

# User Manual

---

IWB (IW006B IW009B)

---

The colour and the appearance may differ depending on the product, and the content in the manual is subject to change without prior notice to improve the performance.

An administration fee may be charged in the following situations:

- (a) An engineer is called out at your request, but it is found that the product has no defect (i.e., where the user manual has not been read).
- (b) You bring the unit to a repair centre, but it is found that the product has no defect (i.e., where the user manual has not been read).

You will be informed of the administration fee amount before a technician visits.

---

# Table of contents

## Before Using the Product

---

Safety Precautions	3
Safety symbols	3
Electricity and Safety	4
Installation	5
Operation	6
Cleaning	7

## Preparations

---

Ports	8
-------	---

## Connecting Devices

---

Precautions when handling the cabinets	9
--	---

---

Installing the cabinets	10
Removing the protective brackets	10

---

Connecting to cabinets	11
Supported resolutions per installation	13

---

Connecting the Power Cable	14
----------------------------	----

## Specifications

---

General	15
---------	----

## Appendix

---

Responsibility for the Pay Service (Cost to Customers)	16
Not a product defect	16
A Product damage caused by customer's fault	16
Others	16

---

Licence	17
---------	----





# Chapter 01







## Before Using the Product

### Safety Precautions

The following safety instructions are to ensure your personal safety and prevent property damage. Please read the following to ensure the proper use of the product.

#### Safety symbols









Symbol	Name	Meaning
	Warning	A serious or fatal injury may result if instructions are not followed.
	Caution	Personal injury or damage to properties may result if instructions are not followed.
	Prohibition	Do NOT attempt.
	Instruction	Follow directions.

CAUTION			
RISK OF ELECTRIC SHOCK. DO NOT OPEN.			
CAUTION: TO REDUCE THE RISK OF ELECTRIC SHOCK, DO NOT REMOVE COVER (OR BACK). THERE ARE NO USER SERVICEABLE PARTS INSIDE. REFER ALL SERVICING TO QUALIFIED PERSONNEL.			
	This symbol indicates that high voltage is present inside. It is dangerous to make any kind of contact with any internal part of this product.		AC voltage: Rated voltage marked with this symbol is AC voltage.
	This symbol indicates that this product has included important literature concerning operation and maintenance.		DC voltage: Rated voltage marked with this symbol is DC voltage.
	Class II product: This symbol indicates that a safety connection to electrical earth (ground) is not required. If this symbol is not present on a product with a mains lead, the product MUST have a reliable connection to protective earth (ground).		Caution. Consult instructions for use: This symbol instructs the user to consult the user manual for further safety related information.





---

## Electricity and Safety

### Warning











-  Do not use a damaged power cord or plug, or a loose power socket.  
An electric shock or fire may result.
-  Do not use multiple products with a single power socket.  
Overheated power sockets may cause a fire.
-  Do not touch the power plug with wet hands. Otherwise, an electric shock may result.
-  Do not bend or pull the power cord with force. Be careful not to leave the power cord under a heavy object.  
Damage to the cord may result in a fire or electric shock.
-  Do not place the power cord or product near heat sources.  
A fire or electric shock may result.
-  Insert the power plug all the way in so it is not loose.  
An unsecure connection may cause a fire.
-  Connect the power plug to a grounded power socket (type 1 insulated devices only).  
An electric shock or injury may result.
-  Clean any dust around the pins of the power plug or the power socket with a dry cloth.  
A fire may result.

### Caution

-  Do not disconnect the power cord while the product is being used.  
The product may become damaged by an electric shock.
-  Only use the power cord provided with your product by Samsung. Do not use the power cord with other products.  
A fire or electric shock may result.
-  Keep the power socket where the power cord is connected unobstructed.  
The power cord must be disconnected to cut off power to the product when an issue occurs.
-  Hold the plug when disconnecting the power cord from the power socket.  
An electric shock or fire may result.





# Installation

## Warning

-  DO NOT PLACE CANDLES, INSECT REPELLANTS OR CIGARETTES ON TOP OF THE PRODUCT. DO NOT INSTALL THE PRODUCT NEAR HEAT SOURCES.  
A fire may result.
-  Do not install the product in poorly ventilated spaces such as a bookcase or closet.  
An increased internal temperature may cause a fire.
-  Do not install the product on an unstable or vibrating surface (insecure shelf, sloped surface, etc.)
  - The product may fall and become damaged and/or cause an injury.
  - Using the product in an area with excess vibration may damage the product or cause a fire.
-  Do not expose the product to direct sunlight, heat, or a hot object such as a stove.  
The product lifespan may be reduced or a fire may result.
-  Do not install the product within the reach of young children.  
The product may fall and injure children.
-  Edible oil, such as soybean oil, can damage or deform the product. Do not install the product in a kitchen or near a kitchen counter.
-  Have a technician install the wall-mount hanger.
  - Installation by an unqualified person can result in an injury.
  - Only use approved cabinets.
-  Install the product at least 10 cm away from the wall to allow ventilation.  
An increased internal temperature may cause a fire.
-  Keep the plastic packaging out of the reach of children.  
Children may suffocate.
-  Do not install the product in a vehicle or a place exposed to dust, moisture (water drips, etc.), oil, or smoke.  
A fire or electric shock may result.

-  Following installation, it is recommended to dehumidify the LED Signage product before use.
  - This helps prevent moisture damage and maintain optimal performance.
  - For product dehumidification, refer to the supplied installation manual. The installation manual is available for download at [www.samsung.com/displaysolutions](http://www.samsung.com/displaysolutions).

## Caution

-  Do not set down the product on its front.  
The screen may become damaged.
-  When installing the product on a cabinet or shelf, make sure that the bottom edge of the front of the product is not protruding.
  - The product may fall and become damaged and/or cause an injury.
  - Install the product only on cabinets or shelves of the right size.
-  Do not drop the product while moving. Product failure or personal injury may result.
-  Set down the product gently.  
Product failure or personal injury may result.
-  Installing the product in an unusual place (a place exposed to a lot of fine dust, chemical substances, extreme temperatures or a significant presence of moisture, or a place where the product will operate continuously for an extended period of time) may seriously affect its performance.  
Be sure to consult Samsung Customer Service Centre if you want to install the product at such a place.

## Operation

### Warning

-  There is a high voltage inside the product. Never disassemble, repair or modify the product yourself.
  - A fire or electric shock may result.
  - Contact Samsung Customer Service Centre for repairs.
-  If the product is dropped or the outer case is damaged, turn off the power switch and disconnect the power cord. Then contact Samsung Customer Service Centre.



Continued use can result in a fire or electric shock.
-  Do not leave heavy objects or items that children like (toys, sweets, etc.) on top of the product.

The product or heavy objects may fall as children try to reach for the toys or sweets resulting in a serious injury.
-  Do not move the product by pulling the power cord or any cable.

Product failure, an electric shock or fire may result from a damaged cable.
-  Do not lift or move the product by pulling the power cord or any cable.

Product failure, an electric shock or fire may result from a damaged cable.
-  Ensure the vents are not blocked by tablecloths or curtains.

An increased internal temperature may cause a fire.
-  Do not insert metallic objects (chopsticks, coins, hairpins, etc) or objects that burn easily (paper, matches, etc) into the product (via the vent or input/output ports, etc).
  - Be sure to power off the product and disconnect the power cord when water or other foreign substances have entered the product. Then contact Samsung Customer Service Centre.
  - Product failure, an electric shock or fire may result.

-  Do not place objects containing liquid (vases, pots, bottles, etc) or metallic objects on top of the product.
  - Be sure to power off the product and disconnect the power cord when water or other foreign substances have entered the product. Then contact Samsung Customer Service Centre.
  - Product failure, an electric shock or fire may result.
-  Before moving the product, turn off the power switch and disconnect the power cable and all other connected cables.

Damage to the cord may result in a fire or electric shock.
-  If the product generates abnormal sounds, a burning smell or smoke, disconnect the power cord immediately and contact Samsung Customer Service Centre.

An electric shock or fire may result.
-  During a lightning or thunderstorm, power off the product and remove the power cable.

A fire or electric shock may result.
-  Do not drop objects on the product or apply impact.







A fire or electric shock may result.
-  If a gas leakage is found, do not touch the product or power plug. Also, ventilate the area immediately.

Sparks can cause an explosion or fire.
-  Do not use or keep combustible spray or an inflammable substance near the product.

An explosion or fire may result.

---

## Caution

-  The screen is bright. Keep a sufficient distance from the screen.
  - Continuously looking at the screen up close is bad for your eyes.
  - Keep at least the recommended viewing distance (pixel pitch x 3.5 m) from the screen.  
e.g. For IW009B:  $0.945 \times 3.5 \text{ m} =$  a distance of at least 3.3 m is recommended
-  Do not use humidifiers or stoves around the product.  
A fire or electric shock may result.
-  Do not touch the screen when the product has been turned on for an extended period of time as it will become hot.
-  Do not place heavy objects on the product.  
Product failure or personal injury may result.
-  Disconnect the power cord from the power socket if you do not plan on using the product for an extended period of time (vacation, etc).  
  
Dust accumulation combined with heat can cause a fire, electric shock or electric leakage.
-  Store small accessories out of the reach of children.

## Cleaning

The LED structure is revealed on the front of the monitor. Exercise caution to ensure that you do not touch the structure. There is a risk that the LED element may fall or become damaged.

To clean the exterior, use the soft cleaning cloth that came with the monitor to wipe the exterior gently.

(The installation manual is available for download at [www.samsung.com/displaysolutions](http://www.samsung.com/displaysolutions).)

Contact Customer Service Centre if the inside of the product needs cleaning (service fee will be charged).





# Chapter 02

## Preparations

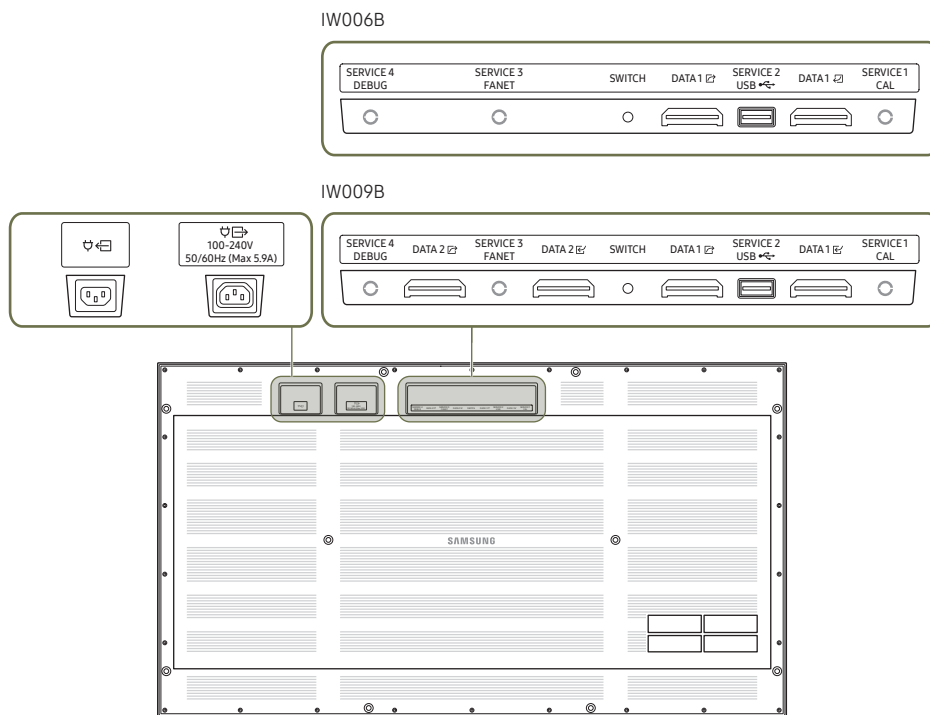
### Ports

 The colour and shape of parts may differ from what is shown. Specifications are subject to change without notice to improve quality.



Parts	Description
SERVICE 4 DEBUG SERVICE 3 FANET SERVICE 2 USB SERVICE 1 CAL	Dedicated to service technicians.
DATA 1	Connects to the DATA 1 or DATA 2 port on the next cabinet.
DATA 2	Connects to the DATA 2 port on the next cabinet.  Supported model: IW009B
DATA 1	Connects to the DATA 1 port on an interface gender or on the previous cabinet to receive video data.
DATA 2	Connects to the DATA 1 or DATA 2 port on an interface gender or on the previous cabinet to receive video data.  Supported model: IW009B
SWITCH	Enters factory mode (press and hold for 3 seconds) or factory reset mode (press and hold for 10 seconds).
	Connects to an AC power.
 100-240V 50/60Hz (Max 5.9A)	Connects the power cable to the next cabinet to support AC power.

# Chapter 03

## Connecting Devices

### Precautions when handling the cabinets

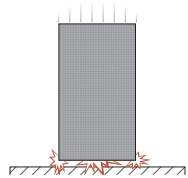

[Caution to prevent external shock and dropping of the product]

After removing the protective brackets, be careful not to expose the product to external shocks or vibrations. Make sure that the product is not dropped from any height.

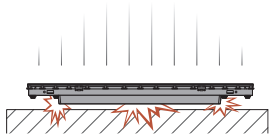

[Caution to prevent damage to the LED]

Be careful not to expose the product to vibrations or external shocks when it is lying flat on the floor.

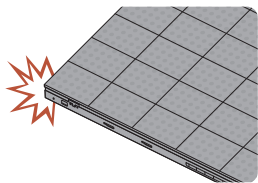

[Caution to prevent damage to corners]

Take extra care to ensure that the corners of a cabinet do not get damaged.

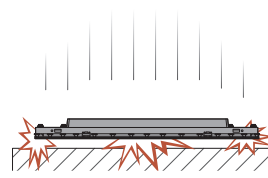

[Caution to prevent damage to the LED]

After removing the protective brackets, do not place the product on the floor with the LED facing down.

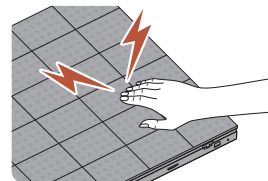

[Caution to prevent damage to the LED from static]

Do not touch the product without anti-static gloves.

- Be sure to wear anti-static gloves when touching the product.

## Installing the cabinets

- Make sure you entrust the installation to a professional installation service provider. For further information regarding installation, contact the dealer you purchased the product from.
- Install the cabinet using the frame kit provided by the manufacturer. For more information about how to install the frame kit, refer to the user manual that comes with it.
- Samsung shall not be liable for any damage to the product and any injury to the users or others that may be incurred while the users install the product by themselves.

## Removing the protective brackets

Remove the safety bracket before proceeding to installation.

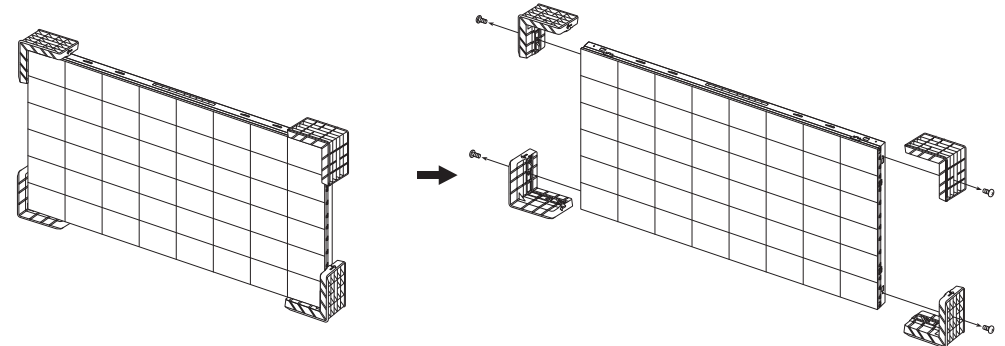

# Connecting to cabinets

Connect the S-Box (SNOW-AAE)/M-Box (MBOX-ACE) and the cabinet to the installed cabinet for video signal transmission.

- ✎ Connect the S-Box/M-Box to the external device before connecting the S-Box/M-Box to the cabinet.
- ✎ Before connecting power to the cabinets, connect the I/G card to the cabinets first.
- ✎ Connect only one type of LED pitch cabinets to a single S-Box/M-Box. Normal picture quality may not be obtained if different types of cabinets are connected. Do NOT use different types of LED pitch cabinets together.
- ✎ Refer to the installation guide for the redundancy connection specifications.

## IW006B

e.g.) 2 x 2

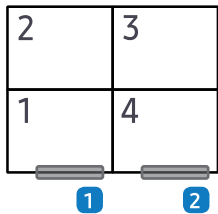

### 1 S-Box/M-Box → I/G Card → First cabinet

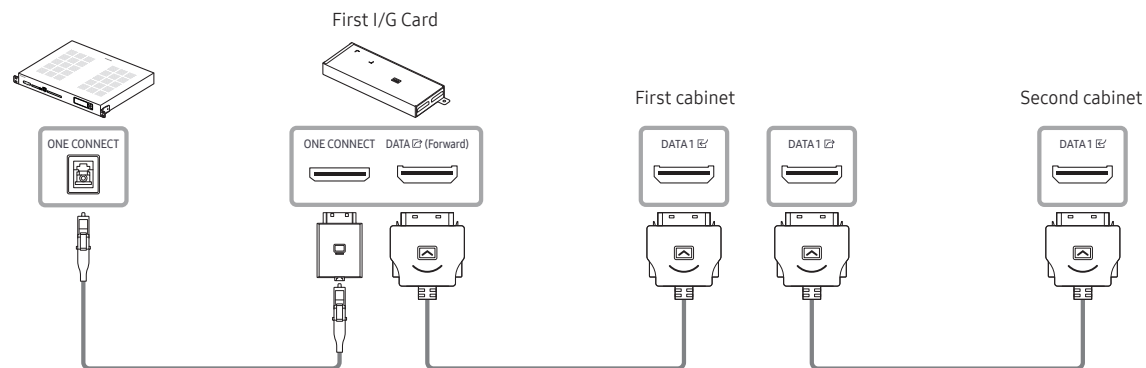

### 2 I/G Card → Second cabinet

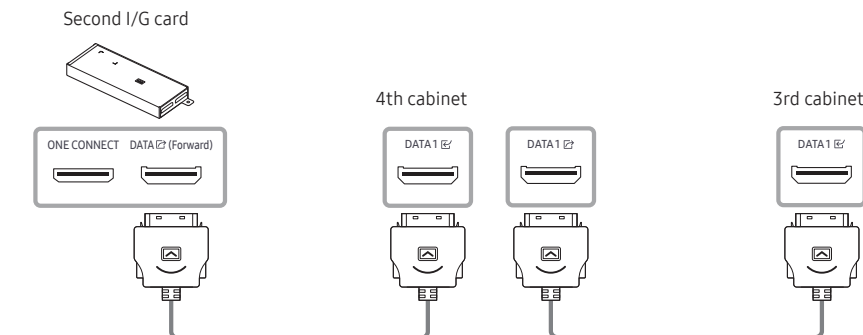

# IW009B

e.g.) 3 x 3

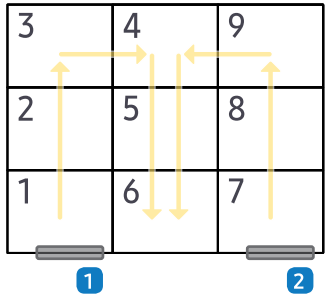

## 1 S-Box/M-Box → I/G Card → First cabinet

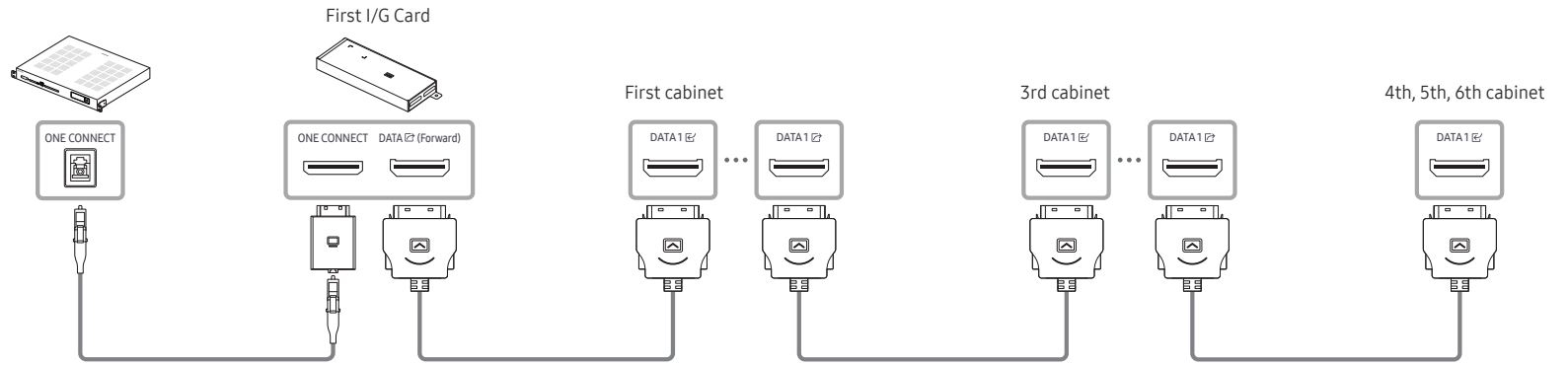

## 2 I/G Card → Second cabinet

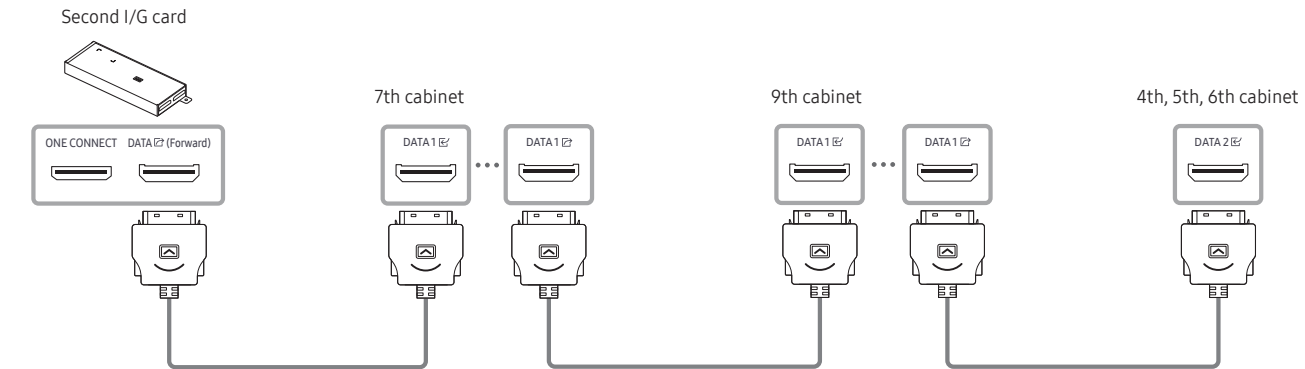

---

## Supported resolutions per installation

Resolution	1280 x 720	1920 x 1080	2560 x 1440	3840 x 2160 (4K)	7680 x 4320 (8K)
IW006B	-	1	-	2 x 2	4 x 4
IW009B	1	-	2 x 2	3 x 3	6 x 6

 One S-Box (SNOW-AAE)/M-Box (MBOX-ACE) supports up to 8K resolution because it has eight built-in ONE CONNECT ports.

 To enjoy resolutions that exceed 8K resolution, you need to add S-Box (SNOW-AAE) to the configuration.

## Connecting the Power Cable

- Connect the power cable after all cables are connected.
- Before connecting external devices, be sure to disconnect the power cable.
- AC power cables may not be provided depending on the model. Contact the dealer from whom you purchased the product if you want to be purchased separately.

### ⚠ Precautions when connecting power

If using 110V power, a maximum of 3 cabinets can be connected to the power source.

If using 220V power, a maximum of 5 cabinets can be connected to the power source.

- For detailed information, visit the install guide.
- ✎ Exceeding the recommended maximum number of devices may produce overvoltage, causing the circuit breaker to trip down or the product to be damaged. Make sure that the number of connected devices does not exceed the recommended maximum number.
- ✎ Samsung is not liable for any problems incurred by connecting devices that exceed the recommended maximum number.

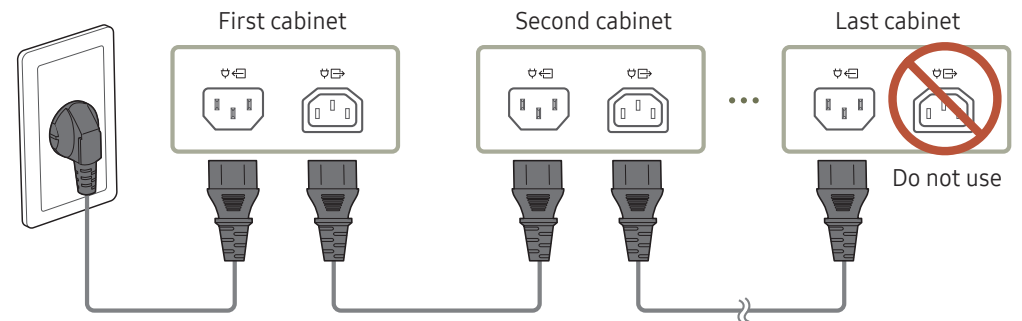

# Chapter 04

## Specifications

### General

Model Name		IW006B	IW009B
Cabinet	Pixel Pitch	0.63 mm	0.945 mm
	LED pixel configuration	Flip-chip RGB LED	
	Pixels (Row x Column)	1920 x 1080 pixels	1280 x 720 pixels
	Aspect ratio (W:H)	16:9	
Synchronization	Refresh rate	3840Hz	
	Video Frame rate	120Hz	
Power Supply		AC100-240V~ 50/60Hz Refer to the label at the back of the product as the standard voltage can vary in different countries.	
Environmental considerations	Operating	Temperature : 0 °C - 40 °C (32 °F - 104 °F) Humidity : 10% - 80%, non-condensing	
	Storage	Temperature : -20 °C - 45 °C (-4 °F - 113 °F) Humidity : 5% - 95%, non-condensing * Applicable before the product package is unpacked.	

- Plug-and-Play  
This monitor can be installed and used with any Plug-and-Play compatible systems. Two-way data exchange between the monitor and PC system optimises the monitor settings. Monitor installation takes place automatically. However, you can customise the installation settings if desired.
- For detailed device specifications, visit the Samsung website.
- (Europe only)  
To access energy labelling information about this product on the European Product Registry for Energy Labelling (EPREL), go to [https://eprel.ec.europa.eu/qr/\\*\\*\\*\\*\\*](https://eprel.ec.europa.eu/qr/*****) where \*\*\*\*\* is the product's EPREL registration number. You can find the registration number on the rating label of your product.
- (Türkiye only)  
To access the energy labelling information of the model:
  - (1) Go to [https://www.samsung.com/global/ecodesign\\_energy](https://www.samsung.com/global/ecodesign_energy)
  - (2) Get the model identifier from the energy label of the product and type it in the search box
  - (3) Energy labelling information can be found

# Chapter 05

## Appendix

### Responsibility for the Pay Service (Cost to Customers)

 When the service is requested, in spite of in warranty, we may charge you for a visit from a service technician in the following cases.

#### Not a product defect

Cleaning of the product, Adjustment, Explanation, Re-installation and etc.

- If a service technician gives instructions on how to use product or simply adjusts options without disassembling product.
- If a defect is caused by external environmental factors (Internet, Antenna, Wired Signal, etc.)
- If a product is reinstalled or devices are connected additionally after installing the purchased product for the first time.
- If a product is reinstalled to move to a different spot or to move to a different house.
- If customer requests instructions on how to use because of another company's product.
- If customer requests instructions on how to use the network or another company's programme.
- If customer requests software installation and setup for the product.
- If a service technician removes/cleans dusts or foreign materials inside of the product.
- If customer requests an installation additionally after purchasing a product through home-shopping or online.

### A Product damage caused by customer's fault

Product damage caused by customer's mishandling or wrong repair

If a product damage is caused by;

- External impact or drop.
- Use of supplies or separately sold product unspecified by Samsung.
- Repair from a person besides an engineer of outsourcing service company or partner of Samsung Electronics Co., Ltd.
- Remodeling or repairing the product by customer.
- Using it with incorrect voltage or non-authorized electrical connections.
- Not following the "cautions" in User Manual.

#### Others

- If product fails by natural disaster. (lightning, fire, earthquake, flood damage, etc)
- If consumable components are all used up. (Battery, Toner, Fluorescent lights, Head, Vibrator, Lamp, Filter, Ribbon, etc.)
-  If customer requests a service in case the product has no defect, service fee may be charged. So please read User Manual first.

---

## Licence

---

Open Source License Notice

Open Source used in this product can be found on the following webpage (<https://opensource.samsung.com>).

---