



User Manual

# Elo Touch Solutions

**ET2270L, ET2470L**  
**Touch monitors**



**Copyright reserved © 2022 Elo Touch Solutions, Inc. All rights reserved.**

No part of this publication may be reproduced, transmitted, transcribed, stored in a retrieval system, or translated into any language or computer language, in any form or by any means, including, but not limited to, electronic, magnetic, optical, chemical, manual, or otherwise without prior written permission of Elo Touch Solutions, Inc.

## Disclaimer

The information in this document is subject to change without notice. Elo Touch Solutions, Inc. and its Affiliates (collectively “Elo”) makes no representations or warranties with respect to the contents herein, and specifically disclaims any implied warranties of merchantability or fitness for a particular purpose. Elo reserves the right to revise this publication and to make changes from time to time in the content hereof without obligation of Elo to notify any person of such revisions or changes.

## Trademark Acknowledgments

Elo, Elo (trademark), Elo Touch, Elo Touch Solutions and IntelliTouch are all the trademarks of Elo and its Affiliates.. Windows is the trademark of Microsoft Corporation.

# Table of Contents

Section 1: Introduction	4
Section 2: Installation	5
Section 3: Mounting	8
Section 4: Operations	10
Section 5: Technical Support	18
Section 6: Safety and Maintenance	20
Section 7: Regulatory Information	21
Section 8: Warranty Information	29

# Section 1: Introduction

## Product Description

Your new touchscreen display combines Elo's latest developments in touch technology and display design with the reliability for use in high-traffic environment.

This touchscreen incorporates a 24-bit color, active matrix thin-film-transistor LCD panel to provide high quality display performance. The 70 Series offers sizes that range from 21.5" to 27" and support a full HD resolution of 1920x1080. The LED backlight significantly reduces power consumption and eliminates mercury (compared to CCFL-backlit panels). Other features that enhance this LCD monitor's display performance are Plug & Play compatibility, interactive TOUCH OSD controls and flexible mounting options

## Precautions

Follow all warnings, precautions and maintenance as recommended in this user manual to maximize the life of your unit and prevent risks to user safety. See the Safety & Maintenance Section for more information.

This manual contains information that is important for the proper setup and maintenance of the unit. Before setting up and powering on your new touchscreen, read through this manual, especially the Installation, Mounting, and Operation Sections

# Section 2: Installation

## Unpacking the Touch Monitor

Open the carton and verify that the following items are present:

- Touch Monitor
- Quick installation guide
- HDMI cable
- USB touch cable
- Europe power cord
- North American power cord
- EEI label
- Tie wraps
- Replaceable plastic cover plates of feet

## Connector panel

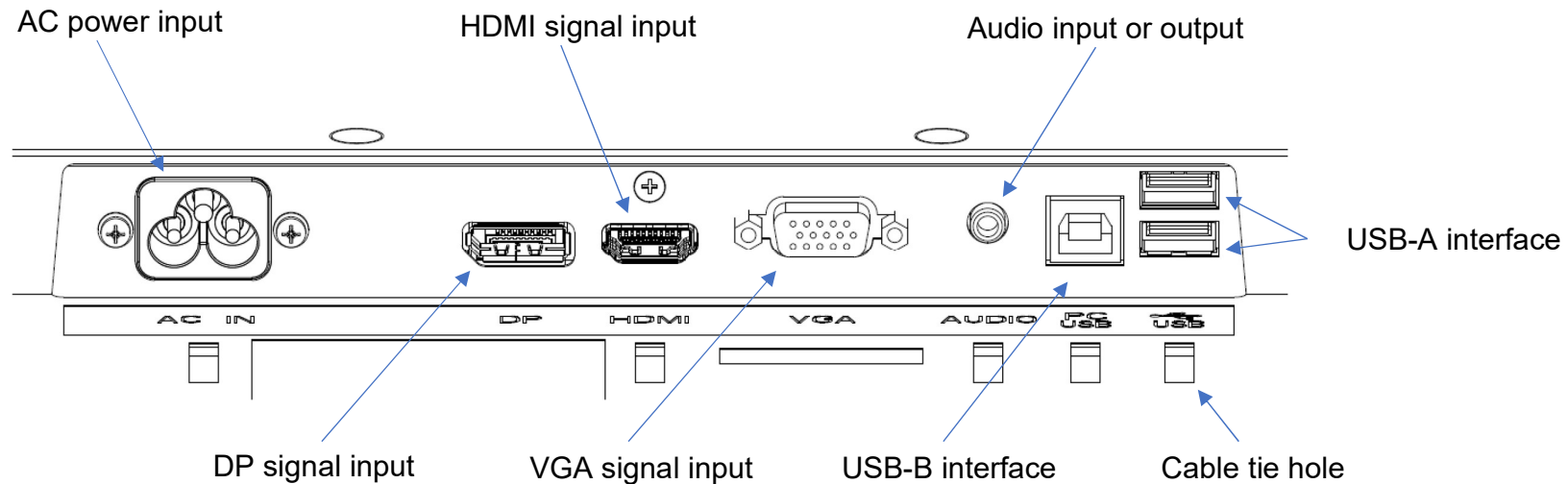

Note: the cable tie hole is the position through which the tie wrap passes to bind the cable. It just needs to pass the tie wrap through the hole and bind the cable to fix the cable connection.

## Touch Monitor Connections

1. Connect one end of the DP, HDMI or VGA video cable to the DP/HDMI/VGA input connector of the monitor and the other end to the DP/HDMI/VGA video source. (Tighten the screws on the VGA cable connector for best performance.)
2. Connect the USB touch line between the USB-B interface of the monitor and the USB-A port on your PC.
3. Connect the audio cable between the audio out of the monitor and your audio source.
4. Use the power cable to connect the power supply with the power input interface of the monitor.
5. The touch monitor ships in an OFF status. Press the power button to switch it on.

## Installing the Touch Technology Software Drivers

No additional drivers are required for your projected-capacitive touch monitor with Windows 7 or 10 operating systems, as it will use the Windows HID drivers. If the monitor is used with the Windows XP operating system, follow the steps below to install the Windows XP touch driver.

To download the latest touch-control driver:

1. please visit <https://www.elotouch.com/support/downloads#/>
2. Select an operating system from the drop-down menu “Operating System.”
3. Select the technology from the drop-down menu “Technology.”
4. Download the driver version necessary for your touch monitor.

# Section 3: Mounting

## Kickstand

The Kickstand angle is manually adjustable in a range of “20° to 70°” by pushing the machine or pull/push the kickstand by hand.

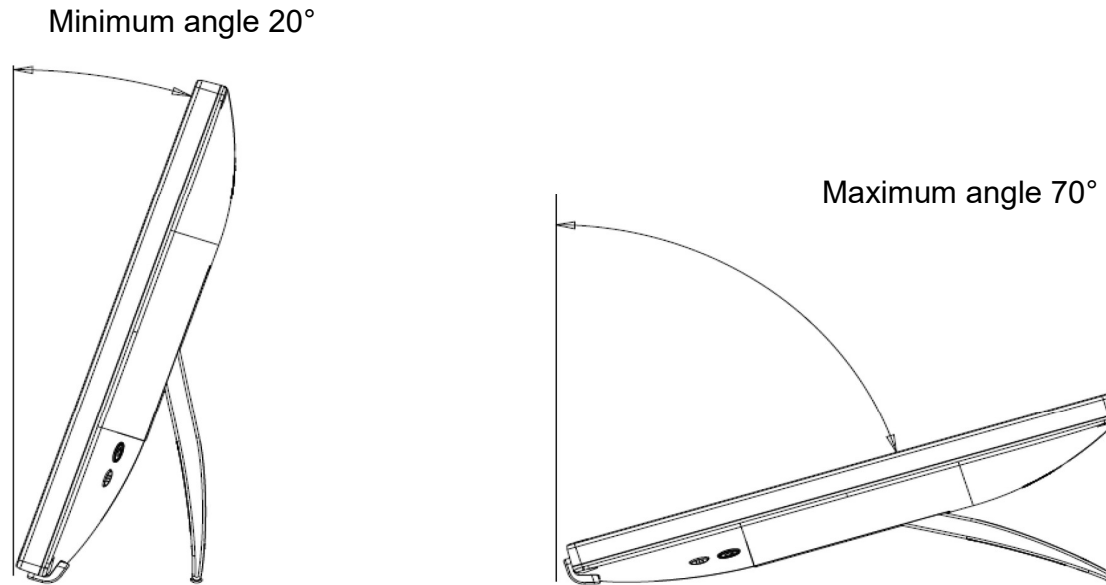

- Note:
1. Once the kickstand leaves the table, the open angle will automatically rebound to the minimum angle. Close the kickstand to prevent damage during moving the touch monitor.
  2. Do not tamper the kickstand to avoid accidental damage.
  3. Do not lift the kickstand when handling / moving the monitor to avoid the damage of touch monitor. This kickstand is not designed for carrying the monitor.



## Rear VESA Mount

A 4-hole 100x100mm mounting interface for M4 screws is provided on the back of the monitor. Peel off the cover mylar, then use a cross screwdriver to remove the screws so as to access the mounting interface. The interface is compatible with the stand of VESA MIS-D, 100, C defined by VESA FDMI.

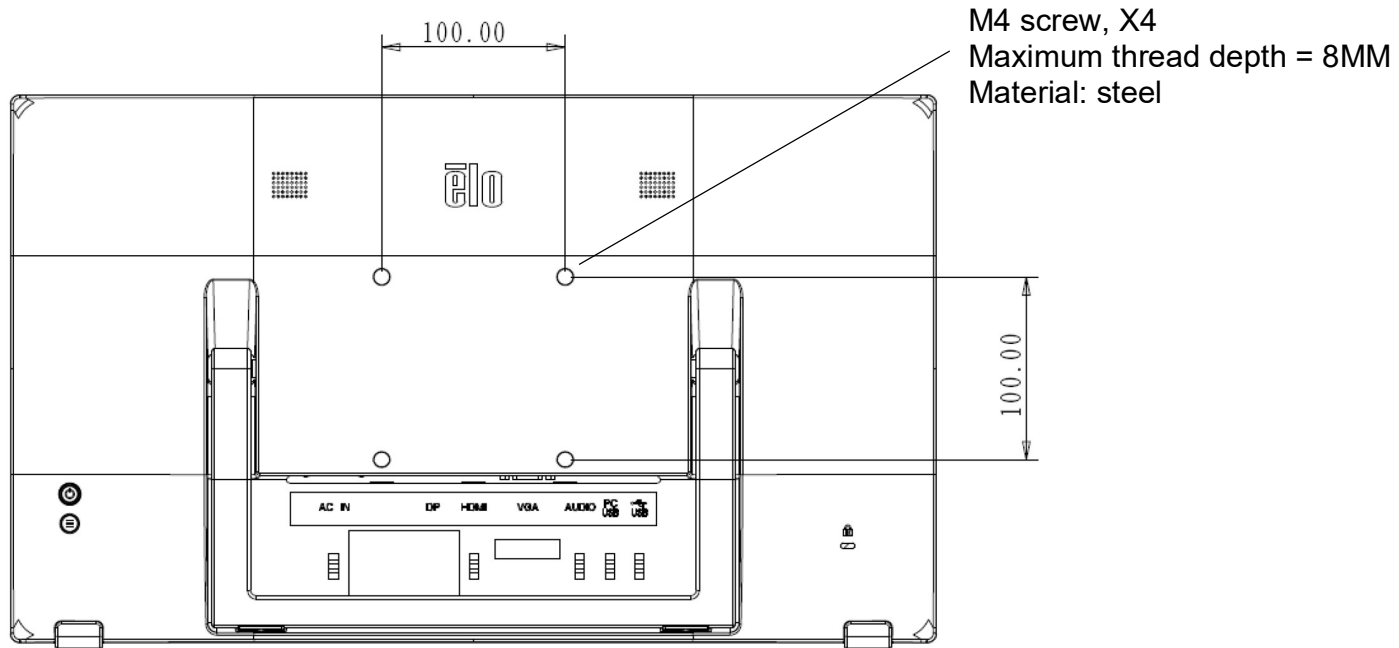

# Section 4: Operations

## Power supply

To power on or off the touch monitor, press the power button.  
The power status LED on the back of the touch monitor functions as follows:

Touch monitor Status	LED Status
Off	Off
Sleep	Pulsing
On	Power-on (green)

The system consumes minimum power when in Sleep or Off modes. For the detailed power consumption specification, refer to the technical specifications on Elo website <http://www.elotouch.com>

Touching the screen will bring the connected host PC out of sleep mode (similar to moving mouse or pressing keyboard key).

In order to improve the reliability and decrease the useless power consumption, disconnect the AC power cable when the machine will be unused for long time.

## Touch control

No calibration is required for projected capacitive technology. The touch monitor can support up to 10 touches at once.

## Projected Capacitive Touch Technology

When connected to Windows 7 or 10 computers, the touch monitor can detect 10 simultaneous touches. When connected to Windows XP computers, the touch monitor detects only single touches.

No additional drivers are required for this technology to work with Windows 7 or 10, as it uses Windows HID drivers.

Refer to Section 2, “Installing the Touch Technology Software Drivers,” for instructions on downloading touch drivers for Windows XP. No calibration is required for this technology

## Gesture support

The TouchPro PCAP technology realizes multiple gestures which support single and multi-touch control. For the description of various gestures supported in Windows 7, 10 and updated operating versions, please refer to Microsoft website: <http://msdn.microsoft.com/en-us/library/dd940543>.

## Video

A display's native resolution is its width and height measured in pixels. Generally, for best performance, an image displayed on this monitor will look best when your computer's output resolution matches this monitor's native resolution, which is 1920x1080.

For computer output at non-native resolutions, the monitor will scale the video to its panel's native resolution. It will involve stretching or compressing the dimensions X and Y to fit the display's native resolution. An unavoidable byproduct of the scaling algorithms is a loss of fidelity when the computer's output video image is scaled by the monitor to fit the display. This loss of fidelity is most apparent when viewing feature-rich images at close distances (e.g., images containing small-font text)

Your touch monitor will likely not require video adjustments. However, for an analog VGA video, variations in video graphic card outputs may require user adjustments through the OSD to optimize the quality of the touch monitor's displayed image. These adjustments are stored by the touch monitor. Moreover, in order to decrease the requirements for adjusting the timing sequence of different video modes, the monitor will properly scale and display some most common video timing sequence modes in the video industry. Refer to the technical specification of the monitor on the website address <http://www.elotouch.com> for a list of these Preset Video Modes.



## On-screen display (OSD)

There are two buttons on the back of the monitor whose functions



are as follows:





Button	Key	Functions
	Power button	Turn on / off monitor power supply
	Menu button	Open / exit OSD menu

The OSD menu of 70 series supports the touch-control interaction. Touching the OSD menu can adjust the monitor parameters. Press the menu button to display the OSD main menu on the screen. Touch the icon on the OSD main menu to collapse the corresponding sub menu.

When the menu pops up, press the menu button again or touch the area outside the menu, the OSD menu will be hidden.

\*OSD menu only supports single touch control



Options	Possible adjustment
	Luminance Setting
Brightness	Increase / decrease the monitor Brightness. Default: 80.
Contrast	Increase / decrease the monitor contrast. Default: best gray-shade performance.
	Image Setting
Video Priority	Set which of those input ports should be given the priority for display . Options include: HDMI, DP, VGA. The monitor continually scans for active video on the VGA, DP and HDMI connectors. If there is no signal from the selected port, it will automatically select the other port having signals. Default: HDMI
H. Position	Move the image horizontally on the display screen in single pixel increment. Default: Centered <i>Applicable for VGA input video only</i>
V. Position	Move the image vertically on the display screen in single pixel increment. Default: Centered <i>Applicable for VGA input video only</i>
Clock	Allow precise adjustment on the pixel dot clock of the panel. <i>Applicable for VGA input video only</i>
Phase	Allow precise adjustments on the pixel clock phase of the panel. <i>Applicable for VGA input video only</i>





## Color Setting

Color	Select the color temperature. The available colors are 9300K, 7500K, 6500K, 5500K, color Enhance and User. If "User" is selected, the user can respectively modify the gains of red, green and blue (the range is 0 to 100) to change the color temperature. Default: User, the values of red, green and blue are all set to 100.
Low Blue Light	Enable / disable the function of Low Blue Light. Default: Disabled





## Audio Setting

Mute	 Mute / unmute the internal speaker of the monitor . Default: Unmute
Volume	 Adjust the audio volume. Default: 50.
Audio Source	Switch between audio sources. The options include: Line-in and From Video Source. Default: the default option is From Video Source if the current video source is HDMI/DP. If the current video source is VGA, this option will be grayed and the default option will be Line-in. Line-in: Set the audio signal to be from the audio port. From Video Source: Set the audio signal to be From Video Source. The option is selectable only when the signal source is HDMI/DP. It can match Line-in / Headphone Out to set the audio output mode.
Line-in / Headphone Out	Set the audio port to be audio input or audio output. Include: Line-in, Headphone Out Default: the default option is Headphone Out if the current video source is HDMI/DP. If the current video source is VGA, this option will be grayed and the default option will be Line-in. Line-in: Set the audio port to be audio input. This option is also used to enable the internal speaker through which the audio is outputted. Headphone Out: Set the audio port is audio output and matches headphones.



## OSD Setting

OSD Timeout	Adjusts how long the touch monitor will wait without OSD button activity before closing the OSD. The adjustable range is between 5 and 60 seconds. Default: 15s.
Language	Select the OSD display language. The available languages are: English, French, Italian, German, Spanish,

	Simplified Chinese, Traditional Chinese and Japanese. Default: English
	Auto Adjust, Adjust automatically the system clock to the input analog VGA video signal, thus affecting the H. Position, V. Position, Clock and Phase menu options. <i>Applicable to VGA input video only</i>
	Miscellaneous Setting
Aspect Ratio	Switch the scaling method, Fill Screen and Fill Aspect Ratio. Default: Fill Screen Fill Screen: Scale the dimensions X and Y of the input video (up and down as needed) to the display's native resolution. Fill Aspect Ratio: Keep the video aspect ratio unchanged (and fill the rest area of the display screen with equal black bars on the left and right.). Assuming a landscape orientation and an input video with aspect ratio smaller than 16:9, scales the Y dimension of the input video (up or down as needed) to the display's Y resolution, scales the X-dimension to maintain the input video's aspect ratio. <i>Other touchscreen technologies may need recalibration when switching between Aspect Ratio options</i>
Sharpness	Adjust the sharpness of the display image. Default: no need to adjust Sharpness <i>Applicable for non-native input video resolution only</i>
Touch on Sleep mode	Whether touch be enabled when monitor is in sleep mode. Default: Enabled
Power LED	Turn on / off the power status LED indicators Default: Enabled
Recall Defaults	Restores all factory default settings for OSD-adjustable parameters (except OSD Language) and for Preset Video Mode timings

All the modifications on the touch monitors via OSD will all be stored automatically when the menu disappears.

This feature prevents having to reenter the settings every time the touch monitor is unplugged or powered off.

In case of power failure, the touch monitor settings will not default to the factory specifications..

## OSD and Power Locked

Press the “Menu Key” for 5s to enable / disable the OSD Locking feature. When OSD Locking is enabled, pressing the menu key will prompt “OSD Locked” but not user menu.

Press the “Menu Key” and the button “Power” for 3s simultaneously to enable / disable the Power Locking feature. When Power Locking is enabled, pressing the power switch will prompt “Power Locked” but will not turn off the monitor.

## Energy Star Certification

The ET2270L/ET2470L complies with the requirements of Energy Star 8.0.



The “Energy Star” is a certification project to promote energy efficiency operated by US Environmental Protection Agency (EPA) and Department of Energy (DOE).

The project complies with the requirements of “Energy Star” under the “Factory Default” settings. If the factory default settings are modified, the power consumption may increase, which possibly exceed the limits necessary for the compliance of “Energy Star” rating. Visit [energystar.gov](http://energystar.gov) to get more information about “Energy Star”.

## TUV Low Blue Light and Flicker-free Certification

The ET2270L/ET2470L have passed the TÜV Rhine Low Blue Light and Flicker-free Certification and can lower down the damage posed by the monitor on human eyes. For the details, please refer to the follows.

### Low Blue Light (Software Solution)

The display industry has developed two different methods to achieve the blue light reduction: a software solution and a hardware solution. The software solution usually reduces the blue light by lowering the blue channel emission or applying an anti-blue light filter.

ET2270L/ET2470L implement Low Blue Light by lowering the blue channel emission.

TÜV Rheinland has tested this product in order to ascertain the product can offer an effective reduction of hazardous blue light.

The keyword “Low Blue Light (Software Solution)” confirms that the product satisfies TÜV Rheinland’s test criteria.

**For the enabling method of LOW Blue Light, please refer to the “OSD” operating instructions**



## Flicker Free

TÜV Rheinland has tested this product to ascertain whether the display produces visibly and invisible flicker for the human eye and therefore strains the eye of the user.

The keyword "Flicker Free" confirms that the device has no visible and invisible flicker defined in this standard within the range of 0 - 3000 Hz under various brightness settings.

## Break time, eye excises, Look at distance objects, Neck Exercises

To reduce your risk for computer vision syndrome and neck, back and shoulder pain, take frequent screen breaks during your work day (at least one 10-minute break every hour). During these breaks, stand up, move about and stretch your arms, legs, back, neck and shoulders to reduce tension and muscle fatigue. Another cause of computer eye strain is focusing fatigue. To reduce your risk of tiring your eyes by constantly focusing on your screen, look away from your computer at least every 20 minutes and gaze at a distant object (at least 20 feet away) for at least 20 seconds. Some eye doctors call this the "20-20-20 rule." Looking far away relaxes the focusing muscle inside the eye to reduce fatigue. Another exercise is to look far away at an object for 10-15 seconds, then gaze at something up close for 10-15 seconds. Then look back at the distant object. Do this 10 times. This exercise reduces the risk of your eyes' focusing ability to "lock up" (a condition called accommodative spasm) after prolonged computer work

### Exercises for the eyes

1. Keep the body and the head upright. Turn the eyes up to look at the ceiling. then turn down to look at the floor.
2. Turn the eyes left and right slowly to look at objects on the two sides.
3. Turn the eyes to look at objects at the right upper direction and then the night lower direction. Repeat for the left upper and left lower directions.

### Exercises for the neck

Keep the arms relaxed at your side.  
Bend your head forward slightly to stretch the neck  
Hold for 5 seconds.  
Keep the arms relaxed at your side.  
Turn the head to one side and hold for 5 seconds.  
Repeat for the other side.  
Keep the arms relaxed at your side.  
Swing the head to the left and hold for 5 seconds.  
Repeat for the other side.

# Section 5: Technical Support

If any problem occurs when you use the machine, please refer to the following suggestions.

If the problem continues, please contact your local dealer or the Elo Touch Solutions Customer Service. The last page on the manual provides the global technical support phone numbers.

## Solutions to common problems

<b>Problems</b>	<b>Recommended trouble-shooting methods</b>
Monitor display is dim.	Use OSD to increase the brightness. Use OSD to increase the contrast.
Monitor display field is blank.	If the power status LED blinks, monitor or computer module may be in sleep mode. Press any key / move the mouse / touch the touchscreen to check if the image reappears. Check whether the signal source device is switched on. Check whether the power cable connection gets loose.
Monitor shows "Out of Range".	Adjust the resolution / timing sequence mode of your computer into the range of permitted timing sequence specified for your machine (for the specifications, please refer to the website contents)
Monitor shows abnormal image.	Adjust the resolution / timing sequence mode of your computer into the range of permitted timing sequence specified for your machine (for the specifications, please refer to the website contents) Use the function of Auto Adjust in OSD.
Touch functionality cannot work.	Check whether the latest version of Elo driver is installed in PC. Execute the calibration routines provided by the latest Elo driver. Press the power button to restart the monitor. Do not touch the screen when the monitor is being started.
Neither the OSD nor power buttons resopnsed when pressed.	Check whether the function of OSD Locked or Power Locked is enabled.
The Touch OSD doesn't work/response	Check whether any other article touches the screen Press the power button to restart the monitor. Do not touch the screen when the monitor is being started.

## Technical Assistance

### Technical Specifications

Please visit [www.elotouch.com/products](http://www.elotouch.com/products)  
To obtain the technical specification of the device

### Technical support

Please visit <https://www.elotouch.com/support>  
Obtain the technical support

Refer to the last page on the manual for worldwide technical support phone numbers.

# Section 6: Safety and Maintenance

## Safety

- To decrease the electric shock risk, please make sure to follow all the safety precautions and must not disassemble the machine without permission. The touch monitors are not user-serviceable.
- The machine is equipped with three grounding power cords. The power supply plug can only be inserted into a grounded socket. Never attempt to insert the power supply plug into other socket or modify it. Never use a damaged power cord. Only the power cables attached to the ELO touch monitor can be used. Use of an unauthorized power cord may invalidate your warranty.
- Make sure your device is under the designated environmental conditions listed in Section “Technical Specification”.
- If you have any doubt or need to learn more product information, please contact you sales representative or manufacturer.

## Care and Handling

The following tips will be helpful for your monitor to work in the optimum state:

- Please unplug the AC power cable before cleaning the monitor.
- Please use a cloth being dipped with a bit neutral cleaning agent to clean the cabinets of display device.
- Important tips: the monitor must be kept dry all the time. Never splash any liquid on or into the monitor. If any liquid enters the monitor, please first turn it off and then ask a qualified maintenance technician to check before powering it on.
- Never use a cloth or sponge that possibly scratches the surface to clean the touch screen.
- Apply a window or glass cleaner on a clean cloth or sponge to clean the touch-control screen. Never apply the cleaner directly on the screen. Never use alcohol (methanol, ethanol or isopropanol), diluent, benzene or other corrosive cleaners.
- Make sure that the ambient temperature and humidity are kept in the designated range and the ventilation slots are not blocked.
- The monitor is not designed for outdoor applications.

## Waste Electrical and Electronic Equipment Directive (WEEE)



It is forbidden to dispose this product as household wastes. It should be deposited at a facility that enables recovery and recycling..

# Section 7: Regulatory Information

## Electrical Safety Information

The requirements on voltage, frequency and current marked on the manufacturer label must be met. If a non-specified power supply is used, it may result in abnormal operations, damaged device or fire.

The device contains no component that can be repaired by the users themselves. The dangerous voltage generated by the device may pose safety hazards. Only a qualified maintenance technician is permitted to repair the machine.

Before the device is powered on, if you have any doubt on the installation, please contact a qualified electrician or the manufacturer.

## Radiation and anti-interference information

### **Notification for US users:**

The device has passed the tests and complies with the limitations on Class B digital equipment in Part 15 of FCC standard. These limitations can provide reasonable prevention on harmful interferences in household appliances. The device may produce, use and radiate radio waves. If not installed and used per the instruction, it may produce harmful interference on the radio communication.

The device is tested to comply with Part 15C of FCC standard. The operations on the device must meet the following two conditions:

- (1) The device will produce no harmful interference and
- (2) it must be able to tolerate any interference, including those that may cause accidental operations.

### **Notifications for Canadian users:**

The device complies with the radio noise limitations of Class B digital equipment specified for radio interference regulations of Industrial Canada.

CAN ICES-003(B)/NMB-003(B)

The device complies with Industry Canada license-exempt RSS standard. The operations on the device must meet the following two conditions:

- (1) The device will produce no interference and
- (2) it must be able to tolerate any interference, including those that may cause accidental operations.

Le présent appareil est conforme aux CNR d'Industrie Canada applicables aux appareils radio exempts de licence. L'exploitation est autorisée aux deux conditions suivantes :

- (1) l'appareil ne doit pas produire de brouillage; et
- (2) l'utilisateur de l'appareil doit accepter tout brouillage radioélectrique subi, même si le brouillage est susceptible d'en compromettre le fonctionnement.

### **Notification for European users:**

Only the power cable and connecting cables attached to the device can be used. According to the requirements of the following standards, if any attached power cable or connecting cables is changed, the electrical safety or radiation or anti-interference CE mark certification may be compromised:

CE mark must be printed on the manufacturer label of an information technology equipment (ITE). The CE mark denotes that the device has passed the tests and meets the following directives and standards: according to the requirements of EMC directive 2014/30/EU of Class B specifications of European standard EN 55032B and the LVD directive 2014/35/EU specified by European standard EN 62368-1, the device has passed the tests and meets the requirements of the CE mark.

### General information for all users:

The device will produce, use and radiate radio waves. If not installed and used per the manual, the machine may produce interference on radio and TV communication. Nevertheless, due to different scene situations, it cannot be guaranteed that it will produce no interference during a special installation course.

1. In order to meet the requirements for radiation and anti-interference, the user must obey the following contents:
  - a. Only the attached I/O cable can be used to connect the digital device to a computer.
  - b. In order to meet the requirements, only the power cables approved by the manufacturer can be used.
  - c. The users must be aware: any changes or modifications on the device without explicit approval by the compliant responsible party may lead to ineffective authorization for using the device.
  
2. If the device produces any interference on radio or television reception or other device:
  - d. Switch attached on / off the device to check whether it is a radiation source. If it is confirmed that the device is producing interference, please take any or several measures below to eliminate the interference:
    - i. Move the digital device away from the affected receiver.
    - ii. Refer to the affected receiver to relocate (rotate) the digital device.
    - iii. Adjust the antenna direction of the affected receiver.
    - iv. Insert the plug of the digital device into another AC socket. Thus, the digital device and receiver are located in different subcircuits.
    - v. Disconnect and remove all I/O lines unused in the digital device. (Unused I/O lines may produce high radio frequency radiation.)
    - vi. The plug of the digital device can only be inserted into a grounded socket. Never use an AC adapter plug.

(If the grounding line is removed or cut, the radio frequency radiation may increase and expose the users to the risk of fatal electric shock.)

If you need other assistance, please consult the retailer, manufacturer or an experienced radio or TV technician.



5 October 2022

## FCC Declaration of Conformity

Per FCC 47 CFR FCC Part15 subpart B Section 2.1077(a)  
In accordance with FCC Rules and Regulations

**Model Number:** ET2470L, ET2270L

**Equipment Category:** Information Technology and Telecommunications Equipment

**Equipment Class:** Commercial and Light Industrial

**Product Name:** Touch Monitor

**Manufacturer:** Elo Touch Solutions, Inc.  
670 N. McCarthy Blvd.  
Suite 100  
Milpitas, CA 95035  
[www.elotouch.com](http://www.elotouch.com)

**Trademark:**



**Declaration:**

This device complies with Part 15 of the FCC Rules. Operation is subject to the following two conditions:  
(1) This device may not cause harmful interference, and  
(2) this device must accept any interference received, including interference that may cause undesired operation

Kevin Huang  
Director, Systems Engineering  
Elo Touch Solutions, Inc.



## Agency Certifications

The monitor has obtained the following certifications and marks:

- CUL, IC (Canada)
- CCC (China)
- CE (Europe)
- UKCA (British)
- KCC (Korea)
- BSMI (Taiwan, China)
- FCC, UL (USA)
- VCCI, PSE (Japan)
- CB (International)
- RCM (Australia)
- EAC (Russia)
- CoC (Mexico)
- India BIS
- RoHS, China RoHS, WEEE, REACH
- TUV Rhine Low Blue Light, Flicker-free
- Energy Star 8.0

## China RoHS certification

According to Chinese Law (RoHS), the section will list the names and contents of toxic or hazardous materials possibly contained in the product.

Part name	Toxic or hazardous substance and elements					
	Lead (Pb)	Mercury (Hg)	Cadmium (Cd)	Hexavalent chromium (Cr6+)	Polybrominated biphenyls (PBB)	Polybrominated diphenyl ethers (PBDE)
Plastic part	O	O	O	O	O	O
Metal part	X	O	O	O	O	O
Power cable and wire assembly	X	O	O	O	O	O
LCD display panel	X	O	O	O	O	O
Touchscreen panel	X	O	O	O	O	O
PCBA	X	O	O	O	O	O
Software (CD, etc)	O	O	O	O	O	O

O: denotes that any toxic or hazardous substance contained in any homogeneous material of the part is lower than the corresponding limitation requirement of SJ/T11363-2006.

X: denotes that the toxic or hazardous substances contained in at least one homogeneous material of the part exceeds the corresponding limitation requirement of SJ/T11363-2006.

The items marked X are exempted according to European RoHS certification.

## Explanation of mark

1. According to the requirements of SJ/T11364-2006, an electronic information product shall be marked with the following pollution control marks.  
The product will pose no impact on the environment within 10 years. Under the following normal working conditions, the product will not be subject to leakage or change. Thus, using the electronic information product will not cause serious environmental pollution, personal injury or property damage.

Working temperature: 0~40°C / Humidity: 20% - 80% (no condensation).  
Storage temperature: -20~60°C / Humidity: 10% - 95% (no condensation).



2. It is encouraged and recommended to recycle and reuse the product according to the local laws. Never discard the product arbitrarily.



## Power adapter specification

### Electrical ratings

Input	100-240Vac, 50/60 Hz, 1A.
-------	---------------------------

## Monitor specification

### **Working conditions**

---

Temperature	0~40°C
-------------	--------

---

Humidity	20%-80% (no condensation).
----------	----------------------------

---

Altitude	0-3,048m
----------	----------

---

### **Storage conditions**

---

Temperature	-20~60°C
-------------	----------

---

Humidity	10%-95% (no condensation).
----------	----------------------------

---

Altitude	0-12,192m
----------	-----------

---

## Section 8: Warranty Information

Unless otherwise specified in the manual or in the order confirmation letter delivered to the buyer, the seller guarantees to the buyer that the product has no materials or process defects. The warranty period of the touch monitor is 3 years.

The seller makes no any guarantee on the standard service life of any component. The suppliers of the seller may make changes on the component delivered as product or component at any time or from time to time.

If it is found that any product fails to conform to the guarantee listed above, the buyer should notify the seller in time in written form (and in any circumstance, the notification shall not be later than 30 days after the finding) and should describe the issues related to the circumstance in a detail level commercially reasonable in the notification. Meanwhile, the seller should try to provide the seller with the opportunities to check the installed products. Unless otherwise instructed in written form by the seller, the buyer must ensure that the seller receive the notification within the warranty period of the product concerned. Within 30 days after the notification is submitted, the buyer should pack the claimed defective product into the original shipping carton box for the product or a package with the equivalent functions, and should ship the product to the seller at the buyer's expense and risk.

After receiving any product claimed defective by the buyer and confirming that the product is indeed not in conformity with the guarantee above, the seller should take the corrective actions based on its own choice within reasonable time, i.e., (i) modify or repair the product, or (ii) replace the product. The expenses to modify, repair or replace the product and incurred during returning the product to the buyer after the modification, repair or replacement at the lowest insurance cost should be at the seller's expense. The buyer should bear the loss or damage risk during product transportation and can insure the product. For a product returned by the buyer but found not defective by the seller, the buyer should compensate the incurred transportation expenses for the product to the seller. The product modification or repair can be conducted at the business premise of the seller or the buyer based on the seller's choice. If the seller cannot modify, repair or replace any product so as to qualify the product to the guarantee above, it should refund the product purchase price to the buyer according to its own choice or subtract the depreciation expense incurred within the specified product warranty period which is calculated according to the method of line from the product purchase price and then remit the remaining balance into the buyer's account.

The remedy above is the only one that can be gained by the buyer in case of breach of guarantee by the seller. Except the express guaranty described above, the seller shall make no any other guarantee, express or implied, including whether the product is suitable for any purpose, product quality, merchantability and non-infringement, etc. Except the guarantees above, no employee from the seller or any other person is authorized to make any guarantee for the product. The liability of the seller in the warranty period is only limited to the purchase price of the returned products. Under any circumstance, for the expenses incurred for purchasing or installing replacement product by the buyer as well as any special, derivative, indirect or incidental damage, the seller shall accept no liability.

The buyer shall bear the risks and agree to protect the seller so as to protect the buyer from being affected by any liability related to the following items and compensate the seller for the loss resulting thereof: (i) evaluating the planned product usage behaviors and the appropriateness of any system design or drawing, and (ii) verifying whether the product usage behaviors comply with the applicable laws, regulations, guidelines and standards. For all the guarantees and other claim for compensation related to the buyer's product (including

the product using some other product or component manufactured or provided by the buyer as part of the product concerned) or incurred due to the buyer's product, the buyer should bear all the liabilities. The buyer should bear the responsibilities for any and all the representations and warranties related to the product manufactured by itself or manufactured under license by itself. The buyer should protect the seller so as to prevent the seller from being affected by any liability, claim for compensation, loss, cost or expense (including reasonable attorney's fees) incurred due to its product or due to the representations or warranties related to its product, and compensate the seller for the loss resulting thereof.









**[www.elotouch.com](http://www.elotouch.com)**

Visit our website for the latest

- Product information
- Specifications
- Upcoming events
- Press Releases
- Software Drivers
- Touchmonitor Newsletter

To find out more about our extensive range of Elo touch solutions, go to [www.elotouch.com](http://www.elotouch.com), or call the office nearest you.

**Americas**

Tel +1 408 597 8000  
[elosales.na@elotouch.com](mailto:elosales.na@elotouch.com)

**Europe (EMEA)**

Tel +32 16 930 136  
[emea.sales@elotouch.com](mailto:emea.sales@elotouch.com)

**Asia-Pacific**

Tel +86 (21) 3329 1385  
[eloasia@elotouch.com](mailto:eloasia@elotouch.com)