



User Guide



HP Smart Tank
6000 series



HP Smart Tank
7000 series



HP Smart Tank
7300 series

HP Smart Tank series

HP company notices

Copyright and License

THE INFORMATION CONTAINED HEREIN IS SUBJECT TO CHANGE WITHOUT NOTICE.

ALL RIGHTS RESERVED. REPRODUCTION, ADAPTATION, OR TRANSLATION OF THIS MATERIAL IS PROHIBITED WITHOUT PRIOR WRITTEN PERMISSION OF HP, EXCEPT AS ALLOWED UNDER THE COPYRIGHT LAWS. THE ONLY WARRANTIES FOR HP PRODUCTS AND SERVICES ARE SET FORTH IN THE EXPRESS WARRANTY STATEMENTS ACCOMPANYING SUCH PRODUCTS AND SERVICES. NOTHING HEREIN SHOULD BE CONSTRUED AS CONSTITUTING AN ADDITIONAL WARRANTY. HP SHALL NOT BE LIABLE FOR TECHNICAL OR EDITORIAL ERRORS OR OMISSIONS CONTAINED HEREIN.

© Copyright 2021 HP Development Company, L.P.

Trademark Credits

Microsoft and Windows are either registered trademarks or trademarks of Microsoft Corporation in the United States and/or other countries.

Mac, OS X, macOS, and AirPrint are trademarks of Apple Inc., registered in the U.S. and other countries.

ENERGY STAR and the ENERGY STAR mark are registered trademarks owned by the U.S. Environmental Protection Agency.

Android and Chromebook are trademarks of Google LLC.

iOS is a trademark or registered trademark of Cisco in the U.S. and other countries and is used under license.

Safety information

Always follow basic safety precautions when using this product to reduce risk of injury from fire or electric shock.

- Read and understand all instructions in the documentation that comes with the printer.
- Observe all warnings and instructions marked on the product.
- Unplug this product from wall outlets before cleaning.
- Do not install or use this product near water, or when you are wet.
- Install the product securely on a stable surface.
- Install the product in a protected location where no one can step on or trip over the line cord, and the line cord cannot be damaged.
- If the product does not operate normally, see **Solve a problem** in this guide.
- There are no user-serviceable parts inside. Refer servicing to qualified service personnel.

Table of contents

1 Get started	1
Printer views	1
Printer front views	1
Printer rear view	2
Printer inner view	3
Control panel features	4
Overview of buttons and lights	4
Control panel display icons	6
Understand control panel lights and display icons	7
Control panel error codes	7
Power button light	9
Document icon and paper errors	9
Printhead icons and errors	10
Printheads alignment icon	10
Ink icons and errors	11
Wi-Fi status, light, and icons	12
Perform common tasks on the printer control panel	13
Print reports from the printer control panel	14
To print the printer information page	14
To print other reports	14
Change printer settings	15
To change printer settings from the embedded web server (EWS)	15
To change printer settings from HP Smart (iOS, Android, and Windows 10)	15
Use the HP printer software	15
To install HP printer software and open the software	16
Use the HP Smart app to print, scan, and manage	16
To install HP Smart and open the app	16
Get more information about HP Smart	17
2 Connect your printer	18
Before you begin	18
Connect your printer to a Wi-Fi network using HP Smart	18
Connect your printer to a Wi-Fi network with a router	19
Connect your printer to a Wi-Fi network using HP printer software	19
Connect your printer to a Wi-Fi network using Wi-Fi Protected Setup (WPS)	20
Connect your printer to an Ethernet network (Ethernet model only)	20
Connect your printer using a USB cable	21
Change the connection type	21
USB to a wireless connection	21

Wireless to a USB connection	22
3 Load media and paper basics	23
Load paper	23
To load standard paper	23
To load legal paper	26
To load an envelope	29
To load cards and photo paper	30
Load original	31
To load an original on the scanner glass	31
To load an original in the document feeder (some printer models)	32
Change the paper settings from the embedded web server (EWS)	33
Paper basics	33
Recommended papers for printing	33
Order HP paper supplies	35
4 Print	36
Print from a Windows computer	36
Print from a Mac computer	36
Print with mobile devices	36
Print while connected to same Wi-Fi network	37
Print without connecting to same Wi-Fi network (Wi-Fi Direct)	37
5 Copy, Scan, and Mobile Fax	39
Copy from the printer	39
Copy an identification (ID) card (some printer models)	39
Scan using the HP Smart app (iOS, Android, Windows 10, and macOS)	40
Scan using the HP printer software	41
Scan from a computer	41
Change scan settings (Windows)	41
Create a new scan shortcut (Windows)	42
Scan using Webscan	42
To enable Webscan	43
To scan using Webscan	43
Tips for successful scanning and copying	43
Mobile Fax	43
Use Mobile Fax in the HP Smart app	43
6 Configure your printer	45
Configure the printer using the embedded web server (EWS)	45
To access and use EWS	45
Configure IP network settings	46
Assign or change the system password using the embedded web server (EWS)	47
Update the printer	47
To update the printer or change the settings from the embedded web server (EWS)	48

Use Web Services	48
To set up Web Services using the embedded web server (EWS)	48
To remove Web Services using the embedded web server (EWS)	48
7 Manage ink and printheads	49
Check the ink levels	49
To check the estimated ink levels from the printer software (Windows)	49
Refill ink tanks	49
To refill the ink tanks	49
Order ink supplies	52
Print with black ink only (Windows)	52
Improve print quality	53
To print a print quality diagnostics page (Windows)	53
Understand the print quality diagnostics page	54
Align and clean printheads	54
To align or clean the printheads from the embedded web server (EWS)	55
To align or clean the printheads (Windows)	55
Clean printer	55
To clean the printer from the printer software (Windows)	55
Tips for working with ink and printheads	56
Printhead tips	56
Ink tips	56
Move printer	56
8 Solve a problem	57
Jams and paper-feed issues	57
Clear a paper or print carriage jam	57
Learn how to avoid paper jams	63
Solve paper-feed problems	63
Printhead problem	65
To verify the printheads are installed properly	66
To clean printhead contacts	67
Printing issues	69
To resolve print issues (Windows)	69
To resolve print issues (macOS)	71
Copy and scan issues	71
Network and connection issues	72
Fix network connection issues	72
Fix Wi-Fi Direct connection issues	72
Fix Ethernet connection issues (some printer models)	72
Restore original factory defaults and settings	73
To restore printer factory defaults from the printer control panel	73
To restore the printer network settings from the printer control panel	73
To restore the printer factory settings or network settings from the embedded web server (EWS)	73
Solve Web Services problems	73

Printer hardware issues.....	74
Maintain the printer.....	75
Clean the scanner glass.....	75
Clean the document feeder glass area (some printer models).....	76
Clean the exterior.....	76
Clean the document feeder (some printer models).....	76
HP support.....	78
Contact HP.....	78
Register printer.....	78
Additional warranty options.....	79
9 HP EcoSolutions (HP and the Environment).....	80
Power Management.....	80
Sleep mode.....	80
Auto-Off.....	80
To change the time for Sleep mode and Auto-Off from the embedded web server (EWS).....	80
Schedule On and Off.....	81
Quiet Mode.....	81
To turn Quiet mode on or off or change the settings from the embedded web server (EWS).....	81
Appendix A Technical information.....	82
Specifications.....	82
Regulatory notices.....	84
Regulatory Model Number.....	84
FCC statement.....	84
Power cord instructions.....	84
VCCI (Class B) compliance statement for users in Japan.....	85
Notice to users in Japan about the power cord.....	85
Visual display workplaces statement for Germany.....	85
Noise emission statement for Germany.....	85
European Union and United Kingdom Regulatory Notice.....	85
Declaration of conformity.....	85
Regulatory wireless statements.....	86
Accessibility.....	89
Environmental product stewardship program.....	89
HP tips for reducing environmental impact.....	90
Eco-Tips.....	90
European Union Commission Regulation 1275/2008.....	90
Paper.....	90
Plastics.....	90
Safety data sheets.....	91
Recycling program.....	91
HP inkjet supplies recycling program.....	91
Power consumption.....	91
Disposal of waste equipment by users.....	91
Waste disposal for Brazil.....	91
Chemical substances.....	92

The Table of Hazardous Substances/Elements and their Content (China)	93
Declaration of the Presence Condition of the Restricted Substances Marking (Taiwan)	93
Restriction of hazardous substance (India)	94
Restriction on hazardous substances statement (Turkey)	94
EPEAT	94
SEPA Ecolabel User Information (China)	95
China Energy Label for Printer, Fax and Copier	95
Battery disposal in Taiwan	96
European Union Battery Directive	96
Battery notice for Brazil	96
California Perchlorate Material Notice	96

1 Get started

This section describes the printer parts, control panel features, and other printer functionalities.

Printer views

This topic describes the printer parts.

Printer front views

 **NOTE:** The printer images and details may vary depending on your printer model and country/region.

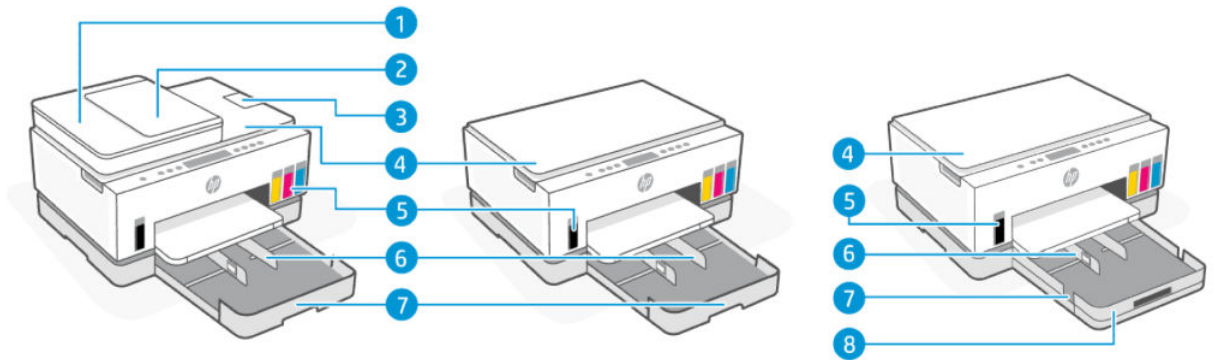

Table 1-1 Printer front view -1

Feature	Description
1	Document feeder cover
2	Document feeder input tray
3	Document feeder output extender
4	Scanner lid
5	Ink tanks
6	Paper-width guides
7	Input tray
8	Removable tray cover (dust cover) (some printer models)

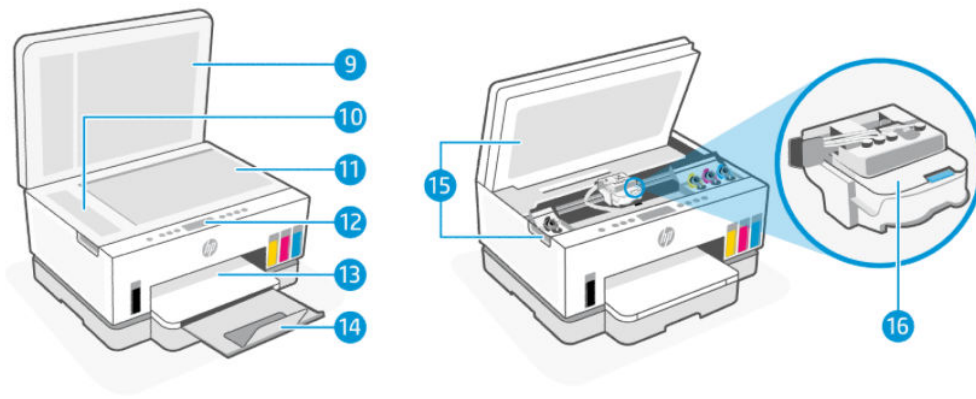



Table 1-2 Printer front view -2

Feature	Description
9	Scanner lid
10	Document feeder glass
11	Scanner glass
12	Control panel
13	Output tray
14	Output tray extender
15	Ink access door
16	Print carriage

Printer rear view

 **NOTE:** The printer images and details may vary depending on your printer model and country/region.

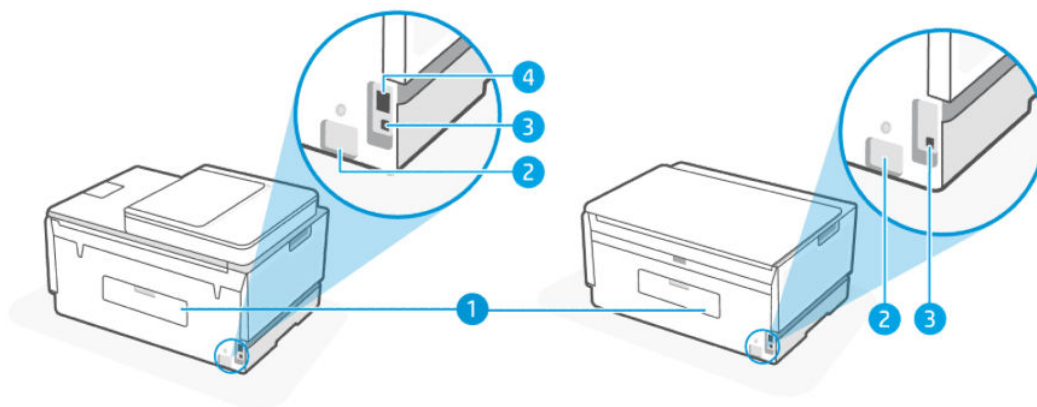

Table 1-3 Printer rear view

Feature	Description
1	Rear door
2	Power connection
3	USB port
4	Ethernet port (Ethernet model only)

Printer inner view

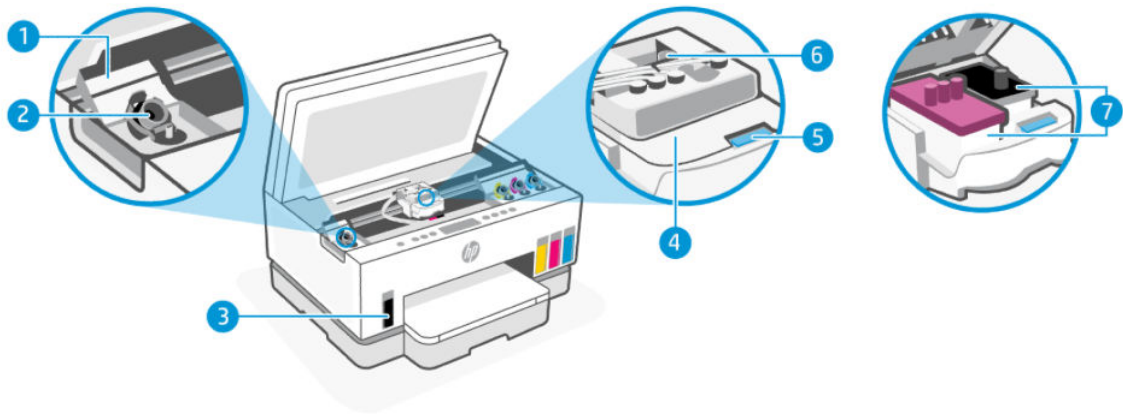

Table 1-4 Printer inner view

Feature	Description
1	Tank covers Tank covers enclose the ink tanks on both sides of the printer.
2	Tank caps Tank caps are plugs to seal the opening of the ink tanks.
3	Ink tanks There are four ink tanks. Each tank contains a different colored ink: black, yellow, magenta, and cyan.
4	Printhead cover The printhead cover on the print carriage secures the printheads in the carriage. Make sure the printhead cover is properly closed to avoid problems such as carriage jams. CAUTION: After you have set up the printer, do not open the printhead cover unless instructed to do so.
5	Printhead cover button Press to open the printhead cover. CAUTION: After you have set up the printer, do not open the printhead cover unless instructed to do so.

Table 1-4 Printer inner view (continued)

Feature	Description
6	<p>Ink tubes button</p> <p>Press to disconnect the ink tubes. To prevent ink leaks or printer damage, you must disconnect the ink tubes when moving the printer to a different location outside of your home or office after initial setup.</p>
7	<p>Printheads</p> <p>The printheads are the components in the print mechanism that apply ink to the paper. There are two printheads: a color printhead and a black printhead.</p> <p>Printheads alignment is a process of aligning the printheads to improve print quality. See Improve print quality.</p>

Control panel features

This topic describes the printer control panel features.

Overview of buttons and lights

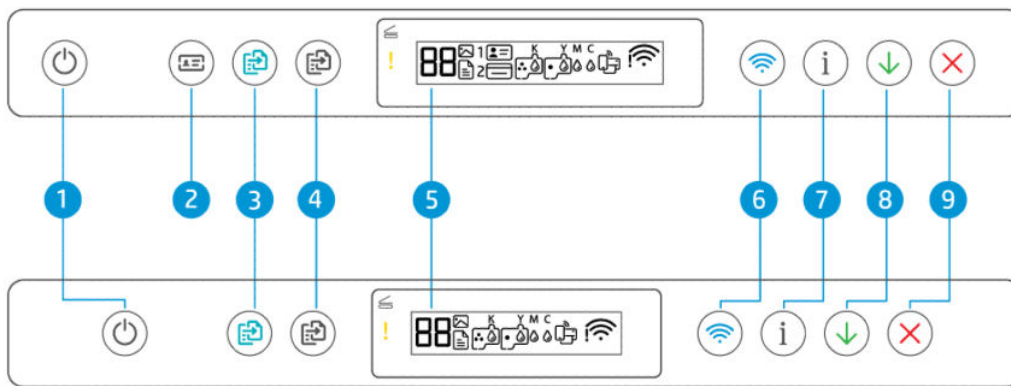

Table 1-5 Overview of buttons and lights









Feature	Button	Description
1	<p>Power button</p> 	Turn the printer on or off.
2	<p>ID Copy button (some printer models)</p> 	The ID Copy feature allows you to place a card or small-size document anywhere on the scanner glass to copy both sides onto the same page. See Copy an identification (ID) card (some printer models) .
3	<p>Color Copy button</p> 	<p>Start a color copy job. To increase the number of copies, press and hold the button or press it multiple times.</p> <p>Copying starts 2 seconds after the last button press.</p>

Table 1-5 Overview of buttons and lights (continued)

Feature	Button	Description
4	Black Copy button 	<p>Start a black-and-white copy job. To increase the number of copies, press and hold the button or press it multiple times.</p> <p>Copying starts 2 seconds after the last button press.</p>
5	Control panel display 	<p>Shows the number counter or error codes, different copy modes, issues relating to ink, printheads, or paper, and the network connection status.</p> <p>For more information on the display icons and error codes, see Understand control panel lights and display icons.</p>
6	Wi-Fi button 	<p>Turn on or off the wireless capability of the printer. See Wi-Fi status, light, and icons.</p>
7	Information button 	<p>Print an information page. The information page provides a summary of the printer information and its current status (including network, Wi-Fi Direct, Web Services, ink, and so on).</p>
8	Resume button 	<p>Resume a job after a disruption (for example, after loading paper or clearing a paper jam).</p>
9	Cancel button 	<p>Stop the current operation.</p>

Control panel display icons

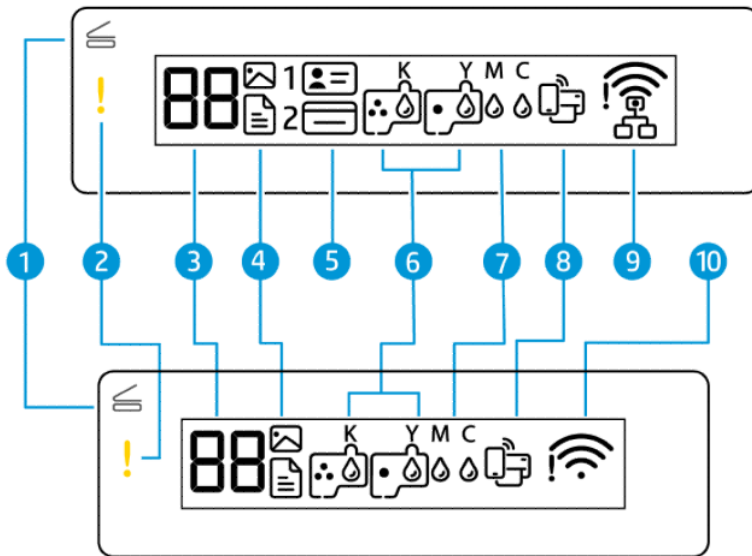

 **NOTE:** For more information on the button lights, display icons, and error codes, see [Understand control panel lights and display icons](#).

Table 1-6 Control panel display icons













Feature	Icon	Description
1	 Open Lid light	This light turns on in one of the following situations: <ul style="list-style-type: none"> • ID Copy mode (some printer models): Open the scanner lid, flip the card, and then press the copy button that is blinking or lit to copy and print. See Copy an identification (ID) card (some printer models). • During printheads alignment: Open the scanner lid, place the printed alignment page print-side down on the scanner glass, and then press the blinking copy button to scan the page. See Printheads alignment icon.
2	 Attention light	Indicates an error or warning state.
3	 Number Counter icon	Shows the number counter when you are copying documents, changes to the letter A when the printer is doing printheads alignment, and shows the letter E and a number when the printer is in an error state. See Control panel error codes .
4	 Document icon  Photo icon	The Document icon appears when the printer is in Document Copy mode, for copying on plain paper. If the Attention light is on or blinking, it also indicates paper related errors. See Document icon and paper errors . The Photo icon appears when the printer is in Photo Copy mode, for copying on photo paper. To switch between the two modes, see Perform common tasks on the printer control panel .

Table 1-6 Control panel display icons (continued)

Feature	Icon	Description
5	ID Copy Front and ID Copy Back icons (some printer models)  	Indicates the side of the card to place on the scanner glass.
6	Printhead icons 	A flashing left icon indicates an error related to the color printhead. A flashing right icon indicates an error related to the black printhead.
7	KYMC and Ink icons 	The KYMC letters and Ink drops are used to indicate status of the four ink tanks in the printer. Each set of icons corresponds to an ink tank: black, yellow, magenta, and cyan.
8	Wi-Fi Direct icon 	Indicates the current Wi-Fi Direct status. <ul style="list-style-type: none">On: Wi-Fi Direct is turned on and ready to use.Off: Wi-Fi Direct is off. See To turn Wi-Fi Direct on or off.
9	Ethernet icon (Ethernet model only) 	<ul style="list-style-type: none">On: Indicates that the printer is connected to the network through a wired (Ethernet) connection.Off: No Ethernet cable is connected to the Ethernet port on the printer, or the printer cannot detect the cable.Blinks: The printer is connected to an active Ethernet cable, but is not connected to a network. See Fix Ethernet connection issues (some printer models) .
10	Wi-Fi status icons 	Shows the Wi-Fi status and signal strength. See Wi-Fi status, light, and icons . To resolve wireless connection issues, see Network and connection issues .

Understand control panel lights and display icons





This topic describes the printer control panel features.

Control panel error codes

This topic describes the error codes on the printer display.

If the Number Counter icon on the printer display changes to a letter E and a number, the printer is in an error state. The letter E and the number work as error codes.

Table 1-7 Control panel error codes

Error code	Cause	Solution
E1/E2	Paper size mismatch (E1) or Paper length mismatch (E2) has occurred. When printing, the printer detects that the paper size of the printing job does not match the width or length of the paper loaded.	<ol style="list-style-type: none"> 1. Press the Cancel button  to cancel printing. 2. Load paper that matches the size of the page you want to print, or change the paper size settings in your application to match the size of the paper you are using. 3. Print the document again. <p>To change the paper size, see Change the paper settings from the embedded web server (EWS).</p>
E3	The carriage inside the printer has stalled.	<ol style="list-style-type: none"> 1. Lift the ink access door. 2. Make sure the printhead cover is properly closed and the print carriage is not obstructed. Do not open the printhead cover. 3. Remove any jammed paper or other objects blocking the carriage. 4. Close the ink access door. 5. Press the Resume button  to continue printing or press the Cancel button . <p>For more information, see Jams and paper-feed issues.</p>
E4	There is a paper jam.	<p>Clear the jam, and then press the Resume button  to continue printing.</p> <p>For more information, see Jams and paper-feed issues.</p> <p>CAUTION: Do not open the printhead cover.</p>
E5	The scanner is not working.	<p>Turn the printer off, and then on again.</p> <p>If the problem persists, contact HP. The printer can still print even if the scanner is not working.</p>
E6	The printer is in an error state.	<p>Restart the printer.</p> <ol style="list-style-type: none"> 1. Turn off the printer. 2. Unplug the power cord. 3. Wait a minute, and then plug the power cord back in. 4. Turn on the printer. <p>If the problem persists, contact HP.</p>
E7	One or more ink tanks are out of ink.	<p>Refill the indicated ink tank that is out of ink. See To refill the ink tanks.</p>
E8	Fatal error.	<p>Turn the printer off, and then on again.</p> <p>If the problem persists, contact HP.</p>
E9	Firmware update error.	<p>Turn the printer off, and then on again.</p> <p>If the problem persists, contact HP.</p>

Power button light



Status	Cause and Solution
On	The printer is on.
Off	The printer is powered off.
Dimmed	The printer is in Sleep mode. See Sleep mode .
Blinking	The printer is turning on or off, or processing a job. To cancel the job, press the Cancel button  .
Fast blinking	If the ink access door is open, close it. If the ink access door is closed and the light is blinking fast, the printer is in an error state. Check your computer or device for any messages that can help provide more information. If need, try printing a page to generate an onscreen message.

Document icon and paper errors

For errors relating to paper mismatch or jams, see [Control panel error codes](#).

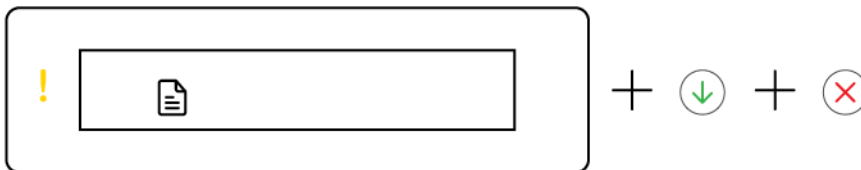

- The Attention light and Document icon are blinking.
The Resume light and Cancel light are on.

Cause	Solution
The printer receives a printing job, and detects that there is no paper in the input tray.	Load paper, and then press the Resume button  to continue printing. See Load paper .

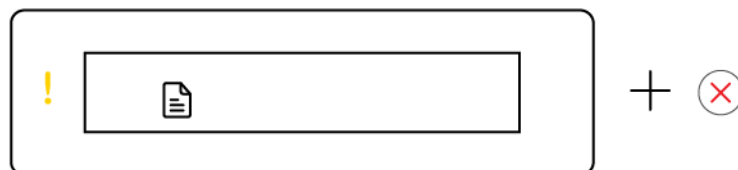

- The Attention light and Document icon are blinking.
The Resume light is off. The Cancel light could be on.

Cause	Solution
There is a paper jam in the document feeder, or the original is not inserted properly into the document feeder.	If the Cancel light is on, press the Cancel button  .
NOTE: The document feeder is only available in some printer models.	For more information, see Jams and paper-feed issues and To load an original in the document feeder (Some printer models) .

Printhead icons and errors

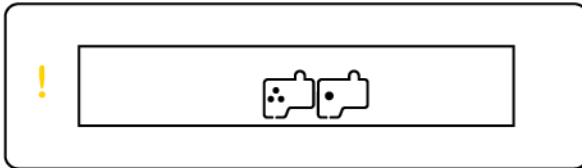

- The Attention light and one or both the Printhead icons are blinking.

Cause	Solution
One of the following might have occurred:	<ul style="list-style-type: none"> • Make sure both printheads are properly installed. • Install any missing printhead. • If both printheads are installed, remove the printhead indicated, make sure there is no orange plug or plastic tape on it, and then reinsert the printhead securely. • Make sure that you are using the correct HP printheads for your printer.
<ul style="list-style-type: none"> • One or both printheads are missing. • One or both printheads are installed incorrectly. • One or both printheads still have an orange plug or plastic tape on them. • One or both printheads are incompatible or damaged. 	<p>For more information, see Printhead problem.</p> <p>NOTE: Do not open the printhead cover unless instructed to do so.</p>

Printheads alignment icon



- The Number Counter icon shows an A or a blinking A, or a “racecourse animation”.

Cause	Solution
The printer is doing printheads alignment.	After the alignment page is printed and the Open Lid light  blinks, place the printed page print-side down on the scanner glass, close the scanner lid, and then press the blinking copy button to scan the page.
A racecourse animation appears on the display when the printer is printing a printheads alignment page.	
A solid "A" appears when the alignment page is printed.	Printheads alignment is complete after the scan.
A blinking "A" appears when the printer is scanning the alignment page.	To load an original, see Load paper .
"A" disappears after the scan when printheads alignment is complete.	

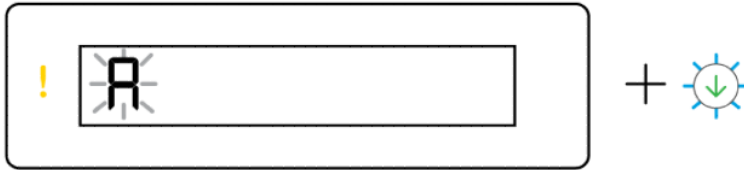

- The Number Counter icon shows a blinking A. The Attention light and Resume light are blinking.

Cause	Solution
Printheads alignment failed. This occurs after you have scanned the alignment page.	Try one of the following: <ul style="list-style-type: none"> • Press one of the copy buttons to rescan the alignment page. • Press the Resume button  to reprint the alignment page. If you do not do anything, printheads alignment gets canceled after some time.

Ink icons and errors

To fill ink tanks, see [Refill ink tanks](#).

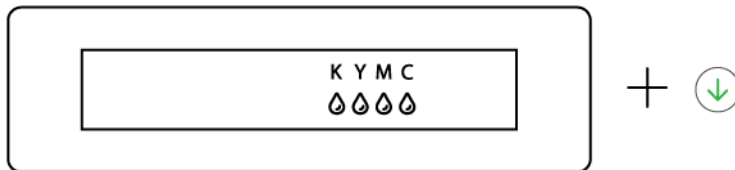

- One or more Ink icons and the Resume light are on.

Cause	Solution
One or more ink tanks are low on ink.	Refill the indicated ink tank.

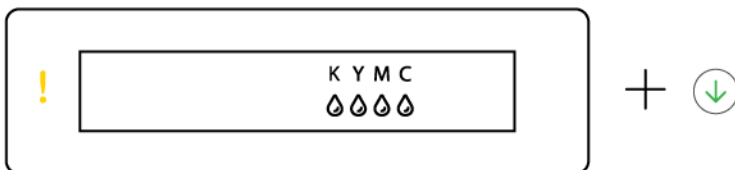

- The Attention light is on, one or more Ink icons are blinking, and the Resume light is on.

Cause	Solution
One or more ink tanks are very low on ink.	Refill the indicated ink tank.

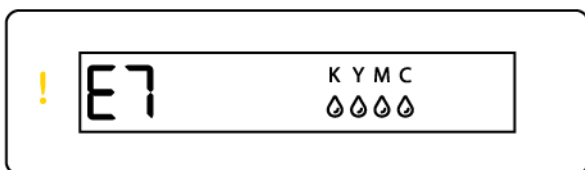

- The Attention light, error code E7, and one or more Ink icons are blinking.

Cause	Solution
One or more ink tanks are out of ink.	Refill the indicated ink tank.

Wi-Fi status, light, and icons

The Wi-Fi light and the wireless status icons on the control panel display work together to indicate the status of a wireless connection.

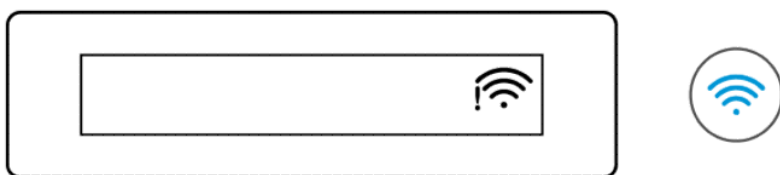

Table 1-8 Wi-Fi status, light, and icons





Wi-Fi light	Wi-Fi icons	Wi-Fi status
Off	Off	<p>The printer is not connected to the Wi-Fi network.</p> <p>To turn on Wi-Fi, press the Wi-Fi button  .</p> <p>To connect the printer to a Wi-Fi network, see Connect your printer to a Wi-Fi network using HP Smart or Connect your printer to a Wi-Fi network using Wi-Fi Protected Setup (WPS).</p>
On	 On	The printer is connected to a Wi-Fi network.
Blinks	 On (signal bars cycle)	<p>The printer is in Wi-Fi setup mode or is trying to connect to a Wi-Fi network.</p> <p>A blinking Wi-Fi light indicates that the printer is not connected to a network or is trying to connect. During setup, it also indicates the printer is in Wi-Fi setup mode. If the setup mode times out after some time, you can restart it by restoring the printer network settings. See Restore original factory defaults and settings.</p>
Blinks	 On (signal bars cycle)	<p>The printer is unable to connect to a Wi-Fi network.</p> <p>To resolve wireless connection issues, see Network and connection issues.</p>

Table 1-8 Wi-Fi status, light, and icons (continued)

Wi-Fi light	Wi-Fi icons	Wi-Fi status
Blinks	 Blinks	The printer is in WPS mode. See Connect your printer to a Wi-Fi network using Wi-Fi Protected Setup (WPS) .

Perform common tasks on the printer control panel

To turn on or off the wireless capability of the printer

When the wireless capability of the printer is turned on, the Wi-Fi button on the printer control panel should be lit.

- If the blue Wi-Fi light is off, press the Wi-Fi button  to turn it on.
- To turn off the Wi-Fi function, press the button again.

To enter Wi-Fi Protected Setup (WPS) Push Button mode

- Press and hold the Wi-Fi button  for at least 3 seconds.

 **NOTE:** For the other tasks listed in the following table, be sure to place the printer in support mode before using any button combinations.

To enter the printer support mode

- Press and hold the Information button  for at least 5 seconds.

All button lights on the printer control panel will light up.

To exit the printer support mode

- Press the Cancel button .

All button lights will turn off if there are no printer errors.

Table 1-9 Common tasks from the printer control panel









Task	Instructions (must be in support mode)
Turn Wi-Fi Direct on or off	Press the Wi-Fi button  and the Resume button  at the same time.

Table 1-9 Common tasks from the printer control panel (continued)

Task	Instructions (must be in support mode)
Switch between Document Copy and Photo Copy modes	Press and hold the Black Copy button  and the Color Copy button  at the same time for 3 seconds.
Restore network defaults	Press the Wi-Fi button  and the Cancel button  at the same time for 5 seconds.
Restore factory defaults	Restoring the printer to factory defaults will remove all settings and functions previously set up on the printer. With the ink access door open, press and hold the Information button  and the Cancel button  for at least 3 seconds.

Print reports from the printer control panel

This topic describes the printer reports and how to print.

To print the printer information page

From the printer control panel, press the Information button .

The information page provides a summary of the printer information and its current status (including network, Wi-Fi Direct, Web Services, ink, and so on).

To print other reports

1. From the printer control panel, place the printer in the support mode. To do so, press and hold the Information button  for 5 seconds until the control panel buttons light up.
2. See the following instructions to print the desired report.

Table 1-10 Print reports











Printer report	Description	How to print (must be in support mode)
Printer Status Report	The page provides a summary of the printer information, current status, and settings, including connectivity settings, as well as print or scan settings and usage.	Press the Resume button  .
Wi-Fi Network Test Report and Network Configuration Page	Wireless Network Test Report shows the diagnostics results for the status of the Wi-Fi network, Wi-Fi signal strength, detected networks, and more. Network Configuration Page shows the network status, hostname, network name, and more.	Press the Information button  and the Resume button  at the same time.

Table 1-10 Print reports (continued)

Printer report	Description	How to print (must be in support mode)
Wi-Fi Quick Start Guide	Provides instructions to help you connect your printer to a Wi-Fi network.	Press the Information button  .
Wi-Fi Direct Guide	Provides instructions to help you set up and use Wi-Fi Direct.	Press the Information button  and the Cancel button  at the same time.
Web Services Reports	Depending on Web Services status, Web Services Reports provide different instructions to help you turn on Web Services, set up Web Services, or fix connection issues, and more.	Press the Resume button  and the Cancel button  at the same time.
Print Quality Diagnostic Report	You can print a diagnostics page to determine if cleaning or aligning the printheads is recommended to improve print quality. See To print a print quality diagnostics page (Windows) .	Press and hold the Color Copy button  for 3 seconds.

Change printer settings

 **NOTE:** You can also view or change the printer settings using the HP printer software. See [Use the HP printer software](#).

To change printer settings from the embedded web server (EWS)

1. Open EWS. See [To access and use EWS](#).
2. Search for a setting. Or click the desired function or tab, and then select a setting from the left menu.
3. Make the necessary changes.

To change printer settings from HP Smart (iOS, Android, and Windows 10)

1. Open the HP Smart app on your computer or mobile device. See [Use the HP Smart app to print, scan, and manage](#).
2. Select your printer, and then click or tap **Printer Settings**.
3. Select the desired option and make the necessary changes.

Use the HP printer software

You can use the HP printer software to change the printer settings, check estimated ink levels, order printing supplies, maintain the printer, resolve printing issues, and more.

- If you are using the HP Smart app instead of the printer software, see [Use the HP Smart app to print, scan, and manage](#).
- Each device must have the app or software installed in order to print.
- Windows 7 Service Pack 1 (SP1) is required to install HP printer software.

To install HP printer software and open the software

1. Visit 123.hp.com to download the software and install on your computer.
2. Open the software.
 - **Windows 10:** From the computer desktop, click **Start**, select **HP** from the app list, and then select the icon with the printer name.
 - **Windows 7:** From the computer desktop, click **Start**, select **All Programs**, click **HP**, click the folder for the printer, and then select the icon with the printer name.

Use the HP Smart app to print, scan, and manage

The HP Smart app can help you perform many different printer tasks, including the following:

- Set up and connect your printer.
- Print and scan documents and photos.
- Share documents through email and other applications.
- Manage printer settings, check printer status, print reports, and order supplies.



NOTE:

- HP Smart is supported on mobile devices and computers running on iOS, Android, Windows 10, and macOS (versions 10.14, 10.15, and 11.0).
 - The HP Smart app might not be available in all languages. Some features might not be available with all printer models.
-

To install HP Smart and open the app

1. Visit [To install HP Smart and open the app](#) to download and install HP Smart on your device.



NOTE: iOS, Android, Windows 10, and macOS devices: You can also download HP Smart from the respective app stores for the device.

2. Open HP Smart after installation.
 - **iOS/Android:** From the mobile device desktop or app menu, tap **HP Smart**.
 - **Windows 10:** From the computer desktop, click **Start**, and then select **HP Smart** from the app list.
 - **macOS:** From the Launchpad, select HP Smart.
3. Connect your printer wirelessly using HP Smart. See [Connect your printer to a Wi-Fi network using HP Smart](#).
4. When prompted, create an HP account and register the printer.

If prompted for a password during the process, enter the PIN which is available from a label in the ink access area or cartridge access area.

Get more information about HP Smart

To learn how to connect, print, and scan using HP Smart, visit the website for your device:

- **iOS/Android:** www.hp.com/go/hpsmart-help
- **Windows 10:** www.hp.com/go/hpsmartwin-help
- **macOS:** www.hp.com/go/hpsmartmac-help

2 Connect your printer

This section describes different ways to connect your printer.

Before you begin



NOTE:

- To turn on or off the wireless capability of the printer, see [Perform common tasks on the printer control panel](#).
 - To resolve network connection issues, see [Fix network connection issues](#).
-

Ensure the following:

- The Wi-Fi network is set up and working properly.
- The printer and the computers that use the printer are on the same network (subnet).

While connecting the printer, you might be prompted to enter the Wi-Fi network name (SSID) and a Wi-Fi password.

- The Wi-Fi network name is the name of your Wi-Fi network.
- The Wi-Fi password prevents other people from connecting to your Wi-Fi network without your permission. Depending on the level of security required, your Wi-Fi network might use either a WPA passphrase or WEP key.

If you have not changed the network name or the security passkey since setting up your Wi-Fi network, you can sometimes find them on the back or side of the wireless router.

If you cannot find the network name or the security password or cannot remember this information, see the documentation provided with your computer or with the wireless router. If you still cannot find this information, contact your network administrator or the person who set up the Wi-Fi network.

Connect your printer to a Wi-Fi network using HP Smart

Install the HP Smart app on your computer or mobile device and use the app to set up or connect the printer to your Wi-Fi network.

For information about HP Smart including where to download the app, see [Use the HP Smart app to print, scan, and manage](#).

1. Make sure your computer or mobile device is connected to your Wi-Fi network. On your mobile device, turn on Bluetooth and location services.



NOTE: HP Smart uses Bluetooth for printer setup. It does not support print using Bluetooth.

2. If your printer Wi-Fi was previously turned off, make sure to turn it on. See [Perform common tasks on the printer control panel](#).

3. If the printer is no longer in Wi-Fi setup mode, restore the printer network settings. See [To restore the printer network settings from the printer control panel](#).

 **NOTE:** For some printers or models, the purple light will start pulsing on the status light bar or the Wi-Fi light will blink when the printer is in Wi-Fi setup mode. See [Wi-Fi status, light, and icons](#).

4. Open the HP Smart app on your computer or mobile device. See [Use the HP Smart app to print, scan, and manage](#).

5. Click or tap the Plus icon  or **Add Printer**, and then choose the option to select or add a printer.

Follow the instructions to add the printer to your network.

6. When prompted, create an HP account and register the printer.

If prompted for a password during the process, enter the PIN which is available from a label in the ink access area or cartridge access area.

 **NOTE:** When the printer is connected successfully, the Wi-Fi light stops blinking and remains lit.

Connect your printer to a Wi-Fi network with a router

This topic describes how to connect your printer to a Wi-Fi network using a router.

Connect your printer to a Wi-Fi network using HP printer software

To connect the printer to an integrated wireless WLAN 802.11 network, make sure you have the following:

- A wireless 802.11a/b/g/n/ac network that includes a wireless router or access point.

 **NOTE:** The printer supports connections using 2.4GHz and 5GHz.

- A computer that is already connected to the Wi-Fi network that you want to use to connect your printer.
- Network name (SSID).
- WEP key or WPA Passphrase (if needed).

To connect your printer using HP printer software (Windows)

If connecting the printer wirelessly using HP software, place the printer in Wi-Fi setup mode by restoring the printer network settings. See [Restore original factory defaults and settings](#).

1. In the HP printer software (available from the **Start** menu), click **Tools**.

For information about the software, see [Use the HP printer software](#).

2. Click **Device Setup & Software**.
3. Click **Connect a new device**.
4. Select **Manual Setup**, select the wireless option, and then follow the on-screen instructions.

Connect your printer to a Wi-Fi network using Wi-Fi Protected Setup (WPS)

This Wi-Fi setup method can be used if your router has a WPS button.

If the router does not have this button, it is recommended that you connect the printer using the HP Smart app. See [Fix network connection issues](#).

1. Make sure your router and printer are not too far from each other.
2. From the printer control panel, press and hold the Wi-Fi button  for at least 3 seconds to start WPS.
3. Press the WPS button on your router.

 **NOTE:**

- Be sure to press the WPS button on the router within 2 minutes.
 - When the printer is connected successfully, the Wi-Fi light stops blinking and remains lit.
-
4. Open the HP Smart app on your computer or mobile device. See [Use the HP Smart app to print, scan, and manage](#).
 5. Click or tap the Plus icon  or **Add Printer**, and then choose the option to select or add a printer.

Follow the instructions to add the printer to your network.
 6. When prompted, create an HP account and register the printer.

If prompted for a password during the process, enter the PIN which is available from a label in the ink access area or cartridge access area.

Connect your printer to an Ethernet network (Ethernet model only)

If your Ethernet network does not have an Internet connection, connect the printer wirelessly to the HP Smart app. See [Connect your printer to a Wi-Fi network using HP Smart](#).

1. Make sure your computer is connected to the router.
2. Connect your printer and router using an Ethernet cable. (Ethernet cable sold separately.)

 **NOTE:**

- The Wi-Fi connection is automatically disabled when you connect the Ethernet cable.
 - To connect the printer wirelessly, disconnect the Ethernet cable and connect the printer to your Wi-Fi network using HP Smart. See [Connect your printer to a Wi-Fi network using HP Smart](#).
-
3. Open the HP Smart app on your computer. See [Use the HP Smart app to print, scan, and manage](#).

4. Click or tap the Plus icon  or **Add Printer**, and then choose the option to select or add a printer.

Follow the instructions to add the printer to your network.

5. When prompted, create an HP account and register the printer.

If prompted for a password during the process, enter the PIN which is available from a label in the ink access area or cartridge access area.

Connect your printer using a USB cable

1. If necessary, remove the label covering the USB port at the back of the printer.
2. Connect the printer and computer using a USB cable.
3. Open the HP Smart app on your computer. See [Use the HP Smart app to print, scan, and manage](#).
4. Click or tap the Plus icon  or **Add Printer**, and then choose the option to select or add a printer.

Follow the instructions to add the printer.

5. When prompted, create an HP account and register the printer.

If prompted for a password during the process, enter the PIN which is available from a label in the ink access area or cartridge access area.

Change the connection type

This topic describes how to change the way to connect your printer.

USB to a wireless connection

Windows 10/macOS

1. Unplug the USB cable from the printer.
2. Make sure your computer or mobile device is connected to your Wi-Fi network. On your mobile device, turn on Bluetooth and location services.
3. If your printer Wi-Fi was previously turned off, make sure to turn it on. For more information about Wi-Fi status, see [Wi-Fi status, light, and icons](#).
4. If the printer is no longer in Wi-Fi setup mode, restore the printer network settings. See [To restore the printer network settings from the printer control panel](#).
5. Open the HP Smart app on your computer or mobile device. See [Use the HP Smart app to print, scan, and manage](#).
6. When prompted, create an HP account and register the printer.

If prompted for a password during the process, enter the PIN which is available from a label in the ink access area or cartridge access area.
7. Follow the on-screen instructions to connect the printer to your Wi-Fi network.

Windows 7

1. Open the HP printer software.

If you have not installed the HP printer software on your computer, visit 123.hp.com to download and install the printer software.



NOTE: Windows 7 Service Pack 1 (SP1) is required to install HP printer software.

2. In the printer software, click **Tools**, and then click **Device Setup & Software**.
3. Select **Convert a USB connected device to wireless**. Follow the on-screen instructions.

Wireless to a USB connection

Windows/macOS

1. If necessary, remove the label covering the USB port at the back of the printer.
2. Connect the printer and computer using a USB cable.
3. Open the HP Smart app on your computer. See [Use the HP Smart app to print, scan, and manage](#).
4. Click or tap the Plus icon  or **Add Printer**, and then choose the option to select or add a printer.

Follow the instructions to add the printer.

5. When prompted, create an HP account and register the printer.

If prompted for a password during the process, enter the PIN which is available from a label in the ink access area or cartridge access area.

3 Load media and paper basics

This section describes how to change paper settings and to load different media into the printer.

Load paper

This topic describes how to load paper into the input tray.



NOTE:

- Do not load paper while the printer is printing.
- If there is other paper in the input tray, remove the paper before loading a different paper type or size.
- When prompted after loading paper, change the paper settings on the printer control panel to match the paper you are using.
- The printer images and details may vary depending on your printer model and country/region.
- For the media supported by your printer, refer to the printer software or the embedded web server (EWS). To open EWS, see [To access and use EWS](#).

To load standard paper

1. Open the input tray.

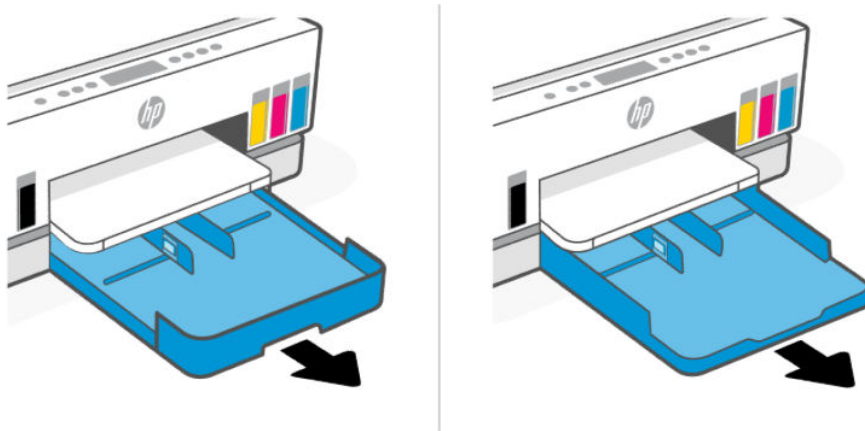

2. Press and hold the button on the paper-width guide, and then slide the guides to the edges of the tray.

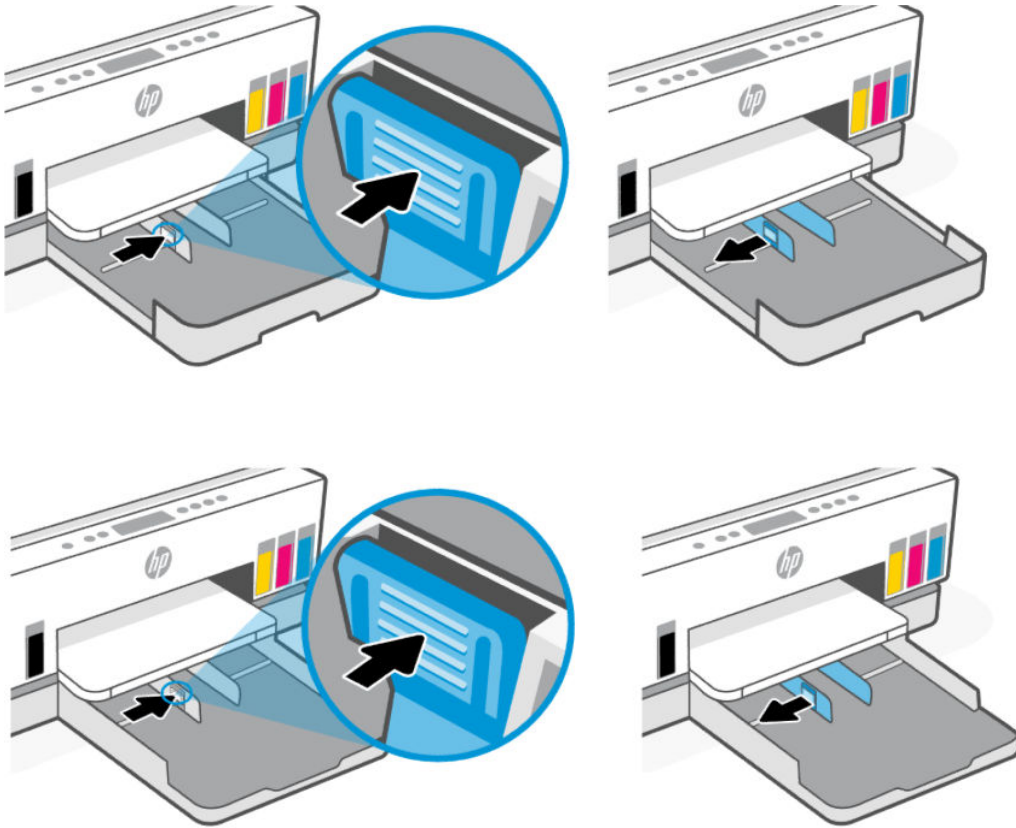

3. Insert the paper in portrait orientation and with the side to be printed facing down.

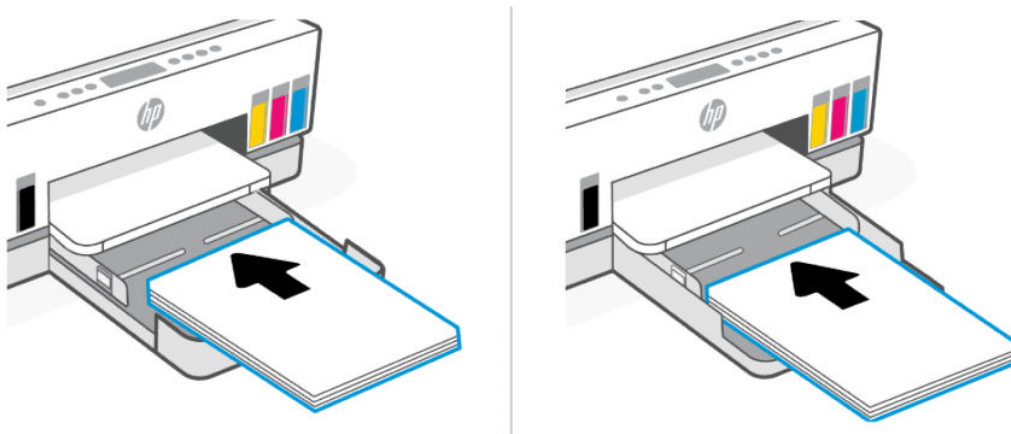

Make sure the stack of paper is aligned with the appropriate paper size lines in the tray. Also, make sure the stack of paper does not exceed the stack-height marking in the tray.

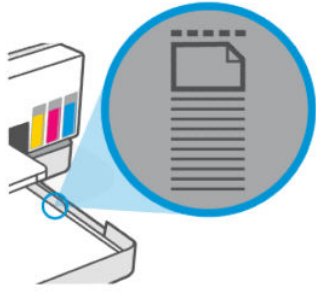

4. Adjust the paper-width guides until they touch the edges of the stack of paper.

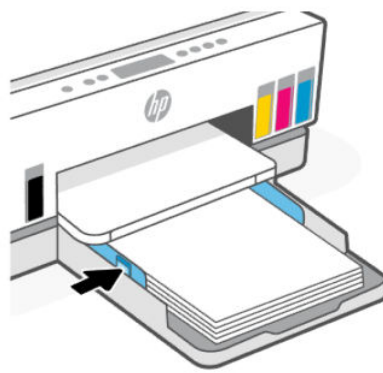
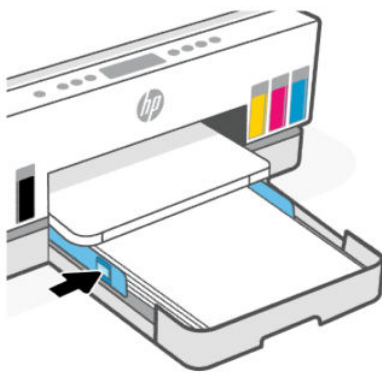

5. Close the input tray.

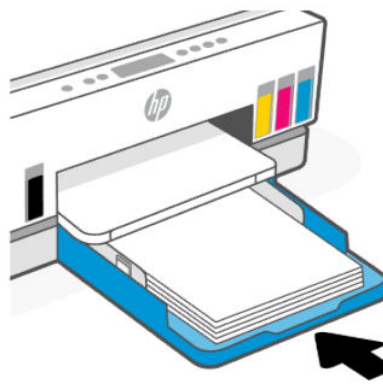
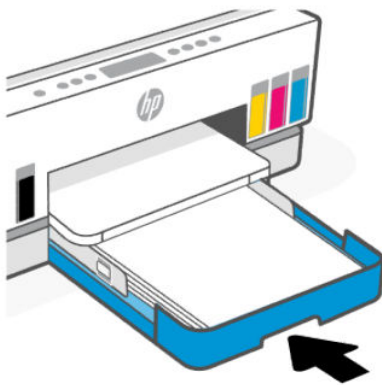

6. Pull out the output tray extender.

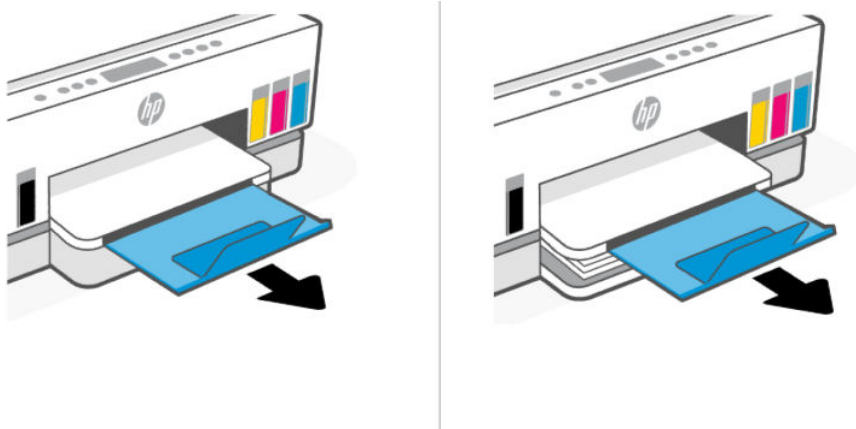

To load legal paper

1. Open the input tray.
2. Press and hold the button on the paper-width guide, and then slide the guides to the edges of the tray.
3. Extend the input tray.

 **NOTE:** Printer models with an open input tray do not require the input tray to be extended.

- a. Press and hold the button on the front edge of the input tray and extend the tray.

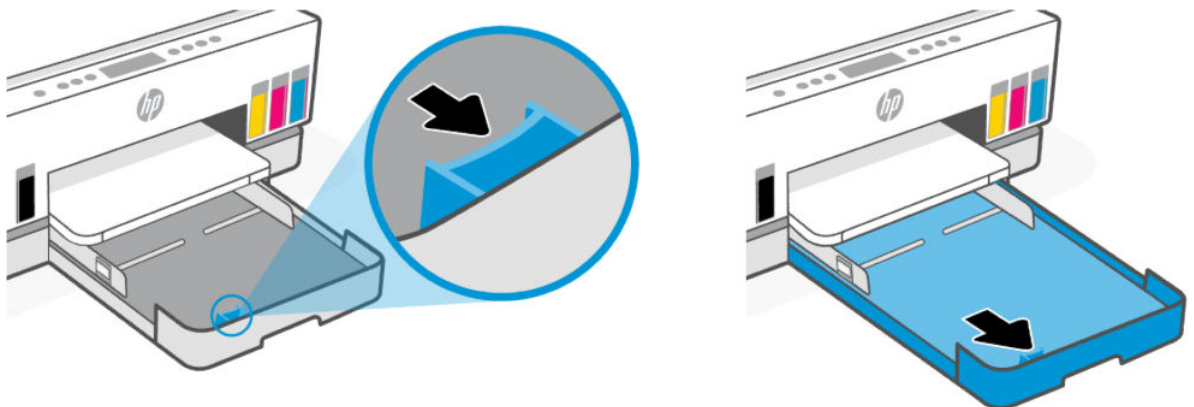

- b. For printer models with a removable tray cover (dust cover), press the buttons at the bottom of the tray towards you to release and remove the cover.

After printing is done, remember to reinsert the cover.

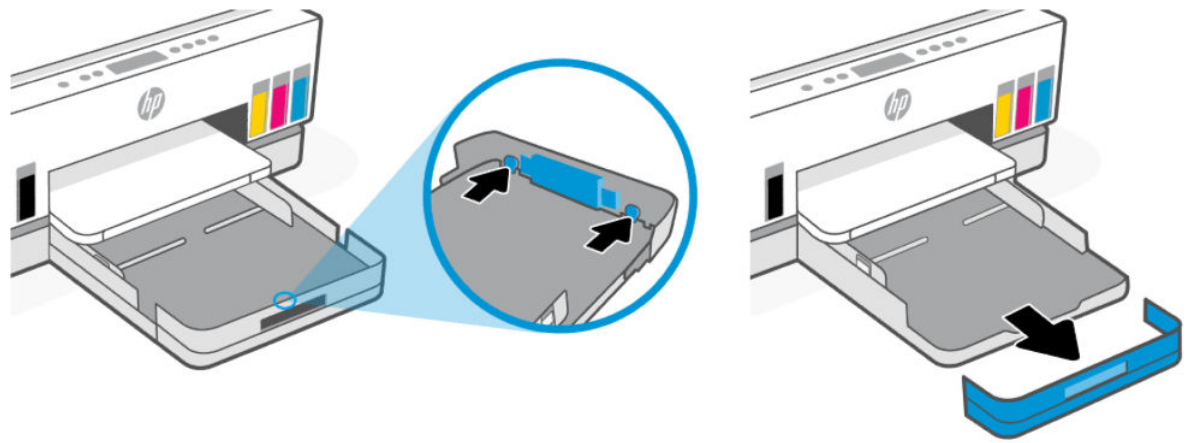

4. Insert the paper in portrait orientation and with the side to be printed facing down.

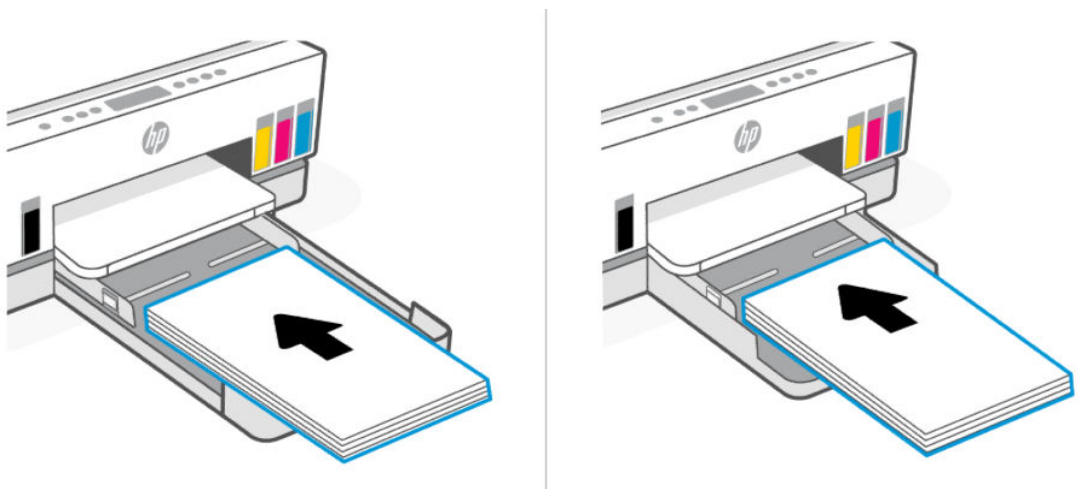

Make sure the stack of paper is aligned with the appropriate paper size lines in the tray. Also, make sure the stack of paper does not exceed the stack-height marking in the tray.



5. Adjust the paper-width guides until they touch the edges of the stack of paper.

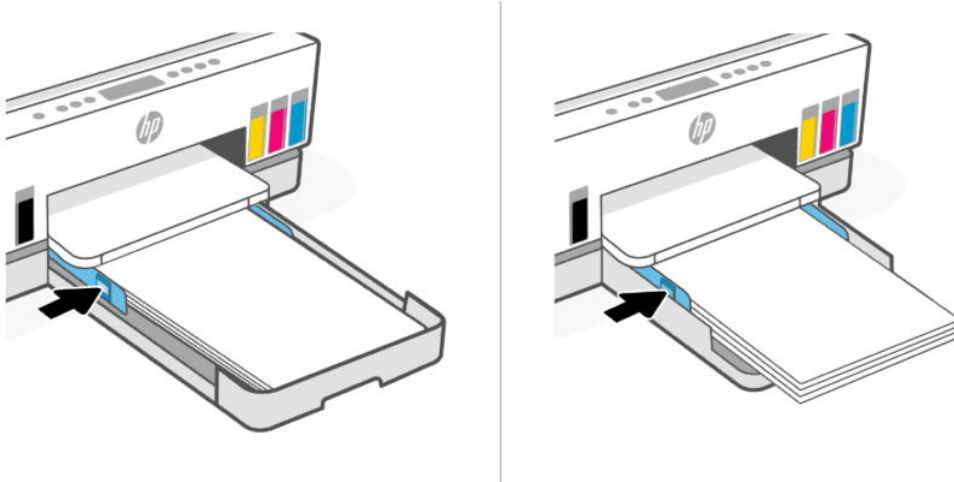

6. Close the input tray.

 **NOTE:** When you reinsert the tray, the extended part is expected to remain outside the printer.

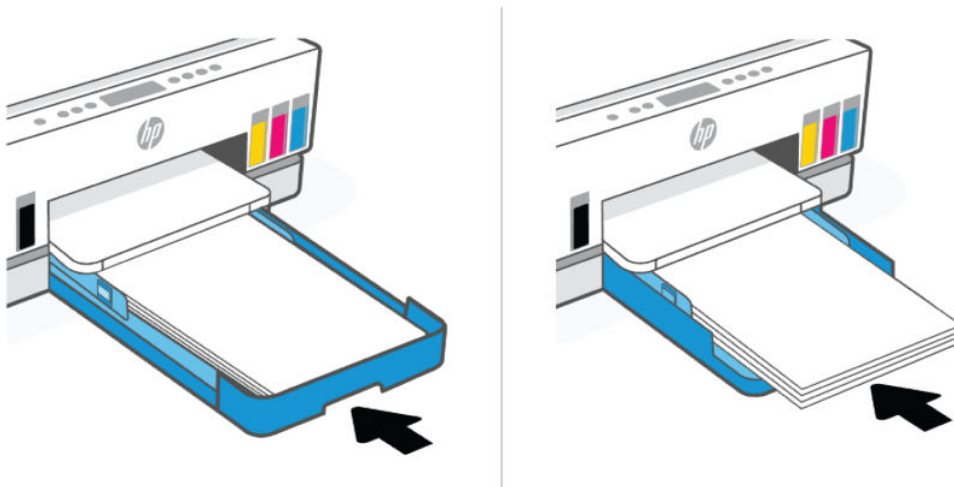

7. Pull out the output tray extender.

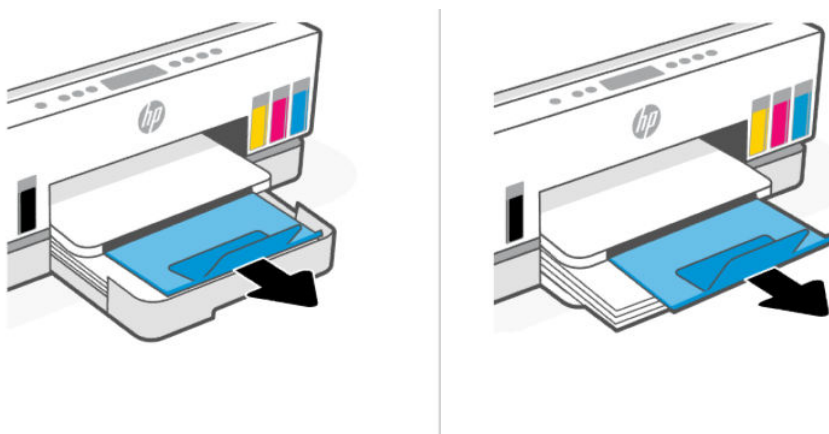

To load an envelope

1. Open the input tray.
2. Press and hold the button on the paper-width guide, and then slide the guides to the edges of the tray.
3. Insert the envelope in portrait orientation and with the side to be printed facing down.

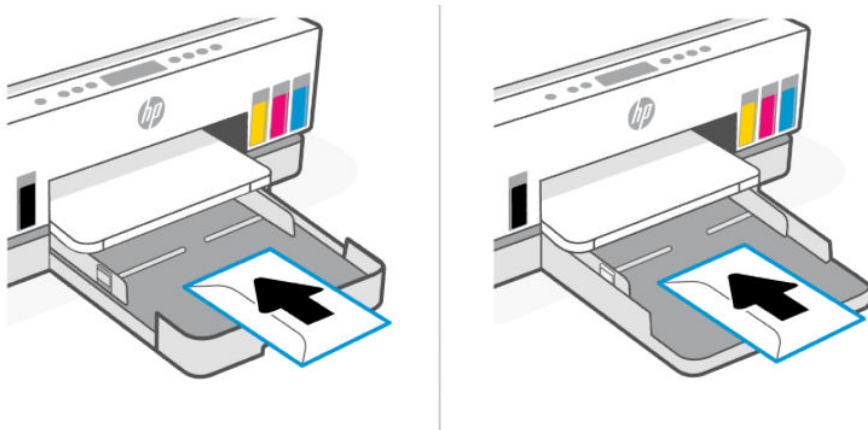

Make sure the stack of paper is aligned with the appropriate paper size lines in the tray. Also, make sure the stack of paper does not exceed the stack-height marking in the tray.



4. Adjust the paper-width guides until they touch the edges of the stack of paper.

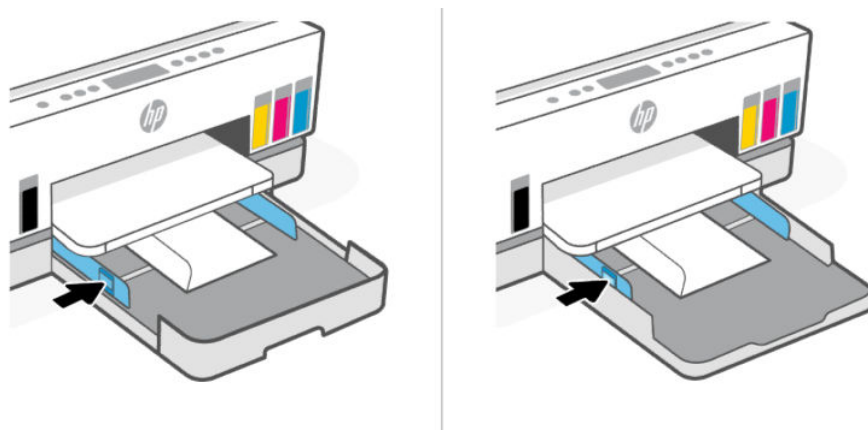

5. Close the input tray.
6. Pull out the output tray extender.

To load cards and photo paper

1. Open the input tray.
2. Press and hold the button on the paper-width guide, and then slide the guides to the edges of the tray.
3. Insert the cards or photo paper in portrait orientation and with the side to be printed facing down.

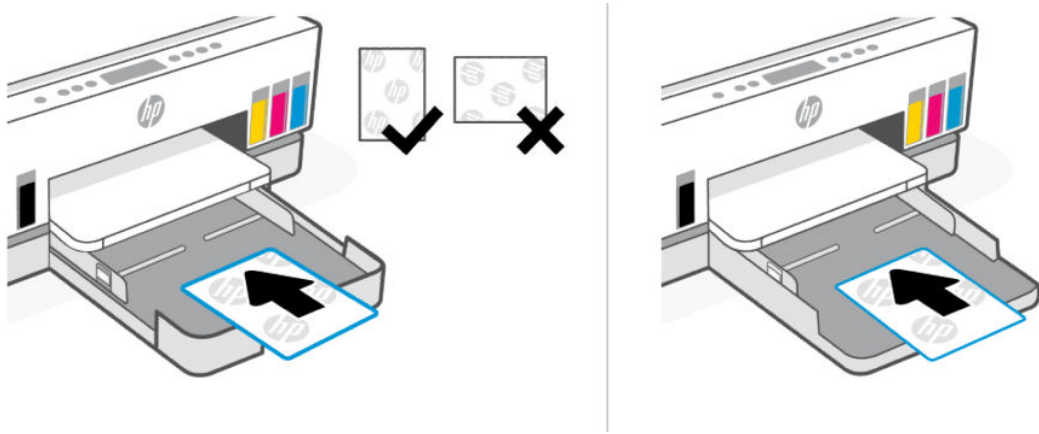

Make sure the stack of paper is aligned with the appropriate paper size lines in the tray. Also, make sure the stack of paper does not exceed the stack-height marking in the tray.



4. Adjust the paper-width guides until they touch the edges of the stack of paper.

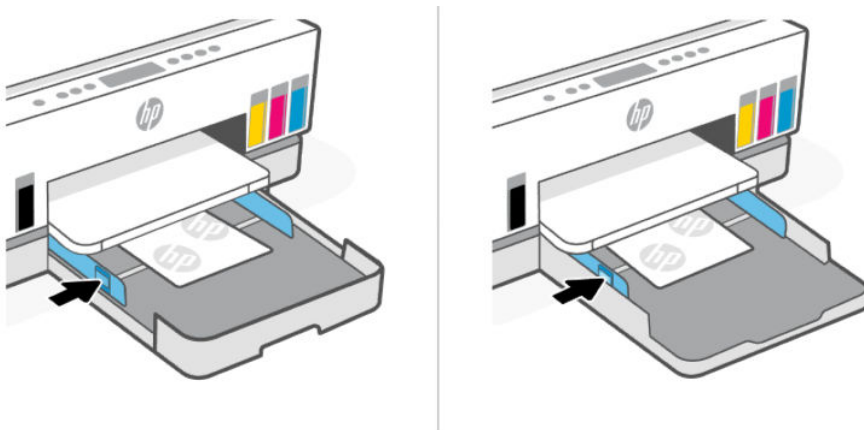

5. Close the input tray.
6. Pull out the output tray extender.

Load original

This topic describes how to load an original into the printer.

To load an original on the scanner glass

1. Lift the scanner lid.



2. Load the original print-side down on the scanner glass (aligned to the indicated corner).



3. Close the scanner lid.



To load an original in the document feeder (some printer models)

1. Open the document feeder output tray extender.

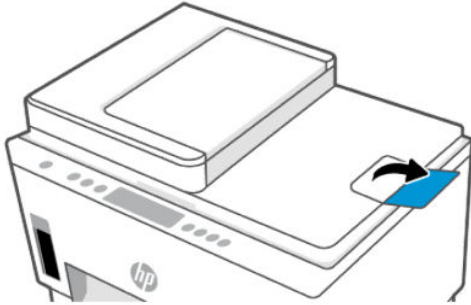

2. Open the document feeder input tray.

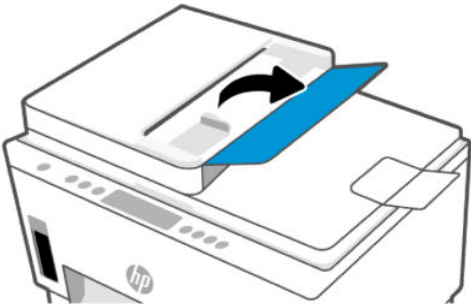

3. Slide the paper-width guides outwards.

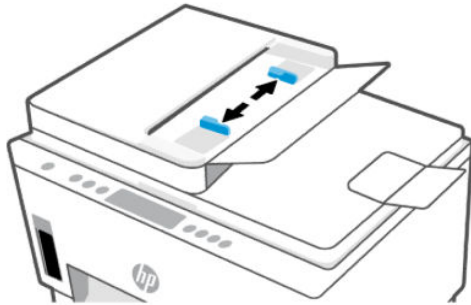

4. Load original print-side up in the document feeder.

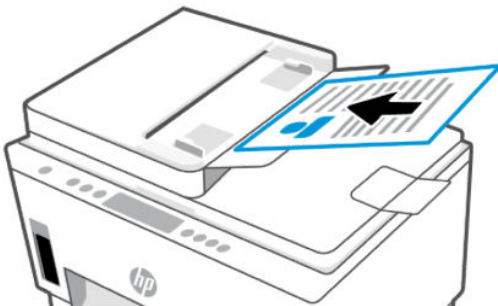

5. Slide the paper-width guides inward until they stop at the edge of the paper.

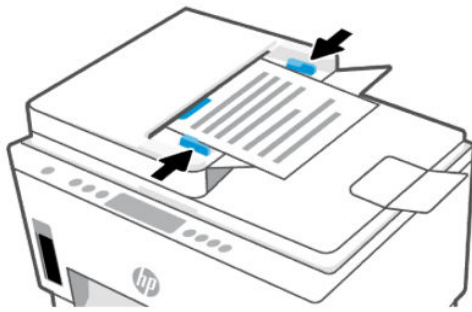

Change the paper settings from the embedded web server (EWS)

 **NOTE:** For your security, some settings in the embedded web server (EWS) are password-protected. Enter the password if prompted. This is the password you have set in the EWS or the default PIN on a label in the ink access area.

1. Open EWS. See [To access and use EWS](#).
2. Click the **Settings** tab.
3. From the left menu, click **Preferences**.
4. Click **Tray and Paper Management**, and then make the necessary changes.
5. Click **Apply**.

Paper basics

The printer is designed to work well with most types of office paper. It is best to test a variety of print paper types before buying large quantities.

Use HP paper for optimum print quality. Visit the HP website at www.hp.com for more information about HP paper.



HP recommends plain papers with the ColorLok logo for printing everyday documents. All papers with the ColorLok logo are independently tested to meet high standards of reliability and print quality, and produce documents with crisp, vivid color, bolder blacks, and that dry faster than ordinary plain papers. Look for papers with the ColorLok logo in a variety of weights and sizes from major paper manufacturers.

Recommended papers for printing

If you want the best print quality, HP recommends using HP papers that are specifically designed for the type of project you are printing. Depending on your country/region, some of these papers might not be available.

Photo printing

- **HP Advanced Photo Paper**

This glossy photo paper features an instant-dry finish for easy handling without smudging. It resists water, smears, fingerprints, and humidity. Your prints have a look and feel comparable to a store-processed photo. It is available in several sizes, including A4, 8.5 x 11 inches, 10 x 15 cm (4 x 6 inches), 13 x 18 cm (5 x 7 inches). It is acid-free for longer lasting documents.

- **HP Everyday Photo Paper**

Print colorful, everyday snapshots at a low cost, using paper designed for casual photo printing. This affordable photo paper dries quickly for easy handling. Get sharp, crisp images when you use this paper with any inkjet printer. It is available in glossy finish in several sizes, including A4, 8.5 x 11 inches, 5 x 7 inches, and 4 x 6 inches (10 x 15 cm). It is acid-free for longer lasting documents.

- **HP Photo Value Packs**

HP Photo Value Packs conveniently package original HP ink cartridges and HP Advanced Photo Paper to save you time and take the guesswork out of printing affordable, lab-quality photos with your HP printer. Original HP inks and HP Advanced Photo Paper have been designed to work together so your photos are long lasting and vivid, print after print. Great for printing out an entire vacation's worth of photos or multiple prints to share.

Business documents

- **HP Enhanced Laser Matte Paper 150g**

This paper is a heavy matte laser paper, ideal for printing professional-color marketing materials including brochures.

- **HP Brochure Paper 180g Glossy or HP Professional Paper 180 Glossy**

These papers are glossy-coated on both sides for two-sided use. They are the perfect choice for near-photographic reproductions and business graphics for report covers, special presentations, brochures, mailers, and calendars.

Everyday printing

All the papers listed for everyday printing feature ColorLok Technology for less smearing, bolder blacks, and vivid colors.

- **HP Bright White Inkjet Paper**

HP Bright White Inkjet Paper delivers high-contrast colors and sharp text. It is opaque enough for two-sided color usage with no show-through, which makes it ideal for newsletters, reports, and flyers.

- **HP Printing Paper**

HP Printing Paper is a high-quality multifunction paper. It produces documents that look and feel more substantial than documents printed on standard multipurpose or copy paper. It is acid-free for longer lasting documents.

- **HP Office Paper**

HP Office Paper is a high-quality multifunction paper. It is suitable for copies, drafts, memos, and other everyday documents. It is acid-free for longer lasting documents.

- **HP Office Recycled Paper**

HP Office Recycled Paper is a high-quality multifunction paper made with 30% recycled fiber.

Order HP paper supplies

The printer is designed to work well with most types of office paper. Use HP paper for optimum print quality.

To order HP papers and other supplies, go to www.hp.com. At this time, some portions of the HP website are available in English only.

HP recommends plain papers with the ColorLok logo for printing and copying of everyday documents. All papers with the ColorLok logo are independently tested to meet high standards of reliability and print quality, and produce documents with crisp, vivid color, bolder blacks and shorter dry-time than ordinary plain papers. Look for papers with the ColorLok logo in a variety of weights and sizes from major paper manufacturers.

4 Print

This section describes how to print from different devices.

This printer is designed to work with the HP Smart app, a software application that makes it easy to print, scan, and manage your printer from a smartphone, laptop, desktop computer, or other devices.

You can print and manage the printer from all of your devices by installing the app on each device. For more information about the app, see [Use the HP Smart app to print, scan, and manage](#).

Print from a Windows computer

1. Make sure you have installed the HP Smart. See [Use the HP Smart app to print, scan, and manage](#).
2. Open the document you wish to print.
3. From the **File** menu in your software program, select the **Print** option.
4. Click the button that opens the **Properties** dialog box.

Depending on your software application, this button might be called **Properties**, **Options**, **Setup**, or **Preferences**.

5. Make sure your printer is selected.
6. Change any print settings, and click **OK**.
7. Click **Print** or the **OK** button to print.

Print from a Mac computer

1. Make sure you have installed the HP Smart app. See [Use the HP Smart app to print, scan, and manage](#).
2. From the computer, open **System Preference**, and select **Printers and Scanners**.
3. Click the Add button/icon + , select the printer from the printer list, and then click **Add**.
4. Once connected, open the document you wish to print and use the **Print** command.
5. Make sure the desired printer is selected.
6. Change any print settings.
7. Click **Print** to print the document.

Print with mobile devices

You can use the HP Smart app to print documents and photos from your mobile device, social media account, or cloud storage.

See [Use the HP Smart app to print, scan, and manage](#).

You can also print directly from your mobile devices using AirPrint (iOS) or HP Print Service Plugin (Android):

- **iOS:** Devices running iOS 4.2 or later have AirPrint pre-installed.
- **Android:** Download the HP Print Service Plugin from the Google Play Store or your favorite app store, and then enable it on your device.

 **NOTE:** You can print using HP Smart or AirPrint/HP Print Service Plugin when the mobile device is on the same network as the printer or a different network (using Wi-Fi Direct).

Print while connected to same Wi-Fi network

You can print documents and photos from your mobile device when the device is on the same Wi-Fi network as the printer.

Visit www.hp.com/go/mobileprinting for more information on mobile printing.

 **NOTE:** Make sure your mobile device and printer are connected to the same Wi-Fi network. See [Connect your printer to a Wi-Fi network using HP Smart](#).

Print without connecting to same Wi-Fi network (Wi-Fi Direct)

With Wi-Fi Direct, you can directly connect your computer or mobile device to the printer and print wirelessly—without connecting your computer or mobile device to an existing wireless network.



Visit www.hp.com/go/wifidirectprinting for more information on Wi-Fi Direct.

 **NOTE:**

- Make sure Wi-Fi Direct on your printer is turned on. When Wi-Fi Direct is turned on, the Wi-Fi Direct icon  should appear on the printer display.
 - Up to 5 computers and mobile devices can connect to the printer using Wi-Fi Direct connection.
-

To turn Wi-Fi Direct on or off

When Wi-Fi Direct is turned on, the Wi-Fi Direct icon  should appear on the printer display. If the icon is off, follow these instructions.

1. From the printer control panel, press and hold the Information button  for 5 seconds until the control panel buttons light up.
2. Press and hold the Wi-Fi button  and the Resume button  at the same time for 3 seconds.

 **NOTE:** When you turn on Wi-Fi Direct the first time, the printer automatically prints a Wi-Fi Direct guide. The guide provides instructions about how to use Wi-Fi Direct. See [Print reports from the printer control panel](#).

To find the Wi-Fi Direct name or password

From the printer control panel, press the Information button  to print the printer information page.



NOTE: For other network details, print the network configuration page. See [Print reports from the printer control panel](#).

To change the Wi-Fi Direct connection security settings for the printer using the embedded web server (EWS)



1. Open EWS. See [To access and use EWS](#).
2. Click the **Network** tab.
3. From the left menu, click **Wi-Fi Direct**, and then click the **Edit Settings** button.
4. Make the necessary changes.
5. Click **Apply**.

5 Copy, Scan, and Mobile Fax

This section describes the copy, scan, and use mobile fax features.

Copy from the printer

 **NOTE:** All documents are copied in normal quality print mode. You cannot change the print mode quality when copying.

1. Load paper in the input tray.
See [Load paper](#).
2. Place the original print-side up in the document feeder or print-side down on the scanner glass (aligned to the corner with an icon).
See [Load original](#).
3. From the printer control panel, press the Black Copy button  or the Color Copy button  to start copying.

To increase the number of copies, press and hold the button or press it multiple times.

Copying starts 2 seconds after the last button press.

Copy an identification (ID) card (some printer models)

The ID Copy feature allows you to place a card or small-size document anywhere on the scanner glass to copy both sides onto the same page.

1. Load paper in the input tray.
See [Load paper](#).
2. Place the card anywhere on the scanner glass, away from the edges or corners of the glass.
3. Close the scanner lid.



4. Press the ID Copy button  to enter the ID Copy mode.

The Color Copy button  and the Black Copy button  will blink or light up.

5. Press either copy button to copy one side of the card.

To increase the number of copies, press and hold the button or press it multiple times.

6. When the Open Lid light  blinks or lights up, open the scanner lid, flip the card on the scanner glass, and then close the scanner lid.



7. Press the copy button that is blinking or lit to copy the other side.
8. Wait for the page to print.

Scan using the HP Smart app (iOS, Android, Windows 10, and macOS)

You can use the HP Smart app to scan documents or photos from the printer's scanner, and you can also scan using your device camera. HP Smart includes editing tools that allow you to adjust the scanned image before saving or sharing. You can print, save your scans locally or in cloud storage, and share them via email, SMS, Facebook, Instagram, etc. To scan with HP Smart, follow the instructions provided in the appropriate URLs below, depending on the type of device you are using.

- **iOS/Android:** www.hp.com/go/hpsmart-help

- **Windows 10:** www.hp.com/go/hpsmartwin-help
- **macOS:** www.hp.com/go/hpsmartmac-help

Scan using the HP printer software

This topic describes how to scan using the HP printer software.

Scan from a computer

Before scanning from a computer, make sure you have already installed the HP recommended printer software. The printer and computer must be connected and turned on.

To scan a document or photo to a file (Windows)

1. Place the original print-side up in the document feeder or print-side down on the scanner glass (aligned to the corner with an icon).
2. In the HP printer software (available from the **Start** menu), click **Scan**, and then click **Scan a Document or Photo**.
3. Select the type of scan you want, and then click **Scan**.

Choose the file format to save the document (or photo).



NOTE:

- Click the **More** link at the top right corner of the Scan dialog to review and modify settings for any scan. See [Change scan settings \(Windows\)](#).
- If **Show Viewer After Scan** is selected, you can make adjustments to the scanned image in the preview screen.

To scan a document or photo to email (Windows)

1. Place the original print-side up in the document feeder or print-side down on the scanner glass (aligned to the corner with an icon).
2. In the HP printer software, available from the **Start** menu, click **Scan**, and then click **Scan a Document or Photo**.
3. Select the type of scan you want, and then click **Scan**.



NOTE:

- Click the **More** link at the top right corner of the Scan dialog to review and modify settings for any scan. See [Change scan settings \(Windows\)](#).
- If **Show Viewer After Scan** is selected, you can make adjustments to the scanned image in the preview screen.

Change scan settings (Windows)

You can modify any of the scan settings either for a singular use or save the changes to use permanently. These settings include options such as page size and orientation, scan resolution, contrast, and the folder location for saved scans.

1. Place the original print-side up in the document feeder or print-side down on the scanner glass (aligned to the corner with an icon).
2. In the HP printer software, available from the **Start** menu, click **Scan**, and then click **Scan a Document or Photo**.
3. Click the **More** link in the top right corner of the HP Scan dialog.

The detailed settings pane appears on the right. The left column summarizes the current settings for each section. The right column allows you to change the settings in the highlighted section.

4. Click each section at the left of the detailed settings pane to review the settings in that section.

You can review and change most settings using drop-down menus.

Some settings allow greater flexibility by displaying a new pane. These are indicated by a + (plus sign) at the right of the setting. You must either click **OK** to accept or click **Cancel** to cancel any changes on this pane to return to the detailed settings pane.

5. When you have finished changing settings, do one of the following:
 - Click **Scan**. You are prompted to save or reject the changes to the shortcut after the scan is finished.
 - Click the save icon to the right of the shortcut, and then click **Scan**.

Create a new scan shortcut (Windows)

You can create your own scan shortcut to make scanning easier. For example, you might want to regularly scan and save photos in PNG format, rather than JPEG.

1. Place the original print-side up in the document feeder or print-side down on the scanner glass (aligned to the corner with an icon).
2. In the HP printer software, available from the **Start** menu, click **Scan**, and then click **Scan a Document or Photo**.
3. Click **Create New Scan Shortcut**.
4. Enter a descriptive name, choose an existing shortcut on which to base your new shortcut, and then click **Create**.
5. Change the settings for your new shortcut to meet your needs, and then click the save icon to the right of the shortcut.



NOTE: Click the **More** link at the top right corner of the Scan dialog to review and modify settings for any scan.

For more information, see [Change scan settings \(Windows\)](#).

Scan using Webscan

Webscan is a feature of the EWS that lets you scan photos and documents from your printer to your device using a web browser.



NOTE: For your security, some settings in the EWS are password-protected. Enter the password if prompted. This is the password you have set in the EWS or the default PIN on a label in the ink access area.

To enable Webscan

1. Open EWS. For more information, see [To access and use EWS](#).
2. Click the **Settings** tab.
3. From the left menu, click **Security**, and then select **Administrator Settings**.
4. Select the option to enable Webscan.
5. Click **Apply**.

To scan using Webscan

Scanning using Webscan offers basic scan options. For additional scan options or functionality, scan from the HP printer software.

1. Place the original print-side up in the document feeder or print-side down on the scanner glass (aligned to the corner with an icon). See [Load original](#).
2. Open EWS. For more information, see [To access and use EWS](#).
3. Click the **Scan** tab.
4. From the left menu, click **Webscan**.
5. Select the desired options, and then click **Start Scan**.

Tips for successful scanning and copying

Use the following tips to copy and scan successfully:

- Keep the glass and the back of the lid clean. The scanner interprets anything it detects on the glass as part of the image.
- Load the original print-side down on the scanner glass (aligned to the corner with an icon).
- To make a large copy of a small original, scan the original into the computer, resize the image in the scanning software, and then print a copy of the enlarged image.
- To avoid incorrect or missing scanned text, make sure the brightness is set appropriately in the software.
- Make sure to select the correct source (for example, scanner glass) for scanning when using HP software.

Mobile Fax

Use the HP Smart app to quickly scan and fax multiple pages at once from your mobile device or computer.

For more information about Mobile Fax, visit the [HP Smart website](#).

Use Mobile Fax in the HP Smart app

1. Make sure your mobile device or computer are connected to a network. Launch the HP Smart app and sign into or create your HP account.

2. Select the Mobile Fax tile.

If you do not see the **Mobile Fax** tile, enable it as follows:

- On a mobile device: Tap **Personalize Tiles**, tap the **Mobile Fax** toggle to enable the tile, and then go back to the Home screen.
- On a Windows 10 device: Click the **Settings**, select **Personalize Tiles**, and click the **Mobile Fax** toggle to enable the tile. Then, go back to the Home screen.
- On a Mac device: From the menu bar, select **HP Smart >Personalize Tiles**. Set the Mobile Fax option to **On**.



NOTE: Mobile Fax is available in specific countries/regions. If you do not see a Mobile Fax option in the Personalize Menu, Mobile Fax might not be available in your country/region.

3. Fill out the necessary mobile fax information.

4. To add a cover page, tap the **Add a cover page** toggle, and then type a subject and message.

5. Scan the item you want to fax using your printer or mobile device camera, or attach a supported file type. Send the fax when ready.

Your fax will be securely delivered and you can track the status in the HP Smart app.

6 Configure your printer

This section describes how to configure your printer.

Configure the printer using the embedded web server (EWS)

Use the embedded web server (EWS) to manage printing functions from your computer.

- View printer status information
- Check the information and status of the printing supplies
- Receive notification of printer and supplies events
- View and change the network and the printer settings

To access and use EWS

You can open EWS using one of the following:

- HP Smart app
- HP printer software
- Web browser using IP address
- Web browser using Wi-Fi Direct connection

Things to note when accessing EWS

- If the web browser displays a message indicating that the website is unsafe, select the option to continue. Accessing the website will not harm your device.
- The default username is “admin”.
- For your security, some settings in the printer home page or EWS are password-protected.
 - When accessing the EWS for the first time, enter the PIN if prompted. This personal identification number (PIN) is available from a label in the printer.
 - Open the ink access door or cartridge access door to locate the label.
 - Once you have access to EWS, you can change the password from EWS.

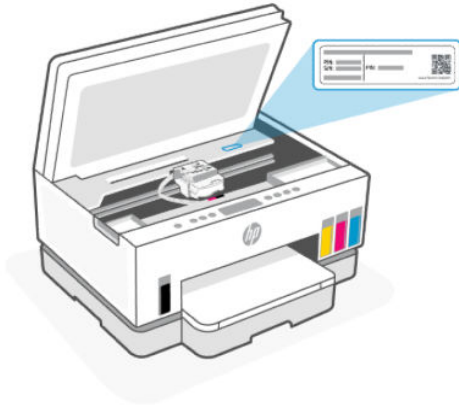

- Depending on how the printer is connected, some features in EWS might not be available.
- EWS is not accessible beyond the network firewall.

To open EWS using HP Smart (iOS, Android, and Windows 10)

1. Open the HP Smart app on your computer or mobile device. See [Use the HP Smart app to print, scan, and manage](#).
2. From HP Smart, select your printer, and then click or tap **Advanced Settings**.

To open EWS using an IP address (Wi-Fi or Ethernet connection)

1. Find out the IP address. Press the Information button  on the printer to print an information page.
2. Open a web browser, type the IP address or hostname in the address bar, and then click or tap **Enter**.

To open EWS using an IP address (Wi-Fi Direct connection)

1. Make sure your device and the printer are connected using Wi-Fi Direct. See [Print while connected to same Wi-Fi network](#).
2. Open a web browser, type the following IP address or hostname of the printer in the address bar, and then click or tap **Enter**.

IP Address: 192.168.223.1

To open EWS using HP Printer software (Windows 7)

1. From the computer desktop, click **Start**, select **All Programs**, click **HP**, click the folder for the printer, select the icon with the printer's name, and then open **HP Printer Assistant**.



NOTE: Windows 7 Service Pack 1 (SP1) is required to install HP printer software.

2. In the **HP Printer Assistant**, select **Print** tab.
3. Select **Printer Home Page (EWS)**.

Configure IP network settings

Use the following sections to configure the printer network settings.

If prompted for a password, enter the PIN which is available from a label in the cartridge access area. See [Things to note when accessing EWS](#).

View or change network settings

Use the embedded web server (EWS) to view or change IP configuration settings.

1. Open EWS. See [To access and use EWS](#).
2. Click the **Network** tab to obtain network information. Change settings as needed.

Rename the printer on a network

To rename the printer on a network so that it can be uniquely identified, use the embedded web server (EWS).

1. Open EWS. See [To access and use EWS](#).
2. Click the **Network** tab.
3. From the left menu, click **General**.
4. Click **Network Identification**.
5. Make the necessary changes, and then click **Apply**.

Manually configure IPv4 TCP/IP parameters

Use the embedded web server (EWS) to manually set an IPv4 address, subnet mask, and default gateway.

1. Open EWS. See [To access and use EWS](#).
2. Click the **Network** tab.
3. From the left menu, click **Wired**.
4. Click **IPv4 Configuration**.
5. Make the necessary changes, and then **Apply**.

Assign or change the system password using the embedded web server (EWS)

Assign an administrator password for access to the printer and EWS so that unauthorized users cannot change the printer settings.

1. Open EWS. See [To access and use EWS](#).
2. Click the **Settings** tab.
3. From the left menu, click **Security**.
4. Click **Password Settings**.
5. Make the necessary changes, and then click **Apply**.



NOTE: Make note of the password and store it in a safe place.

Update the printer

This topic describes how to update the printer firmware.

HP periodically releases firmware updates to enhance product functionality and fix issues. By default, if the printer is connected to the Internet, the printer automatically checks for updates at regular intervals.

To update the printer or change the settings from the embedded web server (EWS)

1. Open EWS. See [To access and use EWS](#).
2. Click the **Tools** tab.
3. From the left menu, click **Printer Updates**, and then select **Firmware Updates**.
4. Select the desired options, and then click **Apply**.

Use Web Services

This topic describes how to use Web services.



NOTE: For your security, some settings in the embedded web server (EWS) are password-protected. Enter the password if prompted. This is the password you have set in the EWS or the default PIN on a label in the ink access area.

To set up Web Services using the embedded web server (EWS)

1. Open EWS. See [To access and use EWS](#).
2. Click the **Web Services** tab.
3. From the left menu, click **Web Services Settings**.
4. Click **Setup**, select the relevant option or button to continue, and follow the on-screen instructions to accept the terms of use.



NOTE: If prompted for proxy settings and if your network uses proxy settings, follow the on-screen instructions to set up a proxy server. If you do not have the proxy details, contact your network administrator or the person who set up the network.

5. When the printer is connected to the server, the printer prints an information page. Follow the instructions on the information page to finish the setup.

To remove Web Services using the embedded web server (EWS)

1. Open EWS. See [To access and use EWS](#).
2. Click the **Web Services** tab.
3. From the left menu, click **Web Services Settings**, click **Remove Web Services**, and then follow the on-screen instructions.

7 Manage ink and printheads

This section describes how to manage ink and printheads.

Check the ink levels

You can check the ink levels from the ink tanks on the printer. You can also check the HP printer software or printer control panel to determine when the tanks need to be refilled.

If you are using the HP Smart app, the estimated ink levels of the selected printer is displayed on the Home screen.

To check the estimated ink levels from the printer software (Windows)

1. In the HP printer software (available from the **Start** menu), click **Estimated Levels** at the top of the window.
2. In the Toolbox, click the **Estimated Levels** tab.

Refill ink tanks

 **NOTE:** Product service or repairs required as a result of filling the ink tanks improperly and/or using non-HP ink will not be covered under warranty.

To refill the ink tanks

1. Open the ink access door and tank covers.

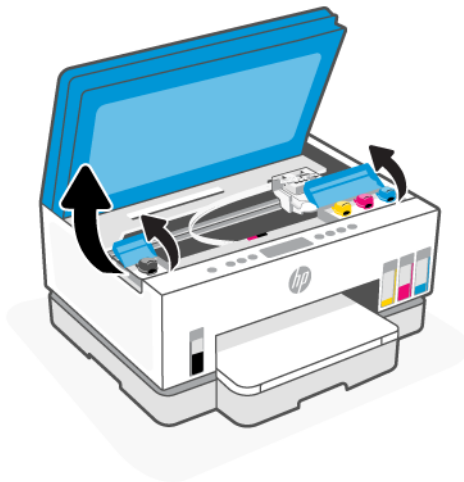

2. Open the cap of the ink tank you plan to refill.

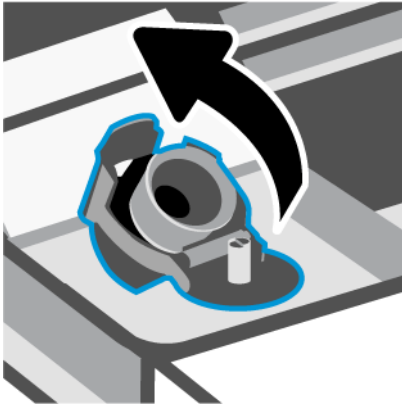

3. Depending on the type of ink bottles you have, do one of following:

- **Screw-cap bottles:** Twist open the cap on the ink bottle.



- **Flip-cap bottles:** Twist open the cap on the ink bottle, remove the seal from the bottle, screw back the cap and tighten it. Then, flip open the top of the cap.

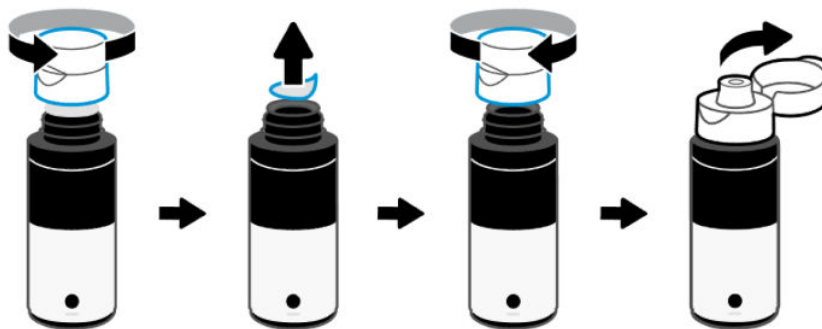

4. Match the color of the ink bottle with the color of the ink tank.

Place the bottle upside down on the tank, make sure the tip of the bottle fits properly over the tank nozzle.

 **NOTE:**

- For screw-cap bottles, the tip of the bottle should click into place when pressed down gently over the tank nozzle.
 - Do not squeeze the ink bottles when filling ink. The ink bottles you have might vary.
 - If there is leftover ink in the bottle, store the bottle in an upright position in a cool and dry location.
-

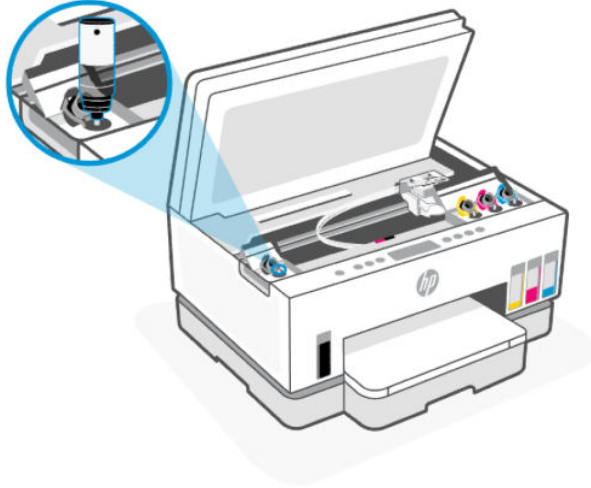

5. Let the ink drain into the tank until the tank is full.
If the ink does not drain immediately, remove the bottle and properly reinsert it on the tank.
6. Close the tank cap securely.

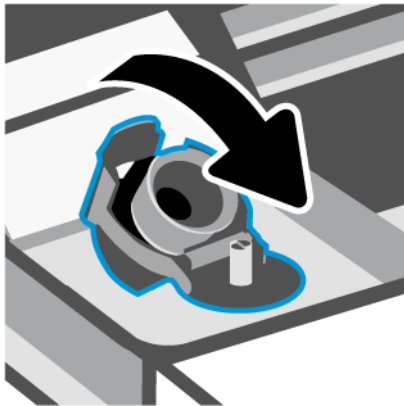

7. Repeat steps 2 to 6 to refill other ink tanks.

8. Close the tank covers and ink access door.

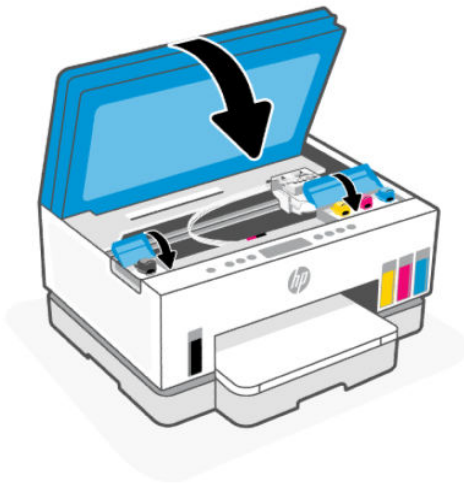

Precautions for working with ink bottles

Use the following tips to work with ink bottles:

- Keep the ink bottles beyond the reach of children.
- Open the ink bottles only when you plan to fill the ink tanks.
- Do not tilt, shake, or squeeze the ink bottle when it is open to prevent ink leaks.
- Store the ink bottles in a cool, dark place.
- Do not drink or place in mouth.

Order ink supplies

Before ordering ink bottles, visually check the labels on the ink bottles to locate the ink bottle numbers. You can also find this information on a label in the ink access area.

To order original HP supplies for the printer, go to www.hp.com/buy/supplies. If prompted, choose your country/region, and then follow the prompts to find the right ink bottles for your printer.

 **NOTE:** Ordering ink bottles online is not supported in all countries/regions. If it is not available in your country/region, you may still view supplies information and print a list for reference when shopping at a local HP reseller.

Print with black ink only (Windows)

1. From your software, select **Print**.
2. Make sure your printer is selected.

3. Click the button that opens the **Properties** dialog box.

Depending on your software application, this button might be called **Properties**, **Options**, **Printer Setup**, **Printer Properties**, **Printer**, or **Preferences**.

4. Select the appropriate options.

- **Windows 10**

- Click **Paper/Quality** tab.
- Under **Print in Grayscale**, select **Black Ink Only** from the list, and then click **OK**.

- **Windows 7**

- On the **Layout** or **Paper/Quality** tab, click the **Advanced** button to open the **Advanced Options** dialog box.
- From the **Print in Grayscale** drop-down list, select **Black Ink Only**, and then click **OK**.

Improve print quality

You can print a diagnostics page to determine if cleaning or aligning the printheads is recommended to improve print quality.

To print a print quality diagnostics page, see [Print reports from the printer control panel](#).

You can also use the HP Smart app to improve the print quality. For information about this app, see [Use the HP Smart app to print, scan, and manage](#).

To print a print quality diagnostics page (Windows)

1. Load Letter or A4 unused plain white paper into the input tray.
2. In the HP printer software (available from the **Start** menu), click **Print & Scan** at the top of the window.
3. In the **Print** section, click **Maintain Your Printer** to access the Toolbox.
4. In the Toolbox, click the **Device Services** tab, and then click the option to print the page.

Understand the print quality diagnostics page

1. Review the black, cyan, magenta, and yellow boxes along with the other content on the diagnostics page.

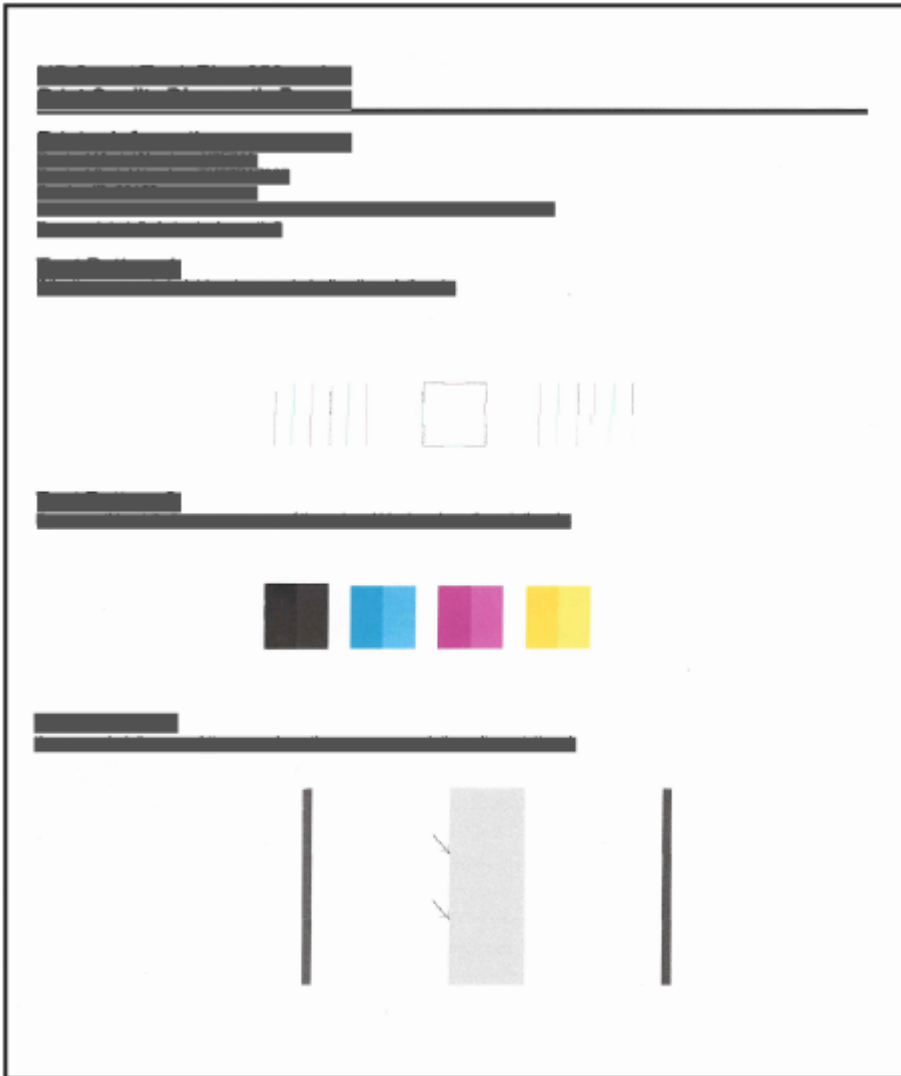

2. If the diagnostic page shows steaks or missing portions of the color and black boxes, then automatically clean the printheads.
See [Align and clean printheads](#).
3. If straight lines appear jagged on printouts, or the diagnostic page indicates to align the printheads, then automatically align the printheads.
See [Align and clean printheads](#).
4. If print quality problems persist after cleaning and aligning printheads, contact HP support.

Align and clean printheads

The printer has a feature to automatically align or clean the printheads.

You can check the print quality diagnostics page to determine if aligning or cleaning is recommended. See [Understand the print quality diagnostics page](#).

- **Align printheads:** Aligning the printheads can improve print quality. If you notice misaligned colors or lines in your printouts or on the print quality diagnostics page, you should perform an alignment.
- **Clean printheads:** If your prints are streaked or have incorrect or missing colors, the printheads might need to be cleaned.



NOTE:

- The cleaning process prints one page to attempt to clean the printheads.
 - Clean the printheads only when necessary. Unnecessary cleaning wastes ink and shortens the life of the printheads.
-

To align or clean the printheads from the embedded web server (EWS)

1. Open EWS. See [To access and use EWS](#).
2. Click the **Tools** tab.
3. From the left menu, click **Utilities**, and select **Print Quality Toolbox**.
4. Click the button next to the option to align or clean printheads.

To align or clean the printheads (Windows)

1. Load Letter or A4 unused plain white paper into the input tray.
2. In the HP printer software (available from the **Start** menu), click **Print & Scan** at the top of the window.
3. In the **Print** section, click **Maintain Your Printer** to access the Toolbox.
4. In the Toolbox, click the **Device Services** tab, click the desired option, and then follow the on-screen instructions.

Clean printer

You can run a cleaning routine from the printer software to prevent back of page smearing.

To clean the printer from the printer software (Windows)

1. Load Letter or A4 unused plain white paper into the input tray.
2. In the HP printer software (available from the **Start** menu), click **Print & Scan** at the top of the window.
3. In the **Print** section, click **Maintain Your Printer** to access the Toolbox.
4. In the Toolbox, click the **Device Services** tab, click the desired option, and then follow the on-screen instructions.

Tips for working with ink and printheads

Printhead tips

Use the following tips to work with printheads:

- Use original HP printheads.
- Handle printheads with care. Do not drop the printheads, and do not touch the electric contacts or print nozzles on any surface.
- To protect the printheads from drying out, always turn the printer off using the Power button, and wait until the Power button light goes out.
- Do not open or untape printheads until you are ready to install them, as this can lead to print quality issues. Leaving tape on the printheads reduces ink evaporation.
- Install both the black and color printheads correctly. See [To verify the printheads are installed properly](#).
- After you have set up the printer, do not open the printhead cover unless instructed to do so.
- You can align the printheads to improve the print quality. See [Improve print quality](#) for more information.
- If you remove a printhead from the printer for any reason, try to replace it again as soon as possible. If left unprotected outside the printer, the printhead may begin to dry out.

Ink tips

Use the following tips to work with ink:

- Make sure the ink tanks are not low on ink before printing. See [Check the ink levels](#).
- Refill the ink tanks when they are low on ink. Printing with the ink tanks low on ink may cause damage to your printer.
- Do not tilt the printer.



NOTE: Original HP printheads and ink are designed and tested with HP printers and papers to help you easily produce great results, time after time.

HP cannot guarantee the quality or reliability of non-HP supplies. Product service or repairs required as a result of using a non-HP supply will not be covered under warranty.

Move printer

To prevent damage to the printer or ink leakage, follow these instructions.

If you are moving the printer within your home or office, keep the printhead cover closed, and keep the printer horizontal.

To move the printer to a different location outside of your home or office, see the instructions provided in box for moving printer, or visit hp.com/support.

8 Solve a problem

This section suggests solutions to common problems.

If the suggestions do not solve the problems, try getting help using one of the support services, see [HP support](#).

You can also get help from the HP Smart app and printer control panel:

- HP Smart: Provides alerts for printer issues (jams and other problems), links to help content, and options to contact support for additional assistance. See [Use the HP Smart app to print, scan, and manage](#).
- Printer control panel: See [Understand control panel lights and display icons](#).

Jams and paper-feed issues

This topic helps you troubleshoot jams and paper-feed issues.

Clear a paper or print carriage jam

Paper jams can occur in several locations. For print carriage jams, remove any objects, including paper, that are blocking the print carriage in the ink access area.

 **NOTE:** Do not use any tools or other devices to remove jammed objects. Always use caution when removing jammed objects from inside the printer.

To clear paper jams from the tray

1. Remove the input tray.
2. Remove the output tray.

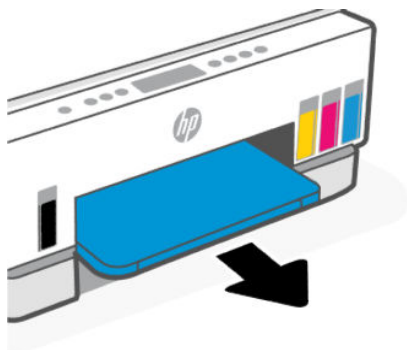

3. Remove the duplexer plate. Do this by carefully reaching inside the gap where the trays were and pulling out the plate.



4. Remove any jammed paper.

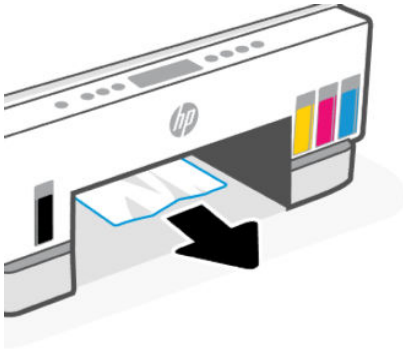

5. Reinsert the duplexer plate, the output tray, and then the input tray.

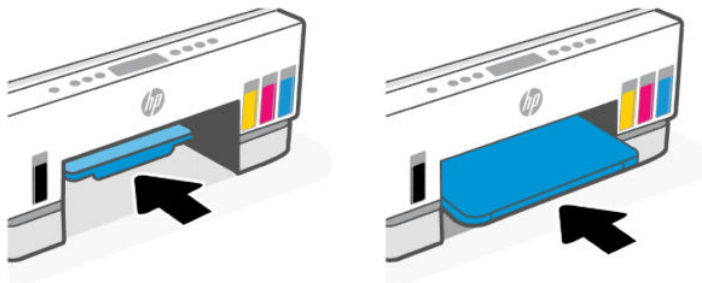

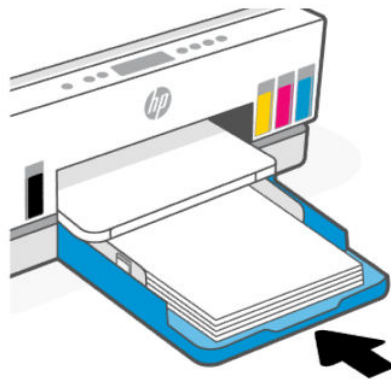
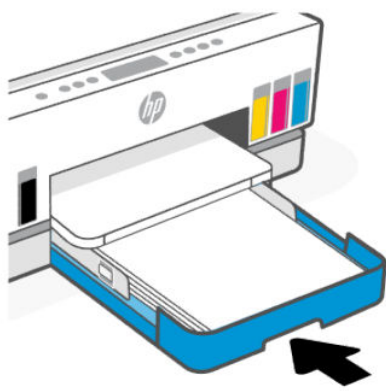

To clear paper jams from the inside of the printer

1. Lift the ink access door.

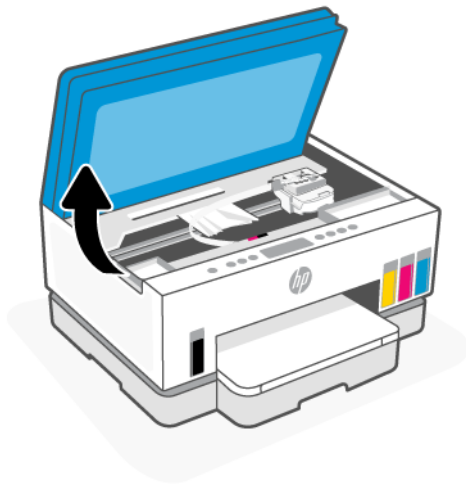

2. Remove any jammed paper.

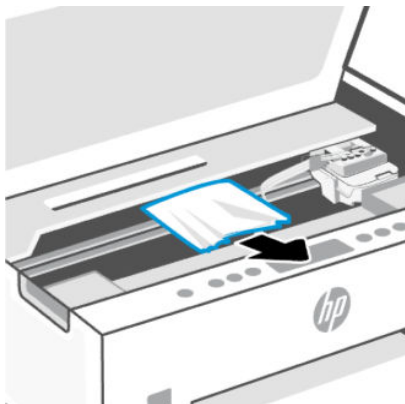

3. Close the ink access door.

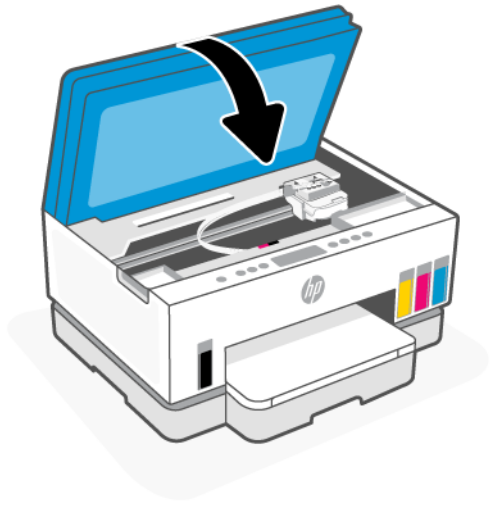

To clear paper jams from the rear of the printer

1. Open the door at the rear of the printer.

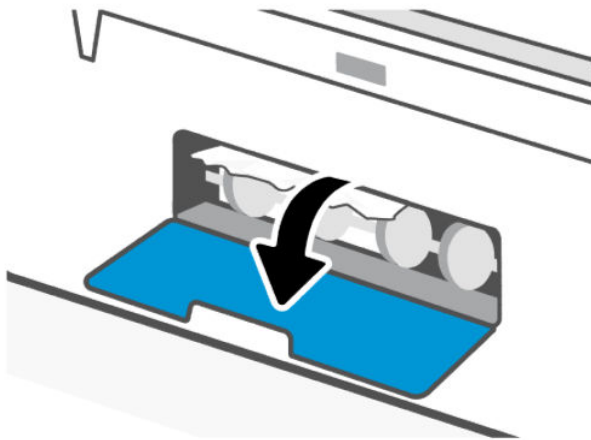

2. Remove any jammed paper.

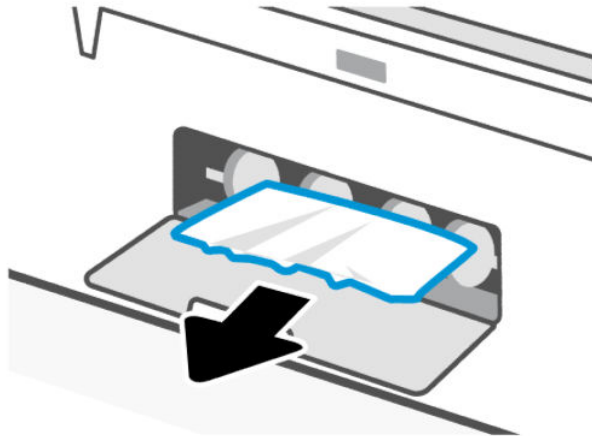

3. Close the rear door.

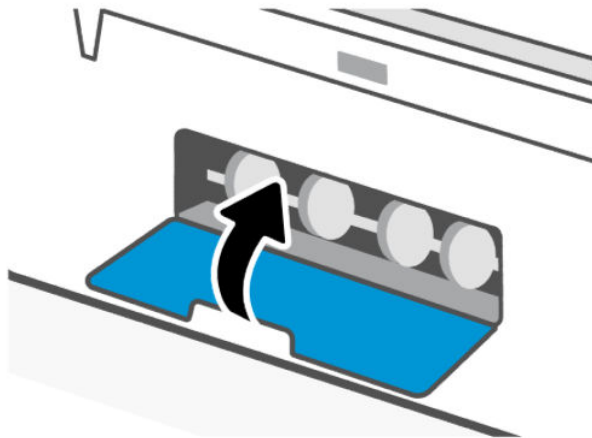

To clear paper jams from the document feeder (some printer models)

 **NOTE:** If paper jams keep occurring when using the document feeder, and other means to avoid document feeder jams do not help, try cleaning the document feeder glass area using a dry, lint-free cloth. See [Clean the document feeder glass area \(some printer models\)](#).

1. Open the document feeder cover.

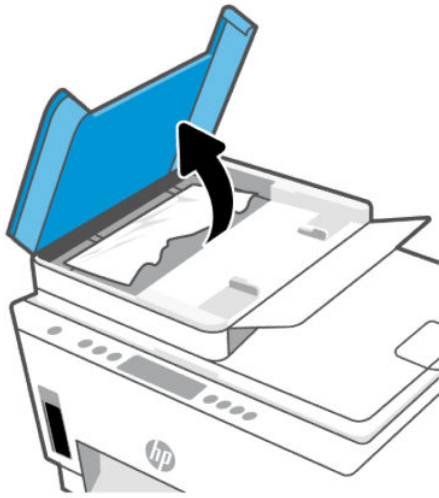

2. Remove any jammed paper.

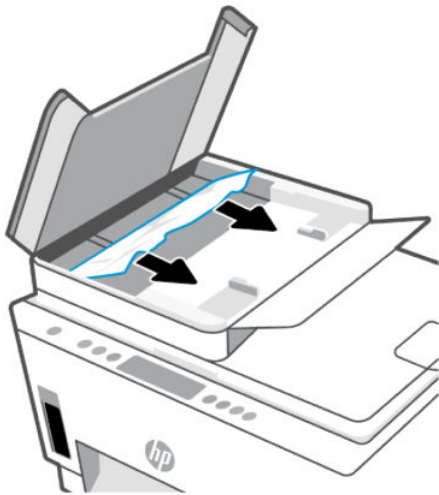

3. Close the document feeder cover.

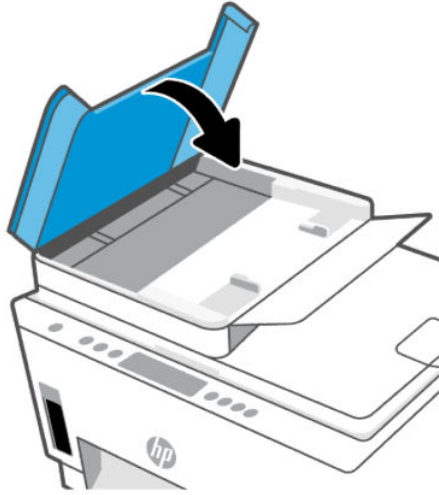

Learn how to avoid paper jams

To avoid paper jams, follow these guidelines.

- Do not overfill the input tray, but make sure that you have at least 5 pages loaded, for best results.
- Keep your printer free of dust and debris by removing paper and closing the input tray when not in use.
- Remove printed papers from the output tray frequently.
- Ensure that paper loaded in the input tray lays flat, and the edges are not bent or torn.
- Do not combine different paper types and paper sizes in the input tray; the entire stack of paper in the input tray must be the same size and type.

Use HP paper for optimum performance. See [Paper basics](#) for more information about HP paper.

- Adjust the paper-width guides in the input tray to fit snugly against all paper. Make sure the paper-width guides do not bend the paper in the input tray.
- Do not force paper too far down in the input tray.
- Do not add paper while the printer is printing. Wait for the printer to prompt before loading paper.

Solve paper-feed problems

What kind of problem are you having?

- **Paper is not picked up from the input tray**
 - Make sure paper is loaded in the input tray. See [Load paper](#).
 - Adjust the paper-width guides in the input tray to fit snugly against all paper. Make sure the paper-width guides do not bend the paper in the input tray.
 - Make sure paper in the input tray is not curled. Uncurl paper by bending it in the opposite direction of the curl.

- Prevent curled or wrinkled paper by storing all unused paper flat in a resealable bag.
- After printing is finished, remove unused photo paper from the input tray. Store the photo paper so it does not start to curl, which could reduce the quality of your printout.
- Clean the paper rollers.
- **Pages are skewing**
 - Make sure the paper loaded in the input tray is aligned to the paper-width guides. If needed, pull out the input tray from the printer and reload the paper correctly, making sure that the paper guides are aligned correctly.
 - Load paper into the printer only when it is not printing.
 - Make sure the rear access door is securely shut.
- **Multiple pages are being picked up**
 - Adjust the paper-width guides in the input tray to fit snugly against all paper. Make sure the paper-width guides do not bend the paper in the input tray.
 - Make sure the input tray is not overloaded with paper.
 - Make sure the pieces of the loaded paper are not sticking together.
 - Use HP paper for optimum performance and efficiency.
 - Clean the paper rollers.

To clean the paper rollers manually

1. Gather the following materials:
 - A long, lint-free cotton swab
 - Distilled, filtered, or bottled water (tap water might damage the printer)
2. Press the Power button  to turn off the printer.
3. Disconnect the power cord from the rear of the printer.
4. Disconnect any other cable from the printer.
5. Remove the input tray.

6. Remove the output tray.

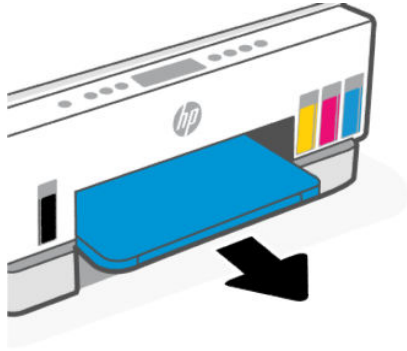

7. Look inside the gap where the trays were and find the gray paper pick rollers. You might need a flashlight to illuminate the area.
8. Dampen a long cotton swab with bottled or distilled water, and then squeeze any excess water from the cloth.
9. Press the swab against the rollers, and then rotate them away from you with your fingers. Apply a moderate amount of pressure to remove dust or dirt buildup.
10. Allow the rollers to dry for 10 or 15 minutes.
11. Reinsert the output tray and the input tray.

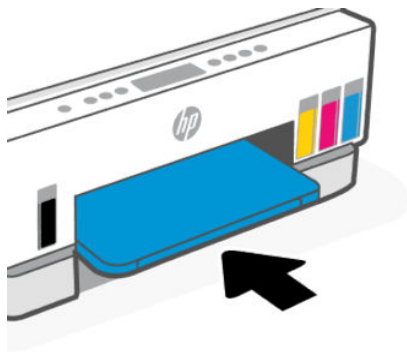

12. Reconnect the power cord to the rear of the printer.
13. Reconnect any other cable to the printer if necessary.
14. Press the Power button to turn on the printer.

Printhead problem

This topic helps you troubleshoot printhead problems.

1. Verify that the indicated printhead is correctly installed.
2. Clean the printhead contacts.

3. Contact HP support for assistance. Go to hp.com/support.

To verify the printheads are installed properly

 **NOTE:**

- The instructions here are only applicable in this section. After you have set up the printer, do not open the printhead cover unless instructed to do so.
- Handle printheads with care. Do not drop the printheads, and do not touch the electric contacts or print nozzles on any surface.

1. Make sure the printer is turned on.
2. Lift the ink access door. Wait for the print carriage to move to the center and stop.

 **NOTE:** After you have set up the printer, do not open the printhead cover unless instructed to do so.

3. Remove and reinsert the printhead.
 - a. Press the blue button to open the printhead cover.
 - b. Remove the printhead from the carriage.

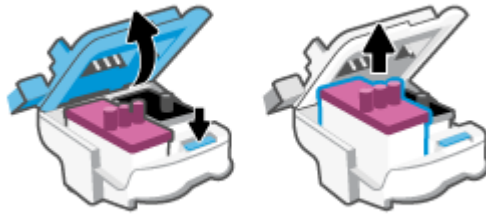

- c. If you find any orange cap or tape on the printhead, remove it.

 **CAUTION:** Do not touch the electric contacts or print nozzles.

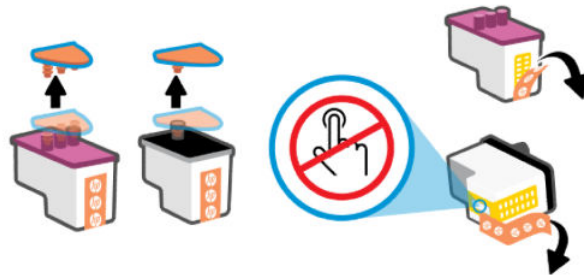

- d. Insert the printhead into the slot until it clicks into place.

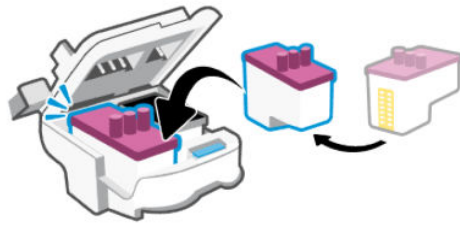

- e. Close the printhead cover.

Make sure it is properly closed to avoid problems such as carriage jams.

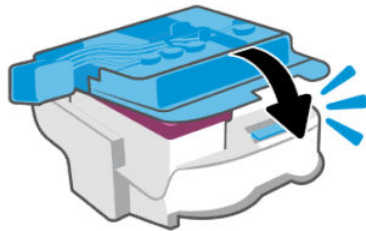

4. Close the ink access door.

To clean printhead contacts

 **NOTE:**

- Open the printhead cover and clean printhead contacts only when necessary; for example, if a printhead cannot be detected.

The instructions here are only applicable in this section. After you have set up the printer, do not open the printhead cover unless instructed to do so.

- The cleaning procedure should take only a few minutes. Make sure that the printheads are reinstalled in the printer as soon as possible. It is not recommended to leave the printheads outside of the printer longer than 30 minutes. This could result in damage to the printheads.
- Handle printheads with care. Do not drop the printheads, and do not touch the electric contacts or print nozzles on any surface.

1. Make sure the printer is turned on.

2. Lift the ink access door.

 **NOTE:** After you have set up the printer, do not open the printhead cover unless instructed to do so.

3. Press the blue button to open the printhead cover.

4. Remove the printhead indicated in the error message.

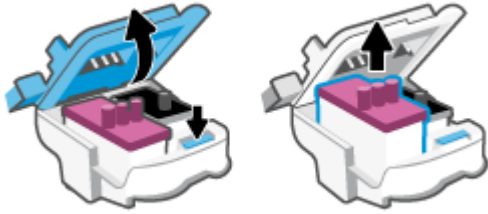

5. Clean the printhead contacts and printer contacts.

- a. Hold the printhead by its sides and locate the electrical contacts on the printhead.
The electrical contacts are the small gold-colored dots on the printhead.

 **NOTE:** Do not touch the electric contacts or print nozzles.



- b. Wipe only the contacts with a dry swab or lint-free cloth.

 **NOTE:** Be careful to wipe only the contacts, do not smear any ink or other debris on the contacts.

- c. On the inside of the printer, locate the contacts for the printhead.

The printer contacts are the set of gold-colored bumps positioned to meet the contacts on the printhead.

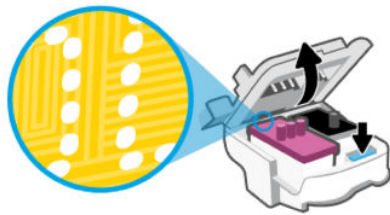

- d. Use a dry swab or lint-free cloth to wipe the contacts.

 **NOTE:** Be careful to wipe only the contacts, do not smear any ink or other debris on the contacts.

6. Insert the printhead into the slot until it clicks into place.

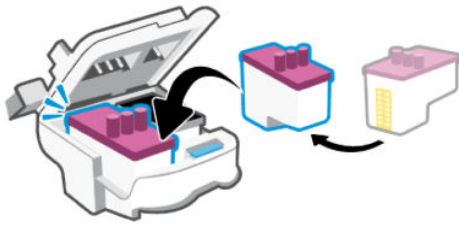

7. Close the printhead cover.

Make sure it is properly closed to avoid problems such as carriage jams.

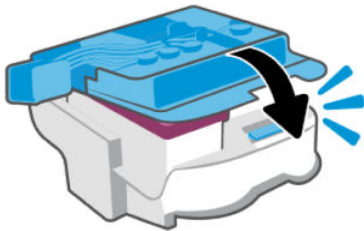

8. Close the ink access door.
9. Check if the error message has gone away.

If you still receive the error message, turn the printer off, and then on.

Printing issues

This topic helps you troubleshoot printing issues.

- Use the [HP Print and Scan Doctor](#) to help diagnose and fix issues automatically.

 **NOTE:** This tool is for the Windows operating system, and is only available in some languages.

- To avoid print quality problems, always turn the printer off using the Power button, and wait until the Power button light goes out before you pull the plug or turn off a power strip. This allows the printer to move the printheads to a capped position, where they are protected from drying out.

To improve print quality, see [Improve print quality](#).

To resolve print issues (Windows)

Make sure that the printer is turned on and that there is paper in the input tray. If you are still unable to print, try the following in order:

1. Check for error messages from the printer software and resolve them by following the on-screen instructions.
2. If your computer is connected to the printer with a USB cable, disconnect and reconnect the USB cable.

If your computer is connected to the printer with a wireless connection, confirm that the connection is working.

3. Verify that the printer is not paused or offline.

To verify that the printer is not paused or offline

- a. Depending on your operating system, do one of the following:
 - **Windows 10:** From the Windows **Start** menu, select **Windows System** from the app list, select **Control Panel**, and then click **View devices and printers** under **Hardware and Sound**.
 - **Windows 7:** From the Windows **Start** menu, click **Devices and Printers**.
 - b. Either double-click or right-click the icon for your printer and select **See what's printing** to open the print queue.
 - c. On the **Printer** menu, make sure there are no check marks next to **Pause Printing** or **Use Printer Offline**.
 - d. If you made any changes, try to print again.
4. Verify that the printer is set as the default printer.

To verify that the printer is set as the default printer.

- a. Depending on your operating system, do one of the following:
 - **Windows 10:** From the Windows **Start** menu, select **Windows System** from the app list, select **Control Panel**, and then click **View devices and printers** under **Hardware and Sound**.
 - **Windows 7:** From the Windows **Start** menu, click **Devices and Printers**.
 - b. Make sure the correct printer is set as the default printer.
The default printer has a check mark in a black or green circle next to it.
 - c. If the wrong printer is set as the default printer, right-click the correct printer and select **Set as Default Printer**.
 - d. Try using your printer again.
5. Restart the print spooler.

To restart the print spooler

- a. Depending on your operating system, do one of the following:
 - **Windows 10:** From the Windows **Start** menu, click **Windows System**, and then click **Control Panel**.
 - **Windows 7:** From the Windows **Start** menu, click **Control Panel**.
- b. Click **System and Security**, and then click **Administrative Tools**.
- c. Double-click **Services**.
- d. Right-click the **Print Spooler**, and then click **Properties**.
- e. On the **General** tab, make sure **Automatic** is selected from the **Startup type** drop-down list.
- f. Under **Service status**, check the status.
 - If the service is not running, click **Start**.

- If the service is running, click **Stop**, and then click **Start** to restart the service.

Then click **OK**.

6. Restart the computer.

7. Clear the print queue.

To clear the print queue

- a. Depending on your operating system, do one of the following:
 - **Windows 10:** From the Windows **Start** menu, click **Windows System**, and then click **Control Panel**. Under **Hardware and Sound**, click **View devices and printers**.
 - **Windows 7:** From the Windows **Start** menu, click **Devices and Printers**.
- b. Right-click the printer, and then select the option to see what is printing.
- c. On the **Printer** menu, click **Cancel all documents** or **Purge Print Document**, and then click **Yes** to confirm.
- d. If there are still documents in the queue, restart the computer and try printing again after the computer has restarted.
- e. Check the print queue again to make sure it is clear, and then try to print again.

To resolve print issues (macOS)

1. Check for error messages and resolve.
2. Disconnect and reconnect the USB cable.
3. Verify that the product is not paused or offline.
 - a. In **System Preferences**, click **Printers & Scanners**.
 - b. Click the **Open Print Queue** button.
 - c. Click a print job to select it.

Use the following buttons to manage the print job:

- **Delete:** Cancel the selected print job.
 - **Hold:** Pause the selected print job.
 - **Resume:** Continue a paused print job.
 - **Pause Printer:** Pause all print jobs in the print queue.
- d. If you made any changes, try to print again.
4. Restart the computer.

Copy and scan issues

This topic helps you troubleshoot copy and scan issues.

- See [Tips for successful scanning and copying](#).

- Use the [HP Print and Scan Doctor](#) to help diagnose and fix issues automatically.



NOTE: This tool is for the Windows operating system, and is only available in some languages.

Network and connection issues

This topic helps you troubleshoot network and connection issues.

Fix network connection issues

Choose one of the following troubleshooting options:

- Restore network settings and reconnect the printer. See [Restore original factory defaults and settings](#).
- Print and check the wireless network test report and network configuration page to assist in diagnosing network connection issues. See [Print reports from the printer control panel](#).
- Ensure that firewalls and security software (including anti-virus, anti-spyware programs) are not affecting the printer connection to your network.

For more information, visit www.hpSMART.com/wireless-printing.

- Use the [HP Print and Scan Doctor](#) (Windows only) to help diagnose and automatically fix network connection issues.

You can also use this tool to find network settings, such as the network name (SSID) and password (network key).

Fix Wi-Fi Direct connection issues

1. See [Print without connecting to same Wi-Fi network \(Wi-Fi Direct\)](#).
2. Make sure that the Wi-Fi Direct icon on the printer display is on. See [To turn Wi-Fi Direct on or off](#).
3. From your wireless computer or mobile device, turn on the wireless (Wi-Fi) connection, and then search for and connect to the Wi-Fi Direct name of your printer.
4. Enter the Wi-Fi Direct password when prompted.
5. If you are using a mobile device, make sure you have installed a compatible printing app. For more information about mobile printing, visit www.hp.com/go/mobileprinting.

Fix Ethernet connection issues (some printer models)

This topic describes how to solve Ethernet connection problems.

Check the following:

- The network is operational and the network hub, switch, or router is turned on.
- The Ethernet cable is properly connected between the printer and the router. The Ethernet cable is plugged into the Ethernet port on the printer and the light near the connector lights up when connected.
- Ensure that firewalls and security software (including anti-virus, anti-spyware programs) are not affecting the printer connection to your network.

For more information, visit www.hpSMART.com/wireless-printing.



- Use the [HP Print and Scan Doctor](#) (Windows only) to help diagnose and automatically fix connection issues.

Restore original factory defaults and settings



This topic describes how to restore original factory defaults and settings.

- If you have made changes to the printer or network settings, you can restore the printer to the original factory settings or network settings.
- If more than 2 hours have passed since you first turned on the printer and you have not set up the printer wirelessly, place the printer in Wi-Fi setup mode by restoring the printer network settings. The setup mode will last for 2 hours.
- You can also troubleshoot network connection issues by restoring the printer network settings.
- If you restore the printer network settings, you will need to reconnect the printer to the network using the HP Smart app. See [Connect your printer to a Wi-Fi network using HP Smart](#).

To restore printer factory defaults from the printer control panel

1. Press and hold the Information button  for 5 seconds until the control panel buttons light up.
2. Lift the ink access door.
3. Press the Information button  and the Cancel button  at the same time for at least 3 seconds.

To restore the printer network settings from the printer control panel

1. Press and hold the Information button  for 5 seconds until the control panel buttons light up.
2. Press the Wi-Fi button  and the Cancel button  at the same time for 5 seconds until the Wi-Fi light blinks blue.

In Wi-Fi setup mode, the Wi-Fi light blinks blue, the Wi-Fi signal bars cycle, and the Wi-Fi alert icon is off. See [Wi-Fi status, light, and icons](#).

To restore the printer factory settings or network settings from the embedded web server (EWS)

1. Open EWS. See [To access and use EWS](#).
2. Click the **Settings** tab.
3. Click **Restore Defaults**, and select the option to restore the factory default settings or network settings.
4. Click the button on the selected page to continue.

Solve Web Services problems

If you are having problems using Web Services, check the following:

- Make sure the printer is connected to the Internet using a supported network connection.
- Make sure the latest product updates have been installed on the printer.
- Make sure Web Services is enabled on the printer. See [Use Web Services](#).
- Make sure the network hub, switch, or router is turned on and working correctly.
- If you are connecting the printer using a wireless connection, make sure the Wi-Fi network is functioning properly. For more information, see [Network and connection issues](#).
- If your network uses proxy settings when connecting to the Internet, make sure the proxy settings you are entering are valid:
 - Check the settings being used by the web browser you are using (such as Internet Explorer, Firefox, or Safari).
 - Check with the IT administrator or person who set up your firewall.

If the proxy settings used by your firewall have changed, you must update these settings in either the printer control panel or the embedded web server (EWS). If these settings are not updated, you will not be able to use Web Services.

For more information, see [Use Web Services](#).

Printer hardware issues

This topic helps you troubleshoot printer hardware issues.

Close all covers and doors

- Make sure the tank covers, printhead cover, and ink access door are properly closed.

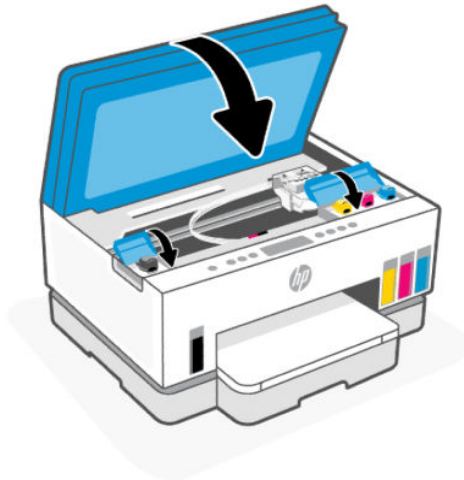

The printer shuts down unexpectedly

- Check the power and power connections.

- Make sure the printer's power cord is connected firmly to a functioning power outlet.

 **NOTE:** When Auto-Off is enabled, the printer will automatically turn off after 2 hours of inactivity to help reduce energy use. For more information, see [Auto-Off](#).

Resolve printer failure

- Turn the printer off, then on. If that does not resolve the problem, contact HP.

Maintain the printer

This topic describes how to maintain the printer.

Clean the scanner glass

Dust or dirt on the scanner glass, scanner lid backing, or scanner frame can slow down performance, degrade the quality of scans, and affect the accuracy of special features such as fitting copies to a certain page size.

To clean the scanner glass

 **WARNING!** Before cleaning the printer, turn the printer off by pressing the Power button , and unplug the power cord from the electrical socket.

1. Lift the scanner lid.



2. Clean the scanner glass and lid backing by using a dry and soft, lint-free cloth. Spray the cloth with a mild glass cleaner and clean **only** the glass.



⚠ CAUTION:

- Do not clean the scanner lid backing with anything wet to avoid damaging the protection layer.
 - Use only glass cleaner to clean the scanner glass. Avoid cleaners that contain abrasives, acetone, benzene, and carbon tetrachloride, all of which can damage the scanner glass. Avoid isopropyl alcohol because it can leave streaks on the scanner glass.
 - Do not spray the glass cleaner directly on the scanner glass. If too much glass cleaner is applied, the cleaner could leak under the scanner glass and damage the scanner.
-

3. Close the scanner lid, and turn on the printer.

Clean the document feeder glass area (some printer models)

If paper jams keep occurring when using the document feeder, and other means to avoid document feeder jams do not help, try cleaning the document feeder glass area using a dry, lint-free cloth.

1. Lift the scanner lid.
2. Using a dry and soft, lint-free cloth, clean the document feeder glass and the indicated area on the scanner lid.

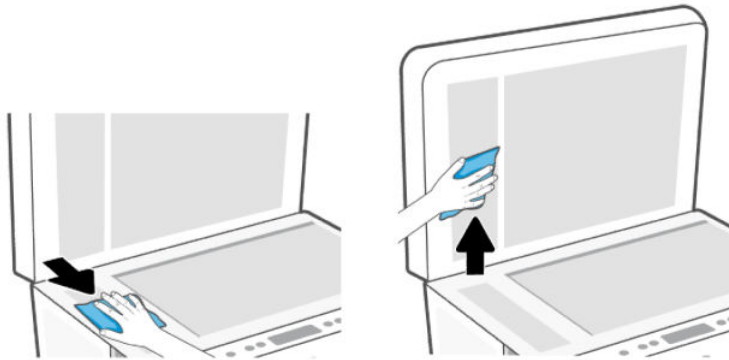

Clean the exterior

-
- ⚠ WARNING!** Before cleaning the printer, turn the printer off by pressing the power button the Power button , and unplugging the power cord from the electrical socket.
-

Use a soft, damp, lint-free cloth to wipe dust, smudges, and stains off of the case. Keep fluids away from the interior of the printer, as well as from the printer control panel.

Clean the document feeder (some printer models)

If the document feeder picks up multiple pages or if it does not pick up plain paper, you can clean the rollers and separator pad.

-
- 📝 NOTE:** If you encounter paper jams or poor outcome when copying or scanning using the document feeder, you might need to clean the document feeder glass (some printer models), see [Clean the document feeder glass area \(some printer models\)](#).
-

To clean the rollers or separator pad

⚠ WARNING! Before cleaning the printer, turn the printer off by pressing the Power button , and unplug the power cord from the electrical socket.

1. Remove all originals from the document feeder input tray.
2. Open the document feeder cover.

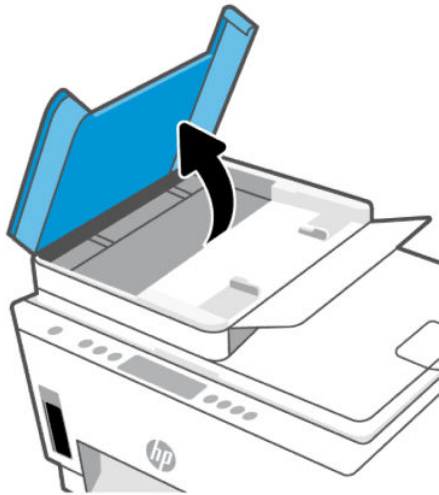

This provides easy access to the rollers (1) and separator pad (2).

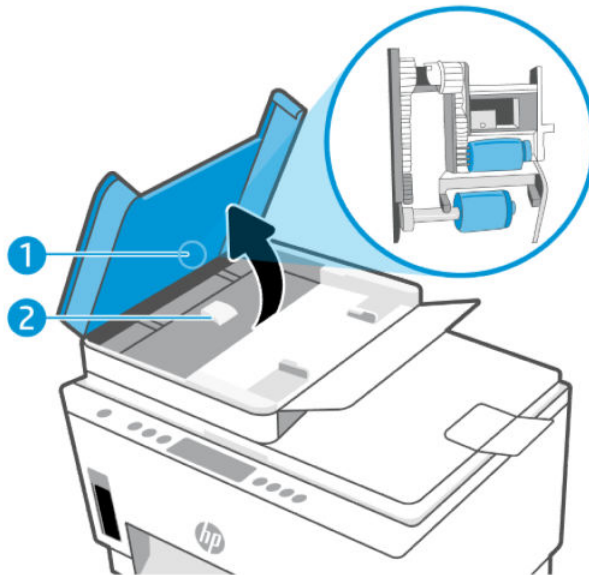

Table 8-1 Rollers and separators

Feature	Description
1	Rollers
2	Separator pad

3. Lightly dampen a clean lint-free cloth with distilled water, then squeeze any excess liquid from the cloth.
4. Use the damp cloth to wipe any residue off the rollers or separator pad.



NOTE: If the residue does not come off using distilled water, try using isopropyl (rubbing) alcohol.

5. Close the document feeder cover.

HP support

HP online support provides a variety of options for help with your printer. For the latest product updates and support information, visit hp.com/support.



NOTE: You can also use the HP Smart app to check printer errors and get troubleshooting assistance. For information about this app, see [Use the HP Smart app to print, scan, and manage](#).

Contact HP

If you need help from an HP technical support representative to solve a problem, visit the [Contact Support website](#). The following contact options are available at no cost for in-warranty customers (HP agent-assisted support for out-of-warranty customers may require a fee):

- Chat with an HP support agent online.
- Call an HP support agent.

When contacting HP support, be prepared to provide the following information:

- Product name (located on the printer)
- Product number and serial number (on a label in the ink access area)

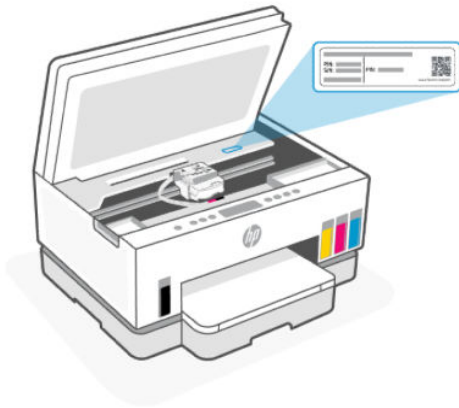

Register printer

By taking just a few quick minutes to register, you can enjoy quicker service, more efficient support, and product support alerts.

If you did not register your printer while installing the software, you can register now at register.hp.com.

Additional warranty options

Extended service plans are available for the printer at additional costs. Go to hp.com/support, select your country/region and language, then explore the extended warranty options available for your printer.

9 HP EcoSolutions (HP and the Environment)

For more detailed information about environmental guidelines that HP follows during the manufacturing process, see [Environmental product stewardship program](#). For more information about HP's environmental initiatives, visit [HP EcoSolutions](#).

Power Management

Learn how to reduce the power or energy use of the printer.



NOTE: Configuring longer times for these settings or turning off these features will increase energy consumption.

Sleep mode

- Power usage is reduced while in Sleep mode.
- After initial setup of printer, the printer will enter Sleep mode after 5 minutes of inactivity.
- You can change the time the printer goes to sleep after a period of inactivity.
- The Power button light is dimmed and the printer control panel display is off in Sleep mode.
- To wake the printer from sleep, touch anywhere on the printer control panel.

Auto-Off

This feature turns the printer off after 2 hours of inactivity to help reduce energy use. Auto-Off turns the printer off completely, so you must use the Power button to turn the printer back on.

If your printer supports this energy saving feature, Auto-Off is automatically enabled or disabled depending on printer capabilities and connection options. Even when Auto-Off is disabled, the printer enters Sleep mode after 5 minutes of inactivity to help reduce energy use.

- Auto-Off is enabled when the printer is turned on, if the printer does not have network, fax or Wi-Fi Direct capability, or is not using these capabilities.
- Auto-Off is disabled when a printer's Wi-Fi or Wi-Fi Direct capability is turned on or when a printer with fax, USB, or Ethernet network capability establishes a fax, USB, or Ethernet network connection.



TIP: To conserve battery power, you can enable Auto-Off, even when the printer is connected or Wi-Fi is turned on.

To change the time for Sleep mode and Auto-Off from the embedded web server (EWS)

1. Open EWS. See [To access and use EWS](#).
2. Click the **Settings** tab.
3. From the left menu, click **Power Management**.
4. Click **Energy Save Mode** or **Auto-Off**.

5. Select the desired time, and then click **Apply**.

Schedule On and Off

Use this feature to automatically turn the printer on or off on selected days. For example, you can schedule the printer to turn on at 8 a.m. and turn off at 8 p.m. from Monday to Friday. In this way, you save energy during the night and weekends.

To schedule the days and time to turn the printer on or off

1. Open EWS. See [To access and use EWS](#).
2. Click the **Settings** tab.
3. From the left menu, click **Power Management**.
4. Click **Schedule On/Off**, and specify the desired time and days to automatically turn on or off the printer.
5. Click **Apply**.

Quiet Mode

Quiet Mode slows down printing to reduce overall noise without affecting print quality. Quiet Mode only works when printing on plain paper with normal print quality.

To reduce printing noise, turn on Quiet Mode. To print at normal speed, turn Quiet Mode off. Quiet Mode is off by default.



NOTE:

- You can specify the time to automatically turn on the feature.
 - To change the setting from HP Smart, open HP Smart on your device, select your printer, and then click **Printer Settings**.
-

To turn Quiet mode on or off or change the settings from the embedded web server (EWS)

1. Open EWS. See [To access and use EWS](#).
2. Click the **Settings** tab.
3. From the left menu, click **Preferences**.
4. Click **Quiet Mode** and make the necessary changes.
5. Click **Apply**.

A Technical information

The information contained herein is subject to change without notice. Some statements might not be applicable for your printer or all countries/regions.

Specifications

For more information about the product specifications (including acoustic information, print resolutions, system requirements), visit hp.com/support.

Environmental specifications

- Recommended operating temperature range: 15°C to 30°C (59°F to 86°F)
- Recommended and operating humidity range: 20% to 80% relative humidity (RH), non-condensing
- Operating temperature range: 5°C to 40°C (41°F to 104°F)
- Non-operating (storage) temperature range: -40°C to 60°C (-40°F to 140°F)
- In the presence of high electromagnetic fields, it is possible the output from the printer may be slightly distorted
- HP recommends using a USB cable less than or equal to 3 m (10 feet) in length to minimize injected noise due to potential high electromagnetic fields

Input tray capacity (HP Smart Tank 6000 series)

- Plain paper sheets (75 g/m² [20lb]): Up to 150
- Envelopes: Up to 10
- Photo paper sheets: Up to 30

Input tray capacity (HP Smart Tank 7000, 7300 series)

- Plain paper sheets (75 g/m² [20lb]): Up to 250
- Envelopes: Up to 30
- Index cards: Up to 50
- Photo paper sheets: Up to 50

Output tray capacity

- Plain paper sheets (75 g/m² [20lb]): Up to 100
- Envelopes: Up to 30
- Index cards: Up to 30 (HP Smart Tank 7000, 7300 series)

- Photo paper sheets: Up to 30

Document feeder capacity (HP Smart Tank 7300 series)

- Plain paper sheets (60 to 90 g/m² [16 to 24 lb]): Up to 35

Paper type and size

- For a complete list of supported media, refer to the printer software or the embedded web server (EWS). To open EWS, see [To access and use EWS](#).

Paper weights

- Plain Paper: 60 to 105 g/m² (16 to 28 lb)
- Envelopes: 75 to 90 g/m² (20 to 24 lb)
- Cards: Up to 200 g/m² (110 lb) (HP Smart Tank 7000, 7300 series)
- Photo Paper: Up to 250 g/m² (66 lb)

Print specifications

- Print speeds vary according to the complexity of the document
- Method: drop-on-demand thermal inkjet
- Language: PCL3 GUI
- For the print resolutions and margins, visit the product support website for details.

Copy specifications

- Resolution: up to 600 dpi
- Digital image processing
- Copy speeds vary according to the complexity of the document and model

Scan specifications

- Resolution: up to 1200 x 1200 ppi optical
For more information about ppi resolution, see the scanner software.
- Color: 24-bit color, 8-bit grayscale (256 levels of gray)
- Maximum scan size from glass: 21.6 x 29.7 cm (8.5 x 11.7 inches)

Power specifications

- Input voltage: 100-240 Vac (+/- 10%)
- Input frequency: 50/60 Hz (+/- 3 Hz)

Regulatory notices

The printer meets product requirements from regulatory agencies in your country/region.

Regulatory Model Number

For regulatory identification purposes, your product is assigned with a Regulatory Model Number. The regulatory model number should not be confused with the marketing names or product numbers.

FCC statement

The United States Federal Communications Commission (in 47 CFR 15.105) has specified that the following notice be brought to the attention of users of this product.

This equipment has been tested and found to comply with the limits for a Class B digital device, pursuant to Part 15 of the FCC Rules. These limits are designed to provide reasonable protection against harmful interference in a residential installation. This equipment generates, uses and can radiate radio frequency energy and, if not installed and used in accordance with the instructions, may cause harmful interference to radio communications. However, there is no guarantee that interference will not occur in a particular installation. If this equipment does cause harmful interference to radio or television reception, which can be determined by turning the equipment off and on, the user is encouraged to try to correct the interference by one or more of the following measures:

- Reorient or relocate the receiving antenna.
- Increase the separation between the equipment and the receiver.
- Connect the equipment into an outlet on a circuit different from that to which the receiver is connected.
- Consult the dealer or an experienced radio/TV technician for help.



NOTE: If the product has an Ethernet / LAN port with metallic casing then use of a shielded interface cable is required to comply with the Class B limits of Part 15 of FCC rules.

Modifications (part 15.21)

Any changes or modifications made to this device that are not expressly approved by HP may void the user's authority to operate the equipment.

For further information, contact: Manager of Corporate Product Regulations, HP Inc. 1501 Page Mill Road, Palo Alto, CA 94304, U.S.A.

This device complies with Part 15 of the FCC Rules. Operation is subject to the following two conditions: (1) this device may not cause harmful interference, and (2) this device must accept any interference received, including interference that may cause undesired operation.

Power cord instructions

Make sure your power source is adequate for the product voltage rating. The voltage rating is on the product. The product uses either 100-240 Vac (+/- 10%) or 200-240 Vac and 50/60 Hz (+/- 3 Hz).



CAUTION: To prevent damage to the product, use only the power cord that is provided with the product.

VCCI (Class B) compliance statement for users in Japan

この装置は、クラスB機器です。この装置は、住宅環境で使用することを目的としていますが、この装置がラジオやテレビジョン受信機に近接して使用されると、受信障害を引き起こすことがあります。
取扱説明書に従って正しい取り扱いをして下さい。 VCCI - B

Notice to users in Japan about the power cord

製品には、同梱された電源コードをお使い下さい。

同梱された電源コードは、他の製品では使用出来ません。

Visual display workplaces statement for Germany

GS-Erklärung (Deutschland)

Das Gerät ist nicht für die Benutzung im unmittelbaren Gesichtsfeld am Bildschirmarbeitsplatz vorgesehen. Um störende Reflexionen am Bildschirmarbeitsplatz zu vermeiden, darf dieses Produkt nicht im unmittelbaren Gesichtsfeld platziert werden.

Noise emission statement for Germany

Geräuschemission

LpA < 70 dB am Arbeitsplatz im Normalbetrieb nach DIN 45635 T. 19

European Union and United Kingdom Regulatory Notice



Products bearing the CE marking and UK marking comply to applicable EU Directives and the equivalent UK Statutory Instruments and can operate in at least one EU Member State and in Great Britain. The full EU and UK Declaration of Conformity can be found at the following website: hp.eu/certificates (Search with the product model name or its Regulatory Model Number (RMN), which may be found on the regulatory label.)

The point of contact for regulatory matters:

For EU: HP Deutschland GmbH, HP HQ-TRE, 71025 Boeblingen, Germany

For GB: HP Inc UK Ltd, Regulatory Enquiries, Earley West, 300 Thames Valley Park Drive, Reading, RG6 1PT

Email: techregshelp@hp.com

Declaration of conformity

Declaration of conformity can be found at www.hp.eu/certificates.

Regulatory wireless statements

This section contains regulatory information pertaining to wireless products.

Products with wireless functionality

EMF

This product meets international guidelines (ICNIRP) for exposure to radio frequency radiation.

If it incorporates a radio transmitting and receiving device that in normal use, a separation distance of 20 cm ensures that radio frequency exposure levels comply with EU requirements.

Wireless functionality in Europe

For products with 802.11 b/g/n or Bluetooth radio:

- Radio frequency band: 2400-2483.5 MHz, with transmit power of 20 dBm (100 mW) or less.

For products with 802.11 a/b/g/n/ac radio:

- Radio frequency band: 2400-2483.5 MHz, with transmit power of 20 dBm (100 mW) or less.
- Radio frequency band: 5170-5330 MHz, with transmit power of 23 dBm (200 mW) or less.
- Radio frequency band: 5490-5730 MHz, with transmit power of 23 dBm (200 mW) or less.
- Radio frequency band: 5735-5835 MHz, with transmit power of 13.98 dBm (25 mW) or less.



AT	BE	BG	CY	CZ
DE	DK	EE	EL	ES
FI	FR	HR	HU	IE
IT	LT	LU	LV	MT
NL	PL	PT	RO	SE
SI	SK	IS	LI	NO
CH	TR	UK(NI)		

AL	BA	MD	ME	MK
RS	UK	XK		

 **IMPORTANT:** IEEE 802.11x wireless LAN with 5.17-5.33 GHz frequency band is restricted for **indoor use only** in all countries reflected in the matrix. Using this WLAN application outdoor might lead to interference issues with existing radio services.

Exposure to radio frequency radiation

 **CAUTION:** The radiated output power of this device is far below the FCC radio frequency exposure limits. Nevertheless, the device shall be used in such a manner that the potential for human contact during normal operation is minimized. This product and any attached external antenna, if supported, shall be placed in such a manner to minimize the potential for human contact during normal operation. In order to avoid the possibility of exceeding the FCC radio frequency exposure limits, human proximity to the antenna shall not be less than 20 cm (8 inches) during normal operation.

Notice to users in Canada

Under Innovation, Science and Economic Development Canada regulations, this radio transmitter may only operate using an antenna of a type and maximum (or lesser) gain approved for the transmitter by Innovation, Science and Economic Development Canada. To reduce potential radio interference to other users, the antenna type and its gain should be so chosen that the equivalent isotropically radiated power (e.i.r.p.) is not more than that necessary for successful communication.

This device complies with Innovation, Science and Economic Development Canada licence-exempt RSS standard(s). Operation is subject to the following two conditions: (1) this device may not cause interference, and (2) this device must accept any interference, including interference that may cause undesired operation of the device.

WARNING! Exposure to Radio Frequency Radiation. The radiated output power of this device is below the Innovation, Science and Economic Development Canada radio frequency exposure limits. Nevertheless, the device should be used in such a manner that the potential for human contact is minimized during normal operation.

To avoid the possibility of exceeding the Innovation, Science and Economic Development Canada radio frequency exposure limits, human proximity to the antennas should not be less than 20 cm (8 inches).

Conformément au Règlement d'Innovation, Science et Développement Economique Canada, cet émetteur radioélectrique ne peut fonctionner qu'avec une antenne d'un type et d'un gain maximum (ou moindre) approuvé par Innovation, Science et Développement Economique Canada. Afin de réduire le brouillage radioélectrique potentiel pour d'autres utilisateurs, le type d'antenne et son gain doivent être choisis de manière à ce que la puissance isotrope rayonnée équivalente (p.i.r.e.) ne dépasse pas celle nécessaire à une communication réussie.

Cet appareil est conforme aux normes RSS exemptes de licence d'Innovation, Science et Développement Economique Canada. Son fonctionnement dépend des deux conditions suivantes : (1) cet appareil ne doit pas provoquer d'interférences nuisibles et (2) doit accepter toutes les interférences reçues, y compris des interférences pouvant provoquer un fonctionnement non souhaité de l'appareil.

AVERTISSEMENT relatif à l'exposition aux radiofréquences. La puissance de rayonnement de cet appareil se trouve sous les limites d'exposition de radiofréquences d'Innovation, Science et Développement Economique Canada. Néanmoins, cet appareil doit être utilisé de telle sorte qu'il doive être mis en contact le moins possible avec le corps humain.

Afin d'éviter le dépassement éventuel des limites d'exposition aux radiofréquences d'Innovation, Science et Développement Economique Canada, il est recommandé de maintenir une distance de plus de 20 cm entre les antennes et l'utilisateur.

Notice to users in Japan

この機器は技術基準適合証明又は工事設計認証を受けた無線設備を搭載しています。

Notice to users in Taiwan

取得審驗證明之低功率射頻器材，非經核准，公司、商號或使用者均不得擅自變更頻率、加大功率或變更原設計之特性及功能。低功率射頻器材之使用不得影響飛航安全及干擾合法通信；經發現有干擾現象時，應立即停用，並改善至無干擾時方得繼續使用。前述合法通信，指依電信管理法規定作業之無線電通信。低功率射頻器材須忍受合法通信或工業、科學及醫療用電波輻射性電機設備之干擾。

Notice to users in Thailand (Wi-Fi)

เครื่องวิทยุคมนาคมและอุปกรณ์นี้ มีความสอดคล้องตามข้อกำหนดของ กสทช.

radio communication act B.E.2498



Notice to users in Brazil

Este equipamento não tem direito à proteção contra interferência prejudicial e não pode causar interferência em sistemas devidamente autorizados.

Para maiores informações consulte o site da ANATEL www.anatel.gov.br.

Notice to users in Mexico

La operación de este equipo está sujeta a las siguientes dos condiciones: (1) es posible que este equipo o dispositivo no cause interferencia perjudicial y (2) este equipo o dispositivo debe aceptar cualquier interferencia, incluyendo la que pueda causar su operación no deseada.

Para saber el modelo de la tarjeta inalámbrica utilizada, revise la etiqueta regulatoria de la impresora.

Notice to users in Ukraine

Повідомлення для користувачів в Україні

Table A-1 Notice to users in Ukraine

Технологія, що використовується	Радіочастотні діапазони	Максимальна потужність передавання
WLAN Wi-Fi 802.11x (2,4 ГГц)	2400–2483,5 МГц	< 100 мВт (20 дБм) EIBП
Bluetooth (2,4 ГГц)	2400–2483,5 МГц	< 100 мВт (20 дБм) EIBП
Bluetooth з низьким енергоспоживанням (2,4 ГГц)	2400–2483,5 МГц	< 100 мВт (20 дБм) EIBП

Table A-1 Notice to users in Ukraine (continued)

Технологія, що використовується	Радіочастотні діапазони	Максимальна потужність передавання
WLAN Wi-Fi 802.11x (5 ГГц)	5150–5350 МГц	< 100 мВт (20 дБм) EIRP
(Лише для використання в приміщенні)	5470–5835 МГц	

 **NOTE:** Відповідні частотні діапазони та максимальна потужність передавання застосовуються, лише якщо в пристрої використовується зазначена технологія підключення.

Notice to users in Canada (5 GHz)

⚠ CAUTION: When using IEEE 802.11a wireless LAN, this product is restricted to indoor use, due to its operation in the 5.15- to 5.25-GHz frequency range. The Innovation, Science and Economic Development Canada requires this product to be used indoors for the frequency range of 5.15 GHz to 5.25 GHz to reduce the potential for harmful interference to co-channel mobile satellite systems. High-power radar is allocated as the primary user of the 5.25- to 5.35-GHz and 5.65- to 5.85-GHz bands. These radar stations can cause interference with and/or damage to this device.

⚠ ATTENTION: Lors de l'utilisation du réseau local sans fil IEEE 802.11a, ce produit se limite à une utilisation en intérieur à cause de son fonctionnement sur la plage de fréquences de 5,15 à 5,25 GHz. Innovation, Science et Développement Economique Canada stipule que ce produit doit être utilisé en intérieur dans la plage de fréquences de 5,15 à 5,25 GHz afin de réduire le risque d'interférences éventuellement dangereuses avec les systèmes mobiles par satellite via un canal adjacent. Le radar à haute puissance est alloué pour une utilisation principale dans une plage de fréquences de 5,25 à 5,35 GHz et de 5,65 à 5,85 GHz. Ces stations radar peuvent provoquer des interférences avec cet appareil et l'endommager.

Notice to users in Taiwan (5 GHz)

應避免影響附近雷達系統之操作。

高增益指向性天線只得應用於固定式點對點系統。

Notice to users in Thailand (5 GHz)

เครื่องวิทยุคมนาคมนี้มีระดับการแผ่คลื่นแม่เหล็กไฟฟ้าสอดคล้องตามมาตรฐานความปลอดภัยต่อสุขภาพของมนุษย์จากการใช้เครื่องวิทยุคมนาคมที่คณะกรรมการกิจการโทรคมนาคมแห่งชาติประกาศกำหนด

Notice to users in Serbia (5 GHz)

Upotreba ovog uredjaja je ogranicna na zatvorene prostore u slucajevima koriscenja na frekvencijama od 5150-5350 MHz.

Accessibility

Learn more about our efforts to create accessible products, share your story, or connect with customer support for accessibility help—all at hp.com/accessibility.

For more information about the accessibility of your printer, please visit [Accessibility for HP inkjet printers](#).

Environmental product stewardship program

HP is committed to providing quality products in an environmentally sound manner. Design for recycling has been incorporated into this product. The number of materials has been kept to a minimum while ensuring

proper functionality and reliability. Dissimilar materials have been designed to separate easily. Fasteners and other connections are easy to locate, access, and remove using common tools. High priority parts have been designed to access quickly for efficient disassembly and repair. For more information, visit HP's Commitment to the Environment website at:

hp.com/sustainableimpact

HP tips for reducing environmental impact

- Choose from a wide variety of HP papers with FSC® or PEFC™ certification, which indicates that the paper pulp came from a reputable and well-managed source.¹
- Conserve resources-look for paper made with recycled content.
- Recycle your Original HP cartridges-it's easy and free with the HP Planet Partners program, available in 47 countries and territories worldwide.²
- Save paper by printing on both sides of the page.
- Conserve energy by choosing ENERGY STAR® certified HP products.
- Lower your carbon footprint-all HP printers include power management settings that help you control energy use.
- Discover more ways HP and our customers are reducing environmental impact at [HP EcoSolutions](#).

¹ HP papers certified under FSC®C017543 or PEFC™TMPEFC/29-13-198.

² Program availability varies. Original HP cartridge return and recycling is currently available in more than 50 countries, territories, and regions in Asia, Europe, and North and South America through the HP Planet Partners program. For more information, visit: hp.com/recycle.

Eco-Tips

HP is committed to helping customers reduce their environmental footprint. Please visit the HP Eco Solutions website for more information on HP's environmental initiatives.

hp.com/sustainableimpact

European Union Commission Regulation 1275/2008

For product power data, including the power consumption of the product in networked standby if all wired network ports are connected and all wireless network ports are activated, please refer to section P15 'Additional Information' of the product IT ECO Declaration at hp.com/hpinfo/globalcitizenship/environment/productdata/itecodesktop-pc.html.

Paper

This product is suited for the use of recycled paper according to DIN 19309 and EN 12281:2002.

Plastics

Plastic parts over 25 grams are marked according to international standards that enhance the ability to identify plastics for recycling purposes at the end of product life.

Safety data sheets

Safety Data Sheets, product safety and environmental information are available at hp.com/go/ecodata or on request.

Recycling program

HP offers an increasing number of product return and recycling programs in many countries/regions, and partners with some of the largest electronic recycling centers throughout the world. HP conserves resources by reselling some of its most popular products. For more information regarding recycling of HP products, please visit: hp.com/recycle

HP inkjet supplies recycling program

HP is committed to protecting the environment. The HP Inkjet Supplies Recycling Program is available in many countries/regions, and lets you recycle used print cartridges and ink cartridges free of charge. For more information, go to the following website: hp.com/recycle

Power consumption

HP printing and imaging equipment marked with the ENERGY STAR® logo is certified by the U.S. Environmental Protection Agency. The following mark will appear on ENERGY STAR certified imaging products:



Additional ENERGY STAR certified imaging product model information is listed at: www.hp.com/go/energystar

Disposal of waste equipment by users



This symbol means do not dispose of your product with your other household waste. Instead, you should protect human health and the environment by handing over your waste equipment to a designated collection point for the recycling of waste electrical and electronic equipment. For more information, please contact your household waste disposal service, or go to hp.com/recycle.

Waste disposal for Brazil



Este produto eletrônico e seus componentes não devem ser descartados no lixo comum, pois embora estejam em conformidade com padrões mundiais de restrição a substâncias nocivas, podem conter, ainda que em quantidades mínimas, substâncias impactantes ao meio ambiente. Ao final da vida útil deste produto, o usuário deverá entregá-lo à HP. A não observância dessa orientação sujeitará o infrator às sanções previstas em lei.

Após o uso, as pilhas e/ou baterias dos produtos HP deverão ser entregues ao estabelecimento comercial ou rede de assistência técnica autorizada pela HP.

Para maiores informações, inclusive sobre os pontos de recebimento, acesse:

hp.com.br/reciclar

Chemical substances

HP is committed to providing our customers with information about the chemical substances in our products as needed to comply with legal requirements such as REACH (*Regulation EC No 1907/2006 of the European Parliament and the Council*). A chemical information report for this product can be found at: hp.com/go/reach.

The Table of Hazardous Substances/Elements and their Content (China)

产品中有害物质或元素的名称及含量

根据中国《电器电子产品有害物质限制使用管理办法》



Table A-2 The Table of Hazardous Substances/Elements and their Content (China)

部件名称	有害物质					
	铅 (Pb)	汞 (Hg)	镉 (Cd)	六价铬 (Cr(VI))	多溴联苯 (PBB)	多溴二苯醚 (PBDE)
外壳和托盘	○	○	○	○	○	○
电线	○	○	○	○	○	○
印刷电路板	X	○	○	○	○	○
打印系统	X	○	○	○	○	○
显示器	X	○	○	○	○	○
喷墨打印机墨盒	○	○	○	○	○	○
驱动光盘	X	○	○	○	○	○
扫描仪	X	○	○	○	○	○
网络配件	X	○	○	○	○	○
电池板	X	○	○	○	○	○
自动双面打印系统	○	○	○	○	○	○
外部电源	X	○	○	○	○	○

本表格依据 SJ/T 11364 的规定编制。

○: 表示该有害物质在该部件所有均质材料中的含量均在 GB/T 26572 规定的限量要求以下。

X: 表示该有害物质至少在该部件的某一均质材料中的含量超出 GB/T 26572 规定的限量要求。

此表中所有名称中含“X”的部件均符合中国 RoHS 达标管理目录限用物质应用例外清单的豁免。

此表中所有名称中含“X”的部件均符合欧盟 RoHS 立法。

注: 环保使用期限的参考标识取决于产品正常工作的温度和湿度等条件。

Declaration of the Presence Condition of the Restricted Substances Marking (Taiwan)

台灣 限用物質含有情況標示聲明書

Taiwan Declaration of the Presence Condition of the Restricted Substances Marking

單元 unit	限用物質及其化學符號 Restricted substances and chemical symbols					
	鉛 (Pb)	汞 (Hg)	鎘 (Cd)	六價鉻 (Cr ⁺⁶)	多溴聯苯 (PBB)	多溴二苯醚 (PBDE)
列印引擎 Print engine	—	○	○	○	○	○
外殼和紙匣 External Casing and Trays	○	○	○	○	○	○
電源供應器 Power Supply	—	○	○	○	○	○
電線 Cables	○	○	○	○	○	○
印刷電路板 Print printed circuit board	—	○	○	○	○	○
控制面板 Control panel	—	○	○	○	○	○
墨水匣 Cartridge	○	○	○	○	○	○
掃描器組件 Scanner assembly	—	○	○	○	○	○
備考 1. “超出 0.1wt%”及“超出 0.01wt%”係指限用物質之百分比含量超出百分比含量基準值。 Note 1: “Exceeding 0.1 wt %” and “exceeding 0.01 wt %” indicate that the percentage content of the restricted substance exceeds the reference percentage value of presence condition. 備考 2. “○”係指該項限用物質之百分比含量未超出百分比含量基準值。 Note 2: “○” indicates that the percentage content of the restricted substance does not exceed the percentage of reference value of presence. 備考 3. “—”係指該項限用物質為排除項目 Note 3: “—” indicates that the restricted substance corresponds to the exemption.						

若要存取產品的最新使用指南或手冊，請前往 hp.com/support。選取**搜尋您的產品**，然後依照 畫面上的指示繼續執行。

To access the latest user guides or manuals for your product, go to hp.com/support. Select **Find your product**, and then follow the on-screen instructions.

Restriction of hazardous substance (India)

This product, as well as its related consumables and spares, complies with the reduction in hazardous substances provisions of the "India E-waste (Management and Handling) Rule 2016." It does not contain lead, mercury, hexavalent chromium, polybrominated biphenyls or polybrominated diphenyl ethers in concentrations exceeding 0.1 weight % and 0.01 weight % for cadmium, except for where allowed pursuant to the exemptions set in Schedule 2 of the Rule.

Restriction on hazardous substances statement (Turkey)

Türkiye Cumhuriyeti: AEEE Yönetmeliğine Uygundur

EPEAT

Most HP products are designed to meet EPEAT. EPEAT is a comprehensive environmental rating that helps identify greener electronics equipment. For more information on EPEAT go to epeat.net.

[Click here for information on HP's EPEAT registered products.](#)

SEPA Ecolabel User Information (China)

中国环境标识认证产品用户说明

噪声大于 63.0 dB(A) 的办公设备不宜放置于办公室内，请在独立的隔离区域使用。

如需长时间使用本产品或打印大量文件，请确保在通风良好的房间内使用。

如您需要确认本产品处于零能耗状态，请按下电源关闭按钮，并将插头从电源插座断开。

您可以使用再生纸，以减少资源耗费。

China Energy Label for Printer, Fax and Copier

复印机、打印机和传真机能源效率标识实施规则

依据“复印机、打印机和传真机能源效率标识实施规则”，该打印机具有中国能效标识。标识上显示的能效等级和操作模式值根据“复印机、打印机和传真机能效限定值及能效等级”标准(“GB 21521”)来确定和计算。

1. 能效等级

产品能效等级分 3 级，其中 1 级能效最高。能效限定值根据产品类型和打印速度由标准确定。能效等级则根据基本功耗水平以及网络接口和内存等附加组件和功能的功率因子之和来计算。

2. 能效信息

喷墨打印机

- 操作模式功率

睡眠状态的能耗按照 GB 21521 的标准来衡量和计算。该数据以瓦特 (W) 表示。

- 待机功率

待机状态是产品连接到电网电源上功率最低的状态。该状态可以延续无限长时间，且使用者无法改变此状态下产品的功率。对于“成像设备”产品，“待机”状态通常相当于“关闭”状态，但也可能相当于“准备”状态或者“睡眠”状态。该数据以瓦特 (W) 表示。

- 睡眠状态预设延迟时间

出厂前由制造商设置的时间决定了该产品在完成主功能后进入低耗模式(例如睡眠、自动关机)的时间。该数据以分钟表示。

- 附加功能功率因子之和

网络接口和内存等附加功能的功率因子之和。该数据以瓦特 (W) 表示。

标识上显示的能耗数据是根据典型配置测量得出的数据，此类配置包含登记备案的打印机依据复印机、打印机和传真机能源效率标识实施规则所选的所有配置。因此，该特定产品型号的实际能耗可能与标识上显示的数据有所不同。

要了解规范的更多详情，请参考最新版的 GB 21521 标准。

Battery disposal in Taiwan



廢電池請回收

European Union Battery Directive



This product contains a battery that is used to maintain data integrity of real time clock or product settings and is designed to last the life of the product. Any attempt to service or replace this battery should be performed by a qualified service technician.

Battery notice for Brazil

A bateria deste equipamento nao foi projetada para ser removida pelo cliente.

California Perchlorate Material Notice

Perchlorate material - special handling may apply. See: dtsc.ca.gov/hazardouswaste/perchlorate

This product's real-time clock battery or coin cell battery may contain perchlorate and may require special handling when recycled or disposed of in California.