

BRIO 500

Setup Guide
设置指南

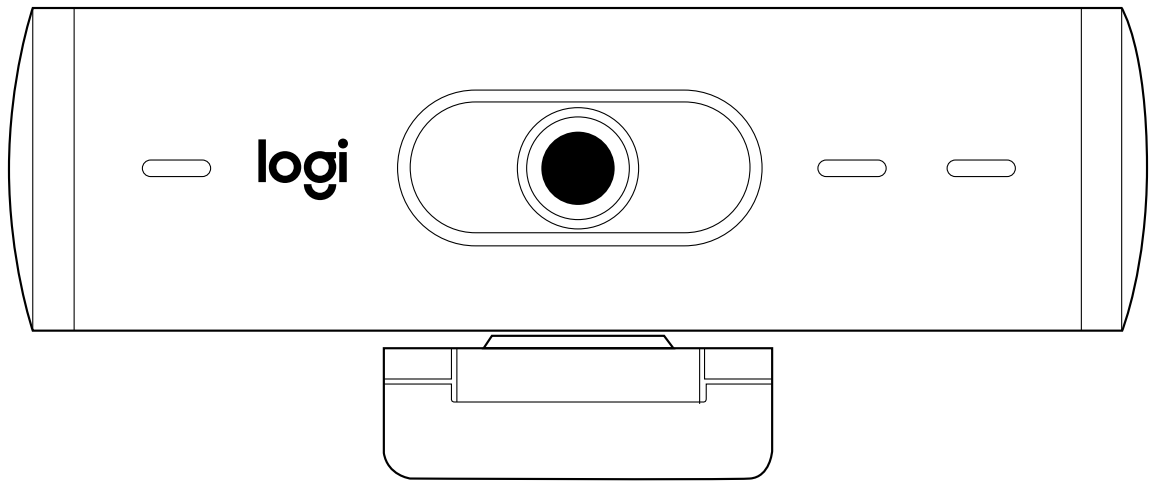

CONTENTS

English 3

简体中文 11

繁體中文 19

한국어 27

Indonesia 35

KNOW YOUR PRODUCT

BRIO 500 FRONT VIEW WITH FUNCTION INDICATIONS

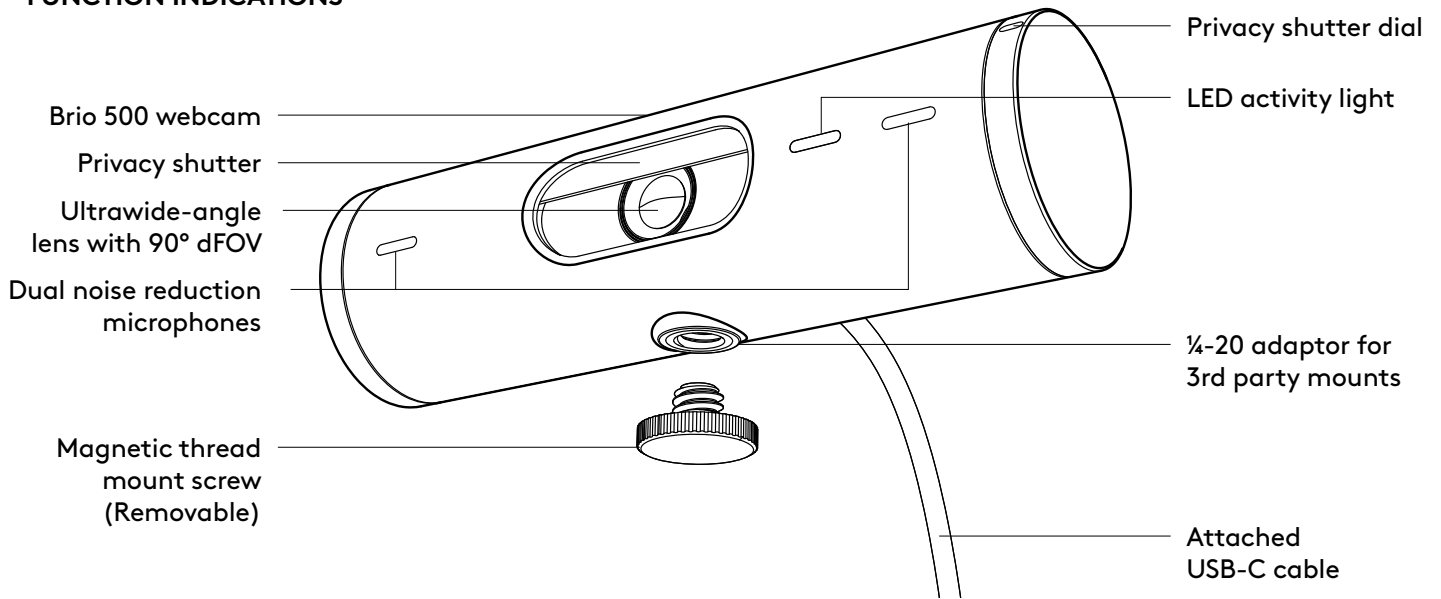

MOUNT DESIGN OVERVIEW

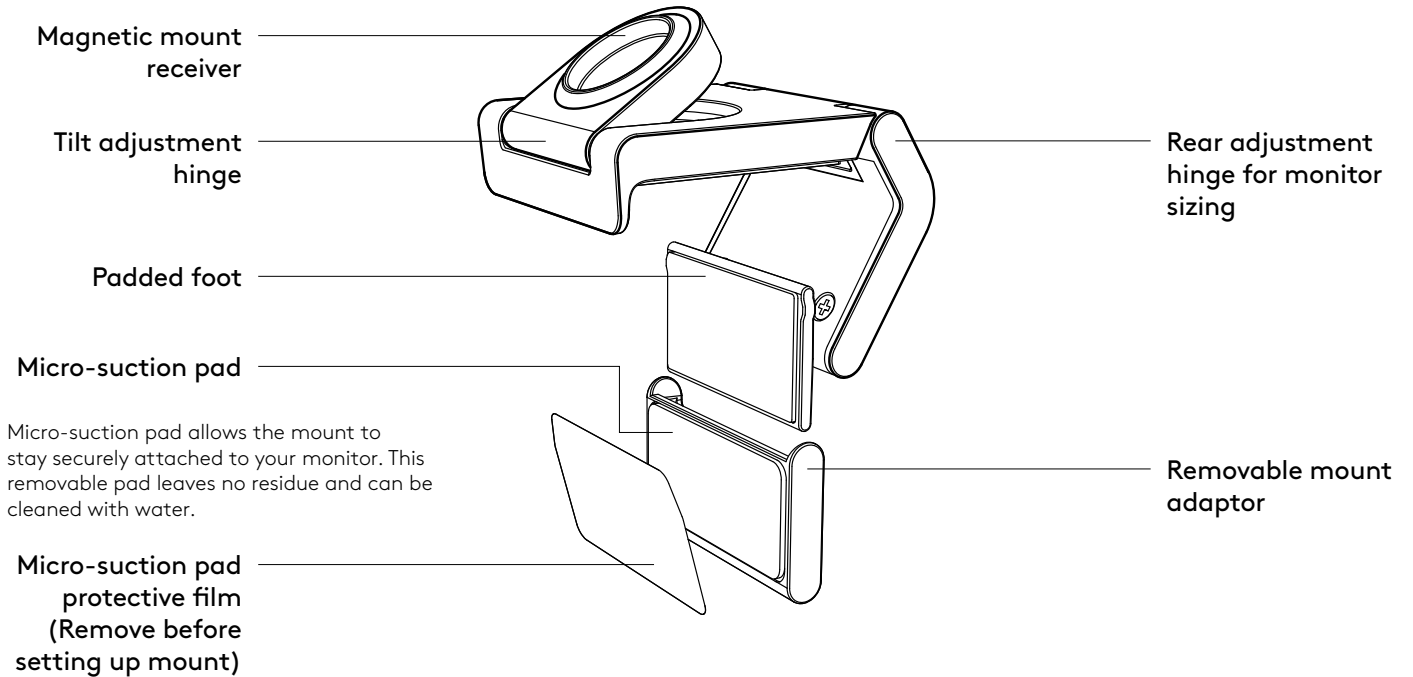

STEP 1: WHAT'S IN THE BOX

1. Webcam with attached USB-C cable
2. Mount clip with removable mount adaptor
3. User documentation

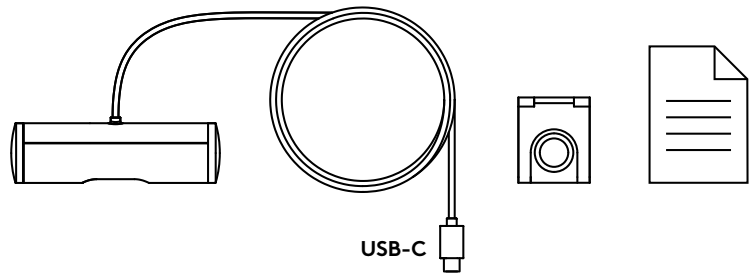

STEP 2: DETERMINE MOUNT PLACEMENT

Placement to allow one-handed camera adjustments (using micro-suction pad)

1. Determine the best placement for your webcam before continuing.
2. Wipe the back of your monitor to clear any dust or dirt.

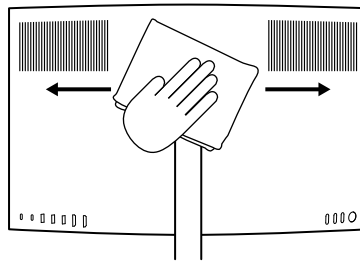

3. Remove the protective film from the micro-suction pad.

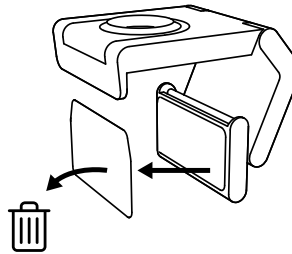

4. Open the mount fully and place on top of your monitor, being sure that the pad of the front clip makes contact with the front of the monitor.
5. Rotate the rear foot down until it makes contact with the back of the monitor.
6. Press the micro-suction pad to the back of your monitor firmly to create a good bond.

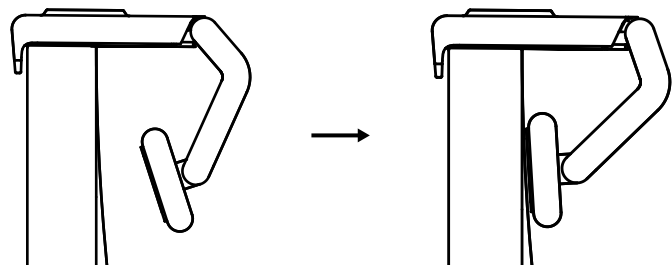

Note:

- The mount adaptor can be removed and reused for mounting adjustments without leaving residue.
- To clean the micro-suction pad, rinse with water to remove debris, and let it air dry in order to regain strong suction.

(Optional) Placement without the micro-suction pad

Slide the removable mount adapter down to remove it from the webcam foot. Adjust the foot on the mounting clip until it is flush with the back of your device and press firmly in place.

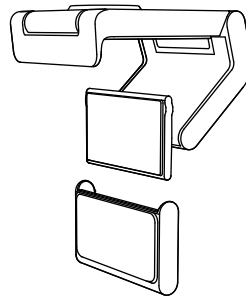

STEP 3: MOUNT ADAPTOR REMOVAL AND CLEANING

1. Remove the webcam from mount and gently peel the adaptor from one corner to remove.

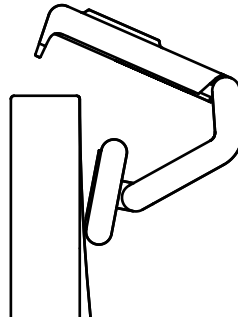

2. With a wet finger gently rub the pad clear of dust and dirt and let the micro-suction pad air dry completely before remounting (do not use cloth or tissue to dry).

3. Repeat the monitor placement setup steps to best deploy your webcam.

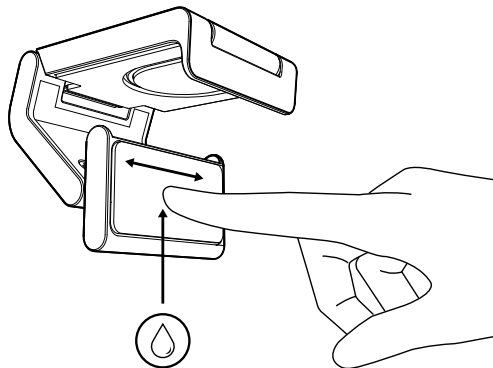

STEP 4: ATTACH CAMERA TO THE MOUNT

Place the webcam into the magnet attachment point on top of the mount. Listen for an audible click indicating the webcam is properly seated on the mount.

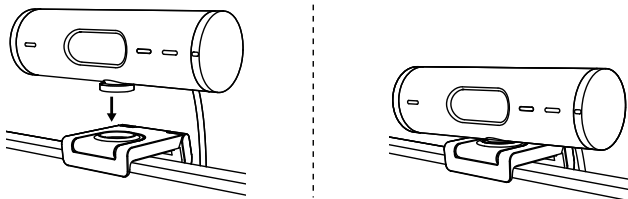

STEP 5: CONNECT THE WEBCAM VIA USB-C & GET STARTED

1. Plug the USB-C connector into the USB-C port on your computer, monitor, laptop, or docking station.

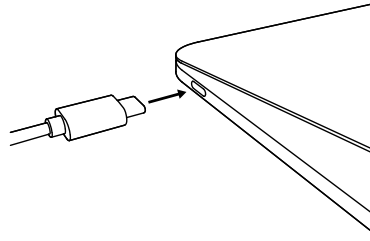

2. Rotate the dial on the right side of the webcam to open/close the privacy shutter.

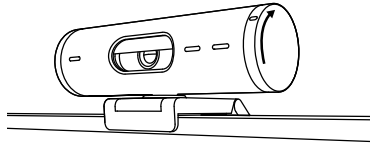

3. Adjust the webcam by turning side to side and tilting up and down to find the best framing for your video meetings.

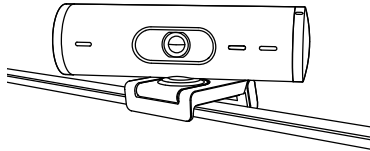

STEP 6: SUCCESSFUL CONNECTION

LED activity light will light up when the webcam is in use by any video application.

LED activity lights:

- Video ON/Audio ON: White
- Video ON/Audio OFF: White
- Video OFF/Audio ON: Yellow
- Video OFF/Audio OFF: No light
- Firmware Update: Breathing Lilac



STEP 7: SHOW MODE

Easily show physical items in video calls by tilting the camera down to present sketches, objects, and work in progress. There are two ways to use Show Mode:

1. **If mount is secured with micro-suction**

pad: Using one hand, tilt the camera down to show your desktop, and tilt back up to show yourself.

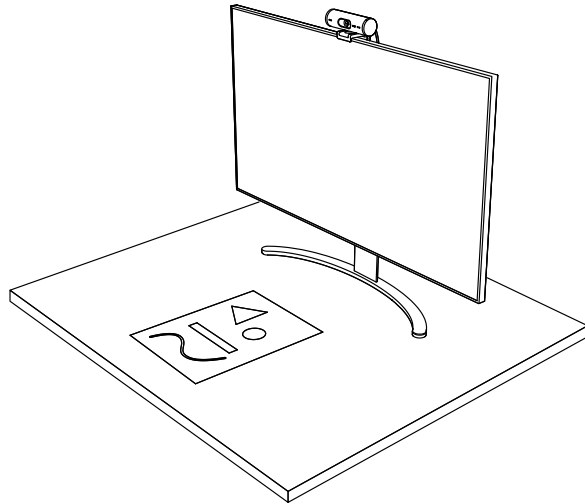

2. **If mount is not secured with micro-suction**

pad: Hold the mount still with one hand and tilt the camera up or down with the other.

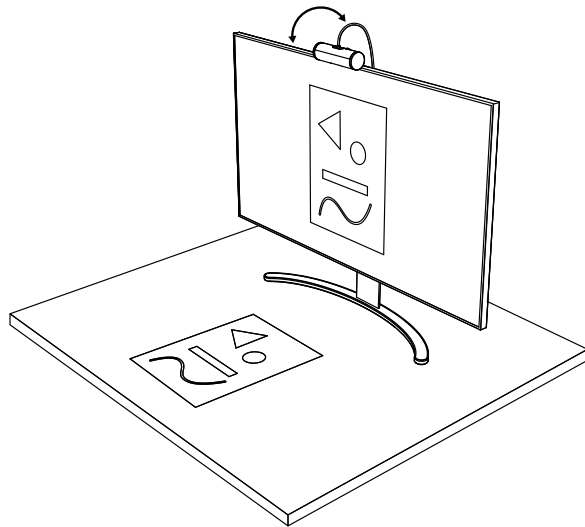

STEP 8: LOGI TUNE

Logi Tune helps boost your webcam performance with periodic software and firmware updates.

It is recommended to update your webcam. To do so, download Logi Tune from www.logitech.com/tune



www.logitech.com/tune

ADJUSTABLE OPTIONS

- Show Mode
- Auto-framing
- Zoom adjustment
- Field of View (90°/78°/65°)
- Image adjustment
- Auto-focus
- Disable mics
- LED on/off for video and audio

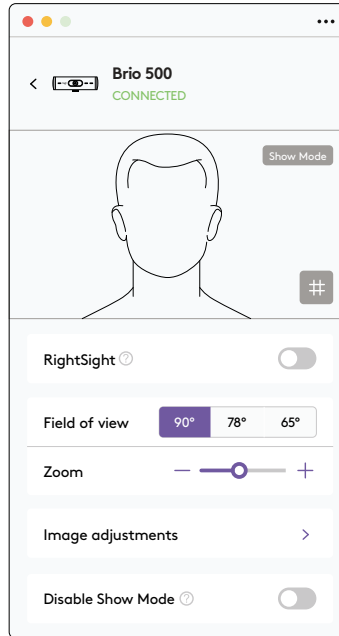

STEP 9: (OPTIONAL) ATTACH TO A TRIPOD

For placement on a tripod (not included)

1. Rotate counterclockwise to remove the mounting screw from the bottom of the webcam.

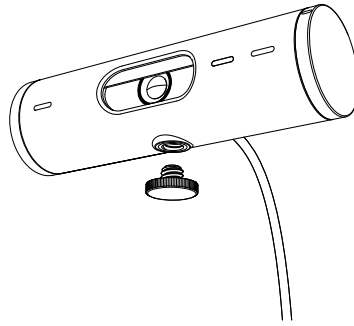

2. Locate the ¼ inch tripod thread on the bottom of the universal mounting clip.

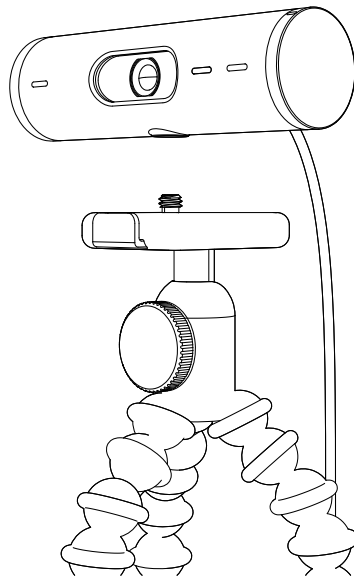

3. Secure the webcam on your tripod by twisting it into the ¼ inch thread.
4. Repeat the monitor placement setup steps to best deploy your webcam.
5. Please refer to step 5 and 6 to complete your webcam setup.

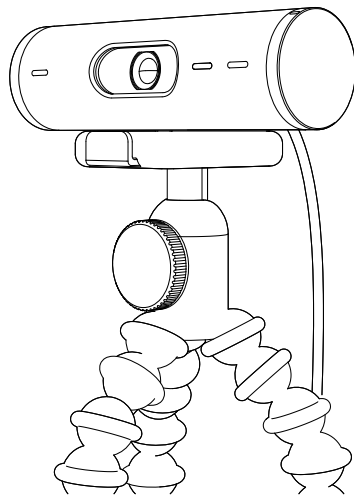

DIMENSIONS

WEBCAM:

Height x Width x Depth:

1.2 in (31.5 mm) x 4.3 in (110 mm) x 1.2 in (31.5 mm)

Height x Width x Depth (incl. mount clip):

2 in (51.5 mm) x 4.3 in (110 mm) x 1.8 in (45 mm)

Weight: 4.2 oz (121 g), incl. mount clip & cable

Attached Cable length: 5 ft (1.5 m)

MOUNTING CLIP:

Height x Width x Depth:

1 in (25 mm) x 1.8 in (45.8 mm) x 2.6 in (65.1 mm)

Weight: 1.4 oz (40 g), incl. Removable mount adapter

www.logitech.com/support/Brio500

了解您的产品

BRIO 500 前视图，带功能指示

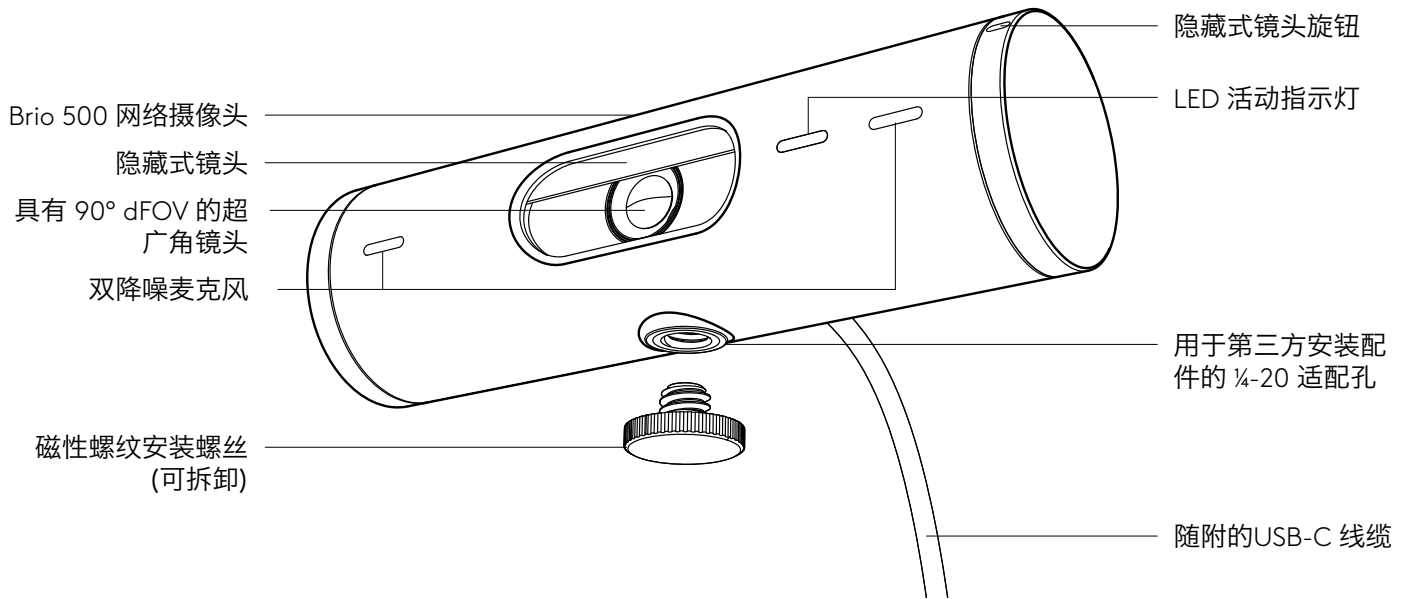

安装配件设计概览

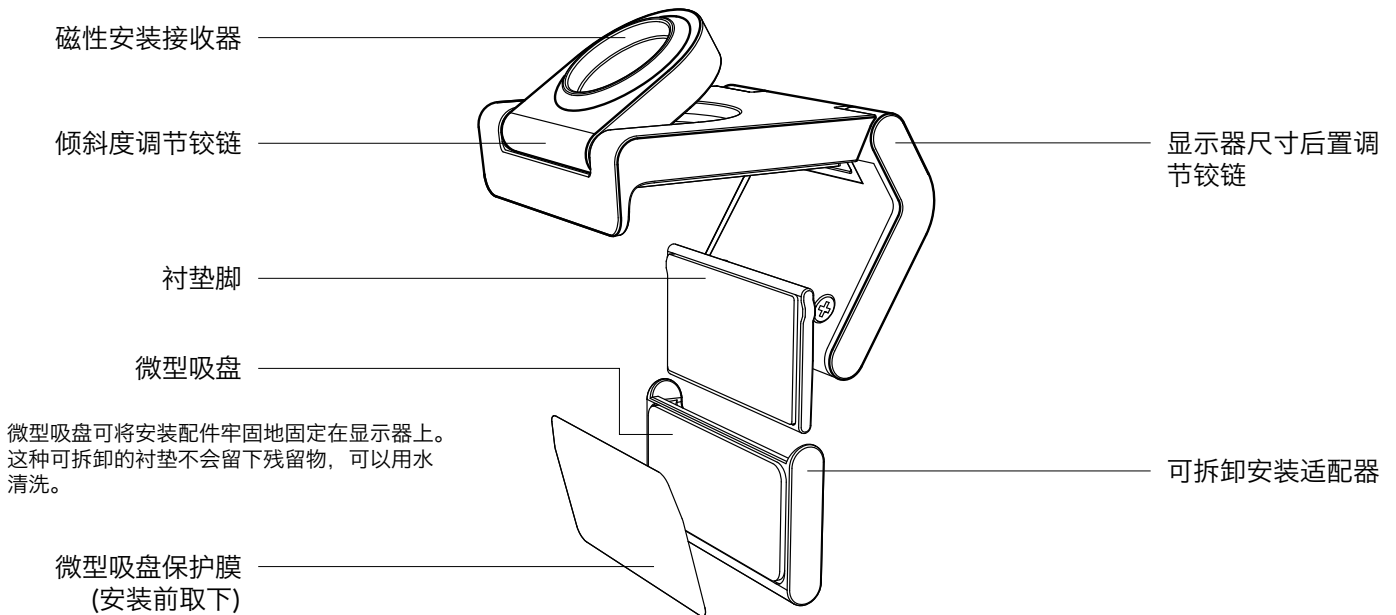

步骤 1: 包装内容

1. 带 USB-C 线缆的网络摄像头
2. 带可拆卸安装适配器的安装夹
3. 用户文档

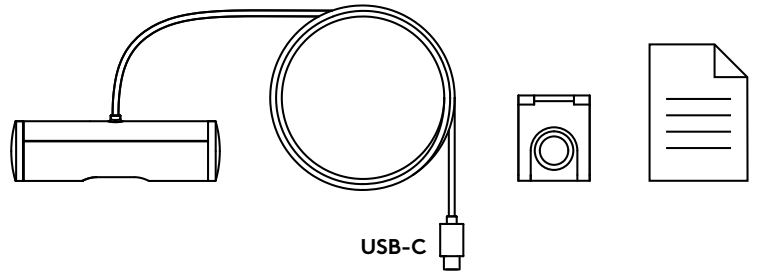

步骤 2: 确定安装位置

单手调节摄像头位置（使用微型吸盘）

1. 在继续之前确定网络摄像头的理想位置。
2. 擦拭显示器背面以清除灰尘或污垢。

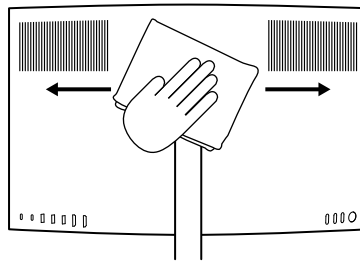

3. 取下微型吸盘的保护膜。

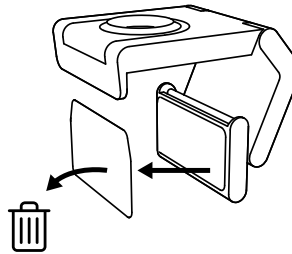

4. 完全打开支架并将其放在显示器顶部，确保前夹板的衬垫与显示器的正面接触。
5. 向下旋转后支脚，直至接触到显示器的后部。
6. 将微型吸盘牢固地按在显示器背面，以形成良好的粘合。

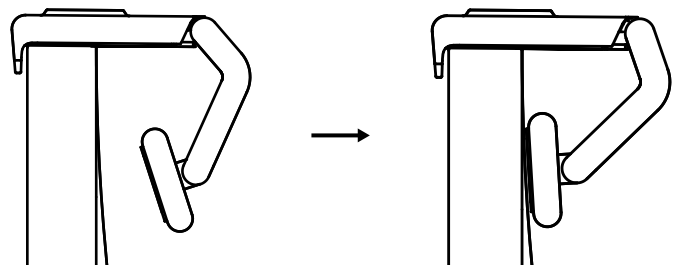

注意：

- 安装适配器可以移除并重新用于安装调整，而不会留下任何残留物。
- 清洁微型吸盘时，请先用水冲洗掉碎屑，然后自然风干以恢复强大的吸力。

(可选) 不使用微型吸盘放置

向下滑动可拆卸安装适配器，将其从网络摄像头脚上卸下。调整安装夹上的支脚，直至与设备背面齐平，然后用力按压到位。

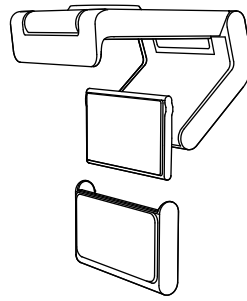

步骤 3: 安装适配器的拆卸和清洁

1. 从安装配件上取下网络摄像头，轻轻地从一角剥下适配器以将其取下。

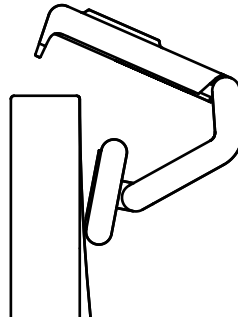

2. 用沾湿的手指轻轻擦去灰尘和污垢，让微型吸盘完全风干，然后再重新安装（不要使用布或纸巾擦干）。

3. 重复显示器放置设置步骤，以更好地部署网络摄像头。

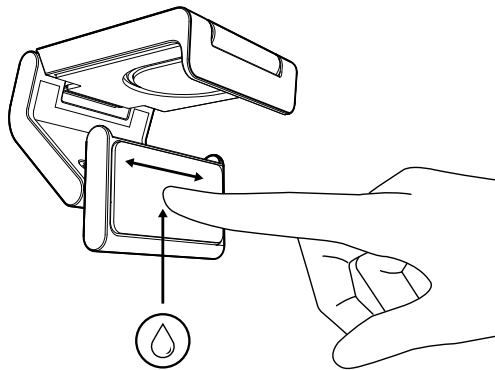

步骤 4: 将摄像头安装到安装配件上

将网络摄像头放入安装配件顶部的磁铁连接点。听到咔嚓声，表示网络摄像头已正确安装在支架上。

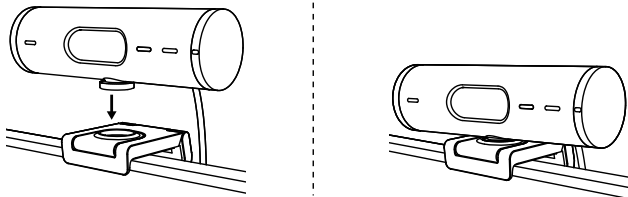

步骤 5：通过 USB-C 连接网络摄像头并开始使用

1. 将 USB-C 接头插入电脑、显示器、笔记本电脑或扩展坞的 USB-C 端口。

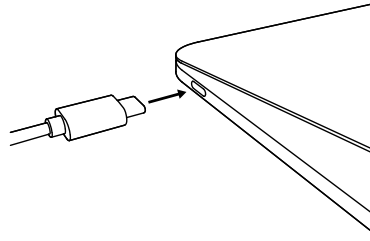

2. 旋转网络摄像头右侧的旋钮以打开/关闭隐私镜头盖。

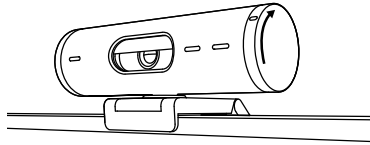



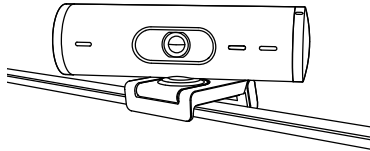

3. 通过左右转动和上下倾斜来调整网络摄像头，找到适合视频会议的取景画面。



步骤 6：成功连接

当任何视频应用程序使用网络摄像头时，LED 活动指示灯都将点亮。

LED 活动指示灯：

- 视频开启/音频开启：白色 
- 视频开启/音频关闭：白色 
- 视频关闭/音频开启：黄色 
- 视频关闭/音频关闭：无指示灯 
- 固件更新：紫色呼吸灯 

步骤 7: 显示模式

可向下倾斜摄像头以拍摄手绘、拍摄对象和进行中的工作，轻松将实体内容展示在视频通话之中。有两种使用显示模式的方法：

1. 如果支架是用微型吸盘固定的：用一只手向下倾斜摄像头即可拍摄桌面，向后倾斜即可拍摄您自己。

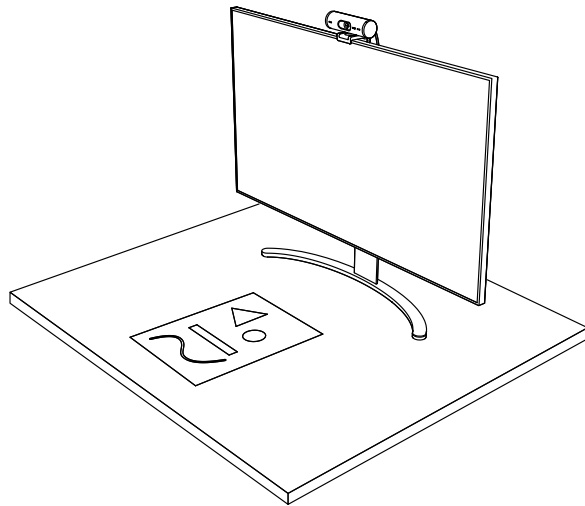

2. 如果支架没有用微型吸盘固定：一手握住支架，另一只手向上或向下倾斜摄像头。

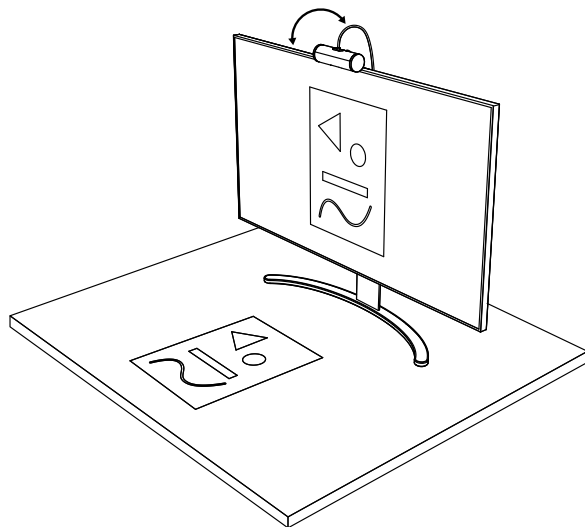

步骤 8: LOGI TUNE

Logi Tune 通过定期的软件和固件更新帮助改善网络摄像头性能。

建议您及时更新网络摄像头。为此，请下载 Logi Tune：www.logitech.com/tune



www.logitech.com/tune

可调节选项

- 显示模式
- 自动取景
- 变焦调节
- 视野 (90°/78°/65°)
- 画面调节
- 自动对焦
- 禁用麦克风
- 视频和音频 LED 开/关

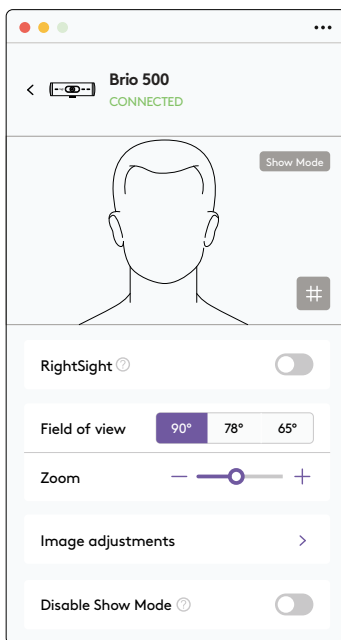

步骤 9: (可选) 连接三脚架

放置于三脚架上 (需另购)

1. 逆时针旋转, 卸下网络摄像头底部的安装螺丝。

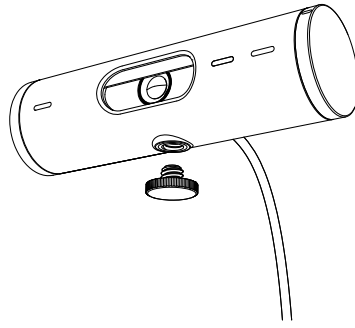

2. 找到通用安装夹底部的 1/4 英寸三脚架安装螺纹。

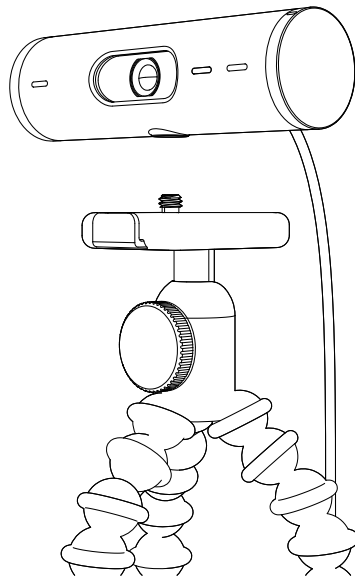

3. 将三脚架拧入 1/4 英寸安装螺纹, 将网络摄像头固定于三脚架上。
4. 重复显示器放置设置步骤, 以更好地部署网络摄像头。
5. 请参阅步骤 5 和 6 完成网络摄像头设置。

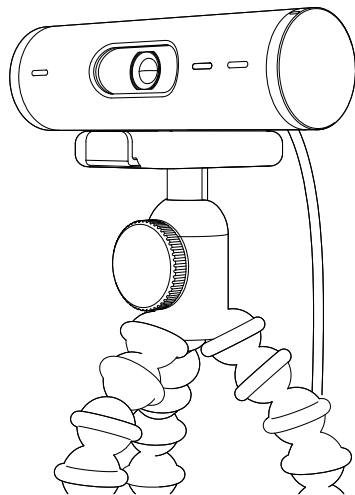

尺寸

网络摄像头:

高 x 宽 x 深:

约 31.5 毫米 x 约 110 毫米 x 约 31.5 毫米

高 x 宽 x 深 (含安装夹):

约 51.5 毫米 x 约 110 毫米 x 约 45 毫米

重量: 约 121 克, 含安装夹和线缆

随附线缆长度: 约 1.5 米

安装夹:

高 x 宽 x 深:

约 25 毫米 x 约 45.8 毫米 x 约 65.1 毫米

重量: 约 40 克, 含可拆卸安装适配器

www.logitech.com/support/Brio500

瞭解您的產品

BRIO 500 正面檢視，含功能指示

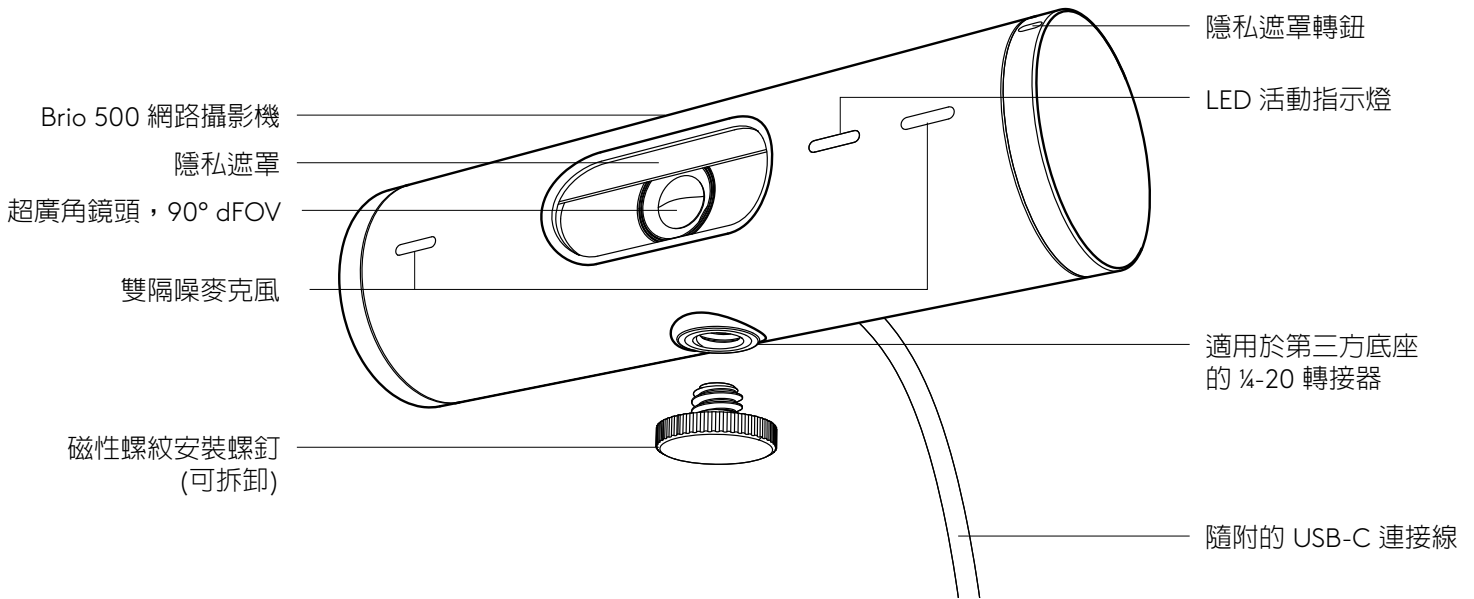

安裝套件設計概覽

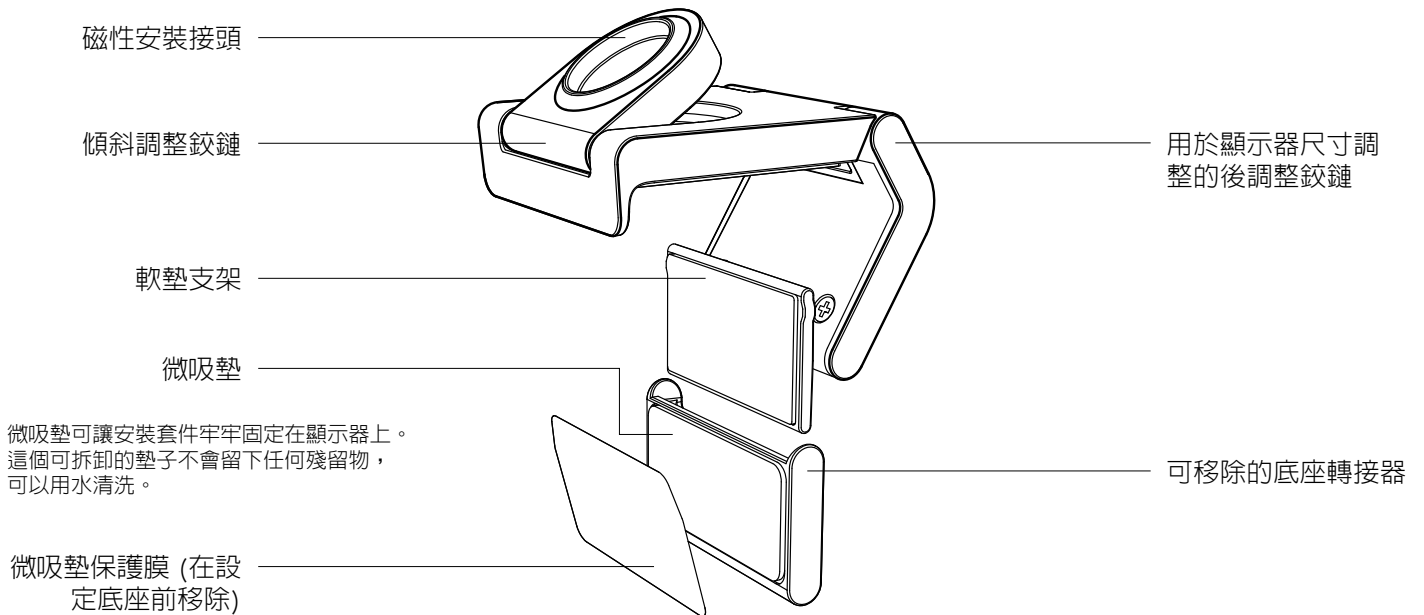

步驟 1：包裝內容

1. 含 USB-C 連接線的網路攝影機
2. 含可移除底座轉接器的安裝夾具
3. 使用者文件

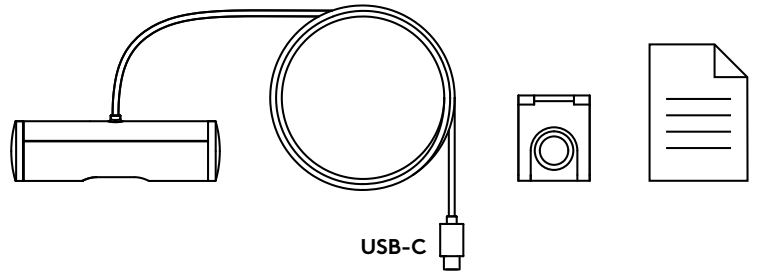

步驟 2：決定安裝位置

擺放位置應足以進行單手攝影機調整 (使用微吸墊)

1. 在繼續之前，為您的網路攝影機決定最佳位置。
2. 擦拭顯示器背面，清除所有灰塵或污垢。

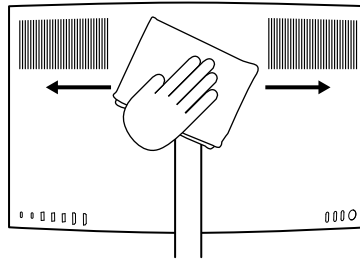

3. 取下微吸墊上的保護膜。

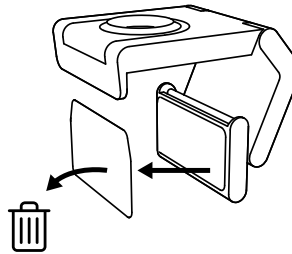

4. 完全打開底座並將其放在顯示器頂部，確保前方夾具的墊子與顯示器正面接觸。
5. 向下旋轉後支架，直到其接觸到顯示器的背面。
6. 按壓微型墊使其牢牢貼附在顯示器背面，形成良好的黏合。

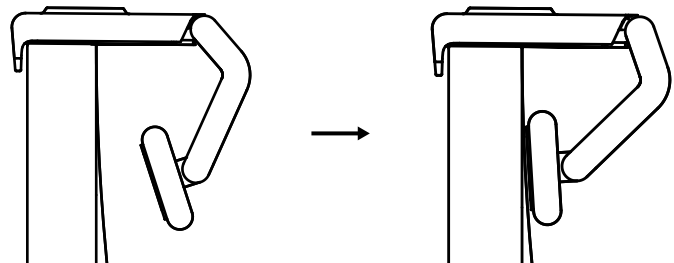

注意：

- 底座轉接器可移除並可再使用於底座調整，不會留下任何殘留物。
- 若要清潔微吸墊，請用水沖洗以去除碎屑，然後風乾以恢復強大的吸力。

(選用) 不使用微吸墊的擺放方式

向下滑動可拆卸底座轉接器，將其從網路攝影機支架上取下。調整安裝夾具上的支架，直到其與裝置背面齊平，然後用力按壓到定位。

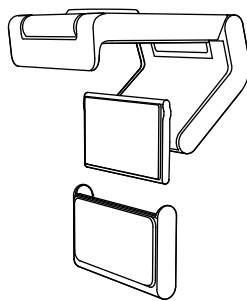

步驟 3：底座轉接器的移除和清潔

1. 從底座上取下網路攝影機，然後從一角輕輕剝下轉接器，將其取下。

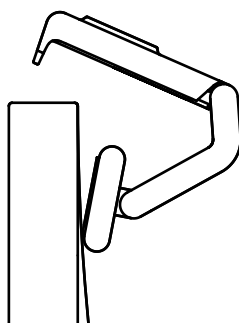

2. 在重新裝上之前，使用沾濕的手指輕輕擦拭微吸墊上的灰塵和污垢，讓微吸墊完全風乾 (不要用布或紙巾擦乾)。
3. 重複顯示器放置設定步驟，以獲得您網路攝影機的最佳部署方式。

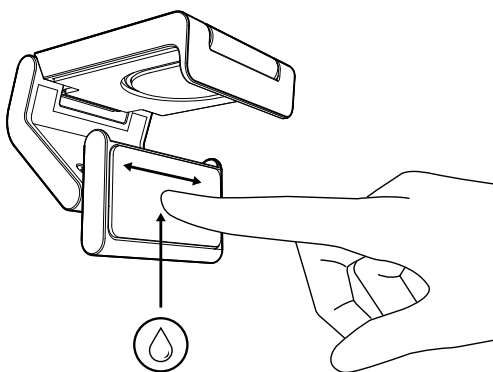

步驟 4：將網路攝影機接到底座上

將網路攝影機放入底座上方的磁力接點。助益聆聽嗒聲，這表示網路攝影機已正確安裝在底座上。

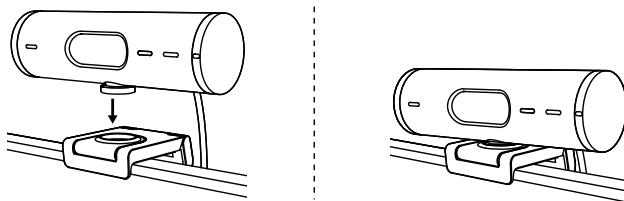

步驟 5：透過 USB-C 連接網路攝影機並準備就緒

1. 將 USB-C 接頭插入電腦、顯示器、筆記型電腦或擴展塢底座上的 USB-C 連接埠。

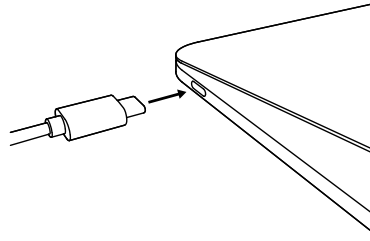

2. 旋轉網路攝影機右側的轉鈕可打開/關上隱私遮罩。

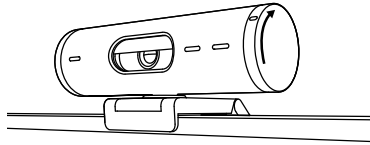



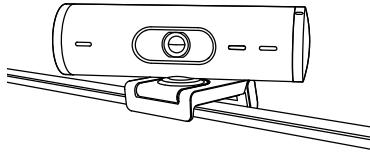

3. 透過左右轉動和上下傾斜調整網路攝影機，為您的視訊會議找到最佳取景位置。



步驟 6：成功連接

LED 活動指示燈會在任何視訊應用程式使用網路攝影機時亮起。

LED 活動指示燈：

- 視訊開啓/音訊開啓：白色 
- 視訊開啓/音訊關閉：白色 
- 視訊關閉/音訊開啓：黃燈 
- 視訊關閉/音訊關閉：無指示燈 
- 韌體更新：呼吸丁香紫燈 

步驟 7：展示模式

透過向下傾斜攝影機以展示繪圖、物體和進行中的工作，輕鬆在視訊通話中展示實際的物品。有兩種使用展示模式的方法：

1. 如果底座使用微吸墊固定：用一隻手向下傾斜相機以顯示您的桌面，然後向上傾斜以顯示您自己。

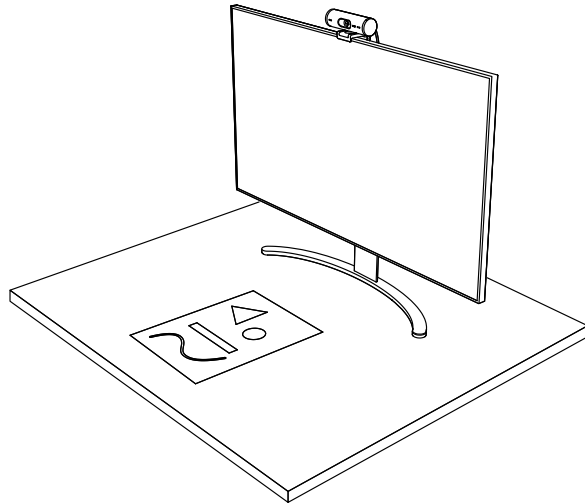

2. 如果底座不是使用微吸墊固定：一隻手握底座，另一隻手向上或向下傾斜攝影機。

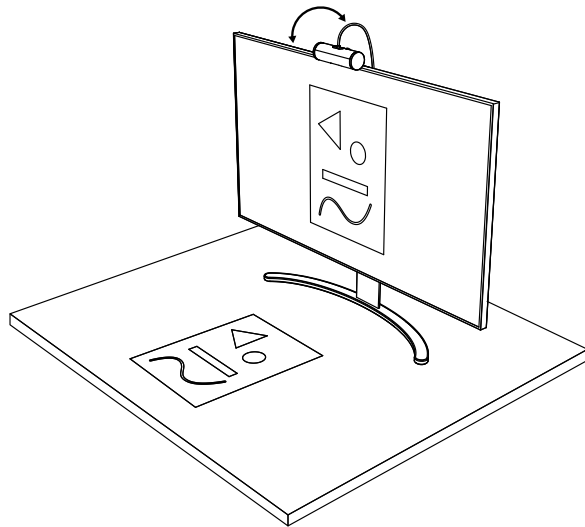

步驟 8：LOGI TUNE

Logi Tune 可透過定期的軟體與韌體更新，協助加強網路攝影機性能。

建議您更新您的網路攝影機。若要如此做，請到下列網址下載 Logi Tune：
www.logitech.com/tune



www.logitech.com/tune

可調整選項

- 展示模式
- 自動取景
- 變焦調整
- 視野 (90°/78°/65°)
- 影像調整
- 自動對焦
- 停用麥克風
- 視訊和音訊的 LED 指示燈亮起/熄滅

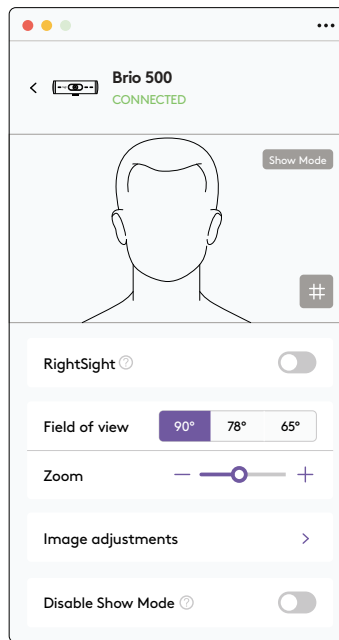

步驟 9：(選用) 連接到三腳架

若要放置在三腳架 (未隨附) 上

1. 逆時針旋轉以從網路攝影機底部取下安裝螺釘。

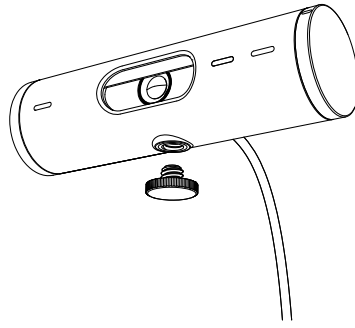

2. 找到位於通用安裝夾具底部上的 ¼ 英吋三腳架安裝螺紋。

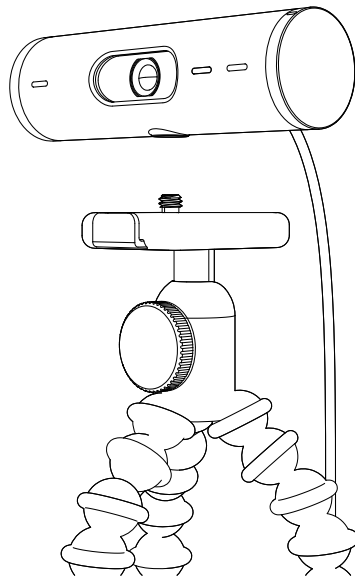

3. 將三腳架轉入 ¼ 英吋螺紋中，使網路攝影機固定在三腳架上。
4. 重複顯示器放置設定步驟，以獲得您網路攝影機的最佳部署方式。
5. 請參閱步驟 5 和 6 以完成您的網路攝影機設定。

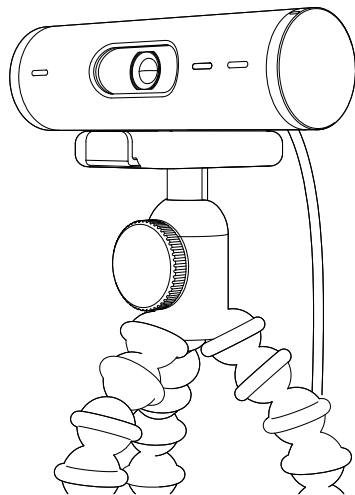

尺寸

網路攝影機：

高 x 寬 x 深：

31.5 公釐 (1.2 英吋) x 110 公釐 (4.3 英吋) x 31.5 公釐 (1.2 英吋)

高 x 寬 x 深 (含安裝夾具)：

51.5 公釐 (2 英吋) x 110 公釐 (4.3 英吋) x 45 公釐 (1.8 英吋)

重量：121 公克 (4.2 盎司)，含安裝夾具和連接線

隨附的連接線長度：1.5 公尺 (5 英呎)

安裝夾具：

高 x 寬 x 深：

25 公釐 (1 英吋) x 45.8 公釐 (1.8 英吋) x 65.1 公釐 (2.6 英吋)

重量：40 公克 (1.4 盎司)，含可移除的底座轉接器

www.logitech.com/support/Brio500

제품 설명

기능 표시가 있는 BRIO 500 전면 모습

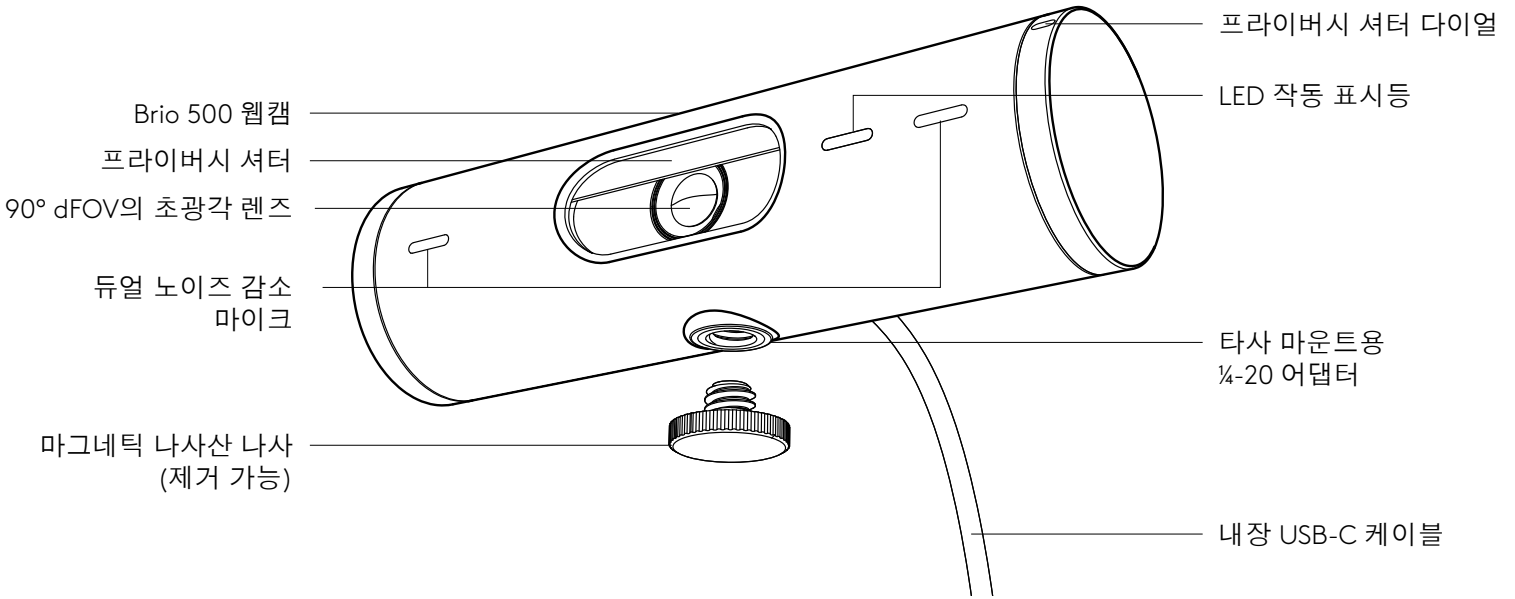

마운트 디자인 개요

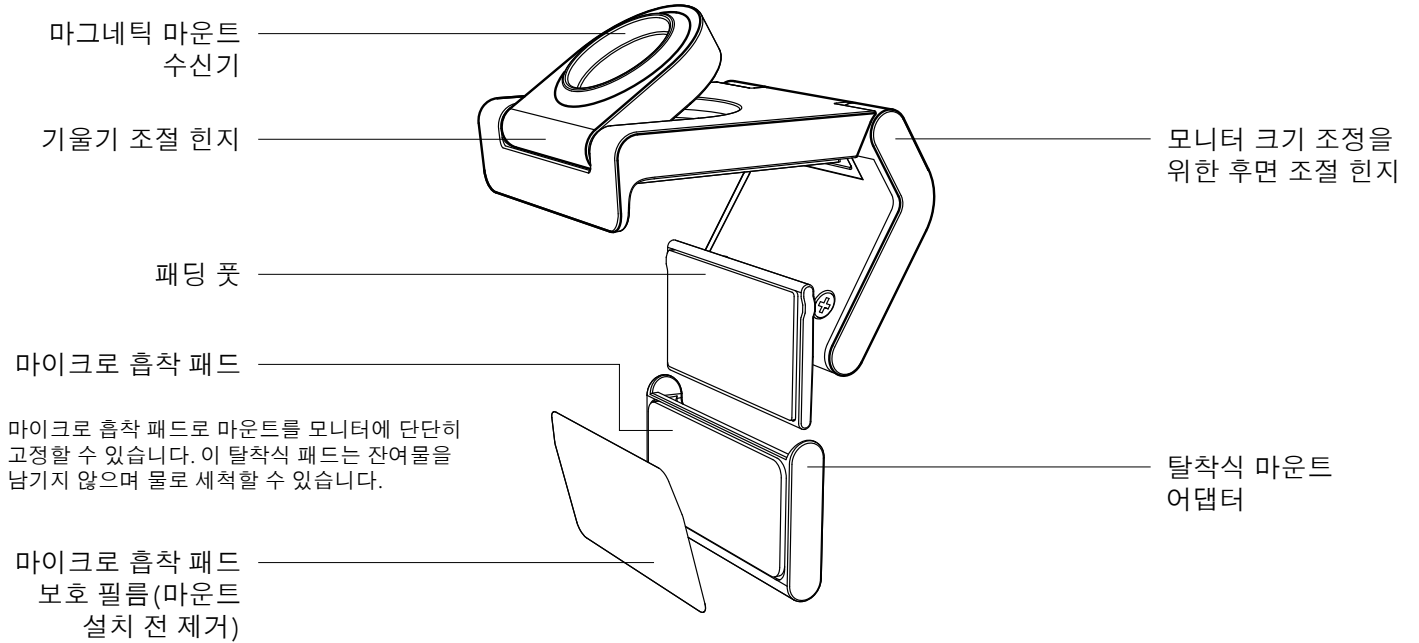

1단계: 내용물

1. USB-C 케이블이 내장된 웹캠
2. 탈착식 마운트 어댑터가 달린 마운트 클립
3. 사용 설명서

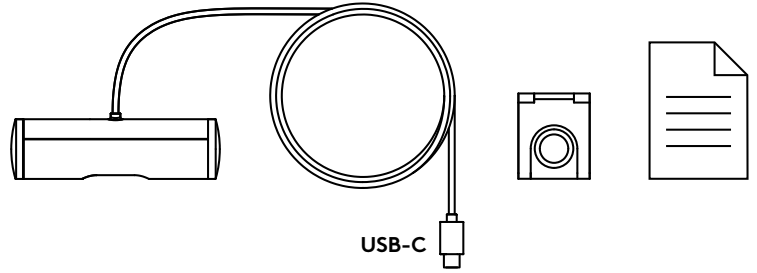

2단계: 마운트 배치 결정

한 손으로 카메라를 조절할 수 있는 배치
(마이크로 흡착 패드 사용)

1. 진행하기 전에 웹캠에 가장 적합한 위치를 결정해야 합니다.
2. 모니터 뒷면을 닦아 먼지를 제거합니다.

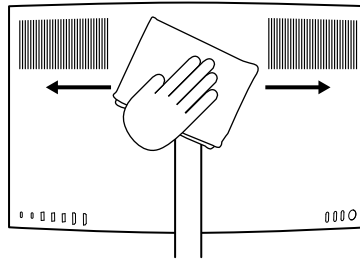

3. 마이크로 흡착 패드에서 보호 필름을 제거합니다.

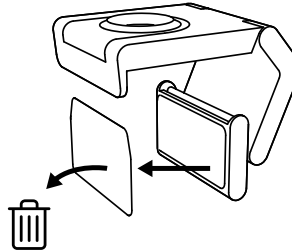

4. 마운트를 완전히 열고 전면 클립의 패드가 모니터 전면에 닿도록 하여 모니터 위에 놓습니다.
5. 모니터 후면에 닿을 때까지 뒷발을 아래로 돌립니다.
6. 모니터 후면의 마이크로 흡착 패드를 세게 눌러 접착력을 높칩니다.

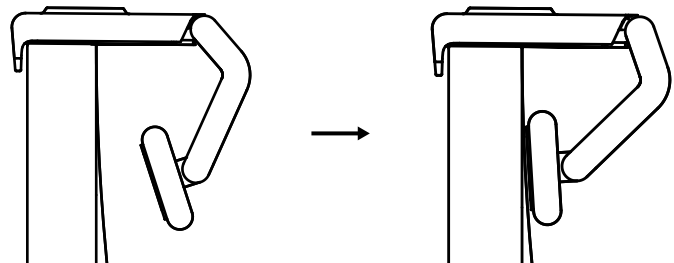

참고:

- 마운트 어댑터는 잔여물을 남기지 않고 제거 가능하며 마운트 조정에 재사용할 수 있습니다.
- 마이크로 흡착 패드를 청소하려면 물로 행구어 이물질 제거한 다음 강한 흡착력을 되찾을 수 있도록 말리면 됩니다.

(선택 사항) 마이크로 흡착 패드 없이 배치

탈착식 마운트 어댑터를 아래로 밀어 웹캠 다리에서 분리합니다. 마운팅 클립 위에서 다리를 조절하여 장치의 후면과 같은 높이로 만든 다음 세게 눌러 고정합니다.

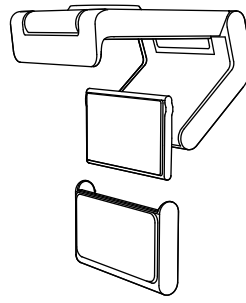

3단계: 마운트 어댑터 분리 및 청소

1. 마운트에서 웹캠을 제거하고 어댑터의 한쪽 모서리를 부드럽게 벗겨 제거합니다.

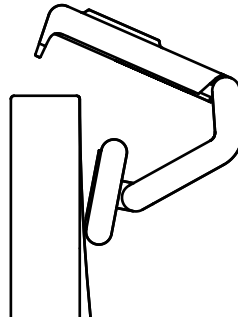

2. 젖은 손가락으로 패드를 부드럽게 문질러 먼지와 더러움을 제거하고 마이크로 흡착 패드를 공기 중에 완전히 건조한 다음 다시 장착합니다(천이나 티슈로 말리지 마십시오).

3. 모니터 배치 설정 단계를 반복하여 웹캠을 배치합니다.

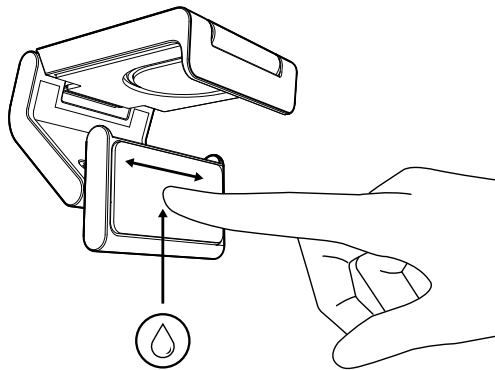

4단계: 마운트에 카메라 부착

웹캠을 마운트 상단의 자석 부착 지점에 둡니다. 웹캠이 마운트에 제대로 장착되었음을 알리는 딸깍 소리가 들려야 합니다.

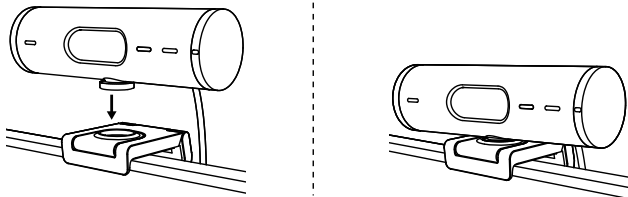

5단계: USB-C로 웹캠 연결 및 시작하기

1. USB-C 커넥터를 컴퓨터, 모니터, 노트북 또는 도킹 스테이션의 USB-C 포트에 연결합니다.

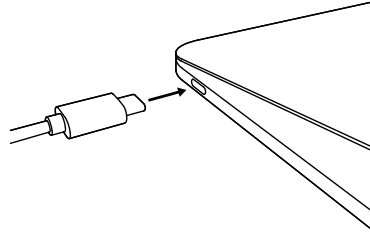

2. 웹캠 오른쪽에 있는 다이얼을 돌려 프라이버시 셔터를 열거나 닫을 수 있습니다.

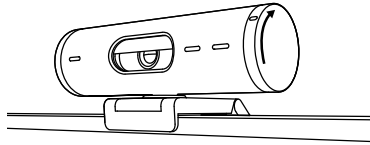

3. 웹캠을 좌우로 돌리고 상하로 기울여 화상 회의에 가장 적합한 프레임을 찾아보세요.

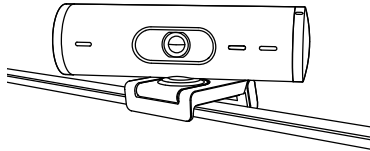

6단계: 연결 성공

아무 비디오 애플리케이션에서 웹캠을 사용하면 LED 작동 표시등에 불이 들어옵니다.

LED 작동 표시등:

- 비디오 켜짐/오디오 켜짐: 흰색 ○
- 비디오 켜짐/오디오 꺼짐: 흰색 ○
- 비디오 꺼짐/오디오 켜짐: 노란색 ●
- 비디오 꺼짐/오디오 꺼짐: 조명 없음 ∅
- 펌웨어 업데이트: 보라색으로 깜박임 ●

7단계: 보여주기 모드

영상 통화 중 카메라를 기울여 스케치, 물체, 진행 중인 작업 등 다양한 물건을 쉽게 보여줄 수 있습니다. 보여주기 모드 사용 방법은 두 가지입니다.

1. 마운트가 마이크로 흡착 패드로 고정된 경우: 한 손을 사용하여 카메라를 아래로 기울이면 바탕 화면이 표시되고 다시 뒤로 기울이면 내 모습이 표시됩니다.

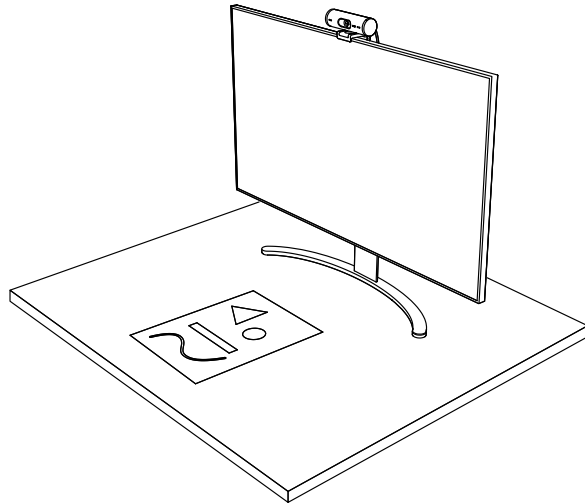

2. 마운트가 마이크로 흡착 패드로 고정되지 않은 경우: 한 손으로 마운트를 잡고 다른 손으로 카메라를 위 또는 아래로 기울칩니다.

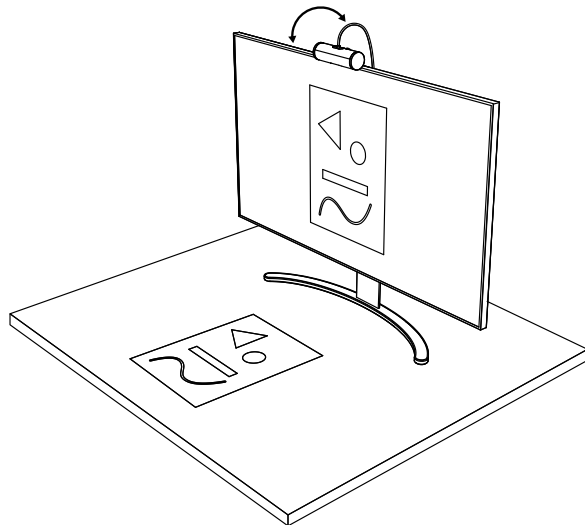

8단계: LOGI TUNE

Logi Tune은 정기 소프트웨어 및 펌웨어 업데이트로 웹캠 성능 향상을 지원합니다.

웹캠을 업데이트하는 것이 좋습니다.

업데이트하려면 www.logitech.com/tune에서 Logi Tune을 다운로드합니다.



www.logitech.com/tune

조정 가능한 옵션

- 보여주기 모드
- 오토 프레이밍
- 확대/축소 조절
- 시야각(90°/78°/65°)
- 이미지 조정
- 오토 포커스
- 마이크 비활성화
- 비디오 및 오디오용 LED 켜기/끄기

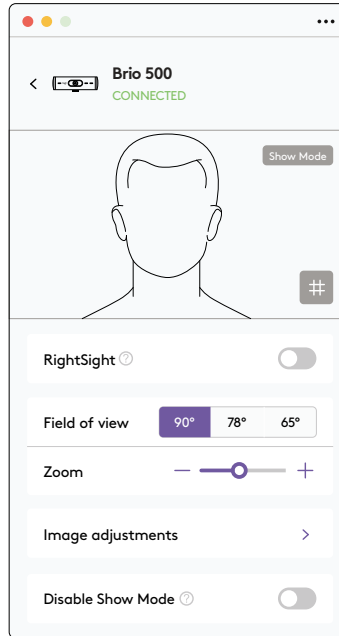

9단계: (선택 사항) 삼각대에 부착

삼각대 장착용 (미포함)

1. 시계 반대 방향으로 돌려 웹캠 하단에서 장착 나사를 제거합니다.

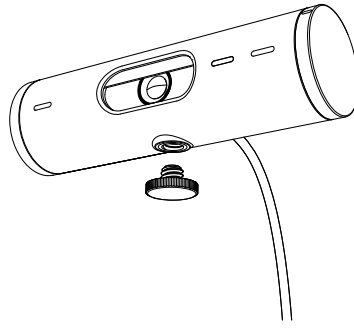

2. 범용 장착 클립 하단에서 1/4인치 삼각대 나사를 찾습니다.

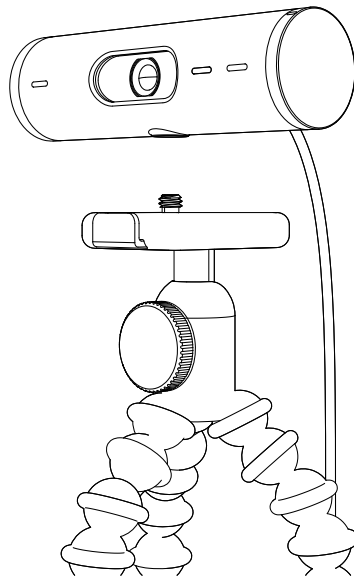

3. 웹캠을 1/4인치 나사에 끼워 삼각대에 고정합니다.
4. 모니터 배치 설정 단계를 반복하여 웹캠을 배치합니다.
5. 5단계와 6단계를 참조하여 웹캠 설정을 완료하세요.

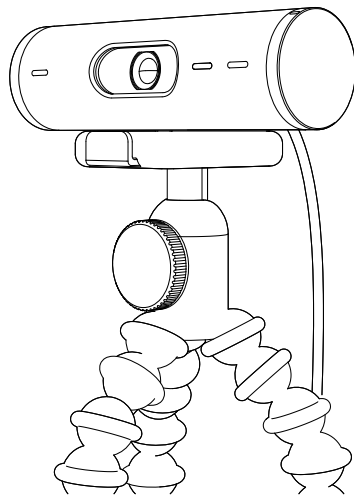

규격

웹캠:

높이 x 너비 x 깊이:

31.5mm(1.2인치) x 110mm(4.3인치) x 31.5mm(1.2인치)

높이 x 너비 x 깊이 (마운트 클립 포함):

51.5mm(2인치) x 110mm(4.3인치) x 45mm(1.8인치)

무게: 마운트 클립 및 케이블 포함 121g(4.2oz)

내장 케이블 길이: 1.5미터(5피트)

마운팅 클립:

높이 x 너비 x 깊이:

25mm(1인치) x 45.8mm(1.8인치) x 65.1mm(2.6인치)

무게: 탈착식 마운트 어댑터 포함 40g(1.4oz)

www.logitech.com/support/Brio500

MENGENAL PRODUK

BRIO 500 TAMPILAN DEPAN DENGAN INDIKASI FUNGSI

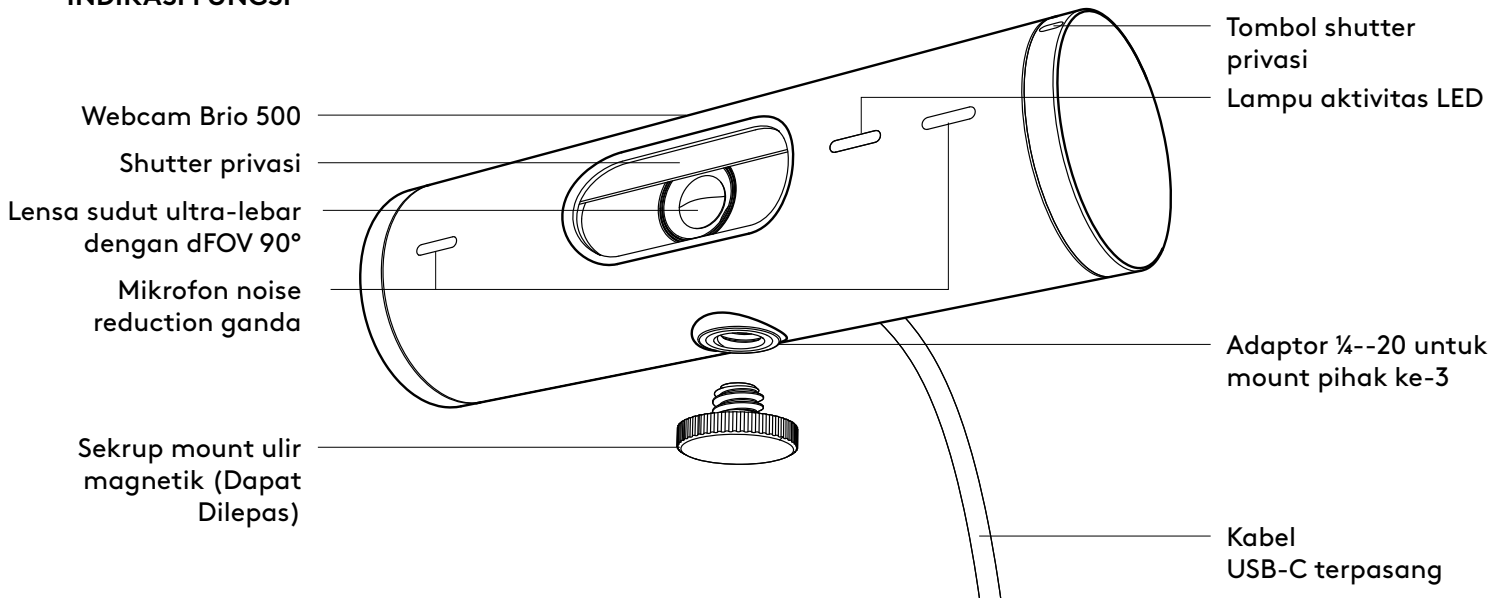

IKHTISAR DESAIN MOUNT

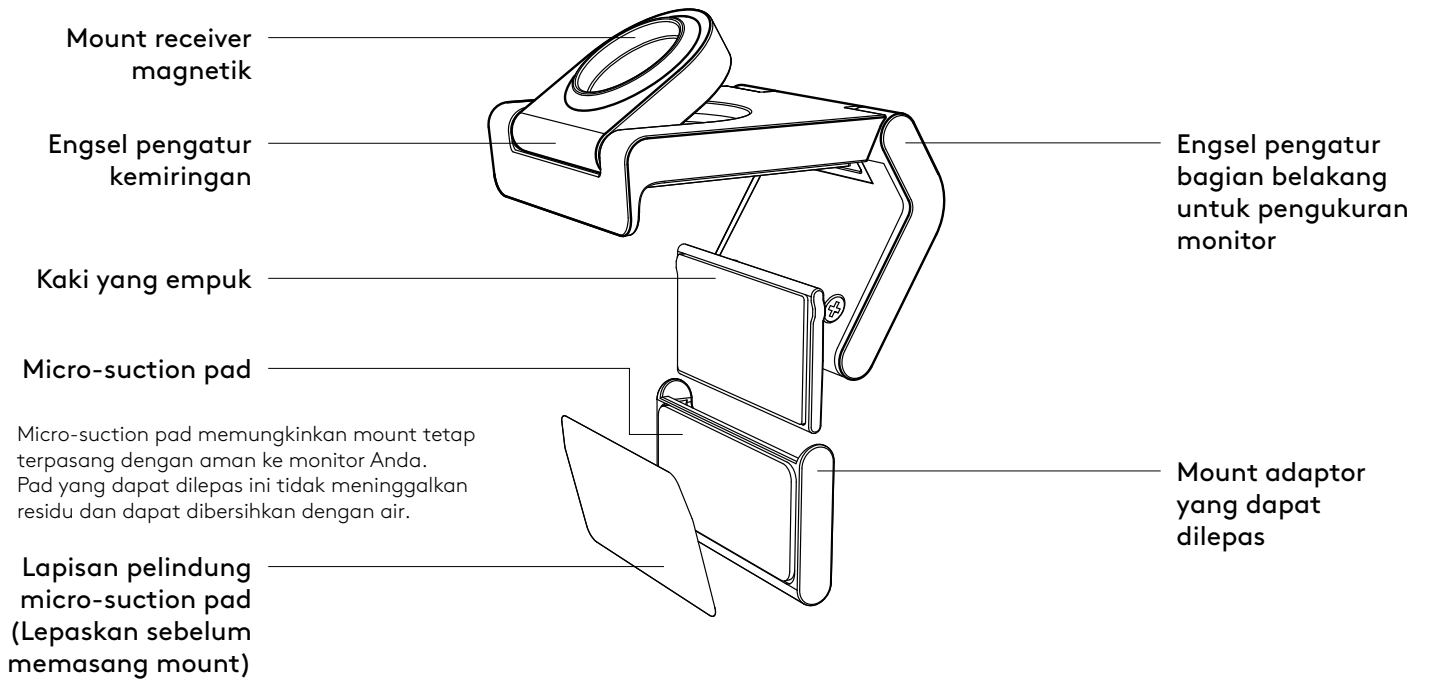

LANGKAH 1: ISI KEMASAN

1. Webcam dengan kabel USB-C terpasang
2. Mount clip dengan mount adaptor yang dapat dilepas
3. Dokumentasi pengguna

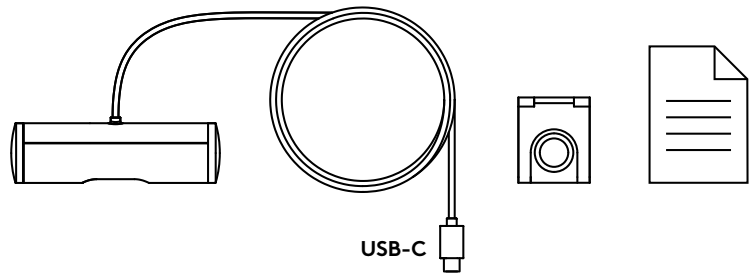

LANGKAH 2: TENTUKAN PENEMPATAN MOUNT

Penempatan yang memungkinkan penyesuaian kamera dengan satu tangan (menggunakan micro-suction pad)

1. Tentukan penempatan terbaik untuk webcam Anda sebelum melanjutkan.
2. Seka bagian belakang monitor untuk membersihkan debu atau kotoran.

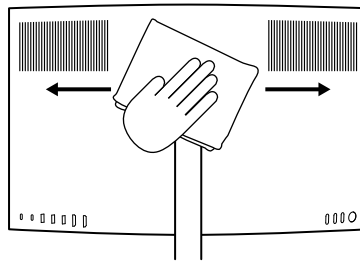

3. Lepaskan lapisan pelindung dari micro-suction pad.

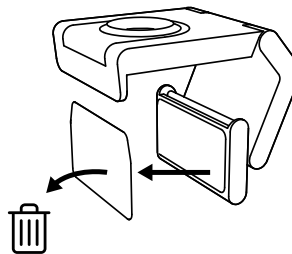

4. Buka mount sepenuhnya dan letakkan di bagian atas monitor Anda, pastikan pad di klip depan menyentuh bagian depan monitor.
5. Putar kaki belakang ke bawah hingga menyentuh bagian belakang monitor.
6. Tekan micro-suction pad ke bagian belakang monitor dengan kuat agar menempel dengan baik.

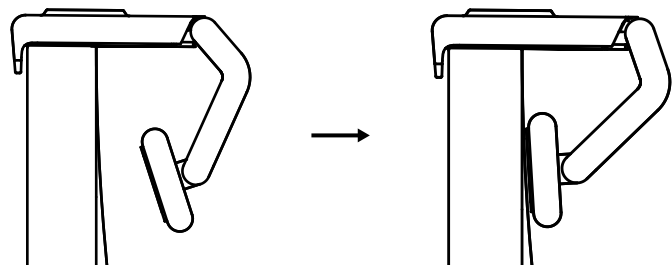

Catatan:

- Mount adaptor dapat dilepas dan digunakan kembali untuk menyesuaikan pemasangan tanpa meninggalkan residu.
- Untuk membersihkan micro-suction pad, bilas dengan air untuk menghilangkan kotoran, dan biarkan mengering agar daya hisapnya kembali kuat.

(Opsional) Penempatan tanpa micro-suction pad

Geser mount adaptor yang dapat dilepas ini ke bawah untuk melepaskannya dari kaki webcam. Sesuaikan kaki pada mounting clip hingga sejajar dengan bagian belakang perangkat Anda lalu tekan dengan kuat.

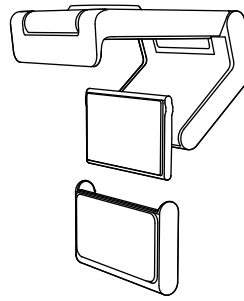

LANGKAH 3: MELEPASKAN DAN MEMBERSIHKAN MOUNT ADAPTOR

1. Lepaskan webcam dari mount dan dengan lembut kelupas adaptor dari salah satu sudutnya untuk melepaskannya.

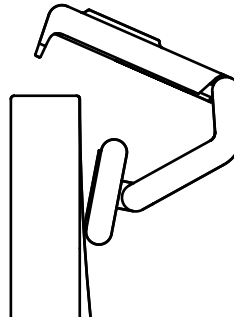

2. Dengan jari yang basah, bersihkan debu dan kotoran dari pad secara perlahan-lahan lalu biarkan micro-suction pad benar-benar kering sebelum memasangnya kembali (jangan gunakan kain atau tisu untuk mengeringkannya).

3. Ulangi langkah penyiapan penempatan monitor agar bisa menggunakan webcam Anda dengan sebaik mungkin.

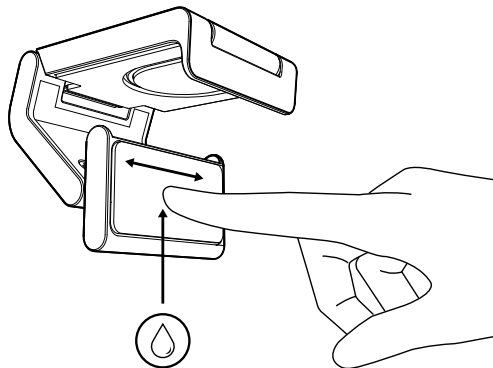

LANGKAH 4: PASANG KAMERA KE MOUNT

Letakkan webcam ke titik pemasangan magnet di bagian atas mount. Dengarkan bunyi klik yang menunjukkan webcam sudah terpasang dengan benar di mount.

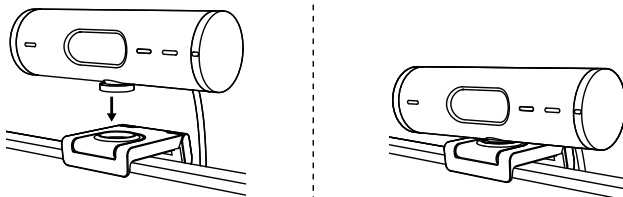

LANGKAH 5: HUBUNGKAN WEBCAM VIA USB-C & MULAI

1. Colokkan konektor USB-C ke port USB-C di komputer, monitor, laptop, atau docking station Anda.

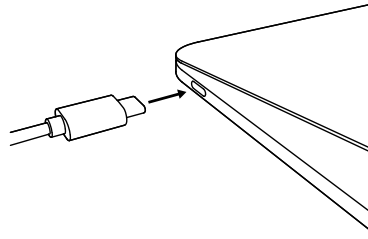

2. Putar tombol di sisi kanan webcam untuk membuka/menutup shutter privasi.

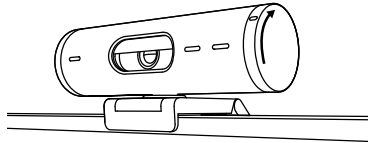



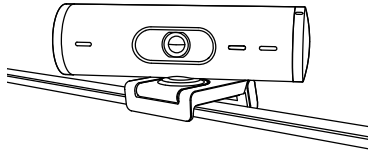

3. Sesuaikan posisi webcam dengan menggerakkannya ke samping lalu memiringkannya ke atas dan ke bawah guna menemukan framing terbaik untuk video meeting Anda.



LANGKAH 6: KONEKSI BERHASIL

Lampu aktivitas LED akan menyala ketika webcam digunakan oleh sebuah aplikasi video.

Lampu aktivitas LED:

- Video ON/Audio ON: Putih 
- Video ON/Audio OFF: Putih 
- Video OFF/Audio ON: Kuning 
- Video OFF/Audio OFF: Tidak ada cahaya 
- Pembaruan Firmware: Breathing Lilac 

LANGKAH 7: SHOW MODE

Dengan mudah menampilkan benda fisik dalam video call dengan memiringkan kamera ke bawah untuk menampilkan sketsa, objek, dan pekerjaan yang sedang dikerjakan. Ada dua cara untuk menggunakan Show Mode:

1. **Jika mount sudah terpasang kokoh dengan micro-suction pad:** Dengan menggunakan satu tangan, miringkan kamera ke bawah untuk menampilkan desktop Anda, dan miringkan kembali ke atas untuk menampilkan diri Anda sendiri.

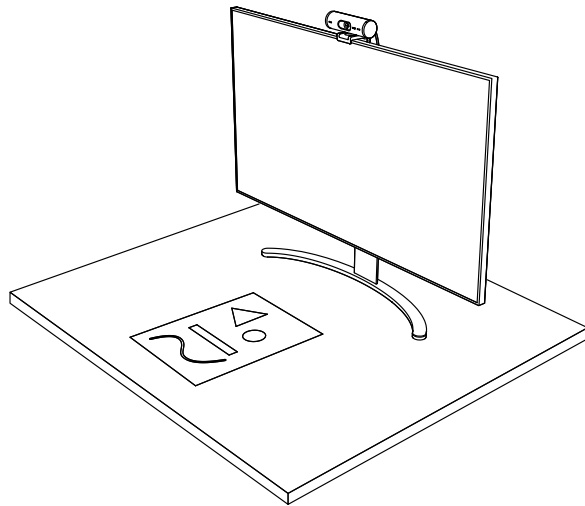

2. **Jika mount tidak terpasang kokoh dengan micro-suction pad:** Pegang mount masih dengan satu tangan dan miringkan kamera ke atas atau ke bawah dengan tangan lainnya.

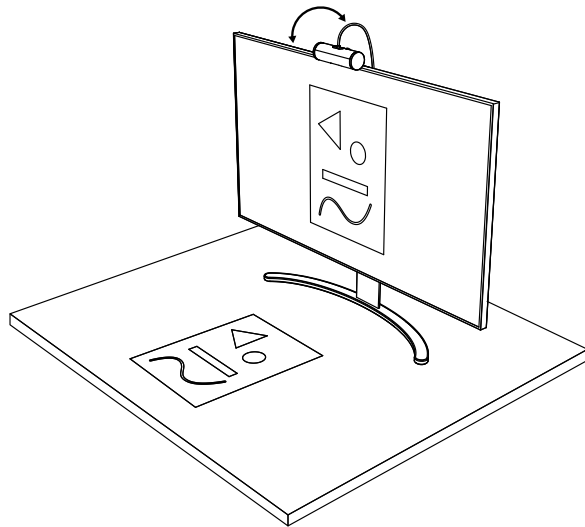

LANGKAH 8: LOGI TUNE

Logi Tune membantu meningkatkan kinerja webcam Anda dengan pembaruan software dan firmware secara berkala.

Disarankan untuk memperbarui webcam Anda. Untuk melakukan hal ini, download Logi Tune dari www.logitech.com/tune



www.logitech.com/tune

OPSI YANG DAPAT DISESUAIKAN

- Show Mode
- Auto-framing
- Penyesuaian zoom
- Bidang Pandang (90°/78°/65°)
- Penyesuaian gambar
- Auto-focus
- Nonaktifkan mikrofon
- LED on/off untuk video dan audio

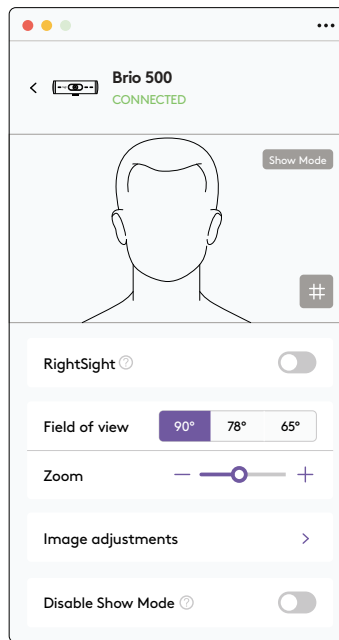

LANGKAH 9: (OPSIONAL) PASANG DI TRIPOD

Untuk penempatan di atas tripod
(tidak disertakan)

1. Putar berlawanan arah jarum jam untuk melepaskan sekrup pemasangan dari bagian bawah webcam.

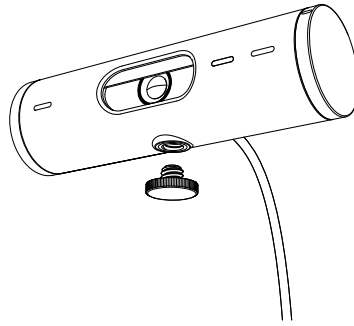

2. Cari ulir tripod ¼ inci di bagian bawah universal mounting clip.

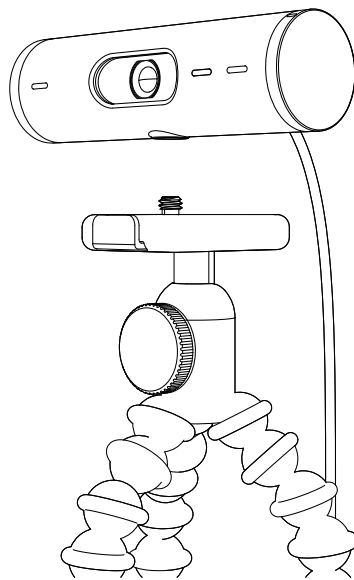

3. Pasangkan webcam di tripod Anda dengan memutarinya pada ulir ¼ inci.
4. Ulangi langkah penyiapan penempatan monitor agar bisa menggunakan webcam Anda dengan sebaik mungkin.
5. Lihat langkah 5 dan 6 untuk menyelesaikan pemasangan webcam Anda.

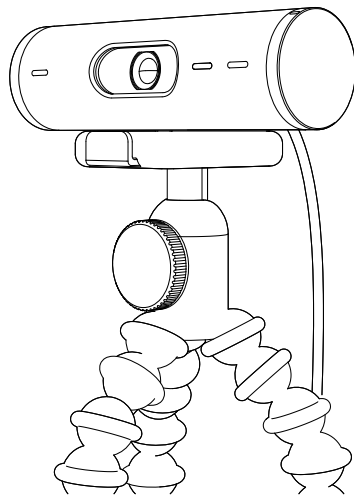

DIMENSI

WEBCAM:

Tinggi x Lebar x Tebal:

1,2 inci (31,5 mm) x 4,3 inci (110 mm) x 1,2 inci (31,5 mm)

Tinggi x Lebar x Tebal (termasuk mount clip):

2 inci (51,5 mm) x 4,3 inci (110 mm) x 1,8 inci (45 mm)

Berat: 4,2 oz (121 g), termasuk mount clip & kabel

Panjang Kabel yang Terpasang: 5 kaki (1,5 inci)

MOUNTING CLIP:

Tinggi x Lebar x Tebal:

1 inci (25 mm) x 1,8 inci (45,8 mm) x 2,6 inci (65,1 mm)

Berat: 1,4 oz (40 g), termasuk mount adapter yang dapat dilepas

www.logitech.com/support/Brio500

© 2022 Logitech. Logitech, Logi, dan logo Logitech adalah merek dagang atau merek dagang terdaftar Logitech Europe S.A. dan/atau afiliasinya di AS dan negara lainnya. Tanda kata dan logo *Bluetooth*® adalah merek dagang terdaftar yang dimiliki oleh Bluetooth SIG, Inc. dan setiap penggunaan tanda tersebut oleh Logitech sudah sesuai dengan lisensinya. *USB-C* adalah merek dagang terdaftar dari USB Implementers Forum. Semua merek dagang lain adalah properti dari setiap pemilik merek terkait. Logitech tidak bertanggung jawab atas setiap kesalahan yang terjadi akibat manual ini. Informasi di dalam manual ini dapat berubah sewaktu-waktu tanpa pemberitahuan.

WEB-621-002251 002