

**MIDDLE
ATLANTIC**
A brand of **legrand**



NEXSYS™

Line Interactive UPS User Manual

100-00072 Rev A





©2021 | [Legrand AV, Inc.](#) All rights reserved.

Information in this document is subject to change without notice. The AV equipment described in this document is furnished under a license agreement or nondisclosure agreement. The equipment may be used or copied only in accordance with the terms of those agreements. No part of this publication may be reproduced, stored in a retrieval system, or transmitted in any form or any means electronic or mechanical, including photocopying and recording for any purpose other than the purchaser's personal use without the written permission of Legrand AV.

Middle Atlantic Products is a brand of Legrand AV

[legrandav.com](#) | Phone: (866) 977-3901 | Fax: (877) 894-6918 | Email: av.middleatlantic.techsupport@legrand.com

Visit us at [legrandav.com](#) for firmware updates, specifications, drawings, manuals, technical support information, and more.

Middle Atlantic Products is a registered trademark of Legrand AV, Inc.

All other brand names or marks are used for identification purposes and are trademarks of their respective owners.

All patents are protected under existing designations. Other patents pending.

Legrand AV Inc. Brands: Chief | Da-Lite | Middle Atlantic Products | Projecta | Sanus | Vaddio

Table of Contents

Important Safety Instructions	4
Instructions Importantes Sur La Sécurité.....	7
Supplied Components and Hardware.....	12
Required Tools	12
Introduction.....	13
Charging Your UPS the First Time	13
Determining Your Equipment Power Requirements	14
Understanding UPS Installation Requirements	14
Installing the UPS Inside of Your Enclosure	15
Communicating with Your UPS	18
Disabling and Enabling the UPS Emergency Power Off (EPO) Function	19
Connecting the Expandable Runtime Battery Option	20
Basic Operation and Feature Set	24
Understanding the UPS Power Button	37
Replacing the Battery	38
Replacing the Power Cord (if Necessary).....	40
Troubleshooting.....	41
Specifications	43
System Function Block Diagram.....	49
Warranty.....	50

Important Safety Instructions

Comply with all warnings and operating instructions in this manual and save them for future reference. Do not operate this unit before carefully reading through all safety information and operating instructions.

Understanding Safety Symbols



**DANGER
HAZARDOUS
VOLTAGE**

The lightning flash with the arrowhead symbol, within an equilateral triangle is intended to alert the user to the presence of uninsulated dangerous voltage within the product's enclosure that may be of sufficient magnitude to constitute a risk of electric shock to persons.



WARNING

A warning alerts you to a situation that could result in serious personal injury or death.



CAUTION

A caution alerts you to a situation that may result in minor personal injury or damage to the product and/or property.



NOTE

A note is used to highlight procedures pertaining to the installation, operation, or maintenance of the product.

Transportation and Storage



Transport the UPS system only in the original package to protect against shock and impact.



The UPS must be stored in a ventilated and dry room.

Preparation



Condensation may occur if the UPS system is moved directly from cold to warm environments. The UPS system must be absolutely dry before being installed. Please allow at least two hours for the UPS system to adjust to the environment.



Do not install the UPS system near water or in damp environments.



Do not install the UPS system where it would be exposed to direct sunlight or near a heater.



Do not block ventilation holes on the UPS housing.

Installation





Do not connect appliances or devices to the UPS output sockets or terminal that would over load the UPS.





Place cables in such a way that no one can step on or trip over them.

 Do not connect domestic appliances such as hair dryers to UPS output sockets.

 Connect the UPS system only to a grounded, shockproof outlet, which must be easily accessible and close to the UPS system.

 Use only a VDE-tested, CE-marked (or UL-marked for 100/110/115/120/127 Vac models) mains cable (e.g., the mains cable of your computer) to connect the UPS system to the building wiring outlet (shockproof outlet).

 Use only VDE-tested, CE-marked (or UL-marked for 100/110/115/120/127 Vac models) power cables to connect the loads to the UPS system.

 When installing the equipment, ensure that the sum of the leakage current of the UPS and the connected devices does not exceed 3.5mA.

 Temperature Rating: Units are considered acceptable for use in a maximum ambient environment of 104°F (40°C).

 For Pluggable Equipment: The socket-outlet shall be installed near the equipment and shall be easily accessible.

 The unit is heavy. Lifting the unit requires a minimum of two people.

Operation

 Do not disconnect the ground conductor cable on the UPS or the building wiring terminals at any time since this would cancel the protective earth of the UPS system and of all connected loads.

 The UPS system features its own, internal current source (batteries), therefore, the UPS output sockets or output terminal blocks may be electrically live even if the UPS system is not connected to the building wiring outlet.

 In order to fully disconnect the UPS system, first press the “OFF” button, and then disconnect the mains.

 Ensure that no liquid or other foreign objects can enter into the UPS system.

 The EPO, RS-232 and USB circuits are an IEC 60950-1 safety extra low voltage (SELV) circuit. This circuit must be separated from any hazardous voltage circuits by reinforced insulation.

Maintenance, Service and Faults

 The UPS system operates with hazardous voltages. Repairs may be carried out only by qualified maintenance personnel.

 Risk of electric shock. Even after the unit is disconnected from the mains (building wiring outlet); components inside the UPS system are still connected to the battery and are electrically live and dangerous.



Before performing any service and/or maintenance, disconnect the batteries and verify that no current is present and no hazardous voltage exists on the terminals of the high capability capacitor, such as BUS-capacitors.



Only persons are adequately familiar with batteries and with the required precautionary measures may replace batteries and supervise operations. Unauthorized persons must be kept well away from the batteries.



Risk of electric shock. The battery circuit is not isolated from the input voltage. Hazardous voltages may occur between the battery terminals and the ground. Before touching, please verify that no voltage is present.



Do not dispose of batteries in a fire. The batteries may explode.



Do not open or mutilate batteries. Released electrolyte is harmful to the skin and eyes. It may be toxic.



Batteries may cause electric shock and have a high short-circuit current. Please take the precautionary measures specified below and any other measures necessary when working with batteries:

- Remove watches, rings, or other metal objects.
- Use tools with insulated handles.
- Wear rubber gloves and boots.
- Do not lay tools or metal parts on top of batteries.
- Disconnect charging source and load prior to installing or maintaining the battery.
- Remove battery grounds during installation and maintenance to reduce likelihood of shock. Remove the connection from ground if any part of the battery is determined to be grounded.



When changing batteries, install the same number and same type of batteries or battery packs.



For UPS with internally mounted battery:

- Instructions shall have sufficient information to enable the replacement of the battery with a suitable manufacturer and catalogue number.
- Safety instructions to allow access by Service Personnel shall be stated in the installation/service handbook.
- If batteries are to be installed by Service Personnel, instructions for interconnections, including terminal torque, shall be provided.



Do not attempt to dispose of batteries by burning them. This could cause an explosion.



Do not open or destroy batteries. Escaping electrolyte can cause injury to the skin and eyes. It may be toxic.



Only replace the fuse with the same type and amperage to avoid fire hazards.



Do not disassemble the UPS system.



This equipment has been tested and found to comply with the limits for a Class A digital device, pursuant to part 15 of the FCC Rules. These limits are designed to provide reasonable protection against harmful interference when the equipment is operated in a commercial environment. This equipment generates, uses, and can radiate radio frequency energy and, if not installed and used in accordance with the instruction manual, may cause harmful interference to radio communications. Operation of this equipment in a residential area is likely to cause harmful interference in which case the user will be required to correct the interference at his own expense.



Changes or modifications not expressly approved by the party responsible for compliance could void the user's authority to operate the equipment.



This is a product for commercial and industrial applications. In second environment installations, restrictions or additional measures may be needed to prevent disturbances.

Industry Canada (IC)

ICES-003 Class A Notice. This Class A digital apparatus complies with Canadian ICES-003.

Waste Electrical and Electronic Equipment (WEEE) Directive



Correct disposal of this product: This symbol indicates that this product must not be disposed of with household waste, according to the WEEE Directive (2012/19/EU) and your national law. This product should be taken to a collection center licensed for the recycling of waste electrical and electronic equipment (EEE). The mishandling of this type of waste could have a possible negative impact on the environment and human health due to potentially hazardous substances that are generally associated with EEE. At the same time, your cooperation in the correct disposal of this product will contribute to the efficient use of natural resources. For more information about where you can take your waste equipment for recycling, please contact your local city office or your household waste collection service.

Instructions Importantes Sur La Sécurité

Respectez tous les avertissements et consignes d'utilisation de ce manuel et conservez-le pour référence ultérieure. Ne faites pas fonctionner cet appareil avant de lire attentivement toutes les informations de sécurité et les instructions d'utilisation.

Comprendre Les Symboles De Sécurité



DANGER TENSION DANGEREUSE

Le symbole de la pointe de flèche, dans un triangle équilatéral, est destiné à alerter l'utilisateur sur la présence de tension dangereuse non isolée dans l'enceinte du produit qui peut être d'une ampleur suffisante pour constituer un risque d'électrocution.



AVERTISSEMENT

Un avertissement vous avertit d'une situation pouvant entraîner des blessures graves ou la mort.

**ATTENTION**

Une attention vous avertit d'une situation pouvant entraîner des blessures mineures ou des dommages au produit et/ou à la propriété.

**REMARQUE**

Une remarque est utilisée pour mettre en évidence les procédures relatives à l'installation, au fonctionnement ou à l'entretien du produit.

Transport et stockage



Transportez le système UPS uniquement dans son emballage d'origine pour le protéger contre les chocs.



L'onduleur doit être stocké dans une pièce ventilée et sèche.

Préparation



De la condensation peut se produire si le système UPS est directement déplacé d'un environnement froid à un environnement chaud. Le système UPS doit être absolument sec avant d'être installé. Veuillez prévoir au moins deux heures pour que le système d'ASI s'adapte à l'environnement.



N'installez pas l'onduleur à proximité d'eau ou dans un environnement humide.



N'installez pas le système UPS à un endroit exposé à la lumière directe du soleil ou à proximité d'un appareil de chauffage.



Ne bloquez pas les trous de ventilation sur le boîtier de l'onduleur.

Installation



Ne connectez pas de périphériques à la sortie de l'onduleur ou à un terminal susceptible de surcharger l'onduleur.



Placez les câbles de manière à ce que personne ne puisse marcher dessus ou trébucher dessus.



Ne connectez pas d'appareils domestiques tels que des sèche-cheveux aux prises de sortie de l'ASI.



Ne connectez le système ASI qu'à une prise de terre protégée contre les chocs, qui doit être facilement accessible et proche du système ASI.



Utilisez uniquement un câble d'alimentation certifié VDE, marqué CE (par exemple, le câble d'alimentation de votre ordinateur) pour connecter le système UPS au câblage du bâtiment sortie (sortie antichoc).



Utilisez uniquement des câbles d'alimentation VDE, marqués CE pour connecter les charges au système UPS.



Lors de l'installation de l'équipement, assurez-vous que la somme du courant de fuite de l'onduleur et des périphériques connectés ne dépasse pas 3.5 mA.



Température nominale: Les unités sont considérées acceptables pour une utilisation dans un environnement ambiant maximal de 40°C (104°F).



Pour les équipements enfichables: La prise de courant doit être installée près de l'équipement et doit être facilement accessible.



L'unité est lourde. Le levage de l'unité nécessite un minimum de deux personnes.

Fonctionnement



Ne déconnectez pas le câble du conducteur de mise à la terre de l'onduleur ou des bornes de câblage du bâtiment car cela annulerait la mise à la terre de protection de l'onduleur et de toutes les charges connectées.



Le système ASI dispose de sa propre source de courant interne (batteries). Par conséquent, les prises de sortie ou les borniers de sortie de l'ASI peuvent être sous tension même si le système ASI n'est pas connecté à la sortie du bâtiment.



Pour déconnecter complètement le système UPS, appuyez d'abord sur le bouton "OFF", puis débranchez le secteur.



Assurez-vous qu'aucun liquide ou autre corps étranger ne puisse pénétrer dans le système ASI.



Les circuits EPO, RS-232 et USB sont des circuits de très basse tension de sécurité (TBTS) CEI 60950-1. Ce circuit doit être séparé de tout circuit de tension dangereux par une isolation renforcée.

Maintenance, Service et Défauts



Le système UPS fonctionne avec des tensions dangereuses. Les réparations ne peuvent être effectuées que par du personnel de maintenance qualifié.



Risque de choc électrique. Même après que l'appareil est déconnecté du secteur (prise de câblage du bâtiment); les composants à l'intérieur du système UPS sont toujours connectés à la batterie et sont sous tension et dangereux.



Avant d'effectuer toute opération de maintenance, déconnectez les batteries et vérifiez qu'il n'y a pas de courant et qu'aucune tension dangereuse n'existe sur les bornes du condensateur haute capacité, telles que les condensateurs BUS.



Seules des personnes connaissent bien les batteries et, avec les mesures de précaution requises, peuvent les remplacer et superviser les opérations. Les personnes non autorisées doivent être tenues à l'écart des batteries.



Risque de choc électrique. Le circuit de la batterie n'est pas isolé de la tension d'entrée. Des tensions dangereuses peuvent se produire entre les bornes de la batterie et le sol. Avant de toucher, vérifiez s'il n'y a pas de tension.



Ne jetez pas les piles dans un feu. Les piles peuvent exploser.



N'ouvrez pas et ne mutilez pas les piles. L'électrolyte libéré est nocif pour la peau et les yeux. Cela peut être toxique.



Les batteries peuvent provoquer un choc électrique et un courant de court-circuit élevé. Veuillez prendre les mesures de précaution suivantes et toutes les autres mesures nécessaires lorsque vous travaillez avec des batteries:

- Retirez les montres, bagues ou autres objets métalliques.
- Utilisez des outils avec des poignées isolées.
- Portez des gants et des bottes en caoutchouc.
- Ne posez pas d'outils ou de pièces métalliques sur les batteries.
- Débranchez la source de charge avant d'installer ou de maintenir la batterie.
- Retirez les masses de la batterie pendant l'installation et la maintenance afin de réduire les risques de choc. Retirez la connexion de la masse si une partie de la batterie est déterminée pour être mise à la terre.



Lorsque vous changez les piles, installez le même numéro et le même type de piles ou de batteries.



Pour onduleur avec batterie interne:

- Les instructions doivent contenir suffisamment d'informations pour permettre le remplacement de la batterie par un fabricant et un numéro de catalogue appropriés.
- Les instructions de sécurité pour permettre l'accès au personnel de service doivent être indiquées dans le manuel d'installation/d'entretien.
- Si des batteries doivent être installées par le personnel de service, des instructions pour les interconnexions, y compris le couple aux bornes, doivent être fournies.



N'essayez pas de vous débarrasser des piles en les brûlant. Cela pourrait provoquer une explosion.



Ne pas ouvrir ou détruire les piles. L'électrolyte qui s'échappe peut causer des blessures à la peau et aux yeux. Cela peut être toxique.



Ne remplacez le fusible que par le même type et le même ampérage pour éviter les risques d'incendie.



Ne démontez pas le système UPS.



Cet équipement a été testé et déclaré conforme aux limites d'un appareil numérique de classe A, conformément à la partie 15 des règles de la FCC. Ces limites sont conçues pour fournir une protection raisonnable contre les interférences nuisibles lorsque l'équipement est utilisé dans un environnement commercial. Cet équipement génère, utilise et peut émettre de l'énergie radiofréquence et, s'il n'est pas installé et utilisé conformément au manuel d'instructions, peut causer des interférences nuisibles aux communications radio. L'utilisation de cet équipement dans une zone résidentielle est susceptible de provoquer des interférences nuisibles, auquel cas l'utilisateur devra corriger les interférences à ses propres frais.



Les changements ou modifications non expressément approuvés par la partie responsable de la conformité pourraient annuler l'autorité de l'utilisateur à utiliser l'équipement.



Ceci est un produit pour les applications commerciales et industrielles. Dans les installations du deuxième environnement, des restrictions ou des mesures supplémentaires peuvent être nécessaires pour éviter les perturbations.

Industrie Canada (IC)

ICES-003 Avis NMB-003, Classe A. Cet appareil numérique de la classe A est conforme à la norme NMB-003 du Canada.

Directive sur les déchets d'équipements électriques et électroniques (WEEE)

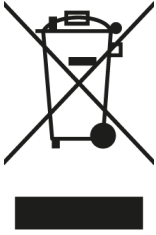

Élimination correcte de ce produit: Ce symbole indique que ce produit ne doit pas être éliminé avec les ordures ménagères, conformément à la directive WEEE (2012/19/EU) et à votre législation nationale. Ce produit doit être déposé dans un centre de collecte agréé pour le recyclage des déchets d'équipements électriques et électroniques (EEE). La mauvaise manipulation de ce type de déchets pourrait avoir un impact négatif possible sur l'environnement et la santé humaine en raison de substances potentiellement dangereuses généralement associées aux EEE. Dans le même temps, votre coopération dans l'élimination correcte de ce produit contribuera à une utilisation efficace des ressources naturelles. Pour plus d'informations sur les lieux de recyclage de vos équipements usagés, veuillez contacter votre mairie ou votre service de collecte des ordures ménagères.

Supplied Components and Hardware

After carefully opening all product packaging, identify the supplied components and hardware shown. If any pieces are missing or damaged, please report it immediately to Technical Support at av.middleatlantic.techsupport@legrand.com or (866) 977-3901. Keep the original box in a safe place for future use.

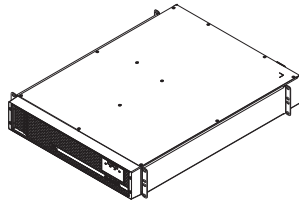

1, 1.5, or 2KVA UPS Unit
NOTE: Rails pre-installed on unit.
A

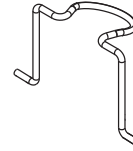

Power Cord Retainer
B

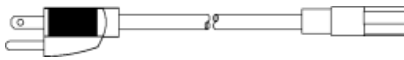

Power Cord
C

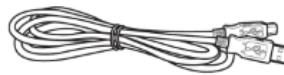

36" (914 mm) USB-B to USB-A Cable
D



RS-232 Cable
E

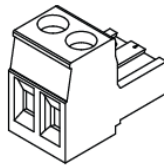

(3x)
Connector
(For EPO and Dry Contacts)
F



User Manual



NOTE To order more hardware, contact support at av.middleatlantic.techsupport@legrand.com or (866) 977-3901.

Required Tools

- #2 Phillips Screwdriver
- Electric Drill and #2 Phillips Bit (if Preferred)



WARNING

Use tools with caution and follow all safety protocols.

AVERTISSEMENT

Utiliser des outils avec prudence et suivre tous les protocoles de sécurité.

Introduction

This user manual provides information about your Line Interactive UPS (A), one of the NEXSYS power devices offered by Middle Atlantic Products. You may have purchased additional items (some sold separately) as part of your NEXSYS UPS configuration.

For information about additional UPS products that are part of the NEXSYS series, such as expandable batteries and a RackLink™ network card, to name a few, refer to their respective documents available on the NEXSYS product page at www.legrandav.com or contact support at av.middleatlantic.techsupport@legrand.com or (866) 977-3901.

Some General Specifications

For more specification details see “Specifications” on page [43](#).

Model	UPX-1000R-2 UPX-RLNK-1000R-2 UPX-RLNK-1000R-8	UPX-1500R-2 UPX-RLNK-1500R-2 UPX-RLNK-1500R-8	UPX-2000R-2 UPX-RLNK-2000R-2 UPX-RLNK-2000R-8
VA	1000VA	1500VA	2000VA
Watts	900W	1350W	1800W
Power Factor	0.9		

Understanding the One-Time UPS Transport Mode

Your UPS comes from the factory with the batteries fully charged and an enabled, one-time Transport Mode function to minimize battery discharge.

If you press the power button while the UPS is in Transport Mode, the following message appears for 10 seconds on the LCD.

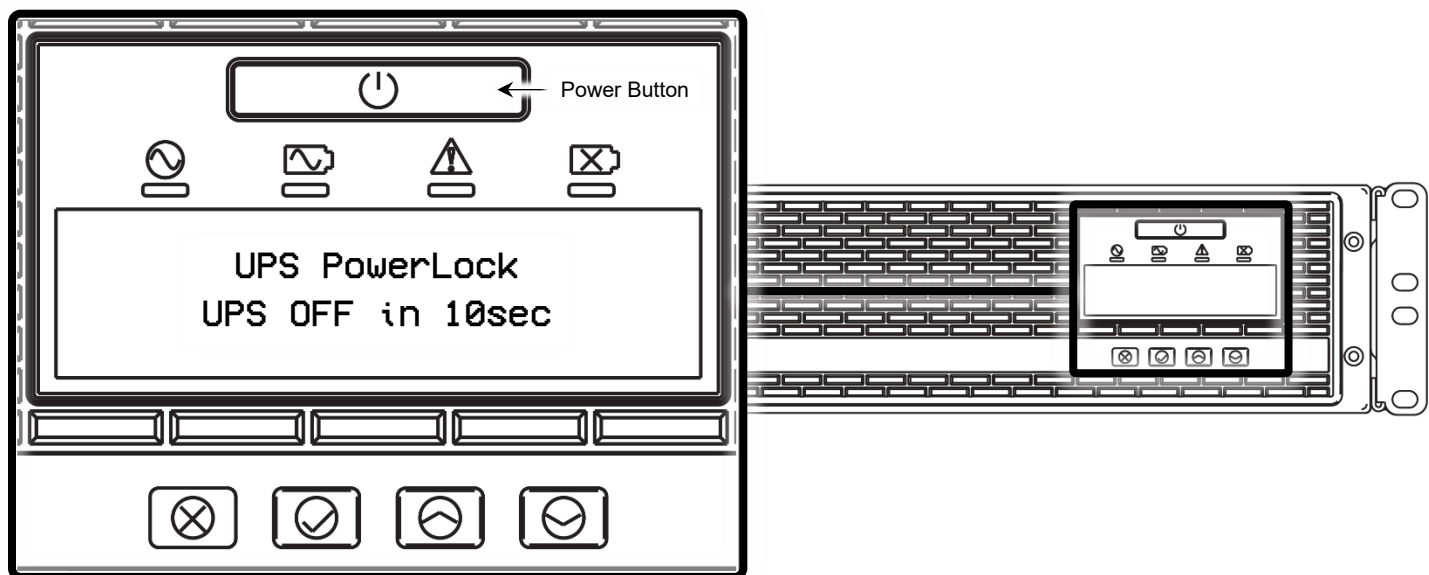

After 10 seconds, the LCD and UPS turn off.

The first time you plug your UPS into an appropriately rated receptacle using the power cord (C), the system turns off this one-time Transport Mode and the power button then functions normally. For more information, see “Understanding the UPS Power Button” on page 37.

Charging Your UPS, the First Time

You must first charge your UPS (A) for at least eight hours before it can provide direct backup power to connected devices.

Whether the UPS is turned on or off, the auto charge feature automatically charges the pre-installed, internal battery whenever the UPS is plugged directly into an appropriately rated AC power receptacle using the supplied power cord (C).



NOTE

First, use the supplied power cord (C) and directly plug your UPS into AC power and allow it to charge for eight hours before providing direct backup power to connected devices.

Determining Your Equipment Power Requirements

Ensure that the equipment plugged into the UPS (A) does not exceed its rated capacity. If they are exceeded, an overload condition may occur and cause the UPS to shut down or the circuit breaker to trip.

Many factors affect the power requirements of your electronic equipment connected to your UPS. For optimal system performance always keep the overall load of the unit below 80% of the rated capacity.

Understanding UPS Installation Requirements



NOTE

Before installing your UPS (A), carefully review the following considerations to select a proper location. Most considerations apply to Expandable Battery options (not included) as well.

1. The UPS should be placed on a flat, clean surface. Place it in an area away from vibration, dust, humidity, high temperature, flammable liquids, gases, corrosive, and conductive contaminants. Install the UPS indoors in a clean environment, where it is away from windows and doors. Maintain a minimum clearance of 3.94” (100mm) on the bottom of the UPS to avoid dust and high temperatures.
2. Maintain an ambient temperature range of 32°F (0°C) to 104°F (40°C) for optimal UPS operation.
3. Maintain a maximum altitude of 1093.61yd. (1000m) to keep the UPS within normal operation at full load. If used in high altitudes, please reduce the connected load. Altitude derating power with connected loads for UPS normal operation is listed as follows:

Altitude (Feet and Meters)		Derating Factor
3280.84	1000	1.0
4921.26	1500	0.95
6561.68	2000	0.91
8202.1	2500	0.86
9842.52	3000	0.82

**NOTE**

Derating factor values are based on density of dry air = 1.225 kg/m³ at sea level, + 59°F (15°C).

- Your UPS is equipped with a fan for thermal management. Place the UPS in a well-ventilated area and maintain a minimum clearance of 4" (100mm) in the front of the UPS, and 12" (300mm) at the back and two sides of the UPS for heat dissipation and maintenance access.

Installing the UPS Inside of Your Enclosure

**WARNING**

This procedure requires at least one additional person.

AVERTISSEMENT

Cette procédure nécessite au moins une personne supplémentaire.

- Carefully team lift your UPS (A), remove it from the packaging, and place it on an appropriate work surface.

**CAUTION**

Only lift from the sides and back of the unit and not by the front or rail sliders.

ATTENTION

Soulevez uniquement par les côtés et l'arrière de l'unité et non par le avant ou les rails.

Acceptable Lifting Points on Your UPS

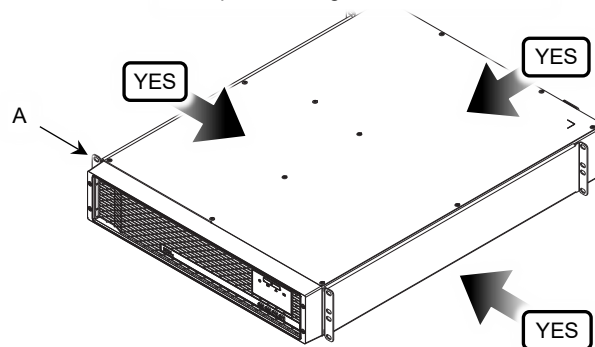

- Slide the back of each rail slider completely off the assembly.

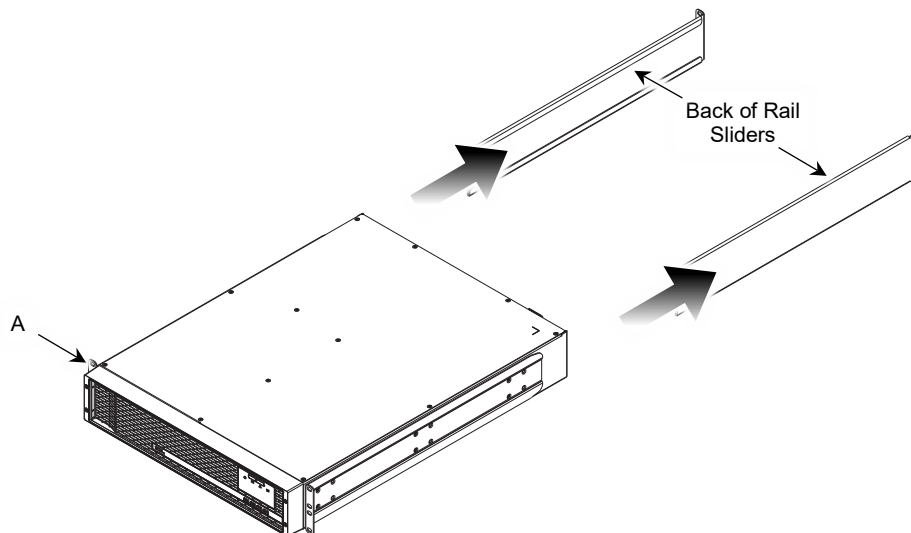

 **TIP** Installing the UPS above or below expandable batteries (or close) will simplify connectivity and cable management. Take a moment to consider where you plan to install your UPS inside your enclosure and the distance from any corresponding expandable batteries.

- Use electric drill, #2 Phillips bit, and (8x) rackscrews (not provided) to attach the ears on the back of the rail sliders to rear rackrails at the desired height inside of your enclosure.

 **WARNING** Every hole on each rail slider ear must be secured with a rackscrew (not provided).
AVERTISSEMENT Cette procédure nécessite au moins une personne supplémentaire.

NOTE:

- Rackscrews not provided.
- Front and rear rackrails on enclosure isolated for clarity.

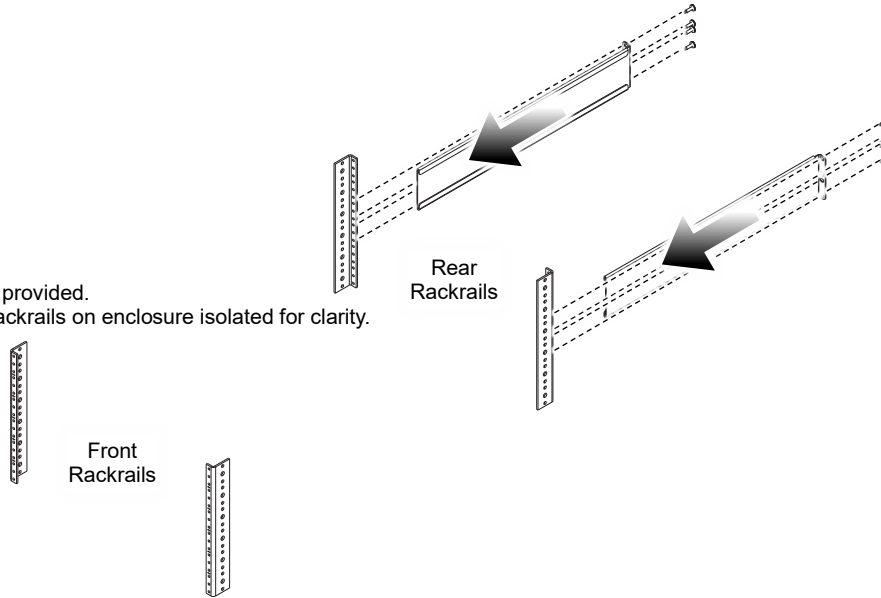

- Team lift your UPS (A) and carefully slide the front of each rail slider over the back sliders until the ears on the front rail sliders are flush with the front rackrails on your enclosure.

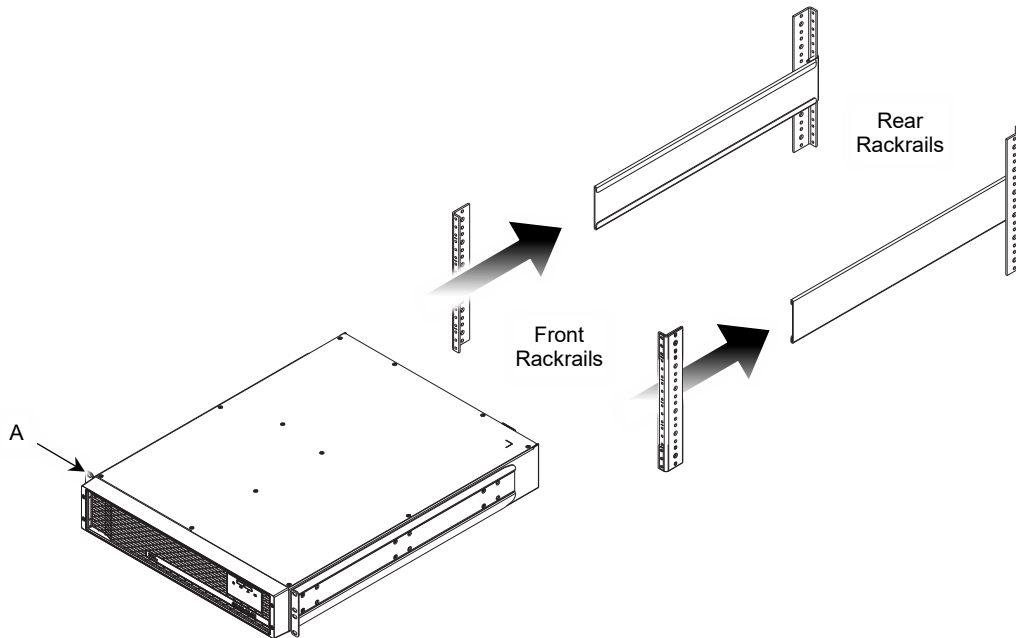

- Use electric drill and (8x) rackscrews (not provided) to attach the ears on the front rail sliders to the front rackrails on your enclosure.

	WARNING	Every hole on the ear of each rail slider must be secured with a rackscrew (not provided).
	AVERTISSEMENT	Cette procédure nécessite au moins une personne supplémentaire.

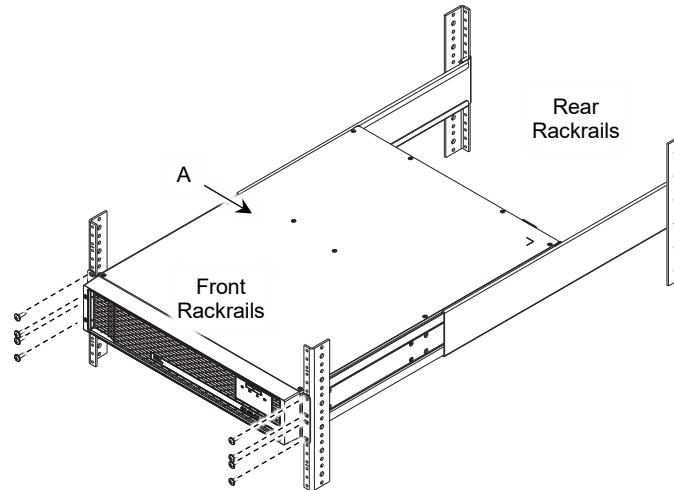

- With your UPS now secured inside of your enclosure, make cable connections as desired. For more information, see “Communicating with Your UPS” on page 18 and “Understanding Rear Panel Connections” on page 24.

	CAUTION	The power demands of devices such as laser printers, paper shredders, copiers, space heaters, vacuum cleaners, sump pumps, or other large electrical equipment are typically too high for battery and surge-protected outlet connections. Doing so will overload and possibly damage your UPS.
	ATTENTION	Les besoins en énergie d'appareils tels que les imprimantes laser, les déchiqueteuses à papier, les copieurs, les appareils de chauffage, les aspirateurs, les pompes de puisard ou d'autres gros équipements électriques sont généralement trop élevés pour se connecter à la batterie et aux prises protégées contre les surtensions. Cela surchargerait et éventuellement endommagerait votre UPS.

- If your system includes any expandable runtime battery option(s), proceed to “Communicating with Your UPS,” “Disabling and Enabling the UPS Emergency Power Off (EPO) Function,” and “Connecting the Expandable Runtime Battery Option,” starting on page 18. Otherwise, continue with the remaining steps in this topic.
- Install the power cord retainer (B) by pressing inward on its sides and hooking the ends into the posts on the back of your UPS as shown.

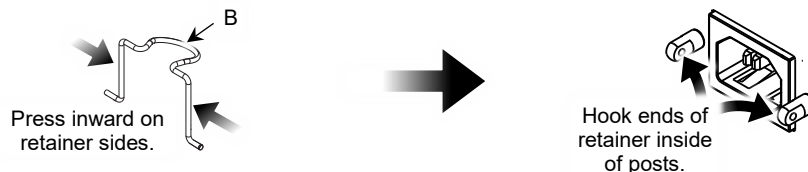

- Use the power cord (C) to connect your UPS from the AC input into an outlet on an appropriately rated receptacle.

	CAUTION	Plug the UPS power cord into a two-pole, three-wire, grounded receptacle only. Avoid using extension cords.
	ATTENTION	Branchez l'onduleur dans une prise bipolaire, trois fils et mise à la terre uniquement. Évitez d'utiliser des rallonges.

	CAUTION	The receptacle should be protected by a fuse or circuit breaker. The circuit should not be servicing other equipment with large electrical demands.
	ATTENTION	La prise doit être protégée par un fusible ou un disjoncteur. Le circuit ne doit pas entretenir d'autres équipements avec de grandes exigences électriques.

- Check the LCD panel on your UPS (A) to confirm that the site wiring fault indicator light is not lit. This light turns on when your UPS is plugged into an improperly wired receptacle.

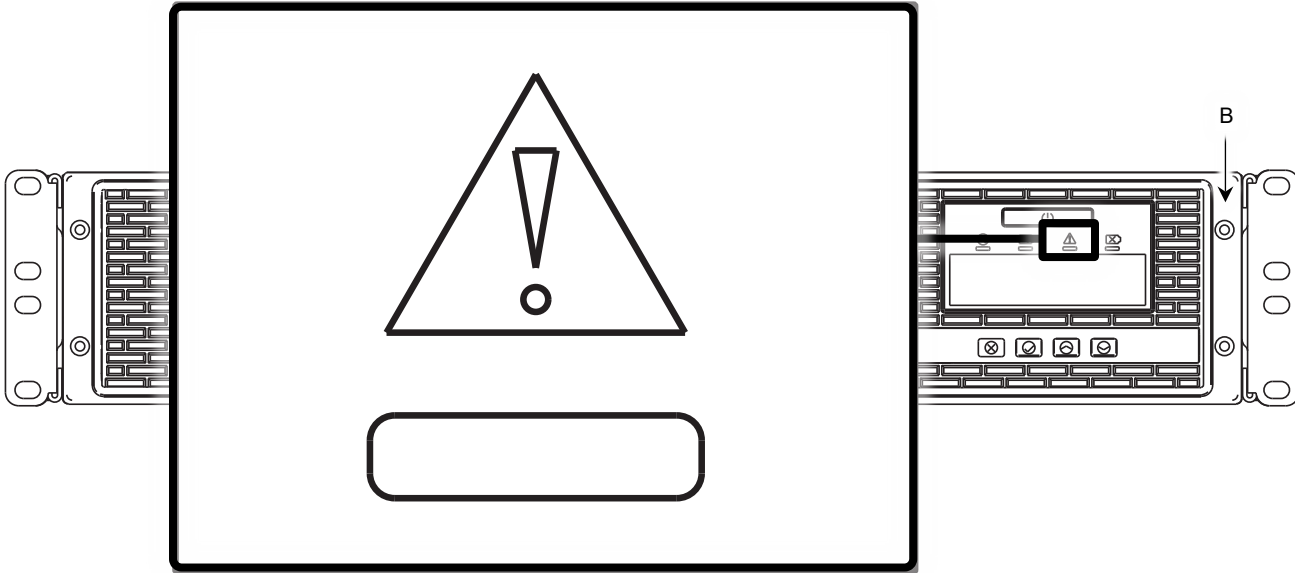

Communicating with Your UPS

Communication ports are available on the back of your UPS (A) which allow you to monitor or control your device from a desktop or laptop computer.

This may be done by direct connection using the USB-B to USB-A Cable (D), the DB9 RS-232 cable (E), or an Ethernet connection via the network card slot if you purchased a RackLink™ Network Card option. The network card option also may be used to communicate with your UPS remotely over the internet.

Serial Connections



USB Type B

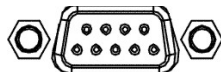

DB9 RS-232

Network Connection



Network Card Expansion Slot on UPS

For more information about communicating with your UPS over the USB-B port, refer to the NEXSYS UPS Manager Software User Manual (100-00077) at www.legrandav.com.

For more information about communicating with your UPS using a wired Ethernet connection or via wireless connection over the internet using the RackLink™ Network Card option, refer to the NEXSYS UPS RackLink Network Card User Manual (100-00074) at www.legrandav.com.

CAUTION

Disable the sleep mode function to keep your network card on regardless of your UPS power settings.

When enabled, sleep mode deactivates the network card port when the UPS is Off, the batteries are fully charged, and the LCD panel is asleep.

For more information, see "Using Main Menu > Configuration Functions > Service Mode" on page 32.

ATTENTION

Désactivez la fonction de mode veille pour garder votre carte réseau allumée quels que soient les paramètres d'alimentation de votre onduleur.

Lorsqu'il est activé, le mode veille désactive le port de la carte réseau lorsque l'onduleur est éteint, les batteries sont complètement chargées est en veille et l'écran LCD.

Pour plus d'informations, voir "Utilisation du menu principal > Fonctions de configuration > Mode service" à la page 32.

Disabling and Enabling the UPS Emergency Power Off (EPO) Function

Your UPS (A) is equipped with an EPO (emergency power off) function.

Use a connector (F) to enable the EPO function by CLOSING the contact. The UPS comes from the factory with the contact OPEN and EPO function disabled.

**NOTE**

- Images in this manual typically show a UPX-1000R-2 model to show the location of connectors, buttons, and lights on the LED panel. The locations of these items are similar on all available NEXSYS™ Line Interactive UPS models.
- The EPO connector and socket are shown in black for clarity.

For more information, see "Understanding Rear Panel Connections" on page 24.

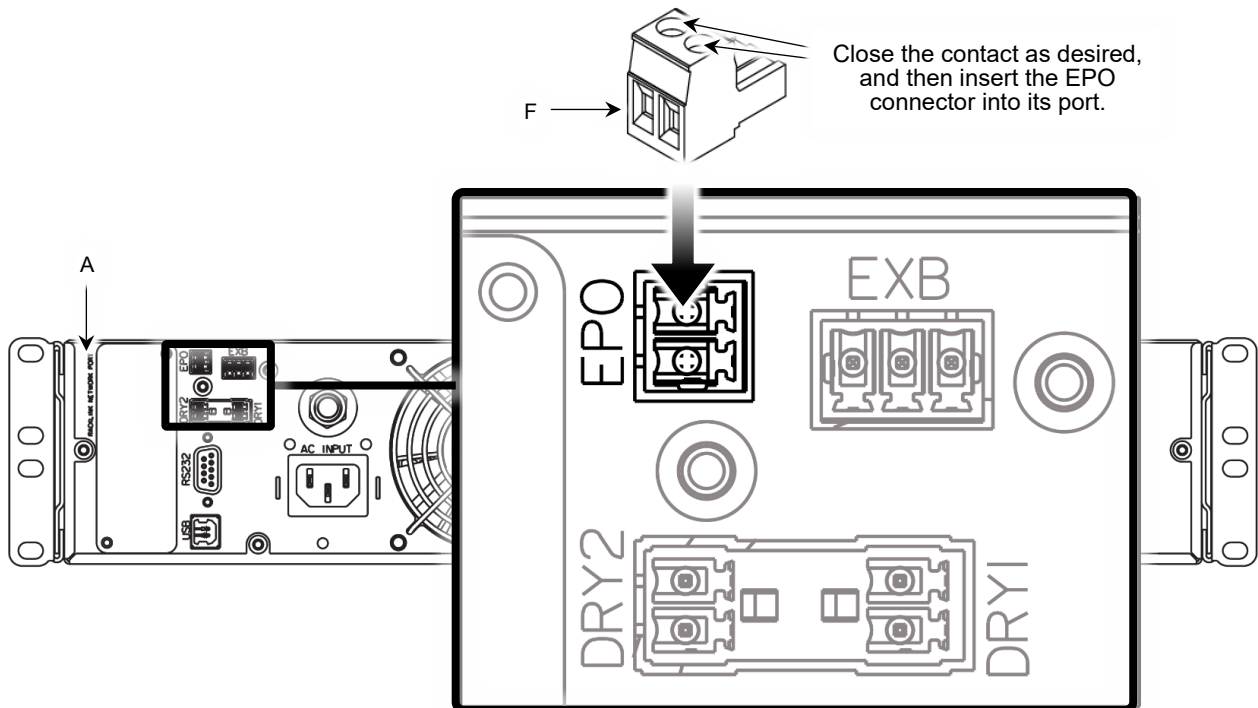

Connecting the Expandable Runtime Battery Option

An expandable runtime battery option is available for your UPS. If you purchased an expandable battery for your configuration, the following topic shows you how to properly add it to your system.



NOTE

- Up to four expandable batteries may be added to your UPS system.
- Images in this manual typically show a UPX-1000R-2 model to show the location of connectors, buttons, and lights on the LED panel. The locations of these items are similar on all available NEXSYS™ Line Interactive UPS models and corresponding options.

For information about battery replacement, see “Replacing the Battery” on page 38.

For more information, refer to the NEXSYS Line Interactive UPS Expandable Runtime Battery Option User Manual (100-00071) at www.legrandav.com.

1. Use a #2 Phillips screwdriver to remove the screw and plate covering the expandable runtime battery main connector ports on the back of both your UPS (A) and expandable runtime battery option.

Carefully set aside the screws and plates for future use.



NOTE

If you are adding exactly one expandable runtime battery to your UPS system, you may decide to leave the main connector port screw and plate intact on your expandable runtime battery, if desired.

2. Connect the end of the expandable runtime battery main connector cord into the corresponding port on the back of your UPS as shown.



NOTE

- Applicable cords, cables, and ports shown in black for clarity.
- After connecting the battery or batteries, the entire system must be charged for eight hours before providing direct backup power to connected devices. For more information, see “Charging Your UPS, the First Time” on page 13.

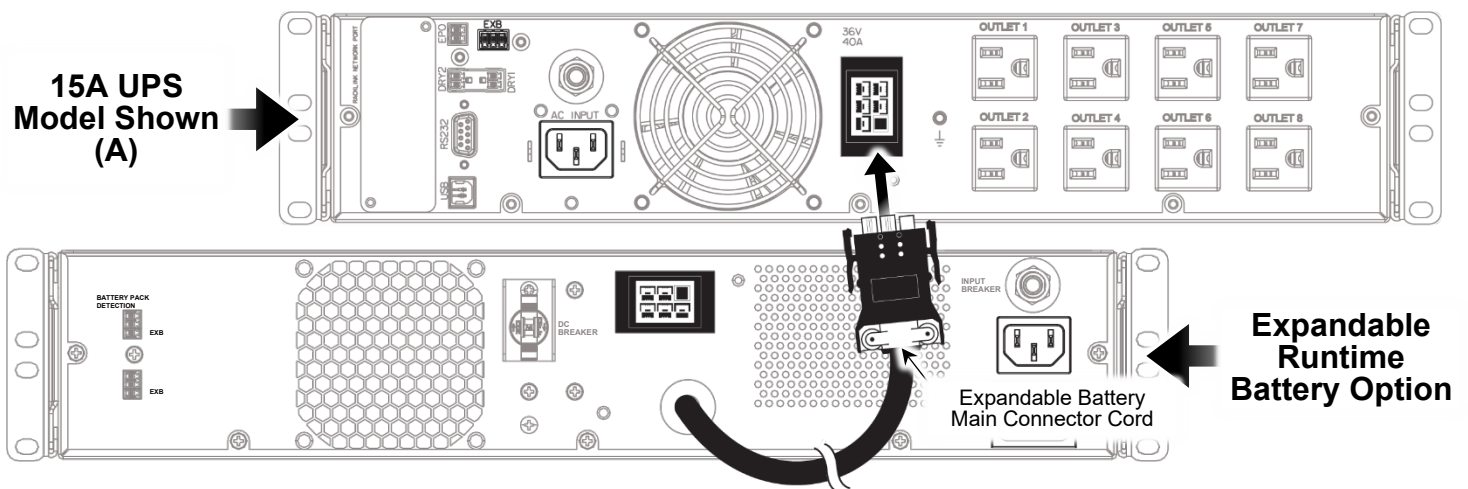

- 3. Connect one side of the expandable battery communication cable into the lower left port labeled EXB on the back of your expandable battery as shown.

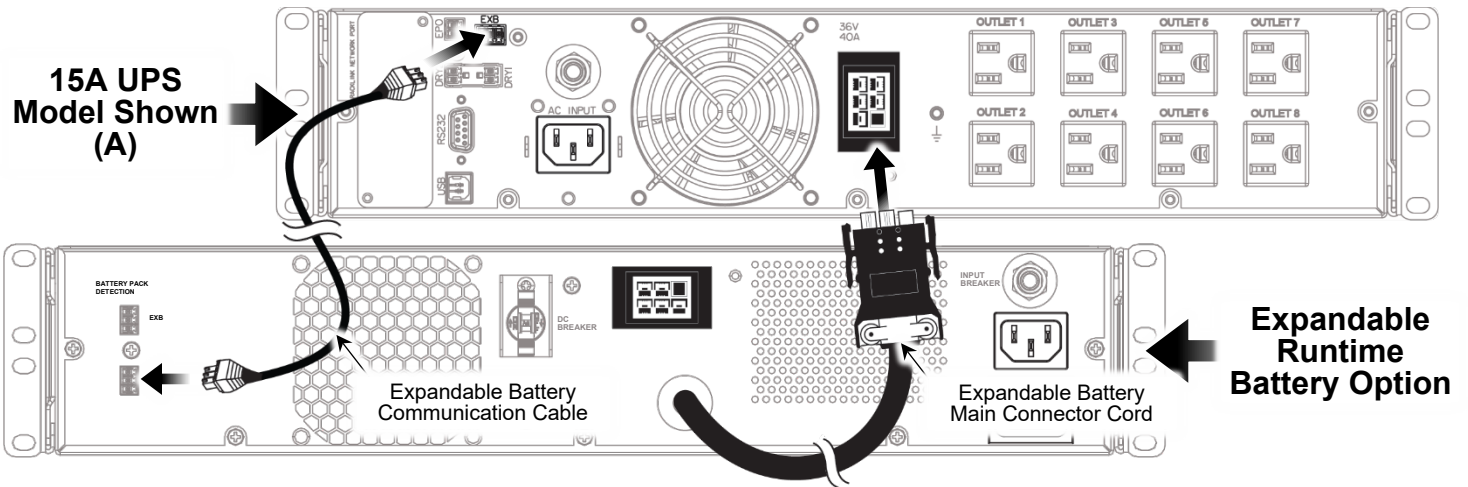

- 4. Connect the other side of the expandable battery communication cable into the port labeled EXB on the back of your UPS.

NOTE Up to four expandable runtime battery options may be added to your UPS system and should only be connected as shown.

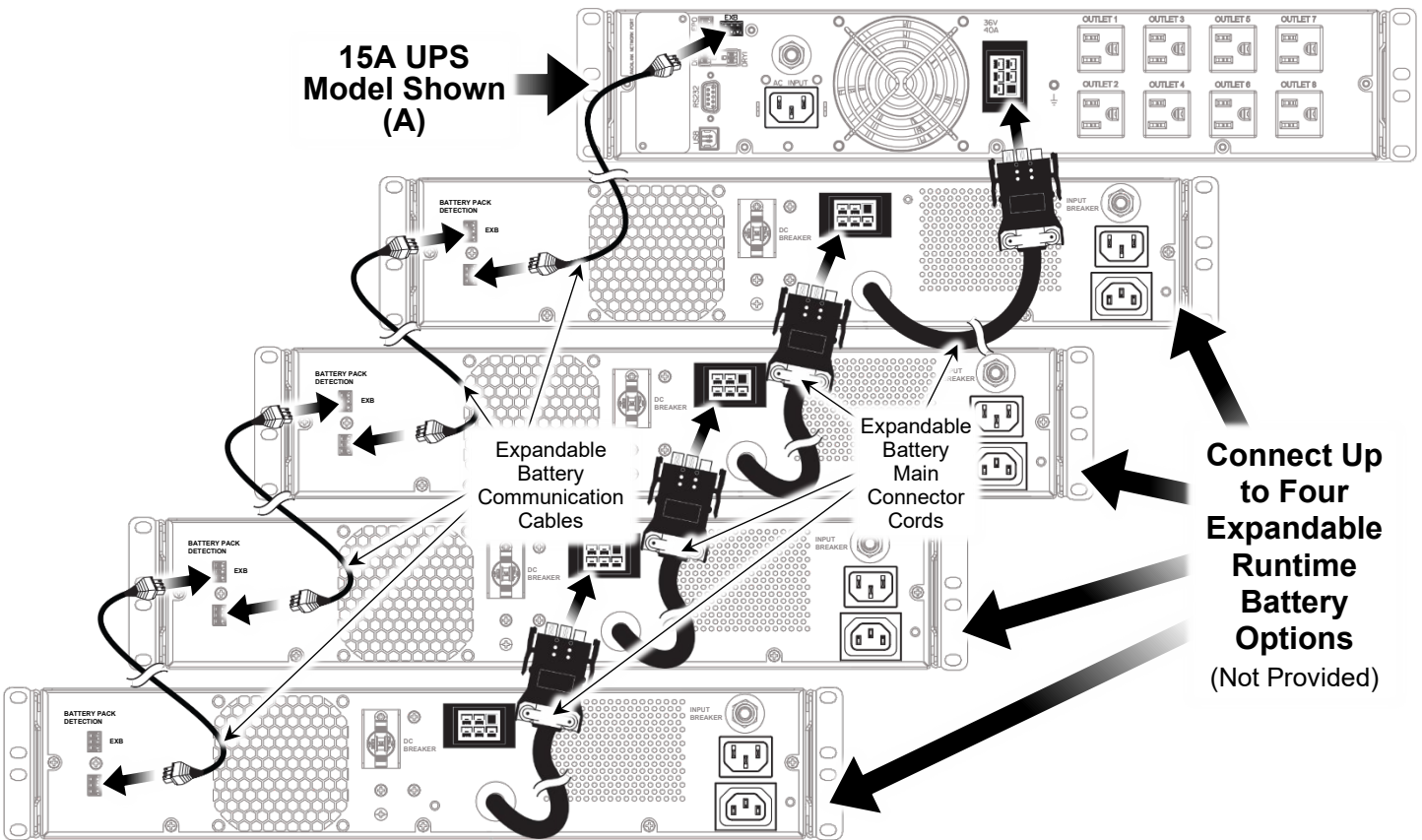

- Install the power cord retainer (B) by pressing inward on its sides and hooking the ends through the input post holes on the back of your UPS as shown.

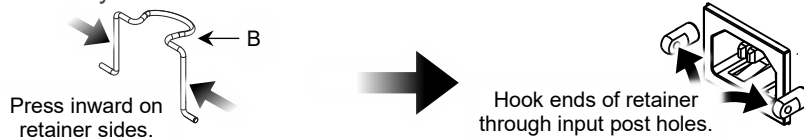

- Only use the power cord (C) provided with your UPS unit and the expandable runtime battery or batteries, and either directly connect them to appropriately rated receptacles, or daisy-chain the power to multiple batteries (where applicable) using IEC-to-IEC short cord(s) as shown.

	CAUTION	Plug the UPS power cord into a two-pole, three-wire, grounded receptacle only. Avoid using extension cords.
	ATTENTION	Branchez l'onduleur dans une prise bipolaire, trois fils et mise à la terre uniquement. Évitez d'utiliser des rallonges.

	CAUTION	The receptacle should be protected by a fuse or circuit breaker. The circuit should not be servicing other equipment with large electrical demands.
	ATTENTION	La prise doit être protégée par un fusible ou un disjoncteur. Le circuit ne doit pas entretenir d'autres équipements avec de grandes exigences électriques.

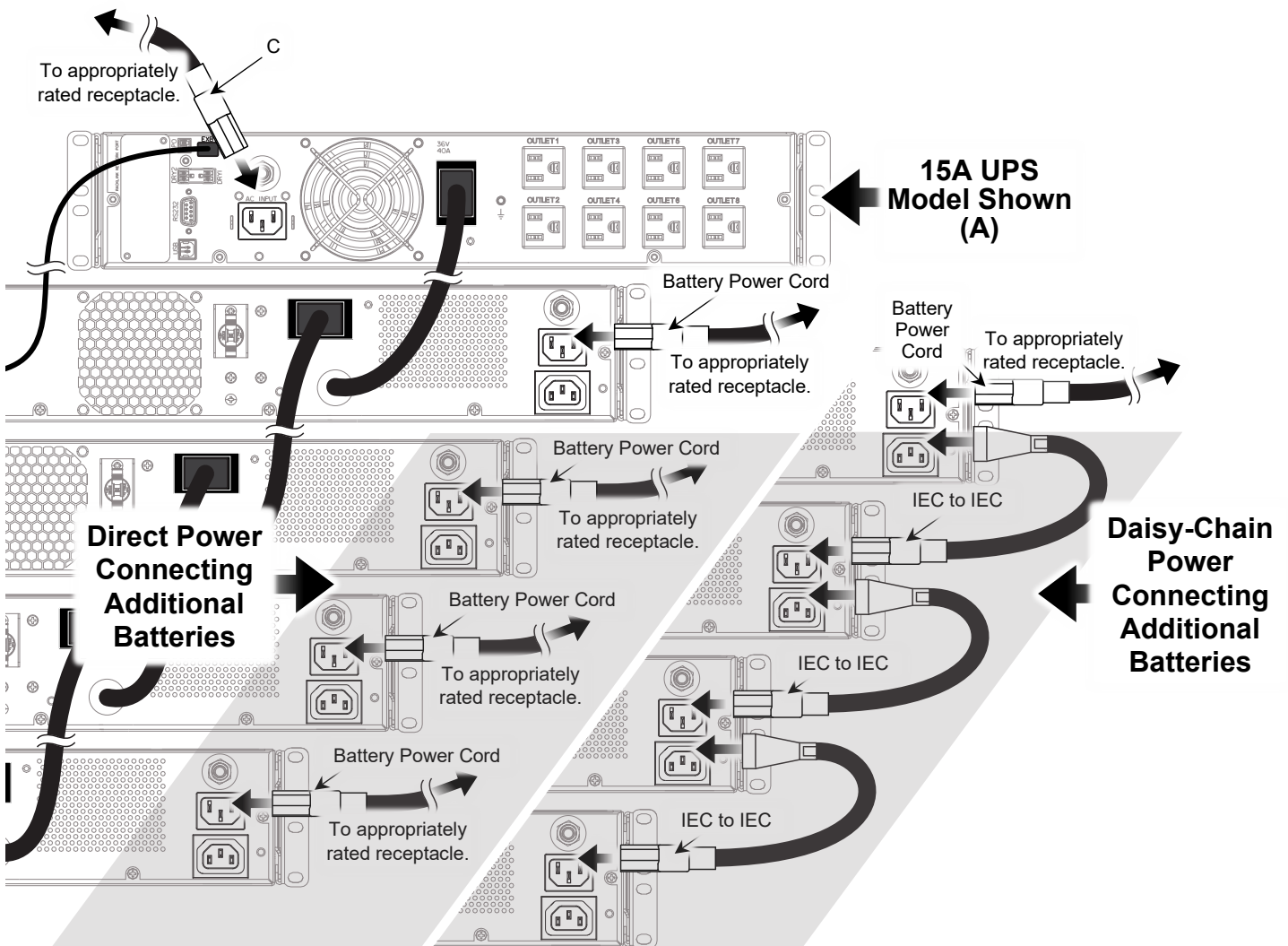

7. After making all expandable runtime battery connections to your UPS, the whole system must first be charged for at least eight hours before it can provide direct backup power to connected devices. For more information, see “Charging Your UPS, the First Time” on page 13.
8. Press the power button on the UPS to turn on the system. For more information, see “Understanding the UPS Power Button” on page 37.
9. Check the LCD panel on your UPS to confirm that the site wiring fault indicator light is not lit. This light turns on when your UPS is plugged into an improperly wired receptacle.

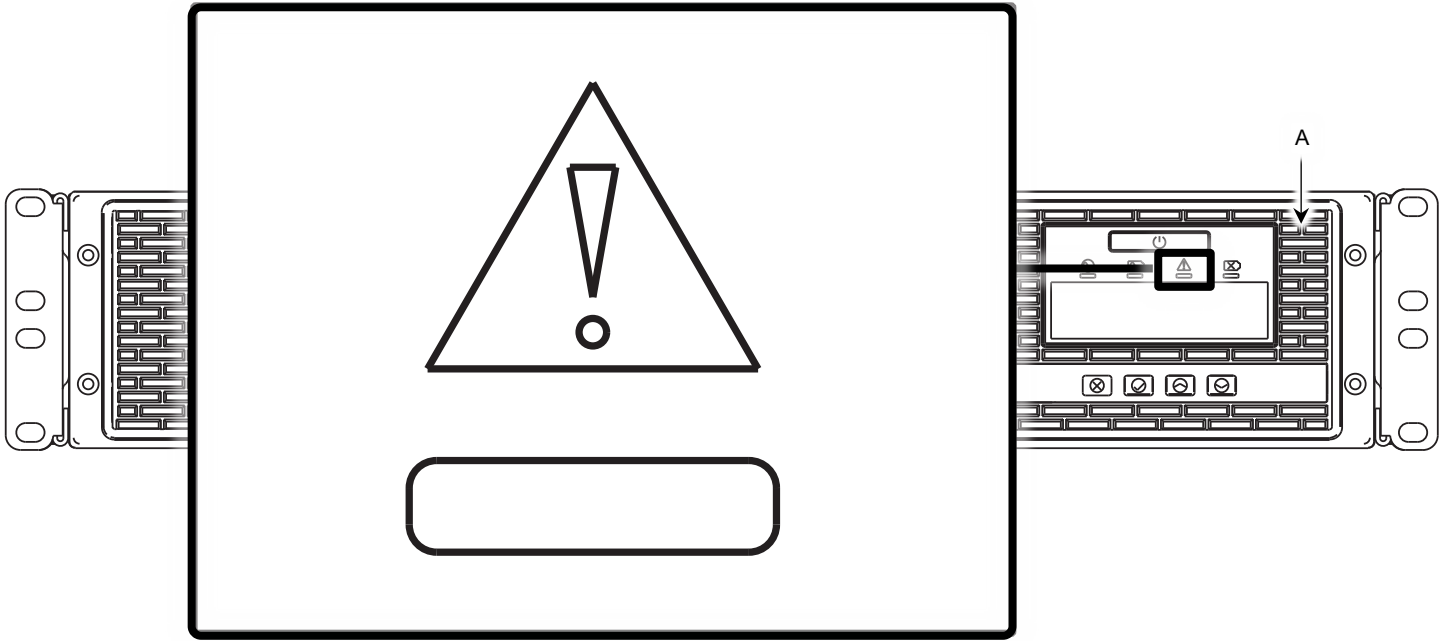

10. Navigate to **Main Menu > Configuration Functions > External Battery** on the LCD front panel of your UPS and verify the system is detecting connections in the manner you prefer.

The default setting is Auto, but you may prefer manually entering the number of external runtime batteries on your system instead.

Option	Description
External Battery 0 – 4	Set the number of external battery pack(s) attached to your UPS.
Auto	Automatically detect the number of external battery pack(s) attached to your UPS.

Basic Operation and Feature Set

Understanding Rear Panel Connections

Labels on the rear panels of different UPS models correspond with the following explanations further down.

1K and 1.5K Bank Models

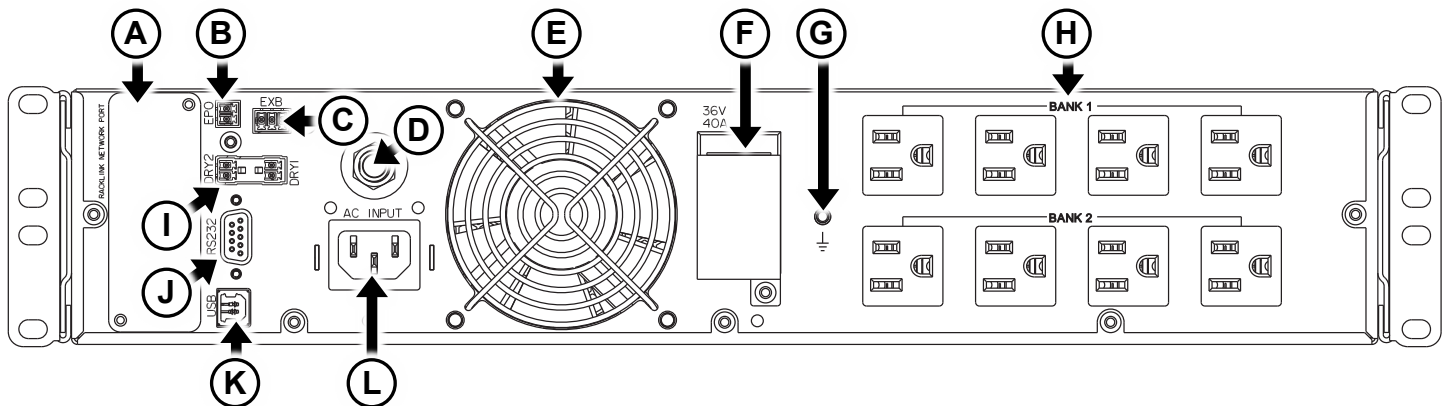

1K and 1.5K Outlet Models

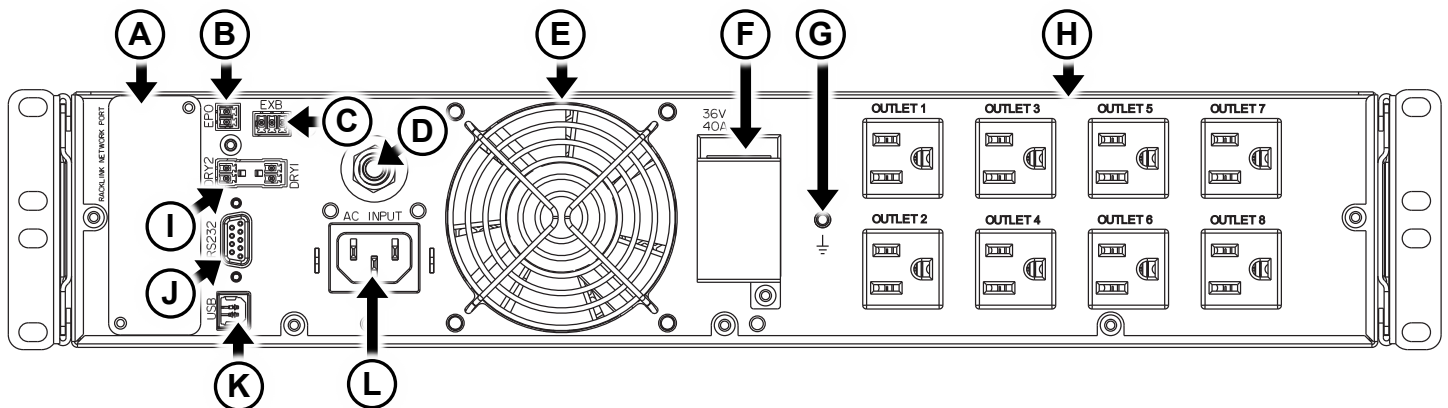

2K Bank Models

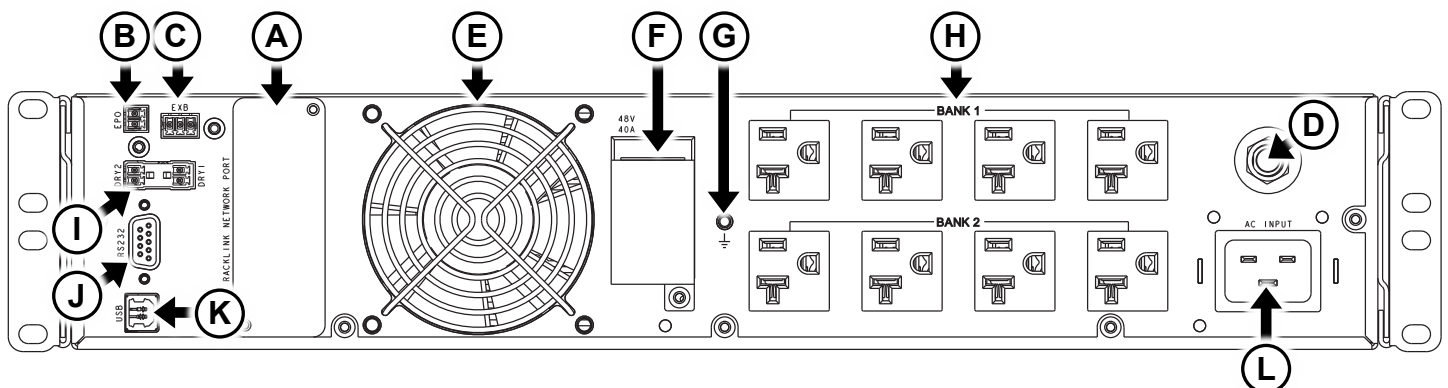

2K Outlet Models

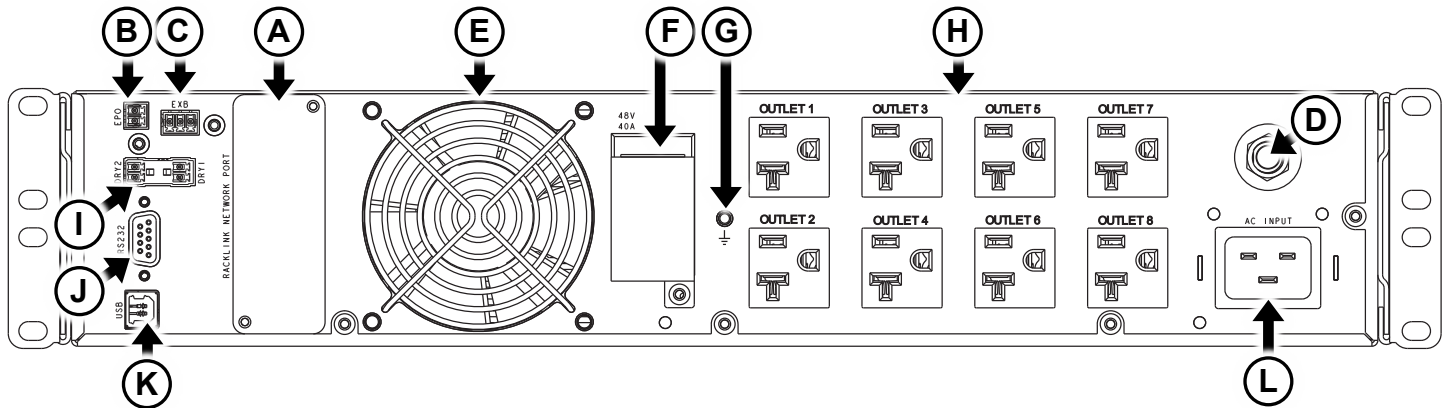

- A. **RackLink™ Network Card Port**
- B. **The Emergency Power Off (EPO) Port:** Used for UPS remote shut down control (not for telecommunication use).
- C. **The External Battery Unit Detection Port (EXB):** Automatically detects the External Battery Pack(s) for UPS estimated runtime calculations.
- D. **Input Circuit Breaker:** Located next to the AC input, the input circuit breaker trips when the load exceeds the UPS power rating.
- E. **Fan**
- F. **External Battery Port:** Port where the expandable battery main connector is inserted.
- G. **External Grounding and Bonding Stud:** Used for connecting an external ground wire to bond the chassis.
- H. **Output Receptacles:** Depending on your model, the Battery Backup output receptacles are equipped with load shedding functionality, bank-controlled outlets, or individually controlled outlets.
 - I. **Dry Contact Communication Port:** These two ports are normally OPEN. Dry 1 will close when input power is lost. Dry 2 closes when battery power is low.
- J. **RS-232 Communication Port:** Used for direct UPS monitoring and control.
- K. **USB Communication Port:** Used for direct UPS monitoring and control.
- L. **AC Input:** The inlet is IEC14 (for 15A) or IEC20 (for 20A) based on the model you purchased.

Using Front Panel Buttons and the LED Indicators

1. If you haven't done so already, your UPS (A) must first be charged for at least eight hours before it can provide direct backup power to connected devices. For more information, see "Charging Your UPS, the First Time" on page 13.
2. Press the power button on the front panel and hold it until you hear a single beep, then release, to turn on your UPS.

For more information, see "Understanding the UPS Power Button" on page 37.



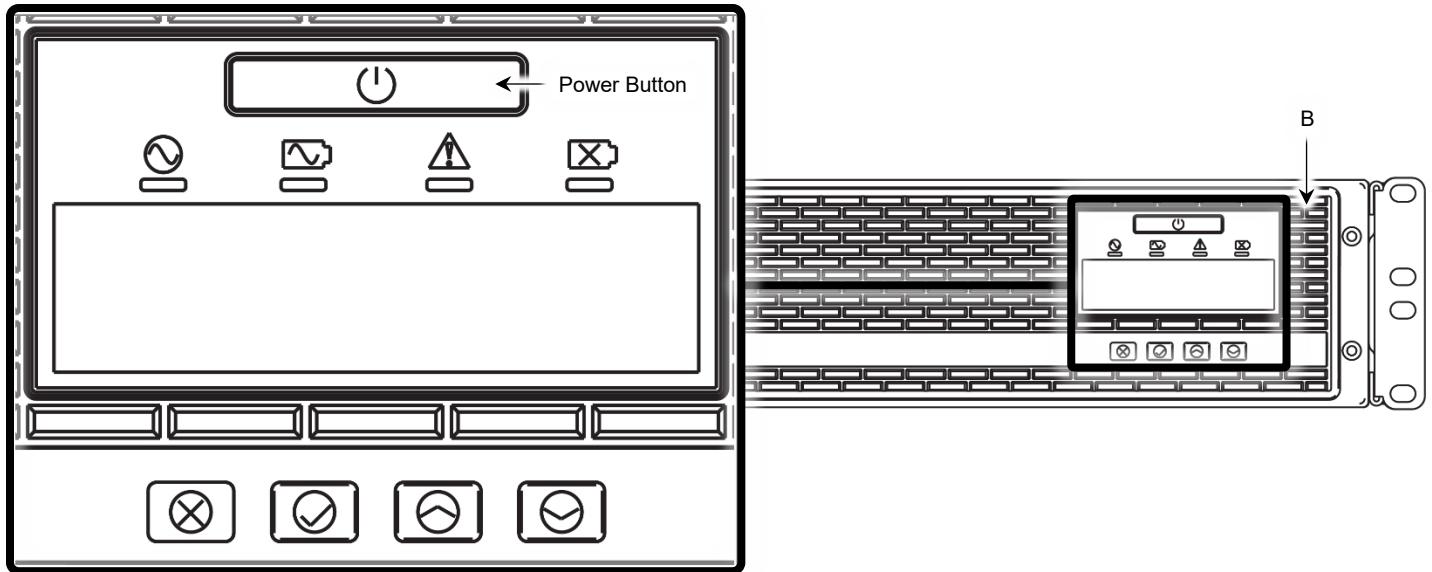

The rest of this topic to explains how use the front panel buttons and interpret the LED indicators.



LED Indicators

LED Icon	LED Icon Color or Status	Operation
	White	Your UPS is in Normal Mode.
	Flashing	Your UPS is in AVR Mode.
	Orange	Your UPS is in Battery Mode.
	Red	Your UPS has an internal fault. For more information, see "Understanding Fault Log Messages" on page 35.
	Red	Your UPS detected a weak, bad, or disconnected battery.

Front Panel Buttons

Front Panel Button	Operation
 Power	Press for approximately 1 second to turn UPS on or off. Press for approximately 4 seconds to start a manual test.
 Cancel, Back	Press to cancel or return to a previous LCD menu.
 Select	Press to select LCD menu options.
 Up Arrow	Press to scroll up the LCD menu.
 Down Arrow	Press to scroll down the LCD menu.

Understanding Your UPS Status Modes

- **Standby Mode:** In this mode, the UPS is Off, the LCD is functioning, the unit is plugged in, and your batteries are still being charged; however, no output going to the banks or outlets. You can only access the service mode and reset to default functions when your UPS is in standby mode.
- **Normal Mode:** When your UPS is in this mode the voltage from the line input (AC plug) is equal to the output voltage to the banks or outlets.
- **AVR Mode:** When your UPS input voltage is too high or low, the unit goes into this mode to properly regulate the voltage to the banks or outlets.
- **Battery Mode:** When your UPS line voltage is unacceptable and AVR mode is unable to compensate, the unit goes into battery mode.

Viewing Status Information on the LCD Panel

Use Up and Down buttons to scroll the status information for your UPS. Use the Cancel button to go back or clear any possible fault or warning notifications.

For more information, see “Front Panel Buttons” on page [27](#).



NOTE The status page list and corresponding sub-pages differ based on Bank or Outlet models.

Understanding Status Information on Bank UPS Models

Screen	Information Shown
General Page	Displays the UPS output voltage and battery general state.
Operating Mode	Displays the UPS operation Mode (Normal or Battery Mode).
Load Total	Displays the UPS total output load.
Load 1 State	Displays load 1 apparent power, current, power, Load percent.
Load 2 State	Displays load 2 apparent power, current, power, Load percent.
Battery State	Displays battery capacity and voltage.
Input Status	Displays UPS input voltage and frequency.
Output Status	Displays UPS output voltage and frequency.
Last UPS Test	Displays UPS last battery test result.
Load Bank State	Displays UPS output relay state as On or Off.
Est Runtime	Displays UPS estimate runtime.

Understanding Status Information on Outlet UPS Models

Screen	Information Shown
General Page	Displays the UPS output voltage and battery general state.
Operating Mode	Displays the UPS operation Mode (Normal or Battery Mode).
Load Total	Displays the UPS total output load.
Battery State	Displays battery capacity and voltage.
Input Status	Displays UPS input voltage and frequency.
Output Status	Displays UPS output voltage and frequency.
Last UPS Test	Displays UPS last battery test result.
Outlet Status (Screen 1)	Displays the status of the UPS outlet numbers 1, 2, 3, or 4 as either O (On) or X (Off).

Screen	Information Shown
Outlet Status (Screen 2)	Displays the status of the UPS outlet numbers 5, 6, 7, or 8 as either O (On) or X (Off).
Est Runtime	Displays UPS estimated runtime.

Operating the LCD Main Menu

	CAUTION	<p>Disable the sleep mode function to keep your network card on regardless of your UPS power settings. When enabled, sleep mode deactivates the network card port when the UPS is Off, the batteries are fully charged, and the LCD panel is asleep. For more information, see "Using Main Menu > Configuration Functions > Service Mode" on page 32.</p>
	ATTENTION	<p>Désactivez la fonction de mode veille pour garder votre carte réseau allumée quels que soient les paramètres d'alimentation de votre onduleur. Lorsqu'il est activé, le mode veille désactive le port de la carte réseau lorsque l'onduleur est éteint, les batteries sont complètement chargées est en veille et l'écran LCD. Pour plus d'informations, voir "Utilisation du menu principal > Fonctions de configuration > Mode service" à la page 32.</p>

Press the select button to enter the main menu.

	NOTE	Depending on the UPS status you are in when pressing the select button, you may have to press it again for the main menu to appear.
---	-------------	---

Use Up and Down buttons to scroll and the Cancel button to go back or clear any possible fault or warning notifications.

For more information, see "Front Panel Buttons" on page [27](#).

Menu Item	Information Shown
Configuration	Displays UPS settings that can be configured by the user.
Event Log	Displays the 3 most recent Fault and Warning event messages.
Information	Displays the UPS model and serial number, replacement battery part number, battery installation date, and the UPS firmware version. If you have a RackLink network card option installed and configured, the screen also shows the UPS name (if configured in the network card software), MAC address, IP address, and serial number.

Using Main Menu > Configuration Functions

Press the Select button to enter the configuration menu.

Use Up and Down buttons to scroll and the Select button to choose a configuration function.

For more information, see "Front Panel Buttons" on page [27](#).

Configuration Function	Available Settings and Descriptions
Audible Alarm	Setup the audible alarm on your UPS as On, Off, or Mute.
Bank/Outlet	Turn banks or outlets on your UPS On or Off.
External Battery	Setup UPS external battery packs.
Reset to Default	Resets the UPS to its factory default settings.
Service Mode	Setup UPS functions such as password, activating load shedding, changing the voltage output and sensitivity, and other items.

Using Main Menu > Configuration Functions > Audible Alarm

Press the Select button to enter the audible alarm menu.

Use Up and Down buttons to scroll and the Select button to choose from the following audible alarm options.

Alarm Option	Description
Enable	Turns On alarms as described in “Understanding Enabled or Muted Alarms” on page 30 .
Mute	Silences alarms only for the current event. After the event, alarms then will sound as described in in “Understanding Enabled or Muted Alarms” on page 30 .
Disable	Alarms are permanently silenced until set back to either Enable or Mute.

Understanding Enabled or Muted Alarms

System events trigger the following sounds when your audible alarm set to either Enabled or Mute options.

Event	Description
Battery Mode	Emitting 1 Beep every 10 seconds.
Low Battery	Emitting 2 beeps every 5 seconds.
Battery Disconnect	Emitting 3 beeps every 5 minutes.
Fault or Overload	Continuous beeping.

Using Main Menu > Configuration Functions > Bank/Outlet

Press the Select button to enter the bank or outlet menu.

Bank Models

Use Up and Down buttons to scroll. Use the Select button to choose from the following options.

Option	Description
Load Bank 1	Turn Load Bank 1 On or Off.
Load Bank 2	Turn Load Bank 2 On or Off.

Outlet Models

Use Up and Down buttons to scroll and the Select button to choose from the following options.

Option	Description
Outlet Numbers 1 – 8	Turn Outlet Numbers 1 – 8 On or Off.

Using Main Menu > Configuration Functions > External Battery

Press the Select button to enter the external battery menu.

Use Up and Down buttons to scroll and the Select button to choose from the following options.

Option	Description
External Battery 0 – 4	Set the number of external battery pack(s) attached to your UPS.
Auto	Automatically detect the number of external battery pack(s) attached to your UPS.

Using Main Menu > Configuration Functions > Reset to Default

Press the Select button to reset the UPS configuration functions to the following default parameters.

Function	Default Parameter
Audible Alarm	Set to On.
Bank/Outlet	All banks and outlets turned On.
External Battery Pack	Set to Auto detect.
Battery Replace Date	Set to 1/1/2022.
Next Battery Replacement Date	Set to 1/1/2024.
Output Voltage	Set to 120V.
Load Shedding	Set to Enabled.
Service Mode Password	Set to 0000.

Function	Default Parameter
Battery Aging Coefficient	Set to 100.
Sleep Mode	Set to Disabled.
Sensitivity	Set to Normal (with L1 and L2 both Off).
Fault and Warning Log	Set to clear notifications for either event.

Using Main Menu > Configuration Functions > Reset Batt aging coefficient

Press the Select button to enter the reset batt aging coefficient menu. Then use Up, Down, and Select buttons to choose Yes and reset the battery aging coefficient, if desired.

Function	Available Settings	Descriptions
Reset Battery Aging	Yes or No	Set the coefficient to Yes whenever you perform a battery replacement to optimize your battery runtime calculation.

Using Main Menu > Configuration Functions > Service Mode



NOTE

Service mode functions are password protected and only available when your UPS is in Standby Mode. The default password for access is 0000 as mentioned in the previous topic. The 0000 password is entered by default, and you must press the select button to verify each password character. For more information about status modes, see “Understanding Your UPS Status Modes” on page [27](#).

Press the Select button to enter the service mode menu.

Use Up and Down buttons to scroll and the Select button to choose from the following service mode functions.

Function	Available Settings	Descriptions
Output Voltage	110V, 120V, or 127V	Set the output of your UPS to one of the available voltage settings.
Load Control	Disable or Enable	When load control is enabled, you can turn the bank or outlets On or Off from the LCD screen, or from direct or remote connections. When disabled, all bank and outlets are locked in their current state.
Password Setup	0000 – 9999	Select a four-digit password from 0000 – 9999 used when accessing and modifying service mode function settings.

Function	Available Settings	Descriptions
<p>Sleep Mode</p>	<p>Disable or Enable</p>	<p>When enabled, sleep mode deactivates the network card port when the UPS is Off, the batteries are fully charged, and the LCD panel is asleep.</p> <p>With the UPS turned Off, sleep mode enabled, and the batteries fully charged, you may press any LCD panel button and the system temporarily activates the network card port until going back to sleep again.</p> <div style="border: 1px solid black; padding: 10px;"> <p>CAUTION</p> <p>Disable the sleep mode function to keep your network card on regardless of your UPS power settings. For more information, refer to "Understanding Network Access to Your UPS" in the NEXSYS UPS RackLink™ Network Card User Manual (100-00074) at www.legrandav.com or contact support at av.middleatlantic.techsupport@legrand.com or (866) 977-3901.</p> <p> ATTENTION</p> <p>Désactivez la fonction de mode veille pour garder votre carte réseau allumée quels que soient les paramètres d'alimentation de votre onduleur. Pour plus d'informations, reportez-vous à " Comprendre l'accès réseau à votre onduleur" dans le manuel d'utilisation de la carte réseau NEXSYS UPS RackLink™ (100-00074) sur www.legrandav.com ou contactez assistance à av.middleatlantic.techsupport@legrand.com ou (866) 977-3901.</p> </div>
<p>Sensitivity</p>	<p>L1 or L2</p>	<p>Select 1 or 2 as the voltage sensitivity level.</p>

Using Main Menu > Event Log Functions

Press the Select button to enter the event log menu.

The LCD screen shows the three most recent Warning and Fault log messages for a total of 6 messages. Use Up and Down buttons to scroll through the log messages which appear on the screen in the order shown below.

For more information, see “Front Panel Buttons” on page 27.

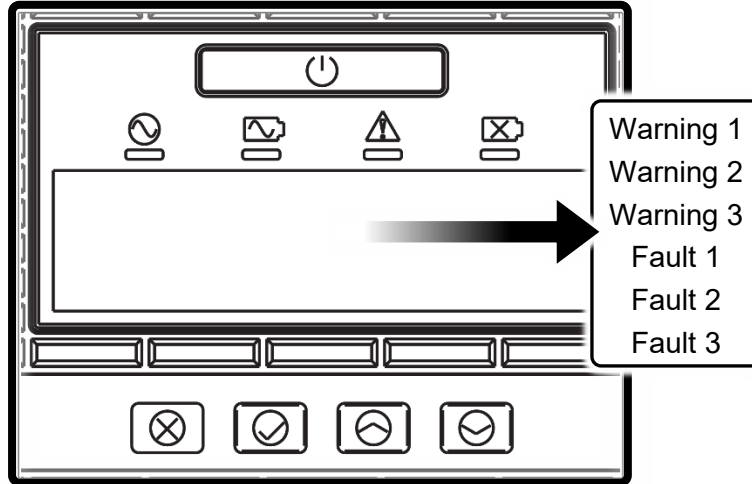

NOTE While the LCD shows the three most current Warning and Fault log messages, the following topics explain all the possible messages that could appear for each type.

Understanding Warning Log Messages

The following are all the possible warnings and corresponding messages that may or may not appear as one of the three most current when scrolling through the event logs in the LCD screen.

Warning Message Shown on LCD	Reason for Message
High Input Current - PLS Reduce Load. (over current warning)	Your UPS has a high input current and is approaching an overload threshold. The UPS will still operate; however, you must reduce the load.
UPS is overloaded.	Your UPS has already shut down or is about to shut down due to an overload condition. For more information, see “Troubleshooting” on page 41.
Low Battery – Shutdown imminent.	Your battery capacity is low, and the UPS will shut down.
Battery Depleted	The battery power of your UPS is completely depleted.
Site Wiring Fault - PLS check input connection	A site wiring fault is detected. Please check the receptacle.
Fan Failure - PLS replace fan	A fan failure has occurred. For more information, contact support at av.middleatlantic.techsupport@legrand.com or (866) 977-3901.
High Internal Temperature	Your UPS has detected a high internal temperature, will shut down, and will not allow a manual restart until an acceptable temperature range is reached.

Warning Message Shown on LCD	Reason for Message
Low Internal Temperature	Your UPS has detected a low internal temperature, will shut down, and will not allow a manual restart until an acceptable temperature range is reached.

Understanding Fault Log Messages

The following are all the possible faults and corresponding messages that may or may not appear as one of the three most current when scrolling through the event logs in the LCD screen.

Fault Message Shown on LCD	Reason for Message
Output Short Circuit	<p>A battery mode short has occurred. Disconnect all equipment connected to your UPS.</p> <p>If the message still appears after disconnecting all connected equipment, contact support at av.middleatlantic.techsupport@legrand.com or (866) 977-3901.</p>
Internal Bus Fault	<p>An internal bus fault occurred in your UPS.</p> <p>Contact support at av.middleatlantic.techsupport@legrand.com or (866) 977-3901.</p>
Inverter / Output Failure	<p>An inverter fault occurred in your UPS. The UPS still operates in Line mode, but if it goes into Battery mode it will shut down.</p> <p>Contact support at av.middleatlantic.techsupport@legrand.com or (866) 977-3901.</p>
Charger Failure	<p>A charger fault occurred in your UPS. The UPS will still operate; however, the battery is no longer being charged.</p> <p>Contact support at av.middleatlantic.techsupport@legrand.com or (866) 977-3901.</p>
Bad Battery – PLS replace battery	<p>Your UPS battery requires replacement.</p> <p>Contact support at av.middleatlantic.techsupport@legrand.com or (866) 977-3901.</p>

Viewing Main Menu > Information

Press the Select button to enter the information menu.

Use Up and Down buttons to scroll and the Select button to choose the device information you wish to view.

For more information, see “Front Panel Buttons” on page [27](#).



NOTE

Device name, IPV4 address, and MAC address options and information are only available with the RackLink™ Network Card option (Model Number UPX-RLNK-CARD).

For more information, refer to the NEXSYS UPS RackLink™ Network Card User Manual (100-00074) at www.legrandav.com or contact support at av.middleatlantic.techsupport@legrand.com or (866) 977-3901.

Option	Information Shown
Device Name	Displays the user setup name. (Only available with the RackLink Network Card option.)
UPS Model	Displays the UPS model name.
UPS Serial No	Displays the UPS serial number.
Battery Part No	Displays the UPS battery pack part number.
Battery Install Date	Displays the UPS battery installation date.
UPS Firmware	Displays the UPS firmware version number.
IPv4 Address	Displays the IP address of the RackLink Network Card. (Only available with the RackLink Network Card option.)
MAC	Displays the MAC address of the RackLink Network Card. (Only available with the RackLink Network Card option.)

Understanding the UPS Power Button



NOTE

Your UPS comes from the factory with the batteries fully charged and a one-time Transport Mode function is enabled to minimize battery discharge.

If you press the power button while the UPS is in Transport Mode, the following message appears for 10 seconds on the LCD.

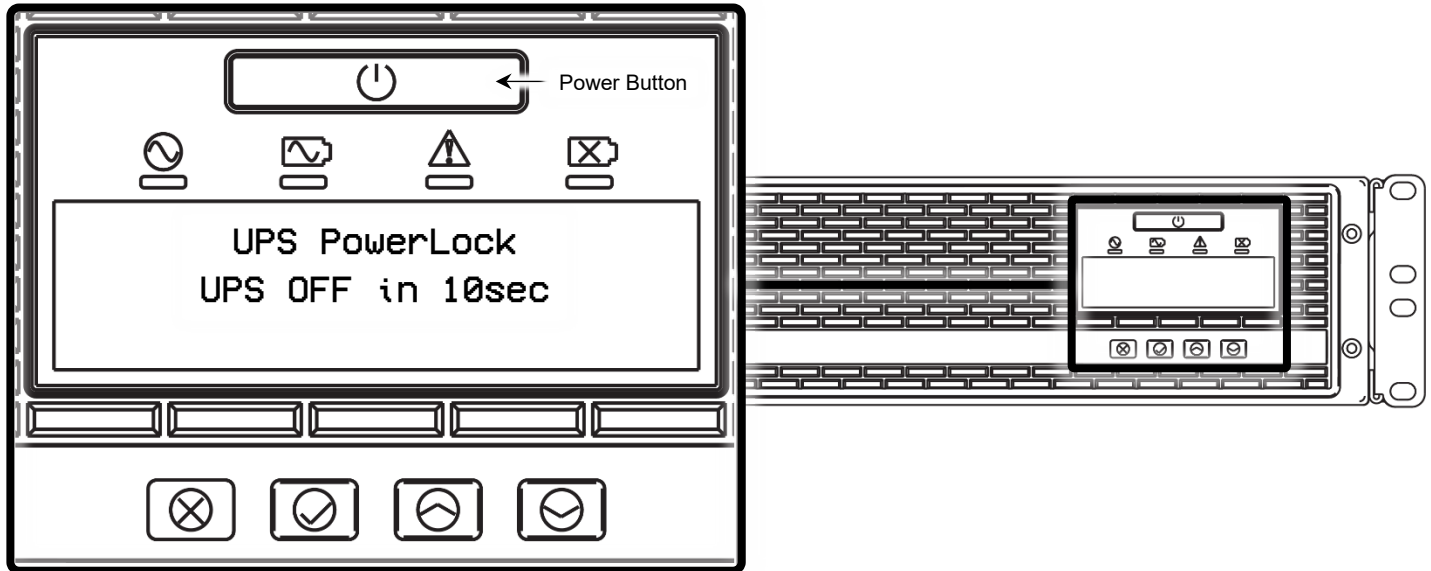

After 10 seconds, the LCD and UPS turn off.

The first time you plug your UPS into an appropriately rated receptacle using the power cord (C), the system turns off the one-time Transport Mode and the power button then functions as follows:

- Press and hold the power button until the display shows “Release Button Turn On UPS.” The unit then powers On – whether it’s in Line Mode (plugged in) or Battery Mode.
- Press and hold the power button until the display shows “Release Button Shutdown UPS.” The unit then powers Off.
- When the UPS is On, in Line Mode, and you press and hold the Power button until you hear exactly 4 beeps, and then immediately release the button, the unit perform a manual battery self-test.

Replacing the Battery



NOTE

The UPS (A) is equipped with a hot-swappable battery design; meaning, the battery may be replaced without shutting down the UPS or removing any connected loads. Replacement is a safe, isolated procedure from electrical hazards.

1. Use a #2 Phillips screwdriver and remove the (4x) screws from the front panel of the UPS (A) as shown.

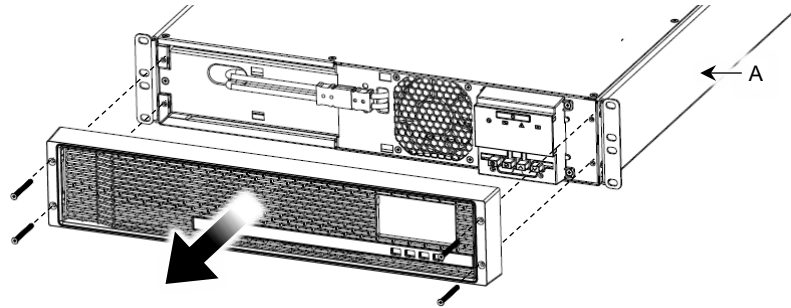

2. Remove the panel from the UPS and set it aside along with the screws for re-attachment.
3. Squeeze and pull apart the battery wire connection and separate them as shown.

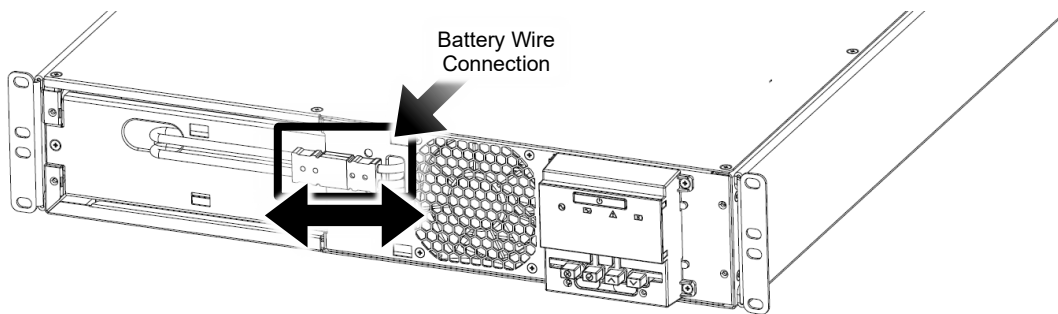

4. Use screwdriver to remove the set screw and battery cover as shown.

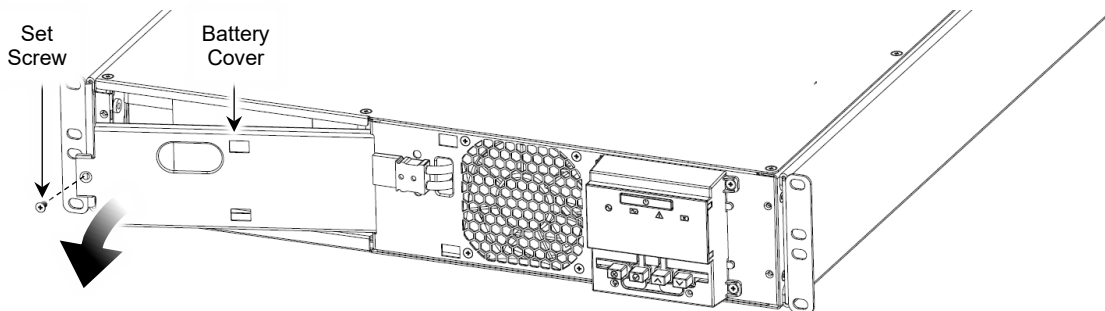

5. Slide the battery box out of the front opening.

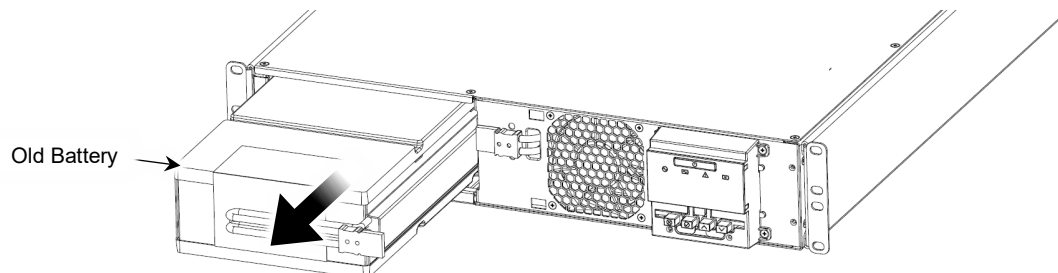

6. Use the box and pre-paid shipping label provided with your replacement battery and carefully pack and send the discharged battery to the recycling center. Otherwise, dispose or recycle your used battery in accordance with local laws and regulations.



CAUTION Discharged batteries are considered hazardous waste. They must be recycled or disposed of in accordance with all local laws and regulations or shipped to your dealer using replacement battery packaging, where applicable.

ATTENTION Les batteries déchargées sont considérées comme des déchets dangereux. Ils doivent être recyclés ou éliminés conformément à toutes les lois et réglementations locales et/ou expédiés à votre revendeur en utilisant un emballage de batterie de remplacement, le cas échéant.

7. Slide your new battery into the front opening.

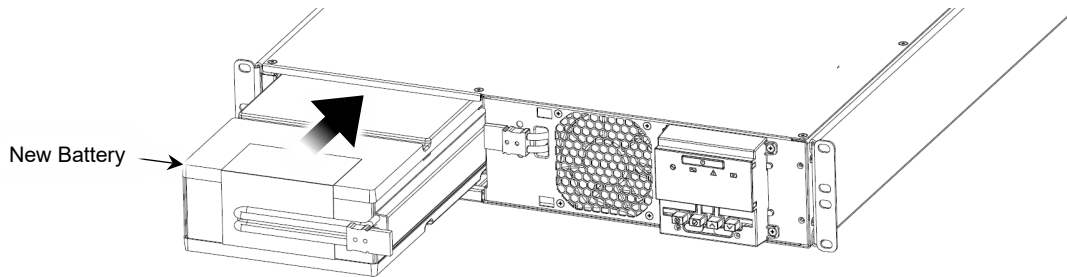

8. Use screwdriver and set screw to re-attach the battery cover.

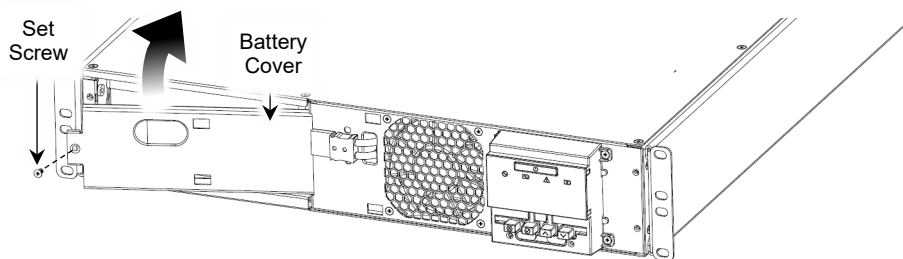

9. Re-attach the battery wire connection as shown.

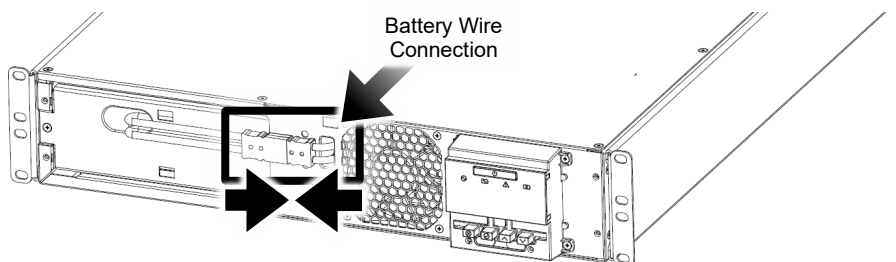

10. Use screwdriver and (4x) screws to re-attach the front panel to your UPS as shown.

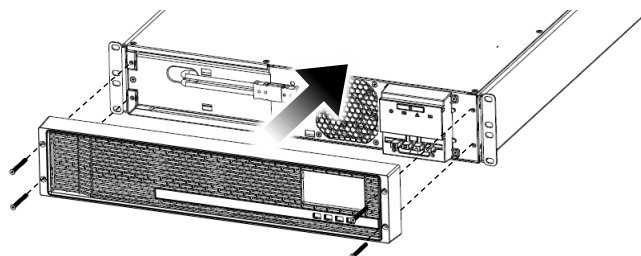

**NOTE**

After replacing the battery, the unit must be charged for eight hours before providing direct backup power to connected devices. For more information, see “Charging Your UPS, the First Time” on page 13.

11. Update the battery installation date that appears on the LCD in the Information menu using either the manager software or the RackLink™ network card option. For more information, see “Communicating with Your UPS” on page 18 and refer to the NEXSYS UPS Manager Software User Manual (100-00077) or NEXSYS UPS RackLink Network Card User Manual (100-00074) at www.legrandav.com.
12. On the LCD screen, select Yes for the coefficient to optimize your battery runtime calculation. For more information see “Using Main Menu > Configuration Functions > Reset Batt aging coefficient” on page 32.

Replacing the Power Cord (if Necessary)

**WARNING**

A power cord used with this device must meet the specifications listed in this topic.

AVERTISSEMENT

Tout câble d'alimentation utilisé avec cet appareil doit répondre aux spécifications répertoriées dans cette rubrique.

Your UPS may require a longer length or replacement power cable. When replacing the cable with Legrand or any other supplier, the following specifications are required for 1K/1.5K UPS and 2K UPS products, respectively.

Understanding Cord Replacement Specifications for the 1K/1.5K UPS

Only operate your UPS using a power supply cord meeting the following compliance standards and specifications.

- Detachable, complying with UL 62, 1581.
- NEMA 5-15P plug type complying with UL 817 and CSA 22.2 NO.21-95, 42M.
- Minimum wire size of SJT 3/C, 16AWG, 221° F (105° C), 300V VW-1.
- C13 connector complying with the IEC60320-1 standard.

Understanding Cord Replacement Specifications for the 2K UPS

Only operate your UPS using a power supply cord meeting the following compliance standards and specifications.

- Detachable, complying with UL 62, 1581.
- NEMA 5-20P plug type complying with UL 817 and CSA 22.2 NO.21-95, 42M.
- Minimum wire size of SJT 3/C, 12AWG, 221° F (105° C), 300V VW-1.
- C19 connector complying with the IEC60320-1 standard.

Troubleshooting

Problem	Possible Cause	Solution
The UPS outlets do not provide power to connected equipment.	The AC input power cord is not properly connected.	Check your input power cord (C) is connected properly to the connector on the back of your UPS and into an appropriately rated receptacle.
	Your UPS battery power has discharged.	Recharge your UPS battery for at least eight hours.
	Manual, Automatic, or Scheduled Load Shedding is enabled on your UPS.	Check the outlet state setting on the LCD menu. For more information, see “Using Main Menu > Configuration Functions > Bank/Outlet” on page 30 . For more information, refer to the NEXSYS UPS Manager Software User Manual (100-00077) or the NEXSYS UPS RackLink Network Card User Manual (100-00074) at www.legrandav.com .
The UPS does not operate for the expected runtime duration.	The UPS battery is not fully charged.	Recharge your UPS battery for at least eight hours.
	The battery needs to be replaced.	If you are still experiencing problems after your UPS has been charged a full eight hours, contact support at av.middleatlantic.techsupport@legrand.com or (866) 977-3901.
The UPS does not calculate the expected runtime for its connected expandable battery option.	The UPS is not configured to automatically detect the expandable battery.	Check that the external battery setting is configured to Auto. For more information, see “Using Main Menu > Configuration Functions > External Battery” on page 31 .
	The main connector cord and communication cable are not properly connected between the UPS and the expandable battery.	Properly connect the main connector cord and the communication cable between the UPS and the expandable battery. For more information, see “Connecting the Expandable Runtime Battery Option” on page 20 .

Problem	Possible Cause	Solution
The UPS displays a High Input Current warning message.	With a low input voltage, the UPS compensates and produces higher current to maintain the power demand.	<p>Access your UPS activity logs and look for any consistent low voltage reading trends, which may indicate a possible site issue. Reduce the load to resolve any high current production stress to the UPS.</p> <p>For more information, refer to the NEXSYS UPS Manager Software User Manual (100-00077) or the NEXSYS UPS RackLink Network Card User Manual (100-00074) at www.legrandav.com.</p>
The LCD on your UPS indicates “UPS is overloaded.” or has already shutdown.	<p>In Normal or Battery mode, the following shutdown timespans vary based on the following overload percentages:</p> <ul style="list-style-type: none"> • A 110% overload sounds an alarm for 20 seconds before shutdown. • A 125% overload sounds an alarm for 10 seconds before shutdown. • A 150% overload sounds no alarm and causes an immediate shutdown. 	Reduce the load, and then press the power button to re-establish power to the UPS outlets. For more information, see “Understanding the UPS Power Button” on page 37 .
The UPS has shut down.	If a “UPS overloaded” warning message appears, the UPS was overloaded above 105% for more than 30 seconds.	Reduce the load, and then press the power button to re-establish power to the UPS outlets. For more information, see “Understanding the UPS Power Button” on page 37 .
	If a “High Internal Temperature” warning message appears, the UPS was above 176° F (80° C) for more than 5 seconds.	<p>Press the power button to start the UPS. For more information, see “Understanding the UPS Power Button” on page 37.</p> <p>If the problem persists, contact support at av.middleatlantic.techsupport@legrand.com or (866) 977-3901.</p>

Problem	Possible Cause	Solution
<p>When the UPS is turned Off, the RackLink™ Network Card is not recognized.</p>	<p>The UPS sleep mode (disabled by default) is enabled.</p> <p>When enabled, sleep mode deactivates the network card port when the UPS is Off, the batteries are fully charged, and the LCD panel is asleep.</p> <p>With the UPS turned Off, sleep mode enabled, and the batteries fully charged, you may press any LCD panel button and the system temporarily activates the network card port until going back to sleep again.</p>	<div style="border: 1px solid black; padding: 10px;"> <p>CAUTION</p> <p>Disable the sleep mode function to keep your network card on regardless of your UPS power settings. For more information, see "Using Main Menu > Configuration Functions > Service Mode" on page 32.</p> <p>ATTENTION</p> <p>Désactivez la fonction de mode veille pour garder votre carte réseau allumée quels que soient les paramètres d'alimentation de votre onduleur. Pour plus d'informations, voir "Utilisation du menu principal > Fonctions de configuration > Mode service" à la page 32.</p> </div>

Specifications



NOTE Specifications are subject to change without notice.

General

Model	UPX-1000R-2 UPX-RLNK-1000R-2 UPX-RLNK-1000R-8	UPX-1500R-2 UPX-RLNK-1500R-2 UPX-RLNK-1500R-8	UPX-2000R-2 UPX-RLNK-2000R-2 UPX-RLNK-2000R-8
UPS Topology	Line Interactive		
VA	1000VAC	1500VAC	2000VAC
Watts	900W	1350W	1800W
Power Factor	0.9		

Input

Model	UPX-1000R-2 UPX-RLNK-1000R-2 UPX-RLNK-1000R-8	UPX-1500R-2 UPX-RLNK-1500R-2 UPX-RLNK-1500R-8	UPX-2000R-2 UPX-RLNK-2000R-2 UPX-RLNK-2000R-8
Nominal Voltage	110VAC 120VAC 127VAC		
Voltage Range	80VAC min – 158VAC max		
Frequency	50/60Hz Autosensing		
Maximum Peak Load	15A	20A	
Rated Load	12A	16A	
Sensitivity	Adjustable for generator application.		
Input Power Cord	SignalSAFE IEC to 5-15P 6' (1.83M)		SignalSAFE IEC to 5-20P 6' (1.83M)

Output

Model	UPX-1000R-2 UPX-RLNK-1000R-2 UPX-RLNK-1000R-8	UPX-1500R-2 UPX-RLNK-1500R-2 UPX-RLNK-1500R-8	UPX-2000R-2 UPX-RLNK-2000R-2 UPX-RLNK-2000R-8
Voltage Regulation	90VAC min – 146VAC max		
Double Boost	105VAC and 90VAC	105VAC and 90VAC	105VAC and 90VAC
Double Buck	130VAC and 146VAC	130VAC and 146VAC	130VAC and 146VAC
Waveform (Battery Mode)	Pure Sine Wave		
Nominal Voltage (Battery Mode)	120VAC \pm 5%		
Selectable Battery Voltage	110 120 127VAC \pm 5%		
	NOTE: When 110VAC is selected, the UPS is derated to 90%.		
Frequency (Battery Mode)	50 Hz or 60 Hz (\pm 0.5 Hz)		
Number of Outlets	8		
Outlet Type	NEMA 5-15R		NEMA 5-20R

Model	UPX-1000R-2 UPX-RLNK-1000R-2 UPX-RLNK-1000R-8	UPX-1500R-2 UPX-RLNK-1500R-2 UPX-RLNK-1500R-8	UPX-2000R-2 UPX-RLNK-2000R-2 UPX-RLNK-2000R-8
Surge Protection	1000 Joules		
Overload Protection	Circuit Breaker		
Transfer Time	Typical: 4ms Max: 6 – 10ms		
Fan and Audible Noise	45dB @ 1m Variable Speed Fan		50dB @ 1m Variable Speed Fan
Sensitivity	5% max @ 100% linear load, 12% max @ 100% non-linear load		
BTUs (Line Mode)	70	105	140
BTUs (Battery Mode)	495	750	990
Full-Load Run Time	4 minutes	3 minutes	3 minutes
Half-Load Run Time	13 minutes	10 minutes	10 minutes

Battery

Model	UPX-1000R-2 UPX-RLNK-1000R-2 UPX-RLNK-1000R-8	UPX-1500R-2 UPX-RLNK-1500R-2 UPX-RLNK-1500R-8	UPX-2000R-2 UPX-RLNK-2000R-2 UPX-RLNK-2000R-8
Sealed Maintenance-Free, Lead Acid Battery	Lead Acid		
Recharge Time	6 – 8 hours		
Battery Replacement	Hot Swappable Front Access		
Replacement Battery Model Numbers	UPX-RPLBATT-A	UPX-RPLBATT-B	UPX-RPLBATT-C
Battery Pack Voltage	36 VDC	36 VDC	48 VDC

Expandable Runtime Battery Option (ERB)

Model	UPX-1000R-2 UPX-RLNK-1000R-2 UPX-RLNK-1000R-8	UPX-1500R-2 UPX-RLNK-1500R-2 UPX-RLNK-1500R-8	UPX-2000R-2 UPX-RLNK-2000R-2 UPX-RLNK-2000R-8
Composition	Lead Acid		
Recharge Time	6 – 8 hours		
Battery Replacement	Hot Swappable Front Access		
Replacement Battery Part Numbers	UPX-RPLBATT-A (ERB requires two batteries.)		UPX-RPLBATT-D (ERB requires two batteries.)
UPS + 1 ERB Full- and Half-Load Runtimes	23 55 minutes	12 37 minutes	17 42 minutes
UPS + 2 ERB Full- and Half-Load Runtimes	43 105 minutes	28 74 minutes	33 83 minutes
UPS + 3 ERB Full- and Half-Load Runtimes	68 164 minutes	43 111 minutes	50 135 minutes
UPS + 4 ERB Full- and Half-Load Runtimes	93 222 minutes	60 154 minutes	71 178 minutes

Environment

Model	UPX-1000R-2 UPX-RLNK-1000R-2 UPX-RLNK-1000R-8	UPX-1500R-2 UPX-RLNK-1500R-2 UPX-RLNK-1500R-8	UPX-2000R-2 UPX-RLNK-2000R-2 UPX-RLNK-2000R-8
Operating Temperature and Relative Humidity	32° F (0° C) – 104° F (40° C) 0% – 95% Non-Condensing		
Storage Temperature	5° F (-15° C) – 113° F (45° C)		

Communication

Model	UPX-1000R-2 UPX-RLNK-1000R-2 UPX-RLNK-1000R-8	UPX-1500R-2 UPX-RLNK-1500R-2 UPX-RLNK-1500R-8	UPX-2000R-2 UPX-RLNK-2000R-2 UPX-RLNK-2000R-8
NEXSYS UPS Manager Software	Supports Windows® 7, 8, 10, and 11 and Windows Server 2008, 2012, 2016, and 2019, Windows 2008, 2012 Server Core, and Hyper-V 2008, 2012		

Model	UPX-1000R-2 UPX-RLNK-1000R-2 UPX-RLNK-1000R-8	UPX-1500R-2 UPX-RLNK-1500R-2 UPX-RLNK-1500R-8	UPX-2000R-2 UPX-RLNK-2000R-2 UPX-RLNK-2000R-8
Ports	USB, RS232, EPO, Dry Contacts, EXB Auto Detect, and NEXSYS UPS RackLink™ Network Card Option For more information, see “Communicating with Your UPS” on page 18 and refer to the NEXSYS UPS RackLink™ Network Card Quick Start Guide (100-00073) at www.legrandav.com .		
Communication and Security Features for the RackLink Network Card Option (If Applicable)	SNMP V3, HTTP, HTTPS, TLS 1.2, SSH, Imbedded Web GUI with Dashboard, RADIUS, TCP/IP, Telnet, and FTP. For more information, see “Communicating with Your UPS” on page 18 and refer to the NEXSYS UPS RackLink™ Network Card Quick Start Guide (100-00073) at www.legrandav.com .		

Control

Model	UPX-1000R-2 UPX-RLNK-1000R-2 UPX-RLNK-1000R-8	UPX-1500R-2 UPX-RLNK-1500R-2 UPX-RLNK-1500R-8	UPX-2000R-2 UPX-RLNK-2000R-2 UPX-RLNK-2000R-8
Load Shedding Functionality	Bank 1 and 2 Programmable (Standard) Individual Outlets Programmable (Optional)		
Active On Off	Manually turn power receptacles on or off using the front panel LCD or the UPS Manager Software.		
Scheduling	Fully programmable scheduling available for bank or outlet switching (based on the model purchased).		

Front Panel Interface

Model	UPX-1000R-2 UPX-RLNK-1000R-2 UPX-RLNK-1000R-8	UPX-1500R-2 UPX-RLNK-1500R-2 UPX-RLNK-1500R-8	UPX-2000R-2 UPX-RLNK-2000R-2 UPX-RLNK-2000R-8
Notification	LED = Normal Mode, AVR Mode, Battery Mode, Internal Fault, Battery Fault LCD = Various For more information, see “Using Front Panel Buttons and the LED Indicators” on page 26 and “Operating the LCD Main Menu” on page 29.		
Audible Alarms	On Battery, Low Battery, Battery Disconnected, Fault, or Overload		

Physical

Model	UPX-1000R-2 UPX-RLNK-1000R-2 UPX-RLNK-1000R-8	UPX-1500R-2 UPX-RLNK-1500R-2 UPX-RLNK-1500R-8	UPX-2000R-2 UPX-RLNK-2000R-2 UPX-RLNK-2000R-8
Dimensions Width x Height x Depth	17.3" (440mm) x 3.4" (86.5mm) x 17.3" (440mm)	17.3" (440mm) x 3.4" (86.5mm) x 17.3" (440mm)	17.3" (440mm) x 3.4" (86.5mm) x 23.6" (600mm)
Product Weight	44.1 lbs. (20kg)	44.1 lbs. (20kg)	63.05 lbs. (28.6kg)
Shipping Weight	54 lbs. (24.5kg)	54 lbs. (24.5kg)	71 lbs. (32.2kg)

Certifications

Model	UPX-1000R-2 UPX-RLNK-1000R-2 UPX-RLNK-1000R-8	UPX-1500R-2 UPX-RLNK-1500R-2 UPX-RLNK-1500R-8	UPX-2000R-2 UPX-RLNK-2000R-2 UPX-RLNK-2000R-8
Safety Standards	cTUVus Tested to UL 1778 & CAN CSA-C22.2 standards.		
EMI Standards	FCC Class A		
Environmental	RoHS 3 REACH Compliant		
Energy Efficiency	Energy Star 2.0, CEC (California Energy Commission), and DOE (U.S. Department of Energy)		

Features

Model	UPX-1000R-2 UPX-RLNK-1000R-2 UPX-RLNK-1000R-8	UPX-1500R-2 UPX-RLNK-1500R-2 UPX-RLNK-1500R-8	UPX-2000R-2 UPX-RLNK-2000R-2 UPX-RLNK-2000R-8
Load Shedding	Yes (Bank)		
Site Fault Detection	Yes		
Cold Start	Yes		

Warranty

Model	UPX-1000R-2 UPX-RLNK-1000R-2 UPX-RLNK-1000R-8	UPX-1500R-2 UPX-RLNK-1500R-2 UPX-RLNK-1500R-8	UPX-2000R-2 UPX-RLNK-2000R-2 UPX-RLNK-2000R-8
Standard	Three Years Limited (2 Years Battery) For warranty information, refer to legrandav.com/policies/warranty_information .		

System Function Block Diagram

As shown in the following diagrams, the UPS is composed of a mains input, EMI/RFI filters, inverter, battery charger, DC-to-DC converter, battery, AVR TX, and UPS output.

Diagram for UPS models with 2 banks of controlled outlets.

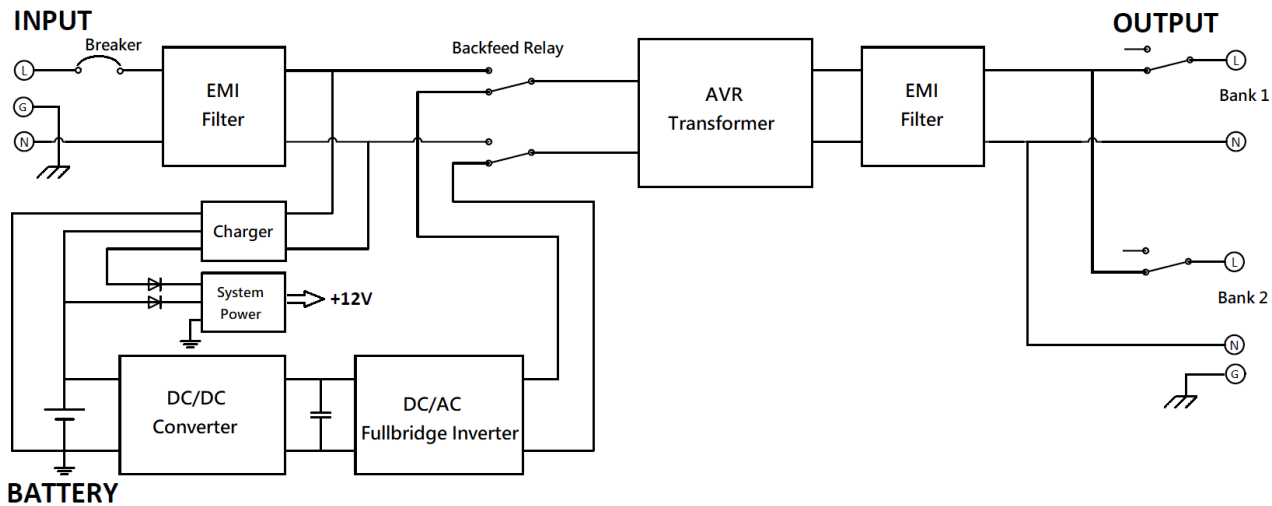
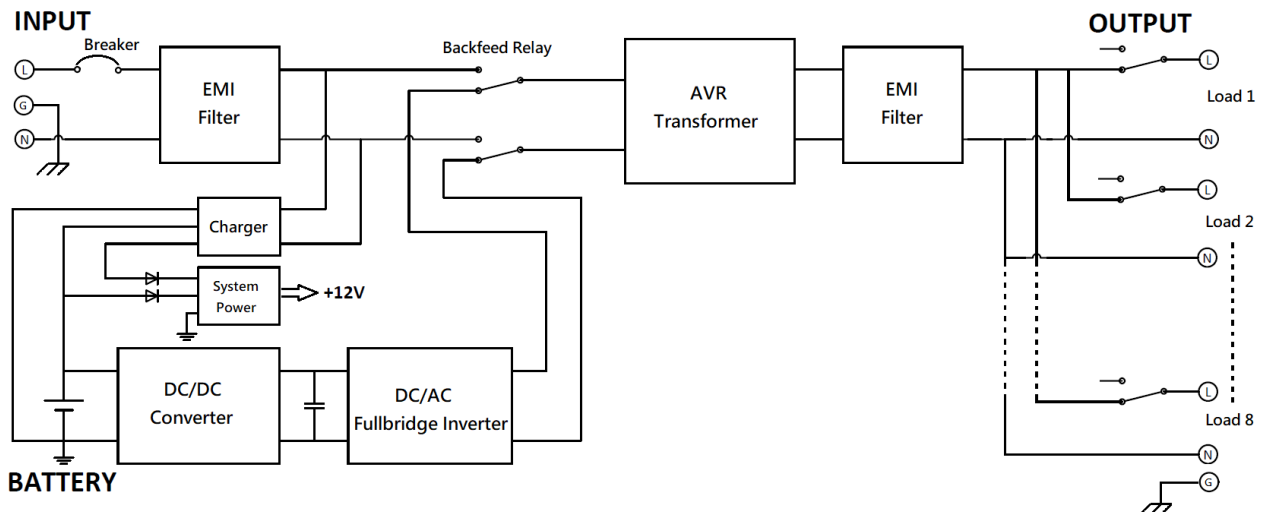

Diagram for UPS models with 8 individually controlled outlets.



Warranty

For warranty information, refer to www.legrandav.com/policies/warranty_information.

Contacting Corporate Headquarters

P: (866) 977-3901 | F: (877) 894-6918 | www.legrandav.com | av.middleatlantic.techsupport@legrand.com

Contacting Middle Atlantic Canada

P: (888) 766-9770 | F: (888) 599-5009 | ca.middleatlantic.com | av.canada.customerservice@legrand.com

United States (US)

Legrand | AV Headquarters
6436 City West Parkway
Eden Prairie, MN, 55344, USA

At Legrand AV Inc. we are always listening. Your comments are welcome.
Legrand AV is an ISO 9001 and ISO 14001 Registered Company.