



Acrylic Security Enclosure Wall Mount

PAD-ASVEBVS / PAD-ASVEVWS

INSTALLATION - MANUAL

CONTENTS:

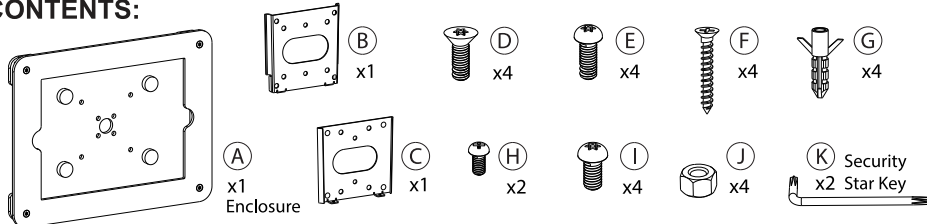

INSTALLATION:

1. Mounting Plate to Surface :

Mounting to wood stud

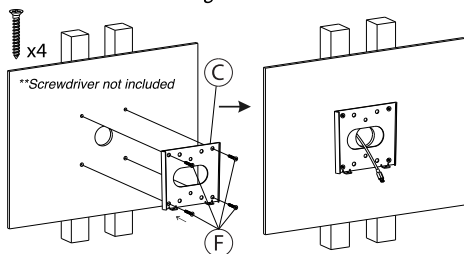

1A. Fix VESA back plate (C) into the surface by screwing the provided nails (F). (shown above)

Mounting to masonry or solid concrete

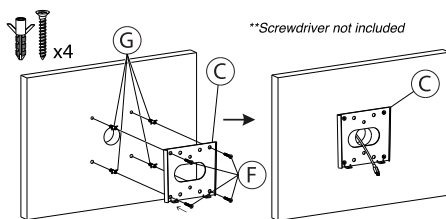

1B. Fix VESA back plate (C) into the surface by inserting anchors (G) into pre-drilled holes then screwing the provided nails (F). (shown above)

2. Mounting Plate to Enclosure and Completing Setup:

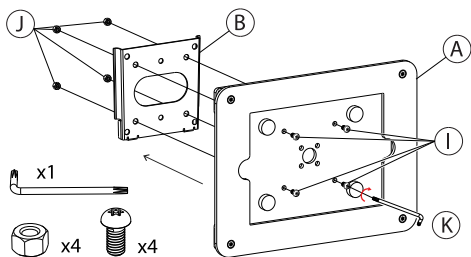

2A. Align VESA holes of VESA front plate (B) with the VESA holes of enclosure (A). Rotate star screws (I) from front of enclosure with security star tool (K) while holding nuts (J) from behind the VESA plate.

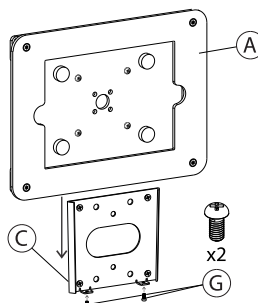

2B. When VESA front plate (B) is attached to enclosure (A), slide onto the wall attached vesa back plate (C) from above as illustrated. Then secure it by screwing provided nails (G) with a screwdriver (not provided).

**Screwdriver not included

3. Setting up Device within Enclosure:

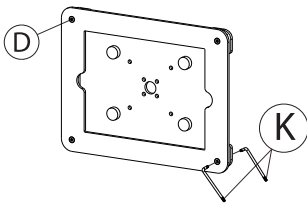

3A. Align the security star keys x2 (K) from both sides and insert into star screw as illustrated.

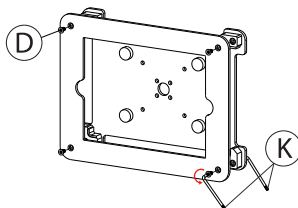

3B. While holding the back security star key (K) tight in place, rotate the front security star key (K) counter clock-wise until all 4 screws (D) are removed.

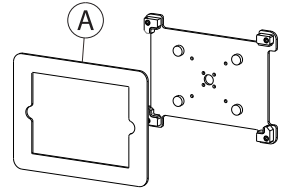

3C. Separate front part of enclosure (A) as shown.

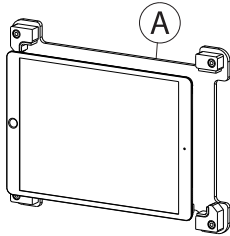

**Tablet is for illustration purposes and not included

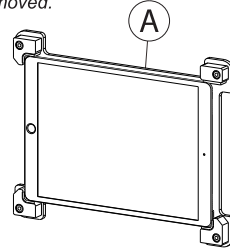

3D. Using one of the compatible listed tablets, insert tablet into back part of enclosure (A) as shown. The tablet should fit snug and securely into the foam adapters as illustrated above. (Tablet is not included)

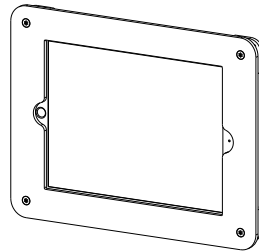
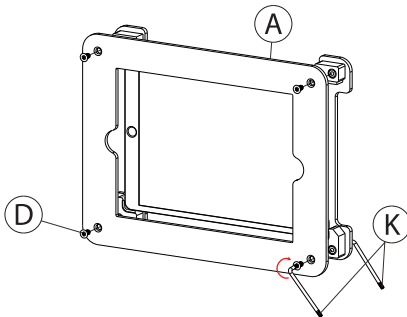

3E. Take the detached enclosure top (A), align the corner holes with the bottom portion. Then use (2) of the provided security star keys (K), turn in clock-wise the star screws (D) while holding the security star key (K) on the other side with your other hand. Screw in until securely tightened.

Portrait or Landscape Orientation



Can install the enclosure either portrait or landscape mode as needed.