



# Instructions for Use

## CuratOR<sup>®</sup> EX4342 Color LCD Monitor





### **Important**

Please read this “Instructions for Use”, and “Installation Manual” (separate volume) carefully to familiarize yourself with safe and effective usage.

- 
- For monitor adjustment and settings, refer to the “Installation Manual”. The “Installation Manual” is part of the “Instructions for Use”.
-

## SAFETY SYMBOLS

This manual and this product use the safety symbols below. They denote critical information. Please read them carefully.

 <b>WARNING</b>	Failure to abide by the information in a WARNING may result in serious injury and can be life threatening.
 <b>CAUTION</b>	Failure to abide by the information in a CAUTION may result in moderate injury and/or property or product damage.
	Indicates a prohibited action. For example,  means "Do not disassemble".

This product has been adjusted specifically for use in the region to which it was originally shipped. If operated outside this region, the product may not perform as stated in the specifications.















No part of this manual may be reproduced, stored in a retrieval system, or transmitted, in any form or by any means, electronic, mechanical, or otherwise, without the prior written permission of EIZO GmbH. EIZO GmbH is under no obligation to hold any submitted material or information confidential unless prior arrangements are made pursuant to EIZO GmbH's receipt of said information. Although every effort has been made to ensure that this manual provides up-to-date information, please note that EIZO product specifications are subject to change without notice.

# PRECAUTIONS

## IMPORTANT

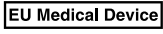
- This product has been adjusted specifically for use in the region to which it was originally shipped. If the product is used outside the region, it may not operate as specified in the specifications.
- To ensure personal safety and proper maintenance, please read carefully this section.

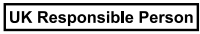
### Markings and symbols

Symbol	This symbol indicates
	Power Switch: Press to turn the monitor's power off.
	Power Switch: Press to turn the monitor's power on.
	Direct current
	Dangerous voltage
	CAUTION: Refer to "SAFETY SYMBOLS" (page 2).
	Protective earth (grounding terminal)
	Potential equalization terminal
	WEEE marking: Product must be disposed of separately; materials may be recycled.
	CE marking: EU conformity mark in accordance with the provisions of Council Directive and/or Regulation (EU).
	Manufacturer
	Date of manufacture
<b>RX only</b>	Caution: Federal law (USA) restricts this device to sale by or on the order of a licensed healthcare practitioner.
	Medical device in accordance with the European medical device regulation.
	Refer to instruction manual / booklet
IP32	Symbol for degree of protection according to DIN EN 60529.
	Mark signifying compliance with UK regulations
	UK Responsible Person
	Authorised representative in Switzerland

## **WARNING**

---

**If the unit begins to emit smoke, smells like something is burning, or makes strange noises, disconnect all power connections immediately and contact your local EIZO representative for advice.**

Attempting to use a malfunctioning unit may result in fire, electric shock, or equipment damage.

---

**Do not disassemble or modify the unit.**

Opening the cabinet or modifying the unit may result in fire, electric shock, or burns.



---

**Use multiple units or have a standby unit ready.**

Prepare an appropriate countermeasure in case the monitor fails.

---

**Do not turn the bushing to fix the AC adapter power cable.**

Doing so may result in fire, electric shock, or equipment damage.



---

**Refer all servicing to qualified service personnel.**

Do not attempt to service this product yourself as opening or removing covers may result in fire, electric shock, or equipment damage.

---

**Keep small objects or liquids away from the unit.**

Small objects accidentally falling through the ventilation slots into the cabinet or spillage into the cabinet may result in fire, electric shock, or equipment damage. If an object or liquid falls/spills into the cabinet, unplug the unit immediately. Have the unit checked by a qualified service engineer before using it again.



---

**Install the unit correctly on a sturdy and stable location using an arm or stand.**

In accordance with the User Manual of each product, install it correctly on a sufficiently sturdy desk or wall. If the unit is installed incorrectly, it may drop or fall over, resulting in personal injury or equipment damage. If the unit falls, disconnect the power immediately and ask your local EIZO representative for advice. Do not continue using a damaged unit. Using a damaged unit may result in fire or electric shock.

---

**Use the unit in an appropriate location.**

Otherwise, fire, electric shock, or equipment damage may result.

- Do not place outdoors.
- Do not place in any form of transportation (ships, aircraft, trains, automobiles, etc.).
- Do not place in dusty or humid environments.
- Do not place in locations where water may be splashed on the screen (bathrooms, kitchens, etc.)
- Do not place in locations where smoke or steam come in direct contact with the screen.
- Do not place near heat generating devices or humidifiers.
- Do not place in locations where the product is subject to direct sunlight.
- Do not place in environments with flammable gas.
- Do not place in environments with corrosive gases (such as sulfur dioxide, hydrogen sulfide, nitrogen dioxide, chlorine, ammonia, ozone, etc.)
- Do not place in environments with dust, components that accelerate corrosion in the atmosphere (such as sodium chloride and sulfur), conductive metals, etc.



---

**To avoid danger of suffocation, keep the plastic packing bags away from babies and children.**

---

**Use approved power cord in your country and connect to the standard power outlet in your country.**

Be sure to use within the rated voltage of the power cord. Otherwise, fire or electric shock may result.

Power supply: 100-240Vac 50/60Hz

---

## **WARNING**

---

### **Use the enclosed AC adapter.**

The enclosed AC adapter (AHM250PS48T) is for use with this product only. Do not use the AC adapter with other equipment. Do not use an AC adapter designed for other devices with this product. Connecting to power sources that do not match the power ratings of the AC adapter may result in fire or electric shock.

---

### **To disconnect the power cord or adapter power cable, grasp the plug firmly and pull.**

Tugging on the cord or cable may damage it and result in fire or electric shock.



### **To avoid the risk of electric shock, this equipment must only be connected to a supply mains with protective earth.**



### **Use the correct voltage.**

- The unit is designed for use with a specific voltage only. Connection to a voltage other than that specified in this "Instructions for Use" may cause fire, electric shock, or equipment damage.  
Power supply: 100-240Vac 50/60Hz
  - Do not overload your power circuit, as this may result in fire or electric shock.
- 

### **Handle the power cord and AC adapter with care.**

Handle the power cord and AC adapter with care.

Do not place heavy objects on the power cord or AC adapter, or pull or tie the power cord. Using a damaged cord or AC adapter may result in fire or electric shock.



### **The operator should not touch the patient while touching the product.**

This product has not been designed to be touched by patients.



### **Never touch the plug, AC adapter or power cord during a thunderstorm.**

Touching them may result in electric shock.



### **Do not touch a damaged LCD panel directly with bare hands.**

Liquid crystal is poisonous. If any part of your skin comes in direct contact with the panel, wash thoroughly. If liquid crystal enters your eyes or mouth, immediately flush with large amounts of water and seek medical attention.



## CAUTION

---

### **Check the operational state before use.**

- Begin use after ensuring that there are no problems with the displayed image.
  - When using multiple units, begin use after ensuring that the images are displayed appropriately.
- 

### **Securely fix cables / cords that have a fixing feature.**

If they are not fixed securely, cables / cords may disconnect, and subsequently images may be cut off and your operations may be disrupted.

---

### **Handle with care when carrying the unit.**

Disconnect the power cord and cables when moving the unit. Moving the unit with the power cord or cables attached is dangerous and may result in injury.

---

### **Carry or place the unit according to the correct specified methods.**

- Monitors of size 30 inches and above are heavy. When unpacking and/or carrying the monitor, ensure at least two people are involved.

Dropping the unit may result in injury or equipment damage.

---

### **Do not block the ventilation slots on the cabinet.**

- Do not place any objects on the ventilation slots.
- Do not install the unit in a place with poor ventilation or inadequate space.
- Do not use the unit laid down or upside down.

Blocking the ventilation slots prevents proper airflow and may result in fire, electric shock, or equipment damage.

---



### **Do not touch the plug or AC adapter with wet hands.**

Doing so may result in electrical shock.

---



### **Use an easily accessible power outlet.**

This is to facilitate disconnecting the power in case of a problem.

---

### **Isolating the device from mains supply**

Means of isolating the device from mains supply is by disconnecting the AC power line. Make sure that the AC power line easily accessible.

---

### **The AC adapter becomes hot during use.**

- Do not touch the AC adapter while it is energized. Touching it may cause a low temperature burn.
  - Do not cover or place anything on top of the AC adapter. Do not place the AC adapter on top of things that trap heat such as carpets, blankets, etc. Keep the AC adapter away from direct sunlight and heat sources. Failure to do so may result in fire.
  - Before moving the monitor, be sure to turn off the power switch, disconnect the power plug from the power outlet, and wait until it has cooled completely.
- 

### **Do not suspend the AC adapter in midair.**

Using the adapter while it is hanging suspended may result in fire or electrical shock.

---



### **Do not place the AC adapter in a vertical orientation.**

Otherwise, dust or water may enter the adapter and may result in fire or electrical shock.

---



### **Do not subject the unit and the AC adapter to any impact due to dropping them or any other causes.**

Using the adapter after it has been subjected to impact may result in fire or electrical shock.

---





## CAUTION

---

**Do not subject the LCD panel to strong impact.**

Otherwise, glass will break and may result in injury.



---

**Periodically clean the area around the power plug and the ventilation slot of the monitor and the AC adapter.**

Dust, water, or oil on the plug may result in fire.

---

**Unplug the unit before cleaning it.**

Cleaning the unit while it is plugged into a power outlet may result in electric shock.

---

**If you plan to leave the unit unused for an extended period of time, disconnect the power plug from the wall socket after turning off the power switch for safety and power conservation.**

---

**For users in the territory of the EEA and Switzerland:**

**Any serious incident that has occurred in relation to the device should be reported to the Manufacturer and the Competent Authority of the Member State in which the user and/or patient is established.**

---

# About the Monitor

## Intended use

---

### Intended purpose

The EX4342 is intended for the display of still images and moving images from various commercially available devices commonly used in a medical environment, in particular endoscopic. The monitor is optimized for the reproduction of colour images. The monitor is not suitable for mammography.

### Intended patient population and medical conditions

The monitor can be used for the intended purpose irrespective of age, body weight and gender.

The monitor is intended to be used in combination with or mounted on medical devices. The monitor therefore has no direct contact with the patient.

The monitor is intended to display still images and moving images from various commercially available (medical) devices commonly used in a medical environment. The monitor cannot be used for direct diagnosis and as main device for monitoring live support equipment.

### Intended users

The intended users for the monitor are qualified healthcare professionals.

### Intended environment

The monitor is intended to be used in professional healthcare facilities such as clinics and hospitals. The monitor can be used in operating rooms (OR) or near patients, but is not limited to them. The monitor is not intended for direct patient contact!

The monitor is not suited for the following environments:

- Home-based healthcare facilities.
- Near short-wave therapy devices.
- Near an MRI-System.
- Built into vehicles, including ambulances.

---

#### Note

#### Serious incident

Any serious incident that has occurred in relation to the device should be reported to the manufacturer and the competent authority of the Member State in which the user and/or patient is established.

---



## Precautions for Use

---

- Parts (such as the LCD panel and the fan) may deteriorate over extended periods of time. Periodically check that they are operating normally.
- When the screen image is changed after displaying the same image for extended periods of time, an afterimage may appear. Use the screen saver or power save function to avoid displaying the same image for extended periods of time. An afterimage may appear even after a short period has elapsed depending on the displayed image. If this occurs, changing the image or leaving the power off for a few hours may solve the problem.
- If the monitor displays continuously over a long period of time, dark smudges or burn-in may appear. To maximize the life of the monitor, we recommend the monitor be turned off periodically.
- The backlight of the LCD panel has a fixed lifetime. When the screen becomes dark or begins to flicker, please contact your local EIZO representative.
- The LCD panel is manufactured using high-precision technology. Although, missing pixels or lit pixels may appear on the LCD panel, this is not a malfunction. Percentage of effective dots: 99.99 % or higher.
- Do not press on the panel or edge of the frame strongly, as this may result in display malfunctions, such as interference patterns, etc. If pressure is continuously applied to the panel surface, it may deteriorate or damage it. (If the pressure marks remain on the panel, leave the monitor with a black or white screen. The symptom may disappear.)
- Do not scratch or press on the panel with any sharp objects, as this may result in damage to the panel. Do not attempt to brush with tissues as this may scratch the panel.
- Condensation may form on the surface or interior of this product when it is brought into a cold room, when the temperature suddenly rises, or when it is moved from a cold room to a warm room. In that case, do not turn the monitor on. Instead wait until the dew condensation disappears, otherwise it may cause some damage to the monitor.
- It takes about 30 minutes for the monitor display to stabilize. Before using the monitor, wait 30 minutes or longer after the monitor power has been turned on or after the monitor has recovered from the power saving mode.

# Cleaning

Periodic cleaning is recommended to keep the monitor looking new and to prolong its operation lifetime. Gently wipe off any dirt on the cabinet or panel surface with a soft cloth soaked in a small amount of water or one of the cleaning agents and disinfectants listed below.

## Recommended cleaning agents and disinfectants

Agent class	Tested cleaning agents and disinfectants	Further examples
Alcohol	Ethanol 96% by vol. Mikrozid Liquid, undiluted Isopropanol 70%	Hospiset cloth Meliseptol Rapid
Aldehyde	Melsitt 10% by vol. Cidex, undiluted	Aldasan 2000 Kohsolin Gigasept FF
Chlorine derivatives	Terralin 0.5% by vol. Sodium hypochlorite 10%	Quartamon Med Benzethonium chloride 0.2%
Disinfectants	Perform 3% by weight Morning Mist (1:64) Terralin Protect 2% by vol. Melisepton rapid; direct Microbac Tissues Taski Sprint DS 5001 0.5% Surfanios Fraichure Citron 0.25% 0.5% Chlorhexidine in 70% isopropylalcohol	Alkyldiaminoethylglycine hydrochloride 0.2% Benzalkonium chloride
Alkylamine	Incidin Plus 8% by vol.	
Guanidine derivatives	Lysoformin 2% by vol.	
Quaternary compounds	Incidur spray, undiluted Mikrozid Sensitive Liquid, undiluted Surfa'safe (ANIOS)	
Standard household washing-up liquid	Tempo	Fairy Ultra, Pril, Palmolive
Pyrene derivatives	Activ spray, undiluted	
Water	Tap water Distilled water	
Cleaning agent	Ammonia solution, 1.65% by vol.	
Lye	Calcium hydroxide diluted with water (limewater)	
Petroleum spirit	Petroleum spirit close to boiling	
Phenol and phenol derivatives	Helipur	

## Prohibited cleaning agents and disinfectants

After extended use, the cleaning agents and disinfectants listed can lighten the paint or damage the polarizer.

Agent class	Tested cleaning agents and disinfectants	Further examples
Organic acids	Bio-AntiBact med	

### Attention

- Do not use chemicals on a frequent basis. Chemicals such as alcohol and antiseptic solution may cause gloss variation, tarnishing, and fading of the cabinet or panel, and also quality deterioration of the image.
- Never use any thinner, benzene, wax, or abrasive cleaner, which may damage the cabinet or panel.
- Do not let chemicals come into direct contact with the monitor.

# CONTENTS

<b>PRECAUTIONS</b> .....	<b>3</b>
<b>IMPORTANT</b> .....	<b>3</b>
<b>About the Monitor</b> .....	<b>8</b>
Intended use .....	8
Precautions for Use .....	9
Cleaning .....	10
<b>CONTENTS</b> .....	<b>11</b>
<b>Chapter 1 Introduction</b> .....	<b>12</b>
1-1. Features .....	12
1-2. Package Contents .....	13
1-3. Controls and Functions .....	13
<b>Chapter 2 Installation / Connection</b> .....	<b>16</b>
2-1. Before Installing the Product .....	16
● Installation Requirements .....	16
2-2. Installing the Product .....	17
2-3. Connecting the Power Cord .....	18
2-4. Connecting the Cables .....	19
2-5. Installing the Cable Cover .....	20
2-6. Turning On the Power .....	20
<b>Chapter 3 If No Image Is Displayed</b> .....	<b>21</b>
<b>Chapter 4 Specifications</b> .....	<b>22</b>
4-1. Specifications List .....	22
4-2. Displayable Input Signals .....	24
<b>Appendix</b> .....	<b>25</b>
Medical Standard .....	25
EMC Information .....	26
Warning for Radio interference .....	30
中国在 ChinaRoHS 中为 RoHS 合规性采取的措施 ...	31
Repairs .....	31
保証 .....	32
アフターサービス .....	33

# Chapter 1 Introduction

## 1-1. Features

### ● High-quality and high-resolution Ultra High Definition (UHD)

- The UHD LCD display allows for display of high-quality, high-resolution medical images.
- Equipped with front protection panel
- LED Backlight
- High luminosity

### ● Supports multiple I/O

- SDI signal: 2 inputs / 1 output  
SDI 1 terminal: compatible with up to 12G-SDI signal, UHD and 3G-SDI Level-B Dual-Link  
SDI 2 terminal: compatible with up to 3G-SDI signal and 3G-SDI Level-B Dual-Link
- DVI signal: 1 input / 1 output
- DisplayPort signal: 1 input / 1 output  
Compatible with DisplayPort 1.2 SST (Single Stream Transport) UHD
- HDMI signal: 1 input  
Compatible with UHD



### ● Other functions

- Optimal preset setting (DisplayPort [sRGB], DisplayPort [BT.2020], HDMI [BT.2020], SDI [BT.2020])
- Dual screen display (PbyP and PinP)  
Permits parallel display of two input images.
- Equipped with wide color gamut automatic switching for 4K signals.
- Gamma switch function  
Gamma function is installed according to usage.  
Simplified DICOM<sup>®</sup> image is supported.
- Color temperature switch function  
Color temperature switch function is installed according to usage.
- External remote function  
Allows for remote control via RS-232C terminal.
- IP32 protection structure (Excluding the AC adapter)  
The IPx2 protection level is effective when the monitor is installed so it cannot be put at a slant.
- Auto Input Detection function  
Automatically switches to the other available input connector when no signals are input from the selected input connector.

## 1-2. Package Contents

Check that all of the following items are included in the package.

### Note

- It is recommended that the box and packing materials be stored so that they can be used to move or transport this product.

- Monitor
- AC adapter (AHM250PS48T)
- Cable cover (attached on the back side with screws)
- Monitor attachment screw (M8×14) x 4
- Torx L-Wrench TX20
- Cable ties x 2
- User Manual CD
  - Instructions for Use
  - Installation Manual
  - Outline Dimensions
- Safety Precautions

## 1-3. Controls and Functions

### AC adapter

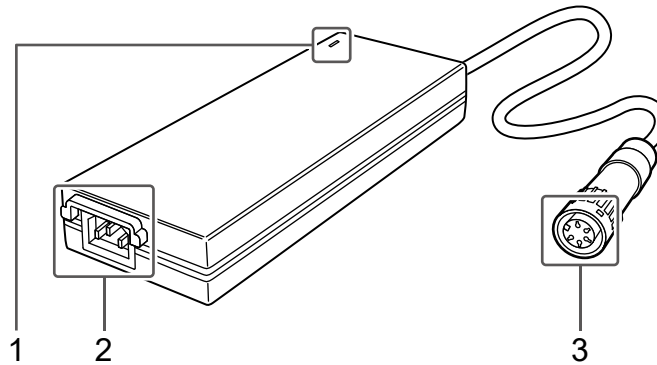

<b>1. Main power indicator</b>	Depending on the operation status of the main power supply, the indicator of the AC adapter turns on or off. Lit up: Power on, Not lit up: Power off
<b>2. AC IN terminal</b>	Connects the power cord.
<b>3. DC OUT terminal</b>	Connect to the DC IN terminal on the monitor.

## Front

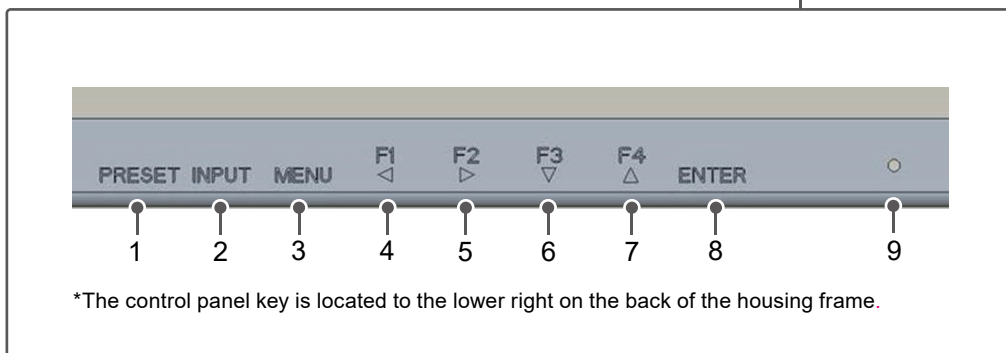
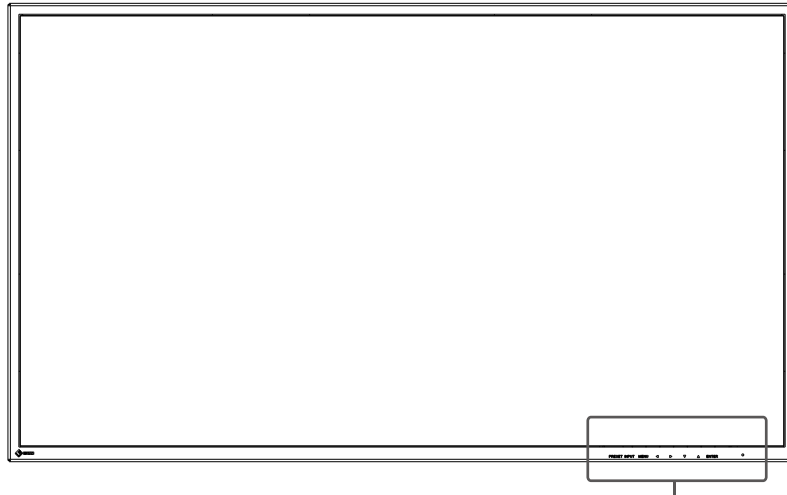

<b>1. PRESET button</b>	Displays the preset menu.
<b>2. INPUT button</b>	Displays the input select menu.
<b>3. MENU button</b>	Displays the main menu.
<b>4. F1/Left button</b>	Executes the function assigned to this button. Select items in the menu screen.
<b>5. F2/Right button</b>	
<b>6. F3/Down button</b>	
<b>7. F4/Up button</b>	
<b>8. ENTER button</b>	Select items in the menu screen.
<b>9. Power indicator</b>	The indicator color differs depending on the monitor's operation status. Green: Normal operating mode, Orange: Power saving mode, Off: Power off

## Rear

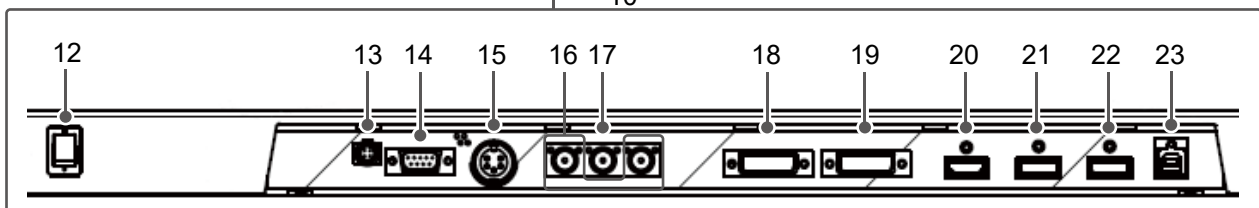
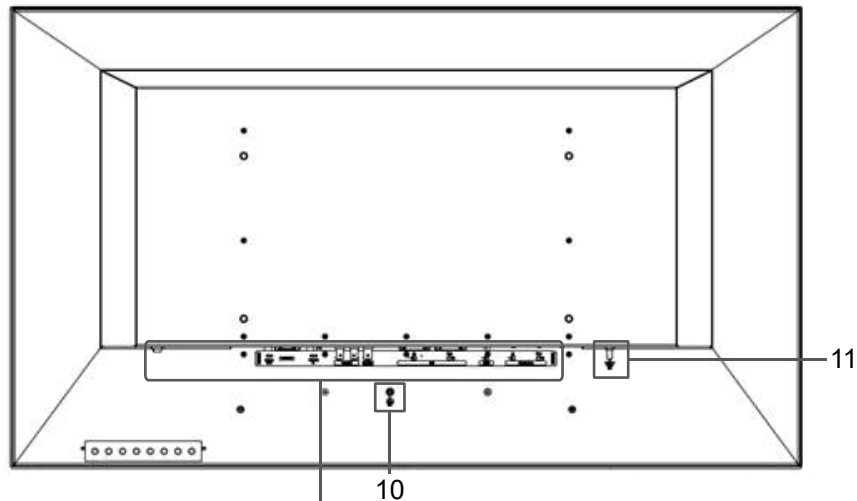

<b>10. Grounding screw</b>	The additional protective conductor is connected to the grounding screw.
<b>11. Equipotential terminal</b>	The equipotential terminal is used when electric potential between electric devices differs and therefore needs to be equalized. This prevents differences in the potential between devices and conductive parts and minimizes the ground resistance. The equipotential bonding connection on the device can minimize contact voltages from different sources, for example, when the device is used in a system with other devices.
<b>12. Power switch</b>	Turns the power on or off.   : On, ○ : Off
<b>13. DC OUT terminal</b>	Used when providing 5V power to a peripheral device. <b>Attention</b> • Do not connect this to the terminal to measurement devices or medical equipment which will come into contact with a patient.
<b>14. RS-232C terminal (D-Sub 9pin)</b>	Controls this product by connecting it to an external device. Input switching and various adjustments are possible from connected external devices.
<b>15. DC IN terminal</b>	Connects the DC OUT terminal of the AC adapter.
<b>16. SDI 1/2 input terminals (BNC type)</b>	Connect from devices with an SDI output terminal. SDI 1 is compatible with 12G / 6G / 3G / HD-SDI, and SDI 2 is compatible with 3G / HD-SDI.
<b>17. SDI output terminal (BNC type)</b>	The signal into the SDI 1 input terminal is output as is.
<b>18. DVI-D input terminal (DVI-D)</b>	Connect from devices with DVI-D output.
<b>19. DVI-D output terminal (DVI-D)</b>	The signal into the DVI-D input terminal is output as is.
<b>20. HDMI input terminal (HDMI)</b>	Connect from devices with HDMI output.
<b>21. DisplayPort input terminal (DisplayPort)</b>	Connect from devices with DisplayPort output.
<b>22. DisplayPort output terminal (DisplayPort)</b>	The signal into the DisplayPort input terminal is output as is.
<b>23. USB terminal (USB upstream port, Type-B)</b>	For maintenance. Cannot be used.

# Chapter 2 Installation / Connection

## 2-1. Before Installing the Product

Carefully read “[PRECAUTIONS](#)” (page 3) and always follow the instructions.

When installing this product, perform thorough operational testing (of the system, cables, arms, etc.) in the environment where the product will be used.

### ● Installation Requirements

When installing the monitor, ensure that there is adequate space around the sides, back, top, and bottom of the monitor.

---

**Attention**

- Position the monitor so that there is no light to interfere with the screen.
  - Do not use any materials or objects that will cover the monitor or the AC adapter.
-



## 2-2. Installing the Product

This product should be installed using an arm or stand.

### Attention

- When installing, do so by carefully following the information in the User Manual about the arm or stand.
- Ensure the following and select components that comply with the VESA standards.
  - Clearance between the screw holes: 400 mm × 200 mm
  - Strong enough to support the weight of the monitor unit (excluding the stand) and attachments such as cables.
- Use the supplied screws when installing.
- Please follow the specifications for the screw tightening torque. If the tightening is not performed correctly, the attached part may be damaged, which may result in injury or equipment damage.
- When using an arm or stand, attach it to achieve the following tilt angles of the monitor.
  - Up 45°, down 45°
- Connect the cables after attaching an arm or stand.
- The monitor, arm, and stand are heavy. Dropping them may result in injury or equipment damage.
- Periodically check the tightness of the screws. If not sufficiently tight, the monitor may detach from the arm, which may result in injury or equipment damage.

### 1. Attach the arm or stand to the back of the monitor by aligning the four screw holes and secure the arm or stand using the screws supplied with the monitor.

Screw tightening torque: Max. 8 N·m

Tool required: Allen wrench (No. 2)

#### Rear

Unit: mm

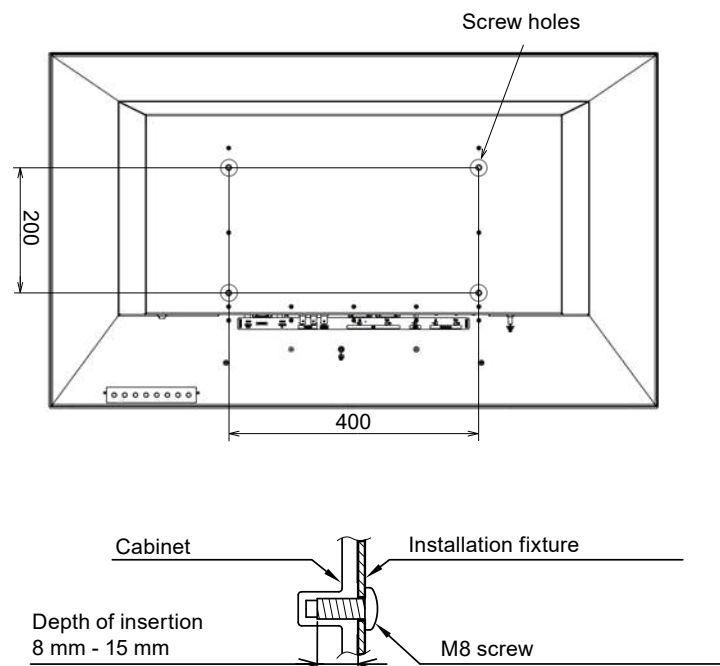

## 2-3. Connecting the Power Cord

### Attention

- Turn off the monitor before connecting it.
- When removing the power cord, always remove the power plug from the power outlet first.

### 1. Connect the power cord to the AC IN terminal on the AC adapter.

Insert the power cord all the way to the back.

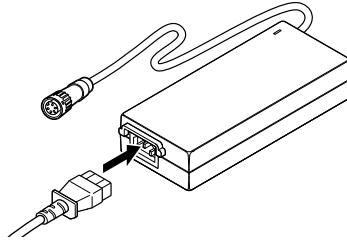

### 2. Connect the DC OUT terminal of the AC adapter to the DC IN terminal on the monitor.

Align the connector shape with the port shape, rotate the lock ring clockwise, and fix it securely.

### Note

- If the lock ring is stiff and does not rotate, push it further into the monitor and try again to rotate it.

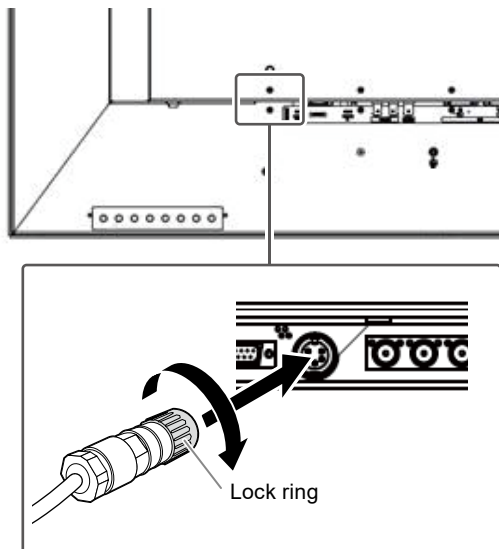

### 3. Check the rated value on the AC adapter and connect the power plug to the power outlet.

### Attention

- If the AC adapter is installed vertically, make sure the AC inlet is not at the top.

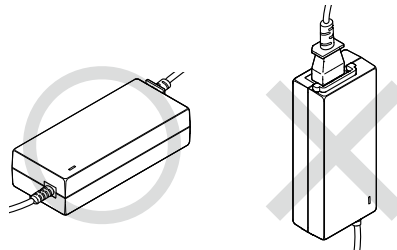

Correct: Horizontal position      Incorrect: Vertical position

- Secure the adapter using a banding band such as a cable tie as necessary to prevent it from dropping.

## 2-4. Connecting the Cables

### 1. Connect the cables appropriate for the device to be used.

If you connected the HDMI cable to the monitor, be sure to secure the HDMI cable with the HDMI cable holder.

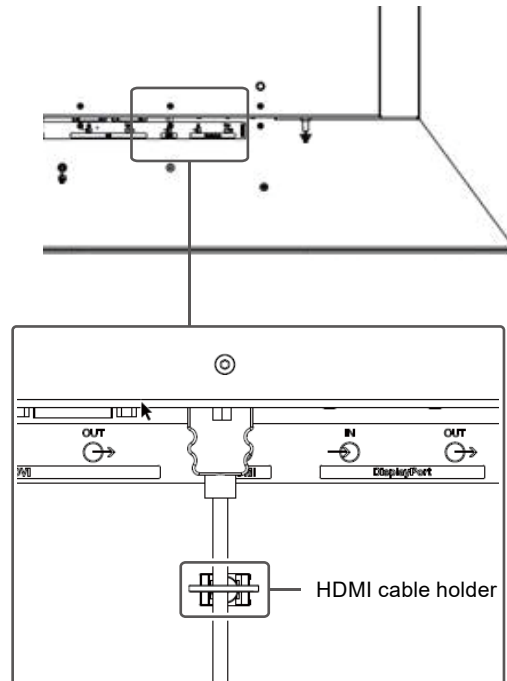

#### Attention

- Do not use damaged cables.
- Do not connect or disconnect the signal cable while the monitor is turned on.
- The SDI terminal, DVI-D terminal, DisplayPort terminal and HDMI terminal are vulnerable to static electricity, therefore exercise caution when installing. When working with the monitor, be sure to observe the following:
  - Do not touch the connector pins.
  - Do not touch pins at the end of any cable connected to a connector.
  - Take anti-static precautions such as using an anti-static wrist strap when working.

## 2-5. Installing the Cable Cover

---

1. Align the cable cover on the back of the monitor in such a way that the cables can go through the cable outlet port.
2. Insert the cable cover tabs into the grooves in the monitor.
3. Tighten the screws at the left and right-hand holes on the back side of the monitor.

---

### Attention

- Ensure that cables are not pinched between the cable cover and the monitor.
  - Securely tighten the screws in the two locations. (Screw tightening torque: 0.4 N·m to 0.7 N·m)
  - Avoid subjecting the terminal and cable to stress.
- 

## 2-6. Turning On the Power

---

1. Turn on the power switch on the back side of the monitor, and then turn on the monitor.

The power indicator on the front of the monitor lights up green.

If the indicator does not light up, see [“Chapter 3 If No Image Is Displayed” \(page 21\)](#).

---

### Note

- If the power switch on the back side of the monitor is turned off, the monitor is turned off.
-

## Chapter 3 If No Image Is Displayed

Problem	Possible cause and remedy
<p><b>1. No picture</b></p>	<ul style="list-style-type: none"> <li>• Check whether the power cord is connected properly.</li> <li>• Check whether the DC OUT terminal and DC IN terminal are connected properly.</li> <li>• Turn on the power switch.</li> <li>• Check whether the main power indicator of the AC adapter is on.</li> <li>• Turn off the power, and then turn it on again.</li> </ul>
<p><b>2. The message below appears.</b></p> <ul style="list-style-type: none"> <li>• This message appears when no signal is input. Example:</li> </ul> <div data-bbox="295 692 614 808" style="background-color: black; color: white; padding: 10px; text-align: center;"> <p>DisplayPort No Signal</p> </div> <ul style="list-style-type: none"> <li>• The message indicates that the input signal is outside the specified frequency range. Example:</li> </ul> <div data-bbox="295 934 614 1050" style="background-color: black; color: white; padding: 10px; text-align: center;"> <p>DisplayPort Signal Error</p> </div>	<p>This message appears when the signal is not input correctly even though the monitor is functioning properly.</p> <ul style="list-style-type: none"> <li>• The message shown on the left may appear, because some devices to be connected do not output the signal immediately after power-on.</li> <li>• Check whether the device to be connected is turned on.</li> <li>• Check whether the signal cable is connected properly.</li> <li>• Turn off the power, and then turn it on again.</li> </ul> <hr/> <ul style="list-style-type: none"> <li>• Check whether the device to be connected is configured to meet the resolution and vertical scan frequency requirements of the monitor (See <a href="#">“4-2. Displayable Input Signals”</a> (page 24)).</li> <li>• Reboot the device to be connected.</li> </ul>

# Chapter 4 Specifications

## 4-1. Specifications List

### Monitor

LCD Panel		
Type	Color (IPS)	
Backlight	LED	
Size	109.2 cm (43 inch)	
Display resolution (H x V)	3840 × 2160	
Display Size (H x V)	962.0 mm × 554.8 mm	
Pixel Pitch	0.2451 mm × 0.2451 mm	
Viewing Angles (H / V, typical)	178° / 178°	
Brightness (typical)	700 cd/m <sup>2</sup>	
Response Time (typical)	8 ms (gray-to-gray)	
Contrast Ratio (typical)	1000 : 1	
Video Signals		
Input Terminals	SDI 1 (BNC)	12G / 6G / 3G / HD-SDI
	SDI 2 (BNC)	3G / HD-SDI
	DVI (DVI-D) × 1	Single link, HDCP support
	DisplayPort × 1	HDCP support
	HDMI × 1	HDCP 2.0 / 1.4 support
Output Terminals	SDI 1 (BNC)	12G / 6G / 3G / HD-SDI
	DVI (DVI-D) × 1	Single link, HDCP unsupported
	DisplayPort × 1	HDCP unsupported
Monitor Control		
Monitor Control Terminals	RS-232C (D-Sub 9 pin) x 1	
Power		
Input	DC 48 V ± 10%, 3.0 A	
Maximum Power Consumption	140 W or less	
DC OUT terminal	DC 5 V, 2 A	
Physical Specifications		
External dimensions (W × H × D)	974 mm × 567 mm × 79 mm	
Net Weight	Approx. 17 kg	
Protection structure	IP32 (The IPx2 protection level is effective when the monitor is installed so it cannot be put at a slant.)	
Operating Environmental Requirements		
Temperature	0 °C to 35 °C (32 °F to 95 °F)	
Humidity	20% to 85% R.H. (no condensation)	
Air Pressure	540 hPa to 1060 hPa	
Transportation / Storage Environmental Requirements		
Temperature	-20 °C to 60 °C (-4 °F to 140 °F)	
Humidity	10% to 85% R.H. (no condensation)	
Air Pressure	200 hPa to 1060 hPa	

## AC adapter

<b>Power</b>	
Input	100 - 240 VAC $\pm$ 10%, 50 / 60 Hz, 3.0 A
Maximum Power Consumption	140 W or less
<b>Physical Specifications</b>	
External dimensions (W $\times$ H $\times$ D)	223.0 mm $\times$ 37.0 mm $\times$ 88.5 mm
Net Weight	Approx. 1.1 kg
<b>Operating Environmental Requirements</b>	
Temperature	0 °C to 35 °C (32 °F to 95 °F)
Humidity	20% to 85% R.H. (no condensation)
Air Pressure	540 hPa to 1060 hPa
<b>Transportation / Storage Environmental Requirements</b>	
Temperature	-20 °C to 60 °C (-4 °F to 140 °F)
Humidity	10% to 90% R.H. (no condensation)
Air Pressure	540 hPa to 1060 hPa

## 4-2. Displayable Input Signals

✓: Supported

-: Not Supported

Resolution	Scan Format	Vertical Scan Frequency (Hz)	DisplayPort	HDMI	DVI-D	SDI
640 × 480	Progressive	59.940	✓	✓	✓	-
800 × 600	Progressive	60.317	✓	✓	✓	-
1024 × 768	Progressive	60.004	✓	✓	✓	-
1280 × 800	Progressive	59.810	✓	✓	✓	-
1280 × 960	Progressive	60.000	✓	✓	✓	-
1280 × 1024	Progressive	60.020	✓	✓	✓	-
1600 × 1200	Progressive	60.000	✓	✓	✓	-
1920 × 1200	Progressive	59.950	✓	✓	✓	-
1280 × 720	Progressive	60.000	-	✓	✓	✓
1280 × 720	Progressive	59.940	-	✓	✓	✓
1280 × 720	Progressive	25.000	-	✓	✓	✓
1280 × 720	Progressive	29.970	-	✓	✓	✓
1280 × 720	Progressive	30.000	-	✓	✓	✓
1920 × 1080	Progressive	60.000	✓	✓	✓	✓
1920 × 1080	Progressive	59.940	✓	✓	✓	✓
1920 × 1080	Interlace	60.000	-	✓	✓	✓
1920 × 1080	Interlace	59.940	-	✓	✓	✓
720 × 480	Progressive	60.000	-	✓ *1	✓ *1	-
720 × 480	Progressive	59.940	-	✓ *1	✓ *1	-
720 × 576	Progressive	50.000	-	✓ *1	✓ *1	-
1280 × 720	Progressive	50.000	-	✓	✓	✓
1920 × 1080	Progressive	50.000	✓	✓	✓	✓
1920 × 1080	Interlace	50.000	-	✓	✓	✓
1920 × 1080	Progressive	24.000	-	-	✓	✓
1920 × 1080	Progressive	23.976	-	-	✓	✓
1920 × 1080	Progressive	25.000	-	✓	✓	✓
1920 × 1080	Progressive	30.000	-	✓	✓	✓
1920 × 1080	Progressive	29.970	-	✓	✓	✓
3840 × 2160	Progressive	30.000	-	✓	-	✓
3840 × 2160	Progressive	29.970	-	✓	-	✓
3840 × 2160	Progressive	25.000	-	✓	-	✓
3840 × 2160	Progressive	24.000	-	-	-	✓
3840 × 2160	Progressive	23.976	-	-	-	✓
3840 × 2160	Progressive	60.000	✓	✓	-	✓
3840 × 2160	Progressive	59.940	✓	✓	-	✓
3840 × 2160	Progressive	50.000	✓	✓	-	✓

\*1 Not compatible with 16:9 aspect ratio displays.



# Appendix

## Medical Standard

---

- Anyone who connects additional equipment to the signal input parts or signal output parts when configuring a medical system is responsible for ensuring that the system complies with the requirements of IEC/EN60601-1.
- Power-supplied equipment can emit electromagnetic waves that could influence, limit or result in malfunction of the monitor. Install the equipment in a controlled environment in which such effects are avoided.

### Classification of Equipment

- Electric shock protection type: Class I
- EMC class: EN60601-1-2:2015 Group 1 Class A
- Medical device classification (EU): Class I
- Mode of operation: Continuous
- IP class: IP32 (The IPx2 protection level is effective when the monitor is installed so it cannot be put at a slant.)

# EMC Information

---

The performance of the EX4342 ensures appropriate display of images.

## Intended Use Environments

The EX4342 is intended to be used in professional healthcare facility environments such as clinics and hospitals (including use in the vicinity of high-frequency surgical equipment such as electrosurgical knives).

The following environments are not suitable for using the EX4342.

- Home healthcare environments
- In the vicinity of short-wave therapy equipment
- RF shielded room of MRI medical equipment systems
- In shielded special environments
- Installed in vehicles including ambulances
- Other special environments



## WARNING

---

**The EX4342 requires special precautions regarding EMC and during installation. You need to carefully read the EMC Information and the “PRECAUTIONS” section of this document, and observe the following instructions when installing and operating the product.**

---

**The EX4342 should not be used adjacent to or stacked with other equipment. If adjacent or stacked use is necessary, the equipment or system should be observed to check for normal operation in the configuration in which it will be used.**

---

**When using portable RF communication equipment, keep it 30 cm (12 inches) or more away from any part, including cables, of the EX4342. Otherwise, degradation of the performance of this equipment could result.**

---

**Anyone who connects additional equipment to the signal input parts or signal output parts when configuring a medical system is responsible for ensuring that the system complies with the requirements of IEC/EN60601-1-2.**

---

**Images may be distorted if the product is used near a device such as high-frequency surgical equipment. Check in advance to ensure that no problems occur during use.**

---

**Only use the cables included in the scope of delivery or recommended by the manufacturer. The use of other cables can result in increased electromagnetic radiation and reduced electromagnetic interference immunity of the device, as well as improper use.**

---

**Cable length: max. 3 m**

---

## Technical Specifications

<b>Electromagnetic emissions</b>		
The EX4342 is intended for use in the electromagnetic environment specified below. The customer or the user of the EX4342 should assure that it is used in such an environment.		
<b>Emission test</b>	<b>Compliance</b>	<b>Electromagnetic environment - Guidance</b>
RF emissions CISPR11 / EN55011	Group 1	The EX4342 uses RF energy only for its internal function. Therefore, its RF emissions are very low and not likely to cause any interference in nearby electronic equipment.
RF emissions CISPR11 / EN55011	Class A	The EMISSIONS characteristics of the EX4342 make it suitable for use in industrial areas and hospitals (CISPR11 class A). If it is used in a residential environment (for which CISPR11 class B is normally required) the EX4342 might not offer adequate protection to radio-frequency communication services. The user might need to take mitigation measures, such as relocating or re-orienting the equipment.
Harmonic emissions IEC / EN61000-3-2	Class D	
Voltage fluctuations / flicker emissions IEC / EN61000-3-3	Complies	

<b>Electromagnetic immunity</b>			
The EX4342 has been tested at the following compliance levels according to the testing requirements for professional healthcare facility environments defined in IEC / EN60601-1-2. Customers and users of the EX4342 must ensure that the EX4342 is used in the following environments:			
<b>Immunity test</b>	<b>Test level for professional healthcare facility environments</b>	<b>Compliance level</b>	<b>Electromagnetic environment - Guidance</b>
Electrostatic discharge (ESD) IEC / EN61000-4-2	±8 kV contact discharge ±2, 4, 8, 15 kV air discharge	±8 kV contact discharge ±2, 4, 8, 15 kV air discharge	Floors should be wood, concrete or ceramic tile. If floors are covered with synthetic material, the relative humidity should be at least 30%.
Electrical fast transients / bursts IEC / EN61000-4-4	±2 kV power lines ±1 kV input / output lines	±2 kV power lines ±1 kV input / output lines	Mains power quality should be that of a typical commercial or hospital environment.
Surges IEC / EN61000-4-5	±1 kV line to line ±2 kV line to ground	±1 kV line to line ±2 kV line to ground	Mains power quality should be that of a typical commercial or hospital environment.
Voltage dips, short interruptions and voltage variations on power supply input lines IEC / EN61000-4-11	0 % $U_T$ (100 % dip in $U_T$ ) 0.5 cycles and 1 cycle 70 % $U_T$ (30 % dip in $U_T$ ) 25 cycles 0 % $U_T$ (100 % dip in $U_T$ ) 5 sec	0 % $U_T$ (100 % dip in $U_T$ ) 0.5 cycles and 1 cycle 70 % $U_T$ (30 % dip in $U_T$ ) 25 cycles 0 % $U_T$ (100 % dip in $U_T$ ) 5 sec	Mains power quality should be that of a typical commercial or hospital environment. If the user of the EX4342 requires continued operation during power mains interruptions, it is recommended that the EX4342 be powered from an uninterruptible power supply or a battery.
Power frequency magnetic fields IEC / EN61000-4-8	30 A/m (50 / 60 Hz)	30 A/m	Power frequency magnetic fields should be at levels characteristic of a typical location in a typical commercial or hospital environment. The product should be kept at least 15 cm away from the source of power frequency magnetic fields during use.

<b>Electromagnetic immunity</b>			
The EX4342 has been tested at the following compliance levels according to the testing requirements for professional healthcare facility environments defined in IEC / EN60601-1-2.			
Customers and users of the EX4342 must ensure that the EX4342 is used in the following environments:			
<b>Immunity test</b>	<b>Test level for professional healthcare facility environments</b>	<b>Compliance level</b>	<b>Electromagnetic environment - Guidance</b>
Conducted disturbances induced by RF fields IEC / EN61000-4-6	3 Vrms 150 kHz - 80 MHz	3 Vrms	Portable and mobile RF communications equipment should be used no closer to any part of the EX4342, including cables, than the recommended separation distance calculated from the equation applicable to the frequency of the transmitter. Recommended separation distance $d = 1.2\sqrt{P}$  $d = 1.2\sqrt{P}$ , 80 MHz - 800 MHz $d = 2.3\sqrt{P}$ , 800 MHz - 2.7 GHz  Where "P" is the maximum output power rating of the transmitter in watts (W) according to the transmitter manufacturer and "d" is the recommended separation distance in meters (m).  Field strengths from fixed RF transmitters, as determined by an electromagnetic site survey <sup>a)</sup> , should be less than the compliance level in each frequency range <sup>b)</sup> .  Interference may occur in the vicinity of equipment marked with the following symbol.  
	6 Vrms ISM bands between 150 kHz and 80 MHz	6 Vrms	
Radiated RF fields IEC / EN61000-4-3	3 V/m 80 MHz - 2.7 GHz	3 V/m	
Note 1	U <sub>T</sub> is the a.c. mains voltage prior to application of the test level.		
Note 2	At 80 MHz and 800 MHz, the higher frequency range applies.		
Note 3	Guidelines regarding conducted disturbances induced by RF fields or radiated RF fields may not apply in all situations. Electromagnetic propagation is affected by absorption and reflection from structures, objects and people.		
Note 4	The ISM bands between 150 kHz and 80 MHz are 6.765 MHz to 6.795 MHz, 13.553 MHz to 13.567 MHz, 26.957 MHz to 27.283 MHz, and 40.66 MHz to 40.70 MHz.		
a)	Field strengths from fixed transmitters, such as base stations for radio (cellular/cordless) telephones and land mobile radios, amateur radio, AM and FM radio broadcast and TV broadcast cannot be predicted theoretically with accuracy. To assess the electromagnetic environment due to fixed RF transmitters, an electromagnetic site survey should be considered. If the measured field strength in the location in which the EX4342 is used exceeds the applicable RF compliance level above, the EX4342 should be observed to verify normal operation. If abnormal performance is observed, additional measures may be necessary, such as reorienting or relocating the EX4342.		
b)	Over the frequency range 150 kHz to 80 MHz, field strengths should be less than 3 V/m.		

### Recommended separation distances between portable or mobile RF communication equipment and the EX4342

The EX4342 is intended for use in an electromagnetic environment in which radiated RF disturbances are controlled. The customer or the user of the EX4342 can help prevent electromagnetic interference by maintaining a minimum distance between portable and mobile RF communications equipment (transmitters) and the EX4342. Immunity to proximity fields from the following RF wireless communication equipment has been confirmed:

Test frequency (MHz)	Bandwidth <sup>a)</sup> (MHz)	Service <sup>a)</sup>	Modulation <sup>b)</sup>	Maximum power (W)	Minimum separation distance (m)	IEC / EN60601 test level (V/m)	Compliance level (V/m)
385	380 - 390	TETRA 400	Pulse modulation <sup>b)</sup> 18 Hz	1.8	0.3	27	27
450	430 - 470	GMRS 460, FRS 460	FM ±5 kHz deviation 1 kHz sine	2	0.3	28	28
710 745 780	704 - 787	LTE Band 13, 17	Pulse modulation <sup>b)</sup> 217 Hz	0.2	0.3	9	9
810 870 930	800 - 960	GSM 800 / 900, TETRA 800, iDEN 820 CDMA 850, LTE Band 5	Pulse modulation <sup>b)</sup> 18 Hz	2	0.3	28	28
1720 1845 1970	1700 - 1990	GSM 1800; CDMA 1900; GSM 1900; DECT; LTE Band 1, 3, 4, 25; UMTS	Pulse modulation <sup>b)</sup> 217 Hz	2	0.3	28	28
2450	2400 - 2570	Bluetooth, WLAN, 802.11 b/g/n, RFID 2450, LTE Band 7	Pulse modulation <sup>b)</sup> 217 Hz	2	0.3	28	28
5240 5500 5785	5100 - 5800	WLAN 802.11 a/n	Pulse modulation <sup>b)</sup> 217 Hz	0.2	0.3	9	9

a) For some services, only the uplink frequencies are included.

b) Carrier waves are modulated using a 50 % duty cycle square wave signal.

The EX4342 is intended for use in an electromagnetic environment in which radiated RF disturbances are controlled. For other portable and mobile RF communication equipment (transmitters), the minimum distance between portable and mobile RF communications equipment (transmitters) and the EX4342 should be according to the maximum output power of the communication equipment as recommended below.

Rated maximum output power of transmitter (W)	Separation distance according to frequency of transmitter (m)		
	150 kHz to 80 MHz $d = 1.2\sqrt{P}$	80 MHz to 800 MHz $d = 1.2\sqrt{P}$	800 MHz to 2.7 GHz $d = 2.3\sqrt{P}$
0.01	0.12	0.12	0.23
0.1	0.38	0.38	0.73
1	1.2	1.2	2.3
10	3.8	3.8	7.3
100	12	12	23

For transmitters rated at a maximum output power not listed above, the recommended separation distance "d" in meters (m) can be estimated using the equation applicable to the frequency of the transmitter, where "P" is the maximum output power rating of the transmitter in watts (W) according to the transmitter manufacturer.

Note 1 At 80 MHz and 800 MHz, the separation distance for a higher frequency range applies.

Note 2 These guidelines may not apply in all situations. Electromagnetic propagation is affected by absorption and reflection from structures, objects and people.

# Warning for Radio interference

For U.S.A., Canada Only

## FCC Supplier's Declaration of Conformity

We, the Responsible Party

EIZO Inc.

5710 Warland Drive, Cypress, CA 90630

Phone: (562) 431-5011

declare that the product

Trade name: EIZO

Model: CuratOR EX4342

is in conformity with Part 15 of the FCC Rules. Operation of this product is subject to the following two conditions: (1) this device may not cause harmful interference, and (2) this device must accept any interference received, including interference that may cause undesired operation.

### WARNING!

This equipment has been tested and found to comply with the limits for a Class A digital device, pursuant to Part 15 of the FCC Rules. These limits are designed to provide reasonable protection against harmful interference when the equipment is operated in a commercial environment. This equipment generates, uses, and can radiate radio frequency energy and if not installed and used in accordance with the instruction manual, may cause harmful interference to radio communications. Operation of this equipment in a residential area is likely to cause harmful interference in which case the user will be required to correct the interference at his own expense.

Changes or modifications not expressly approved by the party responsible for compliance could void the user's authority to operate the equipment.

#### Note

Use the specified cable below or EIZO signal cable with this monitor so as to keep interference within the limits of a Class A digital device.

- AC Cord
- Shielded Signal Cable

## Canadian Notice

This Class A information technology equipment complies with Canadian ICES-003.

Cet équipement informatique de classe A est conforme à la norme NMB-003 du Canada.

# 中国在 ChinaRoHS 中为 RoHS 合规性采取的措施

## 关于电器电子产品有害物质限制使用标识



本标识根据「电器电子产品有害物质限制使用管理办法」，适用于在中华人民共和国销售的电器电子产品。标识中央的数字为环保使用期限的年数。只要您遵守该产品相关的安全及使用注意事项，在自制造日起算的年限内，不会产生对环境污染或人体及财产的影响。上述标识粘贴在机器背面。下表是依据 SJ/T 11364-2014 的规定编制。

### 产品中有害物质的名称及含量

部件名称	有害物质					
	铅 (Pb)	汞 (Hg)	镉 (Cd)	六价铬 (Cr (VI))	多溴联苯 (PBB)	多溴二苯醚 (PBDE)
印刷电路板	○	○	○	○	○	○
机箱 / 支架	○	○	○	○	○	○
显示屏组件	○	○	○	○	○	○
其他	○	○	○	○	○	○

本表格依据 SJ/T 11364 的规定编制。

○ : 表示该有害物质在该部件所有均质材料中的含量均在 GB/T 26572 规定的限量要求以下。

× : 表示该有害物质至少在该部件的某一均质材料中的含量超出 GB/T 26572 规定的限量要求。

## Repairs

Please contact the sales partner from whom you purchased the product with the serial number of the product. The serial number is the 8-digit number displayed on the label back of the main unit.

# 保証

## 保証規定

1. この製品の取扱説明書、本体添付ラベルなどの注意書に従った使用状態で保証期間内に故障した場合、無償で故障箇所の修理または交換をいたします。お買い上げの販売店またはEIZOメンテナンスセンターにお申しつけください。
2. 保証期間内でも次のような場合には、有償となります。
  - 使用上の誤り、または不当な修理や改造による故障および損傷
  - お買い上げの後の輸送・移動・落下などによる故障および損傷
  - 火災・地震・水害・落雷・その他の天災地変ならびに公害や異常電圧などの外部要因や、塵・埃に起因する故障および損傷
  - 強い振動や衝撃を受ける場所に搭載された場合に生じる故障および損傷
  - 当社が想定する使用環境や使用状況を逸脱した場合
  - 電池の液漏れによる故障及び損傷
  - 液晶パネル、バックライトの経年劣化（輝度の変化、色の変化、輝度と色の均一性の変化、焼き付き、欠点の増加など）
  - センサー経年変化による性能劣化（測定値の変化など）
  - 外装品（液晶パネルの表面を含む）の損傷、変色、劣化
  - 付属品（ケーブル、取扱説明書、CD-ROM など）の故障、損傷、劣化、紛失
  - 当社指定の消耗品（電池、リモコン、タッチペンなど）の故障、損傷、劣化、紛失
  - 塵・埃などの外的要因による冷却ファンの異音、回転不良
  - 技術革新などにより製品に互換性がなくなった場合
3. 修理の際に当社の品質基準に達した再生部品を使用することがあります。
4. 修理状況や補修用性能部品の在庫切れなどにより修理できない場合は、修理に代えて同等性能製品への置き換えを提案させていただきますことがあります。
5. 当社は、この製品の使用または故障により生じた直接、間接（逸失利益などを含む）のいかなる損害について責任を負いません。また、この製品の記憶装置に記録された内容の消失などについても同様です。
6. 当保証規定は日本国内においてのみ有効です。 This warranty is valid only in Japan.



# アフターサービス

## 修理を依頼されるとき

### 保証期間中の場合

保証規定に従い、EIZO メンテナンスセンターにて修理または交換をさせていただきます。お買い求めの販売店、または EIZO メンテナンスセンターにご連絡ください。

### 保証期間を過ぎている場合

お買い求めの販売店、または EIZO メンテナンスセンターにご相談ください。修理範囲（サービス内容）、修理費用の目安、修理期間、修理手続きなどを説明いたします。

## 修理を依頼される場合にお知らせいただきたい内容

- お名前、ご連絡先の住所、電話番号 / FAX 番号
- お買い上げ年月日、販売店名
- 製品名、製造番号（製造番号は、本体の背面部のラベルに表示されている 8 桁の番号です。）
- 使用環境（コンピュータ / グラフィックスボード / OS、システムのバージョン / 表示解像度など）
- 故障または異常の内容（できるだけ詳細に）

## 製品回収、リサイクルシステムについて

パソコン及びパソコン用モニターは「資源有効利用促進法」の指定再資源化製品に指定されており、メーカーは自主回収及び再資源化に取り組むことが求められています。

当社製品は、一般社団法人「パソコン 3R 推進協会」が回収させていただきます。

回収を希望されるお客様は当社の Web サイトよりお申し込みください。

([www.eizo.co.jp](http://www.eizo.co.jp))

※ この製品は業務用途を意図した製品ですので、ご使用後廃棄される場合は有償となります。



**EIZO GmbH**

Carl-Benz-Straße 3, 76761 Rülzheim, Germany

**EIZO Limited** UK Responsible Person

1 Queens Square, Ascot Business Park, Lyndhurst Road,  
Ascot, Berkshire, SL5 9FE, UK

**EIZO AG** CH REP

Moosacherstrasse 6, Au, CH-8820 Wädenswil, Switzerland

Copyright © 2022 EIZO GmbH. All rights reserved.



CuratOR EX4342  
Instructions for Use  
1086011-002

2nd Edition - July, 2022