

GV-SNVR3203, GV-SNVR6403

User's Manual





© 2022 GeoVision, Inc. All rights reserved.

Under the copyright laws, this manual may not be copied, in whole or in part, without the written consent of GeoVision.

Every effort has been made to ensure that the information in this manual is accurate. GeoVision, Inc. makes no expressed or implied warranty of any kind and assumes no responsibility for errors or omissions. No liability is assumed for incidental or consequential damages arising from the use of the information or products contained herein. Features and specifications are subject to change without notice.

GeoVision, Inc.
9F, No. 246, Sec. 1, Neihu Rd.,
Neihu District, Taipei, Taiwan
Tel: +886-2-8797-8377
Fax: +886-2-8797-8335
<http://www.geovision.com.tw>

Trademarks used in this manual: *GeoVision*, the *GeoVision* logo and *GV* series products are trademarks of GeoVision, Inc. *Windows* is the registered trademark of Microsoft Corporation.

August 2022

Scan the following QR codes for product warranty and technical support policy:



[Warranty]



[Technical Support Policy]

Thank you for purchasing our product. Contact your local dealer if you have any questions or feedback. No part of this manual may be copied, reproduced, translated, or distributed in any form or by any means without prior consent in writing from our company.

Disclaimer





CAUTION!

- The default password is intended only for your first login. We strongly recommend you set a strong password to ensure account security.
 - Strong: contains at least 9 characters comprising all three elements: letter, special character, digit.
 - Weak: contains at least 8 characters from two of the four types: upper-case letter, lower-case letter, special character, digit.
-
- To the maximum extent permitted by applicable law, the product described, with its hardware, software, firmware, and documents, is provided on an "as is" basis.
 - Best effort has been made to verify the integrity and correctness of the contents in this manual, but no statement, information, or recommendation in this manual shall constitute formal guarantee of any kind, expressed or implied. We shall not be held responsible for any technical or typographical errors in this manual. The contents of this manual are subject to change without prior notice. Update will be added to the new version of this manual.

- Use of this manual and the product and the subsequent result shall be entirely on the user's own responsibility. In no event shall we be liable for any special, consequential, incidental, or indirect damages, including, among others, damages for loss of business profits, business interruption, or loss of data or documentation, or product malfunction or information leakage caused by cyber attack, hacking or virus in connection with the use of this product.
- Video and audio surveillance can be regulated by laws that vary from country to country. Check the law in your local region before using this product for surveillance purposes. We shall not be held responsible for any consequences resulting from illegal operations of the device.
- The illustrations in this manual are for reference only and may vary depending on the version or model. The screenshots in this manual may have been customized to meet specific requirements and user preferences. As a result, some of the examples and functions featured may differ from those displayed on your monitor.
- This manual is a guide for multiple product models and so it is not intended for any specific product.
- Due to uncertainties such as physical environment, discrepancy may exist between the actual values and reference values provided in this manual. The ultimate right to interpretation resides in our company.

Safety Symbols

The symbols in the following table may be found in this manual. Carefully follow the instructions indicated by the symbols to avoid hazardous situations and use the product properly.

Symbol	Description
 WARNING!	Indicates a hazardous situation which, if not avoided, could result in bodily injury or death.
 CAUTION!	Indicates a situation which, if not avoided, could result in damage, data loss or malfunction to product.
 NOTE!	Indicates useful or supplemental information about the use of product.

Contents

Disclaimer	i
Safety Symbols.....	iii
Contents	iv
Preface.....	viii
Part I Local Operations.....	1
1 Before You Begin	2
1.1 User Login.....	2
1.2 Local Operations	3
2 Initial Configuration	10
2.1 Preparation	10
2.2 Device Login.....	10
2.3 Wizard	12
3 Live View	15
3.1 Live View Status	15
3.2 Sequence Operation	19
3.3 Zoom.....	21
3.4 Image Configuration	21
3.5 Preview Configuration	22
4 Channel Configuration	24
4.1 Channel Management.....	24
4.2 OSD Configuration	36
4.3 Image Configuration	38
4.4 Privacy Mask Configuration	44
5 PTZ Control.....	46
5.1 PTZ Control Window and PTZ Management Window	46

5.2 Setting and Calling a Preset	47
5.3 Setting a Preset Patrol	49
5.4 Setting a Recorded Patrol	50
5.5 Setting Auto Guard	51
6 Recording and Snapshot.....	52
6.1 Encoding Settings.....	52
6.2 Draw or Edit a Schedule	56
6.3 Scheduled Recording and Snapshot	58
6.4 Motion Detection Recording and Snapshot	58
6.5 Alarm Triggered Recording and Snapshot	61
6.6 Manual Recording and Snapshot.....	63
6.7 Holiday Recording and Snapshot.....	63
7 Playback.....	66
7.1 Instant Playback.....	66
7.2 Playback Toolbar	67
7.3 Playback by Camera and Date	69
7.4 Playback in Corridor Mode	70
7.5 Playback by Tag	70
7.6 Playback by Motion Detection	71
7.7 Playback by Video Loss.....	72
7.8 Playback by Smart Search	72
7.9 Playback by External File	73
7.10 Playback by Image	73
7.11 File Management.....	74
8 Backup.....	76
8.1 Recording Backup	76
8.2 Image Backup	79
9 Alarm	80
9.1 Alarm Input and Output.....	80

9.2 Motion Detection	82
9.3 Tampering Detection	84
9.4 Human Body Detection	85
9.5 Video Loss	86
9.6 Alert.....	86
9.7 Buzzer	89
9.8 People Present Alarm	89
9.9 One-Key Disarming	90
9.10 Alarm-Triggered Actions.....	90
9.11 Manual Alarm	91
10 VCA	92
10.1 VCA Configuration.....	92
11 Network Configuration	105
11.1 Basic Configuration	105
11.2 Platform Configuration	110
11.3 Advanced Configuration	111
12 Disk Configuration	118
12.1 Disk Management.....	118
12.2 Array Configuration	119
12.3 Disk Group.....	123
12.4 Space Allocation	124
12.5 Advanced Configuration	125
13 System Configuration.....	126
13.1 Basic Configuration	126
13.2 Time Configuration	127
13.3 Serial Configuration.....	128
13.4 User Configuration	128
13.5 Security Configuration	130
13.6 Hot Spare Configuration.....	133

14 System Maintenance	134
14.1 System Information	134
14.2 Network Information	136
14.3 Log Query	138
14.4 Import/Export.....	140
14.5 System Restoration	142
14.6 Automatic Maintenance	142
14.7 System Upgrade	143
14.8 Hard Disk Detection	144
14.9 One-Click Collect.....	145
15 Shutdown	146
Part II Web-Based Operations	147
1 Before You Begin	147
2 Login	148
3 Live View	149
4 Playback	151
5 Configuration	153
Appendix A Typical Applications	154
Typical Application 1	154
Typical Application 2	155
Appendix B Acronyms	156
Appendix C FAQs	157

Preface

This manual describes how to use your NVR locally or on the Web interface.

In this manual, the terms IP camera and IPC refer to the same thing: network camera, which requires a connection to the network. And the IP device mentioned in this manual refers to an IP camera (also known as network camera).

Part I Local Operations

An NVR supports two types of operations: local operations and web-based remote operations. With local operations you connect a monitor and a mouse to the NVR and use the mouse to operate. If your NVR has buttons on the front panel or is delivered with a remote control, you may also control your NVR by pressing the front panel buttons or using the remote control.

The NVR has an embedded web server and allows web-based operations. To do this, you need a PC that has a network connection to the NVR and is installed with a web browser. You just need to navigate to the NVR's IP address and log in to the Web interface like you log in to the system locally.

This section describes local operations.

1 Before You Begin

Please be aware that the parameters that are grayed out on the system user interface (UI) cannot be modified. The parameters and values displayed may vary with device model, and the figures in this manual are for illustration purpose only.

1.1 User Login

Use the default username **admin** and password **123456** for your first login.



CAUTION!

The default password is intended only for the first login and should be changed to a strong one containing at least nine characters including letters, digits and special characters after your first login to ensure security.

1. Right-click anywhere in the window and then choose **Menu**. The login dialog box is displayed.
2. Select the username from the drop-down list, enter your password, and then click **Login**.

1.2 Local Operations

You can refer to [2. Initial Configuration](#) and complete a quick configuration.



NOTE!

Unless otherwise specified, all operations described in this manual are performed with a mouse by the right hand. See [1.2.2 Mouse Operations](#) for details.

1.2.1 Overview

1.2.1.1 GV-SNVR3203 / GV-SNVR6403 Front View



No.	Name	Description
1	LED Indicators	See 1.2.4 Front Panel LED Indicators .
2	Front Panel Buttons	See 1.2.3 Front Panel Buttons .
3	USB 2.0 Ports	Connects to a keyboard, mouse, or USB flash drive.

4	Power Off Button	To shut down the NVR, press this button and hold for at least 3 seconds until a message appears. Click Yes.
---	------------------	---

Note:

1. The shutdown operation can be performed only when you have logged in to the system.
2. To turn on the NVR, switch on the power button at the rear panel. See [1.2.1.2 GV-SNVR3203 / GV-SNVR6403 Rear View](#).

1.2.1.2 GV-SNVR3203 / GV-SNVR6403 Rear View

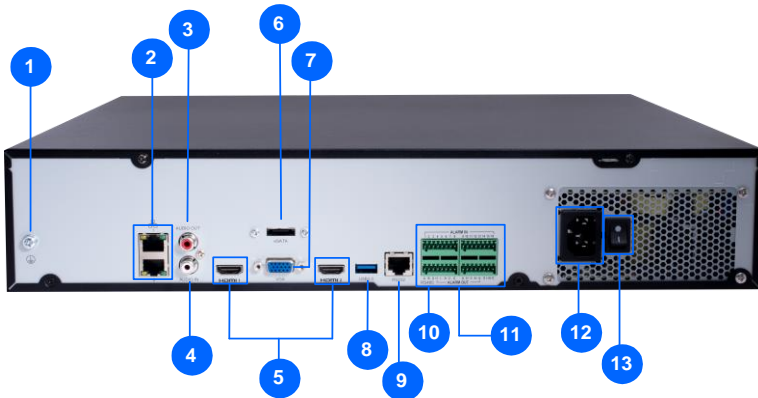

No.	Name	Description
1	Grounding Screw	Fixes the NVR to the ground.
2	Network Ports	Connects to the network.
3	Audio Line Out Port	Connects to a speaker.
4	Audio Line In Port	Connects to a microphone.
5	HDMI Output Ports	Connects to HD TVs.
6	eSATA Port	Connects to external storage devices.
7	VGA Output	Connects to a VGA monitor.

No.	Name	Description
8	USB 3.0 Port	Connects to a keyboard, mouse, or USB flash drive.
9	RS232 Port	Not functional.
10	RS485 Ports	Connects to a PTZ camera.
11	Alarm In/Out Ports	Connects to alarm input/output devices.
12	Power Input	Connects to power supply.
13	Power Button	Turns the system on or off.

Note:

1. HDMI output ports do not support for audio output on the connected monitors.
2. One 4K video output (HDMI) and two 1080p video outputs (HDMI / VGA) are supported.

1.2.2 Mouse Operations

Table 1–1 Mouse Operations

Name	Action	Description
Left button	Click	<ul style="list-style-type: none"> • Select or confirm an item. • Select to edit digits, symbols, upper-case or lower-case letters in a field.
	Double-click	Enter or exit full screen mode in live view.
	Drag	Draw or move a rectangle on the screen, for example, a motion detection area.
Right button	Click	<ul style="list-style-type: none"> • Show the shortcut menu. • Exit zoom. • Exit the current window when Cancel or Exit is displayed.
Wheel	Scroll up or down	Scroll up or down a list or a window; or zoom in or out on a playback progress bar.
	Long press	Restore to lowest resolution.

1.2.3 Front Panel Buttons

The front panel buttons may vary with NVR model.

Table 1–2 Front Panel Buttons 1



















Button	Description
	Display the main menu.
	Switch to the next tab on the screen or switch the input method.
	Auxiliary function button.
	Exit the current window.
	<ul style="list-style-type: none"> • The 4 arrows: Switch windows or menu items; or control rotation directions of a PTZ camera when the PTZ toolbar is closed. PTZ stands for pan, tilt, and zoom. • OK button: Confirm an operation, or start/pause the playback.

Table 1–3 Front Panel Buttons 2

Button	Description
	Enter 1.
	Enter 2, A, B, or C; or start instant playback.
	Enter 3, D, E, or F; or start manual recording.
	Enter 4, G, H, or I; or enter the PTZ control interface.
	Enter 5, J, K, or L; or switch the screen layout in live view or playback mode.
	Enter 6, M, N, or O; or enable or disable arming.
	Enter 7, P, Q, R, or S; or take a snapshot.
	Enter 8, T, U, or V.
	Enter 9, W, X, Y, or Z.
	Enter 0 or a space.
	Delete.
	Switch the input method.
	Auxiliary function button.

Button	Description
	Exit the current window.

1.2.4 Front Panel LED Indicators

Table 1–4 Front Panel LED Indicators

LED	Description
RUN	Steady on: Normal. Blinking: Starting up.
NET	Steady on: Connected to network.
GUARD	Steady on: Arming is enabled.
HD	Blinking: Reading or writing data. Steady on: No disk; disk abnormal.
ALM	Steady on: Device alarm occurred.
CLOUD	Not functional.

2 Initial Configuration

2.1 Preparation

- Make sure that at least one monitor is correctly connected to the VGA or HDMI interface on the rear panel of the NVR.
- Verify that the hard disk(s) are correctly installed. For detailed steps to install a hard disk, please refer to the quick guide shipped with your NVR.

2.2 Device Login

The login page appears after the NVR starts up.

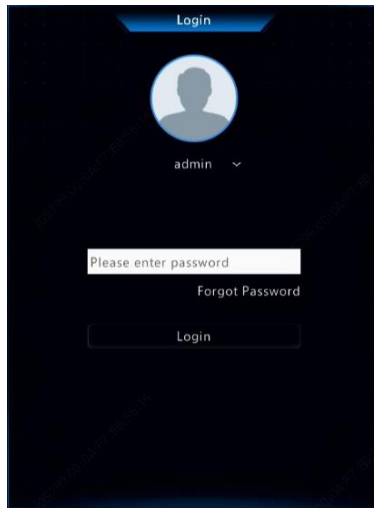

1. Enter the default admin password 123456, click **Login**, and then click **Yes** to change the password.

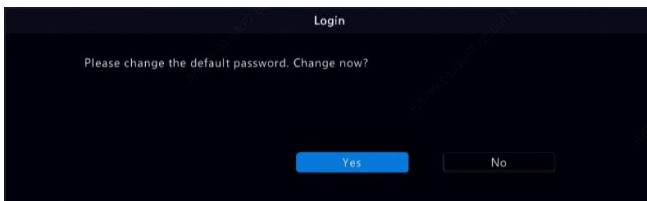

2. Change the password into a strong one, then click **OK**.

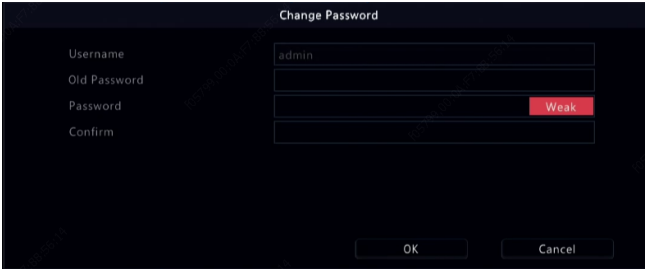

The image shows a 'Change Password' dialog box with a dark background. It contains four input fields: 'Username' (containing 'admin'), 'Old Password', 'Password', and 'Confirm'. The 'Password' field has a red 'Weak' indicator on its right side. At the bottom, there are 'OK' and 'Cancel' buttons.

3. Set the unlock pattern or alternatively click **Skip**.

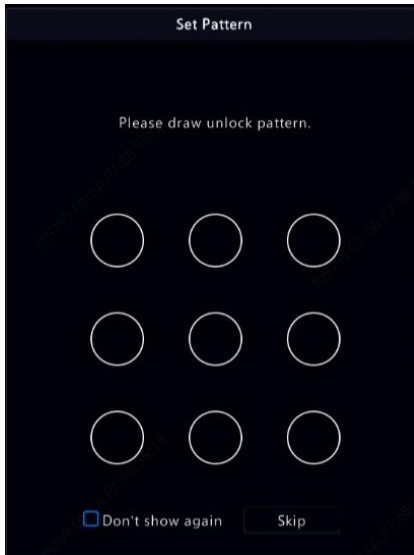

The image shows a 'Set Pattern' dialog box with a dark background. It contains the text 'Please draw unlock pattern.' above a 3x3 grid of white circles. At the bottom, there is a checkbox labeled 'Don't show again' and a 'Skip' button.



NOTE!

To disable unlock pattern, click **System > User**. See [13.3 User Configuration](#) for details.

2.3 Wizard

The wizard can guide you to complete the most basic setup. The following page appears after your login:



1. Enable or disable the wizard as needed and then click **Next**. You may also click .
2. Select the time zone, date and time format, set the system time, and then click **Next**.



- Complete network configuration, and then click **Next**.



- Select the devices to add in the discovered device list, click **Add**, and then click **Yes** to complete configuration.





NOTE!





- To add devices through PoE ports, see Option 3 in [4.1.1 Adding an IP Device](#) for details.
 - The devices added can get online and start live view only if the device password is default; if not, you need to enter the correct device password.
 - If the desired device is not in the device list, you may add it in a preview window or under **Camera > Camera > Camera** (see [4.1.1 Adding an IP Device](#)).
-

3 Live View









3.1 Live View Status







The following icons are used to indicate alarms, recording status, and audio status in a live view window.

Table 3–1 Live View Window Icons







Icon	Description
	Tampering alarm
	Motion detection alarm
	Recording
	Two-way audio





3.1.1 Window Toolbar

Icon	Description
	Available for PTZ cameras only. Click to display the PTZ control window.
	Set mount mode and display mode for fisheye camera. This icon appears only for fisheye cameras.
	Record live video in the window to the hard disk. Click  to stop recording.
	Click to play video recorded during the past 5 minutes and 30 seconds.
	Zoom in on an area of interest.
	Click to edit image settings.
	Click to set OSD.

Icon	Description
	<p>Click to take a snapshot. The window borders will flash white.</p> <p>You may view and back up snapshots under Backup > Image.</p>
	<p>Rest your mouse pointer on the icon to view bitrate info; click this button to view the camera ID and IP address or to change the username and password used to connect the camera.</p>
	<p>Start two-way audio with the camera. Click  to stop. The sound volume is adjustable.</p> <p>Note: Correct audio input and output connections are required.</p>
	<p>Click to turn on audio. Click  to turn off audio. The sound volume is adjustable.</p> <p>Note: When you turn on audio in the current window, audio of the previous window will be turned off.</p>

3.1.2 Screen Toolbar

Icon	Description
	<p>Click to access the main menu.</p>
	<p>Select the screen layout.</p>
	<p>Previous or next screen.</p>
	<p>Start or stop sequence.</p>
	<p>Playback.</p>
	<p>Rest the mouse pointer on this icon to view encoding information including frame rate, bit rate, and resolution; or click to view camera status.</p>

Icon	Description
	Click to view device alarm status and camera status.
	Rest the mouse pointer on it to view NIC card information. Or click this icon to edit basic network settings.
	Rest the mouse pointer on it to view the date. Or click this icon to edit time settings.
	Click to automatically hide the toolbar, or click  to lock.

3.1.3 Shortcut Menu

A shortcut menu as shown below appears when you right-click in a window. Some menu items are described in [Shortcut Menu Description](#).

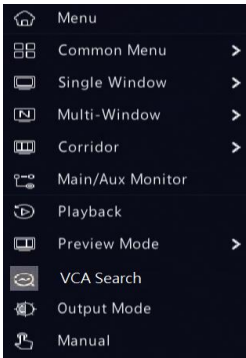
Table 3–2 Shortcut Menu

Table 3–3 Shortcut Menu Description

Menu	Description
Menu	Access the main menu. Most of operations described in this manual are performed from the main menu; for example, click Camera > Camera (or click Menu only to enter the same page).
Common Menu	Quick access to Camera , Net Config , and Backup .
Single Window/Multi-Window	Display different live view layout.
Corridor	Choose a corridor mode. Corridor mode can also be set in the Preview Windows drop-down list under System > Preview . To display images in corridor mode, the camera must be installed correctly (rotated 90° clockwise or counterclockwise), and then use the Image Rotation parameter under Camera > Image to rotate images accordingly.
Main/Aux Monitor	Switch live video from different video output.

Menu	Description
Playback	Play the current day's recording for the camera linked to the current window.
Preview Mode	Switch between Normal and Smart . The default is Normal mode.
VCA Search	Search for data of each VCA function.
Output Mode	Choose a video output mode, including standard, soft, bright, and vivid.
Manual	Manual settings include manual recording, manual snapshot, manual alarm, and buzzer.

3.2 Sequence Operation

The sequence operation requires you to configure the screen layout, windows, linked cameras, and the sequence interval.

This example describes how to configure sequence for five cameras based on a 4-window screen layout.

1. Click **4 Windows** on the screen toolbar.



NOTE!

The number of windows that can be displayed may vary with NVR model.

2. Click **Start Sequence** on the screen toolbar. Sequence starts by displaying four windows on the first screen and then the fifth on the second at the set interval.



NOTE!

- The default sequence interval is eight seconds and can be set under **System > Preview**.
 - You may drag video to the desired window on the screen.
-

3.3 Zoom

Zoom in on an area of images in a window for details.

1. Click the window and then click  on the window toolbar.



2. Move your mouse to the area you want to zoom in, then use your scroll wheel to zoom in and out.
3. Right click to exit zoom.

3.4 Image Configuration

Adjust image settings to get optimal images from a camera.

1. Click the window and then click  on the window toolbar.
2. Select a mode from the drop-down list according to the surveillance scenario, and then adjust contrast, hue, saturation and brightness as needed. The settings available may vary with device model.
3. Click **OK** to save the settings and exit.

3.5 Preview Configuration

Normally, live view (video) is available after you complete the basic setup by following the wizard. You can click **System > Preview** and edit preview setting as needed, including video output, image resolution, default layout, and sequence interval. The video output and the number of windows supported may vary with NVR model.



NOTE!

Pressing and holding the scroll wheel for at least 3 seconds will restore the default resolution.

3.5.1 Preview Configuration

Each preview window (window for short) links to a camera. By default, window 1 links to camera D1, window 2 links to camera D2, and so on. You may want to change the link to display live video from a camera in another specified window. The following example describes how to link window 1 to camera D2 and link window 2 to camera D1.

Step 1: Click window 1 on the right, and then click **D2** under **Camera** on the left. Now **D2** appears in window 1, and **None** appears in window 2. Meanwhile, is cleared for camera D1, meaning D1 is not linked to any window.

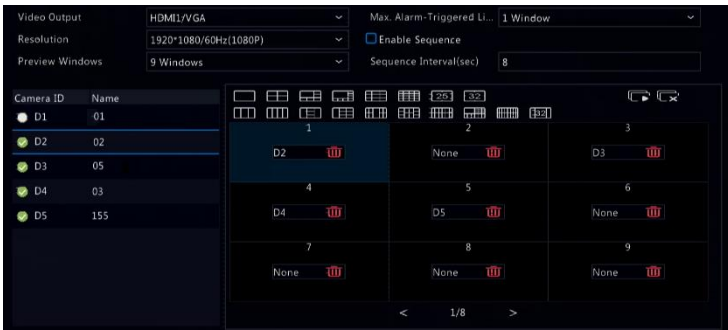

Step 2: Click window 2 on the right, and then click **D1** under **Camera** on the left. Now **D1** appears in window 2. Click **Apply** to save the settings.



3.5.2 Advanced Configuration

Click the **Advanced** tab and then select **Sub Stream First** so the NVR uses the sub stream to establish live video from multiple cameras simultaneously. This function is disabled by default.

4 Channel Configuration

4.1 Channel Management

This chapter describes how to add and manage IP devices in your NVR. The IP devices mentioned in this manual mainly refer to IP camera (or network camera). Before you start, make sure the IP devices are connected to your NVR via network.



CAUTION!

An IP device should be connected to one NVR only. An IP device managed by multiple NVRs may cause unwanted issues.

4.1.1 Adding an IP Device

This section provides multiple options to add an IP device. Choose one as appropriate.

Option 1

1. Click **Camera > Camera > Camera**. The system automatically searches for IP devices and lists the discovered.

Add All		+	Custom Add	🗑️	Delete	↻	Refresh	🔍	Search Segment	⋮	More
<input type="checkbox"/> Camera	IP Address	Status	Protocol	Model	Add/Del	Cam Config	Net Config	Details			
<input type="checkbox"/> D9(IP Camera 09)	206.3.0.29	▶		IPC-B612	🗑️	🔗	🌐	📄			
	192.168.1.32	—	ONVIF	DS-2CD	+	—	🌐	📄			
	203.1.8.11	—	GeoVision	IPC324E	+	—	🌐	📄			
	203.1.8.167	—	GeoVision	IPC3225R3	+	—	🌐	📄			
	206.0.0.127	—	GeoVision	HIC3631	+	—	🌐	📄			
	206.0.0.130	—	GeoVision	HIC3531	+	—	🌐	📄			
	206.0.0.134	—	ONVIF	NVS-DM	+	—	🌐	📄			
	206.2.25.83	—	ONVIF	DS-2CD3	+	—	🌐	📄			
	206.7.10.175	—	ONVIF	DV5411	+	—	🌐	📄			
	206.7.16.100	🔗	GeoVision	IPC332E	+	—	🌐	📄			
	206.7.16.101	🔗	GeoVision	IPC231E-IR	+	—	🌐	📄			
	206.7.16.102	🔗	GeoVision	IPC622L-X2	+	—	🌐	📄			
	206.7.33.13	—	ONVIF	IPC-S214-IR	+	—	🌐	📄			
	206.7.33.19	—	GeoVision	IPC2415-IRS	+	—	🌐	📄			
	206.7.33.27	🔗	GeoVision	IPC-S214-IR@P	+	—	🌐	📄			

Discovered Device(s):158. Added Device(s):13d1e Receive Bandwidth: 62Mbps

2. (Optional) To search a specified network segment, click **Search Segment** and then set the address range.
3. You may choose one of the following ways to add an IP device:
 - Click **Add All** to add all the discovered IP devices allowed (depending on channels supported by the NVR).
 - Click **Custom Add**. In the window displayed, enter the IP address and complete other settings, and then click **Add**. You may also click **Search Segment** and add discovered cameras in the list.
 - Click **+**

Click **+** to add the camera.

Option 2

1. Click **+** in a window.
2. Select the desired IP device and then click **OK**.

Option 3

Use this option to add an IP device that is connected to a different router, for example, when the NVR and the IP device are connected across the Internet.



NOTE!

First you need to enable port mapping at **Setup > Port > Port Mapping** on the IP device's Web interface.

1. Click **Camera > Camera**, click **Custom Add**.
2. Choose an option:

- By IP
 - A. On the IP device's Web interface, go to **Setup > Port > Port Mapping**, find the external IP (public IP) and external port number.
 - B. On the NVR: Select a protocol, enter the above-mentioned IP address and port number. Enter the username and password.
 - C. Click OK.
 - By MyDDNS
 - A. On the IP device's Web interface, go to **Setup > Network > DDNS**, enable DDNS, select **MyDDNS**, set a domain name and get the server address.
-



NOTE!

- After setting the domain name, check that you can use the device address to access the IP device's Web interface.
 - Make sure the MyDDNS server and the NVR are connected (ping the MyDDNS server from the NVR).
-
- B. On the NVR: Select a protocol, enter the above-mentioned server address, domain name, username and password.
 - C. Click OK.

- By a domain name
 - A. On the IP device's Web interface, go to **Setup > Network > DDNS**, enable DDNS, select DynDNS or NO-IP, enter the domain name that you have signed up on the DNS website, enter the username and password, and then click Save.
 - B. On the NVR: Select a protocol, enter the domain name mentioned above, enter the username and password. The port is the external port of the IP device.
 - C. Click OK.
-

**NOTE!**

- If **Custom** is selected for **Protocol**, the port is the mapped external RTSP port of the IP device.
 - Do not add an IP device to an NVR using different methods (e.g., IP and MyDDNS) at the same time.
 - When an IP device is added by MyDDNS, domain name (NO-IP or DynDNS), or IP (public IP + public port) and it is not connected to the same router as the NVR, alarm is configurable, but alarm push is not available.
-

Option 4

Use this option only when the IP device to add supports the standard RTSP, and all you need from the IP device are just view live and playback. IP devices added in this way cannot be configured from the NVR.

1. Click **Camera > Camera**.
2. Click **Custom Add**.

- Click to select a camera in the list, select Custom from the Protocol drop-down list, and then click the **Protocol** button in the lower left corner.

No.	IP Address	Status	Qty	Model
1	192.168.1.32		1	DS-2CD5
2	203.1.8.11		1	IPC324ER3
3	203.1.8.167		1	IPC322SR3
4	206.0.0.127		1	HIC5631-L
5	206.0.0.130		1	HIC3531-IR
6	206.0.0.134		1	NVS-DM36X

Add Mode	IP Address
Protocol	ONVIF
IP Address	192 . 168 . 1 . 32
Port	80
Username	admin
Password	*****
Total Camera Number	1

- In the **Protocol** window, name the protocol, enter the RTSP port number, select a transmission protocol, input the resource paths, and then click **Apply**.

Protocol

Custom	Custom1
Protocol Name	Custom1
Port	554
Transmission Protocol	UDP
Enable Main Stream	<input checked="" type="checkbox"/>
Resource Path	rtsp://<ip>:<port>/
Enable Sub Stream	<input checked="" type="checkbox"/>
Resource Path	rtsp://<ip>:<port>/

Example : rtsp://<IP address>:<Port number>/<Resource path>

One channel :
rtsp://192.168.0.1:554/unicast/c1/s0/live

Multi-channel :
rtsp://192.168.0.1:554/unicast/c[%C]/s0/live Add selected camera ID
rtsp://192.168.0.1:554/unicast/c[%C+1]/s0/live Add selected camera ID+1
rtsp://192.168.0.1:554/unicast/c[%C-1]/s0/live Add selected camera ID-1
[%C±N] : %C means the remote camera ID selected, N means offset





NOTE!

Contact the camera manufacturer for resource paths.

5. Edit settings in the **Add/Modify** window as needed, including the IP address, username and password, and then click **Add**. Check status in the camera list.

4.1.2 Managing an IP Device

Manage IP devices under **Camera > Camera > Camera**.

- Click  to edit settings including the protocol, IP address, port number, username and password. The **IP Address** field displays the IP address that the current channel links to, and you may change the address so the channel links to another device. The username and password must be consistent with that of the IP camera.
- Click  to delete an IP device, or select multiple IP devices and then click **Delete**.
- Click  to change the IP address of an IP camera and the default gateway.

4.1.3 Sort Cameras



Sort cameras to display in the desired order.



NOTE!

- This chapter describes how to sort cameras on an NVR with more than 32 channels. For NVRs with 32 channels or less, you can sort cameras by dragging the mouse.

For example, to switch channel 1 with channel 4, click , and choose **Sort Camera**, and then follow the steps below:

1. In the left list, select the check box for channel 1, and then click . Channel 1 now appears in the right list. Perform the same operations to channel 4.
2. In the right list, select channel 4 and then click . Now channel 4 appears at the previous line of channel 1 in the list. Perform the same operations to channel 1, so channel 1 appears at the previous line of channel 4 in the list.
3. Click **Apply** to save the setting, and then click **Yes**.

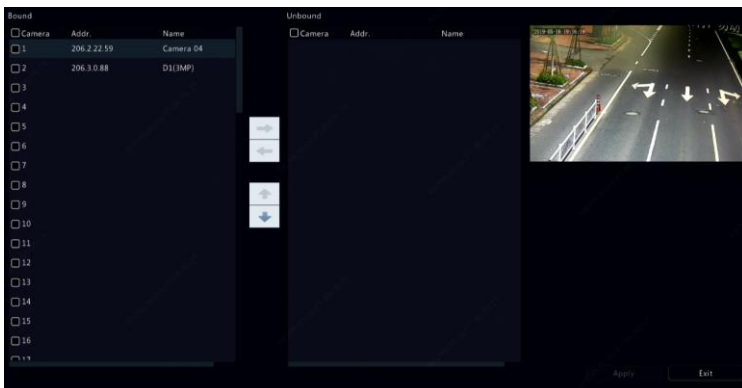



NOTE!

- To move a channel left or right, select the check box first; otherwise, the buttons are grayed.
 - To move a channel up or down, click the channel first; otherwise, the buttons are grayed.
 - A channel will be inserted to the first blank line in the left list unless you have specified another line in the list by selecting the corresponding check box.
 - **Save** cannot be clicked when the right list is not empty. You need to clear the list first.
-

4.1.4 Batch Edit Password

If the password you used to add the cameras is incorrect, use this function to batch edit the password used for authentication.



NOTE!

The cameras can be added to NVR successfully only when the authentication password is correct.

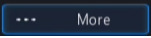
1. Select the cameras with the same password.
 2. Click  **More**, and then select **Batch Edit Password**.
 3. Enter the correct camera password.
 4. Click **Confirm**, then check whether password is changed successfully in Status window.
-



NOTE!

The cameras can be added to NVR successfully only when the authentication password is correct.

5. Click **OK**.

4.1.5 Fisheye Configuration





NOTE!

Fisheye configuration is supported only by GV-FER5702.

4.1.5.1 Configuration

1. Click Camera > Camera > Fisheye.

IP Addr.	Mount	Angle of View(*)	Fisheye Mode	Model	Edit
206.2.22.150	Ceiling	0	Fisheye	GV-FER5702	

2. Click  under **Edit**. The Fisheye window appears.
3. Select a correct mounting mode and complete other settings accordingly.
4. Click **OK**.

4.1.5.2 Dewarping











NOTE!







1. Dewarping is available in live view and playback (in normal and corridor playback modes). The operations are similar.
 2. Fisheye dewarping is only applicable to GV-FER5702.
-

Click **Fisheye Mode** on the window toolbar. The figure below appears. Set mounting mode and display mode.



Three mounting modes are available: ceiling, wall, desktop. Ceiling and desktop mounting modes use the same dewarping method.

Mounting Mode	Display Mode	Description
Ceiling mount 		Original Image
		360° Panoramic + 1PTZ
		180° Panoramic
Desktop mount 		Fisheye + 3PTZ
		Fisheye + 4PTZ
		360° Panoramic + 6PTZ
		Fisheye + 8PTZ

Wall mount 		Original Image
		Panoramic
		Panoramic + 3PTZ
		Panoramic + 4PTZ
		Panoramic + 8PTZ

Operations: Take Ceiling Mount and Fisheye + 3PTZ as an example:

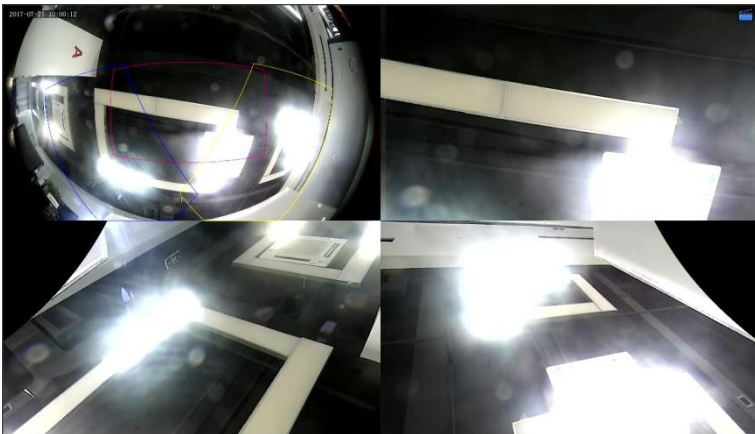

On a PTZ image, drag the mouse to rotate the image or use the scroll wheel to zoom in or out. A box appears on the fisheye image as the image rotates, and as you drag the box or move the scroll wheel on the fisheye image, the corresponding PTZ image rotates or zooms in or out as well.

4.1.6 Advanced Functions

Change the password of connected IP cameras or restore factory default settings for cameras under **Camera > Camera > Advanced**.

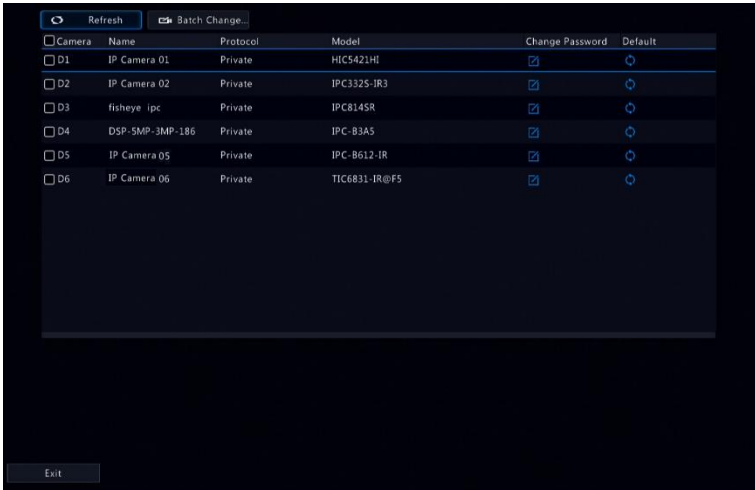

NOTE!

Changing camera password is available for certain cameras only.

4.1.6.1 Change Camera Password

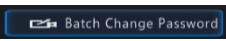
- To change the password of a single camera, select the target camera, and click , enter the new password, then click **Confirm**.
- To change the password of cameras in batch, select the target cameras, and click . Enter the new password, then click **Confirm**.



NOTE!

- Select the checkbox of **Use Admin Password** to change the camera's password to the admin's password of the NVR.
- You can check if the password has been successfully changed on **Status** window.

4.1.6.2 Restore Default Settings

Click , then click **OK** in the pop-up window, then the camera's default settings will be restored.

4.2 OSD Configuration

On Screen Display (OSD) are characters displayed with video images, for example, camera name, date and time, and people counting statistics.

1. Click **Camera > OSD**; or click  on the preview window toolbar.

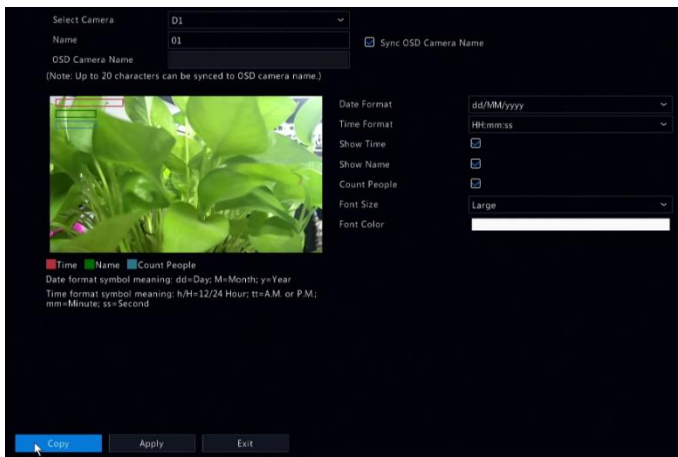

2. Select the desired camera.

3. Set camera name to display. Enable **Show Name** first, and set OSD camera name as needed:
 - If camera name is less than 20 characters, and camera name and **OSD Camera Name** (i.e., the camera name you want to overlay on video image) are the same:
 - a. Select **Sync OSD Camera Name**, then the OSD name will be synchronized with the camera name. This function is enabled by default.
 - b. Enter the camera name in the **Name** field. The name will be displayed on video image.
-

**NOTE!**

If camera name exceeds 20 characters, only the first 20 characters will be used as the OSD camera name.

- If camera name exceeds 20 characters, and you want to overlay a different camera name on video image:
 - a. Deselect Sync OSD Camera Name.
 - b. Enter the camera name in Name field.
 - c. Enter the OSD camera name.
1. Set time to display. Select **Show Time**, and select date and time formats.
 2. Set people counting statistics to display. Select **Count People**. You need to configure people counting function first. See [10.1.4 People Flow Counting](#) for details.
 3. Set font size and color as needed.
-

**NOTE!**

You may click **Copy** to apply the same settings to other cameras.

4. Click Apply to save the settings.

4.3 Image Configuration

1. Click **Camera > Image**.
2. Select the desired camera and scene.

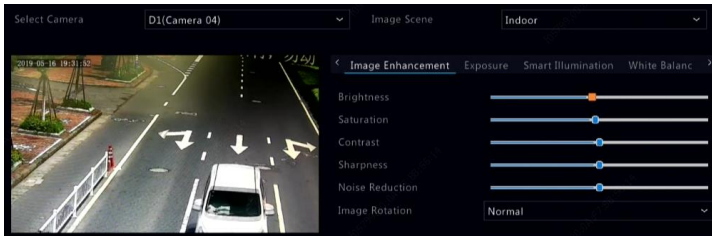

3. Adjust settings on the tabs as needed to achieve optimal images. See the following sections for detailed information.



NOTE!

- A scene can be selected only when supported by the IP camera.
- To restore default image settings, click **Default** in the lower right corner. This function is available only when the camera is connected to the NVR via the GeoVision protocol.
- Image settings apply to both live and recorded videos.

4.3.1 Image enhancement

1. Click the **Image Enhancement** tab.
2. Adjust the settings as needed. Some important parameters are described in the table below.

Parameter	Description
Brightness	The greater the value, the brighter the images appear.
Saturation	The amount of color in a specified hue.
Contrast	The degree of difference between the lightest (white) and darkest (black) parts of an image. Setting a greater value increases contrast.

Parameter	Description
Sharpness	Contrast of boundaries of objects in an image.
Noise Reduction	Reduce noises in images to improve image quality.
Image Rotation	<ul style="list-style-type: none"> • Normal: Displays images without rotation. • 180°: Displays images flipped vertically and horizontally. • 90° CW and 90° CCW: Display images in corridor format. The camera must be installed correctly (rotated 90° clockwise or counterclockwise).

4.3.2 Exposure

1. Click the **Exposure** tab.

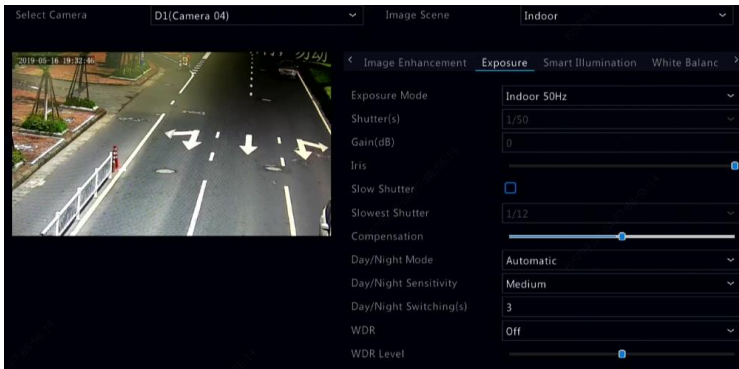

2. Adjust the settings as needed. Some important parameters are described in the table below.

Parameter	Description
Exposure Mode	Select the correct exposure mode to achieve the desired exposure effect.

Parameter	Description
Shutter(s)	Shutter is used to control the light that comes into the lens. A fast shutter speed is ideal for scenes in quick motion. A slow shutter speed is ideal for scenes that change slowly.
Gain(dB)	Control image signals so that the camera can output standard video signals in different light conditions.
Slow Shutter	Improves image brightness in low light conditions.
Slowest Shutter	Set the slowest shutter speed for the camera during exposure.
Compensation	Adjust the compensation value as required to achieve the desired image effects.
Day/Night Mode	<ul style="list-style-type: none"> • Automatic: In this mode, the camera can automatically switch between night mode and day mode according to the ambient lighting condition to output optimum images. • Night: The camera outputs high-quality black and white images according to the ambient lighting condition. • Day: The camera outputs high-quality color images according to the ambient lighting condition.
Day/Night Sensitivity	Light threshold for switching between day mode and night mode. A higher sensitivity value means that the camera is more sensitive to the change of light and is therefore more easily to switch between day mode and night mode.
Day/Night Switching(s)	Set the length of time before the camera switches between day mode and night mode after the switching conditions are met.

Parameter	Description
WDR	Enable WDR to ensure clear images in high contrast conditions.
WDR Level	After enabling WDR, you can improve image quality by adjusting the WDR level.

4.3.3 Smart Illumination

1. Click the **Smart Illumination** tab.

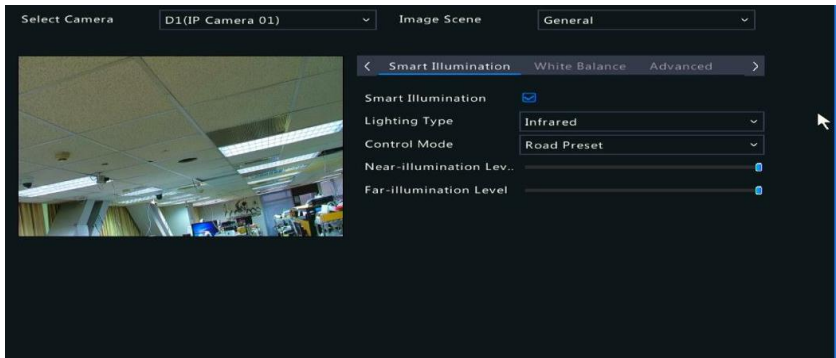

2. Check the box to enable smart illumination.
3. Adjust the settings on this tab. Important parameters are described in the table below.

Parameter	Description
Lighting Type	infrared is set by default.
Control Mode	<p>Set the IR illumination and exposure control mode.</p> <ul style="list-style-type: none"> • Global Mode: Set to achieve balanced image effects. • Overexposure Restrain: Set to avoid regional overexposure. • Manual: Set to manually control the illumination level.

Parameter	Description
Illumination Level	Asjust the IR illumination level from 0 to 1000.

4.3.4 White balance

1. Click the **White Balance** tab.

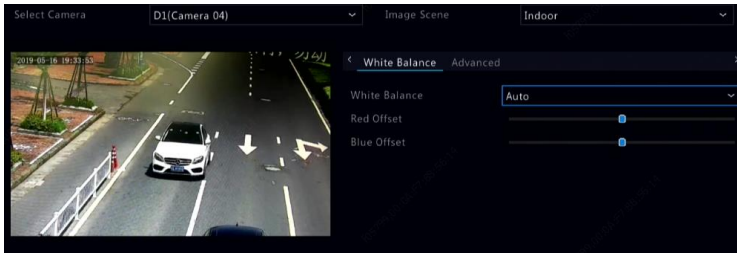

2. Adjust the settings on this tab. Some important parameters are described in the table below.

Parameter	Description
White Balance	Adjust the red or blue offset of the image: <ul style="list-style-type: none"> • Auto: The camera adjusts the red or blue offset automatically according to the lighting condition (the color tends to be blue). • Finetune: Allows you to adjust the red or blue offset manually. • Outdoor: Recommended for outdoor scenes with a wide range of color temperature variation. • Sodium Lamp: Asjusts the red and blur offset automatically according to the light condition. • Lock: Locks the current color temperature settings without adjustment.
Red Offset	Adjust the red offset manually.
Blue Offset	Adjust the blue offset manually.

4.3.5 Advanced settings

1. Click the **Advanced** tab.
2. Use defog to improve image quality in foggy days.

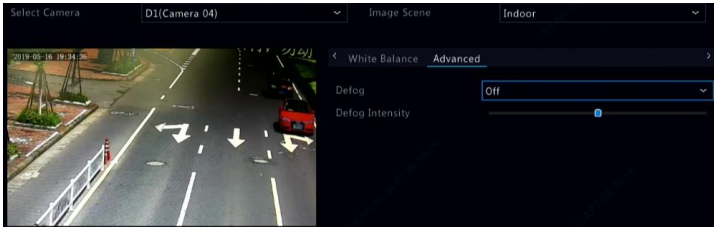



3. Adjust the Defog Intensity.

4.4 Privacy Mask Configuration

A privacy mask is an area of solid color covering certain parts of the monitored area. Privacy mask protects specified areas of images from being viewed and recorded. Multiple mask areas are allowed.

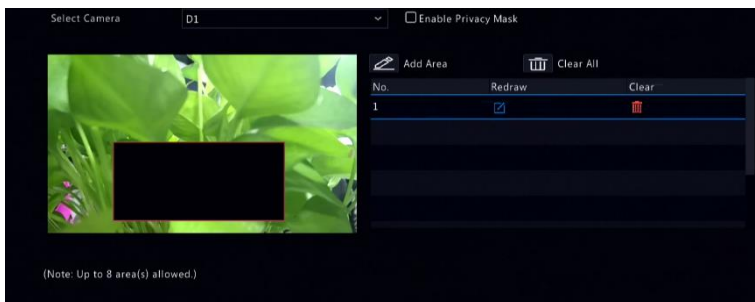
1. Click Camera > Privacy Mask.
2. Select the desired camera, select **Enable Privacy Mask**, click **Add Area** and then use the mouse to specify areas to mask. Up to 4 areas are allowed. The areas are differentiated by different colors.



3. (Optional) To clear a mask area, click .
4. Click **Apply** to save the settings.

5 PTZ Control

PTZ (pan, tilt and zoom) control is applicable to PTZ cameras only and may vary depending on the functions and protocols supported by the PTZ cameras. Refer to PTZ camera specifications for more details.

5.1 PTZ Control Window and PTZ Management Window









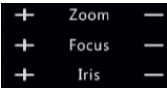

1. Click  on the window toolbar. The **PTZ Control** window appears. See [PTZ Control Window Buttons](#) for detailed descriptions.
2. Click the **Set** button. The **PTZ Management** window appears (can also be opened by clicking **Camera > PTZ**).

Table 5–1 PTZ Control Window Buttons

Button	Description
	Control the rotation direction of the PTZ camera or stop rotation.
	Adjust the zoom, focus, and iris of the PTZ camera. Note: You can also zoom in or out using the scroll wheel on your mouse.
	Control the rotation speed of the camera. 1 means the slowest, and 9 means the fastest.
	Click to display the PTZ Management window.



Button	Description
	<ul style="list-style-type: none"> • Turn on/off the light. • Turn on/off the wiper. • Use 3D positioning. • Turn on/off the heater. • Turn on/off the function to remove snow. • Turn on/off PTZ shortcut operations. <p>Note:</p> <ul style="list-style-type: none"> • Check that the 3D positioning, heater and snow removal functions are supported by the camera before using. • Use 3D positioning to zoom in or out. Dragging from top down zooms in. Dragging the other way zooms out.
	<ul style="list-style-type: none"> • Call a preset so the PTZ camera goes to the preset position. • Delete a preset <p>Note:  and  are displayed for saved presets only.</p>
<p>Preset Patrol/ Recorded Patrol/ Auto Guard</p>	<p>Preset patrol, recorded patrol, and auto guard. For detailed information, see 5.3 Setting a Preset Patrol, 5.4 Setting a Recorded Patrol, and 5.5 Setting Audio Guard.</p>
	<p>Start or stop.</p>

5.2 Setting and Calling a Preset

A preset position (preset for short), is a saved view used to quickly steer the PTZ camera to a specific position. A preset consists of the following settings: pan and tilt positions, zoom, focus, and iris.

1. Access the **PTZ Management** window. For the detailed steps, see [5.1 PTZ Control Window and PTZ Management Window](#).



2. Add presets.
 - A. Click the directional buttons to steer the PTZ camera to the desired position.
 - B. Adjust the zoom, focus, and iris as needed.
 - C. Select a preset number not in use, and then click  under Edit.
 - D. Repeat the above steps to add all the presets.
3. To call a preset, click  for the corresponding number. The camera rotates to the preset position.



NOTE!



Presets can also be triggered by alarms. See [9.10 Alarm-Triggered Actions](#) for details.

5.3 Setting a Preset Patrol

Set the PTZ camera to patrol by presets (go from one preset to the next in specified order). You need to set presets first and then select some as keypoints. Up to four patrol routes (Preset Patrol 1, 2, 3 and 4) are allowed for each PTZ camera, and each patrol route can have up to eight presets (keypoints). After setting presets, follow the steps to set a preset patrol. The following takes preset patrol 1 as an example.



1. In the **PTZ Management** window, click **Add Keypoint**. A window is displayed as follows.



2. Select a preset from the drop-down list, set the duration (time the camera stays at the preset, unit: second), and then set the rotation speed (1: slowest, 9: fastest). Click **OK** to save the settings. The preset is added as a keypoint.
3. Repeat the above steps to add all presets (keypoints), and adjust the sequence of these presets by clicking **↑ Move Up** or **↓ Move Down**. Modify or delete a preset by clicking  or .

Clicking  **Delete All ...** will delete all the added keypoints.

4. After completing the configuration, click **Apply** to save the settings. Now keypoints for preset patrol 1 is complete.

- Click  next to the drop-down list to start preset patrol 1. To stop, click .

**NOTE!**

The duration ranges from 0 to 1800 seconds (default: 10).
The rotation speed ranges from 1 to 9 levels (default: 5).



5.4 Setting a Recorded Patrol

This function requires the camera's support. The drop-down list and the buttons on the right are hidden if this function is not supported by the camera. Currently only one recorded patrol route is allowed.

Record a patrol, including the patrol route, the time that the camera stays at a certain direction, rotation speed, zoom, and focus.

- Click  to start recording. Steer the camera to the desired directions, adjust the zoom, focus, iris as needed during the process.



- Click  to stop recording. All the patrol actions have been recorded.
- To start the recorded patrol, click . Click  to stop.

5.5 Setting Auto Guard

Use auto guard so the PTZ camera automatically operates as configured if no operation is performed by any user during a certain time period. Auto guard avoids situations where the camera is left to monitor incorrect scenes by user's negligence.

This function requires the camera's support. The **Auto Guard** tab is hidden if it is not supported.

1. Click **Auto Guard** and then select **Enable**.
2. Select the desired mode from the drop-down list and then complete other settings accordingly. Click **Apply** to save the settings.

Enable	<input checked="" type="checkbox"/>
Idle State(s)	60
Mode	Preset
Preset	1(Preset001)

6 Recording and Snapshot

Video recording has different levels of priority, which from high to low is: event recording, manual recording, and scheduled recording.



NOTE!

Snapshot is supported by certain device models only.

6.1 Encoding Settings

6.1.1 Recording

The parameters and options displayed may vary with camera model and version. Some functions may be unavailable if the camera version does not support. In this case, you need to upgrade the camera first.

1. Click **Camera > Encoding**.

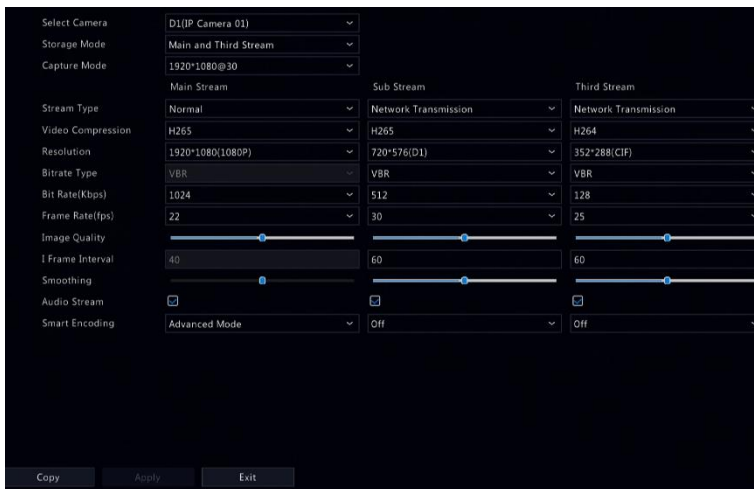

Select the camera and then edit settings as needed. Some parameters are described in the table below.

Table 6–1 Encoding Settings

Parameter	Description
Storage Mode	Five storage modes are available: Main Stream, Sub Stream, Main and Sub Stream, Main and Third Stream, Sub and Third Stream. Note: Only certain models support all the five modes.
Capture Mode	Combinations of resolutions and frame rates. Note: This parameter is effective only when the camera is connected to the NVR via the Geovision protocol.
Stream Type	<ul style="list-style-type: none"> • Normal: main stream that is intended for scheduled recording. • Event: main stream that is intended for recording triggered by events such as alarm inputs or motion detection alarms.
Video Compression	Video compression standard, for example, H.264, H.265.
Resolution	Image resolution.

Bitrate Type	<ul style="list-style-type: none"> • CBR: Constant Bit Rate (CBR) is used to maintain a specific bit rate by varying the quality of video streams. CBR is preferred when limited bandwidth is available. The disadvantage is that video quality will vary and may decrease significantly with increased motion in the scene. • VBR: When using Variable Bit Rate (VBR), video quality is kept as constant as possible, at the cost of a varying bit rate, and regardless of whether there is motion in the image. VBR is ideal when high quality is a requirement, especially when there is motion in the picture.
Bit Rate(Kbps)	Number of bits transferred per second. Select a value or select Custom and then set a value as needed.
Frame Rate(fps)	Number of frames per second.
Image Quality	This parameter is effective only when Bitrate Type is set to VBR . 9 levels are provided.
I Frame Interval	Number of frames between two adjacent I frames.
I Frame Range	Range of I frames.
Smoothing	Use the slider to control the sudden increase of bit rate.
Smart Encoding	The advanced mode achieves higher compression ratios.

1. (Optional) Click **Copy** to apply some current settings such as bit rate and frame rate to other cameras.
2. Click **Apply** to save the settings.

6.1.2 Audio

1. Click **Camera > Audio**.

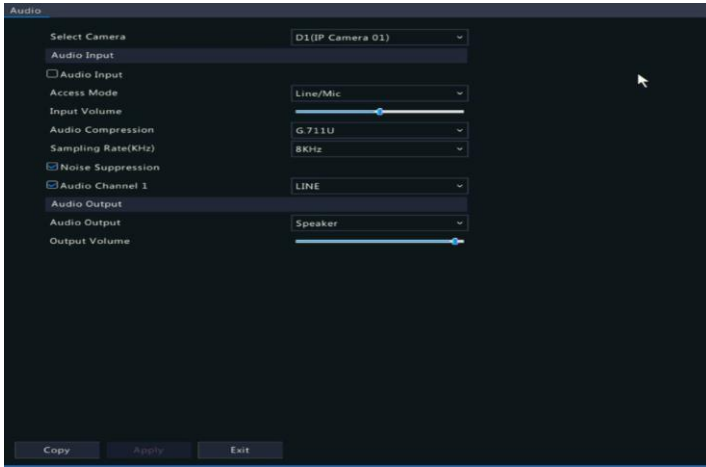

2. Select the camera and edit the audio input/output settings.

6.1.3 Snapshot

Set resolution, image quality and snapshot interval for snapshots taken according to schedule or triggered by an event.

1. Click **Camera > Snapshot**.
2. Select the camera and set the parameters as needed.



Parameter	Description
Snapshot Type	Scheduled snapshot uses the Normal type of schedule. Event-triggered snapshot is triggered by an event such as an alarm input and a motion detection alarm. Note: Settings effective to event-triggered snapshot also apply to manual snapshot.
Image Quality	High, Medium or Low are available.
Snapshot Interval	The time interval between two snapshots.

3. Click **Apply** to save the settings.

6.2 Draw or Edit a Schedule

Make a recording or snapshot schedule by drawing (pressing and dragging) or by editing (using the **Edit** button). The operations for recording and snapshot are similar, so this section only describes how to make a recording schedule.

1. Click **Storage > Recording**.
2. Select the camera from the list. Schedule is enabled by default. If it is disabled, select to enable it.
3. Set **Pre-Record** and **Post-Record** as needed.

- To save a redundant copy of recordings, select **Enable Redundant Recording** and configure a redundant hard disk (see [12.1 Disk Management](#) for details).

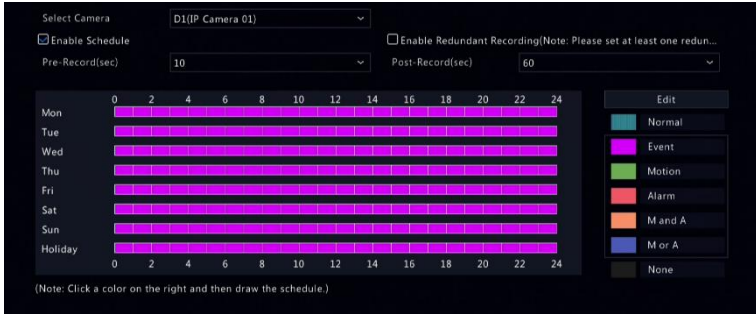

- Click a color icon on the right under the **Edit** button and then draw a schedule on the left. You may also click **Edit** and set schedule details in the **Edit Schedule** window.



NOTE!

When editing a schedule, you may clear the **All Day** check box and set up to eight different periods for each day. To apply the settings to other day(s), select the day(s) right to **Copy To**.

- Click **Apply**.
- (Optional) Click **Copy** to apply the same settings to other cameras.

6.3 Scheduled Recording and Snapshot

6.3.1 Scheduled Recording

Scheduled recording records video according to the set schedule and it is different from manual recording and alarm-triggered recording. A 24x7 recording schedule is enabled by default and may be edited as needed to record video in specified periods only.

See [6.2 Draw or Edit a Schedule](#) for the detailed steps. Make sure the schedule type is **Normal**. The set schedule appears in blue, which stands for scheduled recording.

6.3.2 Scheduled Snapshot

Configure scheduled snapshot under **Storage > Snapshot**.

Scheduled snapshot is similar to scheduled recording (see [6.3.1 Scheduled Recording](#) for details). Make sure the schedule type is **Normal**.

6.4 Motion Detection Recording and Snapshot

When enabled, a motion detection alarm occurs if an object inside the detection area moves to a certain extent (see [9.2 Motion Detection](#) for more details). Motion detection alarms can trigger actions including recording and snapshot.

6.4.1 Motion Detection Recording

1. Click **Alarm > Motion**.
2. Select the camera from the list, and then select the check box to enable motion detection.





NOTE!

- Motion detection is enabled on the NVR by default. Unless modified, the detection area covers the full screen, and recording is triggered only for the current camera. The settings remain if you disable motion detection and then enable it.
- An alarm icon appears in the upper right corner when motion is detected.

3. In the preview window on the left side, click and drag your mouse to specify a motion detection area (red grid). Use the slider to adjust detection sensitivity.



4. Configure motion detection recording: click  right to **Trigger Actions**, click the **Recording** tab, select the desired camera, and then click **OK**.
5. (Optional) Configure an arming schedule (time when actions will be triggered): click  right to **Arming Schedule** and then set time periods as needed.

- Set a recording schedule under **Storage > Recording**. For the detailed steps, see [6.2 Draw or Edit a Schedule](#). Make sure the schedule type is **Motion**. The set schedule appears in green, which stands for motion detection recording. The following figure shows an example.

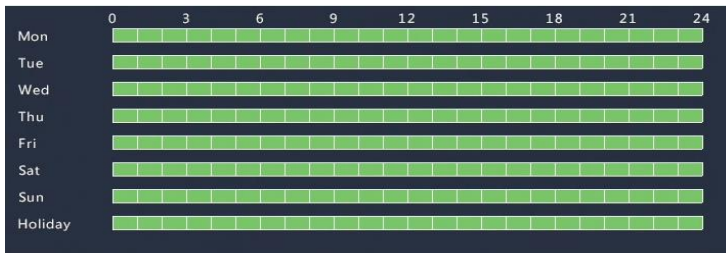

6.4.2 Motion Detection Snapshot

Motion detection snapshot is similar to motion detection recording. You need to enable and configure motion detection alarm first (see steps 1 to 3 in [6.4.1 Motion Detection Recording](#) for details), and then proceed with the following steps.

- Set motion detection snapshot under **Alarm > Motion**: click  right to **Trigger Actions**. In the window displayed, click the **Snapshot** tab, select the desired camera, and then click **OK**.
- Set a snapshot schedule under **Storage > Snapshot**. For the detailed steps, see [6.2 Draw or Edit a Schedule](#). Make sure the schedule type is **Motion**.

6.5 Alarm Triggered Recording and Snapshot

Set input alarms to trigger recording and snapshot. See [9.1 Alarm Input and Output](#) for more details.

6.4.1 Alarm Triggered Recording

1. Click **Alarm > Input/Output > Alarm Input**.

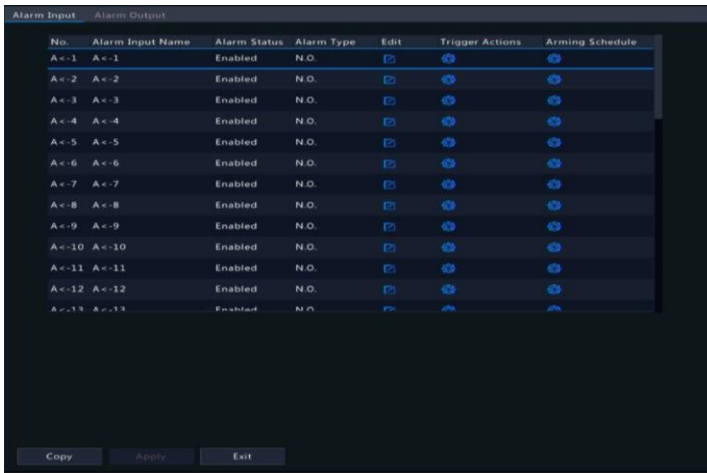

No.	Alarm Input Name	Alarm Status	Alarm Type	Edit	Trigger Actions	Arming Schedule
A<-1	A<-1	Enabled	N.O.			
A<-2	A<-2	Enabled	N.O.			
A<-3	A<-3	Enabled	N.O.			
A<-4	A<-4	Enabled	N.O.			
A<-5	A<-5	Enabled	N.O.			
A<-6	A<-6	Enabled	N.O.			
A<-7	A<-7	Enabled	N.O.			
A<-8	A<-8	Enabled	N.O.			
A<-9	A<-9	Enabled	N.O.			
A<-10	A<-10	Enabled	N.O.			
A<-11	A<-11	Enabled	N.O.			
A<-12	A<-12	Enabled	N.O.			
A<-13	A<-13	Enabled	N.O.			

Copy Apply Exit

2. Set alarm input: click  for the desired camera. In the window displayed, select **Enable**, select N.O. (normally open) or N.C. (normally closed) trigger mode, and then click **OK**.



Alarm Input

Alarm Input Enable

Alarm Type N.O.

OK Cancel



NOTE!

To apply the same settings to other camera(s), click **Copy** and then select the desired camera(s).

3. Set alarm triggered recording: click  under **Trigger Actions**. In the window displayed, click the **Recording** tab, select the desired camera, and then click **OK**.
4. Set a schedule under **Storage > Recording**. For the detailed steps, see [6.2 Draw or Edit a Schedule](#). Make sure the schedule type is **Alarm**. The set schedule appears in red, which stands for alarm-triggered recording. The following shows an example.

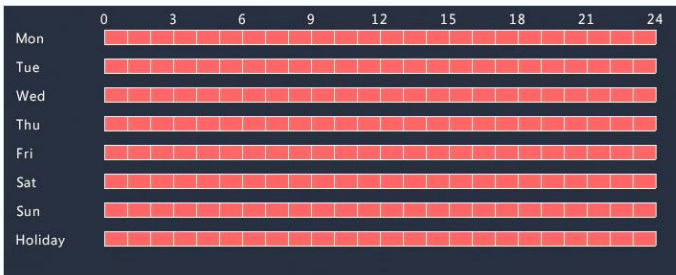

6.4.2 Alarm Triggered Snapshot

Alarm triggered snapshot is similar to alarm triggered recording. You need to enable and configure alarm input first (see steps 1 to 2 in [6.4.1 Alarm Triggered Recording](#) for details) and then proceed with the following steps.

1. Set alarm triggered snapshot: Click  under **Trigger Actions**. In the window displayed, click the **Snapshot** tab, select the desired camera, and then click **OK**.

- Set a snapshot schedule under **Storage > Snapshot**. For the detailed steps, see [6.2 Draw or Edit a Schedule](#). Make sure the schedule type is **Alarm**.

6.6 Manual Recording and Snapshot

6.6.1 Manual Recording

Right click on the preview window, select **Manual** in the shortcut menu. Click the **Manual Recording** tab, select the desired camera and then click **Start**. To stop manual recording, select the camera and then click **Stop**.

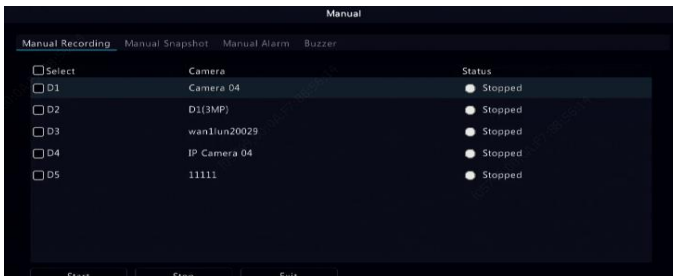

6.6.2 Manual Snapshot

Manual snapshot is similar to manual recording. Right click and select **Manual > Manual Snapshot**, select the desired camera, and then click **Start**. Click **Stop** to stop.

6.7 Holiday Recording and Snapshot

Holiday recording and snapshot allows you to specify certain time periods as holidays for scheduled recording and snapshot. First you specify certain date(s) as holidays, and then configure recording or snapshot schedules on these days.

6.7.1 Holiday Recording

1. Click **System > Time > Holiday**.
2. Click the **Add** button in the lower right corner. The **Holiday** window is displayed. Complete the settings including the holiday name, start and end dates. By default a holiday is enabled when added and does not repeat.

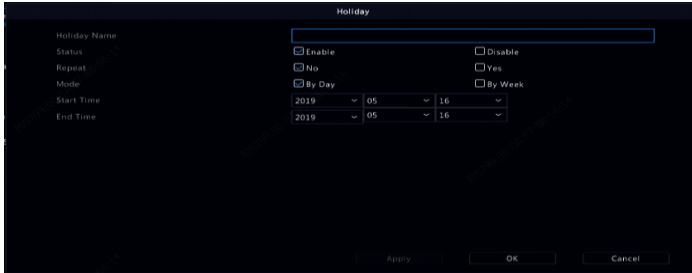

3. Click **OK**. The holiday appears in the list.
4. Click **Storage > Recording** and then set a recording schedule as described in [6.2 Draw or Edit a Schedule](#). Make sure **Holiday** is selected in the **Select Day** drop-down list. In the following example, motion detection recording is enabled on the set holiday.

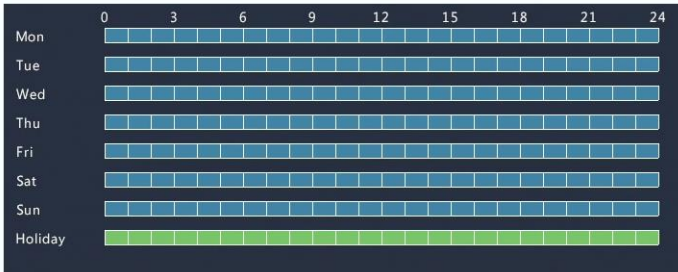

6.7.2 Holiday Snapshot

Holiday snapshot is similar to holiday recording. First you set holidays under **System > Time > Holiday**, and then configure a snapshot schedule under **Storage > Snapshot**. Set a snapshot schedule as described in [6.3.1 Scheduled](#) Recording. Make sure **Holiday** is selected from the **Select Day** drop-down list.

6.7.3 Other Recording and Snapshot Types

To access the options, select **Storage > Recording / Snapshot**.

- Event: Including the types below and VCA. Any of these types will trigger event recording/snapshot.
- Motion detection AND alarm triggered (M and A for short): recording or snapshot is triggered only when a motion detection alarm AND an input alarm occur simultaneously.
- Motion detection OR alarm triggered (M or A for short): recording or snapshot is triggered when a motion detection alarm OR an input alarm occurs.

When you choose an Event type of recording or snapshot, make sure you have enabled the corresponding alarm function and configured alarm-triggered recording/snapshot. The configuration steps are similar. See [6.4 Motion Detection Recording and Snapshot](#) for more details.

7 Playback

7.1 Instant Playback











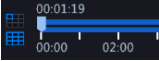

Instant playback plays the video recorded during the last 5 minutes and 30 seconds. If no recording is found, it means there is no recording during this period.

1. Click the desired window, and then click  on the toolbar to start instant playback.
2. You may drag the slider to control the progress. Pause and resume as needed.





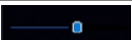

7.2 Playback Toolbar

Table 7–1 Playback Toolbar Buttons

Button	Description
	<p>Show playback progress.</p> <p>Note:</p> <ul style="list-style-type: none"> • A small window displaying video of the selected window is displayed as you drag the slider, helping locate the part of the video you want to view. • The first progress bar indicates playback progress of the video playing in the highlighted window. The second indicates the overall playback progress for all the selected cameras.
	<p>Timeline.</p>
	<p>Zoom in or out on the timeline.</p> <p>Note: Alternatively, scroll your mouse wheel.</p>
	<p>Play, pause, stop, and reverse.</p>
	<p>Rewind or forward 30 seconds. Adjust the time duration from the dropdown list in the middle.</p>
	<p>Slow down or speed up.</p> <p>Note: Click  to restore the normal playback speed after clicking , and vice versa.</p>
	<p>Forward by frame.</p>
	<p>Start or stop clipping video.</p>
	<p>Take a snapshot. The success window will appear.</p>
	<p>Lock.</p>
	<p>Manage files (clips, snapshots, locked files, tags).</p>
	<p>Adjust sound volume for the current window.</p>

Click on the playback window to access the following options.

	Take a snapshot. The success window will appear.
	Add a playback tag. See 7.5.1 Adding a Tag .
	Zoom in on images. For more details, see 3.3 Zoom .
	Turn off/on audio.
	Set fisheye mounting mode and display mode.

7.3 Playback by Camera and Date

Use this method to search and play recordings by camera and date.

1. Click on the preview window, then right click and choose **Playback** to start playback.



NOTE!

In playback window, you can select multiple cameras for synchronous playback. Clicking **Max. Camera** selects the maximum number of cameras allowed, and clicking **Close All** stops playback for all cameras. The performance varies with NVR model.

2. Select the desired date on the calendar and then click  to start playback. Double-clicking the date will start playback directly.

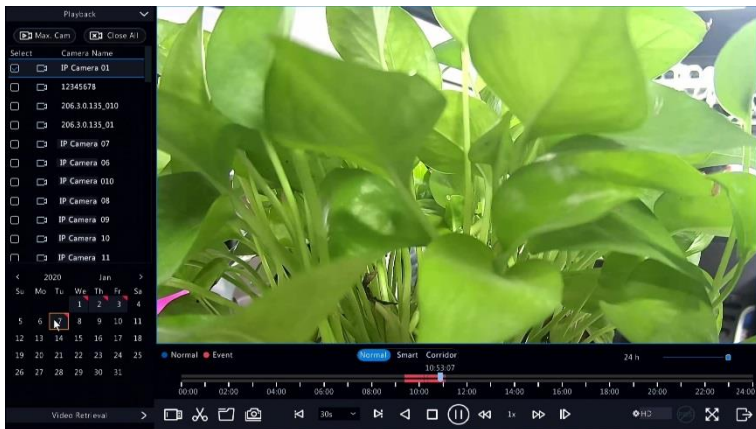



NOTE!

- The calendar uses different flags to indicate different recording types. No flag means no recording. The blue flag means normal recording. The red flag means event-triggered recording.
 - In the drop-down list at the bottom: **HD** means video recorded with the main or sub stream; **SD** means video recorded with the third stream.
-

7.4 Playback in Corridor Mode



Play recordings in corridor mode in multiple windows.

1. In the playback window, select **Corridor** above the progress bar.
2. Select cameras and then double-click the desired date to start playback.

7.5 Playback by Tag

Add tags named with keywords such as event name and location to a recording and use tags to quickly locate the part of the video you need during playback.

7.5.1 Adding a Tag

1. Right-click and then click **Playback**.
2. Click  on the window toolbar, and then set the tag name.
3. To manage the added tags, click  on the screen toolbar, and then rename or delete tags as needed.

7.5.2 Playback by Tag

1. In the playback window, click **Video Retrieval**, select **Tag Search** from the drop-down list in the upper left corner.
2. Select cameras, set the time period, and then click **Search**. Search results, if there are any, are displayed with names of cameras and tags.
3. Click  for the desired tag to start playback. You may configure **Set Time** to set when the tagged video starts and ends.

7.6 Playback by Motion Detection

Search for and play recordings triggered by motion detection during a specified time period.



NOTE!

Make sure motion detection is enabled and alarm-triggered recording has been configured before you use this function. See [9.2 Motion Detection](#) and [9.10 Alarm-Triggered Actions](#) for details.

1. In the playback window, click **Video Retrieval**, select **Motion** from the drop-down list in the upper left corner.
2. Select the desired camera, set the time period, and then click **Search**.
3. Click  for the desired recording to start playback.

7.7 Playback by Video Loss

Search for and play recordings triggered by video loss during a specified time period.



NOTE!





Make sure video loss alarm is enabled and alarm-triggered recording has been configured before you use this function. See [9.5 Video Loss](#) and [9.10 Alarm-Triggered Actions](#).

1. In the playback window, click **Video Retrieval**, select **Video Loss** from the drop-down list in the upper left corner.
2. Select the desired camera, set the time period, and then click **Search**.
3. Click  for the desired recording to start playback.

7.8 Playback by Smart Search



This function provides an efficient way to review recordings containing smart search results such as detected motions. In smart playback mode, the system analyzes recordings for smart search results. If such results are detected, the progress bar is highlighted in green, and the video plays at the normal speed, allowing you enough time to catch details; otherwise, the video plays at 16x speed to save time.

1. In the playback window, select **Smart** above the progress bar.
2. Click  for the desired camera to start smart playback.

3. Click  at the bottom. The smart search window is displayed. By default, the full screen is the smart search area. To clear all, click ; to restore the full-screen search area, click .
4. Set smart search rules, including detection area and sensitivity.
5. Click  to start search. To quit, click .

7.9 Playback by External File

Use this function to play recordings stored in an external storage device, for example, a USB drive or a portable USB hard drive.

1. In the playback window, click  on the screen toolbar.
2. Click **Refresh** and then wait for the NVR to read the external storage device.
3. Select the desired recording file and then click  to start playback.

7.10 Playback by Image



Specify an image type (for example, Normal or Motion) to search for and play images from one or more cameras during a specified time period.

1. In the playback window, click **Video Retrieval**, select **Picture Search** from the drop-down list in the upper left corner.

2. Select a type from the **Type** drop-down list in the upper right corner.
3. Select the desired camera(s), set the desired time period, and then click **Search**.
4. Click the desired file to start playback.

7.11 File Management

File management allows you to manage video clips, tags, snapshots taken during playback, and lock or unlock files.

1. Take snapshot during playback.
 - A. In playback page, play the recording until the desired image appears.
 - B. Click  in the playback window to take a snapshot.
 - C. Click  and then click the Playback Image tab to view the snapshot.
 - D. Select the desired image file(s) and then click Backup to save them to the storage device.



NOTE!

The image resolution depends on the resolution from the output interface and the number of windows displayed when the snapshot is taken.

2. Lock files.

Use this function to lock a recording file so it will not be overwritten. To lock a recording file will prevent all the files stored in the same disk partition from being overwritten.

A. Play the recording you want to lock.

B. Click  in the playback window.

C. Click  and then click the Locked File tab to view the

locked file. To unlock a file, click ,

and the icon changes to . To back up a file, select the file and then click Backup.

8 Backup

8.1 Recording Backup

Backup, also known as recording backup, is the process of querying video stored on a hard disk of the NVR and then saving to a USB storage device or a DVD-R disc as a file.

Recording backup has the following conditions:

- Back up using a USB storage device: format the partition in FAT32 or NTFS format; connect the storage device correctly to the NVR.
- Back up using a disc: use a GP65NB60 DVD burner. Make sure the DVD-R disc is empty, and the burner is correctly connected to your PC.
- Permission is required.
- The recording to back up is stored on a hard disk of the NVR.



NOTE!

- The default file format is .mp4 when you back up recordings to a USB storage device.
 - When backing up using a disc, recordings are saved as .TS files only.
 - Backing up using a disk is only applicable on the Web interface.
-

8.1.1 Normal Backup

1. Click **Backup > Recording**. All cameras are selected by default.
2. Set search conditions and then click **Search**. Search results are displayed.



NOTE!

You can lock/unlock and play recording files in this window.

3. Select the desired recording(s) and then click **Backup**.
4. Set the destination in the USB storage device and then click **Backup**. The recording(s) will be saved to the specified directory.



NOTE!

- You may want to create a new folder for the recording(s) by clicking **New Folder**.
 - If the connected storage device has a capacity that is greater than 2T, clicking **Format** will format the device to NTFS file system; if the capacity is 2T or less, the device will be formatted to FAT32 or NTFS. Only certain devices can format a storage device that has a greater capacity than 2T.
 - A progress bar (e.g., **Exporting X/Y**) is displayed to indicate the progress, where *X* indicates the current number being backed up, and *Y* indicates the total number of recordings. To cancel the operation, click **Cancel**.
 - A backup file is named in this format: *camera name-recording start time*.file extension. For example, Ch9-20150630183546.mp4.
-

- Back up to a DVD-R disc using the Web interface

On the Web interface, click **Backup > Back Up Recording** to back up the recordings. Set the destination on the disk and then click **Backup**. The recording(s) will be saved to the specified directory.





NOTE!

- Before you start burning, check that the video to back up was not compressed using smart encoding.
 - Clicking **Cancel** before burning is finished will cause the disc unusable.
 - When burning is finished, wait for the drive to eject itself. Do not eject the drive manually.
-

8.1.2 Video Clip Backup

A recording can be clipped and saved to a USB storage device.

1. Open the playback window. For the detailed steps, see [7. Playback](#).
2. After playback starts, click  on the playback toolbar to clip videos.
3. Click  and then click the **Video Clip** tab to view video clips.
4. Select the desired video clip(s) and then click **Backup**.
5. Select a destination in the USB storage device and then click **Backup**. The selected video clips are saved to the specified directory.

8.2 Image Backup

The default format of image backup is JPG.

1. Click **Backup > Image**.
2. Set search conditions and then click **Search**. Search results are displayed.



NOTE!



The image resolution depends on the resolution from the output interface and the number of windows displayed when the snapshot is taken.

3. Select the desired file(s) and then click **Backup**.
4. Select a destination in the USB storage device and then click **Backup**. The selected files are saved to the specified directory.

9 Alarm

9.1 Alarm Input and Output

9.1.1 Alarm Input

1. Click **Alarm > Input/Output > Alarm Input**.
2. Click  for the desired camera. In the **Alarm Input** window, select **Enable** to enable alarm input.
3. Enable the Alarm Input, and optionally type the desired alarm name.
4. Select the normally open (N.O.) or normally closed (N.C.) trigger mode, and then click **OK**.
5. Click  under **Trigger Actions** and then set action(s) to trigger.

For more details, see [9.10 Alarm-Triggered Actions](#).

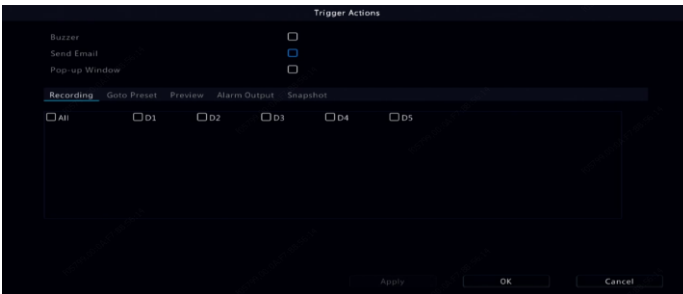

NOTE!

- The number of cameras that can be connected may vary with NVR model.
 - Actions that can be triggered may vary with alarm type.
-

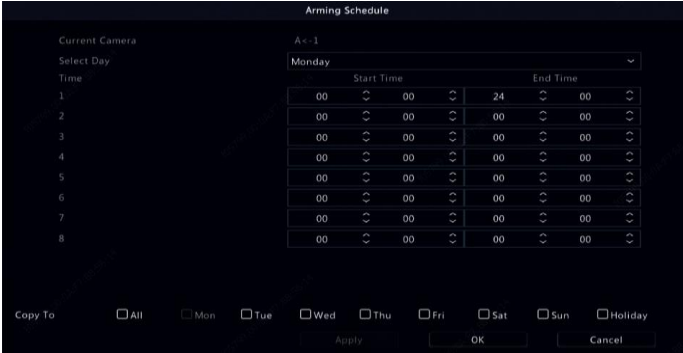

6. Click  under **Arming Schedule** and then set the time when actions will be triggered.



NOTE!

- The default schedule is 24x7. You may change it as needed and set up to eight different periods for each day. Time periods cannot overlap.
- To apply the same arming schedule to other days, select the intended days right to **Copy To**.
- To apply the same settings to other cameras, click **Copy**, select cameras, and then click **OK**.

9.1.2 Alarm Output

1. Click **Alarm > Input/Output > Alarm Output**.
2. Click  under **Edit** for the desired camera, and then set the default status and duration. After you have completed the settings, click **OK**.
3. Click  under **Arming Schedule** and then set the time when actions will be triggered.



NOTE!

To apply the same settings to other cameras, click **Copy**, select cameras, and then click **OK**.

9.2 Motion Detection

When enabled, a motion detection alarm occurs if an object inside the detection area moves to certain extent, and an alarm icon appears in the upper right corner.

Motion detection is enabled on the NVR by default. Unless modified, the detection area covers the full screen, and recording is triggered only for the current camera. The settings remain if you disable motion detection and then enable it.

1. Click **Alarm > Motion**.
2. Select the desired camera and then select **Enable** to enable motion detection.

- The detection area is set full screen by default. Optionally click **Clear All** and use the mouse to draw a detection area. Drag the slider to set detection sensitivity. The higher the sensitivity, the more likely a moving object will be detected.

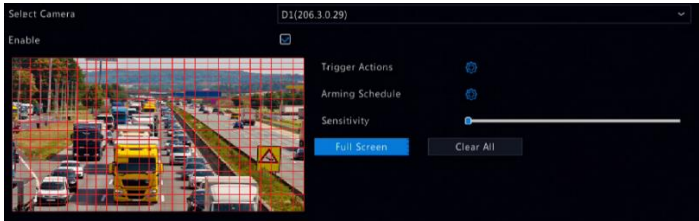

- Click  right to **Trigger Actions** and set action(s) to trigger. For more details, see [9.10 Alarm-Triggered Actions](#).



NOTE!

- The number of cameras that can be connected may vary with NVR model.
- Actions that can be triggered may vary with alarm type.

- (Optional) Click  right to **Arming Schedule** and then set the time when actions will be triggered.



NOTE!

- The default schedule is 24x7. You may change it as needed and set up to eight different periods for each day. Time periods cannot overlap.
- To apply the same arming schedule to other days, select the intended days right to **Copy To**.



- Click **Apply** to save the settings.
- (Optional) Click **Copy** to apply the same settings to other cameras.

9.3 Tampering Detection

A tampering detection alarm occurs when the camera lens is covered.

1. Click **Alarm > Tampering**.
2. Select the desired camera and then select **Enable** to enable tampering detection.





3. Click  right to **Trigger Actions** and set action(s) to trigger. For more details, see [9.10 Alarm-Triggered Actions](#).
4. (Optional) Click  right to **Arming Schedule** and then set the time when actions will be triggered.
5. (Optional) Click **Copy** to apply the same settings to other cameras.
6. Click **Apply** to save the settings.

9.4 Human Body Detection

Human body detection alarms occur when the presence of human beings is detected in the specified area. Note that this function is only applicable to the IP cameras that are equipped with Human Body Detection function. See [10.1 VCA Configuration](#) for details.

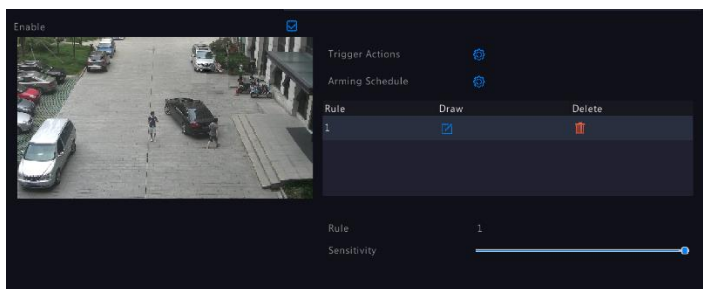
1. Click **Alarm > Human Body Detection**.





2. Enable human body detection by selecting the **Enable** check box.
3. Click , and then draw detection area.





NOTE!

Only one detection area is allowed for each camera.

4. Set detection sensitivity. The higher the sensitivity, the more likely a human body will be detected.
5. Click  right to **Trigger Actions** and set action(s) to trigger. For more details, see [9.10 Alarm-Triggered Actions](#).
6. (Optional) Click  right to **Arming Schedule** and then set the time when actions will be triggered.
7. Click **Apply** to save the settings.

9.5 Video Loss

A video loss alarm occurs when the NVR loses video signals from a camera. Video loss alarm is enabled by default.

1. Click **Alarm > Video Loss**. To disable video loss alarm for a channel, click , which then changes to .
2. Click  under **Trigger Actions** and set action(s) to trigger. For more details, see [9.10 Alarm-Triggered Actions](#).



NOTE!

Video loss alarm cannot trigger recording, preset, preview (live view) and snapshot actions for the current camera.

3. Click  under **Arming Schedule** and then set the time when actions will be triggered.
4. (Optional) Click **Copy** to apply the same settings to other cameras.

9.6 Alert

The NVR reports an alert when an event occurs in the system. The following are some alerts and their definitions in the system.

- **IP Conflict:** Devices on the network use the same IP address.
- **Network Disconnected:** Network connection is lost.
- **Disk Offline:** A disk is not properly connected or is damaged.
- **Disk Abnormal:** A disk can be detected but cannot be accessed.

- **Illegal Access:** A failed login attempt for a username that does not exist or a password that is incorrect.
- **Hard Disk Space Low:** Less than 10% of disk space remains.
- **Hard Disk Full:** No disk space.
- **Recording/Snapshot Abnormal:** Storage resource cannot be found. For example, when all hard disks are removed, or when there is no disk in disk group 1 (see [12.3 Disk Group](#) for more information).

Perform the following steps to configure an alert:

1. Click **Alarm > Alert**.
2. Select an alert type, select the desired actions, and then select the camera(s) for which you want to enable alarm output.

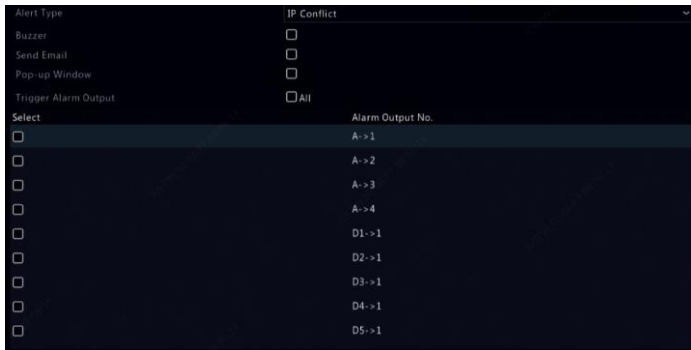



3. Click **Apply** to save the settings.

9.6.1 Audio Detection

An audio detection alarm occurs when a camera detects a sudden change in sound volume.

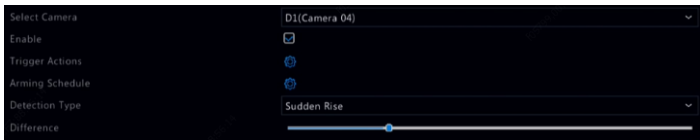
1. Click **Alarm > Audio Detection**.
2. Select the camera and then select **Enable** to enable audio detection.



3. Click  right to **Trigger Actions** and set action(s) to trigger. For more details, see [9.10 Alarm-Triggered Actions](#).
4. (Optional) Click  right to **Arming Schedule** and then set the time when actions will be triggered.
5. Select a detection type and adjust the settings as needed.

Detection Type	Description
Sudden Rise	An alarm occurs when the rise of volume exceeds the set value.
Sudden Fall	An alarm occurs when the fall of volume exceeds the set value.
Sudden Change	An alarm occurs when the rise or fall of volume exceeds the set value.
Threshold	An alarm occurs when the volume exceeds the set value.

6. Drag the bar to adjust the difference value.
7. Click **Apply** to save the settings.

9.7 Buzzer

The buzzer can be triggered by alarms to alert the user. Follow the steps to set how long the buzzer will buzz after it is triggered.

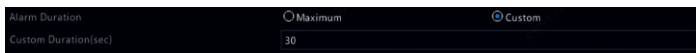

1. Click **Alarm > Buzzer**.



2. Set the duration as needed. The range is from 1 to 600 seconds.
3. Click **Apply** to save the settings.

9.8 People Present Alarm

People present alarms occur when the number of people detected in the specified area exceeds the set threshold. Note that this function is only applicable to the IP cameras that are equipped with People Counting function. See [10.1 VCA Configuration](#) for details.

1. Click **Alarm > People Present Alarm**.
2. Select the camera.
3. Enable people present alarm by selecting the Enable check box.
4. Click  right to **Trigger Actions** and set action(s) to trigger. For more details, see [9.10 Alarm-Triggered Actions](#).
5. (Optional) Click  right to **Arming Schedule** and then set the time when actions will be triggered.
6. Set the People Present Alarm Threshold.
7. Click **Apply** to save the settings.

9.9 One-Key Disarming

One-key disarming allows users to disable NVR/IPC alarms over appointed period of time or based on the set frequency.

1. Click **Alarm > One-Key Disarming**.
2. Click the **NVR Disarming / IPC Disarming** tabs to disable the alarms on the NVR or IPC.

9.10 Alarm-Triggered Actions

An alarm can trigger actions, for example, buzzer, recording, and preview. The supported actions may vary with NVR model.

Alarm-Triggered Buzzer

The NVR makes a buzzing sound when an alarm occurs.

Alarm-Triggered E-mail

The NVR e-mails an alarm message to a specified email address when an alarm occurs.

Alarm-Triggered Pop-up Window

A window pops up when an alarm occurs.

Alarm-Triggered Recording

The NVR records video from a specified camera when an alarm occurs.

Alarm-Triggered Snapshot

The NVR takes a snapshot when an alarm occurs.

Alarm-Triggered Preset

A PTZ camera rotates to a preset position when an alarm occurs.

Alarm-Triggered Preview

The NVR plays live video in full screen when an alarm occurs.

Alarm-Triggered Alarm Output

The NVR outputs an alarm to trigger actions by a third-party device when an alarm occurs.

9.11 Manual Alarm

9.11.1 Manual Alarm Output

Follow the steps to trigger or clear an alarm output manually.

1. Right click on the live view video and select **Manual > Manual Alarm**.
2. To trigger an alarm output manually, select the desired channel and then click **Trigger**. To clear an alarm output manually, select the desired channel and then click **Clear**.

Manual Buzzer

Follow the steps to stop the buzzer manually.

1. Right click on the live view video and select **Manual > Buzzer**.
2. Select the buzzer (in Started status) and then click **Stop**.

10 VCA

10.1 VCA Configuration

VCA means Video Content Analysis. VCA functions include face recognition, perimeter protection, and exception detection. Note that the functions are only applicable when the NVR is connected to compatible AI-capable IP cameras that are equipped with the corresponding functions. See the table below for details.

AI Functions	Compatible AI-capable IP cameras			
	GV-BLFC5800, EBD4813, EBFC5800, TBL4810, TDR4803, TFD4800, TVD4810 (V1.04 or later)	GV-EBD8813, EBD8800, TBL8804, TBL8810, TDR8805, TVD8810 (V1.05 or later)	GV-SD4825-IR, SD4834-IR (V1.02 or later)	GV-PTZ5810-IR (V1.01 or later)
Intrusion	✓	✓	✓	✓
Cross Line	✓	✓	✓	✓
Enter Area	✓	✓	✓	✓
Face Detection	✓	✓	✓	✓
Leave Area (Human & Vehicle Classification)	✓	✓	✓	✓
People Flow Counting	✓	✓	✓	✓
Crowd Density Monitoring	✓	✓	✓	✓
Auto Tracking	✗	✗	✓	✗

1. Click **VCA > VCA Config**.
 2. Select the camera you wish to enable the VCA functions on from the **Select Camera** dropdown list.
 3. **Camera Side Analysis** is set by default. The analysis is performed by the camera.
-

**NOTE!**

- The checkbox of a function that is grayed out means that the function is not supported by the camera.
-

4. Click  to enter the configuration page of that function.

10.1.1 Face Detection

Face detection is used to detect and capture human faces in a specified surveillance area.



1. Select the detection area. You may choose full screen or specify an area to detect. If you select **Specify Area**, click **Draw Area** and then draw a detection area using the mouse.
2. Set face detection sensitivity. The higher the sensitivity, the more likely a face will be detected.



NOTE!

The lower the sensitivity, the less likely a side face or blurring face will be detected. Adjust detection sensitivity as needed to achieve optimal effects.

3. Configure trigger actions. Click  right to **Trigger Actions** and set action(s) to trigger. For more details, see [9.10 Alarm-Triggered Actions](#).

10.1.2 Intrusion Detection

Intrusion detection is used to detect objects entering specified area(s) and trigger actions as needed.

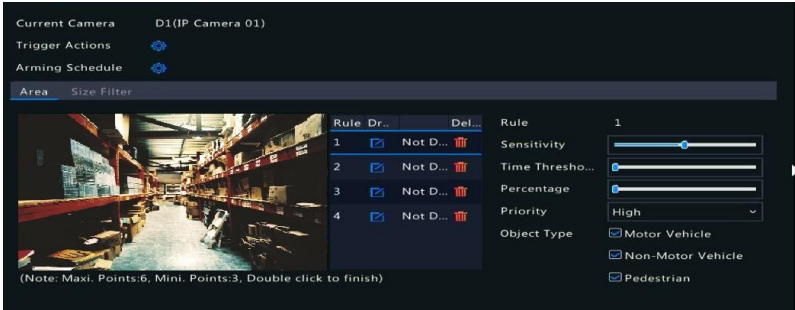

1. Draw detection areas on the screen and set detection rules including sensitivity, time threshold and percentage. Up to four areas are allowed. The time threshold means the minimum length of time an object stays in the detection area(s). The percentage means the proportion of target object size to the size of the detection area. An alarm occurs when the threshold or the percentage is exceeded.
2. From the **Priority** dropdown list, set the detection priority (**Low**, **Mid**, or **High**) when multiple VCA functions are enabled.
3. For **Object Type**, select **Motor Vehicle**, **Non-Motor Vehicle**, or **Pedestrian**.
4. Click  right to **Trigger Actions** and set action(s) to trigger. For more details, see [9.10 Alarm-Triggered Actions](#).

10.1.3 Cross Line Detection

Cross line detection is used to detect whether any object crosses a virtual line on the screen and trigger alarms as needed.

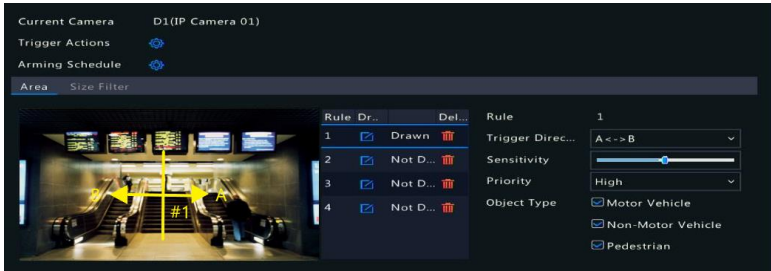

1. Draw detection line(s). Up to four are allowed. Set detection rules, including Trigger Direction and Sensitivity.
2. From the **Priority** dropdown list, set the detection priority (**Low**, **Mid**, or **High**) when multiple VCA functions are enabled.
3. For **Object Type**, select **Motor Vehicle**, **Non-Motor Vehicle**, or **Pedestrian**.
4. Click  right to **Trigger Actions** and set action(s) to trigger. For more details, see [9.10 Alarm-Triggered Actions](#).

10.1.4 People Flow Counting

People flow counting is used to count people entering or leaving an area.





1. Draw a virtual line on the screen to set the minimum width of detection. People narrower than the set width will be ignored.
2. Click the **Draw** button and then draw rules on the left. Set entrance direction and sensitivity as needed.
3. Select the desired counting type, including Total/People Entered/People Exited.
4. For Reporting Interval(s), set the time interval for reporting people counting data.
5. By selecting **Enable Clear by Schedule**, you can have people counting OSD reset at a specified time every day. You may also click **Clear Counting Result** to clear the OSD immediately. Resetting people counting OSD only changes the OSD. It does not change report statistics.
6. Click **Apply** to save the settings.

10.1.5 Defocus Detection

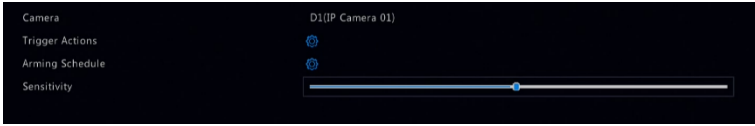
Use defocus detection to check whether the camera focuses properly.





1. Click  right to **Trigger Actions** and set action(s) to trigger. For more details, see [9.10 Alarm-Triggered Actions](#).
2. (Optional) Click  right to **Arming Schedule** and then set the time when actions will be triggered.
3. Set detection sensitivity and then click **Apply** to save the settings.

10.1.6 Scene Change Detection

Use scene change detection to detect the change of surveillance environment caused by external factors such as intentional rotation of the camera.





1. Click  right to **Trigger Actions** and set action(s) to trigger. For more details, see [9.10 Alarm-Triggered Actions](#).
2. (Optional) Click  right to **Arming Schedule** and then set the time when actions will be triggered.
3. Set detection sensitivity and then click **Apply** to save the settings.

10.1.7 Auto Tracking

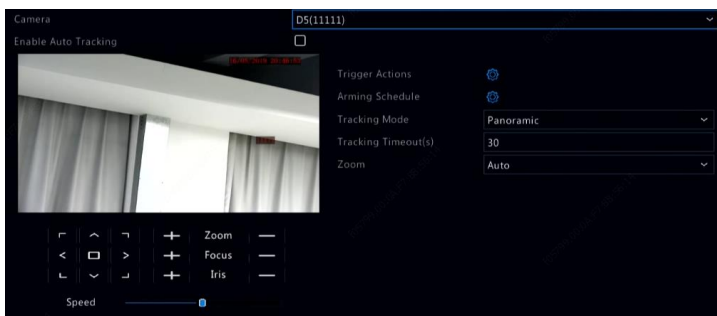
Auto tracking detects moving objects in the scene and automatically tracks the first object detected. Note this function is only applicable when the NVR is connected to certain AI-capable IP cameras. See the table in [10.1 VCA Configuration](#) for details.



1. Click  right to **Trigger Actions** and set action(s) to trigger. For more details, see [9.10 Alarm-Triggered Actions](#).
2. (Optional) Click  right to **Arming Schedule** and then set the time when actions will be triggered.
3. Set tracking mode (currently only **Panoramic**). Set tracking timeout and zoom ratio.



NOTE!

- Tracking Timeout(s) means the maximum length of time the camera tracks an object automatically. The range is 1-300 seconds and the default is 30 seconds. When the tracking timeout is over, the camera stops tracking and restores the original scene and status.
- Zoom means zoom ratio and includes **Auto** (default) and **Current Zoom**. **Auto** means the camera automatically adjusts the zoom ratio according to the tracking distance and thus captures more details on the tracking object; **Current Zoom** means the camera maintains the original zoom ratio during tracking and thus attends to the whole scene.

4. Click **Apply** to save the settings.

10.1.8 Object Left Behind

Detect object left behind in specified areas and trigger an alarm.

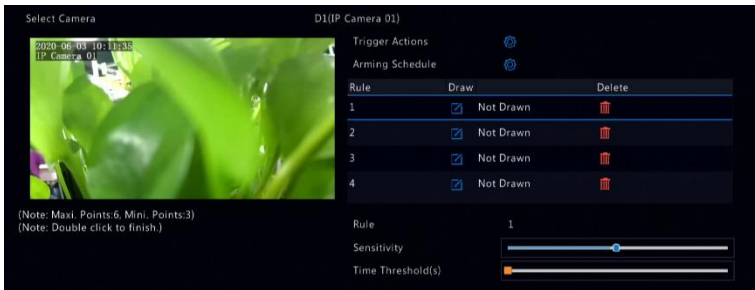



1. Click  to draw detection areas.



NOTE!

When drawing a detection area, you can use up to 6 points to specify the area. Up to 4 detection areas area allowed.

2. Set sensitivity and time threshold:
 - Sensitivity: The higher the sensitivity, the more likely an object left behind will be detected.
 - Time Threshold: An alarm will be triggered when the length of time an object is left behind in a detection area exceeds this value.
3. Click  right to **Trigger Actions** and set action(s) to trigger. For more details, see [9.10 Alarm-Triggered Actions](#).
4. (Optional) Click  right to **Arming Schedule** and then set the time when actions will be triggered.
5. Click **Apply** to save the settings.

10.1.9 Object Removed

Detect object removed from specified areas and trigger an alarm.





1. Click  to draw detection areas.



NOTE!

When drawing a detection area, you can use up to 6 points to specify the area. Up to 4 detection areas area allowed.

2. Set sensitivity and time threshold:
 - Sensitivity: The higher the sensitivity, the more likely an object will be detected.
 - Time Threshold: An alarm will be triggered when the length of time an object is missing in specified areas exceeds this value.
3. Click  to **Trigger Actions** and set action(s) to trigger. For more details, see [Alarm-Triggered Actions](#).
4. (Optional) Click  right to **Arming Schedule** and then set the time when actions will be triggered.
5. Click **Apply** to save the settings.

10.1.10 VCA Search

VCA searches for data of each VCA function. The search result, application scenario and settings vary with the VCA function.

10.1.11 Face Snapshot Search

Use face snapshot search to search for captured face images.

1. Click **VCA > VCA Search > Face Snapshot Search**.
2. Select cameras, set a search period, and then click **Search**. Search results are displayed.
3. View search results in a chart or table. Back up search results (including images and recordings) as needed. To view videos recorded when the face was detected (around 10 seconds before and after), click the play button.

10.1.12 Behavior Search

Use behavior search to search for recordings triggered by detected behaviors.

1. Click **VCA > VCA Search > Behavior Search**.
2. Select camera(s), set a search period, select an event type, an object type, and then click **Search**. Search results are displayed.
3. View search results in a chart or table. Back up search results as needed.

People Counting Report

Use people counting to count people entering and/or leaving an area during a specified period (hour, day, week or year).

1. Click **VCA > VCA Search > People Counting Report**.
2. Select the camera, counting type (people entered or exited), report type (daily, weekly, monthly, yearly, or hourly), set a time period, and then click **Count**. Search results are displayed. You may choose to display search results in a chart or table. When you click a bar, statistics of the selected camera(s) are displayed.
3. (Optional) To save the counting statistics to a connected USB storage device, click **Backup**.

11 Network Configuration

Network configuration is required if your NVR operates in a network.



NOTE!

The default IP address is 192.168.0.100 for NIC 1 and 192.168.1.100 for NIC 2, and likewise.

11.1 Basic Configuration

11.1.1 TCP/IP

1. Click **Network > Basic > TCP/IP**.
2. Set the network parameters as needed. DHCP is enabled by default.

You can choose a working mode if your NVR has two NICs:

- **Multi-address mode:** The two NICs work independently and can be configured separately. Either NIC can be chosen as the default route, and data will be forwarded through this NIC when the NVR connects to the extranet.
- **Load Balance mode:** The two NICs are bound to the same IP address and work together to share network traffic.
- **Net Fault-tolerance mode:** The two NICs are bound to the same IP address. In cases where one NIC fails, the other takes over service seamlessly from the faulty one to ensure network connectivity.

Working Mode	Multi-address
Select NIC	NIC1
<input type="checkbox"/> Enable DHCP	
IPv4 Address	206 . 3 . 0 . 86
IPv4 Subnet Mask	255 . 255 . 255 . 0
IPv4 Default Gateway	206 . 3 . 0 . 1
IPv6 Mode	Router Advertisement
IPv6 Address	fe80::4aea:63ff:fe6a:c792
IPv6 Prefix Length	64
IPv6 Default Gateway	::
MAC Address	48:ea:63:6a:c7:92
MTU(Bytes)	1500
Preferred DNS Server	114 . 114 . 114 . 114
Alternate DNS Server	8 . 8 . 8 . 8
Default Route	NIC1

3. Click **Apply** to save the settings.



NOTE!

- For an NVR with multiple NICs, you can configure the NICs and choose a default route (currently NIC1).
 - If your NVR has a PoE port or a switching port, you can configure an internal NIC IPv4 address.
-



CAUTION!

- If you switch the working mode, the enabled 802.1x and ARP protection will be disabled automatically.
 - The valid MTU ranges from 576 to 1500 (1280-1500 for IPv6). To use IPv6, make sure the NVR and PC can connect to each other using IPv6 addresses. To view live or recorded videos, make sure the IPv4 addresses are also connectable.
-

11.1.2 Mobile APP

The NVR supports for remote access via mobile devices based on Android and iOS operating system. Click **Network > Basic > Mobile APP**. Refer to [GV-Eye Installation Guide](#) for the following operating instructions on GV-Eye. This function is only applicable to GV-Eye V3.0.0 or later.

11.1.3 DDNS

If your NVR is connected to the Internet through PPPoE, the IP address of the network changes every time it connects to the ISP server without your awareness. This is inconvenient when you remotely access your NVR with an IP address. To avoid this issue, you can register with an DDNS server to obtain a domain name for your NVR and then access your NVR by visiting the domain name instead of an IP address (*http://DDNS server address/NVR's domain name*) using a web browser.

1. Click **System > Network > DDNS**.

2. Enable DDNS, select a DDNS type, and then complete other settings.
 - If the DDNS type is **DynDNS**, enter the domain name, username and password. The domain name is the one that you have successfully registered at a domain name registration website (e.g., DynDNS). The username and password are those of the account you have registered at the domain name registration website (e.g., DynDNS).
 - If the DDNS type is **GVDIP**. Enter the **username** (hostname) and **password** registered in the GV-Dynamic DNS Service V2 server (visit <http://ns.gvdip.com/register.aspx>). Click **Save**.
3. Click **Apply** to save the settings.

11.1.4 Email

After Email is enabled as a triggered action (in Trigger Actions windows) and configured properly, the NVR sends an email notification to specified email address(es) if an alarm occurs within the time period(s) set in the arming schedule. The email contains basic alarm information such as alarm type, alarm time, camera ID, and camera name, etc.

Before using this function, make sure the NVR has a functional connection to an SMTP server with which you have a valid email account. Depending on the intended recipients, a connection to the Internet may be required.

1. Click **Network > Basic > Email**.

- Configure the related parameters. If server authentication is required, you need to enter the correct username and password. Click **Test** to send a test email. Enter a valid SMTP server address and port number, and then select **Enable TLS/SSL** if required.

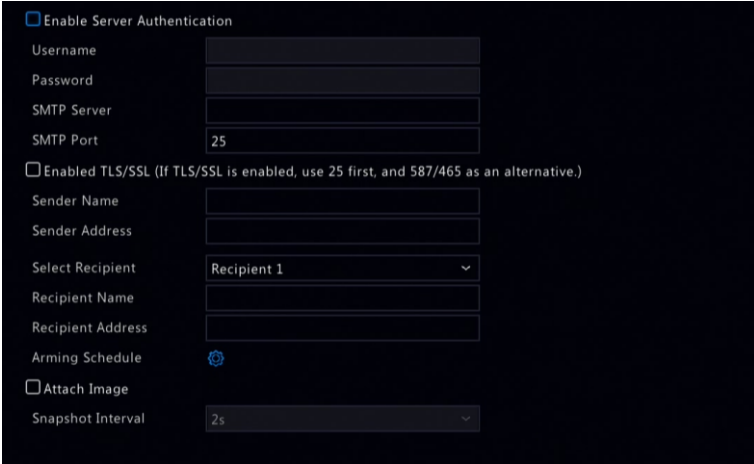

Enable Server Authentication

Username

Password

SMTP Server

SMTP Port

Enabled TLS/SSL (If TLS/SSL is enabled, use 25 first, and 587/465 as an alternative.)

Sender Name

Sender Address

Select Recipient

Recipient Name

Recipient Address

Arming Schedule 

Attach Image

Snapshot Interval



NOTE!

- By default a 24x7 arming schedule is enabled. The NVR sends an email notification only in the arming period.
- Select **Attach Image** if you want snapshots to be sent via email. Make sure Email and snapshot have been enabled in the **Trigger Actions** window.
- You may click **Test** to check whether the email can be sent successfully.

- Click **Apply** to save the settings.

11.2 Platform Configuration

11.2.1 SNMP

Use SNMP to connect to a platform and obtain system time.

1. Click **Network > Platform > SNMP**. Select **Enable SNMP**.



<input checked="" type="checkbox"/> Enable SNMP	
SNMP Type	SNMPv2
Read Community Name	public
Write Community Name	private
Trap Community Name	private
Trap Address	
Trap Port	162
SNMP Port	161

2. Select an SNMP type.
 - Snmp V2
Set **Read Community Name** and **Write Community Name**, which are used by the platform to read data on NVR.
 - Snmp V3
Set authentication password (for the platform to access the NVR) and encryption password (for encrypting data sent from the NVR to the platform).
3. Click **Apply**.

11.2.2 Alarm Service

Use this function to send alarm signals to an external alarm device (for example, alarm control panel) when an alarm or an alert occurs on the NVR.

1. Click **Network > Platform > Alarm Service**.

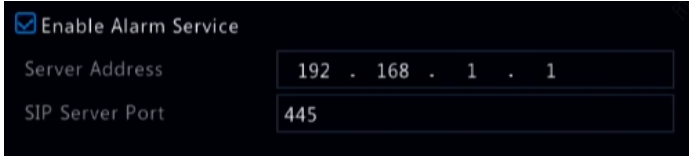

<input checked="" type="checkbox"/> Enable Alarm Service	
Server Address	192 . 168 . 1 . 1
SIP Server Port	445

2. Select **Enable Alarm Service**, and set the server address and SIP server port.



NOTE!

The NVR only sends alarm signals when an alarm or alert occurs; users need to implement alarm receiving and reporting for the external alarm device separately.

11.3 Advanced Configuration

11.3.1 PPPoE

The NVR allows access through Point-to-Point over Ethernet (PPPoE).

1. Click **Network > Advanced > PPPoE**.
2. Enable PPPoE by selecting the check box.
3. Enter the username and password provided by your Internet Service Provider (ISP). Network information including IP address appears when dial-up succeeds.



NOTE!

If your NVR has multiple NICs, PPPoE dial-up will be implemented through the NIC specified as the default route.

4. Click **Apply** to save the settings.

11.3.2 Port

Normally the default port numbers need no modification. This function is mainly used together with the port mapping function. See [4.1.1 Adding an IP Device](#) for more details.

1. Click **Network > Advanced > Port**.
2. Configure ports as planned. Each port number must be unique.

HTTP Port	80
RTSP Port	554
HTTPS Port	443
RTSP URL Format	<pre>rtsp://<ip>:<port>/unicast/c<channel number>/s<stream type>/live <channel number>: 1-n <stream type>: 0(main stream) or 1(sub stream)</pre>



NOTE!

- A valid port number ranges from 1 to 65535, among which 21, 23, 2000, 3702 and 60000 are reserved.
- An RTSP URL can be used to view live video of a channel of the current NVR from another NVR. See Option 4 in [4.1.1 Adding an IP Device](#) for more information.

3. Click **Apply** to save the settings.

11.3.3 Port Mapping

Two port mapping methods are available:

- Universal Plug and Play (UPnP)
- Internal and external mapping

11.3.3.1 UPnP

UPnP enables the NVR to discover other devices on the network and establish network services such as data sharing and communication.

To use UPnP on your NVR, you must enable UPnP in the connected router. With UPnP enabled for Network Address Translation (NAT), the ports on the NVR can be mapped automatically to the router, and computers can access your NVR from outside the LAN.

1. Click **Network > Advanced > Port Mapping**.
2. UPnP is enabled by default. Select the desired mapping type from the drop-down list. To map ports manually, select **Manual** and then set external ports for the router.

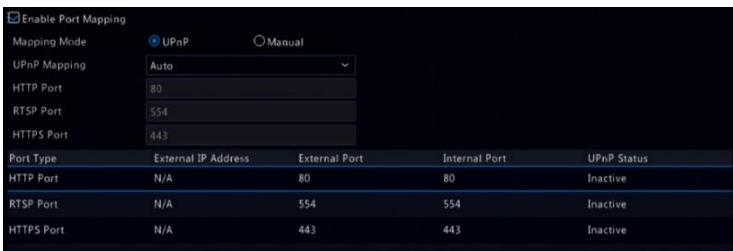



NOTE!

- Automatic mapping (Auto) is recommended. Ports will conflict if not configured properly.
 - For an NVR with multiple NICs, port mapping should be configured based on the NIC specified as the default route.
-

3. Click **Refresh** and check that **Active** is displayed for these ports under **UPnP Status**.
4. Click **Apply** to save the settings.

11.3.3.2 Manual Port Mapping

If your router does not support UPnP, then you need to configure internal and external ports manually.



NOTE!

- The principle of port mapping is that the internal and external ports of the NVR are consistent with that of the router.
 - Some routers may require the same internal and external ports for the NVR and the router.
-

1. Click **Network > Advanced > Port Mapping**.
2. Select **Manual** for **Mapping Mode**, and then set external ports manually.



The screenshot shows a configuration window for port mapping. At the top, there is a checkbox labeled "Enable Port Mapping" which is checked. Below this, there are two radio buttons for "Mapping Mode": "UPnP" (which is unselected) and "Manual" (which is selected). Underneath, there are three input fields for port numbers: "HTTP Port" with the value "50722", "RTSP Port" with the value "554", and "HTTPS Port" with the value "443".

3. Click **Apply** to save the settings.
-

**NOTE!**

After port mapping is completed, you may access the Web client of your NVR by entering the following information in the address bar of your web browser: router's WAN port IP address: external HTTP port. For example, if 10.2.2.10 is the IP address and 82 is the HTTP port, then you enter <http://10.2.2.10:82>.

11.3.4 FTP

Use this function to automatically upload images to a preconfigured FTP server.

1. Click **Network > Advanced > FTP**.
 2. Select the check box to enable FTP.
 3. Enter the IP address of the FTP server, username and password, remote directory, and upload interval.
-

**NOTE!**

- Click **Test** to verify whether an FTP connection can be established.
 - If the remote directory is not specified, the system will create different folders directly by IP, time and camera. You may also specify a remote directory, for example, FTPtest/xxx/xxx, then the system will create the directory first and then create folders by IP, time and camera.
-

- Select the desired camera and then click  right to **Upload Schedule**. In the **Upload Schedule** window, select the desired image type and set time periods.

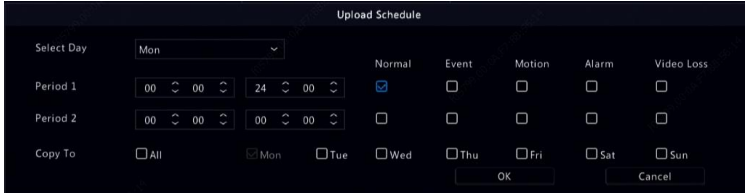

NOTE!

- If you select Event, Motion, Alarm or Video Loss, you also need to configure the corresponding alarm-triggered snapshot. For example, if you select Motion, you need to configure alarm-triggered snapshot (select Motion in the Edit Schedule window).
- To apply the same settings to other days in a week, select the desired days right to **Copy To**.

- (Optional) Apply the same settings to other cameras by clicking  right to **Copy** and then selecting desired cameras.

- Click **Apply** to save the settings.



NOTE!

To apply the same settings to other cameras, click  right to **Copy**, select cameras and then click **OK**.

11.3.5 Multicast

Multicast can be used to realize live view when the number of connecting Web clients exceeds the limit the NVR can accommodate.

- Click **Network > Advanced > Multicast**.

2. Select the check box to enable multicast, and then enter the multicast IP and port number.



3. Click **Apply** to save the settings.
4. Log in to the Web client and set **Live View Protocol** to **Multicast** under **Setup > Client**.



NOTE!

Set the multicast IP correctly. Multicast address is class D address with the range 224.0.0.0 through 239.255.255.255; some are for special use:

- 224.0.1.0--238.255.255.255 can be used on the Internet.
- 224.0.0.0-244.0.0.255: only for use on LAN.
- 224.0.0.1: all-hosts group address, which refers to all the multicast-capable hosts and routers on a physical network.
- 224.0.0.2: for all routers on this subnet.
- 224.0.0.5: for all OSPF routers.
- 224.0.0.13: for all PIMv2 routers.
- 239.0.0.0--239.255.255.255 are for private use like 192.168.x.x.

12 Disk Configuration

12.1 Disk Management

View disk information, including total and free disk space, disk status, disk type, disk usage, and disk property. Admin users can format disks and edit disk property

1. Click **Storage > Hard Disk**.

<input type="checkbox"/> No.	Total(GB)	Free(GB)	Status	Type	Usage	Property	Configure	Operate
<input type="checkbox"/> 1	1842.39	1717.00	Normal	Array	Recording/Snapshot	Read/Write		—

2. To add a disk, click **Add**. In the dialog box displayed, select disk usage (recording/snapshot or backup) and disk type (currently NAS only), enter the server address and directory, and then click **Add**. Up to eight NAS disks are allowed.

Add Extended Disk

Usage	<input type="text" value="Recording/Snapshot"/>
Type	<input type="text" value="NAS"/>
Server Address	<input type="text" value="."/>
Directory	<input type="text"/>

3. To edit disk property, click , and then modify disk usage (recording/snapshot or backup) and disk property (**Read/Write**, **Read Only** or **Redundant**) as needed.



NOTE!

- Disk property can be edited if the disk is used for recording/snapshot.
- The Redundant property is available to certain NVR models.
- You may use external eSATA disks for recording/snapshot or backup purpose and unmount them if necessary. eSATA disks and NAS disks cannot be used to create arrays.

4. To format a disk, select the disk and then click **Format**. A confirmation message appears. Click **Yes**.



NOTE!

- Local disks will be formatted automatically when installed. Extended disks will not. Format a disk with caution. All data will be removed.

12.2 Array Configuration

The table below lists the supported RAID types and hard disks required.

RAID	HDD Qty
RAID 0	2-8
RAID 1	2
RAID 5	3-8
RAID 6	4-8
RAID 10	4-16 (Must be an integral multiple of 2, e.g., 4, 8, 10, etc).

12.2.1 Enabling RAID

You need to enable RAID first.

1. Click **Storage > Array**.
2. Select the check box to enable RAID. A confirmation message appears. Click **Yes**.

12.2.2 Creating an Array

It is recommended to configure physical hard disks as hot spare disks to ensure reliable system operation and successful rebuilding in case an array fails.

1. Click **Storage > Array**.
2. To create an array automatically, click **One-click Create**.



NOTE!

- There is no need to select disks when creating an array with **One-click Create**. The system identifies all usable disks. RAID 1 is created when two disks are available. When three or more disks are available, RAID 5 is created.
 - Arrays created in this way are named ARRAYX, for example, ARRAY1, ARRAY2.
-

3. To create an array manually, select the desired disks and then click **Create**. In the window displayed, enter the array name, select the array type, and select local disks. Click **Apply** to complete the setup. Note that no hot spare disk will be created automatically. Make sure all disks are selected to create array(s); otherwise, disk space will be wasted (because disks that are not selected will not be used for storage).

12.2.3 Rebuilding an Array

By checking array status, you can determine whether maintenance is necessary.



NOTE!

To be alerted when an array is degraded or damaged, you can configure alarm-triggered action at **Alarm > Alert**.

An array is in one of four statuses: normal, degraded, damaged, rebuild. The status is normal if no physical disk is lost. When the number of physical disks lost reaches the specified value, the array is considered damaged. The status between normal and damaged is degraded. A degraded array can be recovered to normal status through rebuilding.



NOTE!

Take RAID 5 that consists of 4 disks as an example. The array is degraded when one disk is lost. When two disks are lost, the array is damaged.

A degraded array can be automatically rebuilt in ten minutes if these conditions are met: a hot spare disk is available; the capacity of the hot spare disk is not less than that of any disk in the array. A degraded array without a hot spare disk can only be rebuilt manually under **Storage > Array > Array**. By default the first local disk that satisfies requirements is selected.

12.2.4 Deleting an Array



CAUTION!

Deleting an array will erase all data on it.

1. Click **Storage > Array > Array**.
2. Click  for the array to delete. A confirmation message appears. Click **Yes**.

12.3 Disk Group

Assign hard disks to a disk group and use the disk group to store recordings and snapshots of specified cameras. Different arrays can be assigned to different disk groups.

Redundant disks cannot be assigned to any disk group. Disk group information will be initialized if any disk in the group is formatted.

1. Click **Storage > Disk Group**.

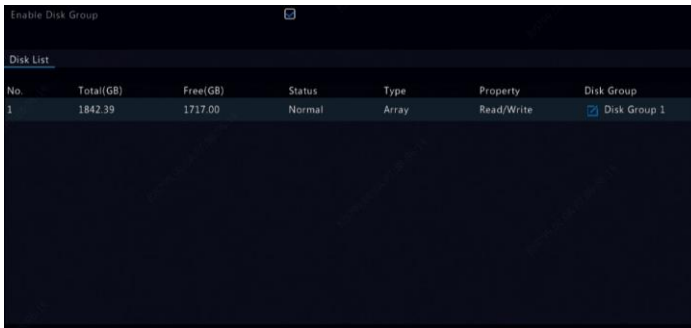

2. Select **Enable Disk Group**. By default all disks belong to Disk Group 1. Click  for the disk to edit, and then select a group to which the disk will be assigned.



3. Click **Apply** to save the settings.

12.4 Space Allocation

Allocate space to store videos and snapshots of a specified camera.

1. Click **Storage > Allocate Space**.

Select Camera	D1(Camera 04) <input type="button" value="v"/>
Used Recording Space(G..	52
Used Image Space(GB)	0
Select Group	Disk Group 1 <input type="button" value="v"/>
Disk Capacity	1842 GB free of 1842 GB
Group Capacity	1842 GB free of 1842 GB
Max Recording Space(GB)	<input type="text" value="0"/>
Max Image Space(GB)	<input type="text" value="0"/>

2. Select the desired camera and then set the maximum recording space and maximum image space. You can select a disk group only when disk group is enabled under **Storage > Disk Group**. For more information, see [11.3 Advanced Configuration](#).
3. Click **Apply** to save the settings.
4. (Optional) Click **Copy** to apply the same settings to other camera(s).

12.5 Advanced Configuration

Set whether to overwrite recordings or snapshots when storage is full.

1. Click **Storage > Advanced**.



2. Choose an option.

Option	Allocated Space	Description
Overwrite	0	The camera shares unallocated space, and its oldest recordings/snapshots will be overwritten when the space is used up.
	Other values	The camera's oldest recordings/snapshots will be overwritten when its allocated space is used up.
Stop	0	The camera shares unallocated space, and its oldest recordings/snapshots will still be overwritten when the space is used up.
	Other values	The camera's new recordings/snapshots will not be saved when its allocated space is used up.

3. Click **Apply** to save the settings.

13 System Configuration

13.1 Basic Configuration

1. Click **System > Basic**.
2. Configure the parameters.



Device Name	GV-SNVR6403
Device ID	2
Device Language	English
Auto Logout(min)	Never
Instant Playback(m...)	60
Mouse Pointer Speed	<input type="range"/>
<input checked="" type="checkbox"/> Enable Password Protection	
<input type="checkbox"/> Enable Startup Wizard	Wizard
<input type="checkbox"/> Intelligent Mark	



NOTE!

- Only admin can set **Enable Password Protection**.
- If **Enable Password Protection** is not selected, no password is required for local login at system startup. However, a username and password are still required when you log in after a logout.
- Some NVR models support Intelligent Mark. When the NVR and IP camera are both enabled, the latest areas/lines or VCA data configured for face detection, intrusion detection, and cross line detection will be displayed on the **Preview**, **Behavior** and **Alarm** windows in real time.
- Intelligent mark is displayed on the screen as areas/lines in different colors. Yellow means areas/lines configured for face detection, intrusion detection, and cross line detection; green means VCA data has changed but not triggered rules; red means rules are triggered in the configured area (rules are configured for VCA alarms), and VCA alarm has occurred.
- You may also set startup Wizard here by clicking **Wizard**.

3. Click **Apply** to save the settings.

13.2 Time Configuration

13.2.1 Time

1. Click **System > Time > Time**.
2. Select the correct time zone, and then set date and time formats and the system time. The following shows an example.

Time Zone	(GMT+08:00) Beijing, Hong Kong, Uru
Date Format	YYYY-MM-DD
Time Format	24-hour
System Time	2019-05-17 10:01:53
<input type="checkbox"/> Enable Auto Update	
NTP Server Address	0.0.0.0
NTP Port	123
Update Interval	10m

3. To use Network Time Protocol (NTP), enable auto update, set the address and port number of the NTP server, and the update interval.
4. Click **Apply** to save the settings.

13.2.2 DST

1. Click **System > Time > DST**.
2. Enable DST by selecting the check box, and then set the start time, end time, and DST bias correctly.
3. Click **Apply** to save the settings.

13.2.3 Time Synchronization

Use this function to synchronize camera time with the NVR. Time sync is enabled by default, and cameras will synchronize time with the NVR after getting online, and then synchronize once every 30 minutes.

1. Click **System > Time > Time Sync**.
2. Select **Sync Camera Time** and then click **Apply**.



CAUTION!

Use this function with caution if you have more than one NVR on the network. An IP camera synchronizing time with multiple NVRs at the same time will cause chaotic recordings.

13.3 Serial Configuration

The **Serial** page allows you to configure RS485 parameters when connecting to a PTZ camera. Click **System > Serial** for relevant configurations.

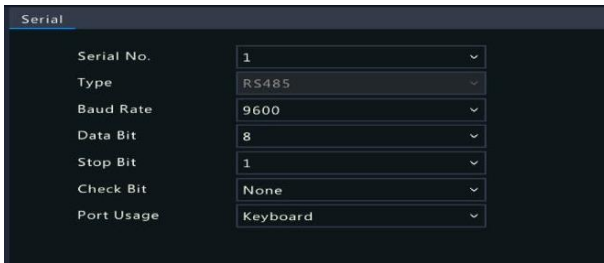

Serial	
Serial No.	1
Type	RS485
Baud Rate	9600
Data Bit	8
Stop Bit	1
Check Bit	None
Port Usage	Keyboard

13.4 User Configuration

Add, delete users or edit user permissions. Only admin can perform these operations. Device password is required for user configuration.



A user type is a set of permissions in the system. When a user type is assigned to a user, this user has all the permissions specified for the user type.

There are four user types in the system:

- **Admin:** Default super administrator in the system, has full system access. Its initial password is **123456**.
- **Default:** Default user reserved in the system, cannot be created or deleted, and only has access to live view and two-way audio. If the default user is denied access, the corresponding channel is locked when no user is logged in, and  appears in the window.
- **Operator:** Has basic permissions and access to cameras.
- **Guest:** Only has access to cameras by default.

1. Click **System > User**.
2. To add a user, click **Add**, and then set the username and password, select user type, permissions and whether to enable unlock pattern as needed. Click **OK** to save the settings.

Username	User Type	Edit	Delete
admin	Administrator	<input checked="" type="checkbox"/>	—
default	Reserved User	<input checked="" type="checkbox"/>	—

- To edit or delete a user, click  or  as needed. If you change the password for a user, the new password takes effect at the user's next login.

13.5 Security Configuration

13.5.1 IP Address Filtering

Use this function to enhance security by allowing or forbidding access to the NVR from specified IP addresses.

- Click **System > Security > IP Address Filtering**.

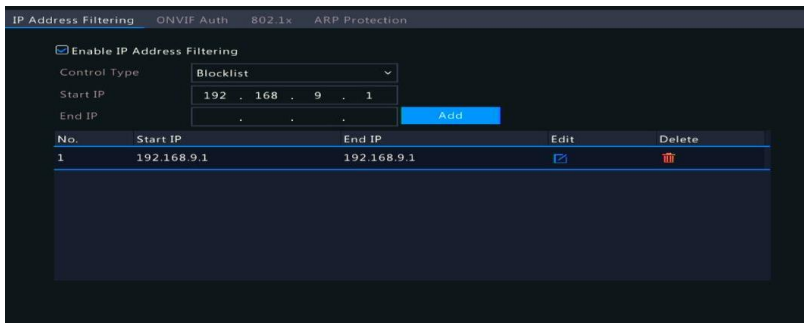

- Select **Enable IP Address Filtering**, select **Blocklist** or **Allowlist** from the drop-down list, set the start and end IP addresses, and then click **Add**.



NOTE!

- If **Blocklist** is selected, the NVR denies remote access from the IP address(es) on the list.
 - If **Allowlist** is selected, the NVR only allows remote access from the IP address(es) on the list. However, if **Allowlist** is selected with no IP address specified, remote access to the NVR will be denied.
-

3. Click **Apply** to save the settings.

13.5.2 ONVIF Authentication

Enable ONVIF authentication under **System > Security > ONVIF Auth** so a username and password will be required for ONVIF-based device access.

Select the check box and then click **Apply**.

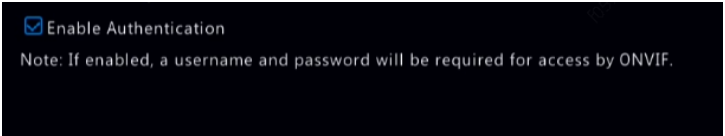

Enable Authentication

Note: If enabled, a username and password will be required for access by ONVIF.

13.5.3 ARP Protection

ARP protocol is used to associate an IP address to a hardware MAC address. ARP attacks mainly occur on LAN, in which attackers use forged IP and MAC addresses. ARP protection prevents this kind of attacks by verifying the gateway's MAC address in all access requests.

Note that changing the NIC working mode will disable ARP protection automatically.

1. Click **System > Security > ARP Protection**.



2. Select the desired NIC and then select **Enable ARP Protection**.
3. Obtain the gateway's MAC address automatically, or select **Custom** and input the MAC address.
4. Click **Apply** to save the settings.

13.5.4 802.1x

802.1x is a port-based network access control protocol mainly used to solve authentication and security issues on LAN.

Note that changing the NIC working mode will disable 802.1x automatically.

1. Click **System > Security > 802.1x**.
2. Select the desired NIC and select the check box to enable 802.1x.
3. Select the EAPOL version, and then enter the username and password of the authentication server.
4. Click **Apply** to save the settings.

13.6 Hot Spare Configuration

Note that the hot spare is not functional.



CAUTION!

If the NVR is set as the hot spare device by accident, **all settings and recording data on the set NVR will be removed without a warning message.**

14 System Maintenance

14.1 System Information

Click **Maintenance > System Info** to view the basic NVR information for maintenance purpose.

14.1.2 System Info

Click the **Basic Info** tab to view the basic information such as the device model, serial number, firmware version, build date and operation time.

Basic Info	
Model	NVR
Serial No.	210235T0
Firmware Version	NVR-B31
Build Date	2019-04-22
Operation Time	0 Day(s) 15 Hour(s) 19 Minute(s)

14.1.3 Camera status

Click the **Camera** tab to view camera status (online or offline with possible offline cause) and status of alarm functions such as motion detection, tampering, video loss and audio detection. **Off** means disabled, and **On** means enabled.

Camera ID	Name	Status	Motion	Tampering	Video Loss	Audio
D1	Camera 04	Online	Off	Off	On	Off
D2	D1(3MP)	Online	On	Off	On	Off
D3	wan11un20029	Online	Triggered	Off	On	Off
D4	IP Camera 04	Online	Triggered	Off	On	Off
D5	11111	Online	On	Off	On	Off

14.1.4 Recording status

Click the **Recording** tab to view recording status and stream settings.

Camera ID	Name	Type	Status	Diagnosis	Stream Type	fps	kbps	Resolution
D1	Camera 04	Normal	Ongoing	Normal	Main Stream	25	2590	1920X1080
D2	D1(3MP)	Normal	Ongoing	Normal	Main Stream	20	530	2592X1520
D3	wan1lun20029	Event	Ongoing	Normal	Main Stream	15	496	3000X3000
D4	IP Camera 04	Event	Ongoing	Normal	Main Stream	30	271	1920X1080
D5	11111	Normal	Ongoing	Normal	Main Stream	25	162	1920X1080

14.1.5 Online user

Click the **Online User** tab for information about users who are currently logged in.

<input type="checkbox"/> No.	Username	IP Address	Login Time
1	admin	127.0.0.1	2019-05-17 09:11:47

14.1.6 Disk status

Click the **Disk** tab to view the hard disk status and disk properties.

Disk No.	Total(GB)	Free(GB)	Status	Vendor	Property
1	1842.39	1716.50	Normal		Read/Write

Total Capacity(GB)	1842.39
Free Space(GB)	1716.50

14.2 Network Information

14.2.1 Traffic

Click **Maintenance > Network Info > Network Traffic** to view network traffic information.



14.2.2 Packet Capture

To capture and save packets, click **Maintenance > Network Info > Packet Capture**. Select the USB storage device, specify the port number and IP address, and then click  right to the desired NIC. The captured packets are saved as a backup file in the root directory of the USB storage device. You may click **Open** to view the file.



NOTE!

- The packet size is 1520 bytes by default and can be changed as needed.
- The backup file of the captured packets is named in *NIC name_time.pcap* format.
- Packets cannot be captured if it is already started on the Web interface.

14.2.3 Network Detection

Click **Maintenance > Network Info > Network Test**.

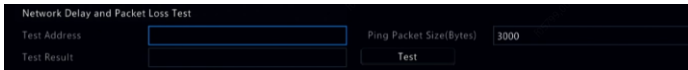

To test network delay and packet loss rate, enter the test address and then click **Start Test**.



NOTE!

The test packet size is 3000 bytes by default and can be changed as needed.

14.2.4 Network Settings

Click **Maintenance > Network Info > Network** to view network settings.

14.2.5 PoE/Network Port Status

Click **System > Network Info** to view port status. A blue port indicates that the port is in use. For PoE models, power information will be displayed.

14.2.6 Network Statistics

Click **Maintenance > Network Info > Network Statistics**. Bandwidth usage statistics are displayed.

Type	Bandwidth
IP Camera	7936Kbps
Remote Live View	0bps
Remote Playback	0bps
Idle Receive Bandwidth	312Mbps
Idle Send Bandwidth	320Mbps



NOTE!















- Insufficient receiving bandwidth (**Idle Receive Bandwidth**) may cause the connected cameras to be offline.
- When the sending bandwidth (**Idle Send Bandwidth**) is insufficient, remote live view, playback or download may fail on the NVR.



14.3 Log Query

Logs contain information about user-performed operations and device status. By analyzing logs, you can keep track of device operation status and view detailed alarm information.

1. Click **Maintenance > Log > Log Search**.
2. Set query conditions, including the start and end times, main type and sub type.

3. Click **Search**.

Username	Operation Time	Camera	Play	Main Type	Sub Type	Details
	2019-05-17 10:18:26	D3		Alarm	Motion Detection Started	
admin	2019-05-17 10:18:10	—	—	Operation	Quick Search IP Camera	
	2019-05-17 10:17:54	D3		Alarm	Motion Detection Ended	
	2019-05-17 10:17:34	D3		Alarm	Motion Detection Started	
	2019-05-17 10:17:26	D3		Alarm	Motion Detection Ended	
	2019-05-17 10:17:22	D4		Alarm	Motion Detection Started	
	2019-05-17 10:17:21	D4		Alarm	Motion Detection Ended	
	2019-05-17 10:16:21	D3		Alarm	Motion Detection Started	

- If  is displayed under **Play**, you may click  to view the recording that started one minute before the alarm time and ended ten minutes after the alarm time.  means this function is not available.
- To export logs to an external storage device, click **Export**, set the export destination and format, and then click **Backup**.

14.4 Import/Export

14.4.1 System Import/Export

Configurations and diagnosis information can be exported to a storage device and saved as files for backup. A configuration file can also be imported to the NVR to restore configurations. The configuration file of an NVR can be imported to multiple NVRs of the same model if you want them to have the same settings. If the imported configuration file contains camera information, the related camera will be added to all the NVRs.

Only admin can perform these operations.

1. Click **Maintenance > Backup > Import/Export**.
2. To export device configurations, specify the destination directory and then click **Export**. A .xml file will be created in the specified directory when export is completed.
3. To import device configurations, double-click the target folder containing the .xml file, select the file, and then click **Import**.



CAUTION!

Delete files with caution. Deleted files cannot be recovered.

14.4.2 Diagnosis Info

The device can save diagnosis info for 14 days and will overwrite the oldest when space is full.

1. Click **Maintenance > Backup > Diagnosis Info**.



The screenshot shows a web interface for 'Diagnosis Info'. At the top, there are radio buttons for 'NVR' (selected) and 'IPC'. Below this, there are tabs for 'Current Diagnosis Info' and 'Export'. The main area contains a table with the following data:

No.	History Diagnosis Info	File Size	Modify Time
<input type="checkbox"/> 1	NVR_Log_20190517000000.tgz	241KB	2019-05-17 00:00:00
<input type="checkbox"/> 2	NVR_Log_20190516000000.tgz	218KB	2019-05-16 00:00:00
<input type="checkbox"/> 3	NVR_Log_20190515000000.tgz	238KB	2019-05-15 00:00:00
<input type="checkbox"/> 4	NVR_Log_20190514000000.tgz	204KB	2019-05-14 00:00:00
<input type="checkbox"/> 5	NVR_Log_20190513000000.tgz	204KB	2019-05-13 00:00:00
<input type="checkbox"/> 6	NVR_Log_20190512000000.tgz	203KB	2019-05-12 00:00:00
<input type="checkbox"/> 7	NVR_Log_20190511000000.tgz	204KB	2019-05-11 00:00:00
<input type="checkbox"/> 8	NVR_Log_20190510000000.tgz	203KB	2019-05-10 00:00:00
<input type="checkbox"/> 9	NVR_Log_20190509000000.tgz	203KB	2019-05-09 00:00:00
<input type="checkbox"/> 10	NVR_Log_20190508000000.tgz	202KB	2019-05-08 00:00:00
<input type="checkbox"/> 11	NVR_Log_20190507000000.tgz	202KB	2019-05-07 00:00:00

2. Select a device type:
 - NVR: For NVR, history diagnosis info is generated at 00:00 every day. To export history diagnosis info, click **Export** at the bottom. To export current diagnosis info, click **Export** right to **Current Diagnosis Info**.
 - IPC: For IPC, history diagnosis info is generated at 00:05 every day. Select channels and then click **Export** at the bottom. To export current diagnosis info, click **Export** right to **Current Diagnosis Info**.



NOTE!

For IPC, diagnosis info is recorded based on channel, which means, if an IPC is added to multiple channels, all the channels will record diagnosis info for the IPC.

14.5 System Restoration

Use this function to restore some or all factory default settings. The NVR will restart automatically to complete this operation. Recordings and operation logs will not be deleted.

1. Click **Maintenance > Restore**.
2. Click **Default** to restore factory default settings except network and user settings, or click **Factory Default** to restore all factory default settings.

14.6 Automatic Maintenance

Set the NVR to restart as scheduled and delete files (including recordings and snapshots) as needed. Only admin can perform this operation.

1. Click **Maintenance > Auto-Function**.
2. Set an auto-restart time, and choose a way to delete files automatically.

Auto-Restart	Never	02:00	
Auto-Delete File(s)	Never		day(s) ago

Note: Auto-Delete File(s) automatically deletes recordings and images saved on hard disk.



CAUTION!

Files deleted automatically cannot be recovered.

14.7 System Upgrade

Upgrade the device locally (using an upgrade file saved in a USB storage device).



CAUTION!

Make sure power is not interrupted during upgrade. A power failure during system upgrade may cause startup failure. Use an Uninterrupted Power Supply (UPS) if necessary.

14.7.1 NVR Upgrade

1. Click **Maintenance > Upgrade**.
2. **Local** is set by default for the upgrade type.
 - Local upgrade
3. Locate the upgrade file and click **Upgrade** to start the upgrade.



NOTE!

- To upgrade the NVR, extract the upgrade file as the .bin file before the operation.
- NVR upgrade is also applicable on the Web interface.

14.7.2 Camera Upgrade

Click **Maintenance > Upgrade > IPC Upgrade** to see if the version of the connected IP camera is up to date. You may upgrade cameras by disk () one by one, or select multiple cameras and then click **Upgrade By Disk** to upgrade cameras in batches.

14.8 Hard Disk Detection

14.8.1 S.M.A.R.T. Test

Click **Maintenance > HDD > S.M.A.R.T. Test** to do the S.M.A.R.T. test.

S.M.A.R.T. (enabled by default) checks the head, platter, motor, and circuit of hard disks to evaluate their health status. The overall evaluation results include **Healthy**, **Failure**, and **Bad Sectors**. It is recommended to replace the disk immediately if the status is **Failure**.

Continue to use the disk when it fails to pass evaluation.

Select Disk: Slot1

Test Type: Short

Test Status: Not tested Disk Temperature(°C): 34

Vendor: TOSHIBA Operation Time(day): 501

Model: TOSHIBA MD04ABA400V Self-Evaluation: Pass

Firmware Version: FP1T Overall Evaluation: Healthy

ID	Attribute Name	Status	Flag	Threshold	Value	Worst	Raw Value
1	Raw_Read_Error_Rate	Healthy	0x000b	50	100	100	0
2	Throughput_Performance	Healthy	0x0005	50	100	100	0
3	Spin_Up_Time	Healthy	0x0027	1	100	100	5228
4	Start_Stop_Count	Healthy	0x0032	0	100	100	25
5	Reallocated_Sector_Count	Healthy	0x0033	50	100	100	0



NOTE!

- Some hard disks only support some of the test items.
- The system provides three test types: **Short**, **Extended**, and **Conveyance**. Extended tests detect more thoroughly and thus take longer time than Short tests. Conveyance tests mainly detect data transmission problems.



CAUTION!

Using a faulty disk is risky. Faulty disks should be replaced immediately.

14.8.2 Bad Sector Detection

Bad sector detection checks for bad sectors in hard disks.

1. Click **Maintenance > HDD > Bad Sector Detect**.
2. Select the desired disk and detection type, and then click **Detect** to start detection. Click **Stop** if you want to stop.



CAUTION!

The detection stops automatically when the error count reaches 100.

14.9 One-Click Collect

Collect the diagnosis information of IPC and NVR with one click. Click **Maintenance > One-Click Collect** for the configurations.

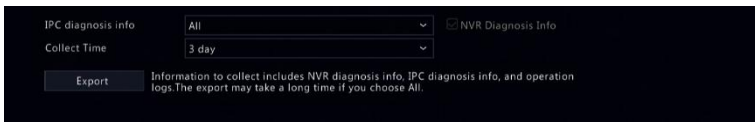

The screenshot shows a configuration window for 'One-Click Collect'. It features two dropdown menus: 'IPC diagnosis info' set to 'All' and 'Collect Time' set to '3 day'. To the right, there is a checkbox labeled 'NVR Diagnosis Info' which is currently unchecked. Below these controls is an 'Export' button and a text box containing the following information: 'Information to collect includes NVR diagnosis info, IPC diagnosis info, and operation logs. The export may take a long time if you choose All.'

15 Shutdown

Click  to shutdown, log out, or restart as needed. To shut down the NVR, you may also long-press the power off button. See no.4 in [1.2.1.1 GV-SNVR3203 / GV-SNVR6403 Front View](#).



CAUTION!

Unsaved settings will be lost if the NVR is shut down unexpectedly, for example, due to a power failure. An incorrect shutdown during a system upgrade may cause startup failures.

Part II Web-Based Operations

1 Before You Begin

You may access and manage your NVR remotely using a web browser on a PC (through the Web interface). Check the following before you begin:

- Access will be authenticated during login, and operation permissions will be required.
- The PC is operating properly and has a network connection to the NVR.
- The PC uses the Windows 8 operating system or later versions.
- A Web browser has been installed on the PC. Microsoft Internet Explorer 8.0 or higher is recommended. Non-IE browsers (Chrome, Edge, Firefox, Safari) are also supported.
- A 32-bit Web browser is still required even if you are using a 64-bit operating system.



NOTE!

- The parameters that are grayed out on the Web GUI cannot be modified. The parameters and values displayed may vary with NVR model.
 - The figures are for illustration purpose only and may vary with NVR model.
-

2 Login

You may need to install a plug-in as prompted at your first login. Close the Web browser when the installation starts.

1. Open a Web browser on your PC and browse to the login page by entering the IP address (**192.168.0.100 / 192.168.1.100** by default) of your NVR.
2. In the login dialog box, enter the default username and password (**admin / 123456**) or the modified password based on your configurations on the NVR and then click **Login**.



CAUTION!

The default password is intended only for your first login. We strongly recommend you set a strong password to ensure account security.

- Strong: contains at least 8 characters from at least three of the four types: upper-case letter, lower-case letter, special character, digit.
 - Weak: contains at least 8 characters from two of the four types: upper-case letter, lower-case letter, special character, digit.
-

3 Live View

The **Live View** page is displayed when you are logged in. The following figure shows an example. Click the camera on the list at the left to access the live view.

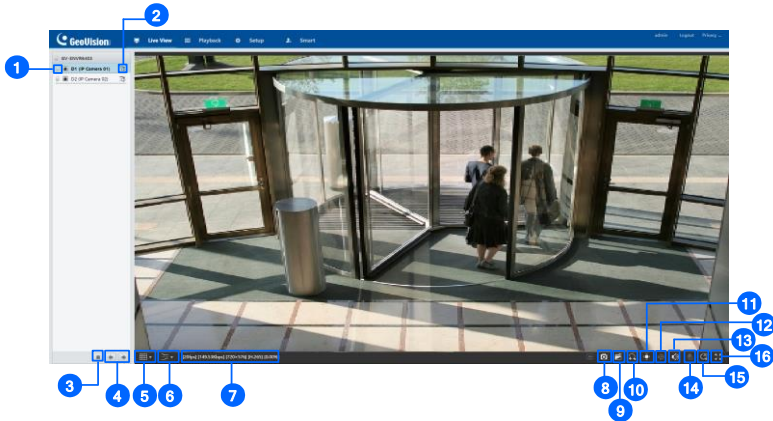





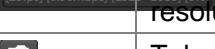













Table 3–1 Live View Window Control Buttons

No.	Button	Description
1		Two-way audio
2		Main/Sub stream
3		Start or stop live view in all windows
4		Previous and next screen
5		Switch screen layout
6		Select stream type
7		Shows the current frame rate, bit rate, resolution, and packet loss rate
8		Take a snapshot
9		Local recording

No.	Button	Description
10		Enable digital zoom
11		Open or close the control panel
12		Set fisheye mounting mode and display mode.
13		Turn on or off audio; adjust sound volume.
14		Adjust MIC volume
15		3D positioning
16		Full screen



NOTE!

- The  icon means two-way audio is available. Click to start two-way audio with the NVR or a camera (depending on where the icon is displayed).
 - Only the main stream  is displayed when the camera is offline or it supports only one stream.
 - Snapshots are saved in a snapshot file folder named by the IP address, and the snapshot file is named in this format: *Camera ID_time*. By default, snapshots are saved in this directory: `\Snap\IP\Camera ID_time`. The time is in YYYYMMDDHHMMSSMS format.
 - Local recordings are saved in a recording file folder named by the IP address, and the recording file is named in this format: *Camera ID_S recording start time_E recording end time*. By default, recordings are saved in this directory: `\Record\IP\Camera ID_S recording start time_E recording end time`. The recording start and end times are in YYYYMMDDHHMMSSMS format.
-

4 Playback

Click **Playback** on the top to show the **Playback** page. The following figure shows an example. Click the camera to access the playback videos.

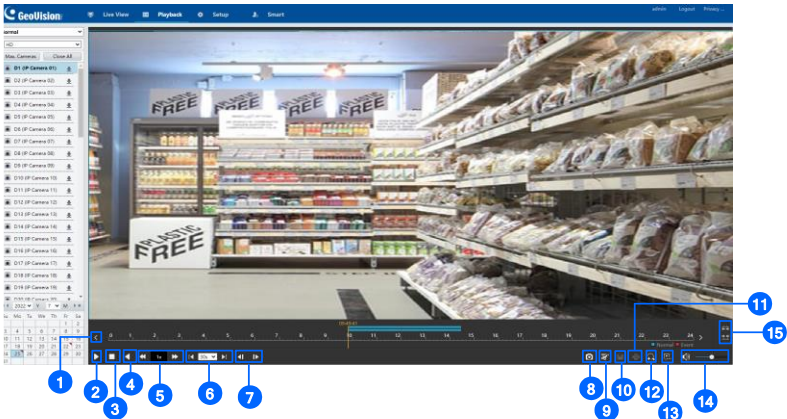

















Table 4-1 Playback Control Buttons

No.	Button	Description
1		Previous or next period (time)
2		Play/Pause
3		Stop
4		Reverse
5		Slow down or speed up
6		Rewind or forward the playback video; adjust the rewind/forward time length by selecting from the dropdown list in the middle

No.	Button	Description
7		Rewind or forward by frame
8		Take a snapshot
9		Clip video/pause
10		Save video clip
11		Set fisheye mounting mode and display mode.
12		Enable digital zoom
13		Add customized tag
14		Adjust sound volume; turn on or off sound
15		Zoom in/out the playback timeline

5 Configuration

Click **Setup** on the top, and then click the menus on the left to configure parameters.

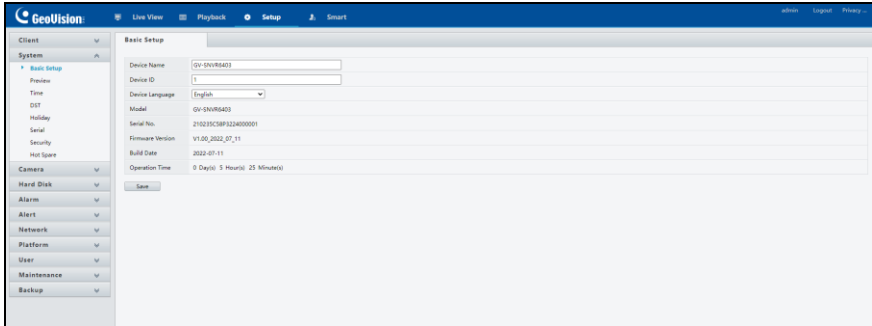

Appendix A Typical Applications

Typical Application 1

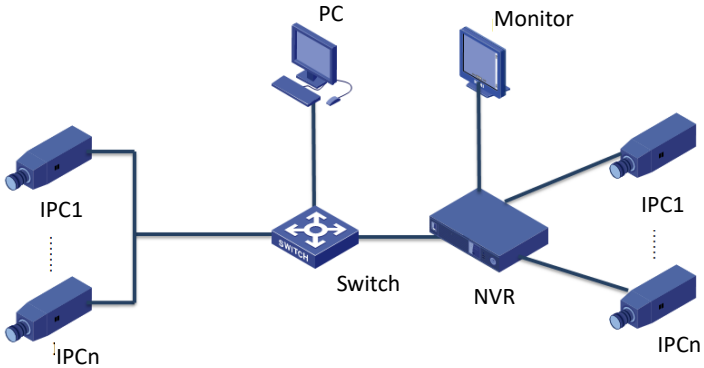

The NVR, IP cameras, and PC are connected on a private network (or LAN). The IP cameras can be connected to the NVR directly or via a switch. You can manage the NVR and the connected IP cameras through the monitor or using a web browser on the PC.

Typical Application 2

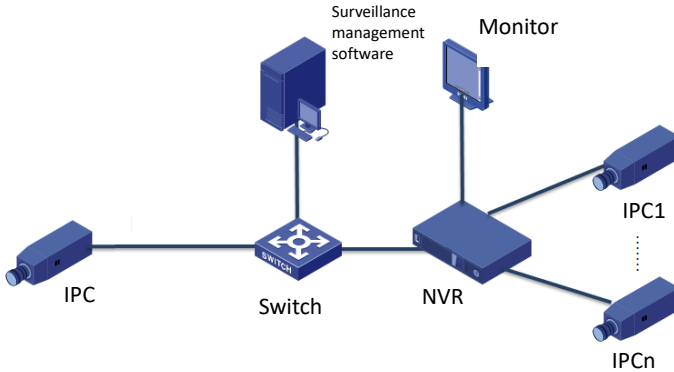

The NVR, IP cameras, and PC are connected on a private network (or LAN). The IP cameras can be connected to the NVR directly or via a switch. The PC is installed with surveillance management software. You can manage the NVR and the connected IP cameras using the surveillance software or through the monitor.

Appendix B Acronyms

Acronym	Description
CBR	Constant Bit Rate
DDNS	Dynamic Domain Name Service
DHCP	Dynamic Host Configuration Protocol
DST	Daylight Saving Time
FTP	File Transfer Protocol
HDMI	High Definition Multimedia Interface
HTTPS	Hypertext Transfer Protocol Over Secure Sockets Layer
IPC	IP Camera
JPEG	Joint Photographic Experts Group
MTU	Maximum Transfer Unit
NAT	Network Address Translation
NIC	Network Interface Card
NTP	Network Time Protocol
NVR	Network Video Recorder
ONVIF	Open Network Video Interface Forum
PoE	Power over Ethernet
PPPoE	Point-to-Point Protocol over Ethernet
PTZ	Pan, Tilt, Zoom
RAID	Redundant Arrays of Independent Disks
RTSP	Real-Time Streaming Protocol
SDK	Software Development Kit
S.M.A.R.T.	Self-Monitoring, Analysis and Reporting Technology
UPnP	Universal Plug-and-Play
USB	Universal Serial Bus
VGA	Video Graphics Array

Acronym	Description
VBR	Variable Bit Rate

Appendix C FAQs

Problem	Possible Cause and Solution
Forgot the login password	Click Forgot Password on the login page, then follow the on-screen instructions to retrieve password.
The Web plugin (ActiveX) cannot be loaded.	<ul style="list-style-type: none"> • Close your web browser when the installation starts. • Disable the firewall and close the anti-virus program on your computer. • Enable your Internet Explorer (IE) to check for newer versions of the stored pages every time you visit the webpage (Tools > Internet Options > General > Settings). • Add your NVR's IP address to the trusted sites in your IE (Tools > Internet Options > Security). • Add your NVR's IP address to the Compatibility View list in your IE (Tools > Compatibility View Settings). • Clear your IE's cache.

Problem	Possible Cause and Solution
<p>No images are displayed in live view on the Web interface.</p>	<p>Check if the bit rate is 0Mbps in the live view window.</p> <ul style="list-style-type: none"> • If yes, check if the firewall has been disabled, and the anti-virus program has been stopped on your computer. • If not, maybe it is because the graphics card driver on your computer is not working properly. Try installing the driver again.
<p>A camera is offline, and No Link is displayed.</p>	<p>Click Maintenance > System Info > Camera. The cause is displayed under Status. Common causes include disconnected network, incorrect username or password, weak password, insufficient bandwidth.</p> <ul style="list-style-type: none"> • Check network connection and network configurations. • If it indicates incorrect username or password, check that the camera password set in the NVR is the one used to access the camera's Web interface. • If it indicates denied access for weak password, log in to the camera's Web interface and set a strong password. • If it indicates insufficient bandwidth, delete other online IP devices in the NVR.

Problem	Possible Cause and Solution
<p>The NVR displays live video for some cameras and No Resource for others.</p>	<ul style="list-style-type: none"> • Set the camera to encode the sub stream, and decrease its resolution to D1. • Set the NVR to use the sub stream first for live view.
<p>A camera goes online and offline repeatedly.</p>	<ul style="list-style-type: none"> • Check if network connection is stable. • Upgrade the firmware for the camera and the NVR. Contact your dealer for the latest versions.
<p>Live view is normal, but the recording cannot be found.</p>	<ul style="list-style-type: none"> • Check if a recording schedule has been properly configured. • Check if the time and time zone configured in the NVR are correct. • Check if the hard disk storing the recording has been damaged. • Check if the desired recording has been overwritten.
<p>Motion detection is not effective.</p>	<ul style="list-style-type: none"> • Check if motion detection is enabled, and the motion detection area is properly configured. • Check if detection sensitivity is properly set. • Check if the arming schedule is properly configured.

Problem	Possible Cause and Solution
A hard disk cannot be identified by the NVR.	<ul style="list-style-type: none">• Use the power adapter delivered with your NVR.• Power down the NVR and then mount the hard disk again.• Try another disk slot.• The disk is not compatible with your NVR.
The mouse does not work.	<ul style="list-style-type: none">• Use the mouse delivered with your NVR.• Make sure no cable is extended.