

Olympus

0-T400 installation and service manual



OLY **M** PUS ^{CRS}

Dell EMC PowerEdge T440

Installation and Service Manual

Notes, cautions, and warnings

 **NOTE:** A NOTE indicates important information that helps you make better use of your product.

 **CAUTION:** A CAUTION indicates either potential damage to hardware or loss of data and tells you how to avoid the problem.

 **WARNING:** A WARNING indicates a potential for property damage, personal injury, or death.

Chapter 1: Dell EMC PowerEdge T440 system overview.....	7
Supported configurations for the Dell EMC PowerEdge T440 system.....	7
Front view of the system.....	9
Status LED indicators.....	15
System health and system ID indicator codes.....	16
Drive indicator codes.....	17
Back view of the system.....	17
NIC indicator codes.....	19
Power supply unit indicator codes.....	19
Locating the Service Tag of your system.....	20
System information label.....	22
Chapter 2: Initial system setup and configuration.....	24
Setting up your system.....	24
iDRAC configuration.....	24
Options to set up iDRAC IP address.....	24
Log in to iDRAC.....	25
Options to install the operating system.....	25
Methods to download firmware and drivers.....	25
Downloading drivers and firmware.....	26
Chapter 3: Installing and removing system components.....	27
Safety instructions.....	27
Before working inside your system.....	28
After working inside your system.....	28
Recommended tools.....	28
Optional front bezel.....	28
Removing the front bezel.....	28
Installing the front bezel.....	29
System feet.....	30
Removing the system feet.....	30
Installing the system feet.....	31
Inside the system.....	32
Caster wheels – optional.....	34
Removing caster wheels.....	34
Installing caster wheels.....	34
System cover.....	35
Removing the system cover.....	35
Installing the system cover.....	36
Air shroud.....	38
Removing the air shroud.....	38
Installing the air shroud.....	38
Drives.....	39
Removing a drive blank.....	39

Installing a drive blank.....	40
Removing a drive carrier.....	41
Installing a drive carrier.....	42
Removing the drive from the drive carrier.....	43
Installing a drive into the drive carrier.....	43
Removing a 2.5-inch drive from a 3.5-inch drive adapter.....	44
Installing a 2.5-inch drive into a 3.5-inch drive adapter.....	45
Removing a 3.5-inch drive adapter from a 3.5-inch drive carrier.....	46
Installing a 3.5-inch drive adapter into the 3.5-inch drive carrier.....	47
Optical drives and tape drives.....	48
Removing the optical or tape drive blank.....	48
Installing the optical or tape drive blank.....	49
Removing the optical drive cage or tape drive.....	50
Installing the optical drive cage or tape drive.....	51
Cabled drives.....	52
Removing the internal hard drive bay.....	52
Installing the internal hard drive bay.....	53
Removing a cabled drive.....	54
Installing a cabled drive.....	55
Drive backplane.....	56
Drive backplane guidelines.....	56
Backplane cable routing.....	59
Removing a hard drive backplane.....	61
Installing a hard drive backplane.....	62
System memory.....	63
System memory guidelines	63
General memory module installation guidelines.....	65
Mode-specific guidelines.....	65
Removing a memory module.....	68
Installing a memory module.....	69
Cooling fans.....	70
Removing the internal cooling fan.....	70
Installing the internal cooling fan.....	70
Removing the external cooling fan	71
Installing the external cooling fan.....	72
Optional internal USB memory key.....	72
Replacing the optional internal USB memory key.....	72
Expansion card holder.....	73
Removing the expansion card holder.....	73
Installing the expansion card holder.....	73
Expansion cards.....	74
Expansion card installation guidelines.....	74
GPU card installation guidelines.....	75
Removing a expansion card.....	76
Installing an expansion card.....	77
M.2 SSD module.....	78
Removing the M.2 SSD module.....	78
Installing the M.2 SSD module.....	79
Optional MicroSD or vFlash card.....	80
Removing the MicroSD card.....	80

Installing the MicroSD card.....	81
Optional IDSDM or vFlash module.....	82
Removing the optional IDSDM or vFlash card.....	82
Installing optional IDSDM or vFlash card.....	83
Processors and heat sinks.....	84
Removing a processor and heat sink module.....	84
Removing the processor from the processor and heat sink module.....	85
Installing the processor into a processor and heat sink module.....	87
Installing a processor and heat sink module.....	89
Power supply units.....	91
Removing a power supply unit blank.....	91
Installing a power supply unit blank.....	91
Removing a power supply unit.....	92
Installing a power supply unit.....	93
Removing a cabled power supply unit.....	93
Installing a cabled power supply unit.....	94
Power interposer board.....	95
Removing the power interposer board.....	95
Installing the power interposer board.....	96
System battery.....	97
Replacing the system battery.....	97
Control panel assembly.....	98
Removing the control panel assembly.....	98
Installing the control panel assembly.....	98
System board.....	100
Removing the system board.....	100
Installing the system board.....	102
Restoring the system using Easy Restore.....	103
Trusted Platform Module.....	104
Upgrading the Trusted Platform Module.....	104
Initializing TPM for BitLocker users.....	105
Initializing the TPM 1.2 for TXT users.....	105
Converting the system from tower mode to rack mode.....	106
Converting the system from tower mode to rack mode	106
Updating BIOS.....	107
Chapter 4: Jumpers and connectors	108
System board jumpers and connectors.....	108
System board jumper settings.....	109
Disabling forgotten password.....	109
Chapter 5: System diagnostics.....	111
Dell Embedded System Diagnostics.....	111
Running the Embedded System Diagnostics from Boot Manager.....	111
Running the Embedded System Diagnostics from the Dell Lifecycle Controller.....	111
System diagnostic controls.....	111
Chapter 6: Getting help.....	113
Contacting Dell EMC.....	113

Documentation feedback.....	113
Accessing system information by using QRL.....	113
Quick Resource Locator for Dell EMC PowerEdge T440 system.....	114
Receiving automated support with SupportAssist	114
Recycling or End-of-Life service information.....	114

Chapter 7: Documentation resources..... 115

Dell EMC PowerEdge T440 system overview

The Dell EMC PowerEdge T440 system is a dual-socket, 5U rackable tower server that supports up to:

- Two Intel Xeon Scalable Processors
- 16 DIMM slots
- 4 or 8 x 3.5-inch SAS/SATA drive or SSDs, or 16 x 2.5-inch SAS/SATA drive bays (up to 12 Gbps SAS and 6 Gbps SATA)
- Redundant power supply units (PSUs)
- Cabled power supply units (PSUs)

Topics:

- [Supported configurations for the Dell EMC PowerEdge T440 system](#)
- [Front view of the system](#)
- [Back view of the system](#)
- [Locating the Service Tag of your system](#)
- [System information label](#)

Supported configurations for the Dell EMC PowerEdge T440 system

The Dell EMC PowerEdge T440 system supports the following configurations:

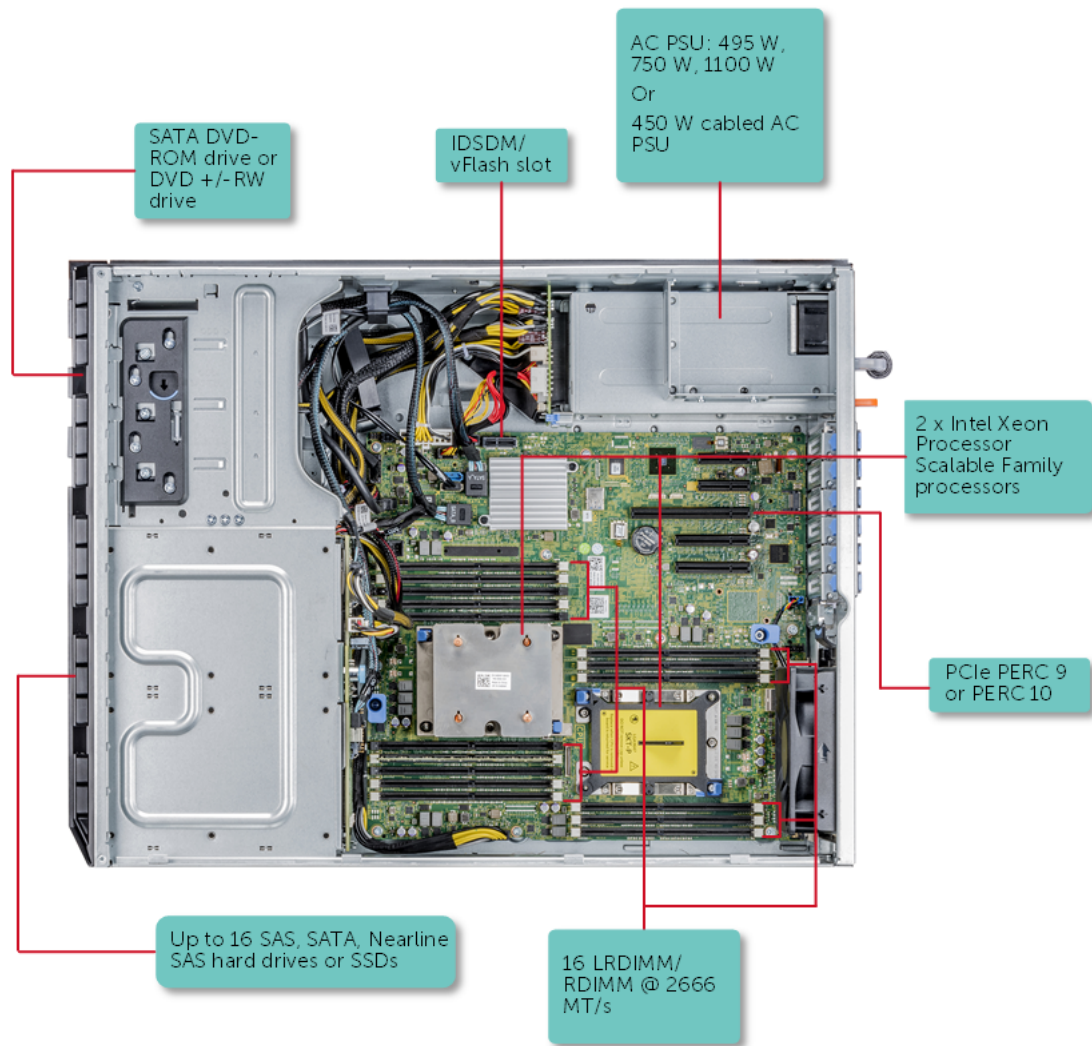

Figure 1. Supported configurations for a Dell EMC PowerEdge T440 system

Front view of the system

The front view displays the features available on the front of the system.

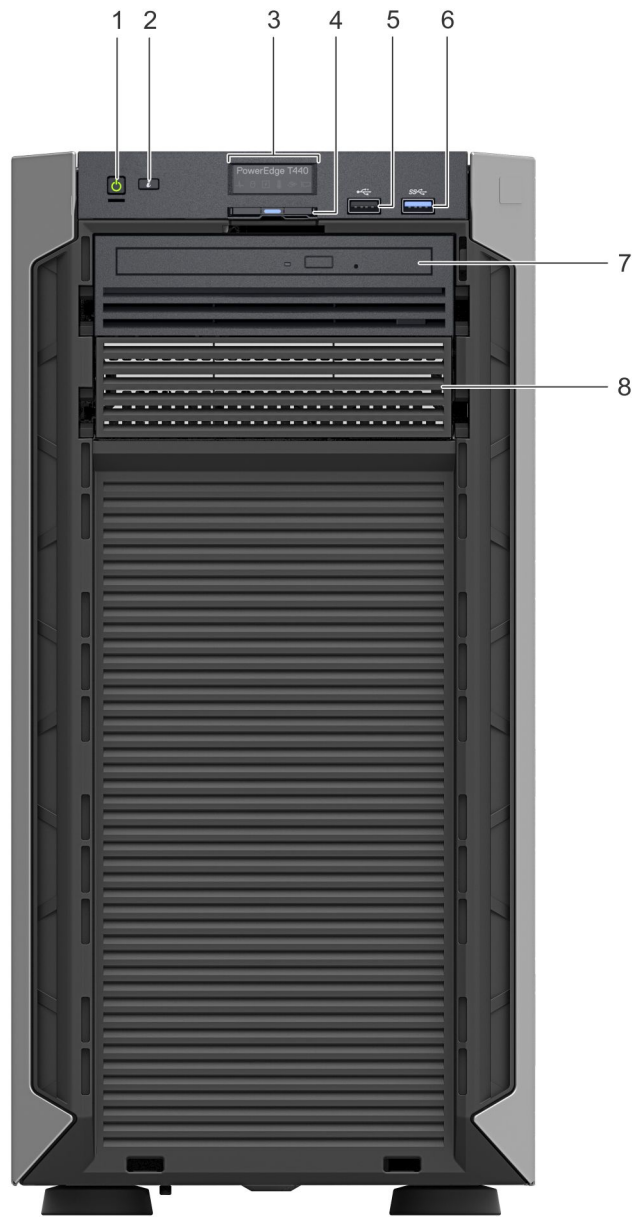



Figure 2. Front panel view of 4 x 3.5-inch cabled drive system

Table 1. Front panel features

Item	Components	Icon	Description
1	Power button		Indicates if the system is powered on or off. Press the power button to manually power on or off the system. NOTE: Press the power button to gracefully shut down an ACPI-compliant operating system.
2	System identification button		The System Identification (ID) button is available on the front and back of the systems. Press the button to identify a system in a rack by

Table 1. Front panel features (continued)

Item	Components	Icon	Description
			turning on the system ID button. You can also use the system ID button to reset iDRAC and to access BIOS using the step through mode.
3	Status LED indicator panel	N/A	Indicate the status of the system. For more information, see the Dell EMC PowerEdge T440 Technical Specifications on the product documentation page.
4	Information tag	N/A	The Information tag is a slide-out label panel that contains system information such as Service Tag, NIC, MAC address, and so on. If you have opted for the secure default access to iDRAC, the Information tag also contains the iDRAC secure default password.
5	USB port 2.0		The USB ports are 4-pin, 2.0-compliant. These ports enable you to connect USB devices to the system.
6	USB port 3.0		The USB port is USB 3.0 compliant.
7	Optical drive bay	N/A	Enable you to install drives that are supported on your system. For more information, see the Dell EMC PowerEdge T440 Technical Specifications on the product documentation page.
8	Drive slot	N/A	Enables you to install TBUs for 8x and 16x backplane configurations, or drive blank in the empty drive slot to maintain proper system cooling.

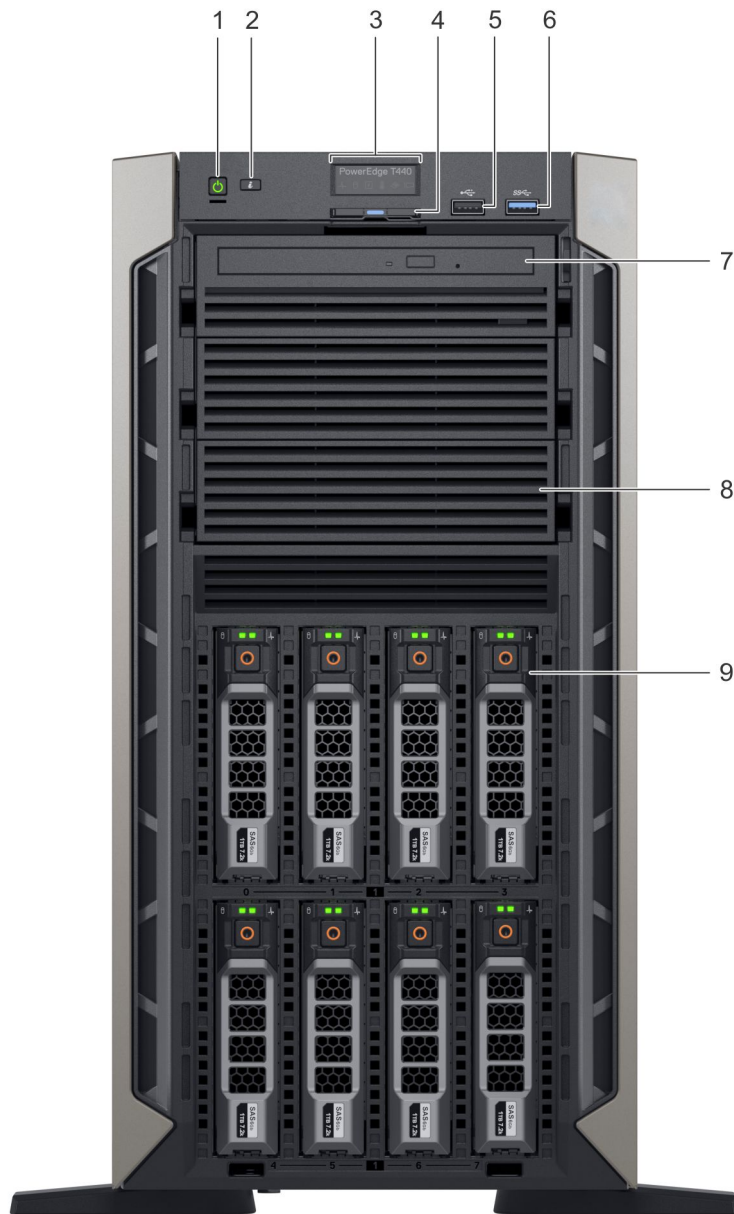

Figure 3. Front panel view of 8 x 3.5-inch hot swappable drive system

Table 2. Front panel features





Item	Components	Icon	Description
1	Power button		Indicates if the system is powered on or off. Press the power button to manually power on or off the system. i NOTE: Press the power button to gracefully shut down an ACPI-compliant operating system.
2	System identification button		The System Identification (ID) button is available on the front and back of the systems. Press the button to identify a system in a rack by turning on the system ID button. You can also use the system ID button to reset iDRAC and to access BIOS using the step through mode.
3	Status LED indicator panel	N/A	Indicate the status of the system. For more information, see the Dell EMC PowerEdge T440 Technical Specifications on the product documentation page.

Table 2. Front panel features (continued)

Item	Components	Icon	Description
4	Information tag	N/A	The Information tag is a slide-out label panel that contains system information such as Service Tag, NIC, MAC address, and so on. If you have opted for the secure default access to iDRAC, the Information tag also contains the iDRAC secure default password.
5	USB port 2.0		The USB ports are 4-pin, 2.0-compliant. These ports enable you to connect USB devices to the system.
6	USB port 3.0		The USB port is USB 3.0 compliant.
7	Optical drive bay	N/A	Enable you to install drives that are supported on your system. For more information, see the Dell EMC PowerEdge T440 Technical Specifications on the product documentation page.
8	Drive slot	N/A	Enables you to install TBUs for 8x and 16x backplane configurations, or drive blank in the empty drive slot to maintain proper system cooling.
9	Physical drives	N/A	3.5-inch drives and 2.5-inch drives/SSDs.

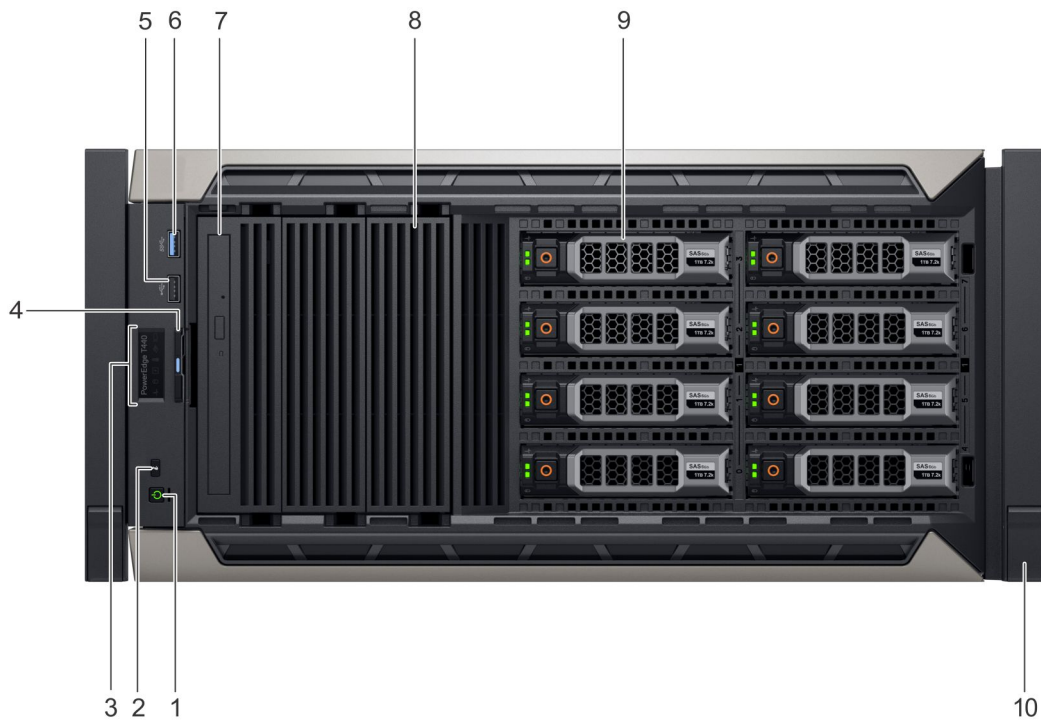

Figure 4. Front panel view of 8 x 3.5-inch hot swappable drive system in rack mode

Table 3. Front panel features





Item	Components	Icon	Description
1	Power button		Indicates if the system is powered on or off. Press the power button to manually power on or off the system. NOTE: Press the power button to gracefully shut down an ACPI-compliant operating system.
2	System identification button		The System Identification (ID) button is available on the front and back of the systems. Press the button to identify a system in a rack by turning on the system ID button. You can also use the system ID button to reset iDRAC and to access BIOS using the step through mode.

Table 3. Front panel features (continued)

Item	Components	Icon	Description
3	Status LED indicator panel	N/A	Indicate the status of the system. For more information, see the Dell EMC PowerEdge T440 Technical Specifications on the product documentation page.
4	Information tag	N/A	The Information tag is a slide-out label panel that contains system information such as Service Tag, NIC, MAC address, and so on. If you have opted for the secure default access to iDRAC, the Information tag also contains the iDRAC secure default password.
5	USB port 2.0		The USB ports are 4-pin, 2.0-compliant. These ports enable you to connect USB devices to the system.
6	USB port 3.0		The USB port is USB 3.0 compliant.
7	Optical drive bay	N/A	Enable you to install drives that are supported on your system. For more information, see the Dell EMC PowerEdge T440 Technical Specifications on the product documentation page.
8	Drive slot	N/A	Enables you to install TBUs for 8x and 16x backplane configurations, or drive blank in the empty drive slot to maintain proper system cooling.
9	Physical drives	N/A	3.5-inch drives and 2.5-inch drives/SSDs.
10	Rack ear	N/A	Enables you to convert the tower system to a rack system.

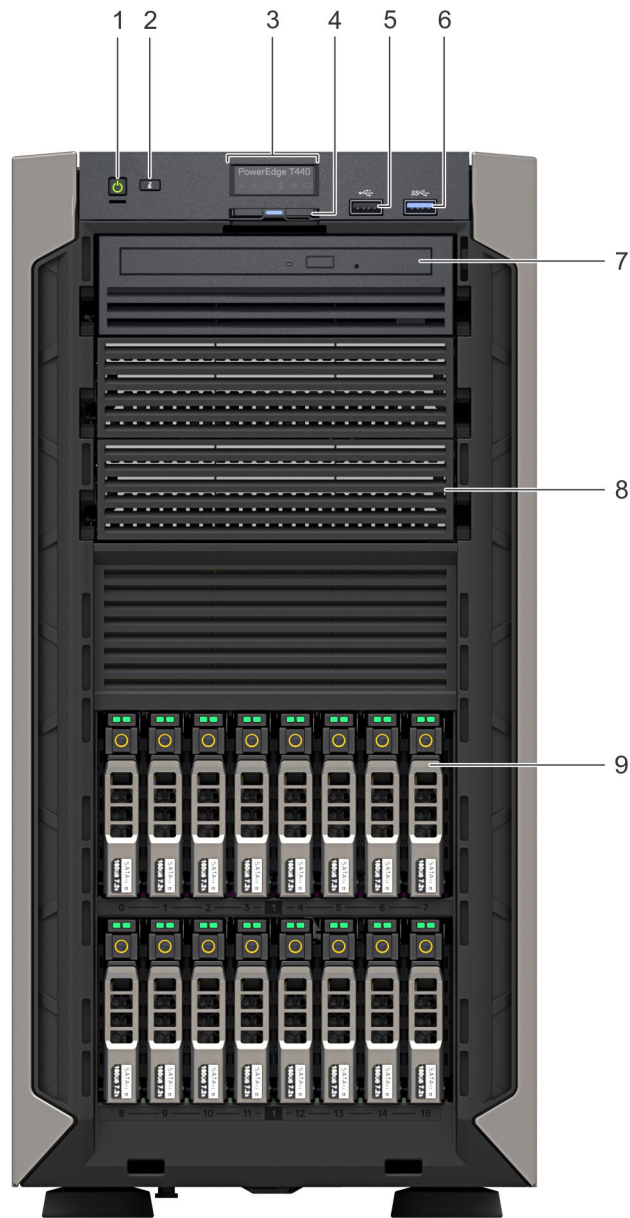

Figure 5. Front panel view of 16 x 2.5-inch hot swappable drive system

Table 4. Front panel features





Item	Components	Icon	Description
1	Power button		Indicates if the system is powered on or off. Press the power button to manually power on or off the system. NOTE: Press the power button to gracefully shut down an ACPI-compliant operating system.
2	System identification button		The System Identification (ID) button is available on the front and back of the systems. Press the button to identify a system in a rack by turning on the system ID button. You can also use the system ID button to reset iDRAC and to access BIOS using the step through mode.
3	Status LED indicator panel	N/A	Indicate the status of the system. For more information, see the Dell EMC PowerEdge T440 Technical Specifications on the product documentation page.

Table 4. Front panel features (continued)

Item	Components	Icon	Description
4	Information tag	N/A	The Information tag is a slide-out label panel that contains system information such as Service Tag, NIC, MAC address, and so on. If you have opted for the secure default access to iDRAC, the Information tag also contains the iDRAC secure default password.
5	USB port 2.0		The USB ports are 4-pin, 2.0-compliant. These ports enable you to connect USB devices to the system.
6	USB port 3.0		The USB port is USB 3.0 compliant.
7	Optical drive bay	N/A	Enable you to install drives that are supported on your system. For more information, see the Dell EMC PowerEdge T440 Technical Specifications on the product documentation page.
8	Drive slot	N/A	Enables you to install TBUs for 8x and 16x backplane configurations, or drive blank in the empty drive slot to maintain proper system cooling.
9	Physical drives	N/A	3.5-inch drives and 2.5-inch drives/SSDs.

Status LED indicators

 **NOTE:** The indicators display solid amber if any error occurs.



Figure 6. Status LED indicators

Table 5. Status LED indicators and descriptions







Icon	Description	Condition	Corrective action
	Health indicator	<p>The indicator turns solid blue if the system is in good health.</p> <p>The indicator blinks amber, when the system is:</p> <ul style="list-style-type: none"> Powered on In standby In any error condition For example, a failed fan, PSU, or a drive 	<p>None required.</p> <p>Check the System event log or system messages for the specific issue.</p> <p>For more information about error messages, see the <i>Event and Error Message Reference Guide for 14th Generation Dell EMC PowerEdge Servers</i> at www.dell.com/qrl.</p> <p>The POST process is interrupted without any video output due to invalid memory configurations. See Getting help.</p>
	Drive indicator	The indicator turns solid amber if there is a drive error.	<ul style="list-style-type: none"> Check the System event log to determine if the drive has an error. Run the appropriate Online Diagnostics test. Restart the system, and run embedded diagnostics (ePSA).

Table 5. Status LED indicators and descriptions (continued)

Icon	Description	Condition	Corrective action
	Electrical indicator	The indicator turns solid amber if the system experiences an electrical error. For example, voltage out of range, or a failed power supply unit (PSU) or voltage regulator.	<ul style="list-style-type: none"> If the drives are configured in a RAID array, restart the system, and enter the host adapter configuration utility. <p>Check the System event log or system messages for the specific issue. If it is due to a problem with the PSU, check the LED on the PSU. Reseat the PSU.</p> <p>If the problem persists, see Getting help.</p>
	Temperature indicator	The indicator turns solid amber if the system experiences a thermal error. For example, the ambient temperature is out of range or there is a fan failure.	<p>Ensure that none of the following conditions exist:</p> <ul style="list-style-type: none"> A cooling fan has been uninstalled or has failed. System cover, air shroud, or back filler bracket is uninstalled. Ambient temperature is too high. External airflow is obstructed. <p>If the problem persists, see Getting help.</p>
	Memory indicator	The indicator turns solid amber if a memory error occurs.	<p>Check the System event log or system messages for the location of the failed memory. Reseat the memory module.</p> <p>If the problem persists, see Getting help.</p>
	PCIe indicator	The indicator turns solid amber if a PCIe card experiences an error.	<p>Restart the system. Update any required drivers for the PCIe card. Reinstall the card.</p> <p>If the problem persists, see Getting help.</p> <p>NOTE: For more information about the supported PCIe cards, see Expansion card installation guidelines.</p>

System health and system ID indicator codes

The system health and system ID button  is on the front panel of your system.



Figure 7. System health and system ID buttons

Table 6. System health and system ID indicator codes

System health and system ID indicator code	Condition
Solid blue	Indicates that the system is turned on, system is healthy, and system ID mode is not active. Press the system health and system ID button to switch to system ID mode.
Blinking blue	Indicates that the system ID mode is active. Press the system health and system ID button to switch to system health mode.
Solid amber	Indicates that the system is in fail-safe mode. If the problem persists, see Getting help .
Blinking amber	Indicates that the system is experiencing a fault. Check the System Event Log for specific error messages. For information about the event and error messages generated by the system firmware and agents that monitor system components, go to qrl.dell.com > Look Up > Error Code , type the error code, and then click Look it up .

Drive indicator codes

Each drive carrier has an activity LED indicator and a status LED indicator. The indicators provide information about the status of the drive. The activity LED indicator indicates whether the drive is in use or not. The status LED indicator indicates the power condition of the drive.

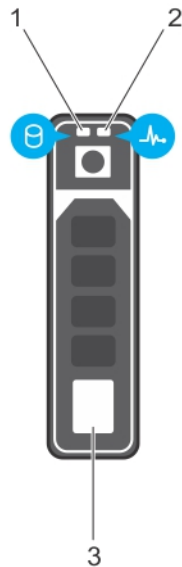

Figure 8. Drive indicators

1. Drive activity LED indicator
2. Drive status LED indicator
3. Drive capacity label

i NOTE: If the drive is in the Advanced Host Controller Interface (AHCI) mode, the status LED indicator does not turn on.

Table 7. Drive indicator codes

Drive status indicator code	Condition
Flashes green twice per second	Identifying drive or preparing for removal.
Off	Drive ready for removal. i NOTE: The drive status indicator remains off until all drives are initialized after the system is turned on. Drives are not ready for removal during this time.
Flashes green, amber, and then powers off	Predicted drive failure.
Flashes amber 4 times per second	Drive failed.
Flashes green slowly	Drive rebuilding.
Solid green	Drive online.
Flashes green for three seconds, amber for three seconds, and then turns off after six seconds.	Rebuild stopped.

Back view of the system

The back panel view of the system shows the features available on the back of the server, such as the system identification button, power supply sockets, iDRAC storage media, NIC ports, and USB and VGA ports. Most of the expansion card ports can be accessed from the back panel. The hot swappable and cabled power supply units are accessible from the back panel.

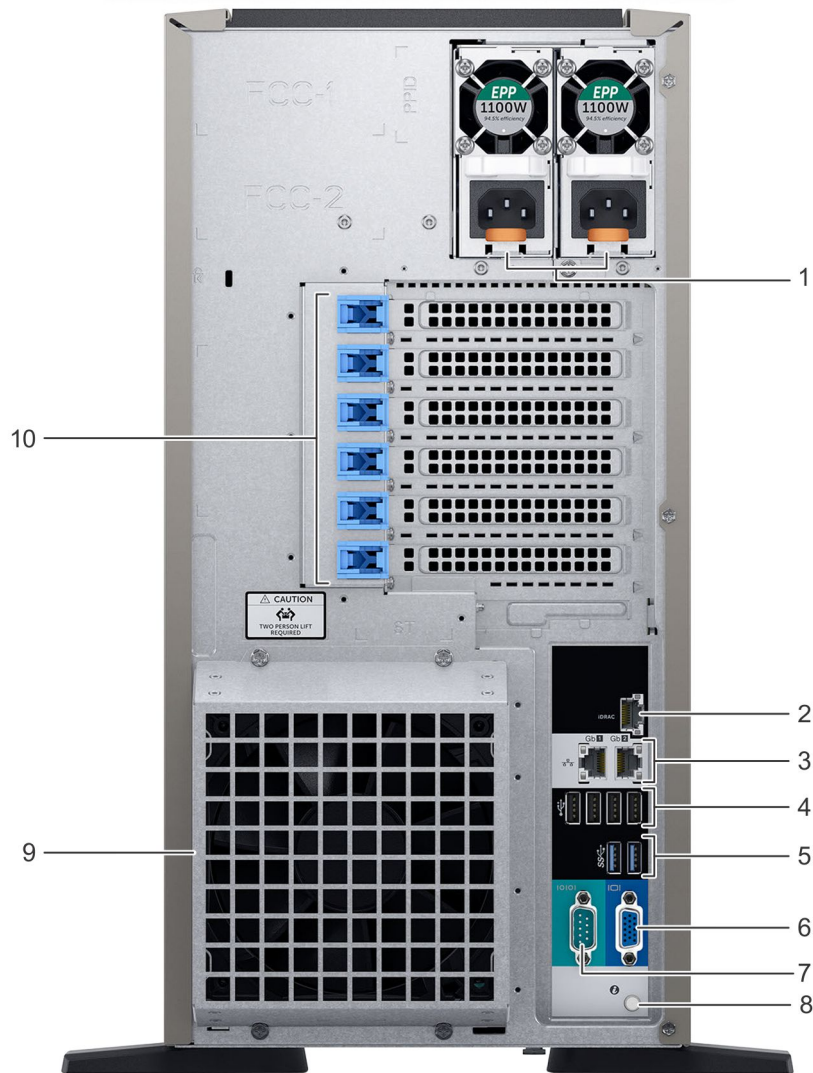

Figure 9. Back view of the system with optional redundant cooling fan

Table 8. Features available on the back view







Item	Ports, panels, or slots	Icon	Description
1	Power supply unit (2)	N/A	For more information, see the Dell EMC PowerEdge T440 Technical Specifications on the product documentation page.
2	iDRAC9 dedicated network port		Enables you to remotely access iDRAC. For more information, see the iDRAC User's Guide at www.dell.com/poweredgemanuals .
3	NIC port (2)		The NIC ports are integrated on the system board provide network connectivity. For more information, see the Dell EMC PowerEdge T440 Technical Specifications on the product documentation page.
4	USB 2.0 port (4)		The USB ports are 4-pin, 2.0-compliant. These ports enable you to connect USB devices to the system.
5	USB 3.0 port (2)		The USB ports are 9-pin and 3.0-compliant. These ports enable you to connect USB devices to the system.
6	VGA port		Enables you to connect a display device to the system. For more information, see the Dell EMC PowerEdge T440 Technical Specifications on the product documentation page.

Table 8. Features available on the back view (continued)

Item	Ports, panels, or slots	Icon	Description
7	Serial port	IOIOI	Enables you to connect a serial device to the system. For more information, see the Dell EMC PowerEdge T440 Technical Specifications on the product documentation page.
8	System identification button		The System Identification (ID) button is available on the front and back of the systems. Press the button to identify a system in a rack by turning on the system ID button. You can also use the system ID button to reset iDRAC and to access BIOS using the step through mode.
9	External cooling fan (optional)	N/A	Enables you to connect an optional redundant cooling fan.
10	PCIe expansion card slot(6)	N/A	The expansion slots enable you to connect PCI Express expansion cards. For more information, see the Dell EMC PowerEdge T440 Technical Specifications on the product documentation page.

NIC indicator codes

Each NIC on the back of the system has indicators that provide information about the activity and link status. The activity LED indicator indicates if data is flowing through the NIC, and the link LED indicator indicates the speed of the connected network.

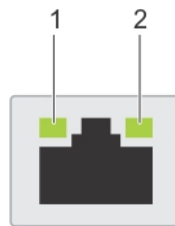

Figure 10. NIC indicator codes

1. Link LED indicator
2. Activity LED indicator

Table 9. NIC indicator codes

Status	Condition
Link and activity indicators are off.	The NIC is not connected to the network.
Link indicator is green, and activity indicator is blinking green.	The NIC is connected to a valid network at its maximum port speed, and data is being sent or received.
Link indicator is amber, and activity indicator is blinking green.	The NIC is connected to a valid network at less than its maximum port speed, and data is being sent or received.
Link indicator is green, and activity indicator is off.	The NIC is connected to a valid network at its maximum port speed, and data is not being sent or received.
Link indicator is amber, and activity indicator is off.	The NIC is connected to a valid network at less than its maximum port speed, and data is not being sent or received.
Link indicator is blinking green, and activity is off.	NIC identify is enabled through the NIC configuration utility.

Power supply unit indicator codes

AC power supply units (PSUs) have an illuminated translucent handle that serves as an indicator. The indicator shows whether power is present or if a power fault has occurred.

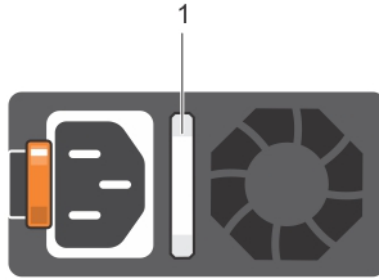

Figure 11. AC PSU status indicator

1. AC PSU status indicator/handle

Table 10. AC PSU status indicator codes

Power indicator codes	Condition
Green	A valid power source is connected to the PSU, and the PSU is operational.
Blinking amber	Indicates a problem with the PSU.
Not illuminated	Power is not connected to the PSU.
Blinking green	When the firmware of the PSU is being updated, the PSU handle blinks green. ⚠ CAUTION: Do not disconnect the power cord, or unplug the PSU when updating firmware. If firmware update is interrupted, the PSUs do not function.
Blinking green and turns off	When hot-plugging a PSU, the PSU handle blinks green five times at a rate of 4 Hz and powers off. It indicates a PSU mismatch regarding efficiency, feature set, health status, or supported voltage. ⚠ CAUTION: If two PSUs are installed, both the PSUs must have the same type of label; for example, Extended Power Performance (EPP) label. Mixing PSUs from previous generations of PowerEdge servers is not supported, even if the PSUs have the same power rating. It results in a PSU mismatch condition or failure to power on the system. ⚠ CAUTION: When correcting a PSU mismatch, replace only the PSU with the blinking indicator. Swapping the PSU to make a matched pair can result in an error condition and unexpected system shutdown. To change from a high output configuration to a low output configuration or conversely, you must turn off the system. ⚠ CAUTION: AC PSUs support both 240 V and 120 V input voltages except for Titanium PSUs, which support only 240 V. When two identical PSUs receive different input voltages, they can output different wattages, and trigger a mismatch. ⚠ CAUTION: If two PSUs are used, they must be of the same type and have the same maximum output power.

Locating the Service Tag of your system

You can identify your system using the unique Express Service Code and Service Tag. Pull out the information tag in front of the system to view the Express Service Code and Service Tag. Alternatively, the information may be on a sticker on the chassis of the system. The mini Enterprise Service Tag (EST) is found on the back of the system. This information is used by Dell to route support calls to the appropriate personnel.

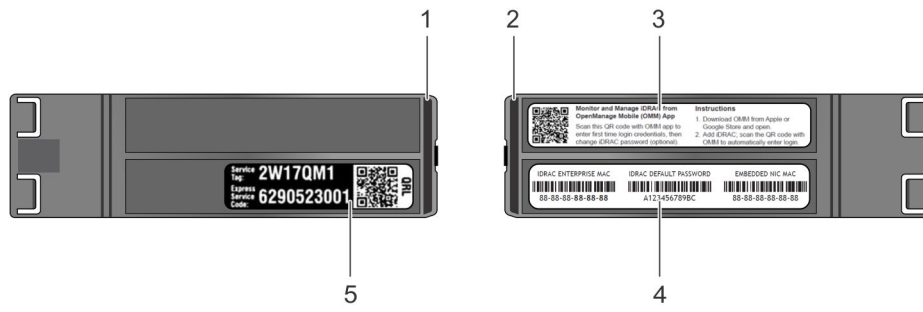

Figure 12. Locating Service Tag of your system

1. Information tag (top view)
2. Information tag (back view)
3. OpenManage Mobile (OMM) label
4. iDRAC MAC address and iDRAC secure password label
5. Service Tag

System information label

Service Information

System Touchpoints

- **Hot swap touchpoints:** Components with terracotta touchpoints can be serviced while the system is running.
- **Cold swap touchpoints:** Components with blue touchpoints require a full system shutdown before servicing.

Mechanical Overview

Rear View

Front View/Rack Mode

Front View

Power System ID Fault LEDs EST DVD/TBU Drivers USB USB 3.0

Hard Drives
3.5" Cabled HDD

Hard Drives
3.5" Hot Swap HDD

Hard Drives
2.5" Hot Swap HDD

Side View

Electrical Overview

System Board Connections

- 1 ODD Power
- 2 System Power
- 3 ODD
- 4 PIB Signal 1
- 5 PIB Signal 2
- 6 IDSDM + vFlash
- 7 Internal USB 3.0
- 8 Coin Cell Battery
- 9 PCIe Card Slot 1 (PCH)
- 10 Jumpers
- 11 PCIe Card Slot 2 (CPU 1)
- 12 TPM

- 13 PCIe Card Slot 3 (CPU 2)
- 14 PCIe Card Slot 4 (CPU 1)
- 15 PCIe Card Slot 5 (CPU 1)
- 16 Fan 1 (Internal Fan)
- 17 Fan 2 (External Fan)
- 18 DIMMs For CPU 2 Channels 0, 1, 2
- 19 CPU 2
- 20 DIMMs For CPU 2 Channels 3, 4, 5
- 21 CPU 2 Power

- 22 DIMMs For CPU 1 Channels 0, 1, 2
- 23 CPU 1
- 24 DIMMs For CPU 1 Channels 3, 4, 5
- 25 CPU 1 Power
- 26 Intrusion Switch
- 27 Backplane Signal
- 28 SATA_B
- 29 Front USB
- 30 SATA_A
- 31 Control Panel

Memory Information

Memory Population

Configuration	Sequence
Memory-Optimized	C1{1}, C2{1}, C1{2}, C2{2}, C1{3}, C2{3}
Mirroring	C1{1,2,3,4,5,6}, C2{1,2,3,4,5,6}

Memory sparing details are documented in the *Installation and Service Manual*.

Jumper Settings

Jumper	Setting	Description
PWRD_EN	(default)	BIOS password is enabled.
	(default)	BIOS password is disabled. iDRAC local access is unlocked at next AC power cycle. iDRAC password reset is enabled in F2 iDRAC settings menu.
NVRAM_CLR	(default)	BIOS configuration settings retained at system boot.
	(default)	BIOS configuration settings cleared at system boot.

Figure 13. PowerEdge T440 – Service information

Icon Legend

	Status		System ID
	Hard Drive Activity		CPU
	Power Supply		Fan
	Temperature		EST Express Service Tag
	Memory Bank		vFlash Media
	PCI		

Scan to see hardware servicing and software setup videos, how-to's, and documentation.



Quick Resource Locator
Dell.com/QRL/Server/PET440

Caution: Memory (DIMMs) and CPUs may be hot during servicing.

Caution: Many repairs may only be done by a certified service technician. You should only perform troubleshooting and simple repairs as authorized in your product documentation, or as directed by the online or telephone service and support team. Damage due to servicing that is not authorized by Dell is not covered by your warranty. Read and follow the safety instructions that came with the product.

Processor Heatsink Module	
CPU	
Cabled Hard Drive	
BOSS (M.2)	
Fan1	
System Tasks	

To learn more about this Dell product or to order additional or replacement parts, go to Dell.com/support
Copyright © 2017 Dell Inc. or its subsidiaries. All Rights Reserved. Rev A00. Label Part No. RGC8F

Figure 14. PowerEdge T440 – Service information

Initial system setup and configuration

Topics:

- [Setting up your system](#)
- [iDRAC configuration](#)
- [Options to install the operating system](#)

Setting up your system

Perform the following steps to set up your system:

Steps

1. Unpack the system.
2. Install the system into the rack. For more information about installing the system into the rack, see the *Rail Installation Guide* at www.dell.com/poweredgemanuals.
3. Connect the peripherals to the system.
4. Connect the system to its electrical outlet.
5. Power on the system by pressing the power button or by using iDRAC.
6. Power on the attached peripherals.

For more information about setting up your system, see the *Getting Started Guide* that shipped with your system.

For information on how to manage basic settings and features of the system, see the Dell EMC PowerEdge T440 BIOS and UEFI Reference Guide on the product documentation page.

iDRAC configuration

The Integrated Dell Remote Access Controller (iDRAC) is designed to make system administrators more productive and improve the overall availability of Dell systems. iDRAC alerts administrators about system issues and enables them to perform remote system management. This reduces the need for physical access to the system.

Options to set up iDRAC IP address

To enable communication between your system and iDRAC, you must first configure the network settings based on your network infrastructure.

 **NOTE:** For static IP configuration, you must request for it at the time of purchase.

This option is set to **DHCP** by Default. You can set up the IP address by using one of the following interfaces:

Interfaces	Document/Section
iDRAC Settings utility	<i>Dell Integrated Dell Remote Access Controller User's Guide</i> at www.dell.com/poweredgemanuals
Dell Deployment Toolkit	<i>Dell Deployment Toolkit User's Guide</i> at www.dell.com/openmanagemanuals > OpenManage Deployment Toolkit
Dell Lifecycle Controller	<i>Dell Lifecycle Controller User's Guide</i> at www.dell.com/poweredgemanuals

 **NOTE:** To access iDRAC, ensure that you connect the ethernet cable to the iDRAC9 dedicated network port. You can also access iDRAC through the shared LOM mode, if you have opted for a system that has the shared LOM mode enabled.

Log in to iDRAC

You can log in to iDRAC as:

- iDRAC user
- Microsoft Active Directory user
- Lightweight Directory Access Protocol (LDAP) user

If you have opted for secure default access to iDRAC, you must use the iDRAC secure default password available on the system Information tag. If you have not opted for secure default access to iDRAC, then use the default user name and password `-root` and `calvin`. You can also log in by using your Single Sign-On or Smart Card.

 **NOTE:** You must have the iDRAC credentials to log in to iDRAC.

 **NOTE:** Ensure that you change the default username and password after setting up the iDRAC IP address.

For more information about logging in to the iDRAC and iDRAC licenses, see the latest *Integrated Dell Remote Access Controller User's Guide* at www.dell.com/poweredgemanuals.

You can also access iDRAC by using RACADM. For more information, see the *RACADM Command Line Interface Reference Guide* at www.dell.com/poweredgemanuals.

Options to install the operating system

If the system is shipped without an operating system, install a supported operating system by using one of the following resources:

Table 11. Resources to install the operating system

Resources	Location
iDRAC	www.dell.com/idracmanuals
Lifecycle Controller	www.dell.com/idracmanuals > Lifecycle Controller
OpenManage Deployment Toolkit	www.dell.com/openmanagemanuals > OpenManage Deployment Toolkit
Dell certified VMware ESXi	www.dell.com/virtualizationsolutions
Installation and How-to videos for supported operating systems on PowerEdge systems	Supported Operating Systems for Dell EMC PowerEdge systems

Methods to download firmware and drivers

You can download the firmware and drivers by using any of the following methods:

Table 12. Firmware and drivers

Methods	Location
From the Dell EMC support site	www.dell.com/support/home
Using Dell Remote Access Controller Lifecycle Controller (iDRAC with LC)	www.dell.com/idracmanuals
Using Dell Repository Manager (DRM)	www.dell.com/openmanagemanuals > Repository Manager
Using Dell OpenManage Essentials	www.dell.com/openmanagemanuals > OpenManage Essentials
Using Dell OpenManage Enterprise	www.dell.com/openmanagemanuals > OpenManage Enterprise
Using Dell Server Update Utility (SUU)	www.dell.com/openmanagemanuals > Server Update Utility

Table 12. Firmware and drivers (continued)

Methods	Location
Using Dell OpenManage Deployment Toolkit (DTK)	www.dell.com/openmanagemanuals > OpenManage Deployment Toolkit
Using iDRAC virtual media	www.dell.com/idracmanuals

Downloading drivers and firmware

Dell EMC recommends that you download and install the latest BIOS, drivers, and systems management firmware on your system.

Prerequisites

Ensure that you clear the web browser cache before downloading the drivers and firmware.

Steps

1. Go to www.dell.com/support/home.
2. In the **Drivers & Downloads** section, type the Service Tag of your system in the **Enter a Service Tag or product ID** box, and then click **Submit**.
 **NOTE:** If you do not have the Service Tag, select **Detect Product** to allow the system to automatically detect the Service Tag, or click **View products**, and navigate to your product.
3. Click **Drivers & Downloads**.
The drivers that are applicable to your system are displayed.
4. Download the drivers to a USB drive, CD, or DVD.

Installing and removing system components

Topics:

- Safety instructions
- Before working inside your system
- After working inside your system
- Recommended tools
- Optional front bezel
- System feet
- Inside the system
- Caster wheels – optional
- System cover
- Air shroud
- Drives
- Optical drives and tape drives
- Cabled drives
- Drive backplane
- System memory
- Cooling fans
- Optional internal USB memory key
- Expansion card holder
- Expansion cards
- M.2 SSD module
- Optional MicroSD or vFlash card
- Optional IDSDM or vFlash module
- Processors and heat sinks
- Power supply units
- Power interposer board
- System battery
- Control panel assembly
- System board
- Trusted Platform Module
- Converting the system from tower mode to rack mode
- Updating BIOS

Safety instructions

 **NOTE:** Whenever you need to lift the system, get others to assist you. To avoid injury, do not attempt to lift the system by yourself.

 **WARNING:** Opening or removing the system cover while the system is powered on may expose you to a risk of electric shock.

 **CAUTION:** Do not operate the system without the cover for a duration exceeding five minutes. Operating the system without the system cover can result in component damage.

 **CAUTION:** Many repairs may only be done by a certified service technician. You should only perform troubleshooting and simple repairs as authorized in your product documentation, or as directed by the online or telephone service and support team. Damage due to servicing that is not authorized by Dell is not covered by your warranty. Read and follow the safety instructions that are shipped with your product.

 **NOTE:** It is recommended that you always use an antistatic mat and antistatic strap while working on components inside the system.

 **CAUTION:** To ensure proper operation and cooling, all bays in the system and system fans must be always populated with a component or a blank.

Before working inside your system

Prerequisites

Follow the safety guidelines listed in [Safety instructions](#).

Steps

1. Turn off the system, including all attached peripherals.
2. Disconnect the system from the electrical outlet and disconnect the peripherals.
3. Lay the system on its side.
4. Remove the system cover.

After working inside your system

Prerequisites

Follow the safety guidelines listed in [Safety instructions](#).

Steps

1. Install the system cover.
2. Place the system upright on a flat, stable surface.
3. Reconnect the peripherals and connect the system to the electrical outlet.
4. Turn on the attached peripherals and then turn on the system.

Recommended tools

You need the following tools to perform the removal and installation procedures:

- Key to the bezel lock
The key is required only if your system includes a bezel.
- Phillips #1 screwdriver
- Phillips #2 screwdriver
- Torx #T30 screwdriver
- Wrist grounding strap

Optional front bezel

Removing the front bezel

Prerequisites

Follow the safety guidelines listed in [Safety instructions](#).

Steps

1. Unlock the bezel by using the bezel key.

i **NOTE:** There are two bezel keys attached to the back of the bezel.

2. Press the release latch at the top of the bezel.
3. Pull the top end of the bezel away from the system.
4. Unhook the bezel tabs from the slots at the bottom of the system, and pull the bezel away from the system.

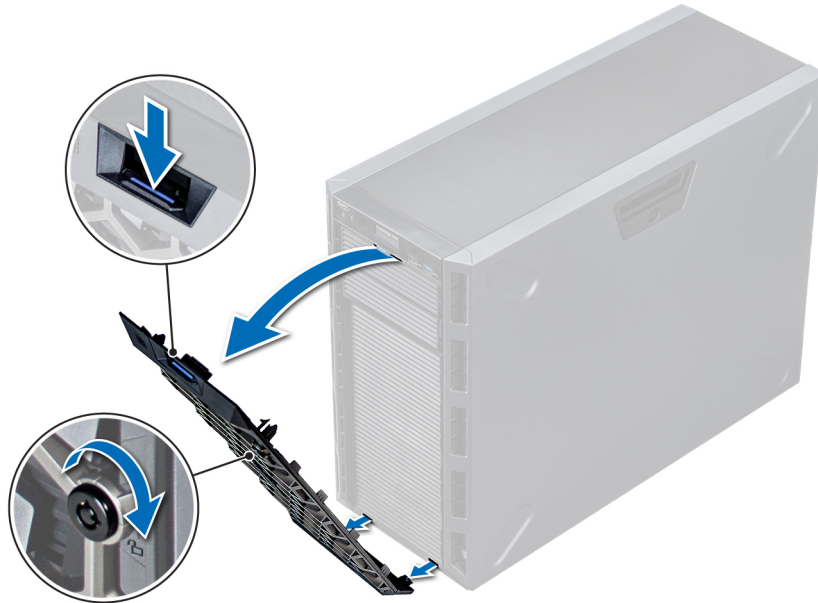

Figure 15. Removing the front bezel

Installing the front bezel

Prerequisites

Follow the safety guidelines listed in [Safety instructions](#).

Steps

1. Locate and remove the bezel key.

i **NOTE:** There are two bezel keys attached to the back of the bezel.

2. Insert the bezel tabs into the slots in the chassis.
3. Press the release latch, and push the bezel toward the system until the bezel locks into place.
4. Using the key lock the bezel.



Figure 16. Installing the front bezel

System feet

Removing the system feet

Prerequisites

i **NOTE:** It is recommended that you remove the system feet only when you are converting the system from the tower mode to the rack mode, or when you are replacing the system feet with the wheel assembly.

1. Follow the safety guidelines listed in [Safety instructions](#).
2. Place the system on its side on a flat, stable surface.
3. Rotate the system feet inward.

Steps

Using the Phillips #2 screwdriver, remove the screw that secures the foot to the base of the system.

- a. Repeat the above step for the 3 remaining feet.



Figure 17. Removing the system feet

Next steps

If applicable, [install the system feet or the caster wheel assembly](#).

Installing the system feet

Prerequisites

CAUTION: Install the feet on a stand-alone tower system to provide stability to the system. An unstable system might tip over and cause injury to the user or damage to the system.

1. Follow the safety guidelines listed in [Safety instructions](#).
2. Place the system on its side, on a flat, stable surface.

Steps

1. Align the three tabs on the system foot with the three slots on the base of the system.
2. Using the Phillips #2 screwdriver, secure the screw that secures the foot to the base of the system.
 - a. Repeat the above steps to install the remaining system feet.



Figure 18. Installing the system feet

Next steps

1. Place the system upright on a flat, stable surface, and rotate the system feet outward.
2. Follow the procedure listed in [After working inside your system](#).

Inside the system

NOTE: Components that are hot swappable are marked orange and touch points on the components are marked blue.

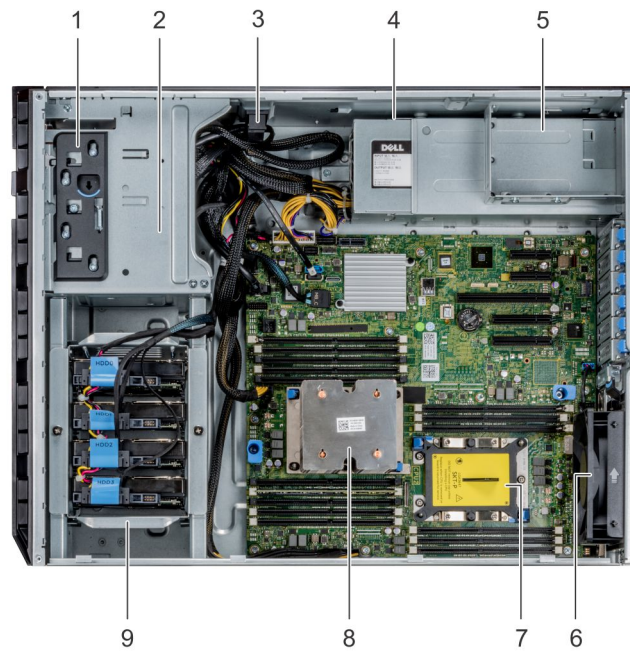

Figure 19. Inside the system - Cabled drive system

- | | |
|---------------------------|-----------------------------|
| 1. release latch | 2. drive cage |
| 3. cable retention lock | 4. cabled power supply unit |
| 5. power supply unit cage | 6. fan |
| 7. processor 2 socket | 8. processor 1 |
| 9. cabled drive cage | |

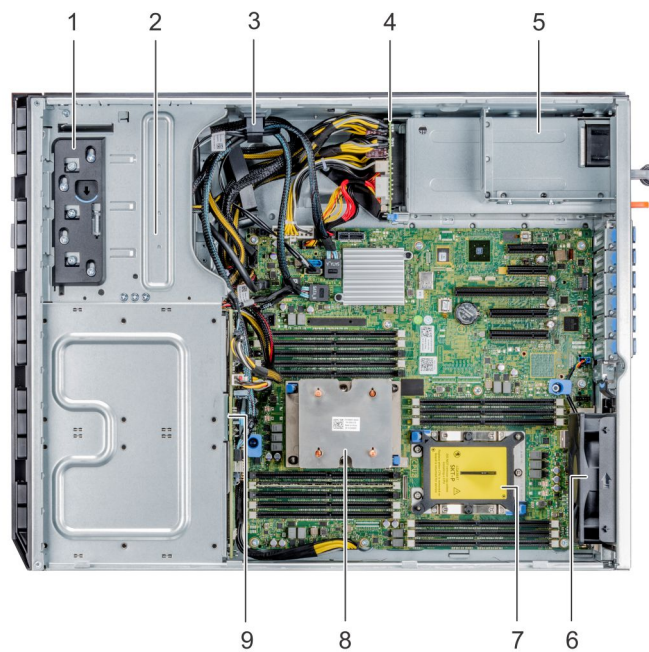

Figure 20. Inside the system - hot swappable drive system

- | |
|---------------------------|
| 1. release latch |
| 2. drive cage |
| 3. cable retention lock |
| 4. power interposer board |
| 5. power supply unit cage |
| 6. fan |

7. processor 2 socket
8. processor 1
9. backplane

Caster wheels – optional

Removing caster wheels

Prerequisites

1. Follow the safety guidelines listed in [Safety instructions](#).
2. Place the system on a flat, stable surface.
3. Extend the wheels beyond the edge of the surface.

Steps

1. Using the Phillips #2 screwdriver, loosen the captive screw that secures the front wheel unit to the base of the system.
2. Push the front wheel unit toward the rear of the system to release the retention hooks, and pull out the front wheel unit.
3. Loosen the screw that secures the back wheel unit to the base of the chassis.
4. Push the rear wheel unit toward the front of the system to release the retention hooks, and pull out the rear wheel unit.



Figure 21. Removing caster wheels

Next steps

Install the caster wheels or the system feet, as applicable.

Installing caster wheels

Prerequisites

1. Follow the safety guidelines listed in [Safety instructions](#).

2. Place the system on its side on a flat, stable surface.
3. If installed, [remove the system feet](#).

Steps

1. Align the two retention hooks on the rear wheel unit with the two slots on the base of the system, and insert the hooks into the slots.
2. Push the rear wheel unit toward the back of the system and using a Phillips #2 screwdriver secure the unit in place using a single screw.
3. Align the two retention hooks on the front wheel unit with the two slots on the base of the system, and insert the hooks into the slots.
4. Push the front wheel unit toward the front of the system and using a Phillips #2 screwdriver secure the unit in place using a single screw.



Figure 22. Installing caster wheels

Next steps

Follow the procedure listed in [After working inside your system](#).

System cover

Removing the system cover

Prerequisites

1. Follow the safety guidelines listed in [Safety instructions](#).
2. Turn off the system and all attached peripherals.
3. Disconnect the system from the electrical outlet and peripherals.
4. If installed, [remove the front bezel](#).
5. Place the system on a flat, stable surface.

Steps

1. Turn the latch release lock to the unlocked position.
2. Press the cover release latch and remove the system cover.

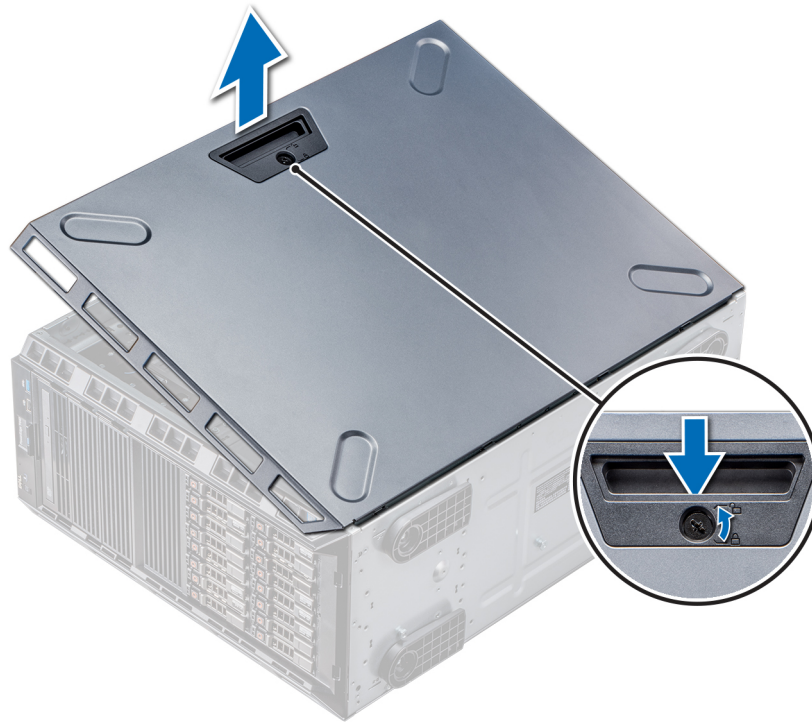

Figure 23. Removing the system cover

Next steps

Install the system cover.

Installing the system cover

Prerequisites

i **NOTE:** Ensure that all internal cables are connected and placed out of the way and no tools or extra parts are left inside the system.

Follow the safety guidelines listed in [Safety instructions](#).

Steps

1. Align the tabs on the system cover with the slots on the chassis.
2. Press the cover release latch, and push the cover toward the chassis until the latch locks into place.
3. Rotate the latch release lock clockwise to the locked position.

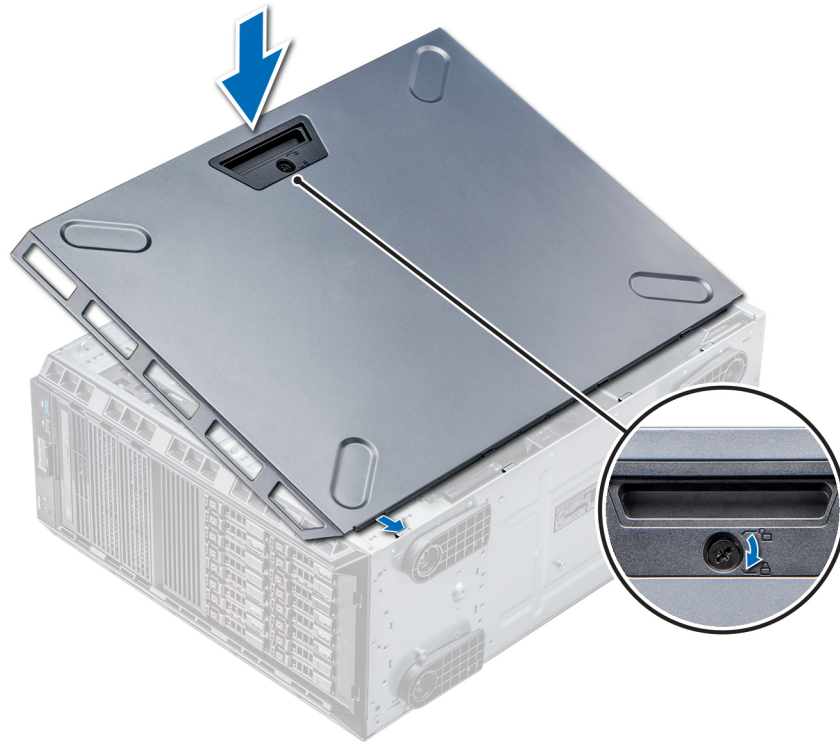

Figure 24. Installing the system cover

Next steps

1. Place the system upright on its feet on a flat and stable surface.
2. If removed, [install the bezel](#).
3. Reconnect the peripherals and connect the system to the electrical outlet.
4. Turn on the system, including all attached peripherals.

Air shroud

Removing the air shroud

Prerequisites

CAUTION: Never operate your system with the air shroud removed. The system may get overheated quickly, resulting in shutdown of the system and loss of data.

1. Follow the safety guidelines listed in [Safety instructions](#).
2. Follow the procedure listed in [Before working inside your system](#).

Steps

Holding the touch points at the center of the air shroud, lift the shroud from the system.

NOTE: Systems with x16 hard-drive backplanes use a different air shroud. To ensure proper cooling, always install the air shroud provided with your system.

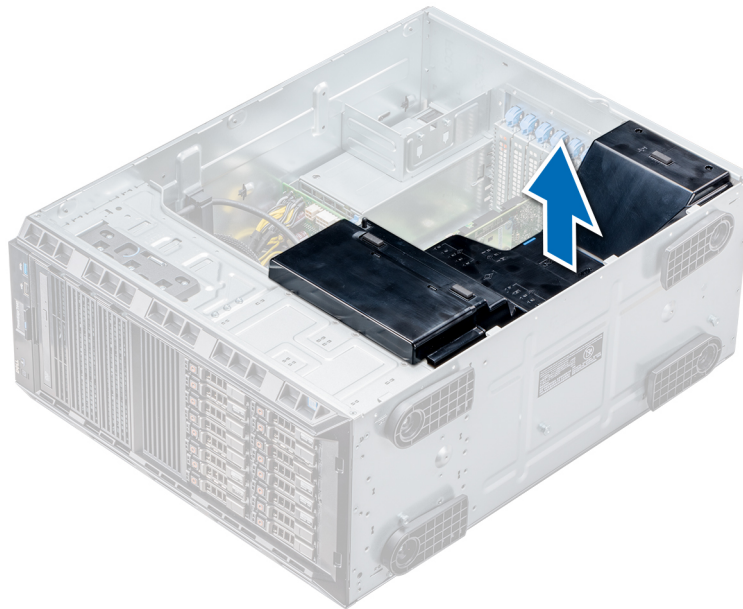

Figure 25. Removing the air shroud

Next steps

Install the air shroud.

Installing the air shroud

Prerequisites

1. Follow the safety guidelines listed in [Safety instructions](#).
2. If applicable, route the cables inside the system along the chassis wall and secure the cables by using the cable-securing bracket.

Steps

1. Align the tabs on the air shroud with the securing slots on the chassis.
2. Lower the air shroud into the chassis until it is firmly seated.

NOTE: When the cooling shroud is properly seated, the chassis intrusion-switch on the cooling shroud connects to the chassis intrusion-switch connector on the system board.

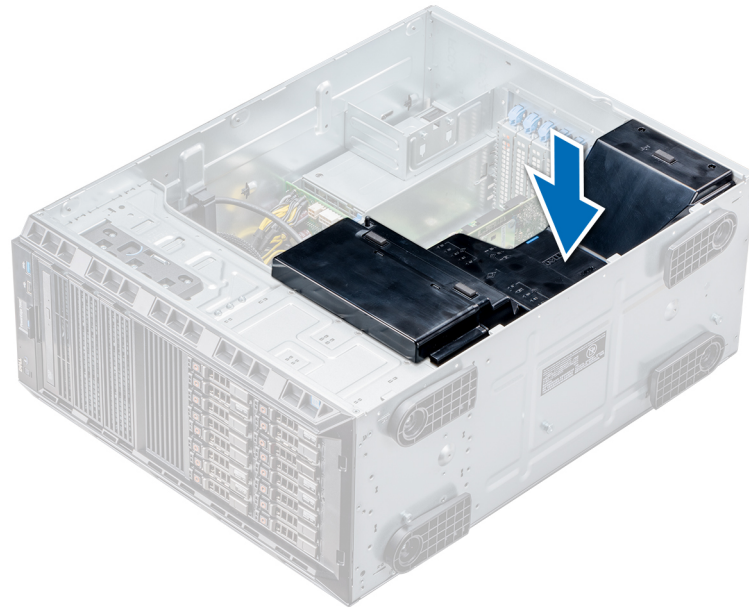

Figure 26. Installing the air shroud

Next steps

Follow the procedure listed in [After working inside your system](#).

Drives

Drives are supplied in hot swappable drive carriers that fit in the drive slots.

CAUTION: Before attempting to remove or install a drive while the system is running, see the documentation for the storage controller card to ensure that the host adapter is configured correctly.

CAUTION: Do not turn off or restart your system while a drive is being formatted. Doing so can cause a drive failure.

When you format a drive, allow enough time for the formatting to complete. Be aware that high-capacity drives can take a long time to format.

Removing a drive blank

The procedure for removing 2.5-inch and 3.5-inch drive blanks is identical.

Prerequisites

1. Follow the safety guidelines listed in [Safety instructions](#).
2. If installed, [remove the front bezel](#).

CAUTION: To maintain proper system cooling, drive blanks must be installed in all empty drive slots.

CAUTION: Mixing drive blanks from previous generations of PowerEdge servers is not supported.

Steps

Press the release button, and slide the drive blank out of the drive slot.

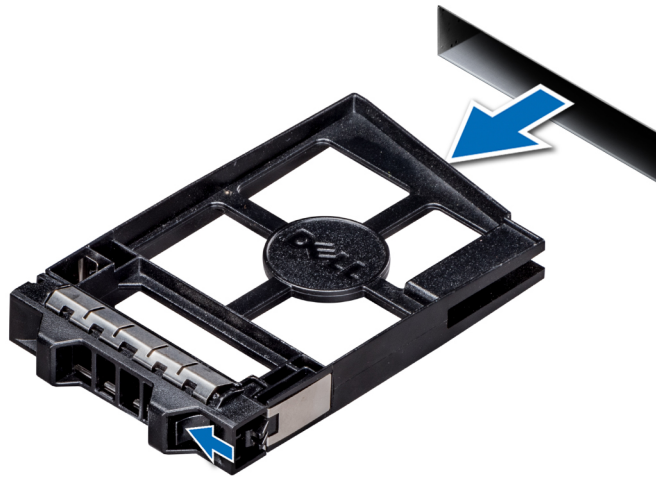

Figure 27. Removing a drive blank

Next steps

1. [Install a drive or a drive blank.](#)

Installing a drive blank

The procedure for installing 2.5-inch and 3.5-inch drive blanks is identical.

Prerequisites

1. Follow the safety guidelines listed in [Safety instructions](#).
2. If installed, [remove the front bezel](#).

CAUTION: Mixing drive blanks from previous generations of PowerEdge servers is not supported.

Steps

Insert the drive blank into the drive slot, and push the blank until the release button clicks into place.

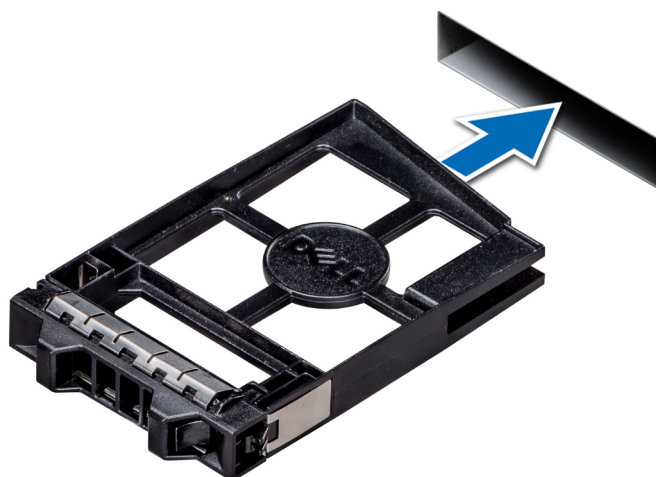

Figure 28. Installing a drive blank

Next steps

If removed, [install the bezel](#).

Removing a drive carrier

Prerequisites

1. Follow the safety guidelines listed in [Safety instructions](#).
2. If applicable, [remove the front bezel](#).
3. Using the management software, prepare the drive for removal.

If the drive is online, the green activity or fault indicator flashes while the drive is turning off. When the drive indicators are off, the drive is ready for removal. For more information, see the documentation for the storage controller.

CAUTION: Before attempting to remove or install a drive while the system is running, see the documentation for the storage controller card to ensure that the host adapter is configured correctly to support drive removal and insertion.

CAUTION: Mixing drives from previous generations of PowerEdge servers is not supported.

CAUTION: To prevent data loss, ensure that your operating system supports drive installation. See the documentation supplied with your operating system.

Steps

1. Press the release button to open the drive carrier release handle.
2. Holding the handle, slide the drive carrier out of the drive slot.

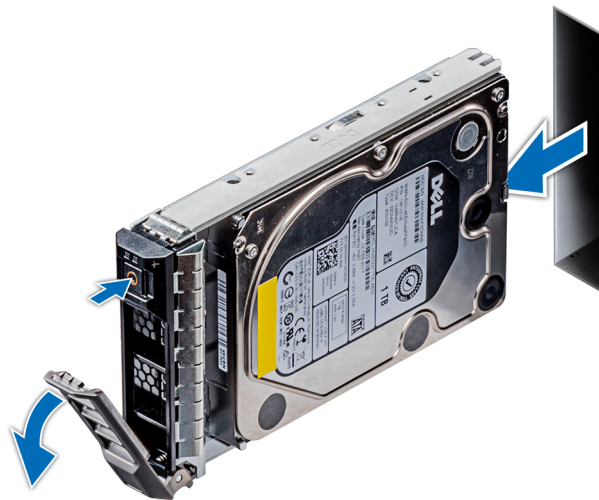

Figure 29. Removing a drive carrier

Next steps

1. Follow the procedure listed in [After working inside your system](#).
2. Install a drive carrier.
3. If you are not replacing the drive immediately, insert a drive blank in the empty drive slot to maintain proper system cooling.

Installing a drive carrier

Prerequisites

- ⚠ **CAUTION:** Before attempting to remove or install a drive while the system is running, see the documentation for the storage controller card to ensure that the host adapter is configured correctly to support drive removal and insertion.
- ⚠ **CAUTION:** Mixing drives from previous generations of PowerEdge servers is not supported.
- ⚠ **CAUTION:** Combining SAS and SATA drives in the same RAID volume is not supported.
- ⚠ **CAUTION:** When installing a drive, ensure that the adjacent drives are fully installed. Inserting a drive carrier and attempting to lock its handle next to a partially installed carrier can damage the partially installed carrier's shield spring and make it unusable.
- ⚠ **CAUTION:** To prevent data loss, ensure that your operating system supports hot-swap drive installation. See the documentation supplied with your operating system.
- ⚠ **CAUTION:** When a replacement hot swappable drive is installed and the system is powered on, the drive automatically begins to rebuild. Ensure that the replacement drive is blank or contains data that you wish to overwrite. Any data on the replacement drive is immediately lost after the drive is installed.

1. Follow the safety guidelines listed in [Safety instructions](#).
2. If applicable, [remove the drive blank](#).

Steps

1. Press the release button on the front of the drive carrier to open the release handle.
2. Insert the drive carrier into the drive slot and slide until the drive connects with the backplane.
3. Close the drive carrier release handle to lock the drive in place.

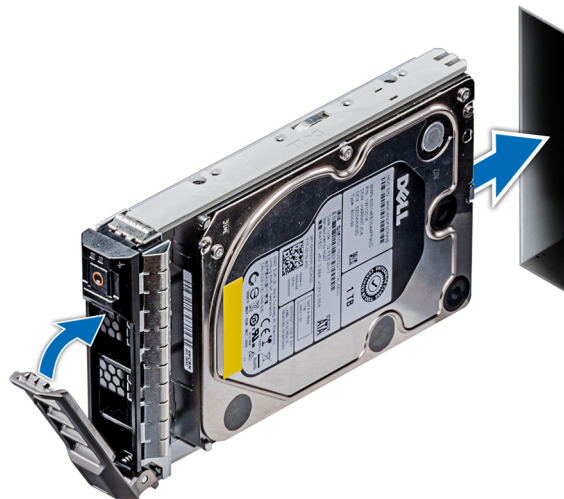

Figure 30. Installing a drive carrier

Next steps

If applicable, [install the bezel](#).

Removing the drive from the drive carrier

Prerequisites

Follow the safety guidelines listed in [Safety instructions](#).

CAUTION: Mixing drives from previous generations of PowerEdge servers is not supported.

Steps

1. Using a Phillips #1 screwdriver, remove the screws from the slide rails on the drive carrier.
 - NOTE:** If the hard drive or SSD carrier has Torx screw, use Torx 6 (for 2.5-inch drive) or Torx 8 (for 3.5-inch drive) screwdriver to remove the drive.
2. Lift the drive out of the drive carrier.

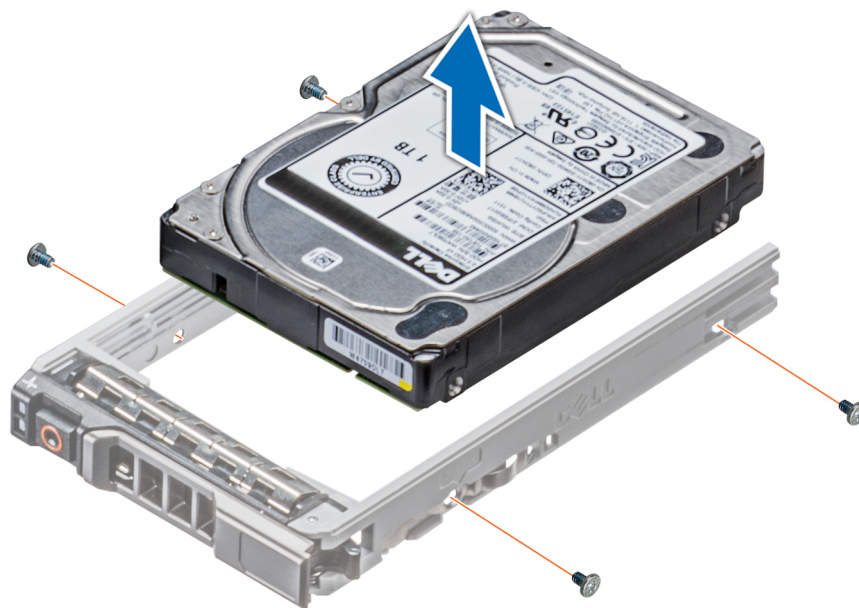

Figure 31. Removing the drive from the drive carrier

Next steps

If applicable, [Install the drives into their original slots](#).

Installing a drive into the drive carrier

Prerequisites

Follow the safety guidelines listed in [Safety instructions](#).

CAUTION: Mixing drive carriers from other generations of PowerEdge servers is not supported.

NOTE: When installing a drive into the drive carrier, ensure that the screws are torqued to 4 in-lbs.

Steps

1. Insert the drive into the drive carrier with the connector end of the drive towards the back of the carrier.

NOTE: If the hard drive or SSD carrier has Torx screw, use Torx 6 (for 2.5-inch drive) or Torx 8 (for 3.5-inch drive) screwdriver to remove the drive. 

2. Align the screw holes on the drive with the screws holes on the drive carrier.
When aligned correctly, the back of the drive is flush with the back of the drive carrier.
3. Using a Phillips #1 screwdriver, secure the drive to the drive carrier with screws.

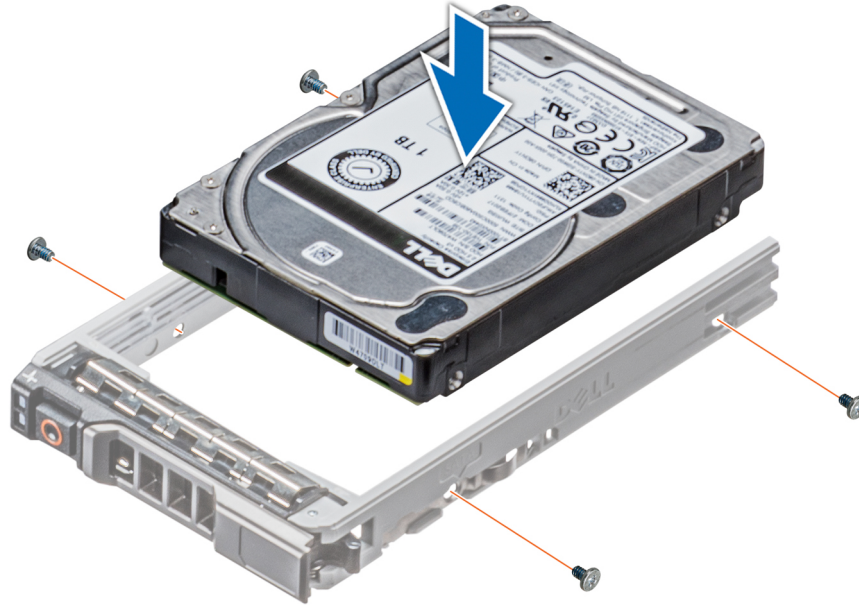

Figure 32. Installing a drive into the drive carrier

Removing a 2.5-inch drive from a 3.5-inch drive adapter

Prerequisites

1. Follow the safety guidelines listed in [Safety instructions](#).
2. Remove the 3.5-inch drive adapter from the 3.5-inch hot swappable drive carrier.

NOTE: A 2.5-inch drive is installed in a 3.5-inch drive adapter, which is then installed in the 3.5-inch drive carrier.

Steps

1. Using a Phillips #2 screwdriver, remove the screws from the side of the 3.5-inch drive adapter.

NOTE: If the hard drive or SSD carrier has Torx screw, use Torx 6 (for 2.5-inch drive) or Torx 8 (for 3.5-inch drive) screwdriver to remove the drive. 

2. Remove the 2.5-inch drive from the 3.5-inch drive adapter.

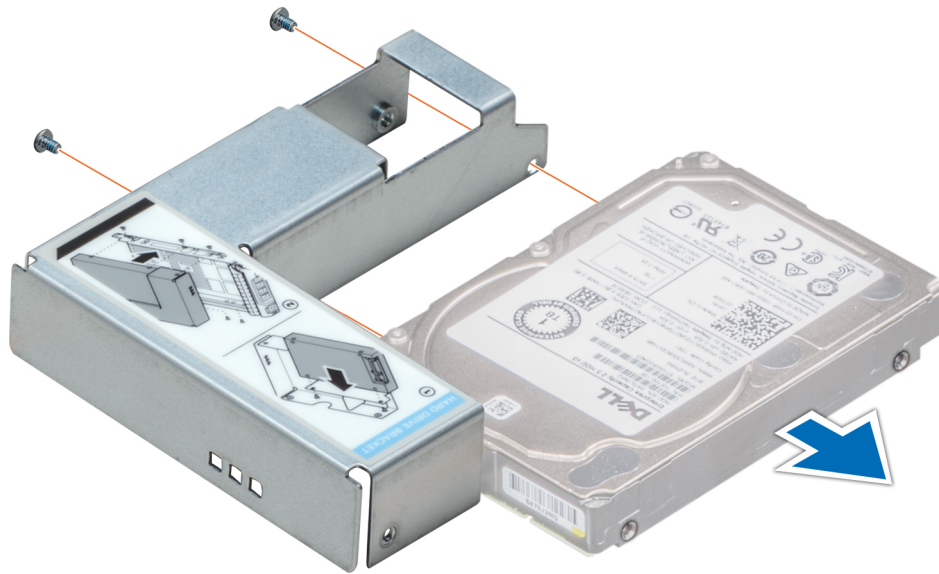

Figure 33. Removing a 2.5-inch drive from a 3.5-inch drive adapter

Next steps

Install a 2.5-inch drive into a 3.5-inch drive adapter.

Installing a 2.5-inch drive into a 3.5-inch drive adapter

Prerequisites

1. Follow the safety guidelines listed in [Safety instructions](#).
2. Remove the 3.5-inch drive adapter from the 3.5-inch hot swappable drive carrier.

Steps

1. Align the screw holes on the 2.5-inch drive with the screw holes on the 3.5-inch drive adapter.

NOTE: If the hard drive or SSD carrier has Torx screw, use Torx 6 (for 2.5-inch drive) or Torx 8 (for 3.5-inch drive) screwdriver to install the drive. 

2. Using a Phillips #2 screwdriver, secure the 2.5-inch drive to the 3.5-inch drive adapter.

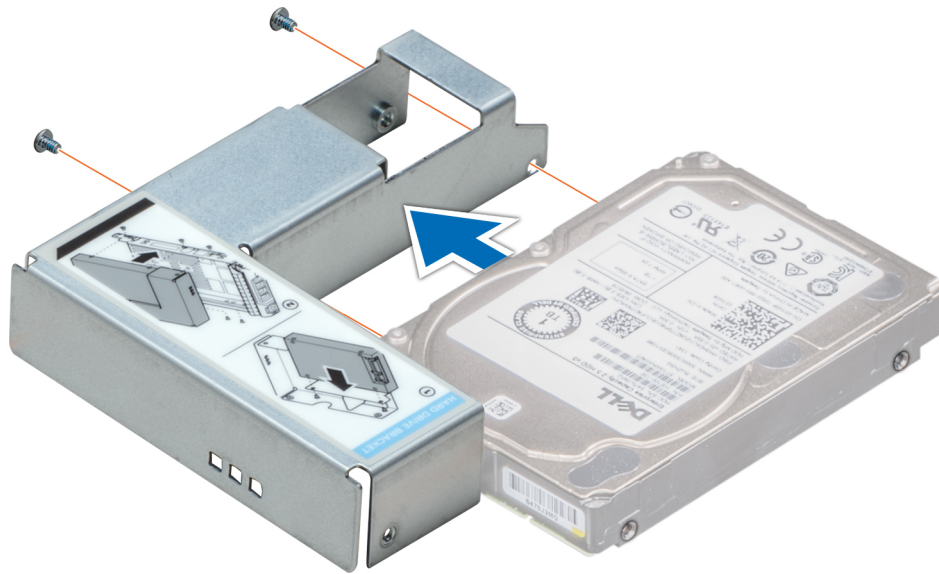

Figure 34. Installing a 2.5-inch drive into a 3.5-inch drive adapter

Removing a 3.5-inch drive adapter from a 3.5-inch drive carrier

Prerequisites

1. Follow the safety guidelines listed in [Safety instructions](#).
2. If installed, [remove the front bezel](#).
3. [Remove the 3.5-inch drive carrier from the system](#).

Steps

1. Using a Phillips #1 screwdriver, remove the screws from the rails on the drive carrier.

i **NOTE:** If the hard drive or SSD carrier has Torx screw, use Torx 6 (for 2.5-inch drive) or Torx 8 (for 3.5-inch drive) screwdriver to remove the drive. 

2. Lift the 3.5-inch drive adapter out of the 3.5-inch drive carrier.

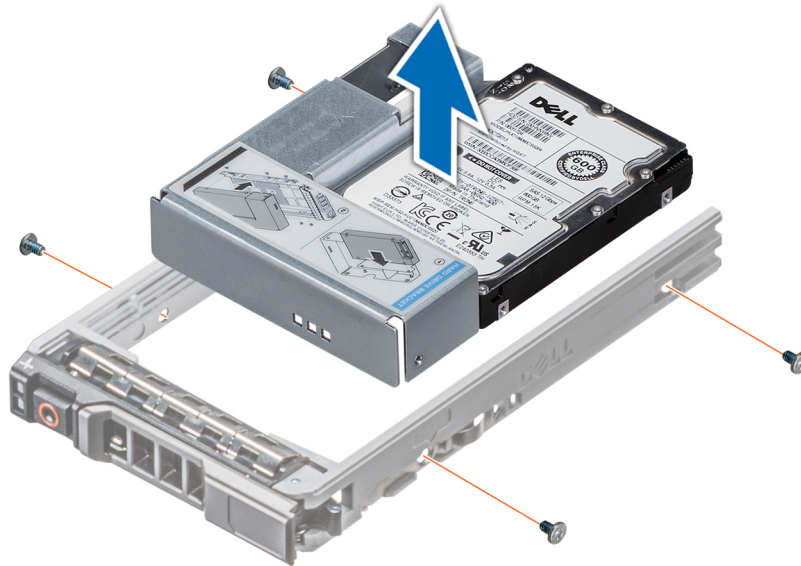

Figure 35. Removing a 3.5-inch drive adapter from a 3.5-inch drive carrier

Next steps

Install the 3.5-inch drive carrier or install the 3.5-inch drive adapter into the 3.5-inch drive carrier.

Installing a 3.5-inch drive adapter into the 3.5-inch drive carrier

Prerequisites

1. Follow the safety guidelines listed in [Safety instructions](#).
2. [Remove the 2.5-inch drive into the 3.5-inch drive adapter](#).

Steps

1. Insert the 3.5-inch drive adapter into the 3.5-inch drive carrier with the connector end of the drive toward the back of the 3.5-inch drive carrier.

i **NOTE:** If the hard drive or SSD carrier has Torx screw, use Torx 6 (for 2.5-inch drive) or Torx 8 (for 3.5-inch drive) screwdriver to install the drive. 

2. Align the screw holes on the 3.5-inch drive adapter with the holes on the 3.5-inch drive carrier.
3. Using a Phillips #1 screwdriver, secure the 3.5-inch drive adapter to the 3.5-inch carrier.

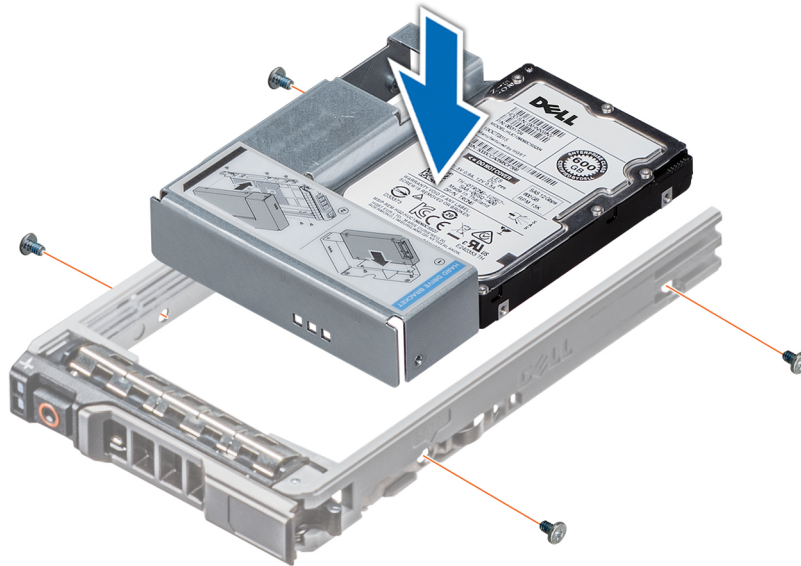

Figure 36. Installing a 3.5-inch drive adapter into the 3.5-inch drive carrier

Next steps

1. [Installing a 2.5-inch drive into a 3.5-inch drive adapter.](#)
2. If removed, [install the front bezel.](#)

Optical drives and tape drives

Removing the optical or tape drive blank

i **NOTE:** Valid TBU configurations:

- HBA330 adapter can be connected to TBU and the PERC H740P, H730P, H330, HBA330 can be connected to the drive backplane.
- HBA350i adapter can be connected to TBU and the PERC H750, H350, HBA350i can be connected to the drive backplane.

For more information, see [Backplane cable routing](#).

Prerequisites

1. Follow the safety guidelines listed in [Safety instructions](#).
2. Follow the procedure listed in [Before working inside your system](#).
3. If applicable, [remove the front bezel](#).

Steps

1. To remove the drive blank, slide the release latch down to release the drive blank.
2. Push the drive blank to slide it out of the drive bay.

i **NOTE:** Blanks must be installed on empty optical drive or tape drive slots to maintain FCC certification of the system. The brackets also keep dust and dirt out of the system and aid in proper cooling and airflow inside the system. Perform the same steps to install blanks.



Figure 37. Removing the optical drive or tape drive blank

Next steps

1. Install the optical drive cage or tape drive.
2. If applicable, install the bezel.

Installing the optical or tape drive blank

NOTE: Valid TBU configurations:

- HBA330 adapter can be connected to TBU and the PERC H740P, H730P, H330, HBA330 can be connected to the drive backplane.
- HBA350i adapter can be connected to TBU and the PERC H750, H350, HBA350i can be connected to the drive backplane.

For more information, see [Backplane cable routing](#).

Prerequisites

1. Follow the safety guidelines listed in [Safety instructions](#).
2. If applicable, [remove the front bezel](#).

Steps

1. Align the guide on the drive blank with the slot on drive bay.
2. Slide the drive into the slot until the latch snaps into place.

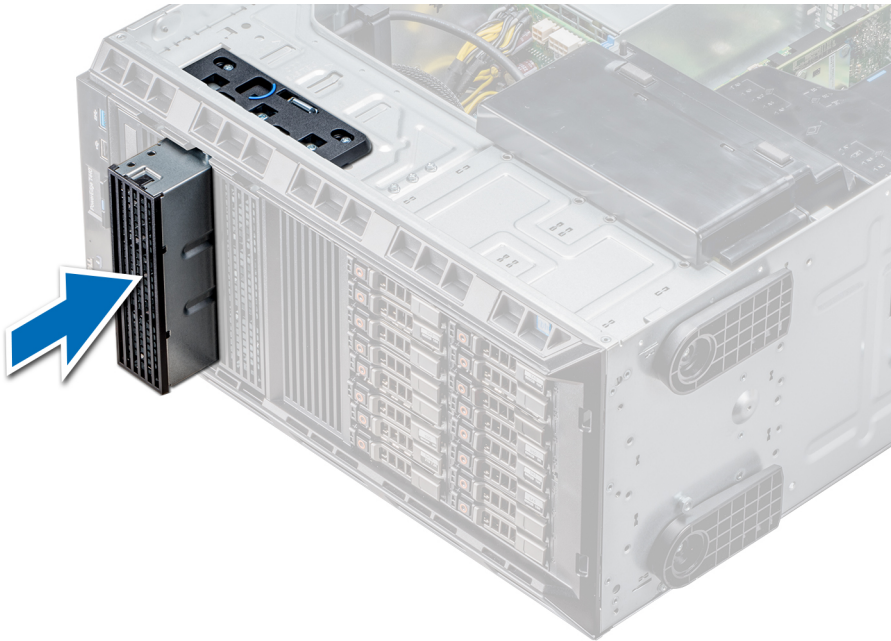

Figure 38. Installing the optical or tape drive blank

Next steps

1. Follow the procedure listed in [After working inside your system](#).
2. If applicable, [install the bezel](#).

Removing the optical drive cage or tape drive

Prerequisites

NOTE: The procedure to remove the optical drive cage is identical to removing a tape drive.

1. Follow the safety guidelines listed in [Safety instructions](#).
2. Follow the procedure listed in [Before working inside your system](#).
3. If installed, [remove the front bezel](#).

Steps

1. Disconnect the power and data cable from the back of the drive.

NOTE: Observe the routing of the power and data cable inside the chassis as you remove them from the system board and the drive. You must route these cables properly when you replace them to prevent them from being pinched or crimped.

2. To remove the drive, push the release latch to release the drive.
3. Slide the drive out of the drive bay.
4. If you are not immediately replacing the tape drive, install the blank.

NOTE: Blanks must be installed on empty optical drive or tape drive slots to maintain FCC certification of the system. The brackets also keep dust and dirt out of the system and aid in proper cooling and airflow inside the system. Perform the same steps to install blanks.



Figure 39. Removing the optical drive cage or tape drive

Next steps

Install the optical drive cage or tape drive.

Installing the optical drive cage or tape drive

Prerequisites

NOTE: The procedure to install the optical drive cage is the same as installing the tape drive.

Follow the safety guidelines listed in [Safety instructions](#).

Steps

1. Unpack and prepare the drive for installation.
For instructions, see the documentation that shipped with the drive.
If you are installing a SAS tape drive, you must have an internal tape adapter installed. For more information on installing a SAS tape drive, see the [Installing an expansion card](#) section.
2. If applicable, remove the existing drive or the drive blank.
3. Align the guide on the drive with the slot on drive bay.
4. Slide the drive into the slot until the latch clicks into place.
5. Connect the power and data cable to the drive.
6. Connect the power and data cables to the backplane and the system board.



Figure 40. Installing the optical drive cage or tape drive

Next steps

1. Follow the procedure listed in [After working inside your system](#).
2. If applicable, [install the bezel](#).

Cabled drives

CAUTION: Do not turn off or restart your system while the drive is being formatted. Doing so can cause a drive failure.

Removing the internal hard drive bay

Prerequisites

1. Follow the safety guidelines listed in [Safety instructions](#).
2. Follow the procedure listed in [Before working inside your system](#).
3. Disconnect the data and power cable(s) from the hard drive(s).

Steps

1. Loosen the two captive screws securing the internal hard drive bay to the chassis.
2. Lift the internal hard drive bay up and out of the chassis.

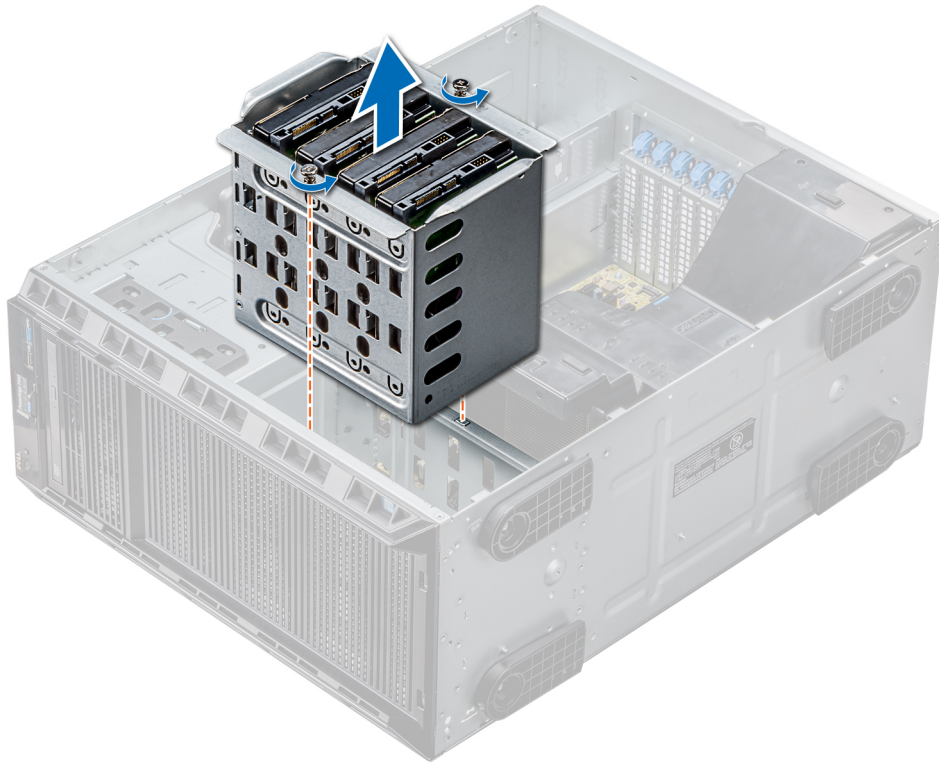

Figure 41. Removing the internal hard drive bay

Next steps

Follow the procedure listed in [After working inside your system](#).

Installing the internal hard drive bay

Prerequisites

1. Follow the safety guidelines listed in [Safety instructions](#).
2. Follow the procedure listed in [Before working inside your system](#).
3. Keep the Phillips #2 screwdriver ready.

Steps

1. Align the internal hard-drive bay with the tabs on the chassis and slide the internal hard drive bay into the chassis.
2. Secure the internal hard drive bay to the chassis using the two captive screws.

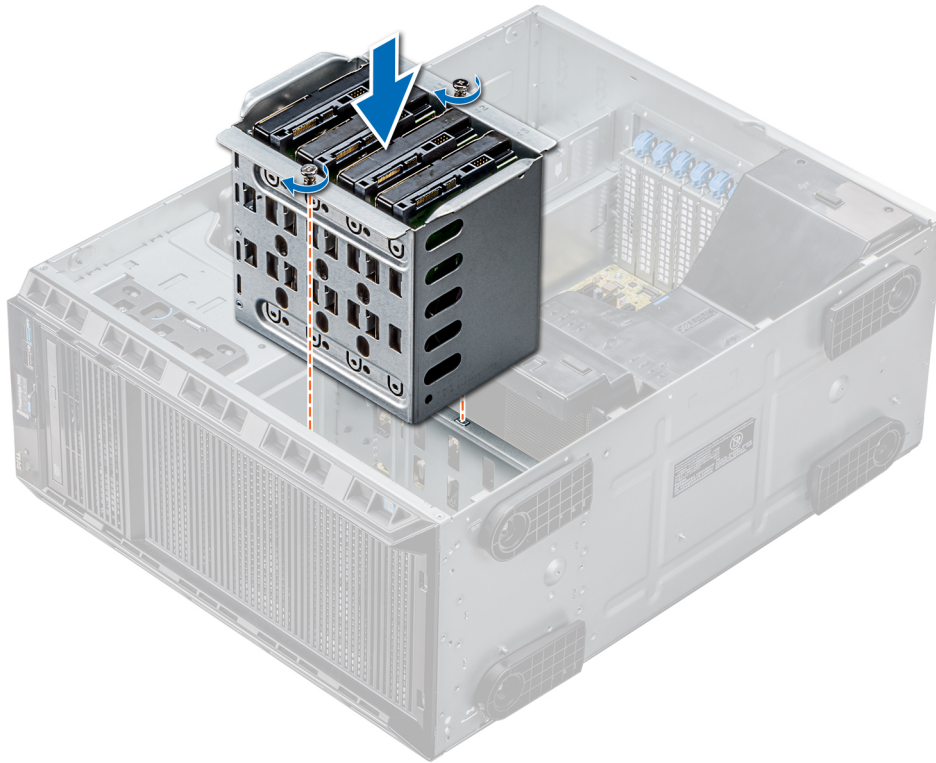

Figure 42. Installing the internal hard drive bay

Next steps

1. Follow the procedure listed in [After working inside your system](#).
2. Connect the data and power cables to the hard drive(s).

Removing a cabled drive

Prerequisites

1. Follow the safety guidelines listed in [Safety instructions](#).
2. Follow the procedure listed in [Before working inside your system](#).
3. Remove the internal drive bay.

Steps

1. Remove the four screws securing the drive to the internal drive bay.
2. Remove the hard drive from the internal drive bay.

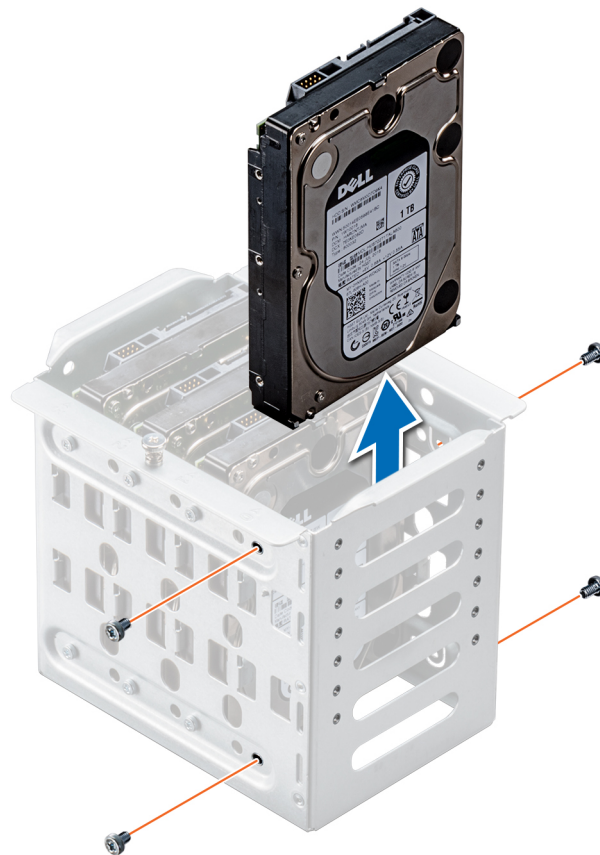

Figure 43. Removing a cabled drive

Next steps

1. Follow the procedure listed in [After working inside your system](#).
2. Install the internal drive bay into the chassis.
3. If disconnected, reconnect the power and data cable(s) to the remaining drive(s) in the internal drive bay.

Installing a cabled drive

Prerequisites

1. Follow the safety guidelines listed in [Safety instructions](#).
2. Follow the procedure listed in [Before working inside your system](#).
3. Remove the internal drive bay.

Steps

1. Insert the drive into the internal drive bay with the drive connector facing outward.
2. Secure the drive to the internal drive bay using the four screws.

NOTE: When installing new drives into the internal drive bay, use the spare drive screws attached to the drive bay.

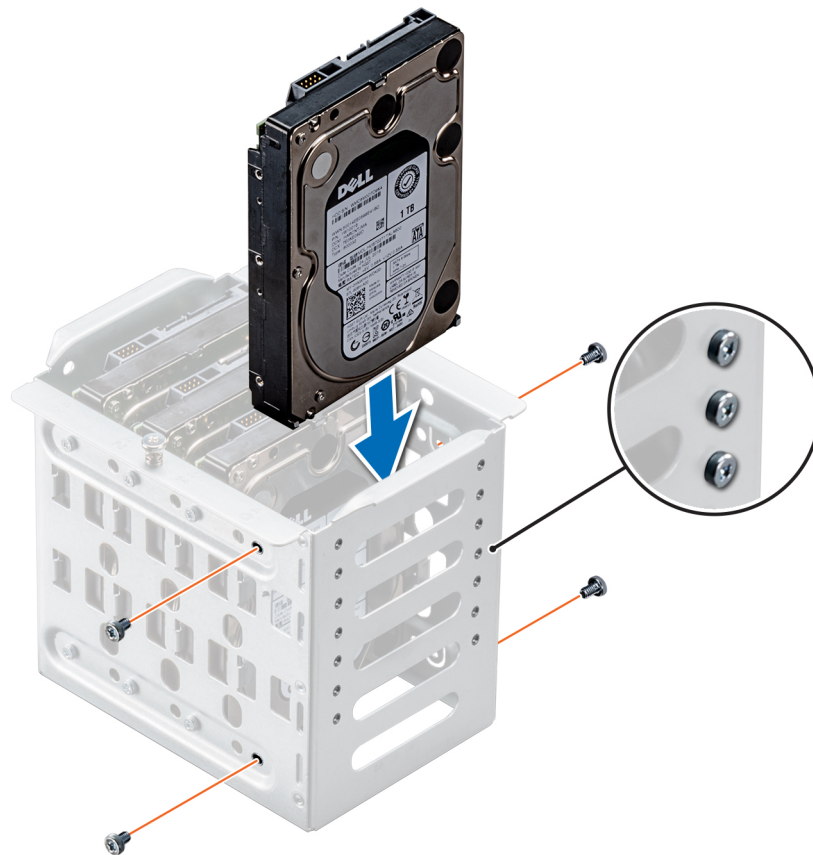

Figure 44. Installing a cabled drive

Next steps

1. Install the internal drive bay into the chassis.
2. Follow the procedure listed in [After working inside your system](#).
3. Enter **System Setup** and ensure that the drive controller is enabled.
4. Exit **System Setup** and restart the system.
5. Install any software required for operating the drive as described in the documentation for the drive.

Drive backplane

Drive backplane guidelines

Depending on the configuration, your system supports one of the following backplane configurations:

- x8 SAS/SATA backplane for 3.5 inch drives
 - ① **NOTE:** The x8 backplane also supports up to eight 2.5 inch (SAS, SATA, or SSD) hot swappable drives that can be installed in 3.5 inch drive adapters, which can be installed in the 3.5 inch drive carriers.
- x16 SAS/SATA backplane for 2.5 inch drives

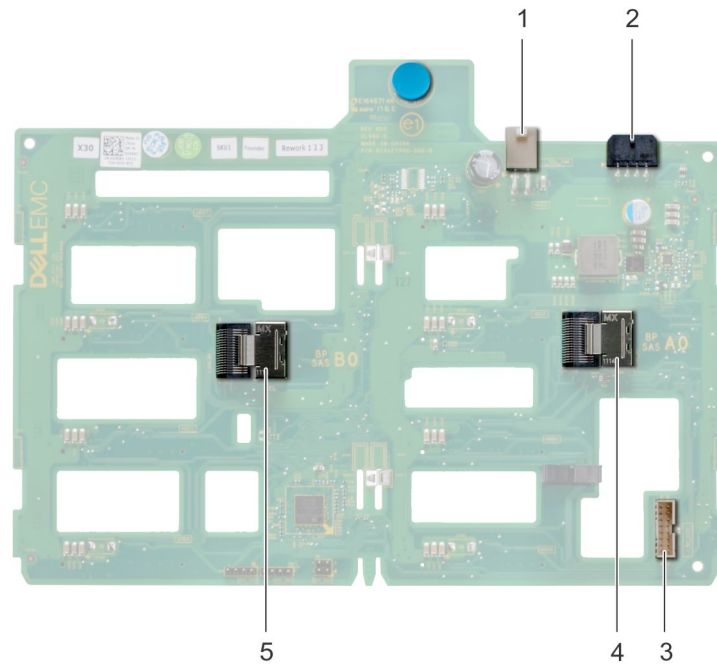

Figure 45. x8 drive backplane

- | | |
|--|---------------------------------|
| 1. ODD power connector | 2. backplane P4 power connector |
| 3. backplane sideband signal connector | 4. Mini SAS SAS_A0 |
| 5. Mini SAS SAS_B0 | |

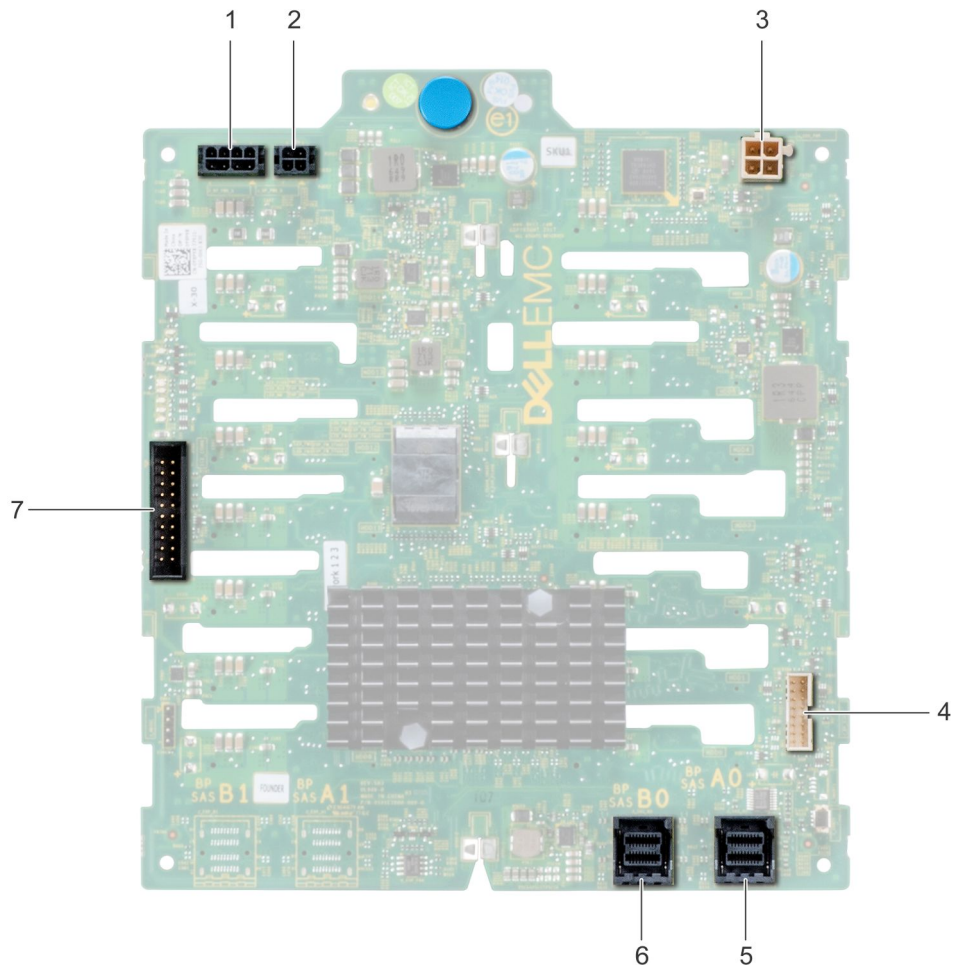

Figure 46. x16 drive backplane

- | | |
|--|------------------------------|
| 1. backplane P4 power connector | 2. backplane power connector |
| 3. backplane power connector for optical and tape drives | 4. signal connector |
| 5. Mini SAS HD SAS_A0 | 6. Mini SAS HD SAS_B0 |
| 7. I2C Connector | |

Backplane cable routing

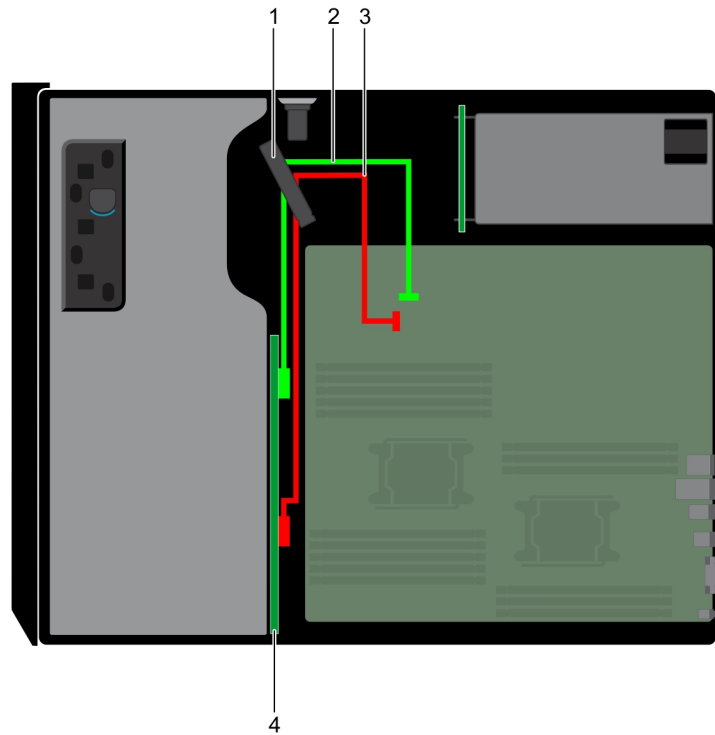

Figure 47. Cable routing - 8 x 3.5 inch drive backplane

1. Cable retention latch
2. SATA cable (BP: BP_A0 to MB: SATA_A)
3. SATA cable (BP: BP_B0 to MB: SATA_B)
4. Drive backplane

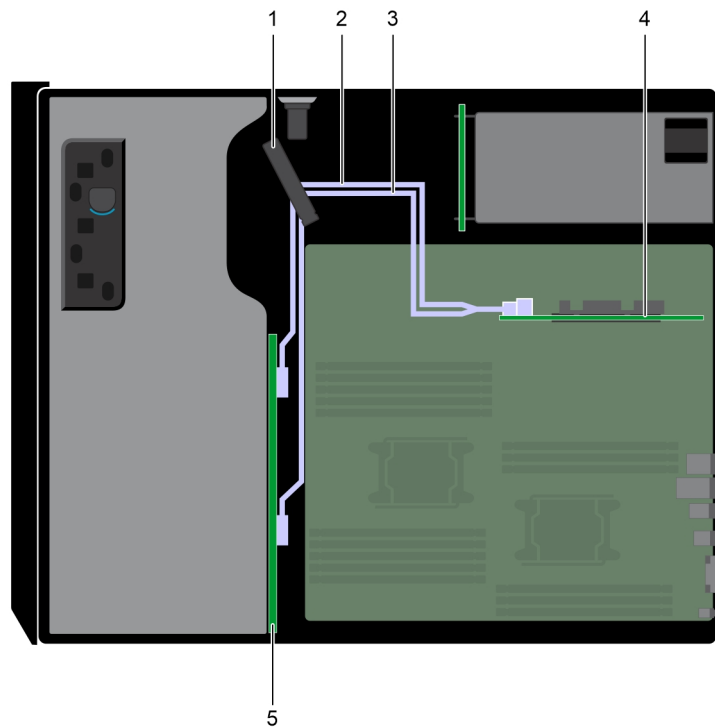

Figure 48. Cable routing - 8 x 3.5 inch drive backplane with internal PERC riser

1. Cable retention latch
2. SAS cable (BP: BP_A0 to internal PERC)

- 3. SAS cable (BP: BP_B0 to internal PERC)
- 5. Drive backplane

- 4. Internal PERC

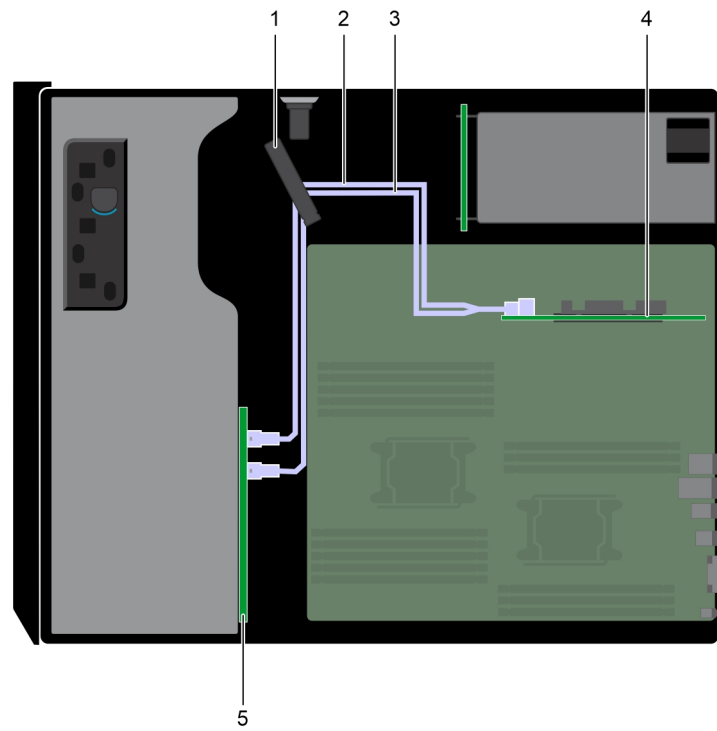

Figure 49. Cable routing -16 x 2.5 inch drive backplane with internal PERC riser

- 1. Cable retention latch
- 3. SAS cable (BP: BP_B0 to internal PERC)
- 5. Drive backplane

- 2. SAS cable (BP: BP_A0 to internal PERC)
- 4. Internal PERC

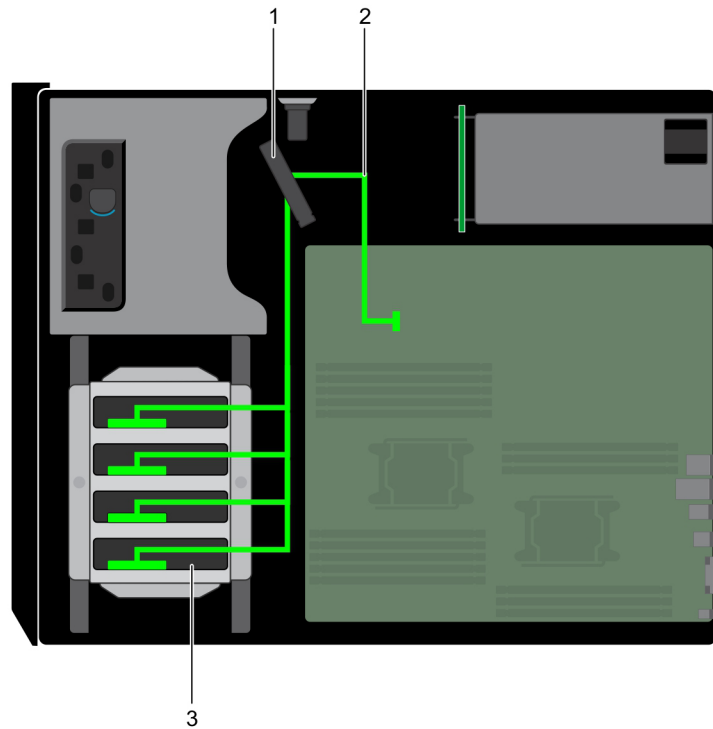

Figure 50. Cable routing - 4 x 3.5 inch cabled HDD

1. Cable retention latch
2. Signal cable
3. Cabled HDD

Removing a hard drive backplane

Prerequisites

- CAUTION:** To prevent damage to the drives and backplane, you must remove the hard drives from the system before removing the backplane.
- CAUTION:** You must note the number of each hard drive and temporarily label them before removal so that you can replace them in the same locations.

1. Follow the safety guidelines listed in [Safety instructions](#).
2. Follow the procedure listed in [Before working inside your system](#).
3. If installed, [remove the front bezel](#).
4. [Remove all the drives](#).
5. [Remove the air shroud](#).

Steps

1. Disconnect the data, signal, and power cables from the backplane.
 - NOTE:** For the x8 backplane, press the SAS connector and push the connector toward the top of the system to release the SAS cable from the backplane.
2. Pull the release pin and holding the pin, lift the backplane out of the system.



Figure 51. Removing a backplane

Next steps

Install a hard drive backplane.

Installing a hard drive backplane

Prerequisites

1. Follow the safety guidelines listed in [Safety instructions](#).
2. Follow the procedure listed in [Before working inside your system](#).
3. If installed, [remove the front bezel](#).
4. [Remove the air shroud](#).

Steps

1. Use the hooks at the base of the system as guides to align the hard drive backplane.
2. Lower the hard-drive backplane into the system till the release pin locks in place, securing the hard drive backplane to the system.
3. Connect the data, signal, and power cables to the backplane.



Figure 52. Installing a hard drive backplane

Next steps

1. Install the air shroud.
2. Install the drives into their original slots.
3. If applicable, install the bezel.
4. Follow the procedure listed in [After working inside your system](#).

System memory

System memory guidelines

The PowerEdge systems support DDR4 Registered DIMMs (RDIMMs), and Load Reduced DIMMs (LRDIMMs). System memory holds the instructions that are executed by the processor.

Your system contains 16 memory sockets. Processor 1 supports up to 10 DIMMs, and Processor 2 supports up to 6 DIMMs. Six memory channels are allocated to each processor. Processor 1 has four 2 DIMM slots per channel and two 1 DIMM slot per channel, Processor 2 has six 1 DIMM per channel.

Memory channels are organized as follows:

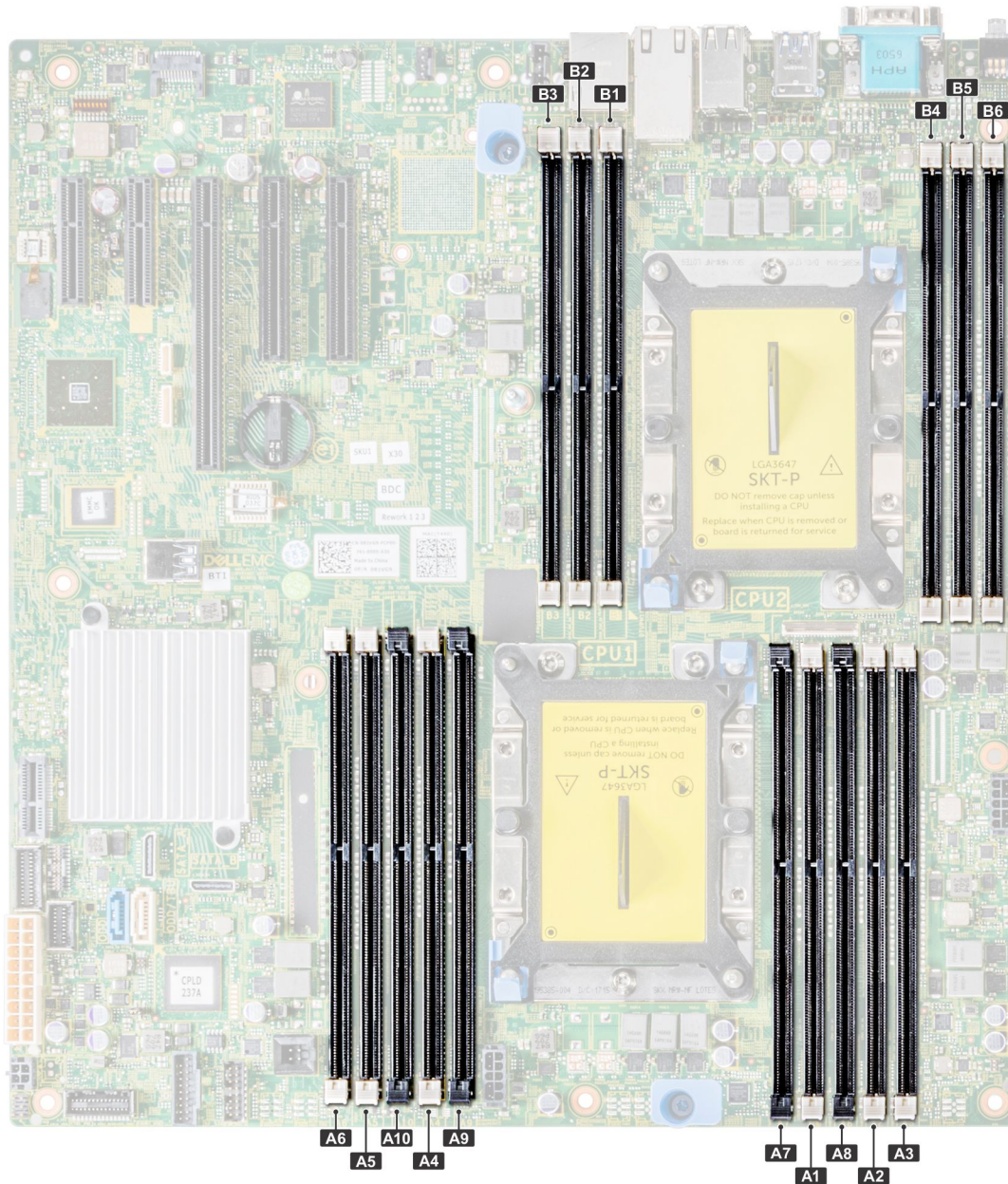

Figure 53. System memory view

Table 13. Memory channels

Processor	Channel 0	Channel 1	Channel 2	Channel 3	Channel 4	Channel 5
Processor 1	Slots A1 and A7	Slots A2 and A8	Slots A3	Slots A4 and A9	Slots A5 and A10	Slots A6
Processor 2	Slots B1	Slots B2	Slots B3	Slots B4	Slots B5	Slots B6

The following table shows the memory populations and operating frequencies for the supported configurations:

Table 14. Memory population

DIMM Type	DIMMs Populated/ Channel	Voltage	Operating Frequency (in MT/s)	Maximum DIMM Rank/ Channel
RDIMM	1	1.2 V	2666, 2400, 2133, 1866	Dual rank or single rank
	2		2666, 2400, 2133, 1866	Dual rank or single rank

Table 14. Memory population (continued)

DIMM Type	DIMMs Populated/ Channel	Voltage	Operating Frequency (in MT/s)	Maximum DIMM Rank/ Channel
LRDIMM	1	1.2 V	2666, 2400, 2133, 1866	Quad rank
	2		2666, 2400, 2133, 1866	Quad rank

General memory module installation guidelines

To ensure optimal performance of your system, observe the following general guidelines when configuring your system memory. If your system's memory configurations fail to observe these guidelines, your system might not boot, stop responding during memory configuration, or operate with reduced memory.

- System profile selected (for example, Performance Optimized, or Custom [can be run at high speed or lower])
- Maximum supported DIMM speed of the processors.
- Maximum supported DIMM speed of the processors.
- Maximum supported speed of the DIMMs

i **NOTE:** MT/s indicates DIMM speed in MegaTransfers per second.

The system supports Flexible Memory Configuration, enabling the system to be configured and run in any valid chipset architectural configuration. The following are the recommended guidelines for installing memory modules:

- All DIMMs must be DDR4.
- RDIMMs and LRDIMMs must not be mixed.
- 64 GB LRDIMMs that are DDP (Dual Die Package) LRDIMMs must not be mixed with 128 GB LRDIMMs that are TSV (Through Silicon Via/3DS) LRDIMMs.
- x4 and x8 DRAM based memory modules can be mixed.
- Up to two RDIMMs can be populated per channel regardless of rank count.
- Up to two LRDIMMs can be populated per channel regardless of rank count.
- A maximum of two different ranked DIMMs can be populated in a channel regardless of rank count.
- If memory modules with different speeds are installed, they will operate at the speed of the slowest installed memory module(s).
- Populate memory module sockets only if a processor is installed.
 - For single-processor systems, sockets A1 to A10 are available.
 - For dual-processor systems, sockets A1 to A10 and sockets B1 to B6 are available.
- Populate all the sockets with white release tabs first, followed by the black release tabs.
- When mixing memory modules with different capacities, populate the sockets with memory modules with the highest capacity first.

i **NOTE:** For example, if you want to mix 8 GB and 16 GB memory modules, populate 16 GB memory modules in the sockets with white release tabs and 8 GB memory modules in the sockets with black release tabs.

- Memory modules of different capacities can be mixed provided other memory population rules are followed.

i **NOTE:** For example, 8 GB and 16 GB memory modules can be mixed.

- In a dual-processor configuration, the memory configuration for each processor must be identical.

i **NOTE:** For example, if you populate socket A1 for processor 1, then populate socket B1 for processor 2, and so on.

- Mixing of more than two memory module capacities in one system is not supported.
- Unbalanced memory configurations will result in a performance loss so always populate memory channels identically with identical DIMMs for best performance.
- Populate six identical memory modules per processor (one DIMM per channel) at a time to maximize performance.





DIMM population update for Performance Optimized mode with quantity of 4 and 8 DIMMs per processor.

- When the DIMM quantity is 4 per processor, the population is slot 1, 2, 4, 5.
- When the DIMM quantity is 8 per processor, the population is slot 1, 2, 4, 5, 7, 8, 9, 10.

Mode-specific guidelines

The configurations allowed depend on the memory mode selected in the System BIOS.

Table 15. Memory operating modes

Memory Operating Mode	Description
Optimizer Mode	The Optimizer Mode if enabled, the DRAM controllers operate independently in the 64-bit mode and provide optimized memory performance.
Mirror Mode	The Mirror Mode if enabled, the system maintains two identical copies of data in memory, and the total available system memory is one half of the total installed physical memory. Half of the installed memory is used to mirror the active memory modules. This feature provides maximum reliability and enables the system to continue running even during a catastrophic memory failure by switching over to the mirrored copy. The installation guidelines to enable Mirror Mode require that the memory modules be identical in size, speed, and technology, and they must be populated in sets of 6 per processor.
Single Rank Spare Mode	Single Rank Spare Mode allocates one rank per channel as a spare. If excessive correctable errors occur in a rank or channel, while the operating system is running, they are moved to the spare area to prevent errors from causing an uncorrectable failure. Requires two or more ranks to be populated in each channel.
Multi Rank Spare Mode	<p>Multi Rank Spare Mode allocates two ranks per channel as a spare. If excessive correctable errors occur in a rank or channel, while the operating system is running, they are moved to the spare area to prevent errors from causing an uncorrectable failure. Requires three or more ranks to be populated in each channel.</p> <p>With single rank memory sparing enabled, the system memory available to the operating system is reduced by one rank per channel.</p> <p>For example, in a dual-processor configuration with sixteen 16 GB dual-rank memory modules, the available system memory: 16 GB x 16(memory modules) - 8GB(1 rank sparing/channel) x 12(channel) = 256 GB - 96 GB = 160 GB. For multi rank sparing, in a dual-processor configuration with sixteen 64 GB quad-rank memory modules, the available system memory: 64 GB x 16(memory modules) - 32 GB(2 rank sparing/channel) x 12 (channel) = 1024 GB - 384 GB = 640 GB.</p> <p> NOTE: To use memory sparing, this feature must be enabled in the BIOS menu of System Setup.</p> <p> NOTE: Memory sparing does not offer protection against a multi-bit uncorrectable error.</p>
Dell Fault Resilient Mode	<p>The Dell Fault Resilient Mode if enabled, the BIOS creates an area of memory that is fault resilient. This mode can be used by an OS that supports the feature to load critical applications or enables the OS kernel to maximize system availability.</p> <p> NOTE: This feature is only supported in Gold and Platinum Intel processors.</p> <p> NOTE: Memory configuration has to be of same size DIMM, speed, and rank.</p>

Optimizer Mode

This mode supports Single Device Data Correction (SDDC) only for memory modules that use x4 device width. It does not impose any specific slot population requirements.

- Dual processor: Populate the slots in round robin sequence starting with processor 1.
 -  **NOTE:** Processor 1 and processor 2 population should match.

Table 16. Memory population rules

Processor	Configuration	Memory population	Memory population information
Single processor	Optimizer (Independent channel) population order	1, 2, 3, 4, 5, 6, 7, 8, 9, 10	<ul style="list-style-type: none"> Populate in this order, odd amount allowed. Odd number of DIMM population is allowed. <ul style="list-style-type: none"> i NOTE: Odd number of DIMMs will result in unbalanced memory configurations, which in turn will result in performance loss. It is recommended to populate all memory channels identically with identical DIMMs for best performance. Optimizer population order is not traditional for 4 and 8 DIMM installations of single processor. <ul style="list-style-type: none"> For 4 DIMMs: A1, A2, A4, A5 For 8 DIMMs: A1, A2, A4, A5, A7, A8, A9, A10
	Mirror population order	{1, 2, 3, 4, 5, 6}	Mirroring is supported with 6 DIMM slots per processor.
	Single rank sparing population order	1, 2, 3, 4, 5, 6, 7, 8, 9, 10	Populate in this order, odd amount allowed. Requires two ranks or more per channel.
	Multi rank sparing population order	1, 2, 3, 4, 5, 6, 7, 8, 9, 10	Populate in this order, odd amount allowed. Requires three ranks or more per channel.
Dual processor (Populate round robin starting with processor1)	Optimized (Independent channel) population order	A{1}, B{1}, A{2}, B{2}, A{3}, B{3}...	<ul style="list-style-type: none"> Odd amount of DIMM slots per processor allowed. Odd number of DIMM population is allowed. <ul style="list-style-type: none"> i NOTE: Odd number of DIMMs will result in unbalanced memory configurations, which in turn will result in performance loss. It is recommended to populate all memory channels identically with identical DIMMs for best performance. Optimizer population order is not traditional for 8 and 14 DIMM installations of dual processor. <ul style="list-style-type: none"> For 8 DIMMs: A1, A2, A4, A5, B1, B2, B4, B5 For 14 DIMMs: A1, A2, A4, A5, A7, A8, A9, A10, B1, B2, B3, B4, B5, B6

Table 16. Memory population rules (continued)

Processor	Configuration	Memory population	Memory population information
	Mirroring population order	A{1, 2, 3, 4, 5, 6}, B{1, 2, 3, 4, 5, 6}	Mirroring is supported with 6 DIMM slots per processor.
	Single rank sparing population order	A{1}, B{1}, A{2}, B{2}, A{3}, B{3}...	Populate in this order, odd amount per processor allowed. Requires two ranks or more per channel.
	Multi rank sparing population order	A{1}, B{1}, A{2}, B{2}, A{3}, B{3}...	Populate in this order, odd amount per processor allowed. Requires three ranks or more per channel.

Removing a memory module

Prerequisites

1. Follow the safety guidelines listed in [Safety instructions](#).
 - a. Follow the procedure listed in [Before working inside your system](#).
2. [Remove the air shroud](#).

⚠️ WARNING: Allow the memory modules to cool after you power off the system. Handle the memory modules by the card edges and avoid touching the components or metallic contacts on the memory module.

⚠️ CAUTION: To ensure proper system cooling, memory module blanks must be installed in any memory socket that is not occupied. Remove memory module blanks only if you intend to install memory modules in those sockets.

Steps

1. Locate the appropriate memory module socket.

⚠️ CAUTION: Handle each memory module only by the card edges, ensuring not to touch the middle of the memory module or metallic contacts.

2. Push the ejectors outward on both ends of the memory module socket to release the memory module from the socket.
3. Lift and uninstall the memory module from the system.

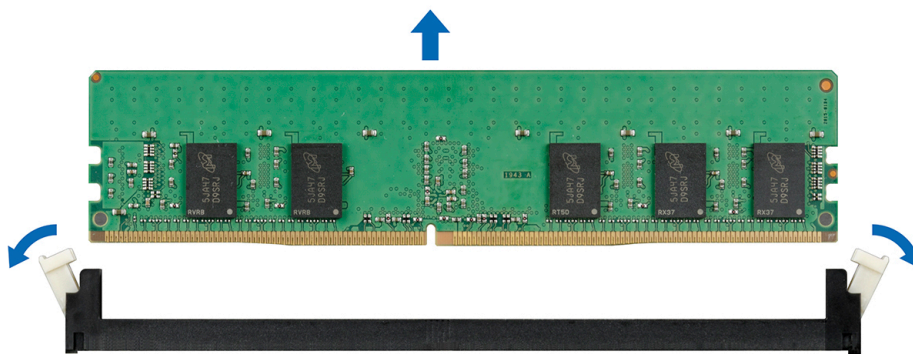

Figure 54. Removing a memory module

Next steps

1. [Install the memory module](#).

Installing a memory module

Prerequisites

Follow the safety guidelines listed in [Safety instructions](#).

CAUTION: To ensure proper system cooling, memory module blanks must be installed in any memory socket that is not occupied. Remove memory module blanks only if you intend to install memory modules in those sockets.

Steps

1. Locate the appropriate memory module socket.

CAUTION: Handle each memory module only by the card edges, ensuring not to touch the middle of the memory module or metallic contacts.

CAUTION: To prevent damage to the memory module or the memory module socket during installation, do not bend or flex the memory module. You must insert both ends of the memory module simultaneously.

2. Open the ejectors on the memory module socket outward to allow the memory module to be inserted into the socket.

3. Align the edge connector of the memory module with the alignment key of the memory module socket, and insert the memory module in the socket.

CAUTION: Do not apply pressure at the center of the memory module; apply pressure at both ends of the memory module evenly.

NOTE: The memory module socket has an alignment key that enables you to install the memory module in the socket in only one orientation.

4. Press the memory module with your thumbs until the socket levers firmly click into place.

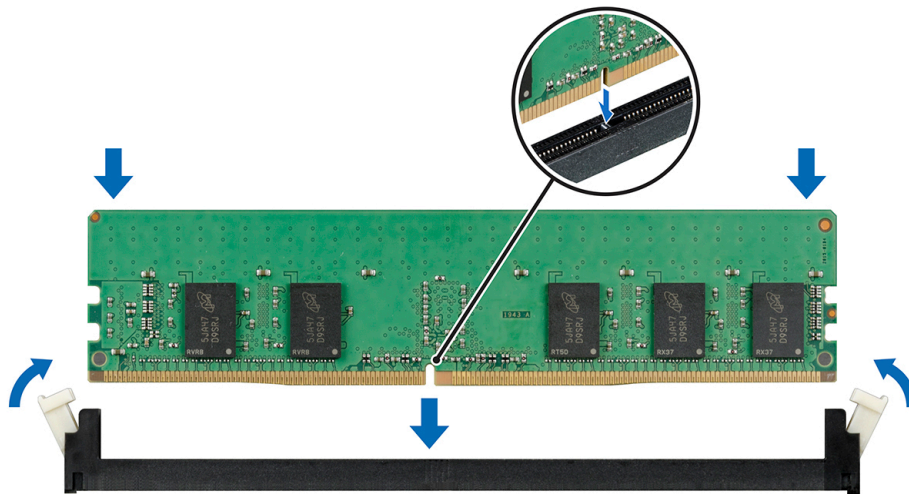

Figure 55. Installing a memory module

Next steps

1. [Install the air shroud](#)
2. Follow the procedure listed in [After working inside your system](#).
3. To verify if the memory module has been installed properly, press F2 and navigate to **System Setup Main Menu > System BIOS > Memory Settings**. In the **Memory Settings** screen, the System Memory Size must reflect the updated capacity of the installed memory.
4. If the value is incorrect, one or more of the memory modules may not be installed properly. Ensure that the memory module is firmly seated in the memory module socket.
5. Run the system memory test in system diagnostics.

Cooling fans

Removing the internal cooling fan

Prerequisites

CAUTION: Never operate your system with the internal cooling fan removed. The system can overheat and result in shutdown of the system and loss of data.

CAUTION: Do not operate the system with the cover removed for a duration exceeding 5 minutes.

1. Follow the safety guidelines listed in [Safety instructions](#).
2. Follow the procedure listed in [Before working inside your system](#).
3. [Remove the air shroud](#).

Steps

1. Disconnect the internal cooling fan power cable from the system board.
2. Holding the internal cooling fan, press the release tab, and slide the cooling fan out in the direction of the arrow marked on the fan.

CAUTION: Do not remove or install the internal cooling fan by holding the fan blades.



Figure 56. Removing the internal cooling fan

Next steps

1. Follow the procedure listed in [After working inside your system](#).
2. [Install the internal cooling fan](#).

Installing the internal cooling fan

Prerequisites

1. Follow the safety guidelines listed in [Safety instructions](#).
2. Follow the procedure listed in [Before working inside your system](#).
3. [Remove the air shroud](#).
4. If installed, [remove the front bezel](#).

Steps

1. Hold the cooling fan by the sides with the cable end facing the bottom of the system.
2. Align the four tabs on the internal cooling fan with the four slots on the system wall.
3. Press and slide the internal cooling fan into the slots until the release tab locks into place.

4. Connect the internal cooling fan power cable to the connector on the system board.

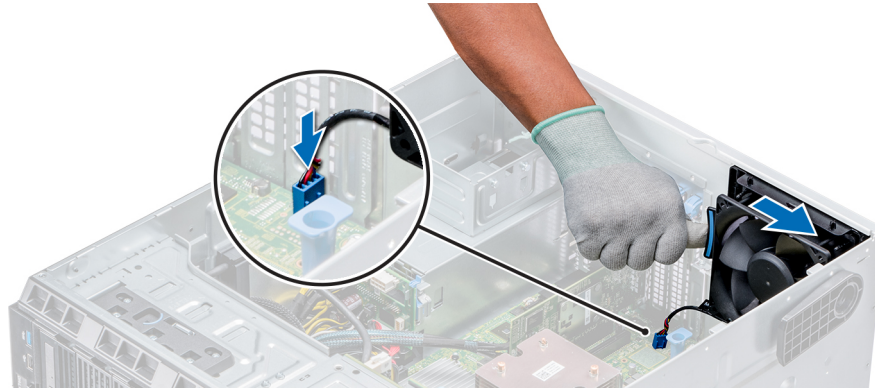

Figure 57. Installing the internal cooling fan

Next steps

1. [Install the air shroud.](#)
2. Follow the procedure listed in [After working inside your system.](#)

Removing the external cooling fan

Prerequisites

1. Follow the safety guidelines listed in [Safety instructions.](#)
2. Follow the procedure listed in [Before working inside your system.](#)
3. [Remove the air shroud.](#)

Steps

1. Disconnect the external cooling fan power cable from the system board.
2. Remove the four screws that secure the external cooling fan to the chassis.
3. Lift the external cooling fan to disengage the upper and the lower hooks from the slots on the chassis wall and remove the cooling fan.
4. Remove the external cooling fan power cable from the slot on the system.

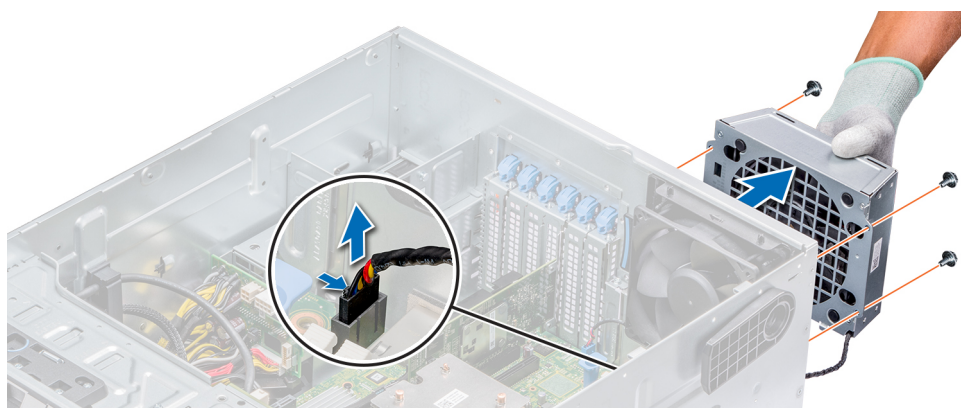

Figure 58. Removing the external cooling fan

Next steps

1. Follow the procedure listed in [After working inside your system.](#)
2. [Install the air shroud.](#)

Installing the external cooling fan

Prerequisites

1. Follow the safety guidelines listed in [Safety instructions](#).
2. Follow the procedure listed in [Before working inside your system](#).

Steps

1. Route the external cooling fan power cable into the system through the slot at the back of the chassis.
2. Align and insert the lower and upper hooks on the external cooling fan into the corresponding slots at the back of the chassis.
3. Use the four screws to secure the external cooling fan to the chassis.
4. Connect the external cooling fan power cable to the FAN2 connector on the system board.

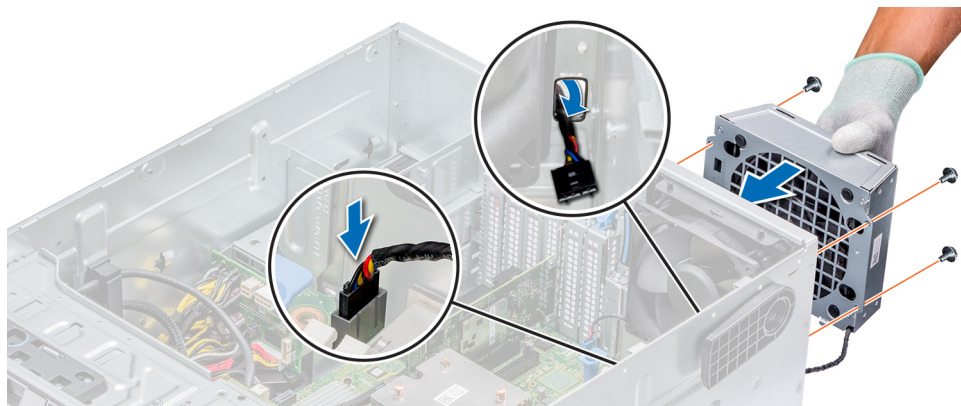

Figure 59. Installing the external cooling fan

Next steps

1. [Install the air shroud](#).
2. Follow the safety guidelines listed in [After working inside your system](#).

Optional internal USB memory key

Replacing the optional internal USB memory key

Prerequisites

CAUTION: To avoid interference with other components in the server, the maximum permissible dimensions of the USB memory key are 15.9 mm wide x 57.15 mm long x 7.9 mm high.

1. Follow the safety guidelines listed in [Safety instructions](#).
2. Follow the procedure listed in [Before working inside your system](#).

Steps

1. Locate the USB port or USB memory key on the system board.
To locate the USB port, see [Jumpers and connectors](#).
2. If installed, remove the USB memory key from the USB port.
3. Insert the replacement USB memory key into the USB port.

Next steps

1. Follow the procedure listed in [After working inside your system](#).
2. While booting, press F2 to enter **System Setup** and verify that the system detects the USB memory key.

Expansion card holder

Removing the expansion card holder

Prerequisites

1. Follow the safety guidelines listed in [Safety instructions](#).
2. Follow the procedure listed in [Before working inside your system](#).
3. [Remove the air shroud](#).

Steps

Press the tab and remove the expansion-card holder from the chassis.

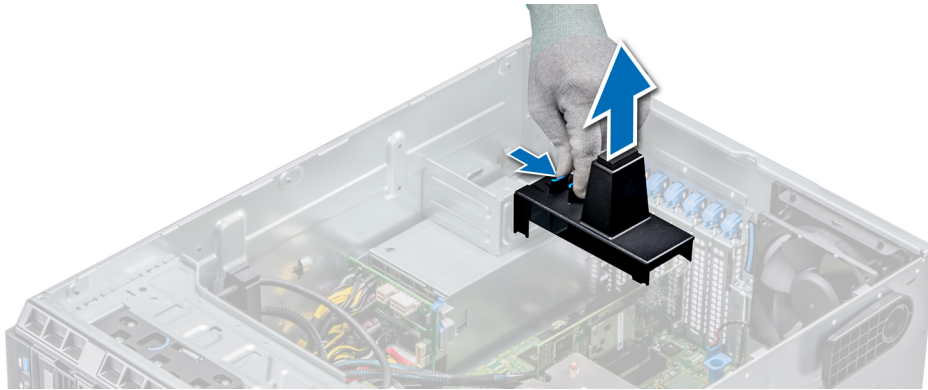

Figure 60. Removing the expansion card holder

Next steps

1. [Install the air shroud](#).
2. Follow the procedure listed in [After working inside your system](#).

Installing the expansion card holder

Prerequisites

1. Follow the safety guidelines listed in [Safety instructions](#).
2. Follow the procedure listed in [Before working inside your system](#).

Steps

Align the expansion card holder with the projections on the chassis and push it down until firmly seated.

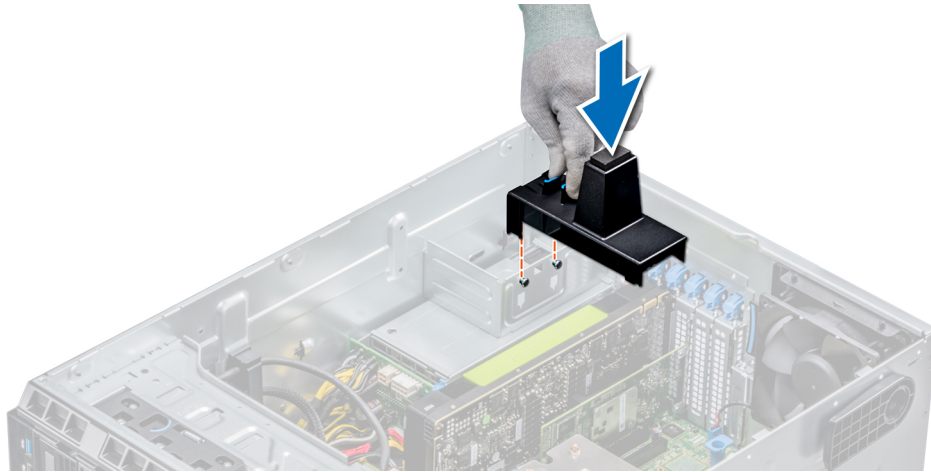

Figure 61. Installing the expansion card holder

Next steps

1. Follow the procedure listed in [After working inside your system](#).
2. [Install the air shroud](#).

Expansion cards

Expansion card installation guidelines

The following table describes the supported expansion cards:

Table 17. Supported PCI express generation 3 expansion cards

PCIe Slot	Processor Connection	Height	Length	Link Width	Slot Width
1 (Gen3)	Platform Controller Hub	Full Height	Half Length	x4	x4
2 (Gen3)	Processor 1	Full Height	Half Length	x4	x4
3 (Gen3)	Processor 2	Full Height	Full Length	x16	x16
4 (Gen3)	Processor 1	Full Height	Half Length	x8	x8
5 (Gen3)	Processor 1	Full Height	Half Length	x8	x8

NOTE: The expansion-card slots are not hot-swappable.

The following table describes the installation order for installing expansion cards to ensure proper cooling and mechanical fit. The expansion cards with the highest priority must be installed first by using the slot priority indicated.

Table 18. Expansion card configuration: 1 processor

Card Type	Slot Priority	Maximum Allowed
Card, Network(Broadcom/Intel)	1, 2, 4, 5	4
NIC (Intel)	1, 2, 4, 5	4
PERC9/ 9.14G (FXN)	4, 5, 3, 2	3
RAID - PERC9+ (Internal) (Dell)	4, 5, 2	3
RAID - PERC10 (Internal) (Dell)	4, 5, 2	3
RAID - PERC10 (External) (Dell)	4, 5, 2	3

Table 18. Expansion card configuration: 1 processor (continued)

Card Type	Slot Priority	Maximum Allowed
RAID - PERC11 (Dell)	4, 5, 2	3
Non-RAID - PERC11 (Dell)	4, 5, 2	3
NIC(Broadcom)	4, 5, 2	3
Card, Network ((Broadcom/Intel/Emulex, Qlogic)	4, 5, 2	3
BOSS M.2 (SATA) (Dell)	4, 5, 2	3

Table 19. Expansion card configuration - 2 processors

Card Type	Slot Priority	Maximum Allowed
GPGPU (NVIDIA, AMD)	3	1
Card, Network (Broadcom, Intel)	1, 2, 4, 5, 3	5
NIC(Intel)	1, 2, 4, 5, 3	5
PERC9/ 9.14G (FXN)	4, 5, 3, 2	4
RAID - PERC9+ (Internal) (Dell)	4, 5, 3, 2	4
RAID - PERC10 (Internal) (Dell)	4, 5, 3, 2	4
RAID - PERC10 (External)(Dell)	4, 5, 3, 2	4
RAID - PERC11 (Dell)	4, 5, 3, 2	3
Non-RAID - PERC11 (Dell)	4, 5, 3, 2	3
NIC(Broadcom)	4, 5, 3, 2	4
Card, Network ((Broadcom/Intel)	4, 5, 3, 2	4
Card, Controller (Emulex, Qlogic)	4, 5, 3, 2	4
BOSS M.2 (SATA) (Dell)	4, 5, 3, 2	4

NOTE: The new generation PERC 11 H750, H350, and HBA350i adapters cannot be mixed with the PERC H740P, H730P, H330, HBA330 adapters of the previous generations in one system. For more information, see [Backplane cable routing](#).

GPU card installation guidelines

Observe the following guidelines while installing a GPU card:

- GPU is supported in the rack and tower mode configuration.
- GPU can be installed only on systems that have 1100 W (recommended) or higher power supply units.
- Each GPU card supports up to 32 GB of dedicated GDDR5 memory.
- Supports one GPU on x16 slot (slot 3) with two processors on it
- Specific GPU cards need the use of the dongle power cable.

GPU card installation restrictions

- Supports only single slot GPU card
- Supports only active (embedded fan) GPU card
- High power (>75 W) GPU cards that use GPU AUX cable should have dual system fans without redundancy.

Removing a expansion card

Prerequisites

1. Follow the safety guidelines listed in [Safety instructions](#).
2. Follow the procedure listed in [Before working inside your system](#).
3. [Remove the air shroud](#).
4. [Remove the expansion card holder](#).

Steps

1. If installed, disconnect the data cables from the PERC card and/or the power cables from the GPU card.
2. Press the expansion card latch and push down the latch to open it.
3. Hold the expansion card by its edge, and pull the card up to remove it from the expansion card connector and the system.
4. Install the filler brackets by performing the following steps:
 - a. Align the slot on the filler bracket with the tab on the expansion card slot.
 - b. Press the expansion card latch till the filler bracket locks into place.

NOTE: Filler brackets must be installed in empty expansion-card slots to maintain FCC certification of the system. The brackets also keep dust and dirt out of the system and aid in proper cooling and airflow inside the system.

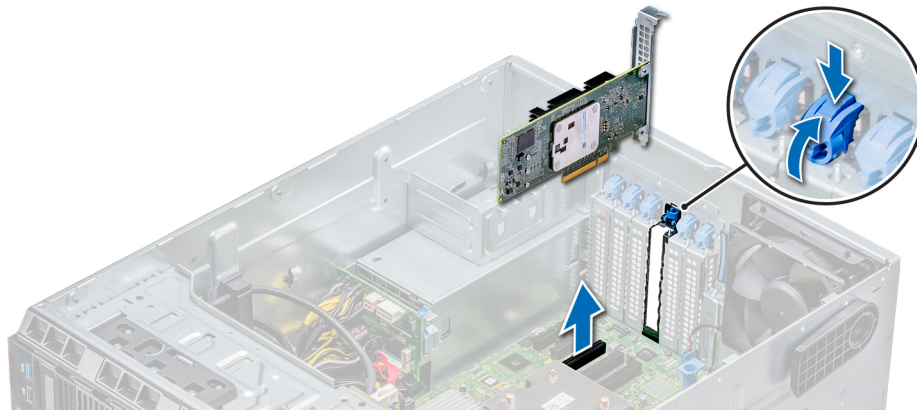

Figure 62. Removing an expansion card

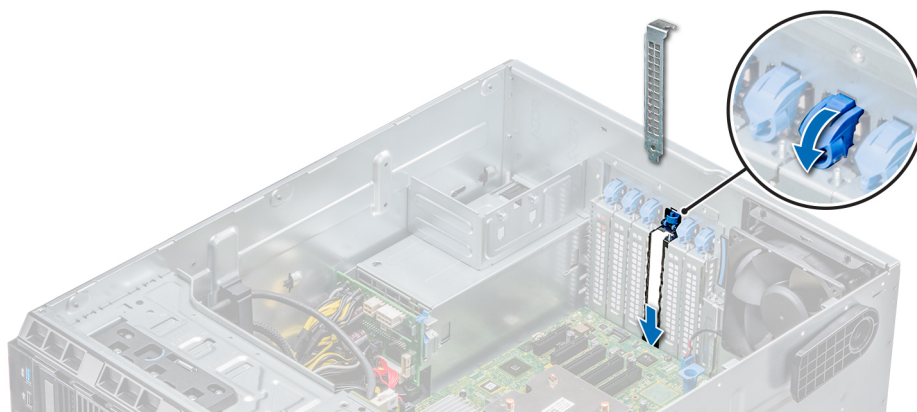

Figure 63. Installing the filler bracket

Next steps

1. Follow the procedure listed in [After working inside your system](#).
2. [Install an expansion card](#).

3. Install the expansion card holder.
4. Install the air shroud.

Installing an expansion card

Prerequisites

1. Follow the safety guidelines listed in [Safety instructions](#).
2. [Remove the air shroud](#).
3. [Remove the expansion card holder](#).

Steps

1. Unpack the expansion card and prepare it for installation.
For instructions, see the documentation accompanying the card.
2. Open the expansion card latch adjacent to the slot you want to install the expansion card.
3. Remove the existing expansion card or filler bracket from the expansion card holder.
 - i** **NOTE:** Store this bracket for future use. Filler brackets must be installed in empty expansion-card slots to maintain FCC certification of the system. The brackets also keep dust and dirt out of the system and aid in proper cooling and airflow inside the system.
4. Holding the card by its edges, position the card so that the card aligns with the expansion card connector.
5. Insert the card firmly into the expansion card connector until the card is fully seated.
6. Close the expansion card latch by pushing the latch up until the latch snaps into place.
7. Connect the data cables to the expansion card and/or the power cables to the GPU card.

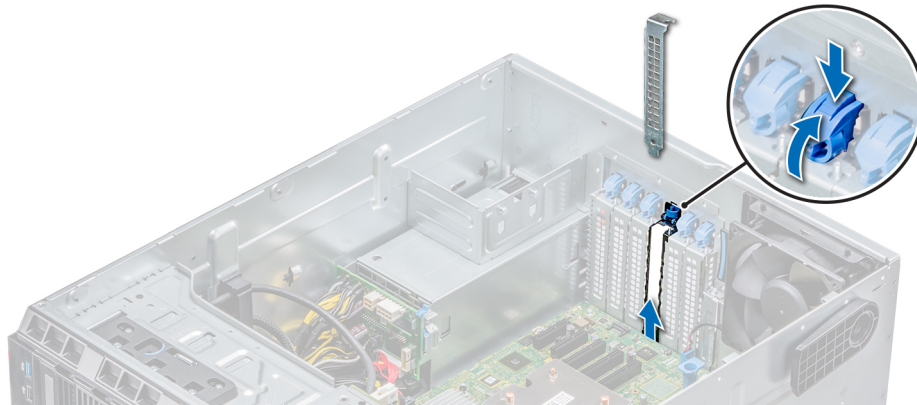

Figure 64. Removing the filler bracket

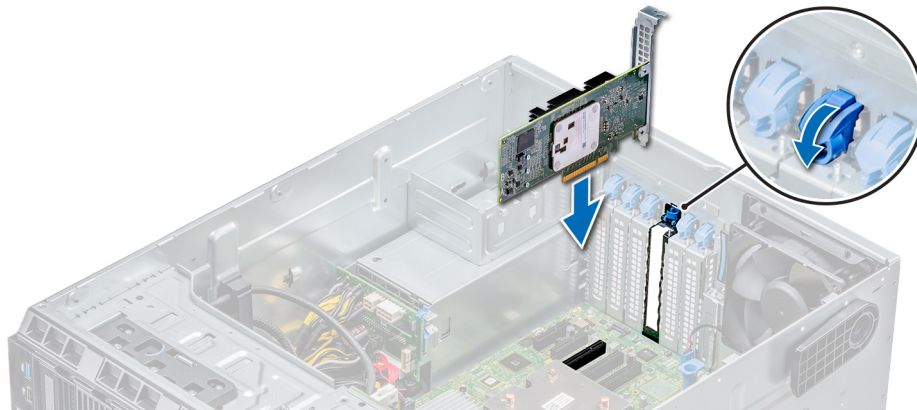

Figure 65. Installing an expansion card

Next steps

1. Follow the procedure listed in [After working inside your system](#).
2. [Install the expansion card holder](#).
3. [Install the air shroud](#).

M.2 SSD module

Removing the M.2 SSD module

Prerequisites

1. Follow the safety guidelines listed in [Safety instructions](#).
2. Follow the procedure listed in [Before working inside your system](#).
3. [Remove the air shroud](#).
4. Remove the BOSS card.

NOTE: The procedure to remove the BOSS card is similar to the removing an expansion card.

Steps

1. Loosen the screw and lift the retention strap that secures the M.2 SSD module on the BOSS card.
2. Lift the M.2 SSD module and slide it out of the connector on the BOSS card.

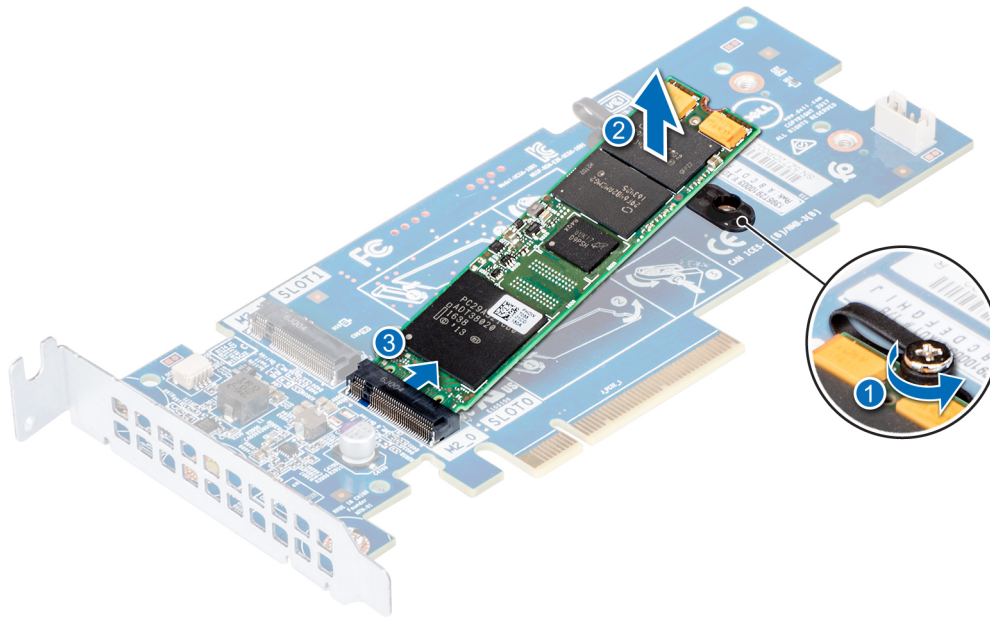

Figure 66. Removing the M.2 SSD module

Next steps

Replace the M.2 SSD module.

Installing the M.2 SSD module

Prerequisites

1. Follow the safety guidelines listed in [Safety instructions](#).
2. Follow the procedure listed in [Before working inside your system](#).
3. [Remove the air shroud](#).
4. Remove the BOSS card.

NOTE: The procedure to remove the BOSS card is similar to the removing an expansion card.

Steps

1. Connect the M.2 SSD module to the connector on the BOSS card.
2. Place the retention strap on the M.2 SSD module, and tighten the screw to secure the module.

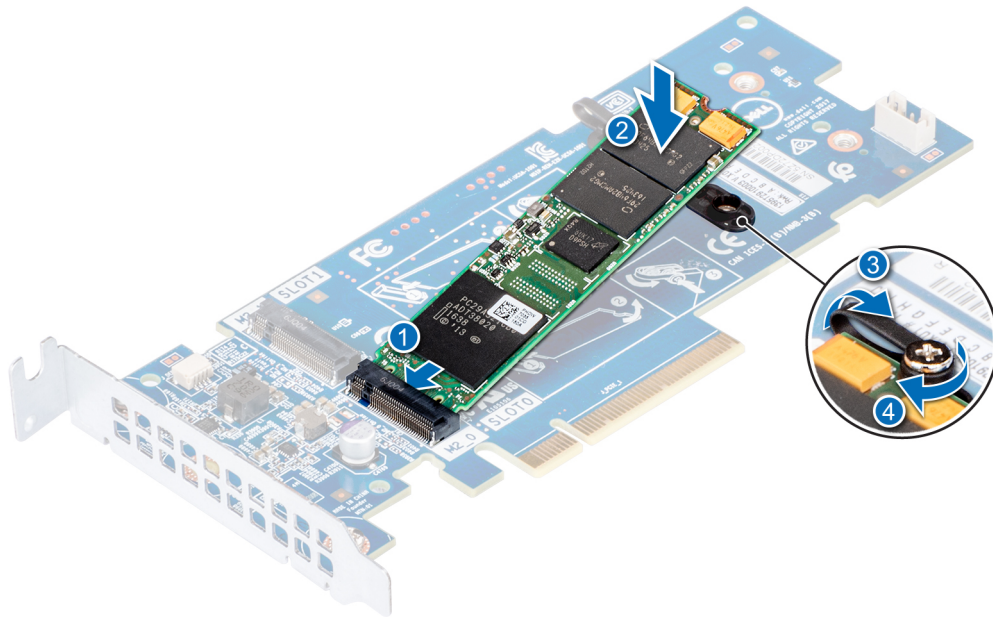

Figure 67. Installing the M.2 SSD module

Next steps

1. Install the BOSS card.
NOTE: The procedure to install the BOSS card is similar to the removing an expansion card.
2. Install the applicable air shroud.
3. Follow the procedure listed in [After working inside your system](#).

Optional MicroSD or vFlash card

Removing the MicroSD card

Prerequisites

1. Follow the safety guidelines listed in [Safety instructions](#).
2. Follow the procedure listed in [Before working inside your system](#).

Steps

1. Locate the MicroSD card slot on the vFlash/IDSDM module, and press the card to partially release it from the slot. To locate IDSDM/vFlash module, see the System board jumpers and connectors section.
2. Hold the MicroSD card and remove it from the slot.

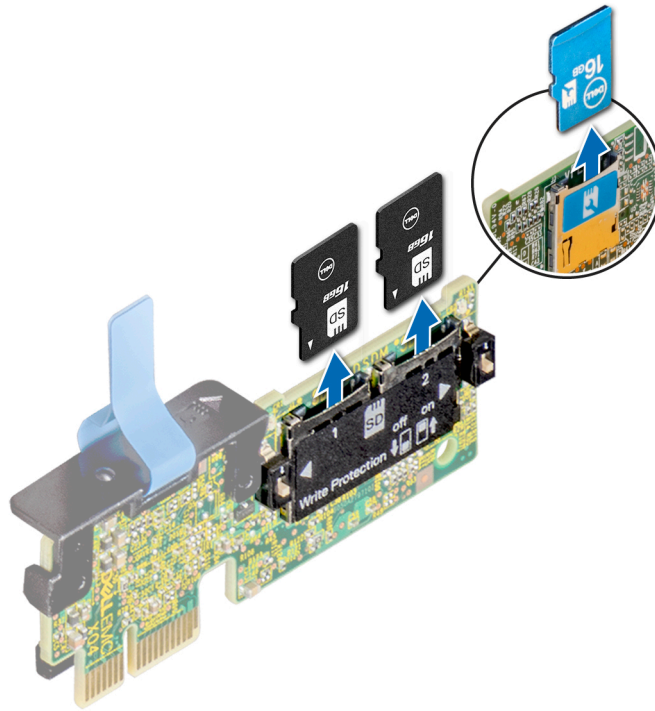

Figure 68. Removing the MicroSD card

NOTE: Temporarily label each MicroSD card with its corresponding slot number after removal.

Next steps

1. Follow the procedure listed in [After working inside your system](#).
2. [Install a MicroSD card](#).

Installing the MicroSD card

Prerequisites

Follow the safety guidelines listed in [Safety instructions](#).

- NOTE:** To use an MicroSD card with your system, ensure that the **Internal SD Card Port** is enabled in System Setup.
- NOTE:** If reinstalling, ensure that you install the MicroSD cards into the same slots based on the labels you had marked on the cards during removal.

Steps

1. Locate the MicroSD card connector on the IDSDM/vFlash module. Orient the MicroSD card appropriately and insert the contact-pin end of the card into the slot. To locate IDSDM/vFlash, see [Jumpers and connectors](#).
NOTE: The slot is keyed to ensure correct insertion of the card.
2. Press the card into the card slot to lock it into place.

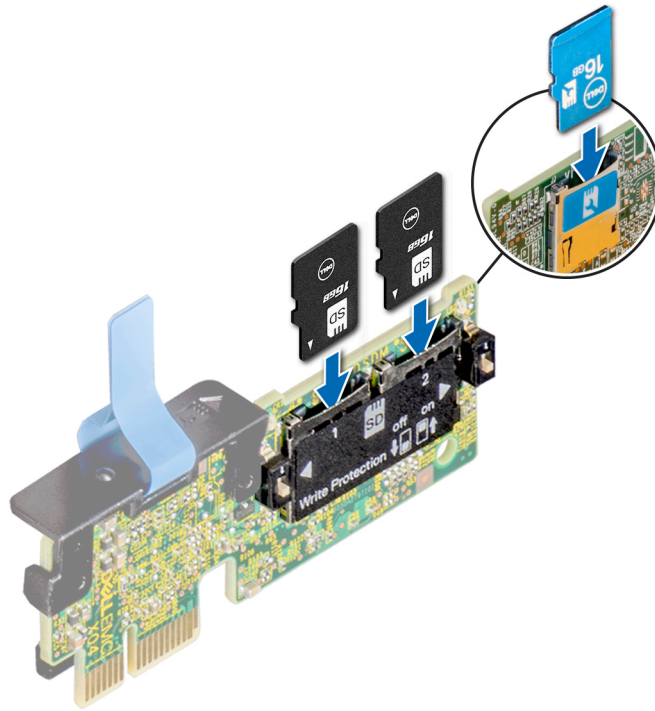

Figure 69. Installing the MicroSD card

Next steps

Follow the procedure listed in [After working inside your system](#).

Optional IDSDM or vFlash module

Removing the optional IDSDM or vFlash card

Prerequisites

1. Follow the safety guidelines listed in [Safety instructions](#).
2. Follow the procedure listed in [Before working inside your system](#).
3. [Install the air shroud](#).

Steps

1. Locate the IDSDM/vFlash connector on the system board.
To locate IDSDM/vFlash connector, see the [System board jumpers and connectors](#) section.
2. Holding the pull tab, lift the IDSDM/vFlash card out of the system.

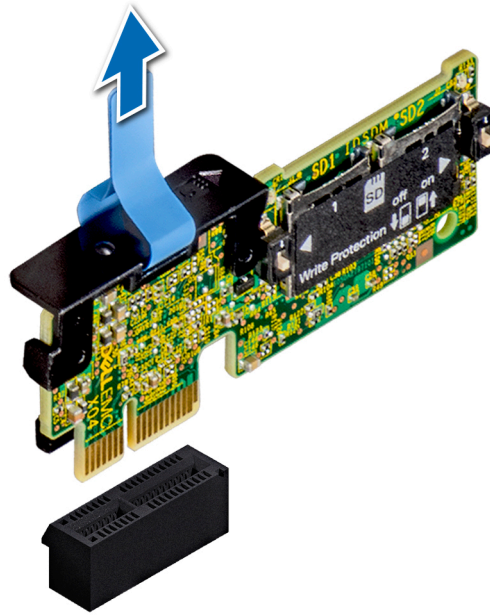

Figure 70. Removing the optional IDSDM/vFlash card

NOTE: There are two dip switches on the IDSDM/vFlash card for write-protection.

Next steps

Install the optional IDSDM/vFlash card.

Installing optional IDSDM or vFlash card

Prerequisites

Follow the safety guidelines listed in [Safety instructions](#).

Steps

1. Locate the IDSDM/vFlash connector on the system board.
To locate IDSDM/vFlash connector, see [Jumpers and connectors](#).
2. Align the IDSDM/vFlash card with the connector on the system board.
3. Push the IDSDM/vFlash card until it is firmly seated on the system board.

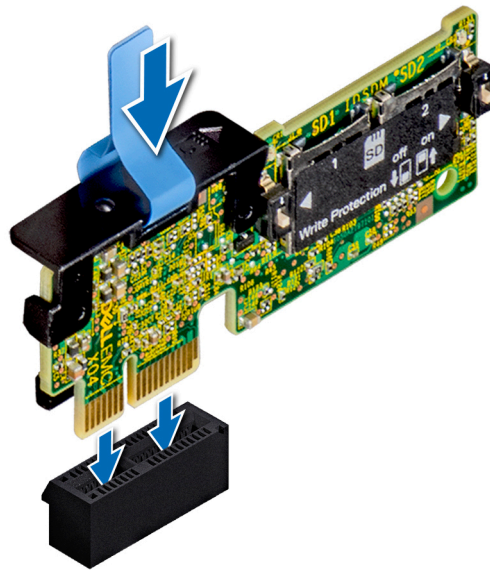

Figure 71. Installing optional IDSDM/vFlash card

Next steps

1. Install the MicroSD cards.
NOTE: Reinstall the MicroSD cards into the same slots based on the labels you had marked on the cards during removal.
2. Follow the procedure listed in [After working inside your system](#).

Processors and heat sinks

Removing a processor and heat sink module

Prerequisites

WARNING: The heat sink may be hot to touch for some time after the system is powered down. Allow the heat sink to cool before removing it.

1. Follow the safety guidelines listed in [Safety instructions](#).
2. Follow the procedure listed in [Before working inside your system](#).
3. [Remove the air shroud](#).

Steps

1. Using a Torx #T30 screwdriver, loosen the screws on the heat sink in the order below:
 - a. Loosen the first screw three turns.
 - b. Loosen the second screw completely.
 - c. Return to the first screw and loosen it completely.
2. Pushing both blue retention clips simultaneously, lift the processor and heat sink module (PHM) processor and heat sink module
3. Set the PHM aside with the processor side facing up.

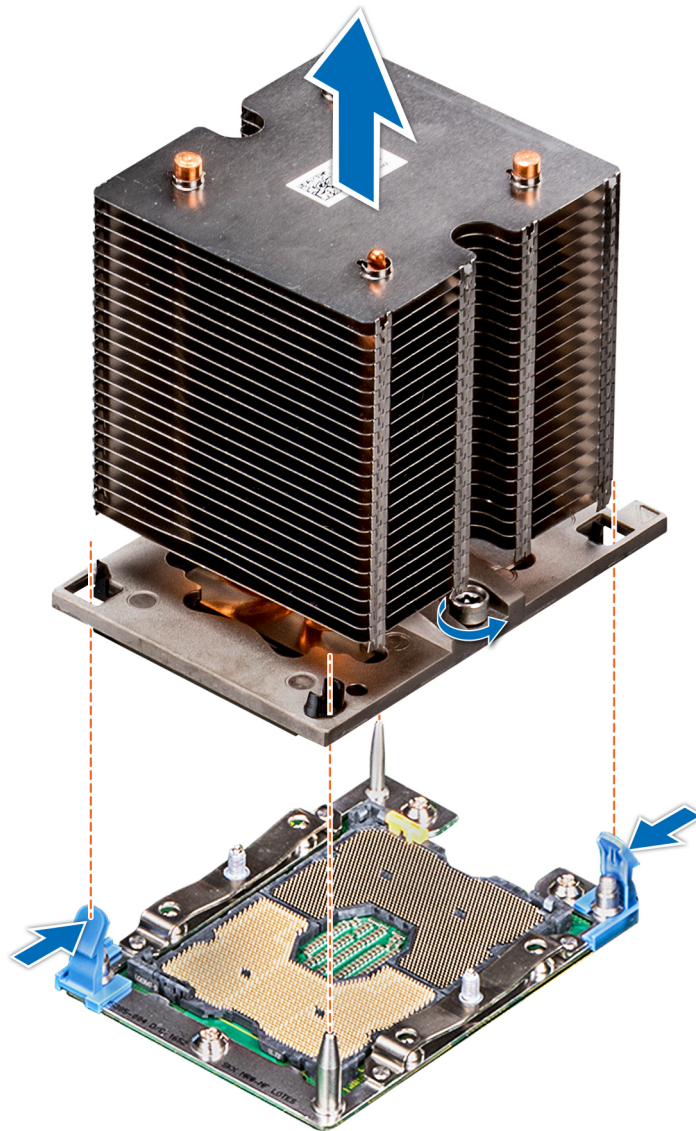

Figure 72. Removing the processor and heat sink module

Next steps

Install the processor and heat sink module.

Removing the processor from the processor and heat sink module

Prerequisites

NOTE: Only remove the processor from the processor and heat sink module if you are replacing the processor or heat sink. This procedure is not required when replacing a system board.

1. Follow the safety guidelines listed in [Safety instructions](#).
2. Follow the procedure listed in [Before working inside your system](#).
3. [Remove the air shroud](#).
4. [Remove the processor and heat sink module](#).

Steps

1. Place the heat sink with the processor side facing up.

2. Insert a flat blade screwdriver into the release slot marked with a yellow label. Twist (do not pry) the screwdriver to break the thermal paste seal.
3. Push the retaining clips on the processor bracket to unlock the bracket from the heat sink.

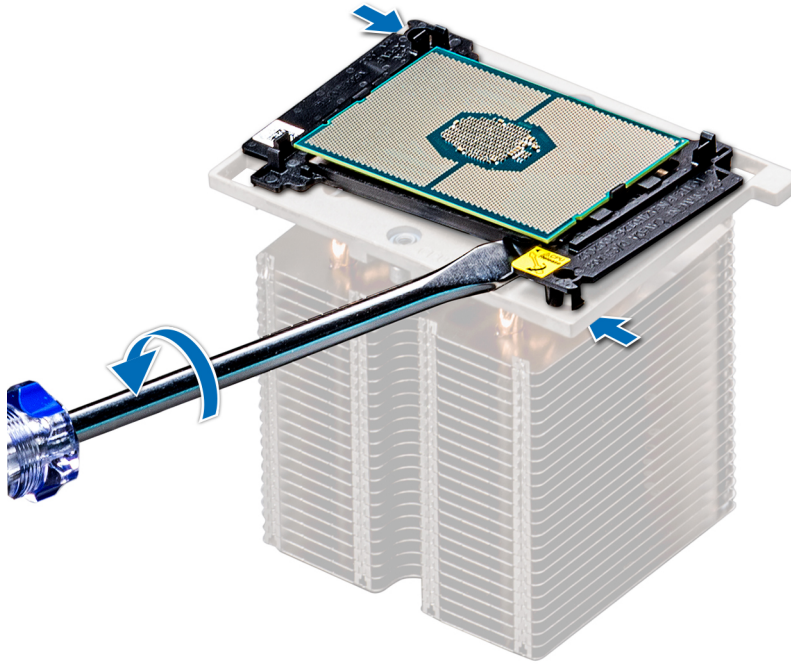

Figure 73. Loosening the processor bracket

4. Lift the bracket and the processor away from the heat sink, and place the processor connector side down on the processor tray.
5. Flex the outer edges of the bracket to release the bracket from the processor.

i **NOTE:** Ensure that the processor and the bracket are placed in the tray after you remove the heat sink.



Figure 74. Removing the processor bracket

Next steps

Install the processor into the processor and heat sink module.

Installing the processor into a processor and heat sink module

Prerequisites

Follow the safety guidelines listed in [Safety instructions](#).

Steps

1. Place the processor in the processor tray.
 - NOTE:** Ensure that the pin 1 indicator on the processor tray is aligned with the pin 1 indicator on the processor.
2. Flex the outer edges of the bracket around the processor ensuring that the processor is locked into the clips on the bracket.
 - NOTE:** Ensure that the pin 1 indicator on the bracket is aligned with the pin 1 indicator on the processor before placing the bracket on the processor.
 - NOTE:** Ensure that the processor and the bracket are placed in the tray before you install the heat sink.



Figure 75. Installing the processor bracket

3. If you are using an existing heat sink, remove the thermal grease from the heat sink by using a clean lint-free cloth.
4. Use the thermal grease syringe included with your processor kit to apply the grease in a quadrilateral design on the top of the processor.
 - CAUTION:** Applying too much thermal grease can result in excess grease coming in contact with and contaminating the processor socket.
 - NOTE:** The thermal grease syringe is intended for single use only. Dispose the syringe after you use it.

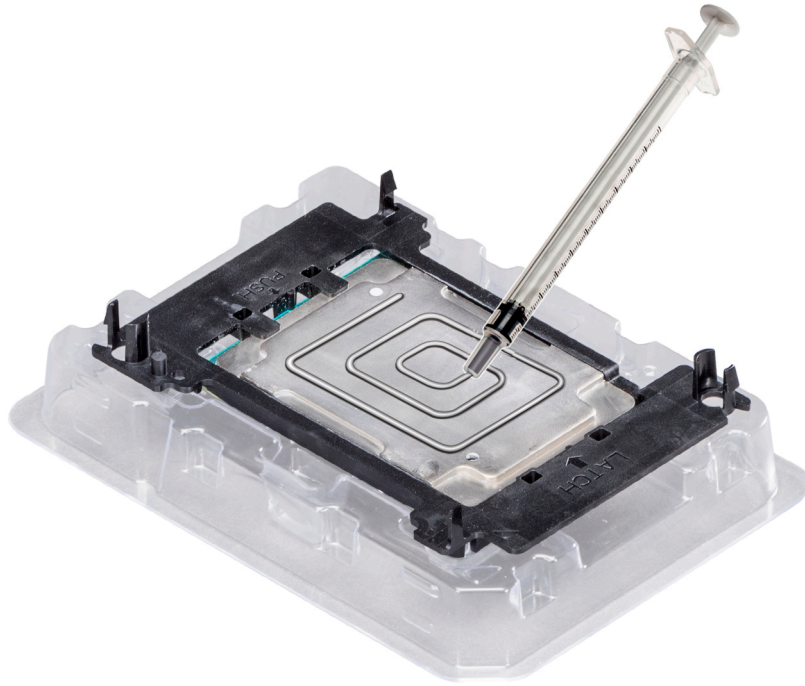

Figure 76. Applying thermal grease on top of the processor

5. Place the heat sink on the processor and push down on the base of the heat sink until the bracket locks onto the heat sink.

i NOTE:

- Ensure that the two guide pin holes on the bracket match the guide holes on the heat sink.
- Do not press on the heat sink fins.
- Ensure that the pin 1 indicator on the heat sink is aligned with the pin 1 indicator on the bracket before placing the heat sink onto the processor and bracket.

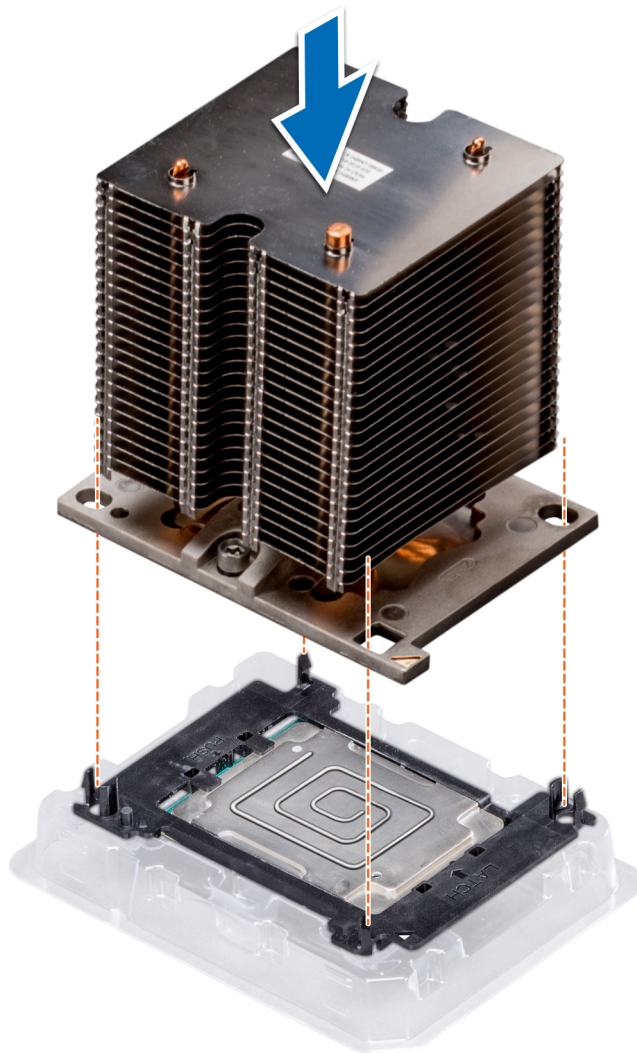

Figure 77. Installing the heat sink onto the processor

Next steps

1. [Install the processor and heat sink module.](#)
2. [Install the air shroud.](#)
3. Follow the procedure listed in [After working inside your system.](#)

Installing a processor and heat sink module

Prerequisites

CAUTION: Never remove the heat sink from a processor unless you intend to replace the processor. The heat sink is necessary to maintain proper thermal conditions.

1. Follow the safety guidelines listed in [Safety instructions.](#)
2. If installed, remove the processor blank and CPU dust cover.

Steps

1. Align the pin 1 indicator of the heat sink to the system board and then place the processor and heat sink module (PHM) on the processor socket.

CAUTION: To avoid damaging the fins on the heat sink, do not press down on the heat sink fins.

NOTE: Ensure that the PHM is held parallel to the system board to prevent damaging the components.

2. Push the blue retention clips inward to allow the heat sink to drop into place.
3. Using the Torx #T30 screwdriver, tighten the screws on the heat sink in the order below:
 - a. Partially tighten the first screw (approximately 3 turns).
 - b. Tighten the second screw completely.
 - c. Return to the first screw and tighten it completely.

If the PHM slips off the blue retention clips when the screws are partially tightened, follow these steps to secure the PHM:

- a. Loosen both the heat sink screws completely.
- b. Lower the PHM on to the blue retention clips, following the procedure described in step 2.
- c. Secure the PHM to the system board, following the replacement instructions listed in this step above. 4.

NOTE: The processor and heat sink module retention screws should not be tightened to more than 0.13 kgf-m (1.35 N.m or 12 in-lbf).

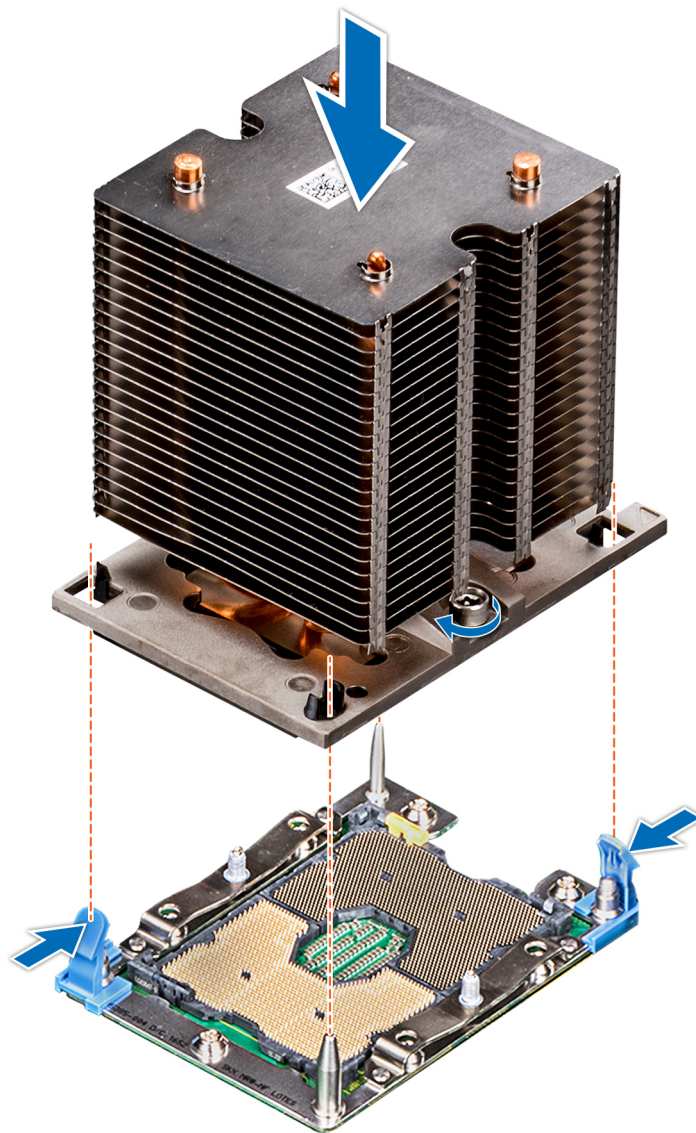

Figure 78. Installing a processor and heat sink module

Next steps

1. [Install the air shroud.](#)
2. Follow the procedure listed in [After working inside your system.](#)

Power supply units

NOTE: For more information, see the PowerEdge T440 Technical Specs at www.dell.com/poweredgemanuals.

CAUTION: If two PSUs are installed, both the PSUs must have the same type of label. For example, Extended Power Performance (EPP) label. Mixing PSUs from previous generations of PowerEdge servers is not supported, even if the PSUs have the same power rating. Mixing PSUs will result in mismatch condition or failure to turn the system on.

NOTE: When two identical PSUs are installed, power supply redundancy (1+1 – with redundancy or 2+0 – without redundancy) is configured in system BIOS. In redundant mode, power is supplied to the system equally from both PSUs when Hot Spare is disabled. When Hot Spare is enabled, one of the PSUs is put into the sleep mode when system utilization is low in order to maximize efficiency.

NOTE: If two PSUs are used, they must be of the same maximum output power.

Removing a power supply unit blank

Prerequisites

Follow the safety guidelines listed in [Safety instructions](#).

Steps

If you are installing a second power supply unit, remove the power supply unit blank in the bay by pulling the blank outward.

CAUTION: To ensure proper system cooling, the power supply unit blank must be installed in the second power supply unit bay in a non-redundant configuration. Remove the power supply unit blank only if you are installing a second power supply unit.

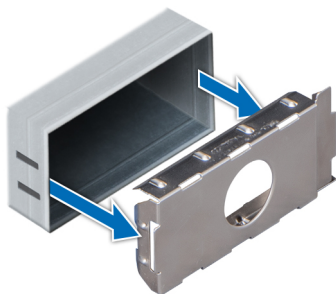

Figure 79. Removing a power supply unit blank

Next steps

Install the second power supply unit blank.

Installing a power supply unit blank

Prerequisites

1. Follow the safety guidelines listed in [Safety instructions](#).

NOTE: Install the power supply unit (PSU) blank only in the second PSU bay.

Steps

Align the PSU blank with the PSU slot and push it into the PSU slot until it clicks into place.

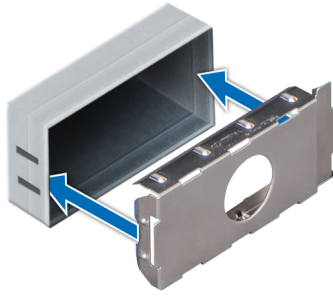

Figure 80. Installing a power supply unit blank

Next steps

Follow the procedure listed in [After working inside your system](#).

Removing a power supply unit

Prerequisites

CAUTION: The system needs one power supply unit (PSU) for normal operation. On power-redundant systems, remove and replace only one PSU at a time in a system that is powered on.

1. Follow the safety guidelines listed in [Safety instructions](#).
2. Disconnect the power cable from the power source and from the PSU you intend to remove, and then remove the cable from the strap on the PSU handle.

Steps

Press the orange release latch and slide the PSU out of the system by using the PSU handle.

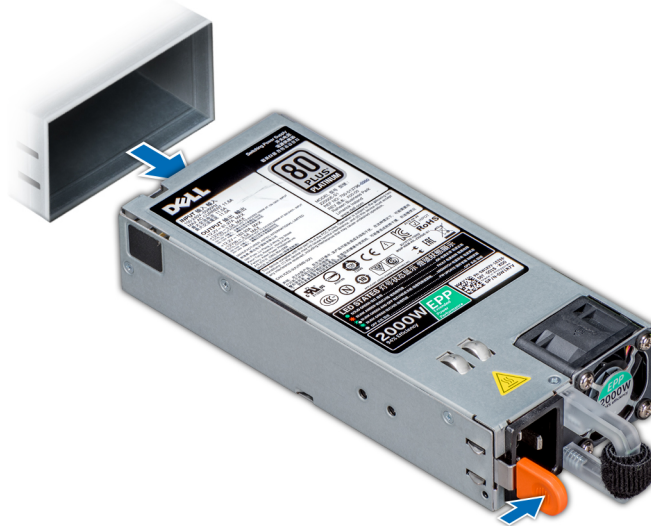

Figure 81. Removing a power supply unit

Next steps

Install the power supply unit.

Installing a power supply unit

Prerequisites

1. Follow the safety guidelines listed in [Safety instructions](#).
2. For systems that support redundant PSU, ensure that both the PSUs are of the same type and have the same maximum output power.

NOTE: The maximum output power (shown in watts) is listed on the PSU label.

Steps

Slide the PSU into the system until the PSU is fully seated and the release latch snaps into place.

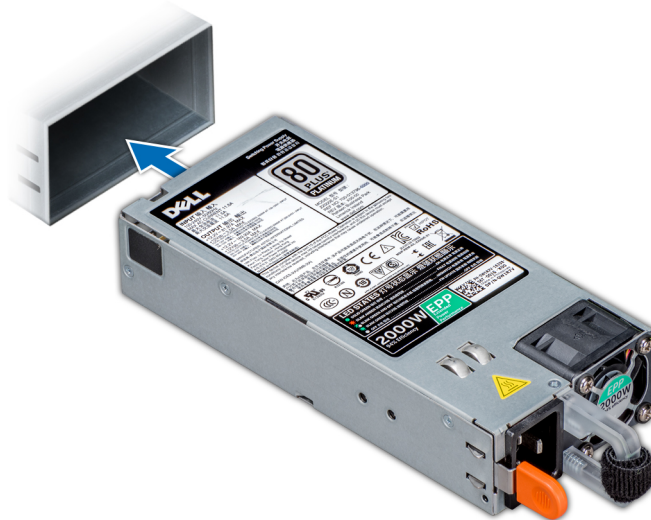

Figure 82. Installing a power supply unit

Next steps

1. Connect the power cable to the PSU, and plug the cable into a power outlet.

CAUTION: When connecting the power cable to the PSU, secure the cable to the PSU with the strap.

NOTE: When installing, hot swapping, or hot adding a new PSU, wait for 15 seconds for the system to recognize the PSU and determine its status. The PSU redundancy may not occur until discovery is complete. Wait until the new PSU is discovered and enabled before you remove the other PSU. The PSU status indicator turns green to signify that the PSU is functioning properly.

Removing a cabled power supply unit

Prerequisites

1. Follow the safety guidelines listed in [Safety instructions](#).
2. Follow the procedure listed in [Before working inside your system](#).

Steps

1. Disconnect all the power cables from the power supply unit (PSU).
2. Remove the screw securing the PSU to the chassis and slide the PSU out of the PSU cage.

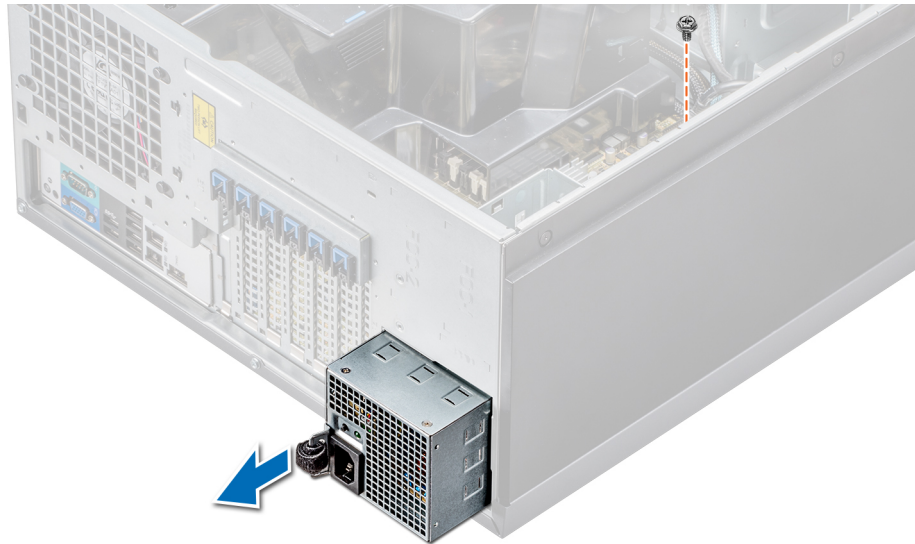

Figure 83. Removing a cabled PSU

Next steps

1. [Install a cabled power supply unit.](#)
2. Follow the procedure listed in [After working inside your system.](#)

Installing a cabled power supply unit

Prerequisites

1. Follow the safety guidelines listed in [Safety instructions.](#)
2. Unpack the replacement power supply unit (PSU).

Steps

1. Slide the new PSU into the PSU cage until the PSU is fully seated.
2. Tighten the screw to secure the PSU to the chassis.
3. Connect all the power cables from the PSU to the system board, drive backplane, and drives.

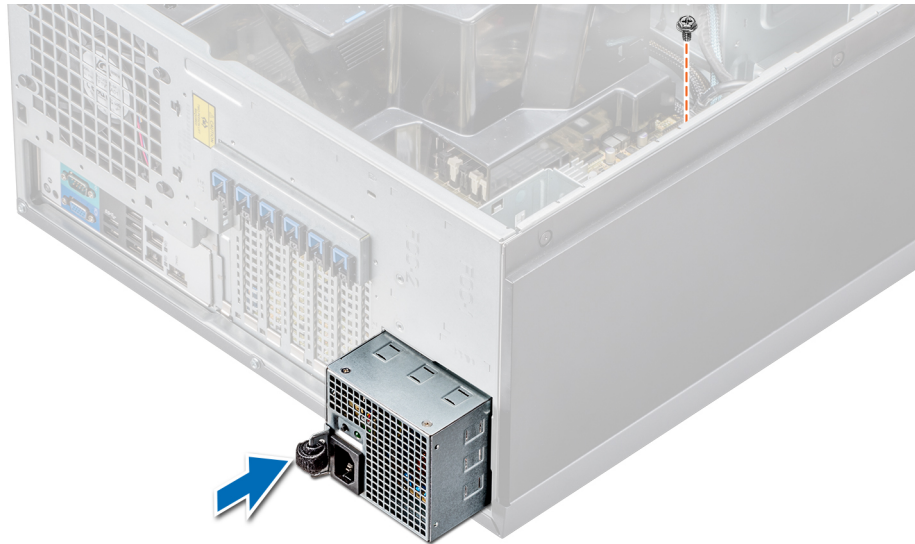

Figure 84. Installing a cabled PSU

Next steps

Follow the procedure listed in [After working inside your system](#).

Power interposer board

Removing the power interposer board

Prerequisites

1. Follow the safety guidelines listed in [Safety instructions](#).
2. Follow the procedure listed in [Before working inside your system](#).

CAUTION: To prevent damage to the power interposer board, you must remove the power supply units (PSUs) or PSU blank from the system before removing the power interposer board (PIB).

3. Remove the PSUs or PSU blanks from the back of the chassis.
4. Remove the air shroud.

Steps

1. Disconnect the power cables from the drive backplane and the system board.
NOTE: If installed, remove the expansion card to enable removing the P3 power cable from the system board.
2. Using the Phillips #2 screwdriver, remove the screw that secures PIB to the chassis.
3. Pressing the release latch on the PIB, lift the PIB to release it from the hooks on the PSU cage.
4. Lift the PIB out of the chassis.

Figure 85. Removing the power interposer board

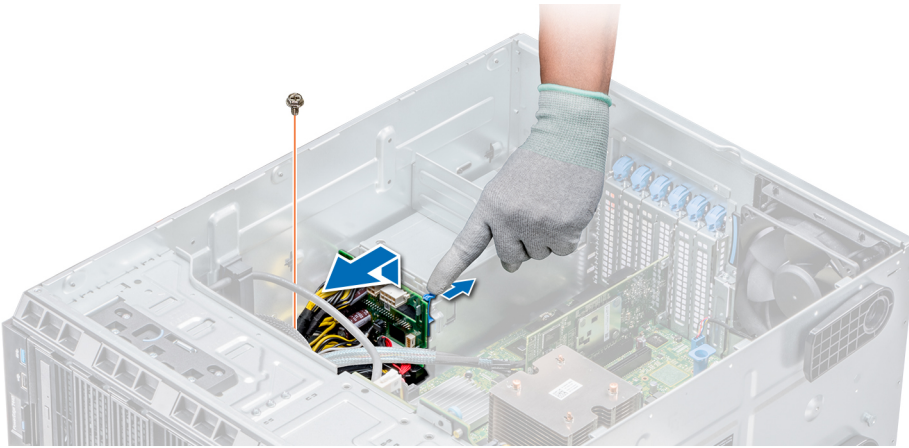

Next steps

Follow the procedure listed in [After working inside your system](#).

Installing the power interposer board

Prerequisites

CAUTION: Many repairs may only be done by a certified service technician. You should only perform troubleshooting and simple repairs as authorized in your product documentation, or as directed by the online or telephone service and support team. Damage due to servicing that is not authorized by Dell is not covered by your warranty. Read and follow the safety instructions that are shipped with your product.

Follow the safety guidelines listed in [Safety instructions](#).

Steps

1. Align the slots on the power interposer board (PIB) with the hooks on the power supply unit (PSU) cage and slide the PIB until it snaps into place.
2. Secure the PIB to the chassis by using the screw.
3. Route the P3 power cable through the securing clip on the system board and connect power cable to the drive backplane.

Figure 86. Installing the power interposer board

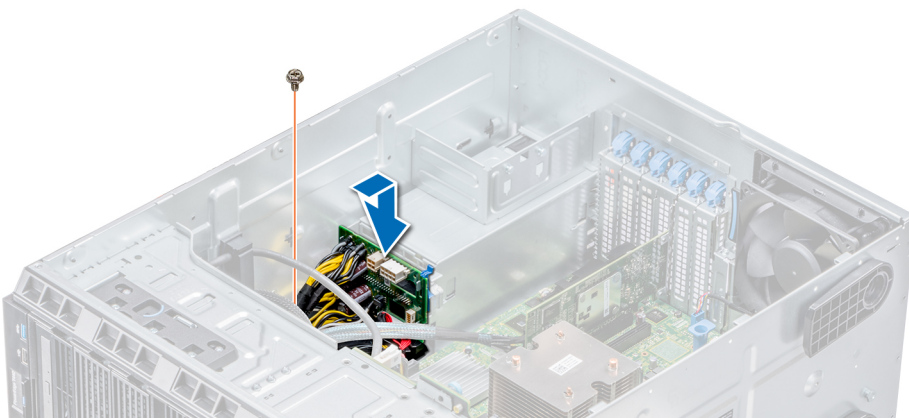

Next steps

1. Install the cooling shroud.
2. Install the PSUs or PSU blank.
3. Follow the procedure listed in [After working inside your system](#).

System battery

Replacing the system battery

Prerequisites

⚠ WARNING: There is a danger of a new battery exploding if it is incorrectly installed. Replace the battery only with the same or equivalent type recommended by the manufacturer. For more information, see the safety information that shipped with your system.

1. Follow the safety guidelines listed in [Safety instructions](#).
2. Follow the procedure listed in [Before working inside your system](#).
3. If applicable, disconnect the power or data cables from expansion card(s).

Steps

1. Locate the battery socket. For more information, see the [System board jumpers and connectors](#) section.

⚠ CAUTION: To avoid damage to the battery connector, you must firmly support the connector while installing or removing a battery.

2. Use a plastic scribe to pry out the system battery.

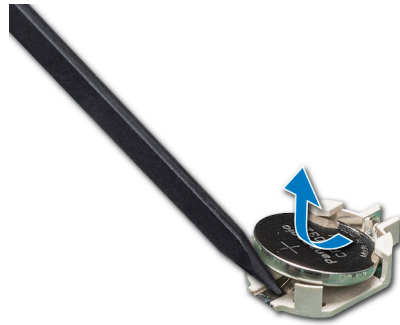

Figure 87. Removing the system battery

3. To install a new system battery, hold the battery with the positive side facing up and slide it under the securing tabs.
4. Press the battery into the connector until it snaps into place.

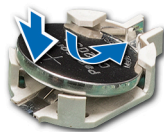

Figure 88. Installing the system battery

Next steps

1. If applicable, connect the cables to the expansion card(s).
2. Follow the procedure listed in [After working inside your system](#).
3. While booting, press F2 to enter the System Setup and ensure that the battery is operating properly.
4. Enter the correct time and date in the System Setup **Time** and **Date** fields.
5. Exit the System Setup.

Control panel assembly

Removing the control panel assembly

Prerequisites

1. Follow the safety guidelines listed in [Safety instructions](#).
2. Follow the procedure listed in [Before working inside your system](#).

Steps

1. Using the Phillips #2 screwdriver, remove the screw that secures control panel to the chassis.
2. Disconnect the control panel cable and the control panel USB cable from the system board.

CAUTION: Do not use excessive force when removing the control panel cables as it can damage the connectors.

3. Slide the control panel out of the chassis.

NOTE: Follow the same steps to remove the control panel in the rack-mode configuration.

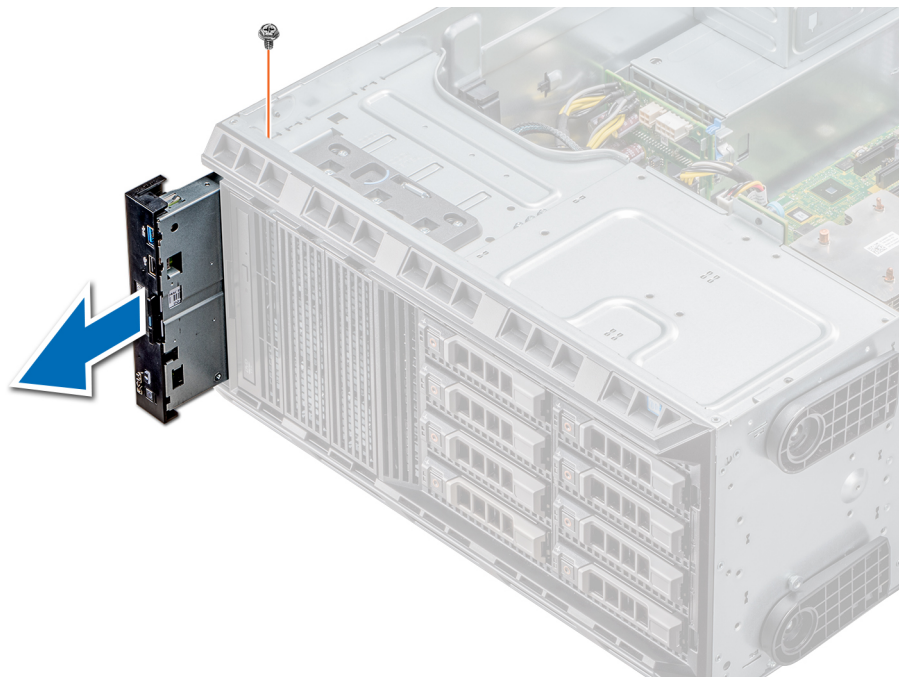

Figure 89. Removing the control panel assembly

4. To remove the information tag, perform the following steps:
 - a. Locate and press the tabs on the information tag.
 - b. Push the information tag out of the slot to remove it from the control panel.

NOTE: Retain the information tag to replace it in the new control panel.

Installing the control panel assembly

Prerequisites

Follow the safety guidelines listed in [Safety instructions](#).

Steps

1. Replace the blank information tag in the new control panel with the information tag retained from the old control panel.

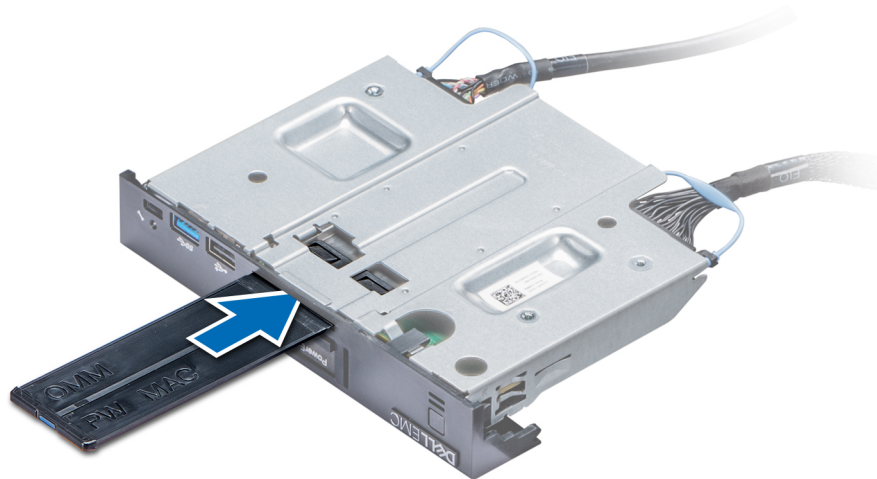

Figure 90. Installing the information tag



Figure 91. Installing the control panel assembly

2. To install the information tag, push the information tag into the control-panel slot.
3. Connect the control panel cable and the control panel USB cable to the control panel assembly.
4. Align and insert the control panel into the control panel slot in the chassis.
5. Secure the control panel to the chassis by using the screw.
6. Connect the control panel cable and the control panel USB cable to the system board.

Next steps

1. Follow the procedure listed in [After working inside your system](#).

System board

Removing the system board

Prerequisites

 **CAUTION:** If you are using the Trusted Platform Module (TPM) with an encryption key, you may be prompted to create a recovery key during program or System Setup. Be sure to create and safely store this recovery key. If you replace this system board, you must supply the recovery key when you restart your system or program before you can access the encrypted data on your hard drives.

 **CAUTION:** Do not attempt to remove the TPM plug-in module from the system board. Once the TPM plug-in module is installed, it is cryptographically bound to that specific system board. Any attempt to remove an installed TPM plug-in module breaks the cryptographic binding, and it cannot be reinstalled or installed on another system board.

1. Follow the safety guidelines listed in [Safety instructions](#).
2. Follow the procedure listed in [Before working inside your system](#).
3. Remove the following:
 - a. Air shroud
 - b. Internal cooling fan
 - c. Expansion card holder
 - d. Expansion cards, if installed
 - e. vFlash/IDSDM module
 - f. Internal USB key, if installed
 - g. Processors and heat sink modules

 **CAUTION:** To prevent damage to the processor pins when replacing a faulty system board, ensure that you cover the processor socket with the processor protective cap.

- h. Memory modules

Steps

1. Disconnect all cables from the system board.

 **CAUTION:** Take care not to damage the system identification button while removing the system board from the chassis.

 **CAUTION:** Do not lift the system board by holding a memory module, processor, or other components.

2. Remove the screws that secure the system board to the chassis.

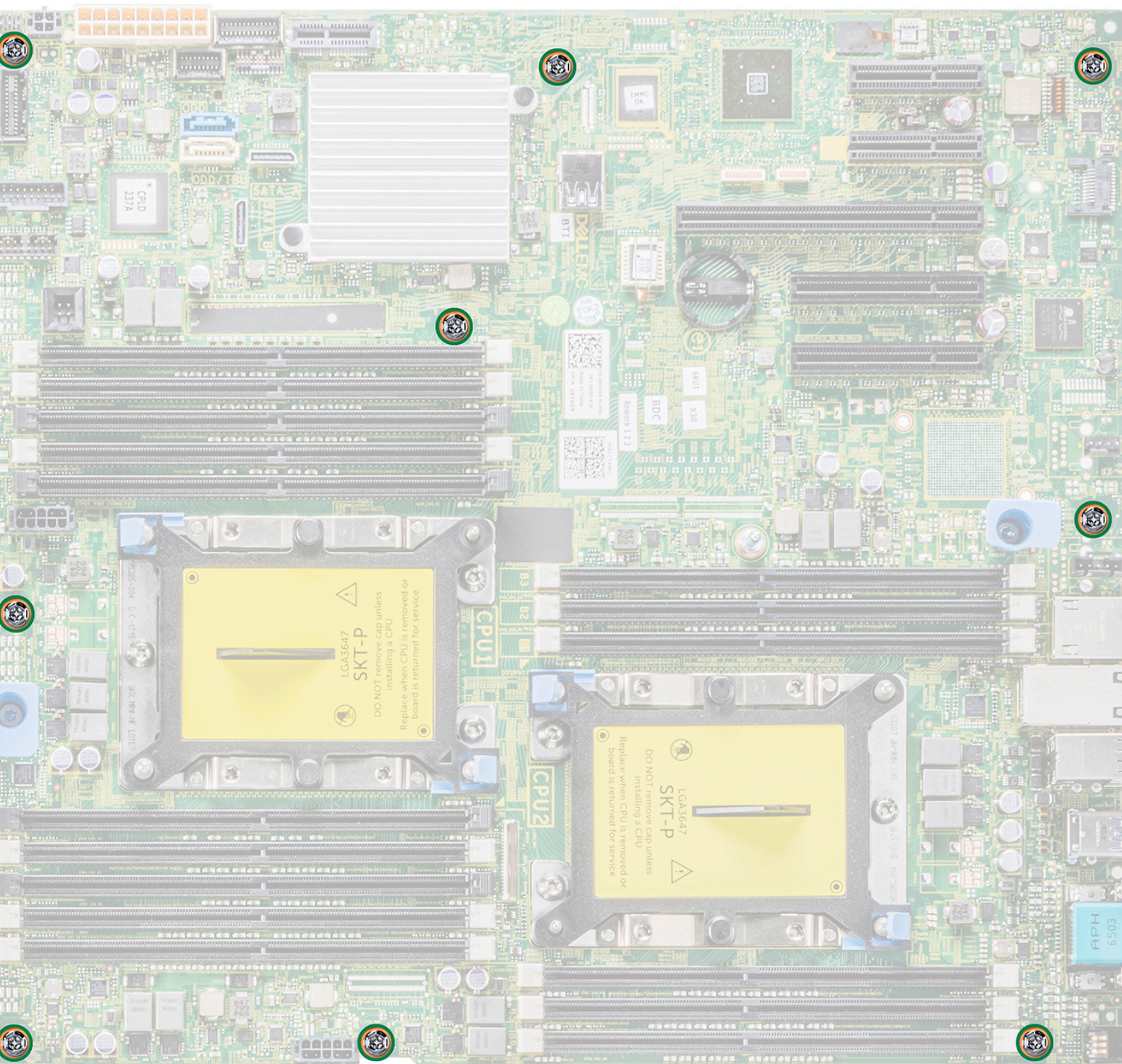

Figure 92. System board screws

3. Holding the post, incline the system board at an angle, and lift the system board out of the chassis.

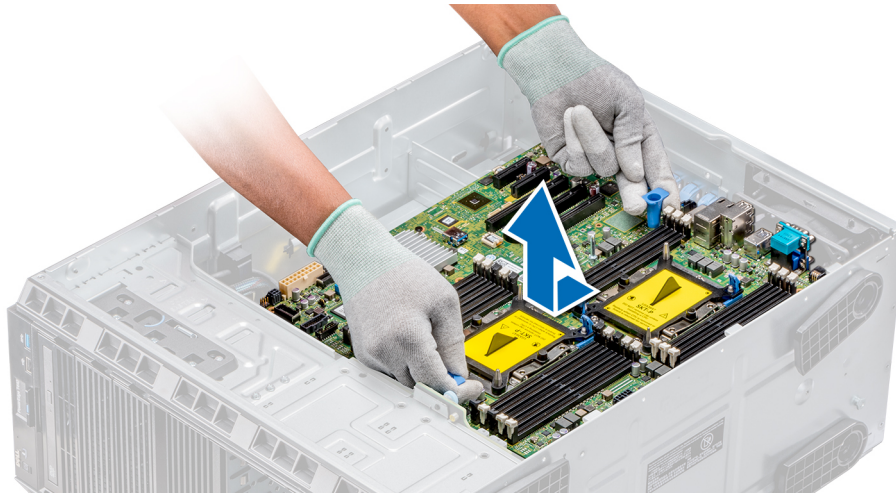

Figure 93. Removing the system board

Next steps

Replace or Install the system board.

Installing the system board

Prerequisites

Follow the safety guidelines listed in [Safety instructions](#).

Steps

1. Unpack the new system board assembly.

CAUTION: Do not lift the system board by holding a memory module, processor, or other components.

CAUTION: Take care not to damage the system identification button while placing the system board into the system.

2. Holding the post, incline the system board, and lower the system board into the chassis.
3. Holding the system board holder, push the system board toward the back of the system such that the ports on the system board align with the corresponding slots on the chassis.

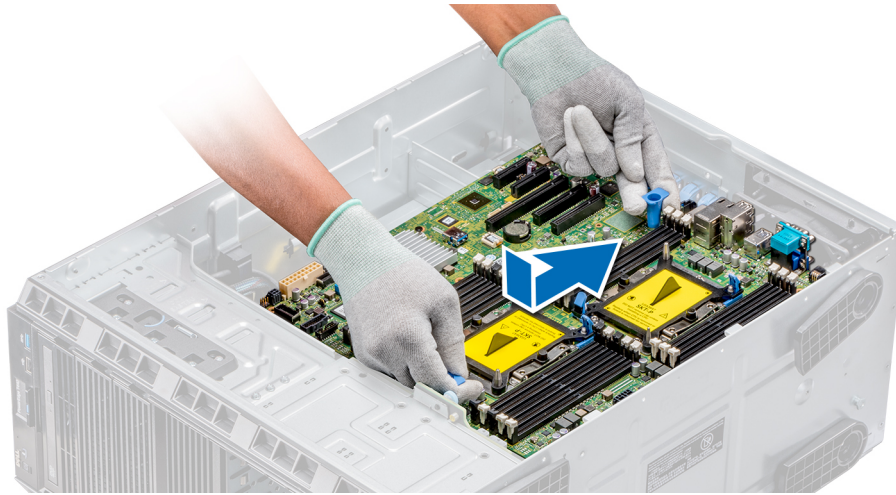

Figure 94. Installing the system board

4. Using the Phillips #2 screwdriver secure the system board to the chassis with screws.

Next steps

1. Replace the following:
 - a. Trusted Platform Module (TPM)
 - b. Memory modules
 - c. Processors and heat sink modules
 - d. Internal USB key
 - e. vFlash/IDSDM module
 - f. Integrated storage controller card
 - g. Expansion cards, if installed
 - h. Expansion card holder
 - i. GPU card holder
 - j. Air shroud
2. Reconnect all cables to the system board.
 - i** **NOTE:** Ensure that the cables inside the system are routed along the chassis wall and secured by using the cable securing bracket.
3. Follow the procedure listed in [After working inside your system](#).
4. Ensure that you:
 - a. Use the Easy Restore feature to restore the Service Tag. For more information, see the [Restoring the Service Tag using Easy Restore](#) section.
 - b. If the Service Tag is not backed up in the backup flash device, enter the Service Tag manually. For more information, see the [Restoring the Service Tag using Easy Restore](#) section.
 - c. Update the BIOS and iDRAC versions.
 - d. Re-enable the Trusted Platform Module (TPM). For more information, see the [Upgrading the Trusted Platform Module](#) section.
5. Import your new or existing iDRAC Enterprise license.



For more information, see iDRAC User's Guide, at www.dell.com/poweredgemanuals

Restoring the system using Easy Restore

The easy restore feature enables you to restore your service tag, license, UEFI configuration, and the system configuration data after replacing the system board. All data is backed up in a backup flash device automatically. If BIOS detects a new system board, and the service tag in the backup flash device, BIOS prompts the user to restore the backup information.

About this task

Below is a list of options available:

- Restore the service tag, license, and diagnostics information, press **Y**
 - Navigate to the Lifecycle Controller based restore options, press **N**.
 - Restore data from a previously created **Hardware Server Profile**, press **F10**
-  **NOTE:** When the restore process is complete, BIOS prompts to restore the system configuration data.
- To restore the system configuration data, press **Y**
 - To use the default configuration settings, press **N**
-  **NOTE:** After the restore process is complete, system reboots.

Manually update the Service Tag

After replacing a system board, if Easy Restore fails, follow this process to manually enter the Service Tag, using **System Setup**.

About this task

If you know the system service tag, use the **System Setup** menu to enter the service tag.

Steps

1. Power on the system.
 2. To enter the **System Setup**, press **F2**.
 3. Click **Service Tag Settings**.
 4. Enter the service tag.
-  **NOTE:** You can enter the service tag only when the **Service Tag** field is empty. Ensure that you enter the correct service tag. Once the service tag is entered, it cannot be updated or changed.
5. Click **OK**.

Trusted Platform Module

Upgrading the Trusted Platform Module

Prerequisites

1. Follow the safety guidelines listed in [Safety instructions](#).
2. Follow the procedure listed in [Before working inside your system](#).

-  **NOTE:**
- Ensure that your operating system supports the version of the TPM module being installed.
 - Ensure that you download and install the latest BIOS firmware on your system.
 - Ensure that the BIOS is configured to enable UEFI boot mode.

About this task

 **CAUTION:** If you are using the Trusted Platform Module (TPM) with an encryption key, you may be prompted to create a recovery key during program or System Setup. Work with the customer to create and safely store this recovery key. When replacing this system board, you must supply the recovery key when you restart your system or program before you can access the encrypted data on your hard drives.

 **CAUTION:** Once the TPM plug-in module is installed, it is cryptographically bound to that specific system board. Any attempt to remove an installed TPM plug-in module breaks the cryptographic binding, the removed TPM cannot be reinstalled or installed on another system board.

Removing the TPM

Steps

1. Locate the TPM connector on the system board.
2. Press to hold the module down and remove the screw using the security Torx 8-bit shipped with the TPM module.
3. Slide the TPM module out from its connector.
4. Push the plastic rivet away from the TPM connector and rotate it 90° counterclockwise to release it from the system board.
5. Pull the plastic rivet out of its slot on the system board.

Installing the TPM

Steps

1. To install the TPM, align the edge connectors on the TPM with the slot on the TPM connector.
2. Insert the TPM into the TPM connector such that the plastic rivet aligns with the slot on the system board.
3. Press the plastic rivet until the rivet snaps into place.

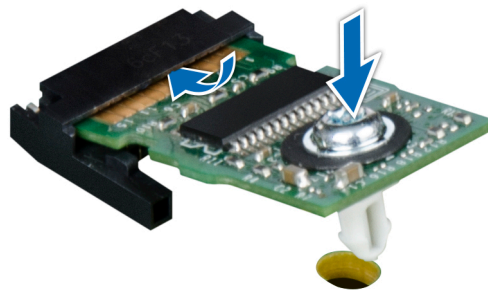

Figure 95. Installing the TPM

Next steps

1. Install the system board.
2. Follow the procedure listed in [After working inside your system](#).

Initializing TPM for BitLocker users

Steps

Initialize the TPM.

For more information, see .

The **TPM Status** changes to **Enabled, Activated**.

Initializing the TPM 1.2 for TXT users

Steps

1. While booting your system, press F2 to enter System Setup.
2. On the **System Setup Main Menu** screen, click **System BIOS > System Security Settings**.
3. From the **TPM Security** option, select **On with Pre-boot Measurements**.
4. From the **TPM Command** option, select **Activate**.
5. Save the settings.

- Restart your system.
- Enter **System Setup** again.
- On the **System Setup Main Menu** screen, click **System BIOS > System Security Settings**.
- From the **Intel TXT** option, select **On**.

Converting the system from tower mode to rack mode

Your system can be converted from the tower mode to the rack mode.

To convert your system from the tower mode to the rack mode, you require the tower to rack conversion kit, which contains the following:

- Rack ears (left and right) with three screws each

Converting the system from tower mode to rack mode

Prerequisites

- Follow the safety guidelines listed in [Safety instructions](#).
- Follow the procedure listed in [Before working inside your system](#).
- If installed, remove the system feet or caster wheels.

Steps

- Remove the control-panel assembly.
- Install the rack slide cover by performing the following steps:
 - Slide the rack slide cover between the system's side cover and the chassis.
 - Slide the rack slide cover toward the back of the system until the tabs on rack slide cover locks with the tabs extending from the chassis.
- Install the control panel assembly.
- Install the rack ears by performing the following steps:
 - Align the three screw holes on the rack ears with the screw holes on the top and the bottom of system.
 - Using a Phillips #2 screwdriver, secure the rack ears to the system.



Figure 96. Installing the system ears

Next steps

1. Install the system cover.
2. Install the system in the rack. For more information, see the Rack Installation Guide that is shipped with your system.
3. Follow the procedure listed in [After working inside your system](#).

Updating BIOS

About this task

To update the BIOS, perform the following steps:

Steps

1. Copy the BIOS update file on a USB device.
2. Plug in the USB device into any of the USB ports on your system.
3. Power on your system.
4. While booting, press **F11** to enter the **Boot Manager**.
5. Go to **System Utilities** → **BIOS Update File Explorer**, and select the plugged in USB device.
6. From the **BIOS Update File Explorer**, select the **BIOS update file**.
The **BIOS Update Utility** with the current and new version of BIOS is displayed.
7. Select **Continue BIOS Update** to install the BIOS update.

Jumpers and connectors

This topic provides specific information about the jumpers. It also provides some basic information about jumpers and switches and describes the connectors on the various boards in the system. Jumpers on the system board help to disable the system and setup passwords. You must know the connectors on the system board to install components and cables correctly.

Topics:

- [System board jumpers and connectors](#)
- [System board jumper settings](#)
- [Disabling forgotten password](#)

System board jumpers and connectors

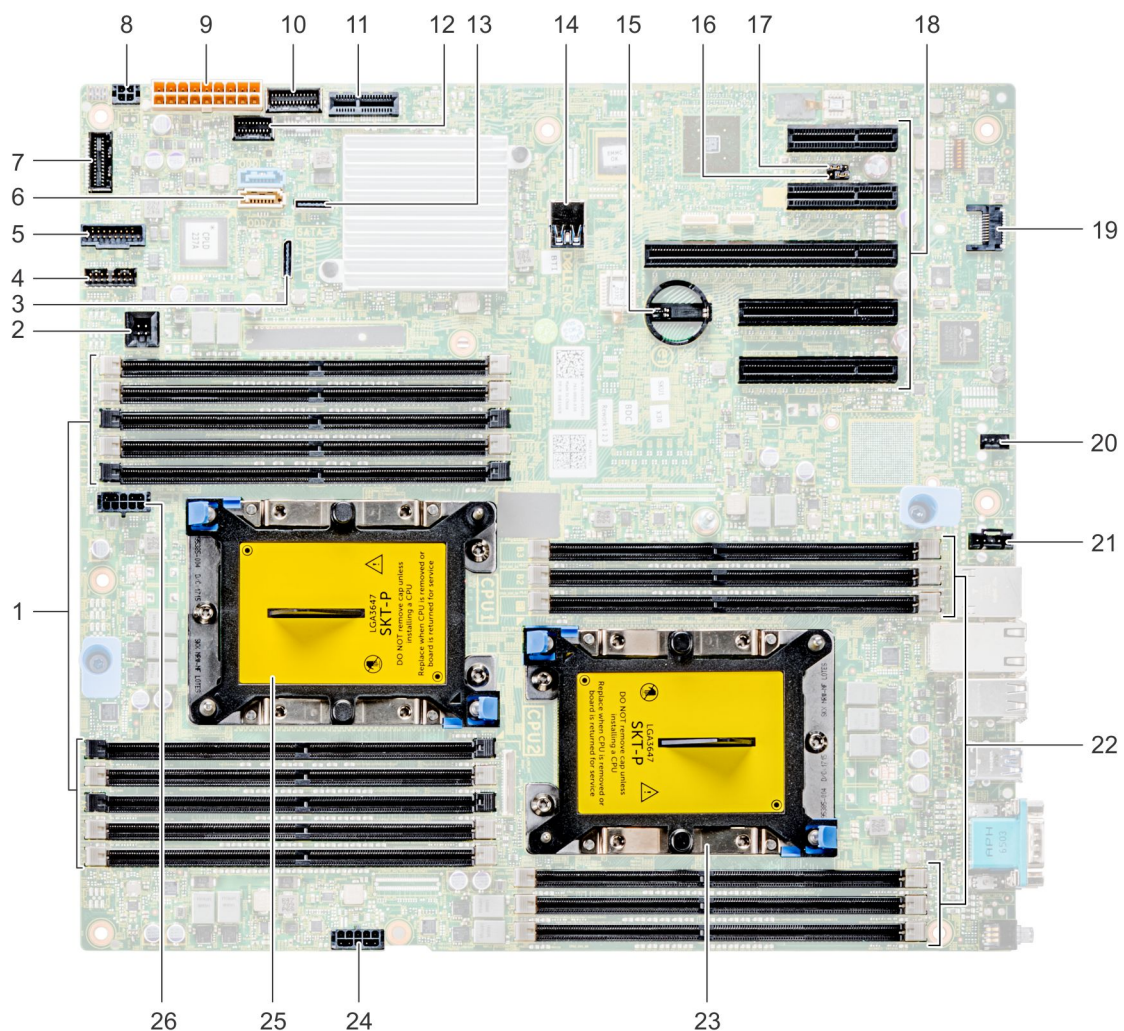

Figure 97. T440 system board jumpers and connectors

Table 20. System board connectors

Item	Connector	Description
1	DIMMs for Processor 1 channels 0,1,2,3,4,5	Memory slots A1-A10 for Processor 1
2	Intrusion switch	Intrusion switch connector
3	SATA B	Onboard SATA B connector
4	Backplane signal	Backplane signal connector
5	Front_USB	Front USB connector
6	SATA connector	SATA connector
7	Control panel	Control panel connector
8	ODD power	ODD power connector
9	System power	System power connector
10	PIB signal 2	PIB signal 2 connector
11	IDSDM+VFlash	IDSDM+VFlash connector
12	PIB signal 1	PIB signal 1 connector
13	SATA A	SATA A connector
14	Internal USB 3.0	Internal USB 3.0 connector
15	COIN Cell BATTERY	Coin cell battery
16	NVRAM_CLR	Clear NVRAM
17	PWRD_EN	Reset BIOS password
18	PCIe slots	PCIe slots 1 - 5
19	TPM	TPM connector
20	Fan 1	Internal fan connector
21	Fan 2	External fan connector
22	DIMMs for Processor 2 channels 0,1,2,4,5	Memory slots B1-B6 for Processor 2
23	Processor 2	Processor 2
24	Processor 2 PWR	Processor 2 Power connector
25	Processor 1	Processor 1
26	Processor 1 PWR	Processor 1 Power connector

System board jumper settings

For information on resetting the password jumper to disable a password, see the [Disabling a forgotten password](#) section.

Disabling forgotten password

The software security features of the system include a system password and a setup password. The password jumper enables or disables password features and clears any password(s) currently in use.

Prerequisites

 **CAUTION:** Many repairs may only be done by a certified service technician. You should only perform troubleshooting and simple repairs as authorized in your product documentation, or as directed by the online or

telephone service and support team. Damage due to servicing that is not authorized by Dell is not covered by your warranty. Read and follow the safety instructions that are shipped with your product.

Steps

1. Power off the system, including any attached peripherals, and disconnect the system from the electrical outlet.
2. Remove the system cover.
3. Move the jumper on the system board jumper from pins 2 and 4 to pins 4 and 6.
4. Install the system cover.

The existing passwords are not disabled (erased) until the system boots with the jumper on pins 4 and 6. However, before you assign a new system and/or setup password, you must move the jumper back to pins 2 and 4.

 **NOTE:** If you assign a new system and/or setup password with the jumper on pins 4 and 6, the system disables the new password(s) the next time it boots.

5. Reconnect the system to its electrical outlet and power on the system, including any attached peripherals.
6. Power off the system, including any attached peripherals, and disconnect the system from the electrical outlet.
7. Remove the system cover.
8. Move the jumper on the system board jumper from pins 4 and 6 to pins 2 and 4.
9. Install the system cover.
10. Reconnect the system to its electrical outlet and power on the system, including any attached peripherals.
11. Assign a new system and/or setup password.

System diagnostics

If you experience a problem with your system, run the system diagnostics before contacting Dell for technical assistance. The purpose of running system diagnostics is to test your system hardware without using additional equipment or risking data loss. If you are unable to fix the problem yourself, service and support personnel can use the diagnostics results to help you solve the problem.

Topics:

- [Dell Embedded System Diagnostics](#)

Dell Embedded System Diagnostics

NOTE: The Dell Embedded System Diagnostics is also known as Enhanced Pre-boot System Assessment (ePSA) diagnostics.

The Embedded System Diagnostics provides a set of options for particular device groups or devices allowing you to:

- Run tests automatically or in an interactive mode
- Repeat tests
- Display or save test results
- Run thorough tests to introduce additional test options to provide extra information about the failed device(s)
- View status messages that inform you if tests are completed successfully
- View error messages that inform you of problems encountered during testing

Running the Embedded System Diagnostics from Boot Manager

Run the Embedded System Diagnostics (ePSA) if your system does not boot.

Steps

1. When the system is booting, press F11.
2. Use the up arrow and down arrow keys to select **System Utilities > Launch Diagnostics**.
3. Alternatively, when the system is booting, press F10, select **Hardware Diagnostics > Run Hardware Diagnostics**. The **ePSA Pre-boot System Assessment** window is displayed, listing all devices detected in the system. The diagnostics starts executing the tests on all the detected devices.

Running the Embedded System Diagnostics from the Dell Lifecycle Controller

Steps

1. As the system boots, press F10.
2. Select **Hardware Diagnostics → Run Hardware Diagnostics**. The **ePSA Pre-boot System Assessment** window is displayed, listing all devices detected in the system. The diagnostics starts executing the tests on all the detected devices.

System diagnostic controls

Menu	Description
Configuration	Displays the configuration and status information of all detected devices.

Menu	Description
Results	Displays the results of all tests that are run.
System health	Provides the current overview of the system performance.
Event log	Displays a time-stamped log of the results of all tests run on the system. This is displayed if at least one event description is recorded.

Getting help

Topics:

- [Contacting Dell EMC](#)
- [Documentation feedback](#)
- [Accessing system information by using QRL](#)
- [Receiving automated support with SupportAssist](#)
- [Recycling or End-of-Life service information](#)

Contacting Dell EMC

Dell EMC provides several online and telephone based support and service options. If you do not have an active internet connection, you can find contact information about your purchase invoice, packing slip, bill, or Dell EMC product catalog. Availability varies by country and product, and some services may not be available in your area. To contact Dell EMC for sales, technical assistance, or customer service issues:

Steps

1. Go to www.dell.com/support/home.
2. Select your country from the drop-down menu on the lower right corner of the page.
3. For customized support:
 - a. Enter your system Service Tag in the **Enter your Service Tag** field.
 - b. Click **Submit**.
The support page that lists the various support categories is displayed.
4. For general support:
 - a. Select your product category.
 - b. Select your product segment.
 - c. Select your product.
The support page that lists the various support categories is displayed.
5. For contact details of Dell EMC Global Technical Support:
 - a. Click [Contact Technical Support](#).
 - b. Enter your system Service Tag in the **Enter your Service Tag** field on the Contact Us webpage.

Documentation feedback

You can rate the documentation or write your feedback on any of our Dell EMC documentation pages and click **Send Feedback** to send your feedback.

Accessing system information by using QRL

You can use the Quick Resource Locator (QRL) located on the information tag in the front of the system, to access the information about the PowerEdge system.

Prerequisites

Ensure that your smartphone or tablet has the QR code scanner installed.

The QRL includes the following information about your system:

- How-to videos

- Reference materials, including the Installation and Service Manual, and mechanical overview
- Your system service tag to quickly access your specific hardware configuration and warranty information
- A direct link to Dell to contact technical assistance and sales teams

Steps

1. Go to www.dell.com/qrl and navigate to your specific product or
2. Use your smartphone or tablet to scan the model-specific Quick Resource (QR) code on your system or in the Quick Resource Locator section.

Quick Resource Locator for Dell EMC PowerEdge T440 system

Quick Resource Locator for Dell EMC PowerEdge T440 system



Receiving automated support with SupportAssist

Dell EMC SupportAssist is an optional Dell EMC Services offering that automates technical support for your Dell EMC server, storage, and networking devices. By installing and setting up a SupportAssist application in your IT environment, you can receive the following benefits:

- **Automated issue detection** — SupportAssist monitors your Dell EMC devices and automatically detects hardware issues, both proactively and predictively.
- **Automated case creation** — When an issue is detected, SupportAssist automatically opens a support case with Dell EMC Technical Support.
- **Automated diagnostic collection** — SupportAssist automatically collects system state information from your devices and uploads it securely to Dell EMC. This information is used by Dell EMC Technical Support to troubleshoot the issue.
- **Proactive contact** — A Dell EMC Technical Support agent contacts you about the support case and helps you resolve the issue.

The available benefits vary depending on the Dell EMC Service entitlement purchased for your device. For more information about SupportAssist, go to www.dell.com/supportassist.

Recycling or End-of-Life service information

Take back and recycling services are offered for this product in certain countries. If you want to dispose of system components, visit www.dell.com/recyclingworldwide and select the relevant country.

Documentation resources

This section provides information about the documentation resources for your system.

To view the document that is listed in the documentation resources table:

- From the Dell EMC support site:
 1. Click the documentation link that is provided in the Location column in the table.
 2. Click the required product or product version.
-  **NOTE:** To locate the product name and model, see the front of your system.
- 3. On the Product Support page, click **Manuals & documents**.
- Using search engines:
 - Type the name and version of the document in the search box.

Table 21. Documentation resources

Task	Document	Location
Setting up your system	<p>For more information about installing and securing the system into a rack, see the Rail Installation Guide included with your rack solution.</p> <p>For information about setting up your system, see the <i>Getting Started Guide</i> document that is shipped with your system.</p>	https://www.dell.com/poweredgemanuals
Configuring your system	<p>For information about the iDRAC features, configuring and logging in to iDRAC, and managing your system remotely, see the Integrated Dell Remote Access Controller User's Guide.</p> <p>For information about understanding Remote Access Controller Admin (RACADM) subcommands and supported RACADM interfaces, see the RACADM CLI Guide for iDRAC.</p> <p>For information about Redfish and its protocol, supported schema, and Redfish Eventing implemented in iDRAC, see the Redfish API Guide.</p> <p>For information about iDRAC property database group and object descriptions, see the Attribute Registry Guide.</p> <p>For information about Intel QuickAssist Technology, see the Integrated Dell Remote Access Controller User's Guide.</p>	https://www.dell.com/poweredgemanuals
	<p>For information about earlier versions of the iDRAC documents.</p> <p>To identify the version of iDRAC available on your system, on the iDRAC web interface, click ? > About.</p>	https://www.dell.com/idracmanuals
	<p>For information about installing the operating system, see the operating system documentation.</p>	https://www.dell.com/operatingsystemmanuals

Table 21. Documentation resources (continued)

Task	Document	Location
	For information about updating drivers and firmware, see the Methods to download firmware and drivers section in this document.	www.dell.com/support/drivers
Managing your system	For information about system management software offered by Dell, see the Dell OpenManage Systems Management Overview Guide.	https://www.dell.com/poweredgemanuals
	For information about setting up, using, and troubleshooting OpenManage, see the Dell OpenManage Server Administrator User's Guide.	www.dell.com/openmanagemanuals > OpenManage Server Administrator
	For information about installing, using, and troubleshooting Dell OpenManage Enterprise, see the Dell OpenManage Enterprise User's Guide.	https://www.dell.com/openmanagemanuals
	For information about installing and using Dell SupportAssist, see the Dell EMC SupportAssist Enterprise User's Guide.	https://www.dell.com/serviceabilitytools
	For information about partner programs enterprise systems management, see the OpenManage Connections Enterprise Systems Management documents.	https://www.dell.com/openmanagemanuals
Working with the Dell PowerEdge RAID controllers	For information about understanding the features of the Dell PowerEdge RAID controllers (PERC), Software RAID controllers, or BOSS card and deploying the cards, see the Storage controller documentation.	www.dell.com/storagecontrollermanuals
Understanding event and error messages	For information about the event and error messages generated by the system firmware and agents that monitor system components, go to qrl.dell.com > Look Up > Error Code , type the error code, and then click Look it up .	www.dell.com/qrl
Troubleshooting your system	For information about identifying and troubleshooting the PowerEdge server issues, see the Server Troubleshooting Guide.	https://www.dell.com/poweredgemanuals