



Video Wall Controller  
Quick Start Guide

# Legal Information

©2022 Hangzhou Hikvision Digital Technology Co., Ltd. All rights reserved.

## About this Manual

The Manual includes instructions for using and managing the Product. Pictures, charts, images and all other information hereinafter are for description and explanation only. The information contained in the Manual is subject to change, without notice, due to firmware updates or other reasons. Please find the latest version of this Manual at the Hikvision website (<https://www.hikvision.com/>).

Please use this Manual with the guidance and assistance of professionals trained in supporting the Product.

## Trademarks

**HIKVISION** and other Hikvision's trademarks and logos are the properties of Hikvision in various jurisdictions. Other trademarks and logos mentioned are the properties of their respective owners.

## Disclaimer

TO THE MAXIMUM EXTENT PERMITTED BY APPLICABLE LAW, THIS MANUAL AND THE PRODUCT DESCRIBED, WITH ITS HARDWARE, SOFTWARE AND FIRMWARE, ARE PROVIDED "AS IS" AND "WITH ALL FAULTS AND ERRORS". HIKVISION MAKES NO WARRANTIES, EXPRESS OR IMPLIED, INCLUDING WITHOUT LIMITATION, MERCHANTABILITY, SATISFACTORY QUALITY, OR FITNESS FOR A PARTICULAR PURPOSE. THE USE OF THE PRODUCT BY YOU IS AT YOUR OWN RISK. IN NO EVENT WILL HIKVISION BE LIABLE TO YOU FOR ANY SPECIAL, CONSEQUENTIAL, INCIDENTAL, OR INDIRECT DAMAGES, INCLUDING, AMONG OTHERS, DAMAGES FOR LOSS OF BUSINESS PROFITS, BUSINESS INTERRUPTION, OR LOSS OF DATA, CORRUPTION OF SYSTEMS, OR LOSS OF DOCUMENTATION, WHETHER BASED ON BREACH OF CONTRACT, TORT (INCLUDING NEGLIGENCE), PRODUCT LIABILITY, OR OTHERWISE, IN CONNECTION WITH THE USE OF THE PRODUCT, EVEN IF HIKVISION HAS BEEN ADVISED OF THE POSSIBILITY OF SUCH DAMAGES OR LOSS.

YOU ACKNOWLEDGE THAT THE NATURE OF THE INTERNET PROVIDES FOR INHERENT SECURITY RISKS, AND HIKVISION SHALL NOT TAKE ANY RESPONSIBILITIES FOR ABNORMAL OPERATION, PRIVACY LEAKAGE OR OTHER DAMAGES RESULTING FROM CYBER-ATTACK, HACKER ATTACK, VIRUS INFECTION, OR OTHER INTERNET SECURITY RISKS; HOWEVER, HIKVISION WILL PROVIDE TIMELY TECHNICAL SUPPORT IF REQUIRED.

YOU AGREE TO USE THIS PRODUCT IN COMPLIANCE WITH ALL APPLICABLE LAWS, AND YOU ARE SOLELY RESPONSIBLE FOR ENSURING THAT YOUR USE CONFORMS TO THE APPLICABLE LAW. ESPECIALLY, YOU ARE RESPONSIBLE, FOR USING THIS PRODUCT IN A MANNER THAT DOES NOT INFRINGE ON THE RIGHTS OF THIRD PARTIES, INCLUDING WITHOUT LIMITATION, RIGHTS OF PUBLICITY, INTELLECTUAL PROPERTY RIGHTS, OR DATA PROTECTION AND OTHER PRIVACY RIGHTS. YOU SHALL NOT USE THIS PRODUCT FOR ANY PROHIBITED END-USES, INCLUDING THE DEVELOPMENT OR PRODUCTION OF WEAPONS OF MASS DESTRUCTION, THE DEVELOPMENT OR PRODUCTION OF CHEMICAL OR BIOLOGICAL WEAPONS, ANY ACTIVITIES IN THE CONTEXT RELATED TO ANY NUCLEAR EXPLOSIVE OR UNSAFE NUCLEAR FUEL-CYCLE, OR IN SUPPORT OF HUMAN RIGHTS ABUSES.

IN THE EVENT OF ANY CONFLICTS BETWEEN THIS MANUAL AND THE APPLICABLE LAW, THE LATTER PREVAILS.

## Regulatory Information

### FCC Information

Please take attention that changes or modification not expressly approved by the party responsible for compliance could void the user's authority to operate the equipment.

#### FCC Compliance

This equipment has been tested and found to comply with the limits for a Class A digital device, pursuant to part 15 of the FCC Rules. These limits are designed to provide reasonable protection against harmful interference when the equipment is operated in a commercial environment. This equipment generates, uses, and can radiate radio frequency energy and, if not installed and used in accordance with the instruction manual, may cause harmful interference to radio communications. Operation of this equipment in a residential area is likely to cause harmful interference in which case the user will be required to correct the interference at his own expense.

#### FCC Conditions

This device complies with part 15 of the FCC Rules. Operation is subject to the following two conditions:

1. This device may not cause harmful interference.
2. This device must accept any interference received, including interference that may cause undesired operation.

### EU Conformity Statement

 This product and - if applicable - the supplied accessories too are marked with "CE" and comply therefore with the applicable harmonized European standards listed under the EMC Directive 2014/30/EU, the LVD Directive 2014/35/EU, the RoHS Directive 2011/65/EU.

 2012/19/EU (WEEE directive): Products marked with this symbol cannot be disposed of as unsorted municipal waste in the European Union. For proper recycling, return this product to your local supplier upon the purchase of equivalent new equipment, or dispose of it at designated collection points. For more information see: [www.recyclethis.info](http://www.recyclethis.info)

 2006/66/EC (battery directive): This product contains a battery that cannot be disposed of as unsorted municipal waste in the European Union. See the product documentation for specific battery information. The battery is marked with this symbol, which may include lettering to indicate cadmium (Cd), lead (Pb), or mercury (Hg). For proper recycling, return the battery to your supplier or to a designated collection point. For more information see: [www.recyclethis.info](http://www.recyclethis.info)

## Preface

### Applicable Models

This manual is applicable to C30 series video wall controllers.

### About the Default

This device has the following defaults.

Category	Parameter	Default Value
Device	Login username and IP address	User name: admin IP Address: 192.0.0.64

---



#### Caution

In order to improve system security, it is strongly recommended to reset your password regularly. In order to protect your personal privacy and corporate data, and avoid network security issues on your device, it is recommended that you set a high-strength password that complies with security regulations.

---

### Symbol Conventions

The symbols that may be found in this document are defined as follows.

Symbol	Description
 <b>Note</b>	Provides additional information to emphasize or supplement important points of the main text.
 <b>Caution</b>	Indicates a potentially hazardous situation, which if not avoided, could result in equipment damage, data loss, performance degradation, or unexpected results.
 <b>Danger</b>	Indicates a hazard with a high level of risk, which if not avoided, will result in death or serious injury.

## Safety Instructions

- In the use of the product, you must be in strict compliance with the electrical safety regulations of the nation and region.

This is a class A product and may cause radio interference in which case the user may be required to take adequate measures.

- Use the power adapter delivered with the device only.
- This equipment is not suitable for use in locations where children are likely to be present.
- CAUTION: Risk of explosion if the battery is replaced by an incorrect type.

Improper replacement of the battery with an incorrect type may defeat a safeguard (for example, in the case of some lithium battery types).

Do not dispose of the battery into fire or a hot oven, or mechanically crush or cut the battery, which may result in an explosion.

- Do not leave the battery in an extremely high temperature surrounding environment, which may result in an explosion or the leakage of flammable liquid or gas.
- Do not subject the battery to extremely low air pressure, which may result in an explosion or the leakage of flammable liquid or gas.
- Waste batteries will pollute the environment. Please dispose of used batteries according to the instructions.
- Do not expose the battery to the sun, fire or other similar overheated environment.
- The protective ground terminal of the equipment should be reliably connected to the protective grounding device of the building.
- The device contains fans. Keep body parts away from fan blades. Disconnect the power source during maintenance.
- If the product does not work properly, please contact your dealer or the nearest service center. Never attempt to disassemble the product yourself. (We shall not assume any responsibility for problems caused by unauthorized repair or maintenance.)
- If smoke, odor or noise rise from the device during use, please turn off the power at once and unplug the power cable, and then contact the service center.

### **Caution**

- The device is a system-level monitoring equipment, which is generally placed in the central computer room of the monitoring system at all levels. The selection of the installation site should comply with the relevant standards of the computer room construction in the country and region of use.
- The device is only suitable for installation in the computer room.
- Please install the device according to the instructions in this manual. To prevent injury, this device must be securely attached to the installation location.
- Do not place the device in an environment with strong vibration, impact, or strong electromagnetic interference (ignorance can cause equipment damage).

- Do not expose the device to the explosive situation.
- Keep clean and dry on the surface of the device.
- Do not touch the exposed connection points or components when the device is powered on.
- Keep a minimum 25 cm distance around the device for sufficient ventilation.

The ventilation should not be impeded by covering the ventilation openings with items, such as newspapers, table-cloths, curtains, etc. The openings shall never be blocked by placing the device on a bed, sofa, rug or other similar surface.

# TABLE OF CONTENTS

<b>Chapter 1 Introduction .....</b>	<b>1</b>
1.1 Overview .....	1
1.2 Packing List.....	1
1.3 Device Appearance .....	2
1.3.1 Host System .....	2
1.3.2 Functional Service Board .....	5
<b>Chapter 2 Installation .....</b>	<b>13</b>
2.1 Safety Precautions .....	13
2.2 Install Board Card.....	15
2.3 Install Cabinet and Grounding .....	16
2.4 Connect Cables .....	17
2.4.1 Connect Network .....	17
2.4.2 Connect Power Cord .....	18
2.5 Power the Device On .....	18
<b>Chapter 3 Get More Information .....</b>	<b>19</b>

# Chapter 1 Introduction

## 1.1 Overview

The DS-C30S series video wall controller (hereinafter referred to as “the device”, or the “controller”) is a new-generation pure hardware image processing device based on Field Programmable Gate Array (FPGA). Compared with the traditional controller, the device has a brand-new system structure and adopts data dual exchange technology to support large-capacity data transmission and processing. With high image processing performance, the device supports the access and real-time processing of multi-channel high definition and ultra-high definition signals. Adopting the main control board plus input and output board structure, which can be figured as required, the device supports multi-screen management. This product is mainly used in large-screen splicing control system and considered the core control device of the system.



## 1.2 Packing List

Table 1-1 Packing List

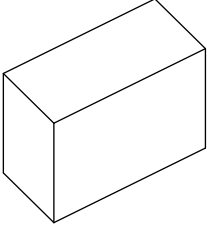
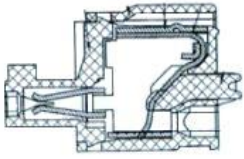
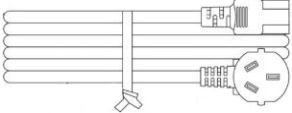
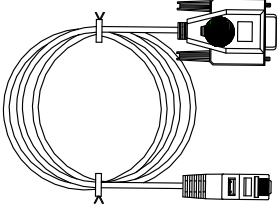
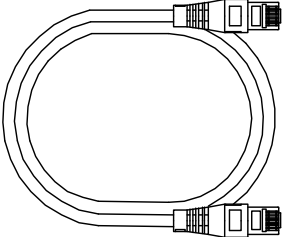
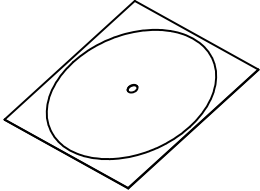
Item	Quantity	Device	Item	Quantity	Device	
 Redundant Power Supply	3	Chassis	 Connecting Terminal	1	Input Board	
 AC Power Cord	2					
 DB9 to RJ45 Converter	1					
 Network Cable	2					
 Disk	1					

## 1.3 Device Appearance

### 1.3.1 Host System

The front view of the host system.

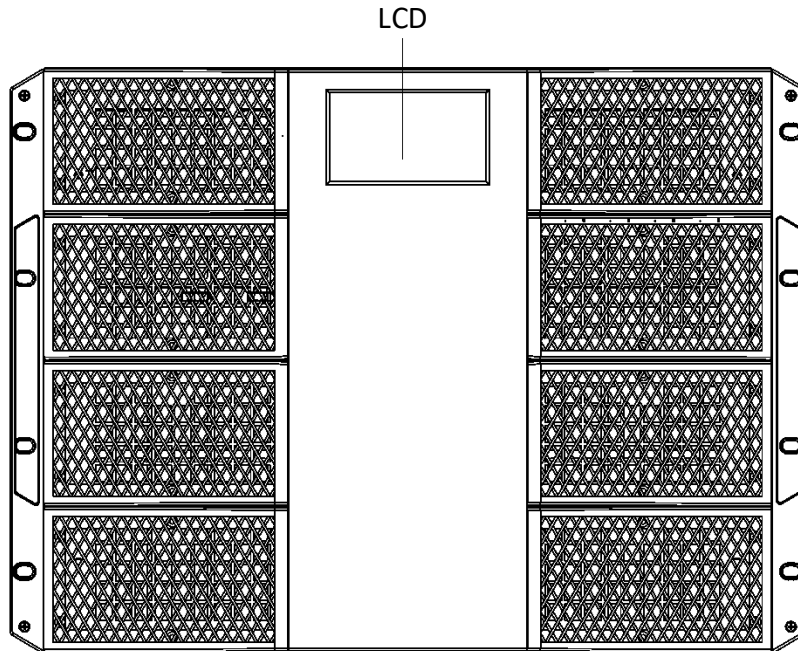

Figure 1-1 Front View

The rear view of the host system.

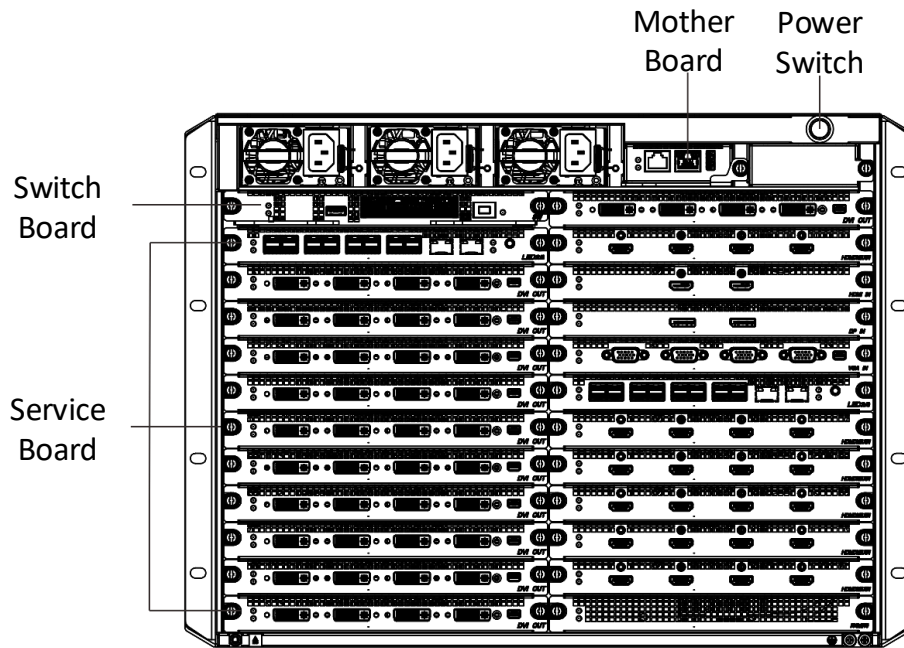

Figure 1-2 Rear View

### Main Control Board

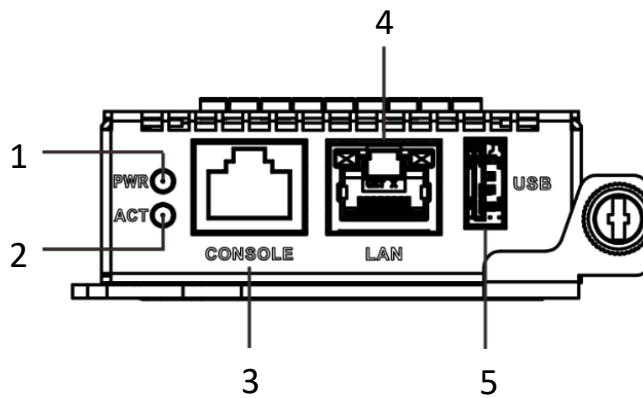

Figure 1-3 Front Panel of Main Control Board

Table 1-2 Main Control Board Interface Description

No.	Name	Description
1	PWR	Power indicator Solid green after the board is powered on.
2	ACT	Status indicator Flashing green when the board is functioning normally.
3	CONSOLE	Interface used for device debugging, parameter configuration, etc.
4	LAN	Reserved LAN interface Please connect to the network through the network interface of the switch board.
5	USB	USB 2.0 interface Used for connecting peripherals such as mouse, keyboard, USB disk, etc.

### Switch Board

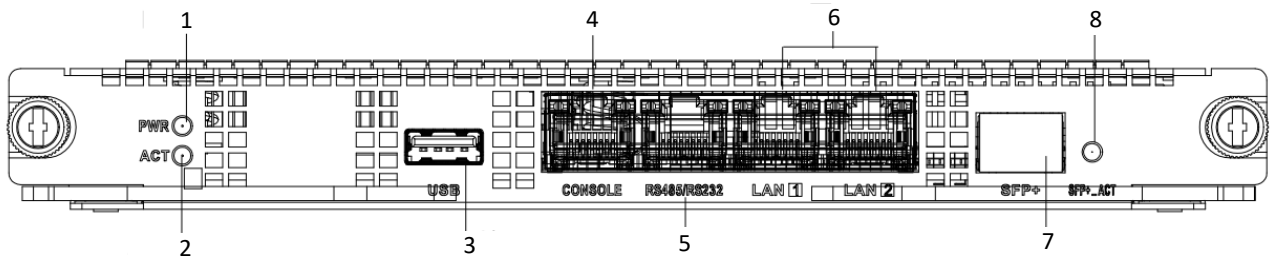

Figure 1-4 Switch Board

Table 1-3 Switch Board Interface Description

No.	Name	Description
1	PWR	Power indicator Solid green after the board is powered on.
2	ACT	Status indicator Flashing green when the board is functioning normally.
3	USB	Reserved USB 2.0 interface Used for connecting peripherals such as mouse, keyboard, U disk, etc.
4	CONSOLE	Interface used for device debugging, parameter configuration, etc.
5	RS485/RS232	RJ45 interface Used for screen control, serial port keyboard control, etc.
6	LAN	2 LAN interfaces Used for network connection.
7	SFP	Interface used for the insertion of one 10 Gigabit optical port module.
8	SFP ACT	Status indicator of SFP <ul style="list-style-type: none"> <li>• Lit when inserted with optical port module</li> <li>• Flashes during data transmission</li> </ul>

### 1.3.2 Functional Service Board

The device adopts a plug-in modular design. The host system is equipped with different service sub-boards to achieve different functions.

#### VGA Input Board

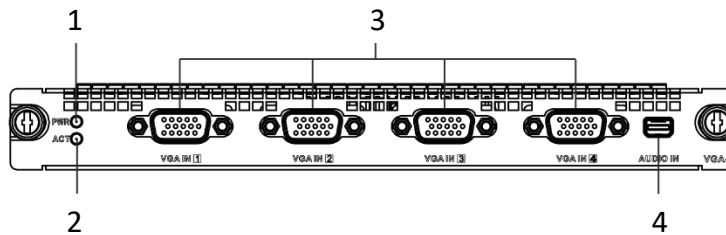

Figure 1-5 VGA Input Board

Table 1-4 VGA Input Board Interface Description

No.	Name	Description
1	PWR	Power indicator Solid green after the board is power-on.
2	ACT	Status indicator Flashing green when the board is functioning normally.
3	VGA IN	4 interfaces used for VGA video input.
4	AUDIO IN	Mini-DP four-in-one Line-in audio input interface Used for audio input with an external adapter cable.

### HDMI UHD Input Board

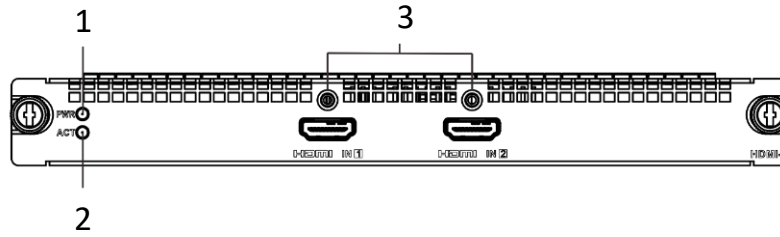

Figure 1-6 HDMI UHD Input Board

Table 1-5 HDMI UHD Input Board Interface Description

No.	Name	Description
1	PWR	Power indicator Solid green after the board is power-on.
2	ACT	Status indicator Flashing green when the board is functioning normally.
3	HDMI IN	2 HDMI Used for ultra-high-definition video input.

## DP Input Board

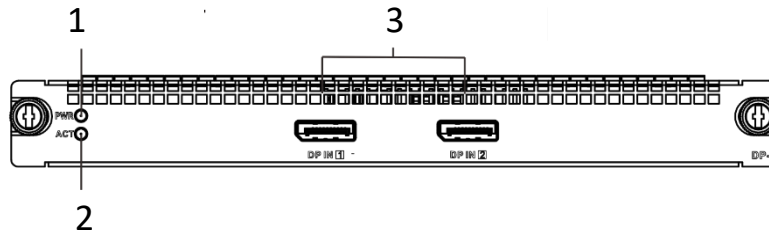

Figure 1-7 DP Input Board

Table 1-6 DP Input Board Interface Description

No.	Name	Description
1	PWR	Power indicator Solid green after the board is power-on.
2	ACT	Status indicator Flashing green when the board is functioning normally.
3	DP IN	2 DP interfaces Used for ultra-high-definition video input.

## DVI Input Board

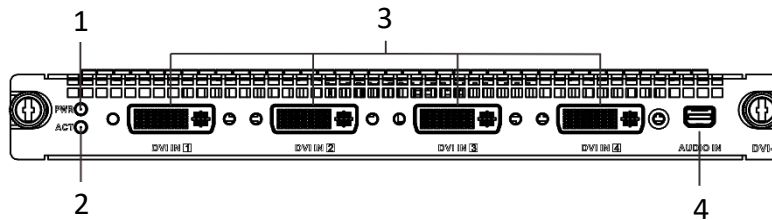

Figure 1-8 DVI Input Board

Table 1-7 DVI Input Board Interface Description

No.	Name	Description
1	PWR	Power indicator Solid green after the board is powered on.
2	ACT	Status indicator Flashing green when the board is functioning normally.
3	DVI IN	4 DVI IN Used for video input.
4	AUDIO IN	Mini-DP four-in-one Line-in audio input interface Used for audio input with an external adapter cable.

DVI Output Board

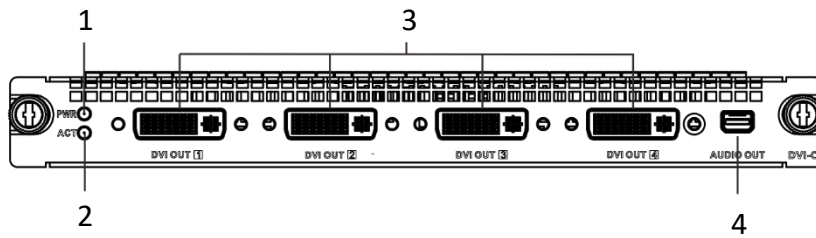

Figure 1-9 DVI Output Board

Table 1-8 DVI Output Board Interface Description

No.	Name	Description
1	PWR	Power indicator Solid green after the board is powered on.
2	ACT	Status indicator Flashing green when the board is functioning normally.
3	DVI OUT	4 DVI OUT Used for video output.
4	AUDIO OUT	Mini-DP four-in-one Line-in audio output interface Used for audio output with an external adapter cable.



### HDMI Input Board

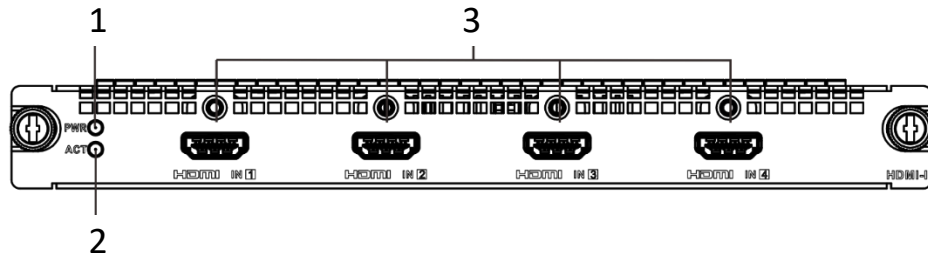

Figure 1-10 HDMI Input Board

Table 1-9 HDMI Input Board Interface Description

No.	Name	Description
1	PWR	Power indicator Solid green after the board is powered on.
2	ACT	Status indicator Flashing green when the board is functioning normally.
3	HDMI IN	4 HDMI IN Used for video input.

### HDMI Output Board

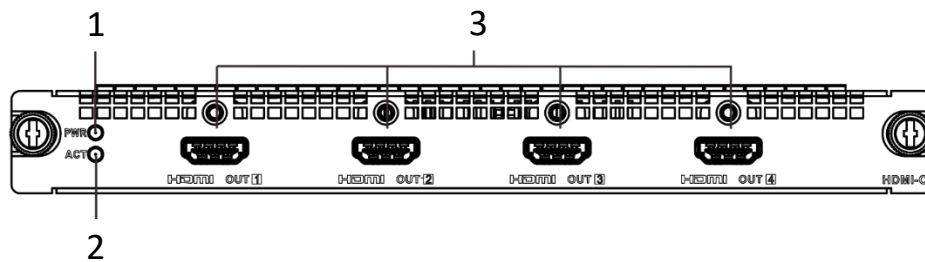

Figure 1-11 HDMI Output Board

Table 1-10 HDMI Output Board Interface Description

No.	Name	Description
1	PWR	Power indicator Solid green after the board is powered on.
2	ACT	Status indicator Flashing green when the board is functioning normally.
3	HDMI OUT	4 HDMI OUT Used for video output.

### 4K Output Board

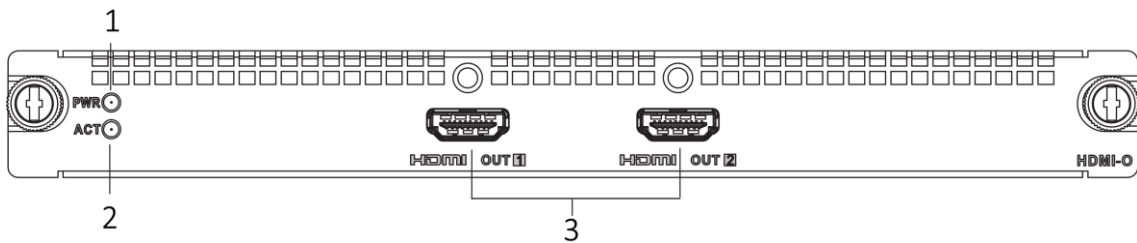

Figure 1-12 4K Output Board

Table 1-11 4K Output Board Interface Description

No.	Name	Description
1	PWR	Power indicator Solid green after the board is powered on.
2	ACT	Status indicator Flashing green when the board is functioning normally.
3	HDMI OUT	2 4K HDMI OUT Used for video output.

### Network Decoding Board

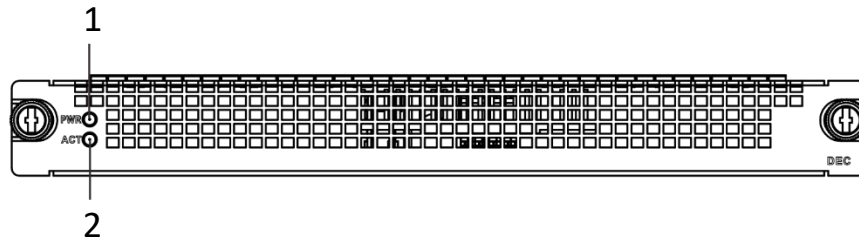

Figure 1-13 Network Decoding Board

Table 1-12 Network Decoding Board Interface Description

No.	Name	Description
1	PWR	Power indicator Solid green after the board is powered on.
2	ACT	Status indicator Flashing green when the board is functioning normally.

### LED Sending Card

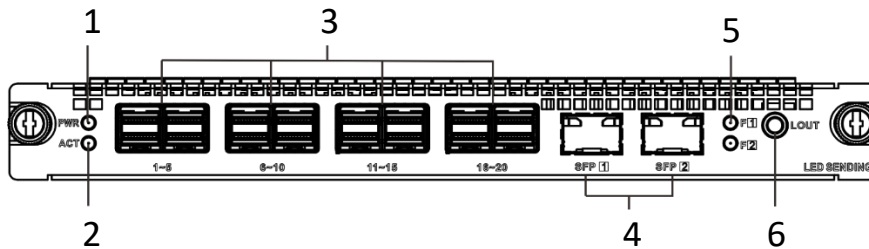

Figure 1-14 LED Sending Card

Table 1-13 LED Sending Card Interface Description

No.	Name	Description
1	PWR	Power indicator Solid green after the board is powered on.
2	ACT	Status indicator Flashing green when the board is functioning normally.
3	Gigabit Network Interface	20 Gigabit Ethernet interfaces Used for network connection through MiniSAS 8x to RJ45.
4	SFP	2 SFP interfaces Used for the insertion of 10 Gigabit optical port module.
5	SFP Indicator	Status indicator of SFP Turns steady green when SFP functions normally.
6	AUDIO OUT	Interfase used for Line-out audio output through left and right channels or two separate channels.

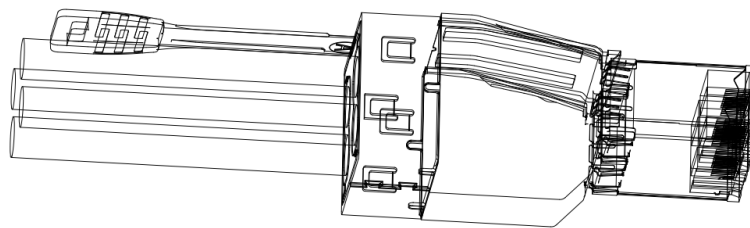

Figure 1-15 MiniSAS 8x to RJ45

## Chapter 2 Installation

### 2.1 Safety Precautions

---



As a high-precision, system-level electronic product, the controller should be installed and maintained by professionals.

---

In order to avoid personal and property injury, please read the safety precautions in this section carefully before installation. The following safety recommendations do not cover all possible dangerous situations.

#### Electricity Safety

- During the installation, wiring, disassembly, and maintenance of the device, please disconnect the power supply and do not operate with electricity (except for the operation of the hot plug).
- In the installation and use of the device, make sure to follow the local electrical safety regulations.
- Please use the power adapter provided with the device.
- In case of abnormal phenomena such as smoke or peculiar smell occur during the use of the device, please cut off the power immediately, unplug the power cord from the socket, and contact the after-sales service center in time.

#### Anti-Static Measures

The equipment is a precision electronic device. In order to avoid static electricity from damaging the components, in addition to anti-static measures in the installation room, you also need to pay attention to the following measures:

- During the installation process (especially when installing the main control board and the business board), you must wear anti-static gloves or anti-static wrists.
- When holding the main control board or the business board, try to avoid touching the components or printed circuits.

## Grounding Requirements

In order to ensure personal safety and device safety, the device must be grounded. See “2.3 for detailed steps.

## Power Supply Requirements

The device supports AC 106 ~ 240 V, 50/60 Hz power supply. It is recommended to use AC 220 V power supply. To ensure the stable operation of the device, it is recommended to install UPS for power supply.

## Anti-Interference Requirements

- The on-site power supply system must have effective measures to prevent grid interference.
- Do not use the working ground together with the grounding device or lightning protection grounding device of power equipment, and keep the two as far away as possible.
- Keep away from high-power radio transmitters, radar transmitters, and high-frequency and high-current equipment.
- When necessary, electromagnetic shielding can be used for anti-interference.

## Environmental Requirements

The device is a system-level monitoring equipment, which is generally placed in the central computer room of the monitoring system at all levels. The selection of the installation site should comply with the relevant standards of the computer room construction in the country and region of use.

The device is a standard rack-mounted equipment fixed in the cabinet. Please pay attention to the following information during installation and use:

- Ensure that the temperature in the cabinet is within the range of 0 °C to 50 °C.
- Ensure that the humidity in the equipment room is between 10% and 90% RH.
- Ensure that the cabinet is strong enough to support the weight of the video integrated platform and its accessories. Pay attention to avoid the danger caused by uneven mechanical load during the simultaneous installation.
- Ensure that there is enough installation space for the video and audio cables. The cable bending radius should not be less than 5 times the cable outer diameter.
- Keep the integrated platform a minimum 50 cm distance above the ground for sufficient ventilation.

## 2.2 Install Board Card

The device is of plug-in modular design. All functions are realized through the service board, and managed through the main control board. The basic steps to install the board card are illustrated as follows.

Step 1 Remove some (or all) baffle from the slots of the device as required.

Loosen the fixing screws on both sides with a screwdriver and pull out the baffle.

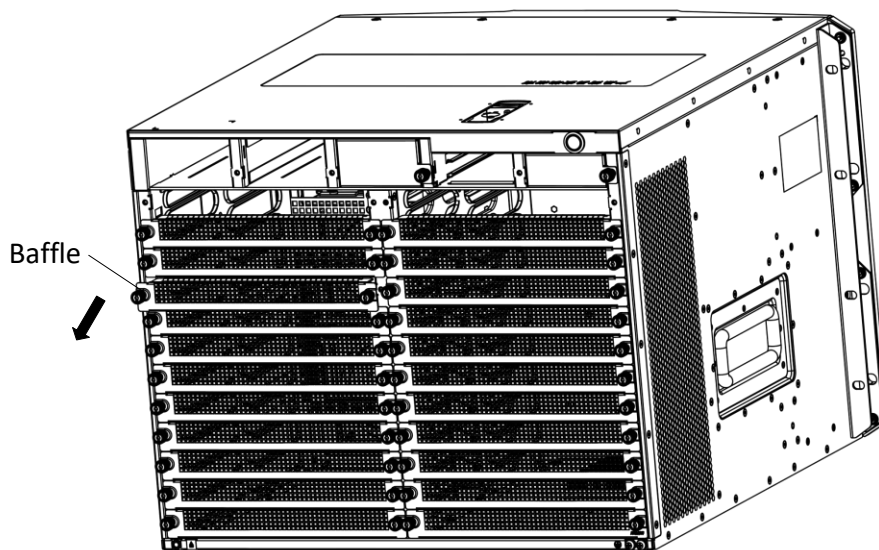

Figure 2-1 Remove the Baffle

---

 **Caution**

Do not remove the baffle from the slot where the board is not installed, so as not to affect the cooling air passage.

---

Step 2 Install the board. Take the installation of the service board as an example.

1. Insert the service board along the slot.

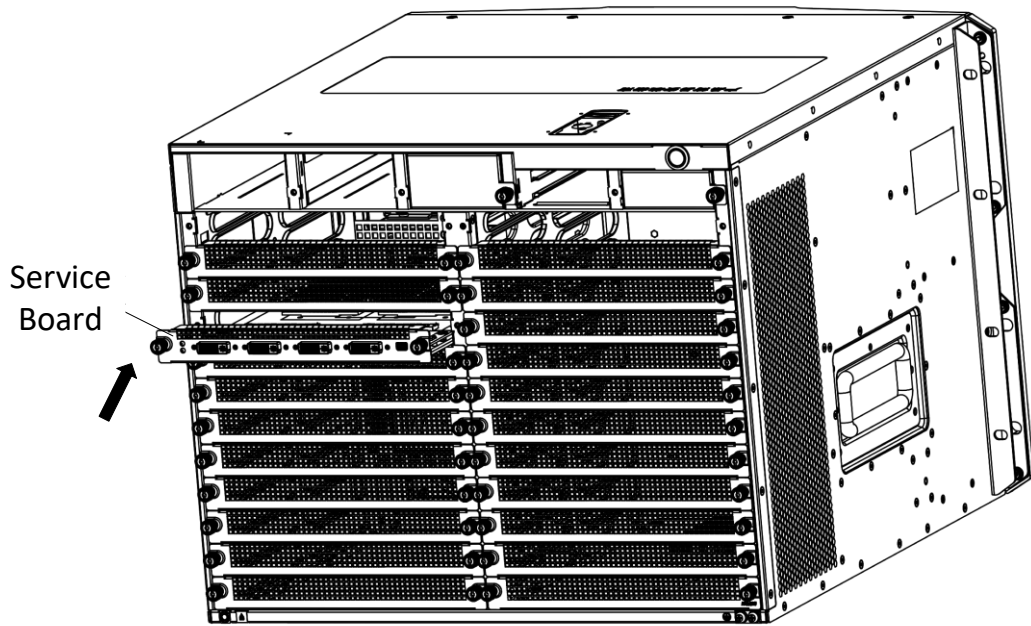

Figure 2-2 Insert the Service Board

2. Push the board to the innermost position.
3. Fix the screws on both sides with a screwdriver.

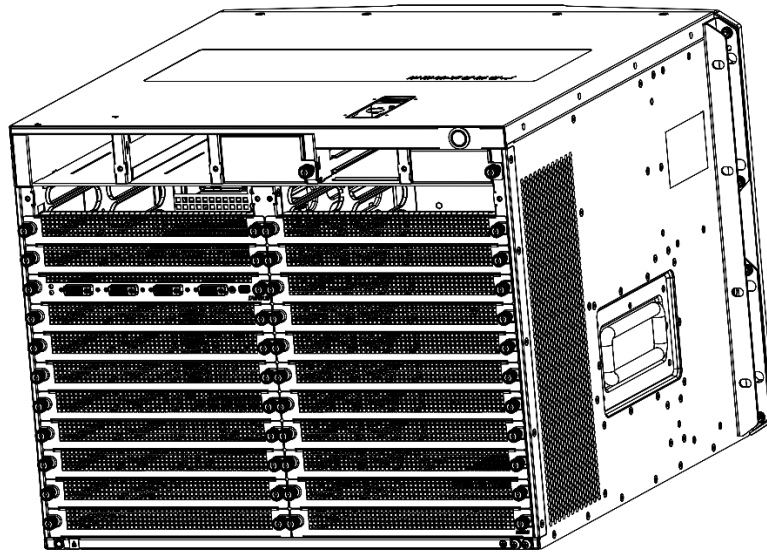

Figure 2-3 Installation Completed

## 2.3 Install Cabinet and Grounding

The device is designed in accordance with the 8U standard chassis structure. The installation process is as follows.



---

**! Caution**

The front and rear weights of the chassis are inconsistent. Please take safety precautions when lifting the chassis.

---

Step 1 Install the rack bracket on an empty slot of the rack (make sure it can bear the weight of the device), and fix it with screws.

Step 2 Place the device on the bracket, and fix the body mounting ears on the fixed guide grooves on both sides of the cabinet with screws.

The positions of the fixed screws for the chassis mounting ears are shown as follows.

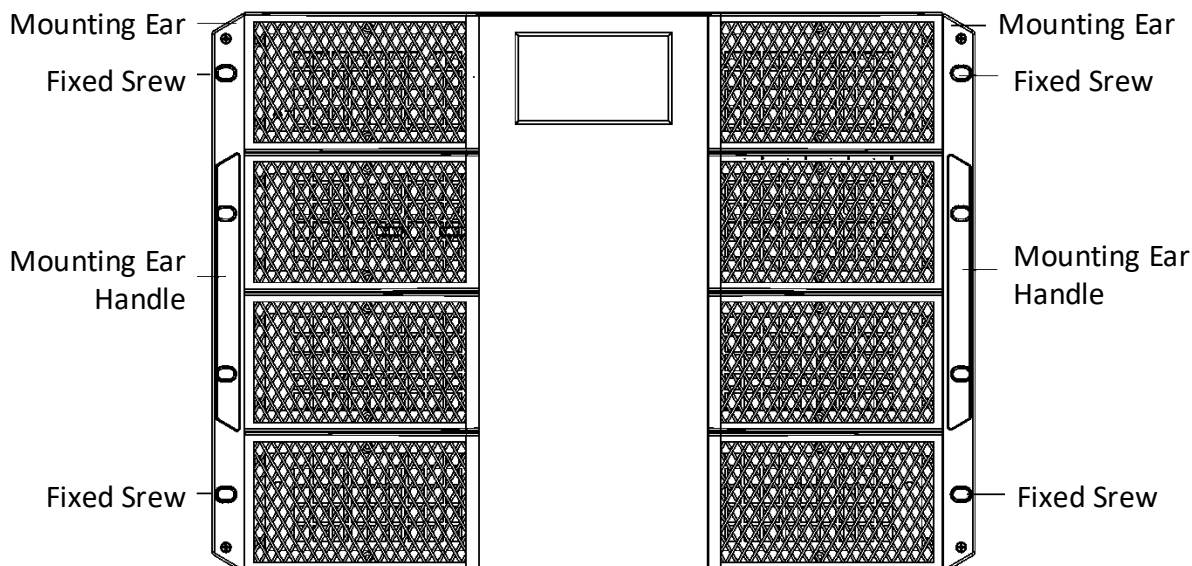

Figure 2-4 Locations of the Fixed Screws for the Chassis Mounting Ears

Step 3 Make reliable grounding between the grounding terminal of the device and the cabinet. The grounding point is located on the rear of the chassis.

---

**! Caution**

To ensure personal safety and equipment safety, the device must be grounded.

---

## 2.4 Connect Cables

### 2.4.1 Connect Network

The device is connected to the network through networking equipment such as switches. The following figure is an example of the switch board network connection.

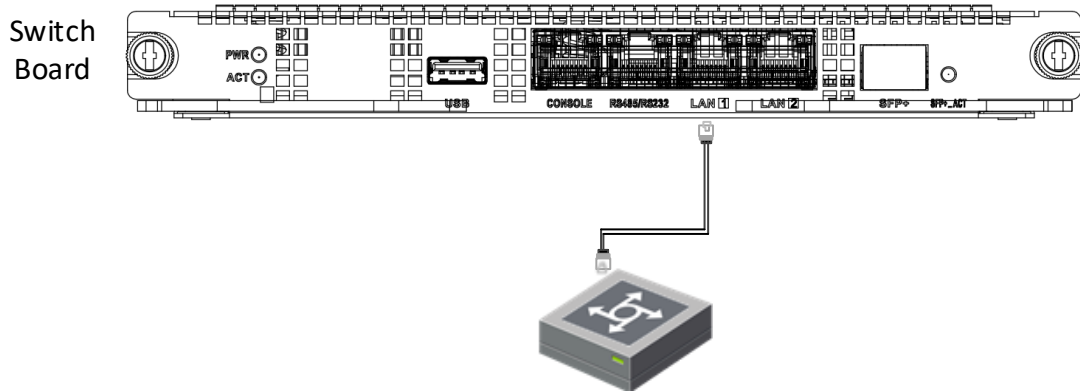

Figure 2-5 Switch Board Network Connection

**Caution**

- It is recommended to use Category 6 Ethernet cable for connection.
- The default configuration of the 2 Gigabit Ethernet ports on the device is not aggregated. Aggregation can be realized as long as the connected switch board is configured.

### 2.4.2 Connect Power Cord

Use three-phase power cord to connect the equipment power supply to the power supply socket in the server room.

The device is equipped with redundant dual power supplies, and both power interfaces need to be connected to power socket(s).

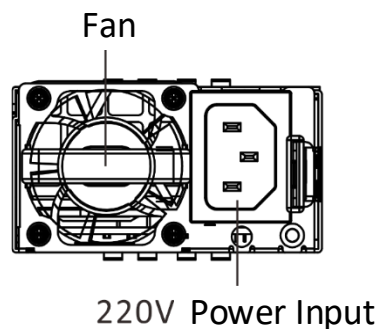

Figure 2-6 Power Supply

## 2.5 Power the Device On

You can start the device after the power cord is connected. Press and hold the power switch during operation to shut down the device. Short press the power switch in the shutdown state to start the device.

## Chapter 3 Get More Information

Scan the QR code below to get more information about the system operation and function configuration. Please refer to the actual device.

---



The following operations require network data traffic and are recommended to be performed in a Wi-Fi environment.

---

User Manual



Communication Matrix



Device Command



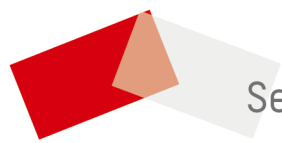

See Far, Go Further