

Dell EMC PowerEdge T350

Installation and Service Manual

Notes, cautions, and warnings

 **NOTE:** A NOTE indicates important information that helps you make better use of your product.

 **CAUTION:** A CAUTION indicates either potential damage to hardware or loss of data and tells you how to avoid the problem.

 **WARNING:** A WARNING indicates a potential for property damage, personal injury, or death.

Chapter 1: About this document	7
Chapter 2: PowerEdge T350 system overview	8
Front view of the system.....	9
Rear view of the system.....	12
Inside the system	16
Locating the Express Service Code and Service Tag.....	17
System information label.....	18
Chapter 3: Initial system setup and configuration	21
Setting up the system.....	21
iDRAC configuration.....	21
Options to set up iDRAC IP address.....	21
Options to log in to iDRAC.....	22
Resources to install operating system.....	23
Options to download firmware	23
Options to download and install OS drivers	23
Downloading drivers and firmware.....	24
Chapter 4: Minimum to POST and system management configuration validation	25
Minimum configuration to POST	25
Configuration validation.....	25
Error messages.....	26
Chapter 5: Installing and removing system components	27
Safety instructions.....	27
Before working inside your system.....	28
After working inside your system.....	28
Recommended tools.....	28
Optional front bezel.....	28
Removing the front bezel.....	28
Installing the front bezel.....	29
System feet.....	30
Removing the system feet.....	30
Installing the system feet.....	31
System cover.....	32
Removing the system cover.....	32
Installing the system cover.....	33
Air shroud.....	35
Removing the air shroud.....	35
Installing the air shroud.....	35
Intrusion switch module.....	36
Removing the intrusion switch module.....	36
Installing the intrusion switch module.....	37

Drives.....	38
Removing a drive blank.....	38
Installing a drive blank.....	38
Removing a drive carrier.....	39
Installing the drive carrier.....	40
Removing the drive from the drive carrier.....	41
Installing the drive into the drive carrier.....	42
Removing a 3.5-inch drive adapter from a 3.5-inch drive carrier.....	43
Installing a 3.5-inch adapter into a 3.5-inch drive carrier.....	44
Removing a 2.5-inch drive from the 3.5-inch drive adapter.....	45
Installing a 2.5-inch drive into the 3.5-inch drive adapter.....	46
Optional optical drive.....	47
Removing the optical drive blank.....	47
Installing the optical drive blank.....	48
Removing the optical drive.....	49
Installing the optical drive.....	50
Drive backplane.....	51
Drive backplane.....	51
Removing the drive backplane	53
Installing the drive backplane.....	53
Cooling fans.....	54
Removing the cooling fan.....	54
Installing the cooling fan.....	55
Cable routing.....	56
System memory.....	59
System memory guidelines.....	59
General memory module installation guidelines.....	60
Removing a memory module.....	60
Installing a memory module.....	61
Processor and heat sink module.....	63
Removing the heat sink.....	63
Removing the processor.....	64
Installing the processor.....	64
Installing the heat sink.....	65
Expansion cards.....	67
Expansion card installation guidelines.....	67
Removing an expansion card.....	68
Installing an expansion card.....	70
Optional BOSS S2 module.....	71
Removing the BOSS S2 module blank.....	71
Installing the BOSS S2 module blank.....	72
Removing the BOSS S2 card carrier blank.....	73
Installing the BOSS S2 card carrier blank.....	74
Removing the BOSS S2 module.....	75
Installing the BOSS S2 module.....	78
Optional IDSDM module.....	81
Removing the IDSDM module.....	81
Installing the IDSDM module.....	82
MicroSD card.....	83
Removing the MicroSD card.....	83

Installing the MicroSD card.....	84
Optional internal USB card.....	85
Removing the internal USB card.....	85
Installing the internal USB card.....	86
Optional internal USB memory key.....	87
Removing the internal USB memory key.....	87
Installing the internal USB memory key	87
Power supply unit.....	88
Hot spare feature.....	88
Removing a power supply unit blank.....	88
Installing a power supply unit blank.....	89
Removing a power supply unit.....	89
Installing a power supply unit.....	90
Removing a cabled PSU.....	91
Installing the cabled PSU.....	93
Power interposer board.....	94
Removing the power interposer board.....	94
Installing the power interposer board.....	95
System battery	96
Replacing the system battery.....	96
System board.....	98
Removing the system board.....	98
Installing the system board.....	100
Trusted Platform Module.....	104
Upgrading the Trusted Platform Module.....	104
Initializing TPM for users.....	105
Initializing the TPM 1.2 for users.....	105
Initializing the TPM 2.0 for users.....	105
Control panel.....	105
Removing the control panel assembly.....	105
Installing the control panel assembly.....	108
Chapter 6: Upgrade Kits.....	112
BOSS S2 module kit.....	112
IDSDM kit.....	115
Internal USB card kit.....	116
Chapter 7: Jumpers and connectors.....	117
System board connectors.....	117
System board jumper settings.....	118
Disabling a forgotten password.....	119
Chapter 8: System diagnostics and indicator codes.....	120
System health and system ID indicator codes.....	120
iDRAC Direct LED indicator codes.....	120
NIC indicator codes.....	121
Power supply unit indicator codes.....	121
Non-redundant cabled power supply unit indicator codes.....	123
Drive indicator codes.....	124

Using system diagnostics.....	125
Dell Embedded System Diagnostics.....	125
Chapter 9: Getting help.....	126
Recycling or End-of-Life service information.....	126
Contacting Dell Technologies.....	126
Accessing system information by using QRL.....	126
Quick Resource Locator for PowerEdge T350 system.....	127
Receiving automated support with SupportAssist	127
Chapter 10: Documentation resources.....	128

About this document

This document provides an overview about the system, information about installing and replacing components, diagnostic tools, and guidelines to be followed while installing certain components.

PowerEdge T350 system overview

The PowerEdge T350 system is a 4.5U tower server that supports:

- One Intel Xeon E-2300 Series processor or Intel Pentium processor
- Four DDR4 DIMM slots
- Two redundant or one cabled AC power supply units
- Up to eight 3.5-inch SAS/SATA hot swap drives

i **NOTE:** All instances of SAS, SATA drives are seen as drives in this document, unless specified otherwise.

i **NOTE:** For more information, see the *Dell EMC PowerEdge T350 Technical Specifications* on the product documentation page.

Topics:

- [Front view of the system](#)
- [Rear view of the system](#)
- [Inside the system](#)
- [Locating the Express Service Code and Service Tag](#)
- [System information label](#)

Front view of the system

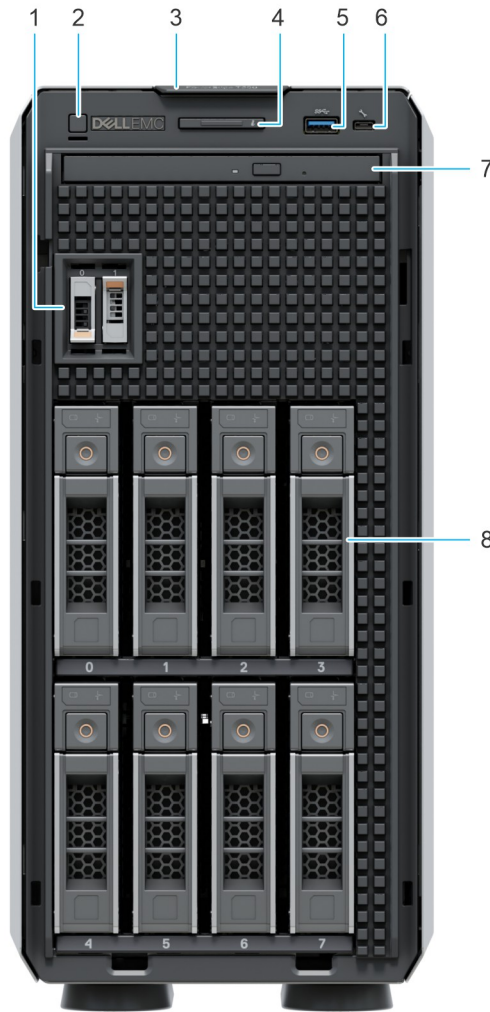

Figure 1. Front view of 8 x 3.5-inch drive system

Table 1. Features available on the front of the system





Item	Ports, panels, and slots	Icon	Description
1	BOSS S2 module (optional)	N/A	This slot supports BOSS S2 module.
2	Power button		Indicates if the system is powered on or off. Press the power button to manually power on or off the system. NOTE: Press the power button to gracefully shut down an ACPI-compliant operating system.
3	Information tag	N/A	The Information tag is a slide-out label panel that contains system information such as Service Tag, NIC, MAC address, and so on. If you have opted for the secure default access to iDRAC, the Information tag will also contain the iDRAC secure default password.
4	System health and ID indicator		Indicates the system health. For more information, see the System health and system ID indicator codes section.

Table 1. Features available on the front of the system (continued)

Item	Ports, panels, and slots	Icon	Description
5	USB 3.0 port		The USB ports are 9-pin, 3.0-compliant. These ports enable you to connect USB devices to the system.
6	iDRAC Direct port (Micro-AB USB)		The iDRAC Direct port is micro USB 2.0-compliant. This port enables you to access the iDRAC Direct features. For more information, see the <i>Integrated Dell Remote Access Controller User's Guide</i> at www.dell.com/poweredgemanuals . NOTE: You can configure iDRAC Direct by using a USB to micro USB (type AB) cable, which you can connect to your laptop or tablet. Cable length should not exceed 3 feet (0.91 meters). Performance could be affected by cable quality.
7	Optical drive (optional)	N/A	Enables you to retrieve and store data on optical discs such as compact discs (CD) and digital versatile discs (DVD). For more information, see the Technical specifications section.
8	Drives (8)	N/A	Enable you to install drives that are supported on your system. For more information about drives, see the Technical specifications section.

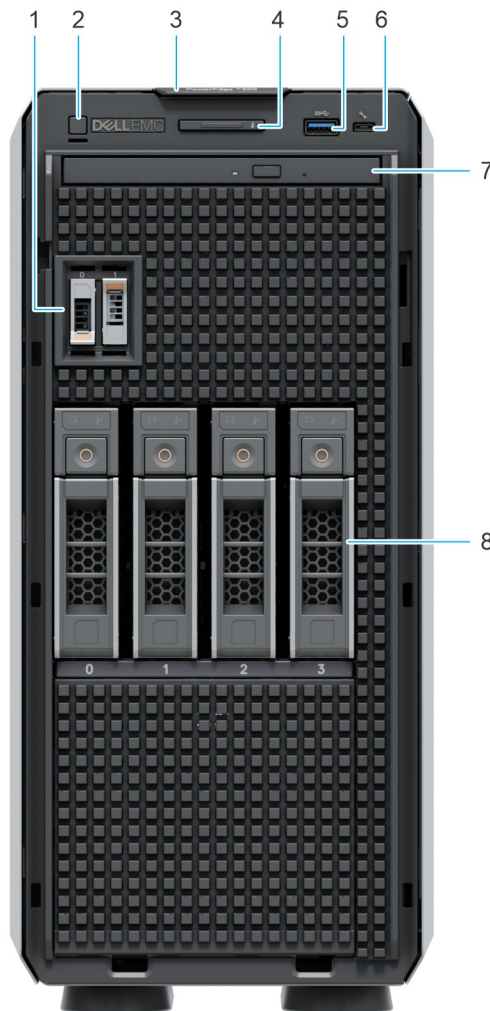





Figure 2. Front view of 4 x 3.5-inch drive system

Table 2. Features available on the front of the system

Item	Ports, panels, and slots	Icon	Description
1	BOSS S2 module (optional)	N/A	This slot supports BOSS S2 module.
2	Power button		Indicates if the system is powered on or off. Press the power button to manually power on or off the system. NOTE: Press the power button to gracefully shut down an ACPI-compliant operating system.
3	Information tag	N/A	The Information tag is a slide-out label panel that contains system information such as Service Tag, NIC, MAC address, and so on. If you have opted for the secure default access to iDRAC, the Information tag will also contain the iDRAC secure default password.
4	System health and ID indicator		Indicates the system health. For more information, see the System health and system ID indicator codes section.
5	USB 3.0 port		The USB ports are 9-pin, 3.0-compliant. These ports enable you to connect USB devices to the system.
6	iDRAC Direct port (Micro-AB USB)		The iDRAC Direct port is micro USB 2.0-compliant. This port enables you to access the iDRAC Direct features. For more information, see the <i>Integrated Dell Remote Access Controller User's Guide</i> at www.dell.com/poweredgemanuals . NOTE: You can configure iDRAC Direct by using a USB to micro USB (type AB) cable, which you can connect to your laptop or tablet. Cable length should not exceed 3 feet (0.91 meters). Performance could be affected by cable quality.
7	Optical drive (optional)	N/A	Enables you to retrieve and store data on optical discs such as compact discs (CD) and digital versatile discs (DVD). For more information, see the Technical specifications section.
8	Drives (4)	N/A	Enable you to install drives that are supported on your system. For more information about drives, see the Technical specifications section.

NOTE: For more information, see the *Dell EMC PowerEdge T350 Technical Specifications* on the product documentation page.

Rear view of the system

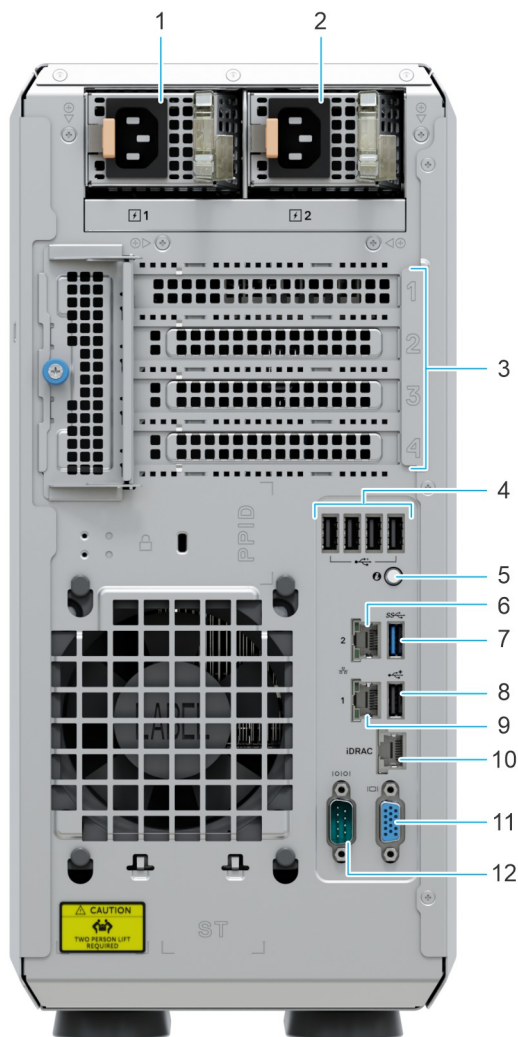

Figure 3. Rear view of the system with redundant PSU

Table 3. Rear view of the system











Item	Ports, panels, or slots	Icon	Description
1	Power supply unit (PSU 1)		PSU1 is the primary PSU of the system. For more information about the PSU configurations, see the <i>Dell EMC PowerEdge T350 Technical Specifications</i> on product documentation page.
2	Power supply unit (PSU 2)		This is a secondary PSU or redundant PSU. For more information about the PSU configurations, see the <i>Dell EMC PowerEdge T350 Technical Specifications</i> on product documentation page.
3	PCIe expansion card slots (4)	N/A	Enables you to connect PCI Express expansion cards. For more information about the expansion cards supported on your system, see the expansion card installation guidelines section.
4	USB 2.0 port (4)		The USB ports are 4-pin, 2.0-compliant. These ports enable you to connect USB devices to the system.

Table 3. Rear view of the system (continued)

Item	Ports, panels, or slots	Icon	Description
5	System identification button		<p>Press the system ID button:</p> <ul style="list-style-type: none"> To locate a particular system within a rack. To turn the system ID on or off. <p>To reset iDRAC, press and hold the button for 16 seconds.</p> <p>NOTE:</p> <ul style="list-style-type: none"> To reset iDRAC using system ID, ensure that the system ID button is enabled in the iDRAC setup. If the system stops responding during POST, press and hold the system ID button (for more than five seconds) to enter the BIOS progress mode.
6	NIC port (1)		The NIC ports are embedded on the LOM card that is connected to the system board.
7	USB 3.0 port (1)		The USB ports are 9-pin, 3.0-compliant. These ports enable you to connect USB devices to the system.
8	USB 2.0 port (1)		The USB ports are 4-pin, 2.0-compliant. These ports enable you to connect USB devices to the system.
9	NIC port (2)		The NIC ports are embedded on the LOM card that is connected to the system board.
10	iDRAC ethernet port	iDRAC	Enables you to remotely access iDRAC. For more information, see the <i>Integrated Dell Remote Access Controller User's Guide</i> at www.dell.com/poweredgemanuals .
11	VGA port		Enables you to connect a display device to the system. For more information about the VGA port, see the <i>Dell EMC PowerEdge T350 Technical Specifications</i> on product documentation page.
12	Serial port		Enables you to connect a serial device to the system. For more information about the Serial port, see the <i>Dell EMC PowerEdge T350 Technical Specifications</i> on product documentation page.

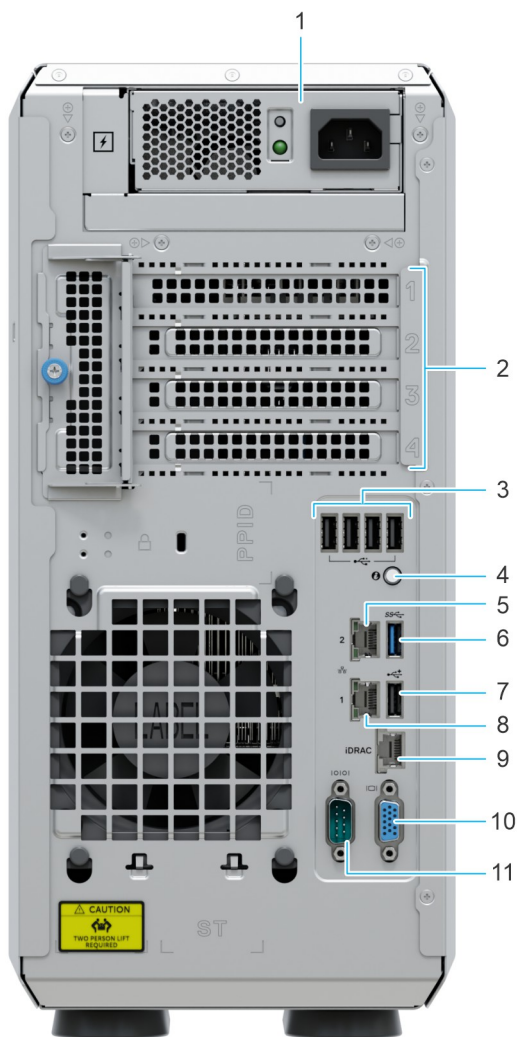

Figure 4. Rear view of the system with cable PSU

Table 4. Rear view of the system









Item	Ports, panels, or slots	Icon	Description
1	Cabled power supply unit		Enables you to connect to AC power source. For more information about the PSU configurations, see the <i>Dell EMC PowerEdge T350 Technical Specifications</i> on product documentation page.
2	PCIe expansion card slots (4)	N/A	Enables you to connect PCI Express expansion cards. For more information about the expansion cards supported on your system, see the expansion card installation guidelines section.
3	USB 2.0 port (4)		The USB ports are 4-pin, 2.0-compliant. These ports enable you to connect USB devices to the system.
4	System identification button		Press the system ID button: <ul style="list-style-type: none"> To locate a particular system within a rack. To turn the system ID on or off. To reset iDRAC, press and hold the button for 16 seconds. <p>NOTE:</p> <ul style="list-style-type: none"> To reset iDRAC using system ID, ensure that the system ID button is enabled in the iDRAC setup.

Table 4. Rear view of the system (continued)

Item	Ports, panels, or slots	Icon	Description
			<ul style="list-style-type: none"> If the system stops responding during POST, press and hold the system ID button (for more than five seconds) to enter the BIOS progress mode.
5	NIC port (1)		The NIC ports are embedded on the LOM card that is connected to the system board.
6	USB 3.0 port (1)		The USB ports are 9-pin, 3.0-compliant. These ports enable you to connect USB devices to the system.
7	USB 2.0 port (1)		The USB ports are 4-pin, 2.0-compliant. These ports enable you to connect USB devices to the system.
8	NIC port (2)		The NIC ports are embedded on the LOM card that is connected to the system board.
9	iDRAC ethernet port	iDRAC	Enables you to remotely access iDRAC. For more information, see the <i>Integrated Dell Remote Access Controller User's Guide</i> at www.dell.com/poweredgemanuals .
10	VGA port		Enables you to connect a display device to the system. For more information about the VGA port, see the <i>Dell EMC PowerEdge T350 Technical Specifications</i> on product documentation page.
11	Serial port		Enables you to connect a serial device to the system. For more information about the Serial port, see the <i>Dell EMC PowerEdge T350 Technical Specifications</i> on product documentation page.

Inside the system

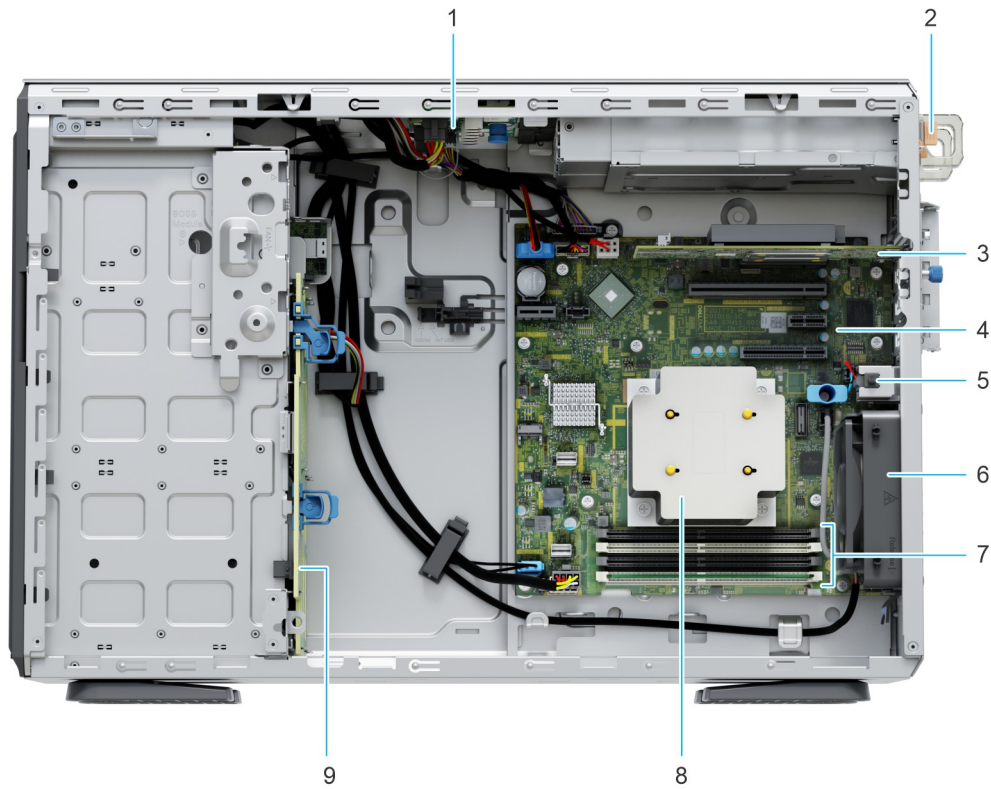

Figure 5. Inside the system with redundant PSU

- | | |
|--------------------------------|-----------------|
| 1. PIB (Power Interface Board) | 2. PSU |
| 3. PCIe expansion card | 4. System board |
| 5. Intrusion switch | 6. Cooling fan |
| 7. Memory module sockets | 8. Heat sink |
| 9. Backplane | |

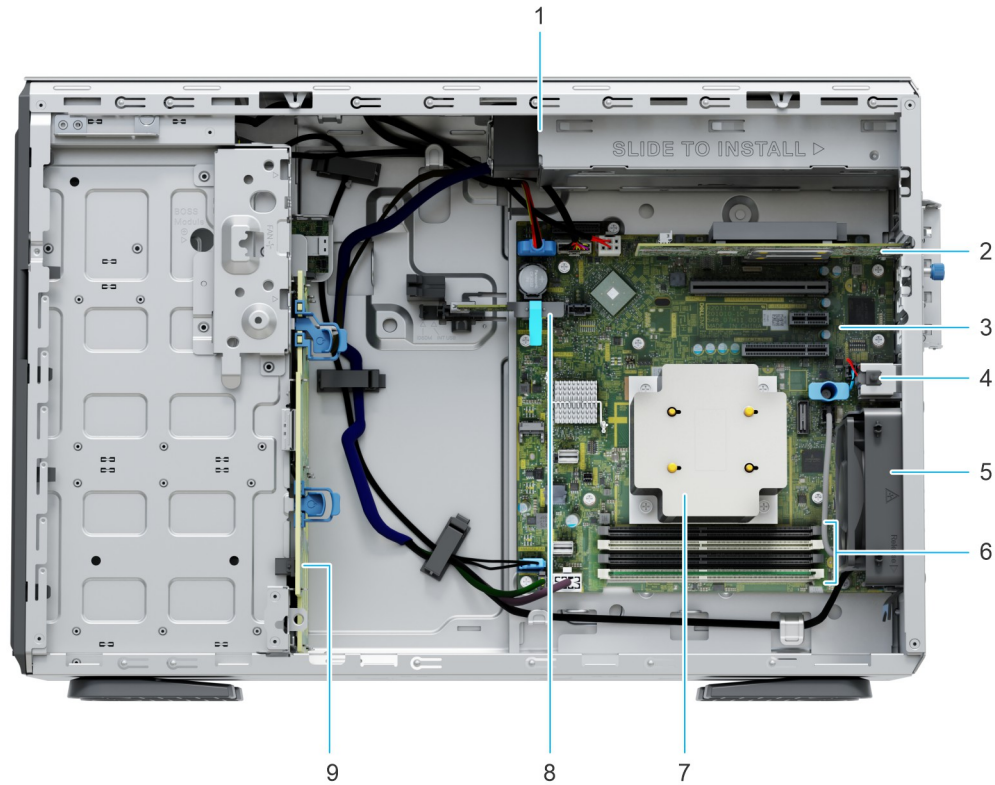

Figure 6. Inside the system with cabled PSU

- | | |
|-----------------|--|
| 1. Cabled PSU | 2. PCIe expansion card |
| 3. System board | 4. Intrusion switch |
| 5. Cooling fan | 6. Memory module sockets |
| 7. Heat sink | 8. Internal Dual SD module (IDSDM)/USB card (optional) |
| 9. Backplane | |

Locating the Express Service Code and Service Tag

The unique Express Service Code and Service Tag are used to identify the system.

The information tag is located on the front of the system that includes system information such as the Service Tag, Express Service Code, Manufacture date, NIC, MAC address, QRL label, and so on. If you have opted for the secure default access to iDRAC, the Information tag also contains the iDRAC secure default password.

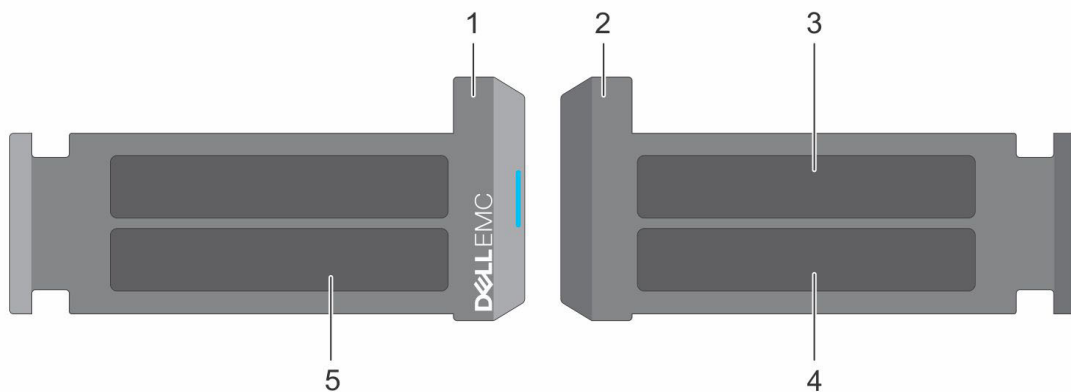

Figure 7. Locating the Express Service Code and Service tag

1. Information tag (front view)

2. Information tag (back view)
3. OpenManage Mobile (OMM) label
4. iDRAC MAC address and iDRAC secure password label
5. Service Tag, Express Service Code, QRL label

The Mini Enterprise Service Tag (MEST) label is located on the rear of the system that includes the Service Tag (ST), Express Service Code (Exp Svc Code), and Manufacture Date (Mfg. Date). The Exp Svc Code is used by Dell EMC to route support calls to the appropriate personnel.

Alternatively, the Service Tag information is located on a label on the rear of the chassis.

System information label

The system information label is located on the back of the system cover.

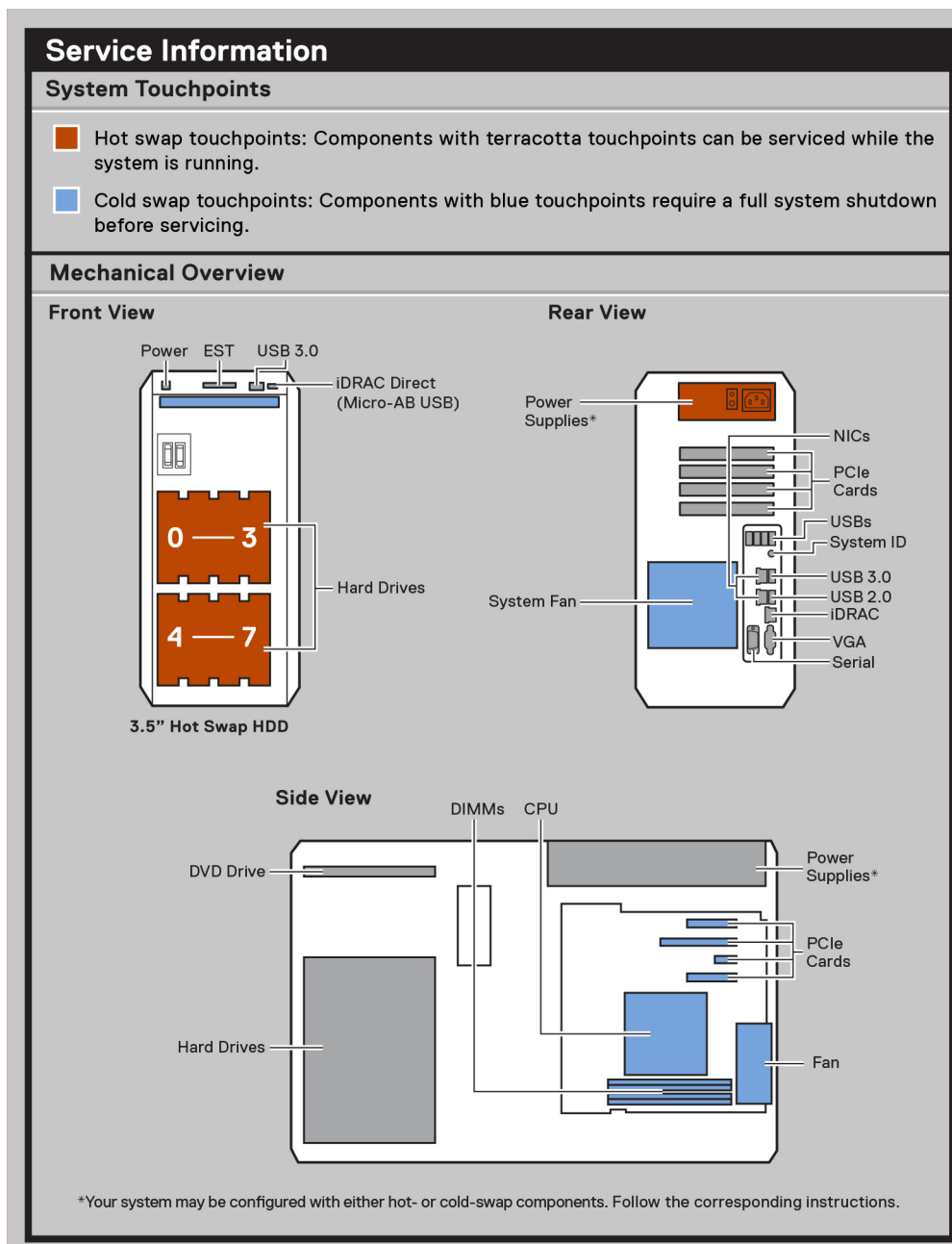

Figure 8. Service information

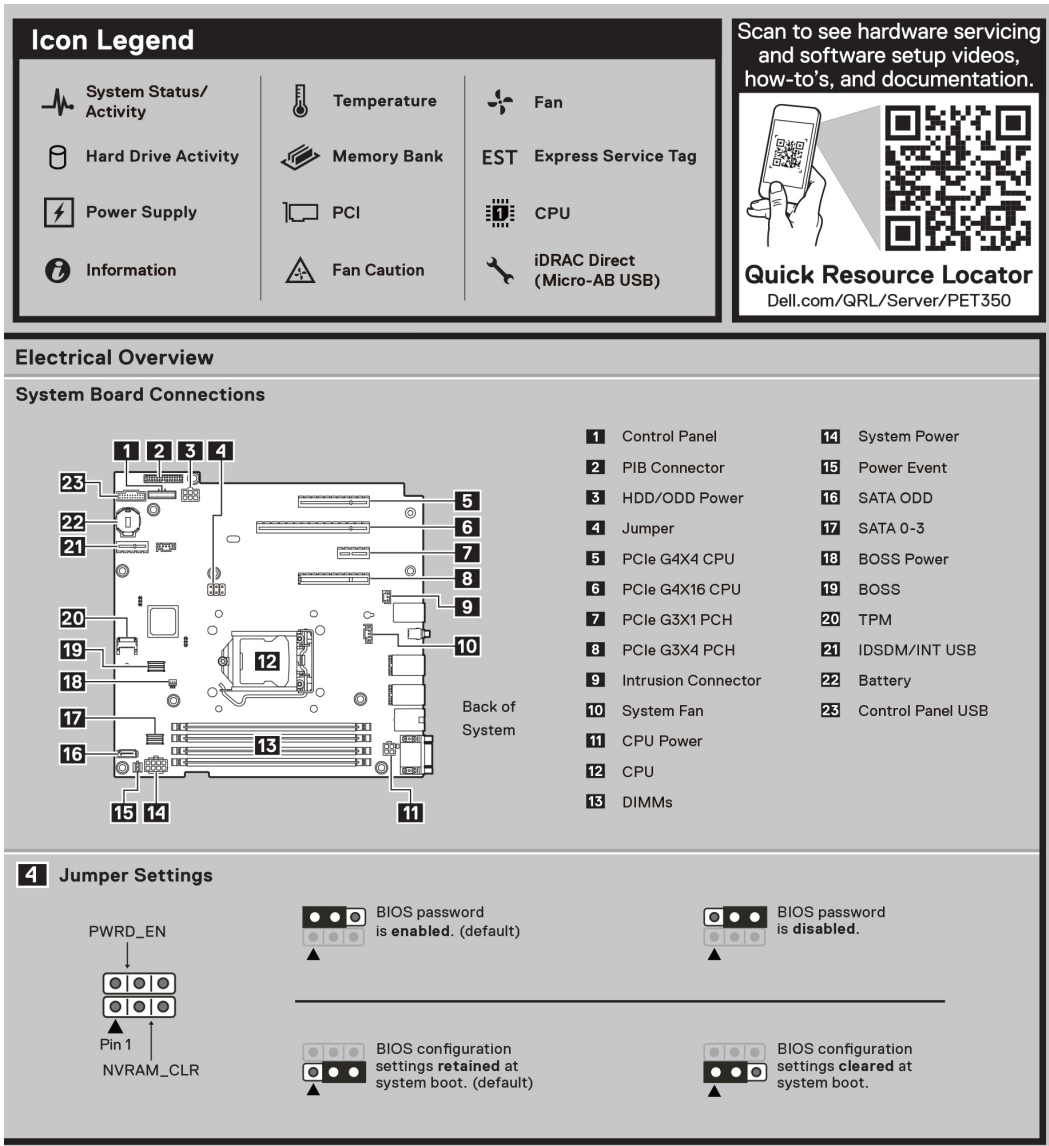

Figure 9. Electrical overview and icon legend

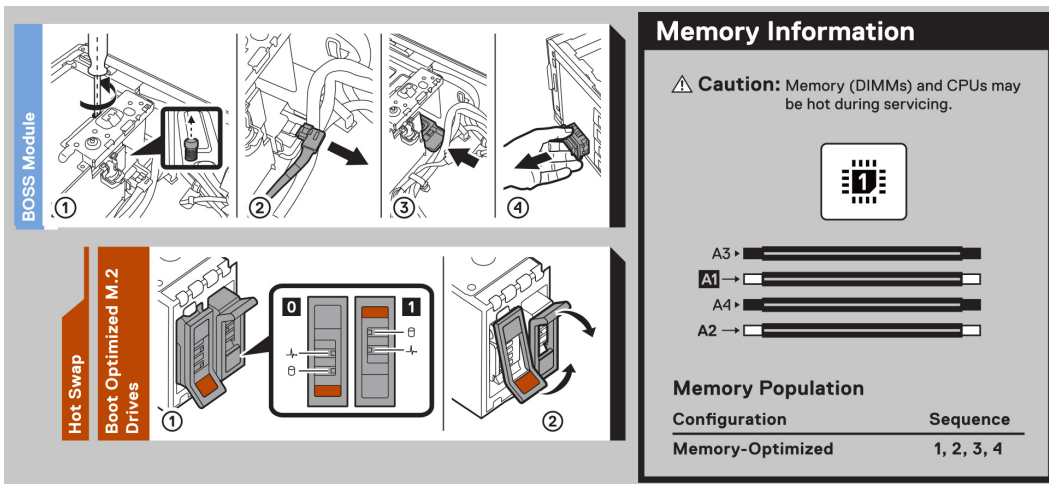

Figure 10. Memory information and system tasks

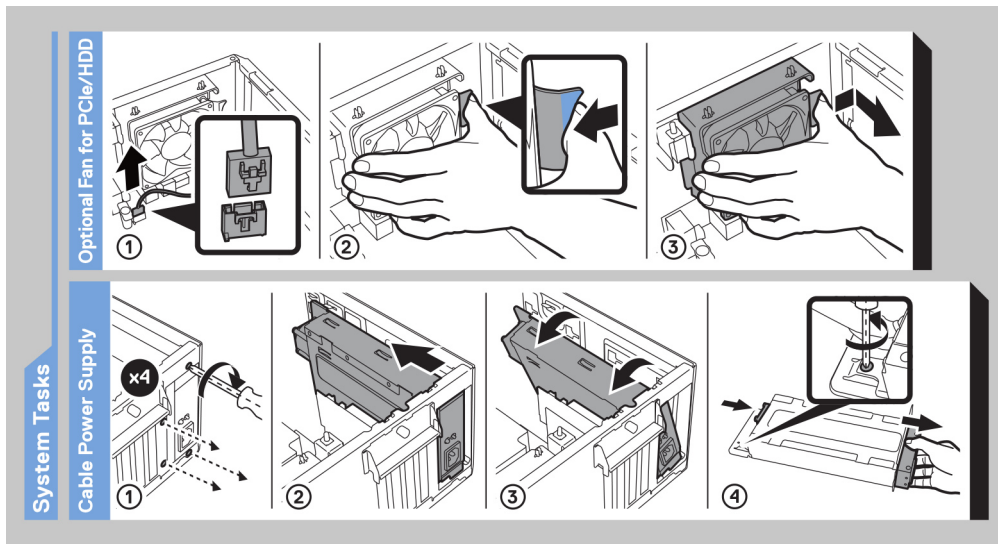

Figure 11. System tasks

Initial system setup and configuration

This section describes the tasks for initial setup and configuration of the Dell EMC system. The section also provides general steps to set up the system and the reference guides for detailed information.

Topics:

- [Setting up the system](#)
- [iDRAC configuration](#)
- [Resources to install operating system](#)

Setting up the system

Perform the following steps to set up the system:

Steps

1. Unpack the system.
2. Connect the peripherals to the system and the system to the electrical outlet.
3. Power on the system.

For more information about setting up the system, see the *Getting Started Guide* that is shipped with your system.

i **NOTE:** For information about managing the basic settings and features of the system, see the *Dell EMC PowerEdge T350 BIOS and UEFI Reference Guide* on the product documentation page.

iDRAC configuration

The Integrated Dell Remote Access Controller (iDRAC) is designed to make you more productive as a system administrator and improve the overall availability of Dell EMC servers. iDRAC alerts you to system issues, helps you to perform remote management, and reduces the need for physical access to the system.

Options to set up iDRAC IP address

To enable communication between your system and iDRAC, you must first configure the network settings based on your network infrastructure. The network settings option is set to **DHCP**, by default.

i **NOTE:** For static IP configuration, you must request for the settings at the time of purchase.

You can set up the iDRAC IP address using one of the interfaces in the table below. For information about setting up iDRAC IP address, see the documentation links provided in the table below.

Table 5. Interfaces to set up iDRAC IP address

Interface	Documentation links
iDRAC Settings utility	<p><i>Integrated Dell Remote Access Controller User's Guide</i> at https://www.dell.com/idracmanuals or for system specific <i>Integrated Dell Remote Access Controller User's Guide</i>, go to https://www.dell.com/poweredgemanuals > Product Support page of your system > Documentation.</p> <p>i NOTE: To determine the most recent iDRAC release for your platform and for latest documentation version,</p>

Table 5. Interfaces to set up iDRAC IP address (continued)

Interface	Documentation links
	see KB article https://www.dell.com/support/article/sln308699 .
OpenManage Deployment Toolkit	<i>Dell EMC OpenManage Deployment Toolkit User's Guide</i> available at https://www.dell.com/openmanagemanuals > Open Manage Deployment Toolkit.
iDRAC Direct	<i>Integrated Dell Remote Access Controller User's Guide</i> at https://www.dell.com/idracmanuals or for system specific <i>Integrated Dell Remote Access Controller User's Guide</i> , go to https://www.dell.com/poweredgemanuals > Product Support page of your system > Documentation . <i>i</i> NOTE: To determine the most recent iDRAC release for your platform and for latest documentation version, see KB article https://www.dell.com/support/article/sln308699 .
Lifecycle Controller	<i>Lifecycle Controller User's Guide</i> at https://www.dell.com/idracmanuals or for system specific <i>Lifecycle Controller User's Guide</i> , go to https://www.dell.com/poweredgemanuals > Product Support page of your system > Documentation . <i>i</i> NOTE: To determine the most recent iDRAC release for your platform and for latest documentation version, see KB article https://www.dell.com/support/article/sln308699 .

i **NOTE:** To access iDRAC, ensure that you connect the ethernet cable to the iDRAC dedicated network port or use the iDRAC Direct port by using the USB cable. You can also access iDRAC through the shared LOM mode, if you have opted for a system that has the shared LOM mode enabled.

Options to log in to iDRAC

To log in to the iDRAC Web User Interface, open a browser and enter the IP address.

You can log in to iDRAC as:

- iDRAC user
- Microsoft Active Directory user
- Lightweight Directory Access Protocol (LDAP) user

In the login screen displayed, if you have opted for secure default access to iDRAC, enter the iDRAC secure default password available on back of the Information Tag. If you have not opted for secure default access to iDRAC, enter the default user name and password – `root` and `calvin`. You can also log in by using your Single Sign-On or Smart Card.

i **NOTE:** Ensure that you change the default username and password after setting up the iDRAC IP address.

For more information about logging in to the iDRAC and iDRAC licenses, see the latest *Integrated Dell Remote Access Controller User's Guide* at www.dell.com/idracmanuals.

i **NOTE:** To determine the most recent iDRAC release for your platform and for latest documentation version, see KB article <https://www.dell.com/support/article/sln308699>.

You can also access iDRAC using command-line protocol - RACADM. For more information, see the *iDRAC with Lifecycle Controller RACADM CLI Guide* available at www.dell.com/idracmanuals.

You can also access iDRAC using automation tool - Redfish API. For more information, see the *iDRAC9 with Lifecycle Controller Redfish API Guide* available at <https://www.dell.com/idracmanuals>.

Resources to install operating system

If the system is shipped without an operating system, you can install a supported operating system by using one of the resources provided in the table below. For information about how to install the operating system, see the documentation links provided in the table below.

Table 6. Resources to install the operating system

Resource	Documentation links
iDRAC	<i>Integrated Dell Remote Access Controller User's Guide</i> at https://www.dell.com/idracmanuals or for system specific <i>Integrated Dell Remote Access Controller User's Guide</i> , go to https://www.dell.com/poweredgemanuals > Product Support page of your system > Documentation . ⓘ NOTE: To determine the most recent iDRAC release for your platform and for latest documentation version, see KB article at https://www.dell.com/support/article/sln308699 .
Lifecycle Controller	<i>Dell Lifecycle Controller User's Guide</i> at https://www.dell.com/idracmanuals or for system specific <i>Dell Lifecycle Controller User's Guide</i> , go to https://www.dell.com/poweredgemanuals > Product Support page of your system > Documentation . Dell recommends using Lifecycle Controller to install the OS, since all required drivers are installed on the system. ⓘ NOTE: To determine the most recent iDRAC release for your platform and for latest documentation version, see KB article at https://www.dell.com/support/article/sln308699 .
OpenManage Deployment Toolkit	www.dell.com/openmanagemanuals > OpenManage Deployment Toolkit

ⓘ **NOTE:** For more information about installation and how-to videos for operating systems supported on PowerEdge systems, see [Supported Operating Systems for Dell EMC PowerEdge systems](#).

Options to download firmware

You can download firmware from the Dell support site. For information about downloading firmware, see the [Downloading drivers and firmware](#) section.

You can also choose any one of the following options to download the firmware. For information about how to download the firmware, see the documentation links provided in the table below.

Table 7. Options to download firmware

Option	Documentation link
Using Integrated Dell Remote Access Controller Lifecycle Controller (iDRAC with LC)	www.dell.com/idracmanuals
Using Dell Repository Manager (DRM)	www.dell.com/openmanagemanuals > Repository Manager
Using Dell Server Update Utility (SUU)	www.dell.com/openmanagemanuals > Server Update Utility
Using Dell OpenManage Deployment Toolkit (DTK)	www.dell.com/openmanagemanuals > OpenManage Deployment Toolkit
Using iDRAC virtual media	www.dell.com/idracmanuals

Options to download and install OS drivers

You can choose any one of the following options to download and install OS drivers. For information about how to download or install OS drivers, see the documentation links provided in the table below.

Table 8. Options to download and install OS drivers

Option	Documentation
Dell EMC support site	Downloading drivers and firmware section.

Table 8. Options to download and install OS drivers (continued)

Option	Documentation
iDRAC virtual media	<p><i>Integrated Dell Remote Access Controller User's Guide</i> at https://www.dell.com/idracmanuals or for system specific <i>Integrated Dell Remote Access Controller User's Guide</i>, go to https://www.dell.com/poweredgemanuals > Product Support page of your system > Documentation .</p> <p>NOTE: To determine the most recent iDRAC release for your platform and for latest documentation version, see https://www.dell.com/support/article/sln308699.</p>

Downloading drivers and firmware

It is recommended that you download and install the latest BIOS, drivers, and systems management firmware on the system.

Prerequisites

Ensure that you clear the web browser cache before downloading the drivers and firmware.

Steps

1. Go to www.dell.com/support/drivers.
2. Enter the Service Tag of the system in the **Enter a Dell Service Tag, Dell EMC Product ID or Model** field, and then press Enter.

NOTE: If you do not have the Service Tag, click **Browse all products**, and navigate to your product.

3. On the displayed product page, click **Drivers & Downloads**.
On the **Drivers & Downloads** page, all drivers that are applicable to the system are displayed.
4. Download the drivers to a USB drive, CD, or DVD.

Minimum to POST and system management configuration validation

This section describes the minimum to POST system requirement and system management configuration validation of the Dell EMC system.

Topics:

- [Minimum configuration to POST](#)
- [Configuration validation](#)

Minimum configuration to POST

The components listed below are the minimum configuration to POST:

- Processor
- One memory module (DIMM) in socket A1
- One power supply unit
- System board

Configuration validation

The new generation of PowerEdge systems have added interconnect flexibility and advanced iDRAC management features to collect precise system configuration information and report configuration errors.

When the system is powered on, information about installed cables, backplanes, floating card (like BOSS), and processor is obtained from the CPLD and backplane memory maps is analyzed. This information forms a unique configuration, which is compared with one of the qualified configurations stored in a table maintained by iDRAC.

One or more sensors are assigned to each of the configuration elements. During POST, any configuration validation error is logged in the System Event Log (SEL)/LifeCycle (LC) log. The reported events are categorized in the configuration validation error table.

Table 9. Configuration validation error

Error	Description	Possible cause and recommendations	Example
Config Error	A configuration element within the closest match contains something that is unexpected and does not match any Dell qualified configuration.	Wrong configuration	Config Error: Backplane cable CTRS_SRC_SA1 and BP-DST_SA1
		The element reported in HWC8010 errors are assembled incorrectly. Verify element (cable, etc) placement in the system.	Config Error : SL Cable PLANAR_SL7 and CTRL_DST_PA1
Config Missing	iDRAC found a configuration element missing within the closest match detected.	Missing or damaged cable, device, or part	Config Missing: adapter PERC/HBA
		Missing element or cable is reported in HWC8010 error logs. Install the missing element (cable, etc).	Config Missing : SL cable PLANAR_SL8 and CTRL_DST_PA1

Table 9. Configuration validation error (continued)

Error	Description	Possible cause and recommendations	Example
Comm Error	A configuration element is not responding to iDRAC using the management interface while running an inventory check.	System management sideband communication Unplug AC Power, reseal the element and replace the element if the problem persists.	Comm Error: Backplane 2

Error messages

This section describes the error messages displayed on the screen during POST or captured in the system event log (SEL)/ LifeCycle (LC) log.

Table 10. Error message HWC8010

Error code	HWC8010
Message	The System Configuration Check operation resulted in the following issue involving the indicated component type
Arguments	floating card (like BOSS), backplane, processor, cable, or other components
Detailed Description	The issue identified in the message is observed in the System Configuration Check operation.
Recommended Response Action	Do the following and retry the operation: <ol style="list-style-type: none"> 1. Disconnect the input power. 2. Check for proper cable connection and component placement. If the issue persists, contact the service provider.
Category	System Health (HWC = Hardware Config)
Severity	Critical
Trap/EventID	2329

Table 11. Error message HWC8011

Error code	HWC8011
Message	The System Configuration Check operation resulted in multiple issues involving the indicated component type
Arguments	floating card (like BOSS), backplane, processor, cable, or other components
Detailed Description	Multiple issues are observed in the System Configuration Check operation.
Recommended Response Action	Do the following and retry the operation: <ol style="list-style-type: none"> 1. Disconnect the input power. 2. Check for proper cable connection and component placement. If the issue persists, contact the service provider.
Category	System Health (HWC = Hardware Config)
Severity	Critical

Installing and removing system components

Topics:

- Safety instructions
- Before working inside your system
- After working inside your system
- Recommended tools
- Optional front bezel
- System feet
- System cover
- Air shroud
- Intrusion switch module
- Drives
- Optional optical drive
- Drive backplane
- Cooling fans
- Cable routing
- System memory
- Processor and heat sink module
- Expansion cards
- Optional BOSS S2 module
- Optional IDSDM module
- MicroSD card
- Optional internal USB card
- Optional internal USB memory key
- Power supply unit
- Power interposer board
- System battery
- System board
- Trusted Platform Module
- Control panel

Safety instructions

 **WARNING:** Opening or removing the system cover while the system is powered on may expose you to a risk of electric shock.

 **WARNING:** Do not operate the system without the cover for a duration exceeding five minutes. Operating the system without the system cover can result in component damage.

 **CAUTION:** Many repairs may only be done by a certified service technician. You should only perform troubleshooting and simple repairs as authorized in your product documentation, or as directed by the online or telephone service and support team. Damage due to servicing that is not authorized by Dell is not covered by your warranty. Read and follow the safety instructions that are shipped with your product.

 **NOTE:** It is recommended that you always use an antistatic mat and antistatic strap while working on components inside the system.

 **CAUTION:** To ensure proper operation and cooling, all system bays and fans must always be populated with a component or a blank.

NOTE: While replacing faulty storage controller, FC, or NIC card with the same type of card, after you power on the system; the new card automatically updates to the same firmware and configuration of the faulty one. For more information about the Part replacement configuration, see the *Lifecycle Controller User's Guide* at <https://www.dell.com/idracmanuals>.

CAUTION: Do not install GPUs, network cards, or other PCIe devices on your system that are not validated and tested by Dell. Damage caused by unauthorized and invalidated hardware installation will null and void the system warranty.

Before working inside your system

Prerequisites

Follow the safety guidelines listed in the [Safety instructions](#).

Steps

1. Power off the system and all attached peripherals.
2. Disconnect the system from the electrical outlet, and disconnect the peripherals.
3. Remove the system cover.

After working inside your system

Prerequisites

Follow the safety guidelines listed in [Safety instructions](#).

Steps

1. Replace the system cover.
2. Reconnect the peripherals and connect the system to the electrical outlet, and then power on the system.

Recommended tools

You need the following tools to perform the removal and installation procedures:

- Key to the bezel lock. The key is required only if your system includes a bezel.
- Phillips 1 screwdriver
- Phillips 2 screwdriver
- Torx T15 screwdriver
- 5 mm hex nut screwdriver
- Plastic scribe
- 1/4-inch flat blade screwdriver
- Wrist grounding strap connected to the ground
- ESD mat
- Needle-nose pliers

Optional front bezel

Removing the front bezel

Prerequisites

1. Follow the safety guidelines listed in [Safety instructions](#).
2. Keep the bezel key handy.

NOTE: The bezel key is part of the LCD bezel package.

Steps

1. Unlock the bezel.
2. Holding the edges at the top, tilt the bezel to release from the system.
3. Unhook the bezel tabs from the slots at the bottom, and lift the bezel.

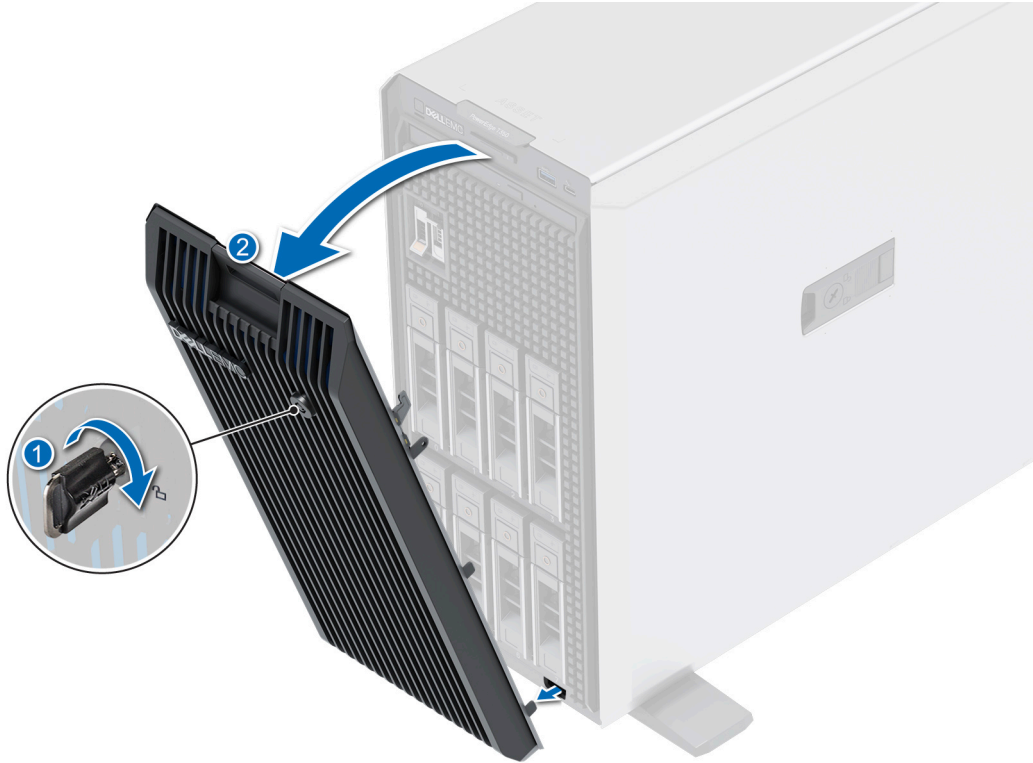

Figure 12. Removing the front bezel

Next steps

Replace the front bezel.

Installing the front bezel

Prerequisites

1. Follow the safety guidelines listed in [Safety instructions](#).
2. Locate and remove the bezel key.

NOTE: The bezel key is part of the bezel package.

Steps

1. Align and insert the bezel tabs into the slots in the system.
2. Press the bezel until clicks in place.
3. Lock the bezel.

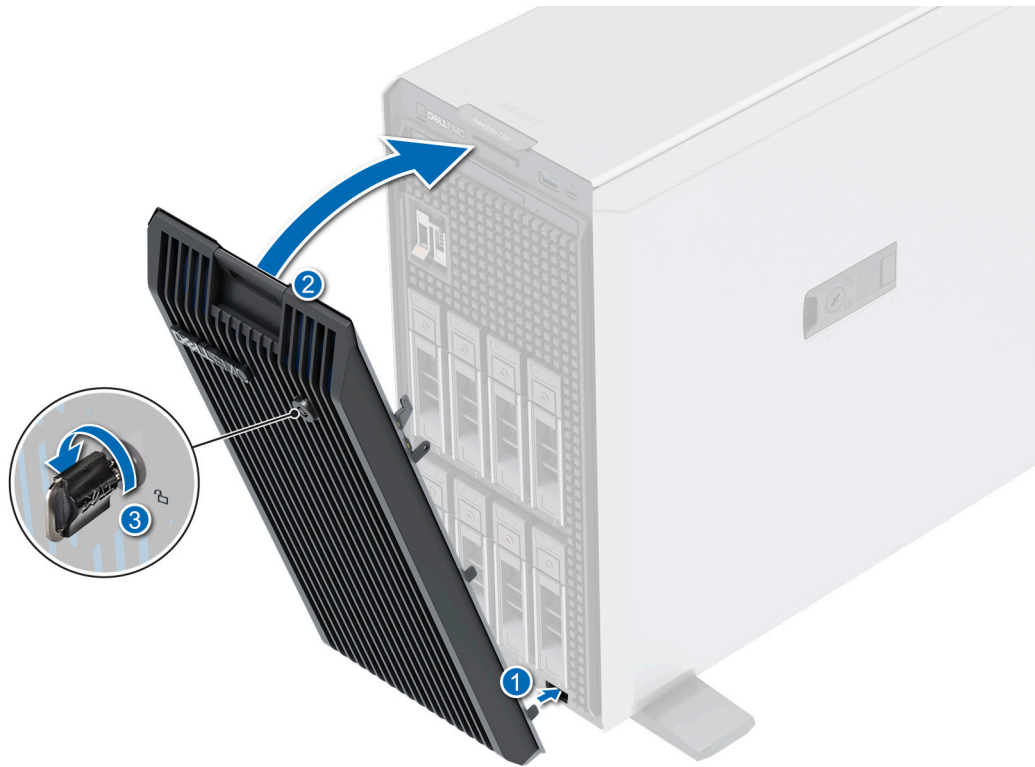

Figure 13. Installing the front bezel

System feet

Removing the system feet

Prerequisites

1. Follow the safety guidelines listed in [Safety instructions](#).
2. Place the system on its side on a flat, stable surface.
3. Rotate the system feet inward.

Steps

1. Using the Phillips 2 screwdriver, remove the screw that secures the foot to the base of the system.
2. Repeat the preceding step to remove the remaining system feet.

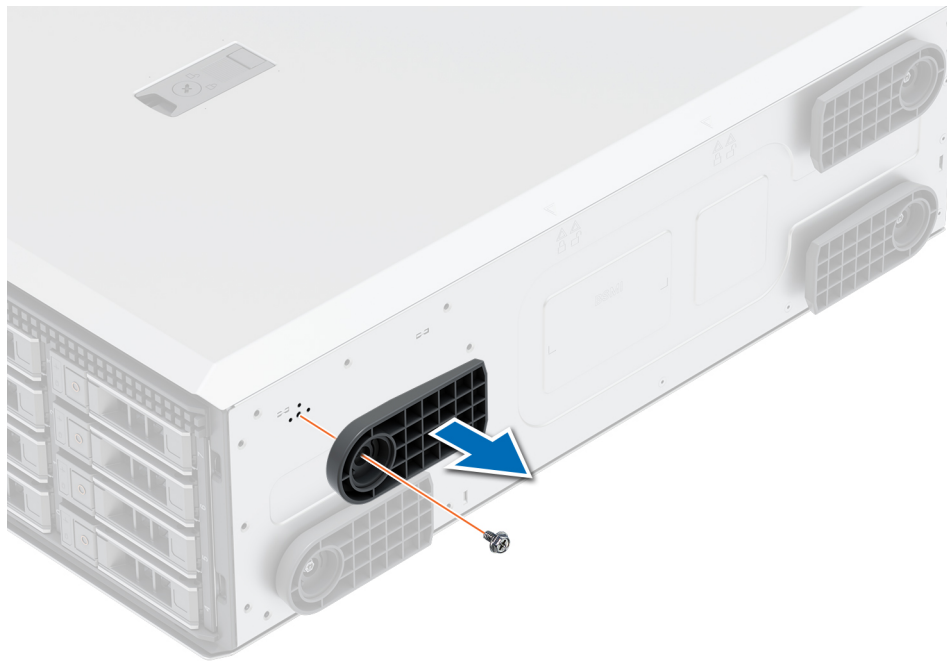

Figure 14. Removing the system feet

Next steps

1. [Replace the system feet.](#)

Installing the system feet

Prerequisites

CAUTION: Install the feet on a stand-alone tower system to provide stability to the system. An unstable system might tip over and cause injury to the user or damage to the system.

1. Follow the safety guidelines listed in [Safety instructions](#).
2. Place the system on its side on a flat, stable surface.

Steps

1. Align the three tabs on the system foot with the three slots on the base of the system.
2. Using the Phillips 2 screwdriver, secure the feet to the base of the system with a screw.
3. Repeat the above steps to install the remaining system feet.

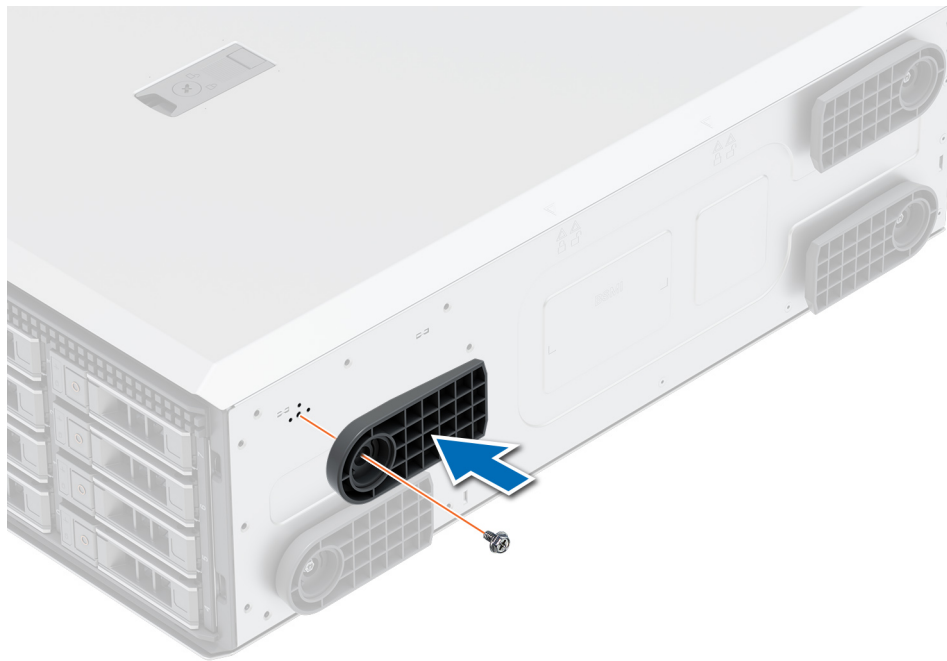

Figure 15. Installing the system feet

Next steps

1. Place the system upright on a flat, stable surface, and rotate the system feet outward.
2. Follow the procedure listed in [After working inside your system](#).

System cover

Removing the system cover

Prerequisites

1. Follow the safety guidelines listed in [Safety instructions](#).
2. [Remove the front bezel](#).
3. Power off the system and any attached peripherals.
4. Disconnect the system from the electrical outlet and peripherals.
5. Place the system on a flat, stable surface.

Steps

1. Use a 1/4-inch flat head or a Phillips 2 screwdriver to turn the lock counterclockwise to the unlock position.
2. Lift the release latch until the system cover slides back.
3. Lift the cover from the system cover.

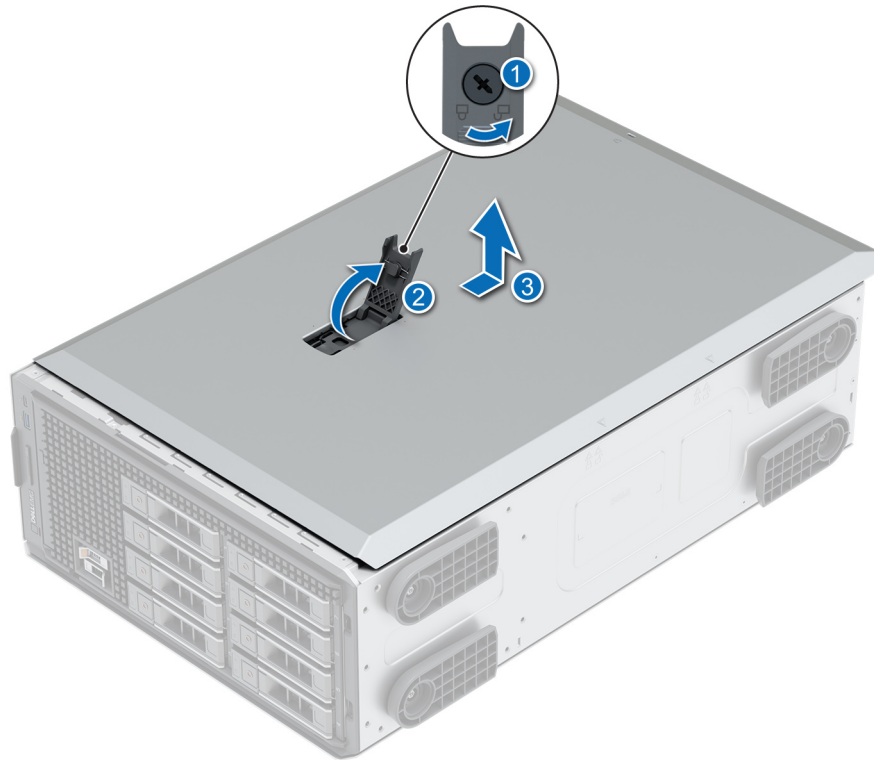

Figure 16. Removing the system cover

Next steps

[Replace the system cover.](#)

Installing the system cover

Prerequisites

1. Follow the safety guidelines listed in [Safety instructions](#).
2. [Remove the front bezel](#).
3. Power off the system and any attached peripherals.
4. Disconnect the system from the electrical outlet and peripherals.
5. Ensure that all internal cables are connected and placed out of the way and no tools or extra parts are left inside the system.

Steps

1. Align the tabs on the system cover with the guide slots on the system and slide the system cover.
2. Close the system cover release latch.
3. Using a 1/4-inch flat head or a Phillips 2 screwdriver, turn the lock clockwise to the locked position.

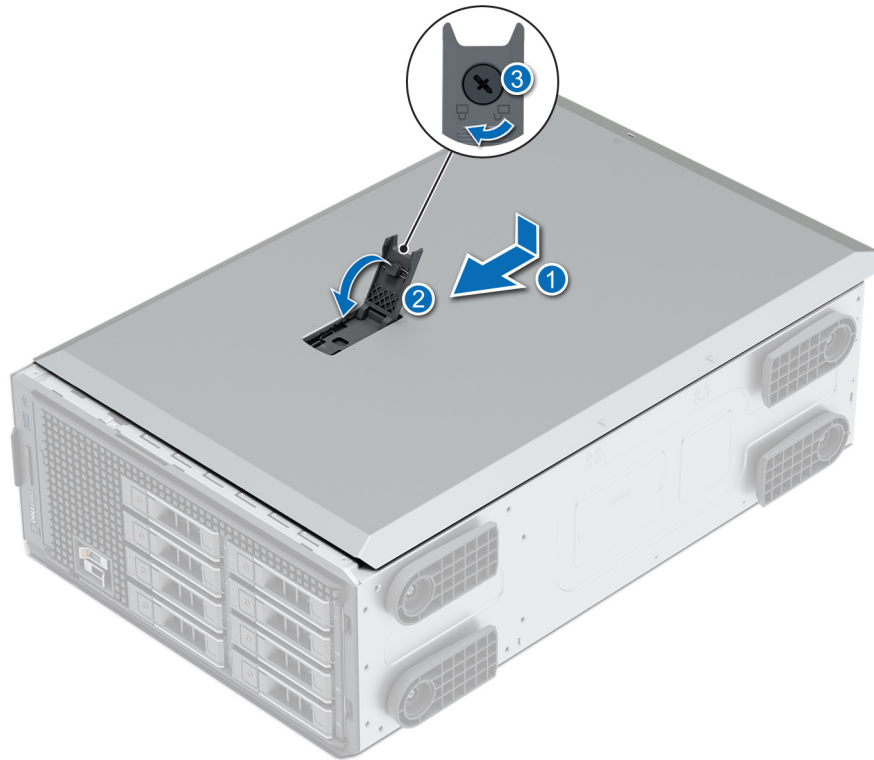

Figure 17. Installing the system cover

Next steps

1. Place the system upright on its feet on a flat, stable surface.
2. [Install the front bezel.](#)
3. Reconnect the peripherals, and connect the system to the electrical outlet and then power on the system.

Air shroud

Removing the air shroud

Prerequisites

CAUTION: Never operate your system with the air shroud removed. The system may get overheated quickly, resulting in shutdown of the system and loss of data.

1. Follow the safety guidelines listed in [Safety instructions](#).
2. Follow the procedure listed in [Before working inside your system](#).

Steps

Holding the touch points, lift the air shroud out of the system.

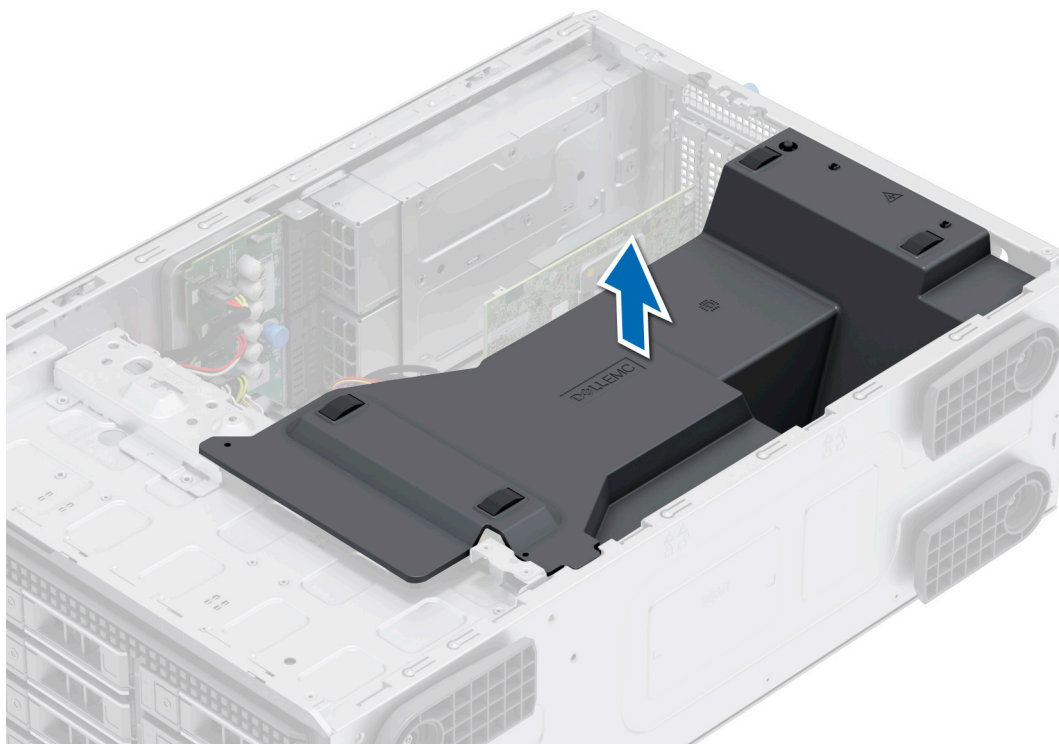

Figure 18. Removing the air shroud

Next steps

1. [Replace the air shroud](#).

Installing the air shroud

Prerequisites

1. Follow the safety guidelines listed in [Safety instructions](#).
2. Follow the procedure listed in [Before working inside your system](#).
3. If applicable, route the cables inside the system along the system wall and secure the cables by using the cable-securing bracket.

Steps

1. Align the tabs on the air shroud with the slots on the system.
2. Lower the air shroud into the system until it is firmly seated.

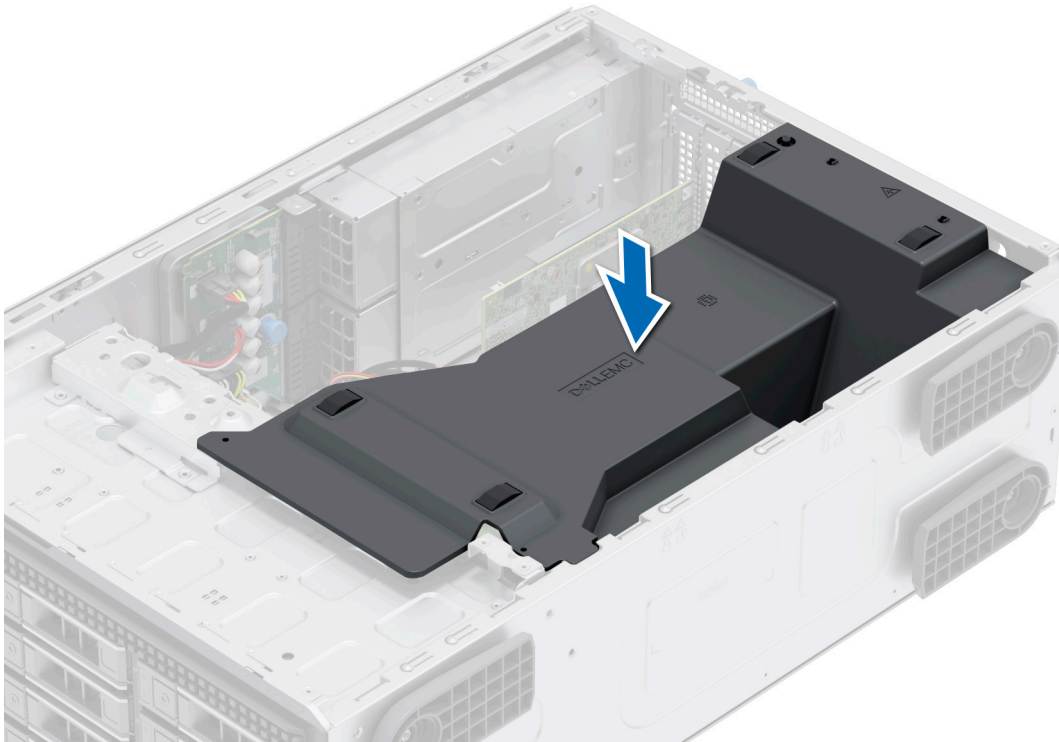

Figure 19. Installing the air shroud

Next steps

Follow the procedure listed in [After working inside your system](#)

Intrusion switch module

This is a service technician replaceable part only.

Removing the intrusion switch module

Prerequisites

1. Follow the safety guidelines listed in [Safety instructions](#).
2. Follow the procedure listed in [Before working inside your system](#).
3. [Remove the air shroud](#).
4. Keep the plastic scribe ready.

Steps

1. Disconnect the intrusion switch cable from the connector on the system board.
i **NOTE:** Observe the routing of the cable as you remove it from the system. Route the cable properly when you replace it to prevent the cable from being pinched or crimped.
2. Using the plastic scribe, slide the intrusion switch module out of the system slot.

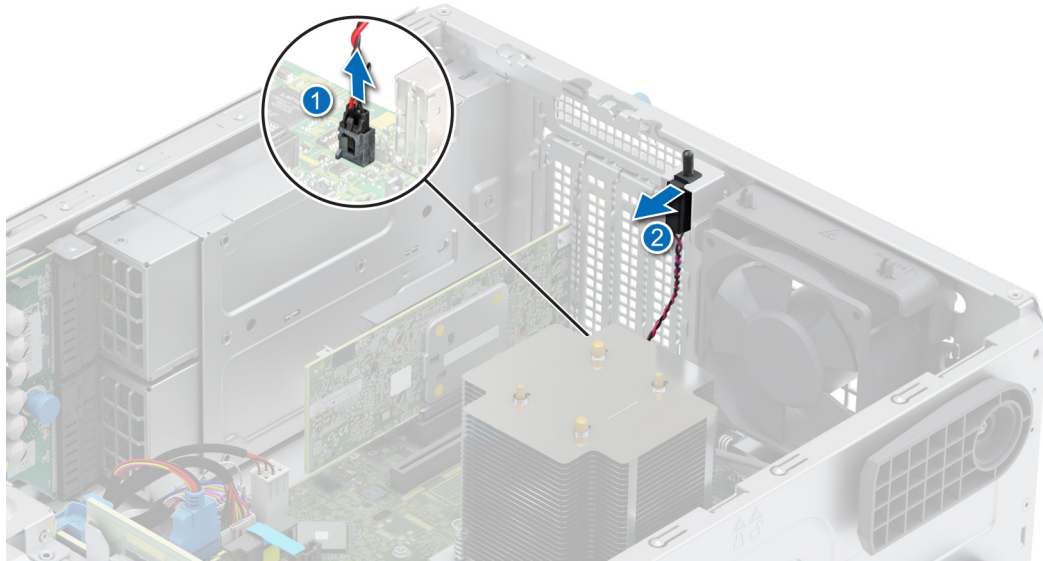

Figure 20. Removing the intrusion switch module

Next steps

Replace the intrusion switch module.

Installing the intrusion switch module

Prerequisites

1. Follow the safety guidelines listed in [Safety instructions](#).
2. Follow the procedure listed in [Before working inside your system](#).

Steps

1. Align and slide the intrusion switch module into the system slot until firmly seated.
2. Connect the intrusion switch cable to the connector on the system board.

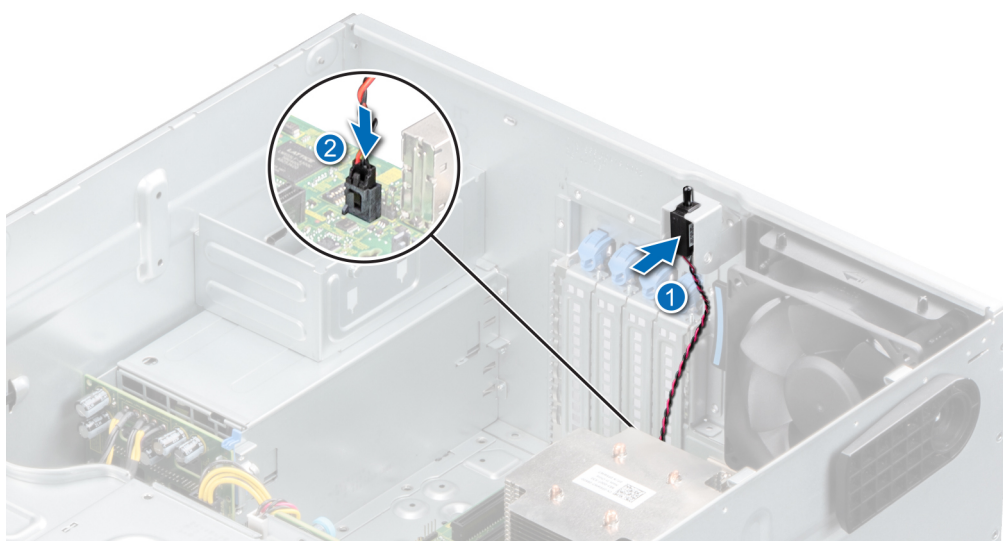

Figure 21. Installing the intrusion switch module

Next steps

1. [Install the air shroud.](#)
2. Follow the procedure that is listed in [After working inside your system.](#)

Drives

Removing a drive blank

Prerequisites

1. Follow the safety guidelines listed in [Safety instructions.](#)
2. Follow the procedure listed in [Before working inside your system.](#)
3. [Remove the front bezel.](#)

CAUTION: To maintain proper system cooling, drive blanks must be installed in all empty drive slots.

CAUTION: Mixing drive blanks from previous generations of PowerEdge servers is not supported.

Steps

Press the release button, and slide the drive blank out of the drive slot.

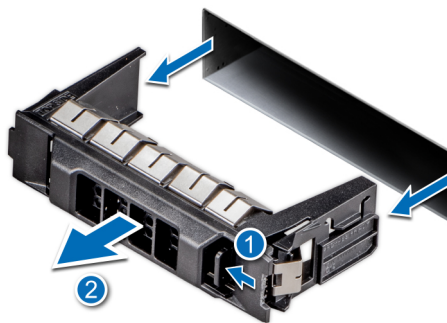

Figure 22. Removing a drive blank

Next steps

1. [Install the drive](#) or [replace the drive blank.](#)

Installing a drive blank

Prerequisites

1. Follow the safety guidelines listed in [Safety instructions.](#)
2. Follow the procedure in [Before working inside your system.](#)
3. [Remove the front bezel.](#)

CAUTION: To maintain proper system cooling, drive blanks must be installed in all empty drive slots.

CAUTION: Mixing drive blanks from previous generations of PowerEdge servers is not supported.

Steps

Slide the drive blank into the drive slot until the release button clicks into place.

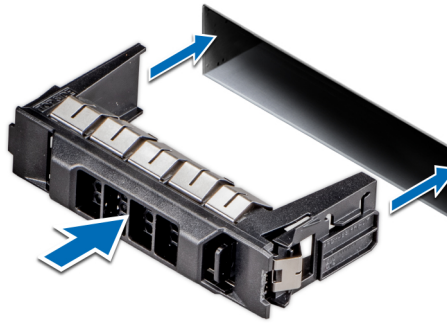

Figure 23. Installing a drive blank

Next steps

1. [Replace the front bezel.](#)
2. Follow the procedure listed in [After working inside your system.](#)

Removing a drive carrier

Prerequisites

1. Follow the safety guidelines listed in [Safety instructions.](#)
2. [Remove the front bezel.](#)
3. Using the management software, prepare the drive for removal. If the drive is online, the green activity or fault indicator flashes while the drive is turning off. When the drive indicators are off, the drive is ready for removal. For more information, see the storage controller documentation.

CAUTION: Before attempting to remove or install a drive while the system is running, see the documentation for the storage controller card to ensure that the host adapter is configured correctly to support drive removal and insertion.

CAUTION: To prevent data loss, ensure that your operating system supports drive installation. See the documentation supplied with your operating system.

Steps

1. Press the release button to open the drive carrier release handle.
2. Holding the drive carrier release handle, slide the drive carrier out of the drive slot.

NOTE: If you are not replacing the drive immediately, install a drive blank in the empty drive slot to maintain proper system cooling.

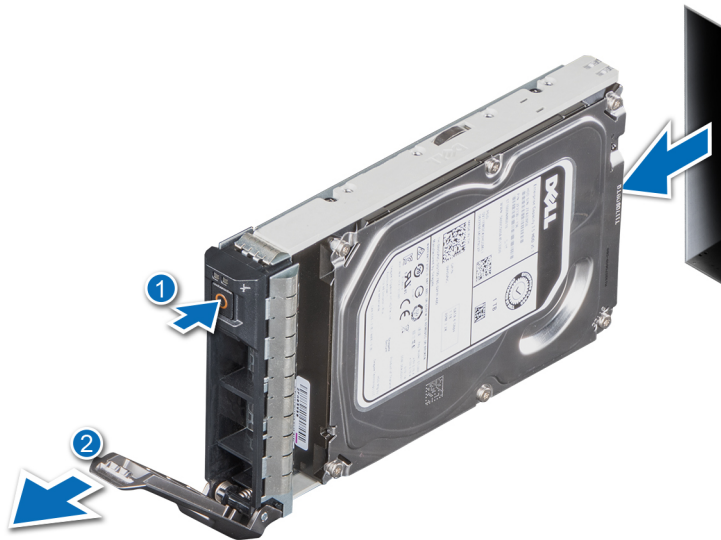

Figure 24. Removing a drive carrier

Next steps

Replace the drive or a drive blank.

Installing the drive carrier

Prerequisites

- CAUTION:** Before removing or installing a drive while the system is running, see the documentation for the storage controller card to ensure that the host adapter is configured correctly to support drive removal and insertion.
- CAUTION:** Combining SAS and SATA drives in the same RAID volume is not supported.
- CAUTION:** When installing a drive, ensure that the adjacent drives are fully installed. Inserting a drive carrier and attempting to lock its handle next to a partially installed carrier can damage the partially installed carrier's shield spring and make it unusable.
- NOTE:** Ensure that the drive carrier's release handle is in the open position before inserting the carrier into the slot.
- CAUTION:** To prevent data loss, ensure that your operating system supports hot-swap drive installation. See the documentation supplied with your operating system.
- CAUTION:** When a replacement hot swappable drive is installed and the system is powered on, the drive automatically begins to rebuild. Ensure that the replacement drive is blank or contains data that you wish to overwrite. Any data on the replacement drive is immediately lost after the drive is installed.

1. Follow the safety guidelines listed in [Safety instructions](#).
2. [Remove the front bezel](#).
3. Remove the drive carrier or remove the drive blank when you want to assemble the drives in to the system.

Steps

1. Slide the drive carrier into the drive slot and push until the drive connects with the backplane.
2. Close the drive carrier release handle to lock the drive in place.



Figure 25. Installing a drive carrier

Next steps

Install the front bezel.

Removing the drive from the drive carrier

Prerequisites

1. Follow the safety guidelines listed in [Safety instructions](#).
2. [Remove the front bezel](#).
3. [Remove the drive carrier](#).

Steps

1. Using a Phillips 1 screwdriver, remove the screws from the slide rails on the drive carrier.

i **NOTE:** If the hard drive or SSD carrier has Torx screw, use Torx 6 (for 2.5-inch drive) or Torx 8 (for 3.5-inch drive) screw driver to remove the drive.



2. Lift the drive out of the drive carrier.



Figure 26. Removing the drive from the drive carrier

Next steps

1. [Replace the drive into the drive carrier.](#)

Installing the drive into the drive carrier

Prerequisites

1. Follow the safety guidelines listed in [Safety instructions](#).
2. [Remove the front bezel.](#)
3. [Remove the drive carrier.](#)

Steps

1. Insert the drive into the drive carrier with the connector end of the drive towards the rear of the carrier.
2. Align the screw holes on the drive with the screws holes on the drive carrier.
3. Using a Phillips 1 screwdriver, secure the drive to the drive carrier with the screws.

i **NOTE:** If the hard drive or SSD carrier has Torx screw, use Torx 6 (for 2.5-inch drive) or Torx 8 (for 3.5-inch drive) screwdriver to install the drive.





Figure 27. Installing a drive into the drive carrier

Next steps

1. [Install the drive carrier.](#)
2. [Install the front bezel.](#)

Removing a 3.5-inch drive adapter from a 3.5-inch drive carrier

Prerequisites

1. Follow the safety guidelines listed in [Safety instructions](#).
2. [Remove the drive carrier.](#)

Steps

1. Remove the screws from the rails on the drive carrier.

(i) NOTE: If the 3.5-inch drive has Torx screw, use Torx 6 screwdriver to remove the drive from a 3.5-inch drive adapter.



2. Lift the 3.5-inch drive adapter out of the drive carrier.

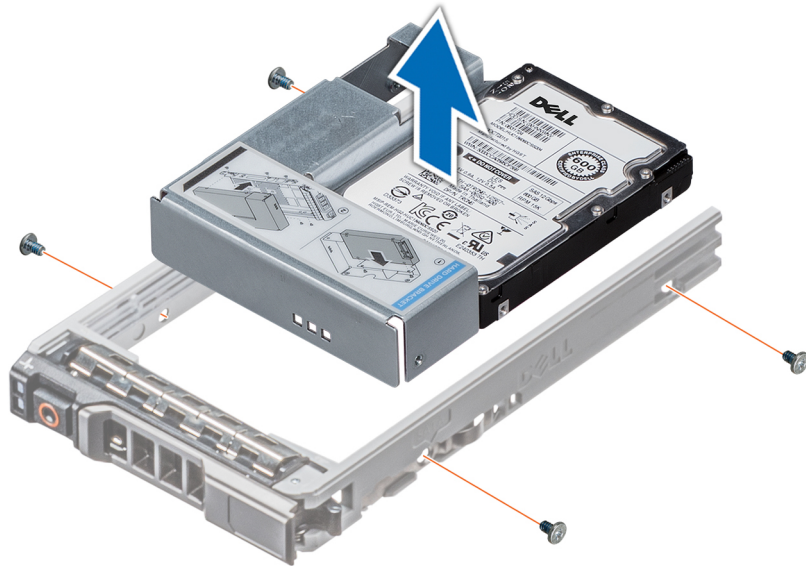

Figure 28. Removing a 3.5-inch drive adapter from a 3.5-inch drive carrier

Next steps

Replace a 3.5-inch adapter into a 3.5-inch drive carrier.

Installing a 3.5-inch adapter into a 3.5-inch drive carrier

Prerequisites

1. Follow the safety guidelines listed in [Safety instructions](#).
2. [Remove the drive carrier](#).

Steps

1. Insert the 3.5 inch drive adapter into the drive carrier with the connector end of the drive toward the rear of the drive carrier.
2. Align the screw holes on the drive and drive adapter with the holes on the drive carrier.
3. Install the screws to secure the drive to the drive carrier.

 **NOTE:** If the 3.5-inch drive has Torx screw, use Torx 6 screwdriver to install the drive to a 3.5-inch drive adapter.



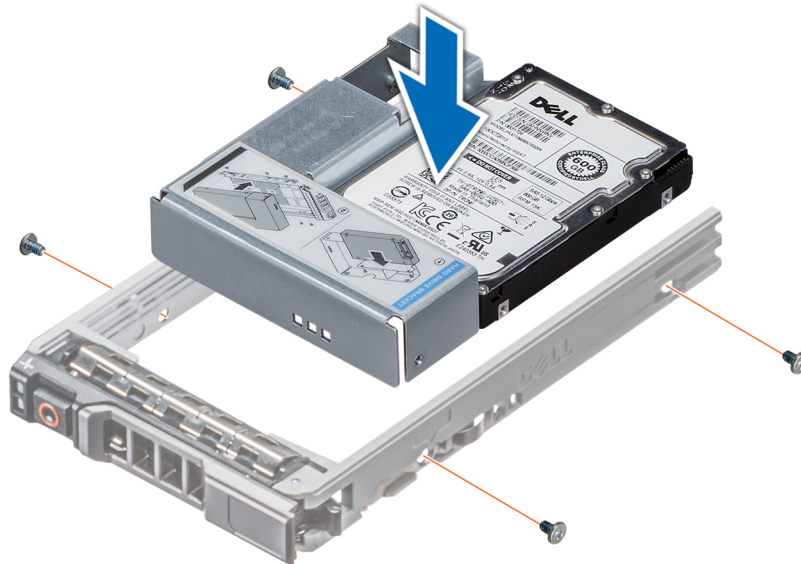

Figure 29. Installing a 3.5-inch drive adapter into the 3.5-inch drive carrier

Next steps

1. [Install the drive carrier.](#)

Removing a 2.5-inch drive from the 3.5-inch drive adapter

Prerequisites

1. Follow the safety guidelines listed in [Safety instructions](#)
2. [Remove the drive carrier.](#)
3. [Remove 3.5-inch drive adapter from the 3.5-inch drive carrier.](#)

i **NOTE:** A 2.5-inch hot swappable drive is installed in a 3.5-inch drive adapter, which is then installed in the 3.5-inch hot swappable drive carrier.

Steps

1. Using a Phillips 1 screwdriver, remove the screws that secures the drive to the 3.5-inch drive adapter.

i **NOTE:** If the 2.5-inch drive has Torx screw, use Torx 6 screwdriver to remove the drive from a 3.5-inch drive adapter.



2. Remove the drive from the 3.5-inch drive adapter.

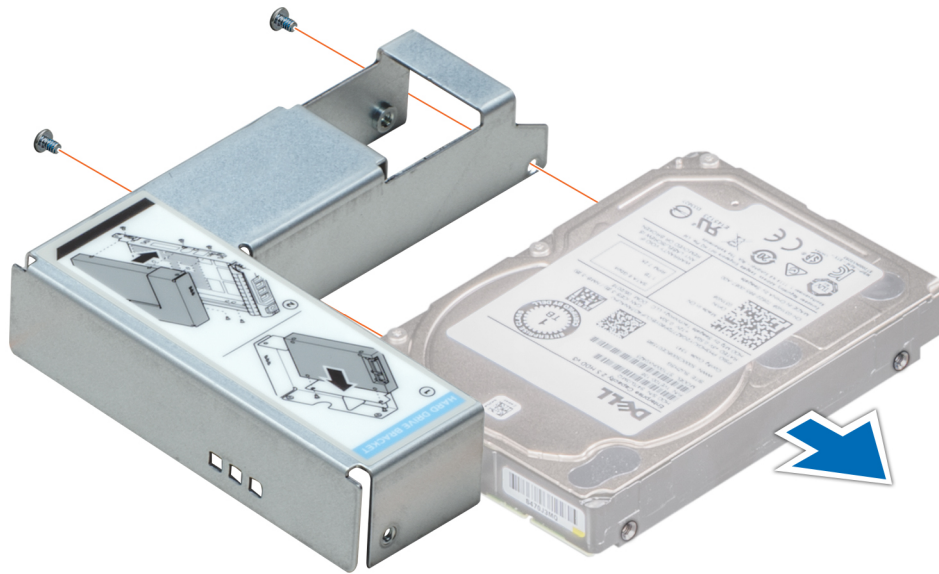

Figure 30. Removing a 2.5-inch drive from the 3.5-inch drive adapter

Next steps

Replace a 2.5-inch drive into the 3.5-inch drive adapter.

Installing a 2.5-inch drive into the 3.5-inch drive adapter

Prerequisites

1. Follow the safety guidelines listed in [Safety instructions](#).
2. [Remove the drive carrier](#).
3. [Remove 3.5-inch drive adapter from the 3.5-inch drive carrier](#).

Steps

1. Align the screw holes on the 2.5-inch drive with the screw holes on the 3.5-inch drive adapter.
2. Using a Phillips 1 screwdriver, tighten the screws to secure the drive to the 3.5-inch drive adapter.

i **NOTE:** If the 2.5-inch drive has Torx screw, use Torx 6 screwdriver to install the drive to a 3.5-inch drive adapter.



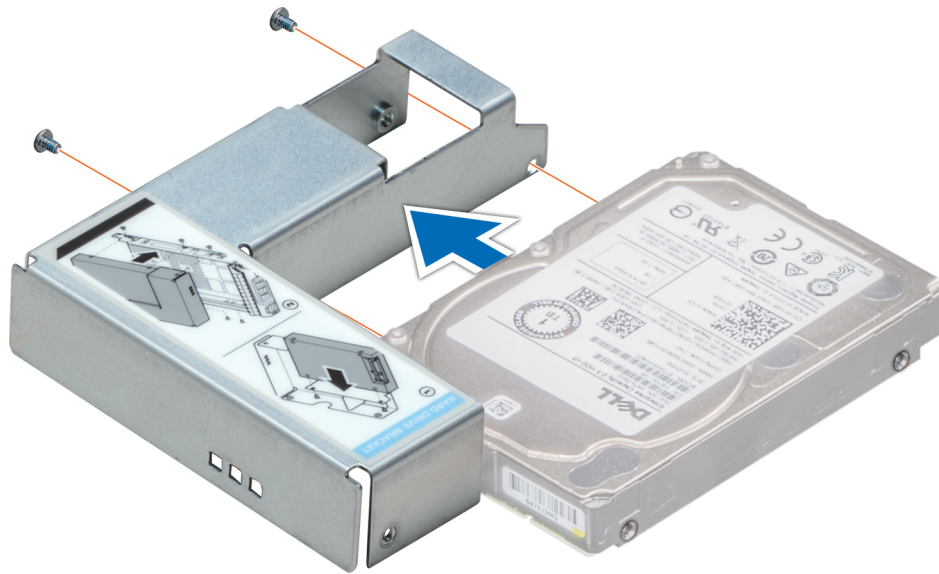

Figure 31. Installing a 2.5-inch drive into the 3.5-inch drive adapter

Next steps

1. Install a 3.5-inch adapter into the 3.5-inch drive carrier.
2. Install the drive carrier.

Optional optical drive

This is a service technician replaceable part only.

Removing the optical drive blank

Prerequisites

1. Follow the safety guidelines listed in [Safety instructions](#).
2. Follow the procedure that is listed in [Before working inside your system](#).
3. [Remove the front bezel](#).

Steps

Press and push the release latch towards the front of the system to remove the optical drive blank.

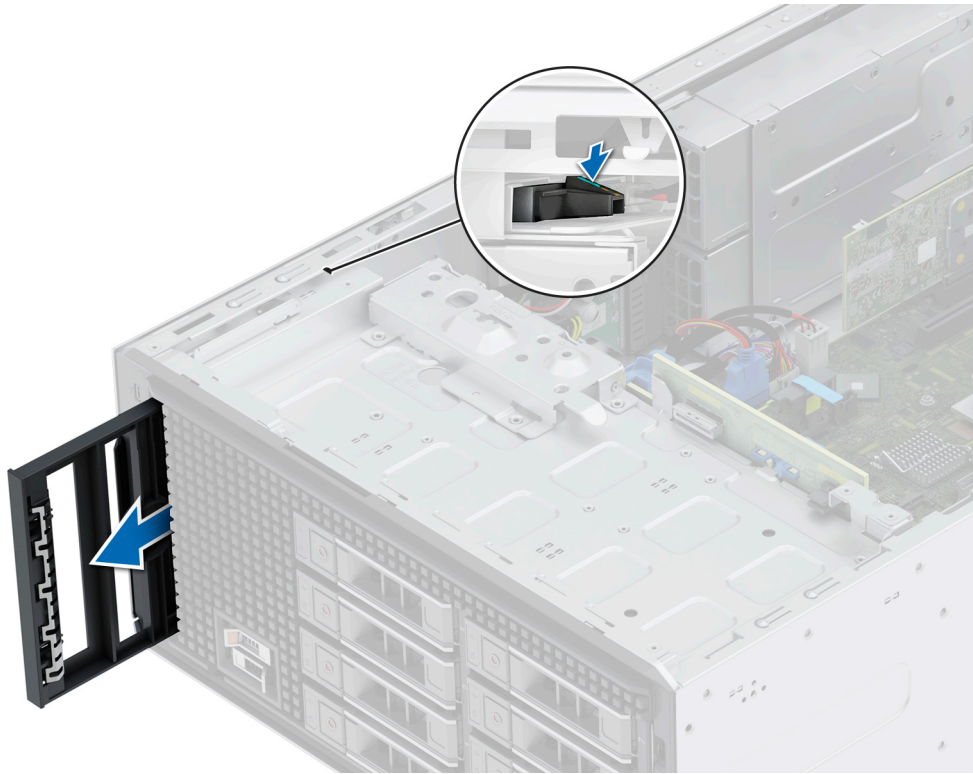

Figure 32. Removing the optical drive blank from the optical drive cage

Next steps

Replace the optical drive blank or install the optical drive.

Installing the optical drive blank

Prerequisites

1. Follow the safety guidelines listed in [Safety instructions](#).
2. Follow the procedure that is listed in [Before working inside your system](#).
3. [Remove the front bezel](#).

Steps

Align and slide the optical drive blank into the optical drive slot until the release latch snaps into place.

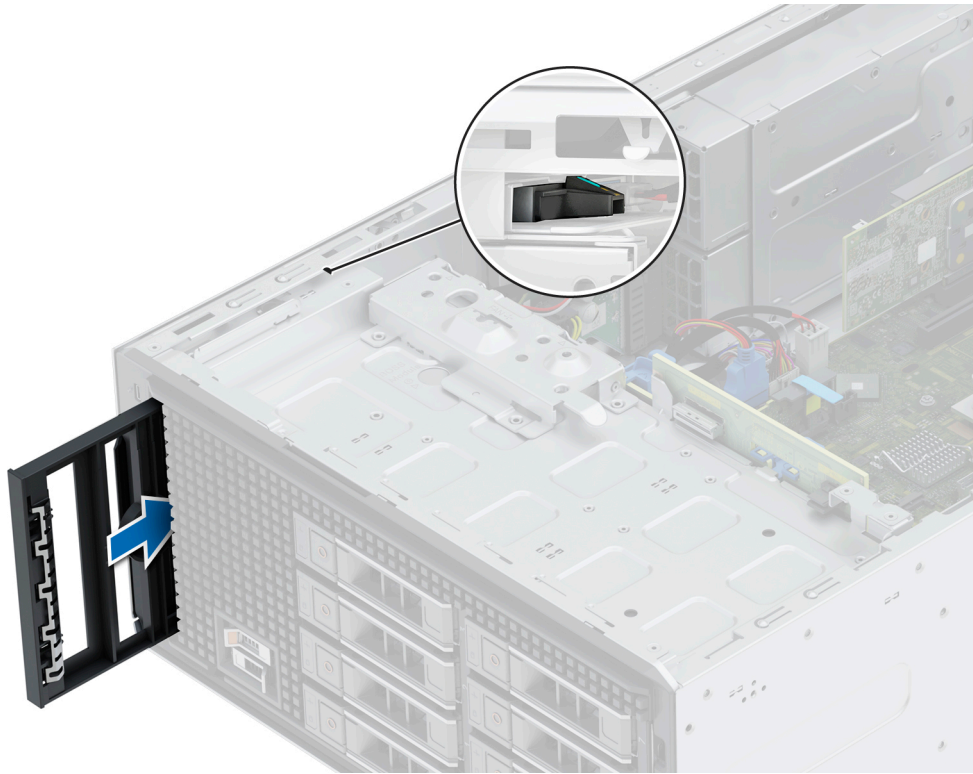

Figure 33. Installing the optical drive blank into the optical drive cage

Next steps

1. [Install the front bezel.](#)
2. Follow the procedure that is listed in [After working inside your system.](#)

Removing the optical drive

Prerequisites

1. Follow the safety guidelines listed in [Safety instructions.](#)
2. Follow the procedure that is listed in [Before working inside your system.](#)
3. [Remove the front bezel.](#)
4. Disconnect the power and data cables from the optical drive.

 **NOTE:** Ensure that you note the routing of the power and data cable as you remove them from the system board and drive.

Steps

1. To release the optical drive, press and push the release tab toward the front of the system.
2. Slide the optical drive out of the system.

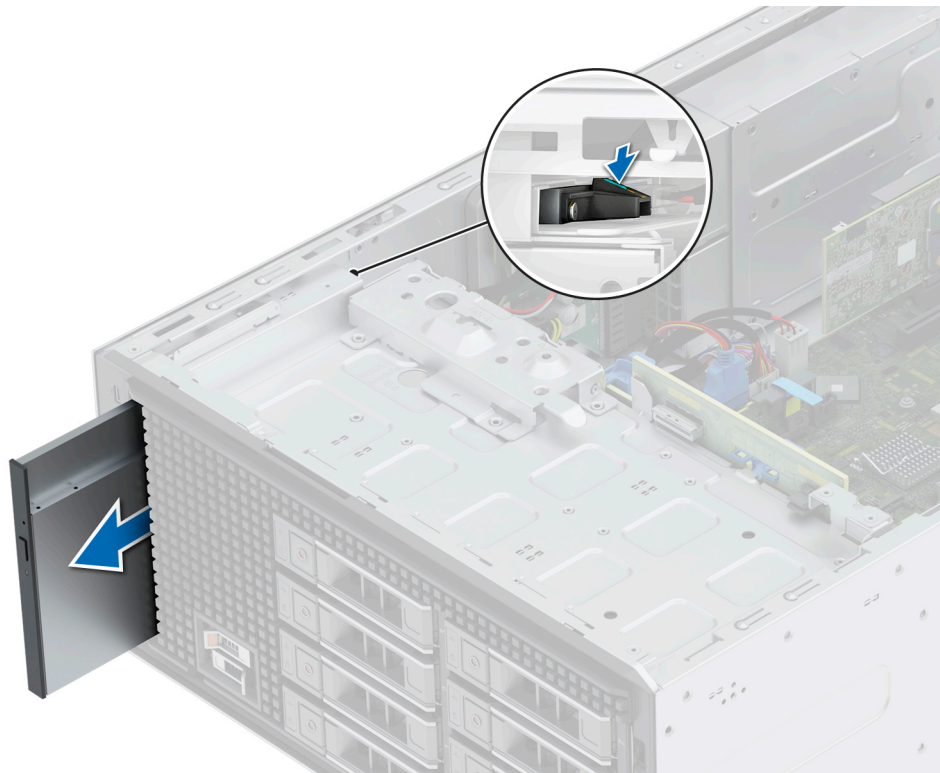

Figure 34. Removing the optical drive

NOTE: If optical drive is not being replaced, install optical drive blank.

Next steps

Replace the optical drive.

Installing the optical drive

Prerequisites

NOTE: Only slim 9.5 mm SATA DVD-ROM drive or DVD+/-RW drive can be installed in your system. External optical drives can be connected through USB ports.

1. Follow the safety guidelines listed in [Safety instructions](#).
2. Follow the procedure that is listed in [Before working inside your system](#).
3. [Remove the front bezel](#).
4. If installed, [Remove the optical drive blank](#).

Steps

1. Align the optical drive with the optical drive slot on the system.
2. Slide the optical drive into the slot until the release tab snaps into place.

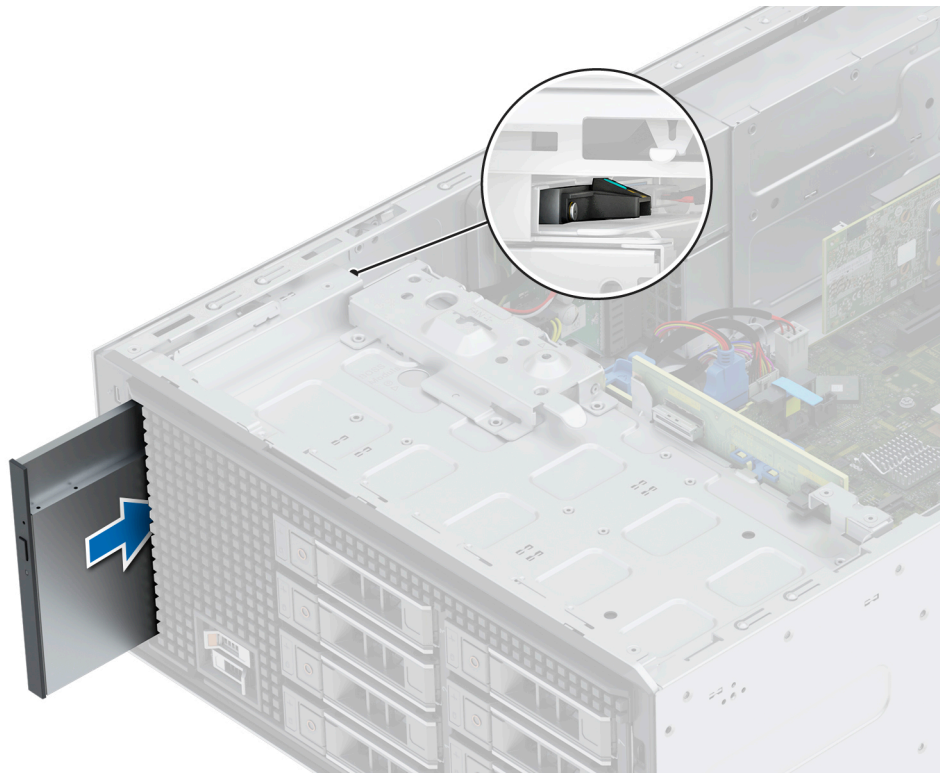

Figure 35. Installing the optical drive

Next steps

1. Connect the power cable and the data cable to the optical drive.
 - NOTE:** Route the cables properly to prevent them from being pinched or crimped.
2. [Install the front bezel.](#)
3. Follow the procedure that is listed in [After working inside your system.](#)

Drive backplane

This is a service technician replaceable part only.

Drive backplane

Depending on your system configuration, the drive backplanes supported are listed here:

Table 12. Supported backplane option

System	Supported hard drives options
PowerEdge T350	Up to 8 x 3.5-inch SAS/SATA (HDD/SSD) backplane

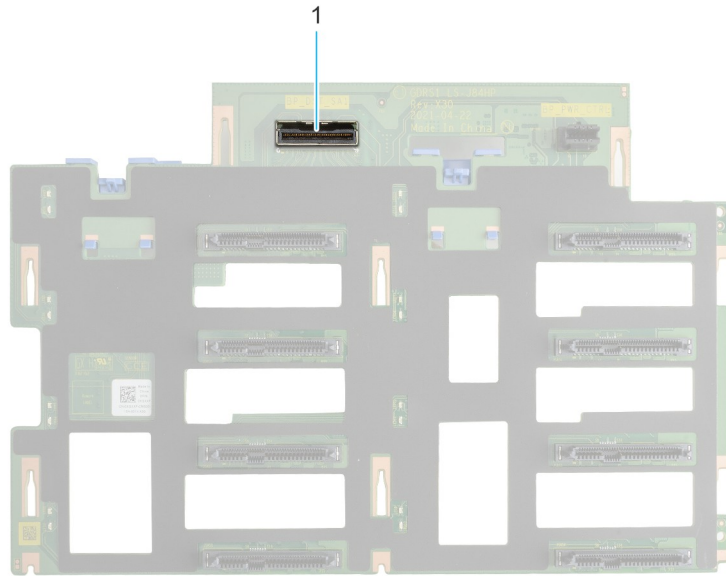

Figure 36. 8 x 3.5-inch drive backplane (front)

1. BP_DST_SA1 (SAS/SATA connector)

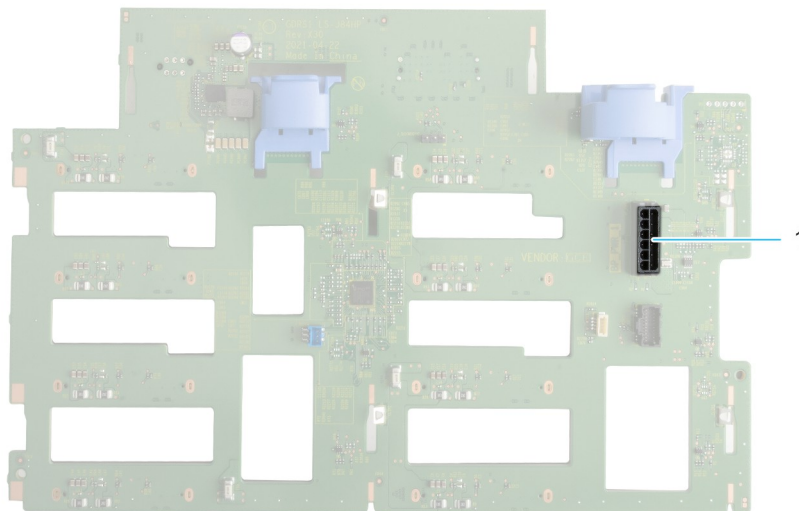

Figure 37. 8 x 3.5-inch drive backplane (rear)

1. BP_PWR_1 (backplane power connector)

Removing the drive backplane

Prerequisites

CAUTION: Note the number of each drive and temporarily label them before you remove the drive so that you can replace them in the same location.

1. Follow the safety guidelines listed in [Safety instructions](#).
2. Follow the procedure listed in [Before working inside your system](#).
3. [Remove the front bezel](#).
4. [Remove all the drives](#)

CAUTION: To prevent damage to the drives and backplane, remove the drives from the system before removing the backplane.

5. [Remove the air shroud](#).
6. Disconnect the cables from the drive backplane.

Steps

1. Press the blue release tabs to disengage the drive backplane from the hooks on the system.
2. Lift and pull out the backplane out of the system.

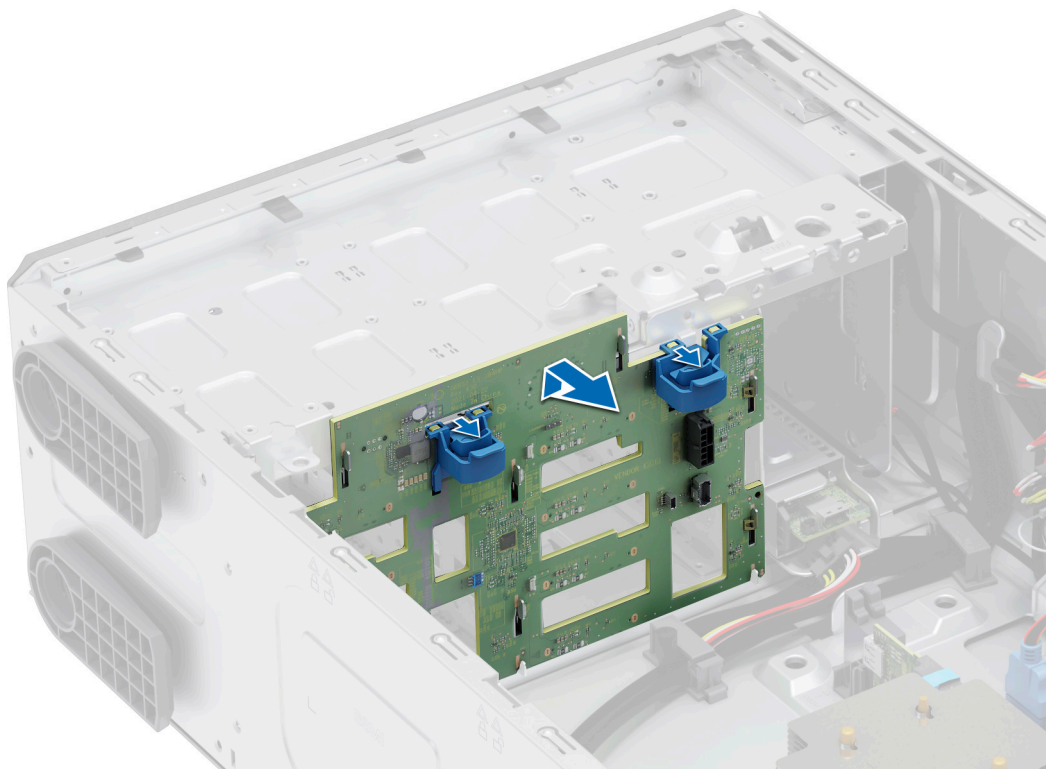

Figure 38. Removing the drive backplane

Next steps

[Replace a drive backplane](#).

Installing the drive backplane

Prerequisites

1. Follow the safety guidelines listed in [Safety instructions](#).
2. Follow the procedure listed in [Before working inside your system](#).

3. Remove the front bezel.
4. Remove all the drives.
- △ **CAUTION:** To prevent damage to the drives and backplane, remove the drives from the system before removing the backplane.
5. Remove the air shroud.
6. Disconnect the cables from the drive backplane.

Steps

1. Align the slots on the drive backplane with the guides on the system.
2. Slide the drive backplane into the guides and lower the backplane until the blue release tabs clicks into place.

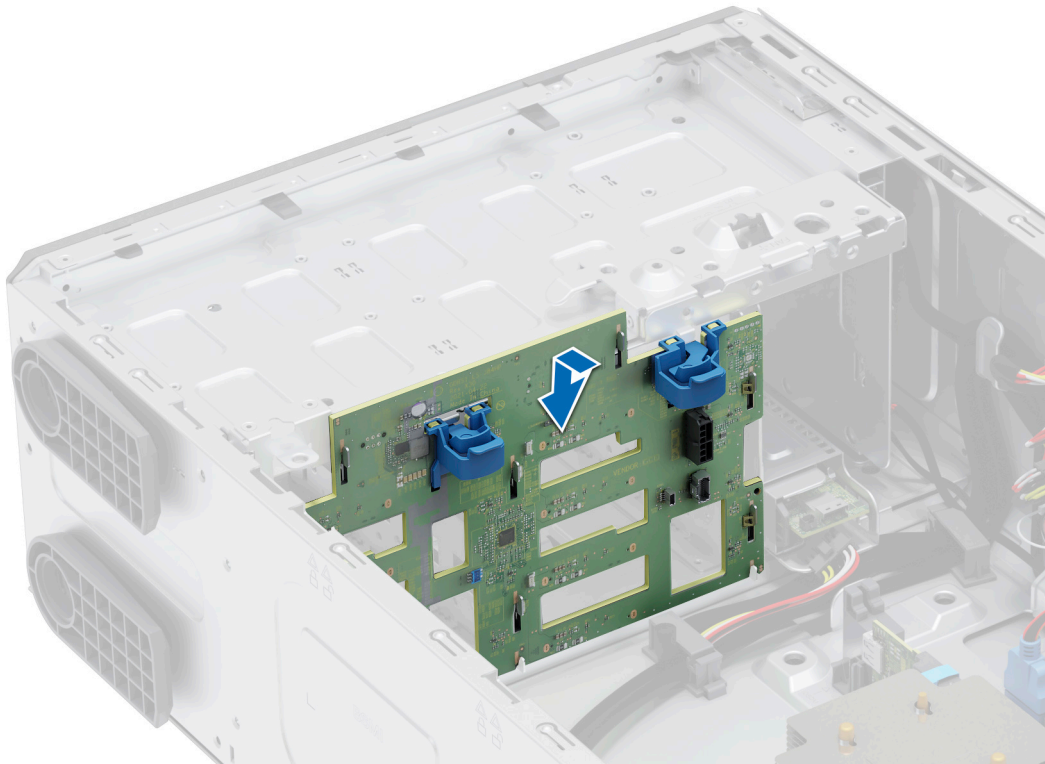

Figure 39. Installing the drive backplane

Next steps

1. Connect the cables into the drive backplane.
2. Install the air shroud.
3. Install the drives.
4. Install the front bezel.
5. Follow the procedure listed in [After working inside your system](#).

Cooling fans

Removing the cooling fan

Prerequisites

△ **CAUTION:** Never operate your system with the fan removed. The system can overheat and result in shutdown of the system and loss of data.

1. Follow the safety guidelines listed in [Safety instructions](#).

2. Follow the procedure listed in [Before working inside your system](#).
3. [Remove the air shroud](#).

Steps

1. Disconnect the fan cable from the connector on the system board.
2. Holding the fan, press the side release tab, and slide the fan in the direction of the arrow that is marked on the fan to remove it from the system.

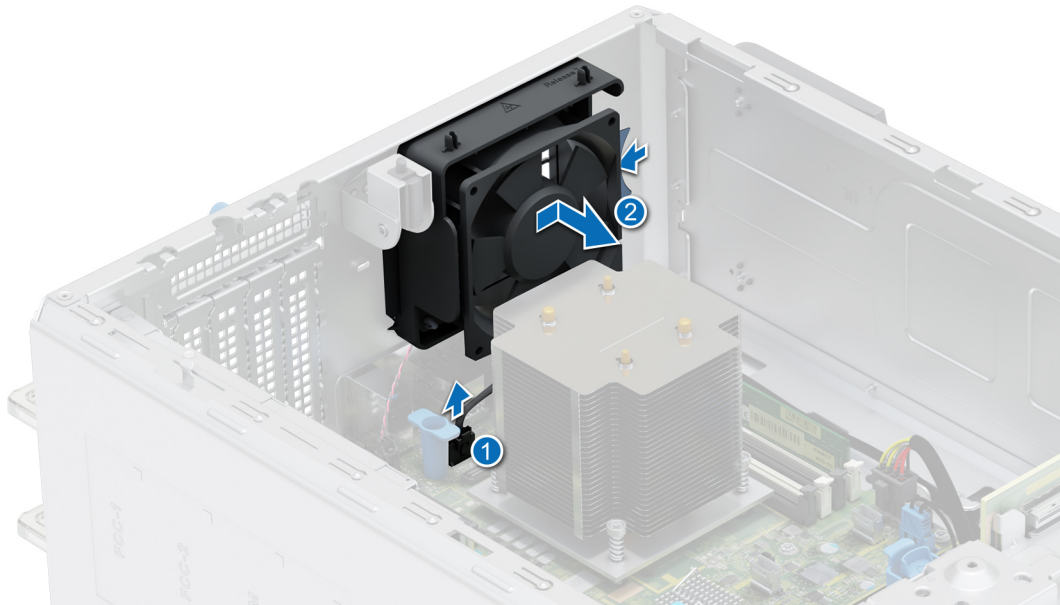

Figure 40. Removing the cooling fan

CAUTION: Do not remove or install the fan by holding the fan blades.

Next steps

1. [Replace the cooling fan](#).

Installing the cooling fan

Prerequisites

1. Follow the safety guidelines listed in [Safety instructions](#).
2. Follow the procedure listed in [Before working inside your system](#).
3. [Remove the air shroud](#).

Steps

1. Align the four tabs on the fan with the four slots on the system wall.
2. Press and slide the fan into the slots until the release tab locks into place.
3. Connect the fan cable to the connector on the system board.

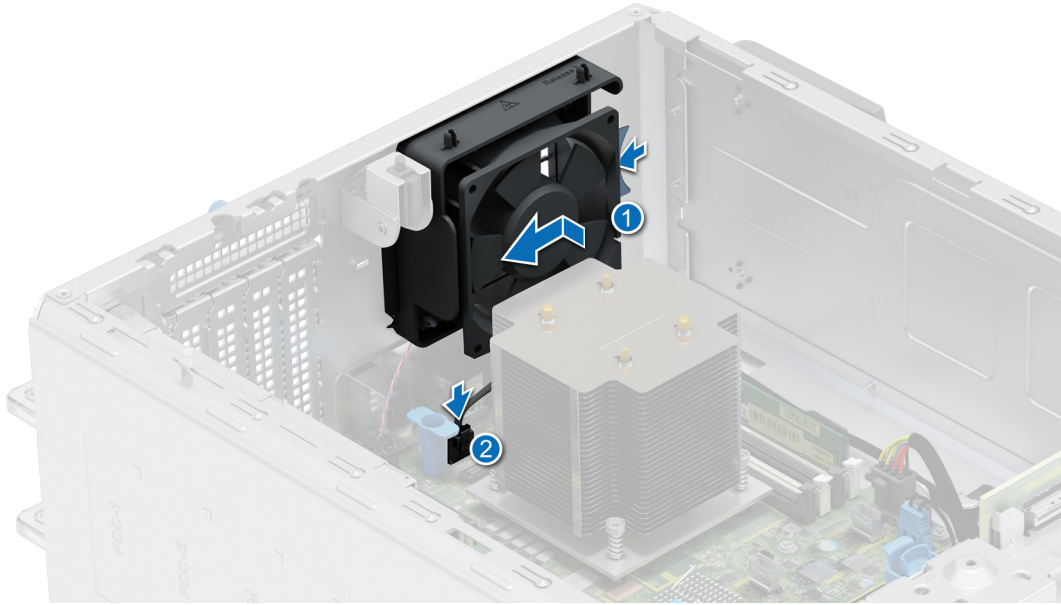

Figure 41. Installing the cooling fan

Next steps

1. Install the air shroud.
2. Follow the procedure listed in *After working inside your system.*

Cable routing

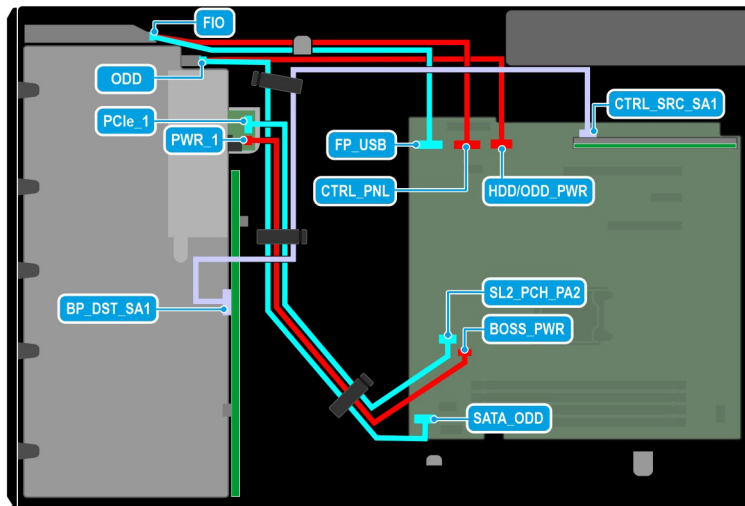

Figure 42. 8 x 3.5-inch drive system

Table 13. Connector descriptions for 8 x 3.5-inch drive system

From	To
CTRL_SRC_SA1 (backplane controller connector on system board)	BP_DST_SA1 (backplane signal connector)
BOSS_PWR (BOSS S2 module power connector on system board)	PWR_1 (BOSS S2 module power connector)
SL2_PCH_PA2 (signal connector on system board)	PCle_1 (BOSS S2 module signal connector)
SATA_ODD (optical disc drive SATA connector on system board) and HDD/ODD_PWR (optical disk drive power connector on system board)	ODD (optical disc drive connector)
FP_USB (front USB connector on system board) and CTRL_PNL (control panel connector on system board)	FIO (control panel connector)

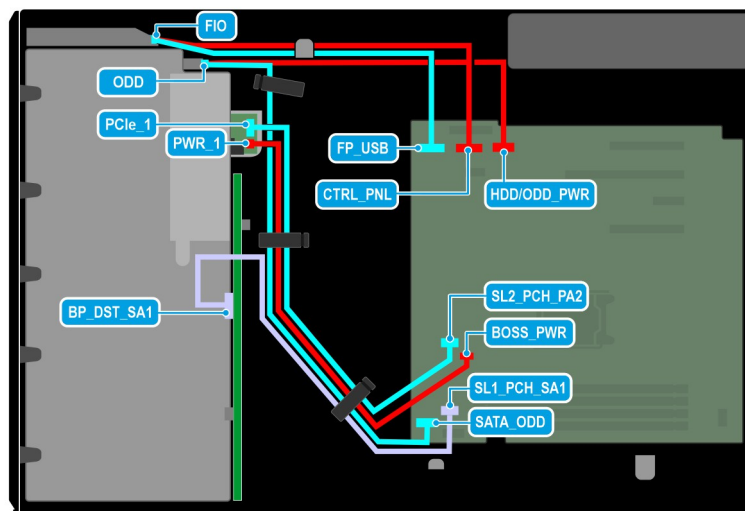

Figure 43. Cable routing - 4 x 3.5-inch drive system

Table 14. Connector descriptions for 4 x 3.5-inch drive system

From	To
SL1_PCH_SA1 (backplane signal connector on system board)	BP_DST_SA1 (backplane signal connector)
BOSS_PWR (BOSS S2 module power connector on system board)	PWR_1 (BOSS S2 module power connector)
SL2_PCH_PA2 (signal connector on system board)	PCle_1 (BOSS S2 module signal connector)
SATA_ODD (optical disc drive SATA connector on system board) and HDD/ODD_PWR (optical disk drive power connector on system board)	ODD (optical disc drive connector)
FP_USB (front USB connector on system board) and CTRL_PNL (control panel connector on system board)	FIO (control panel connector)

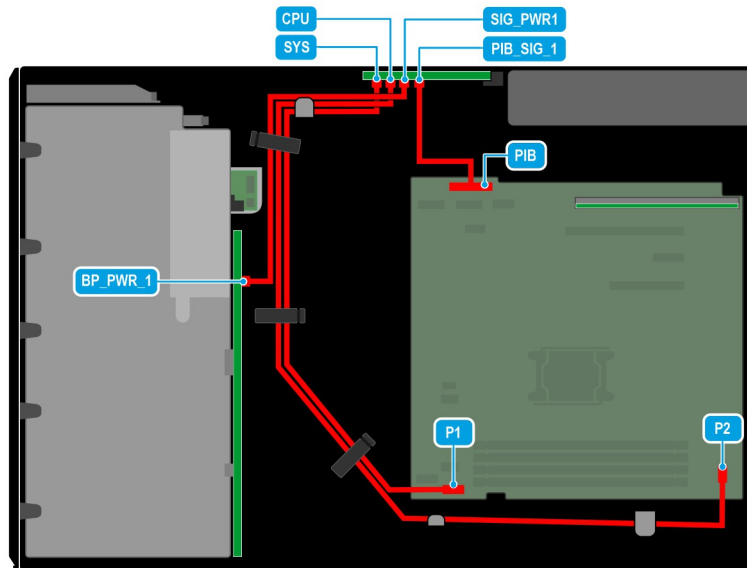

Figure 44. Cable routing - redundant PSU

Table 15. Connector descriptions for redundant PSU

From	To
SYS (system power connector on power interposer board)	P1 (system power connector on system board)
CPU (processor power connector on power interposer board)	P2 (processor power connector on system board)
SIG_PWR_1 (backplane power connector on power interposer board)	BP_PWR_1 (backplane power connector)
PIB_SIG_1 (power interposer board signal connector)	PIB (Power interposer board connector on system board)

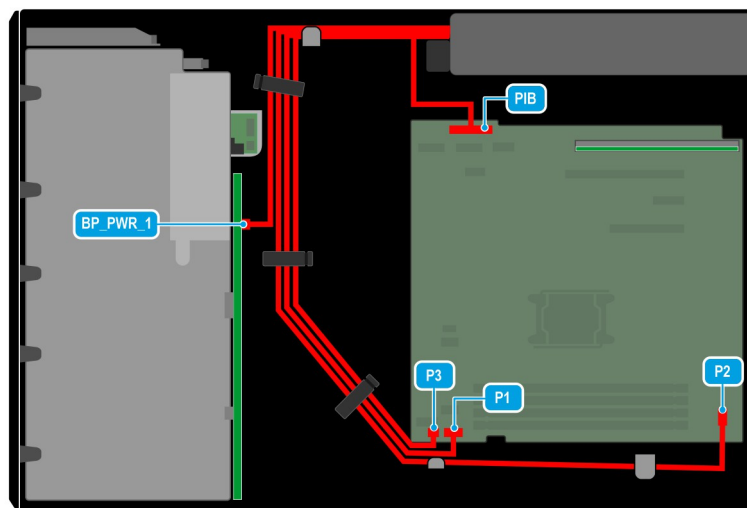

Figure 45. Cable routing - cabled PSU

Table 16. Connector descriptions for cabled PSU

From	To
Power cables from the PSU	P1 (system power connector on system board)
	P2 (processor power connector on system board)
	P3 (power event connector on system board)
	BP_PWR_1 (backplane power connector)
	PIB (Power interposer board connector on system board)

System memory

System memory guidelines

The PowerEdge T350 system supports DDR4 unregistered DIMMs (UDIMMs). System memory holds the instructions that are run by the processor.

Your system contains four memory sockets. Two memory channels are allocated to the processor.

Memory channels are organized as follows:

Table 17. Memory channels

Processor	Channel A	Channel B
Processor 1	A1, A3	A2, A4

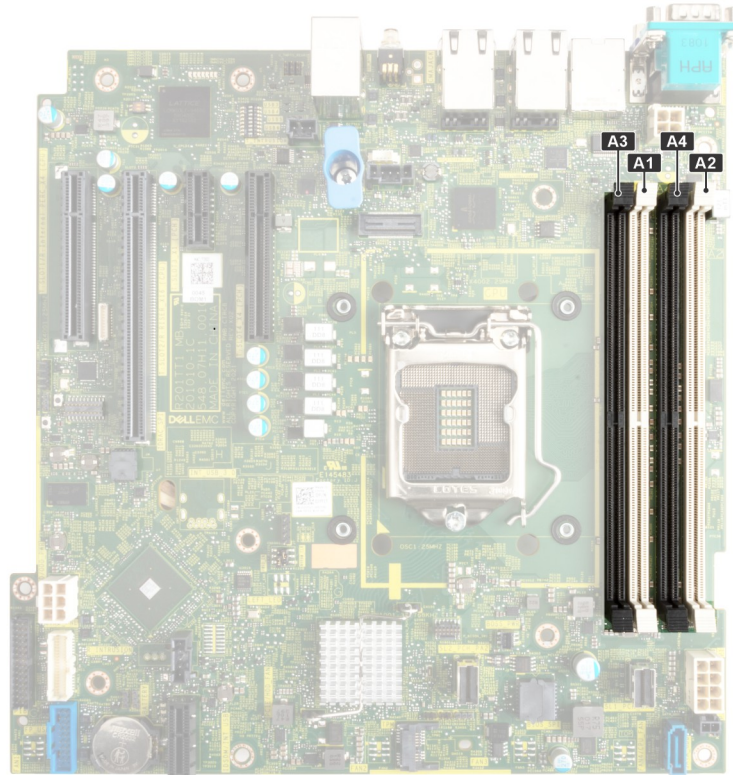

Figure 46. Memory socket location

Table 18. Supported memory matrix

DIMM type	Rank	Capacity	DIMM rated voltage and speed	Operating speed for DIMMs per Channel (DPC)
UDIMM	1 R	8 GB/16 GB	DDR4 (1.2 V), 3200 MT/s	3200 MT/s
	2 R	32 GB	DDR4 (1.2 V), 3200 MT/s	3200 MT/s

NOTE: Dual rank UDIMMs with two DIMMs per channel (2 DPC) limits the speed to 2933 MT/s.

General memory module installation guidelines

To ensure optimal performance of your system, observe the following general guidelines when configuring your system memory. If your system's memory configurations fail to observe these guidelines, your system might not boot, stop responding during memory configuration, or operate with reduced memory.

The memory bus may operate at speeds up to 2933 MT/s depending on the following factors:

- System profile selected (for example, Performance Optimized, or Custom [can be run at high speed or lower])
- Maximum supported DIMM speed of the processor
- Maximum supported speed of the DIMMs
- Rank of the DIMMs

NOTE: MT/s indicates DIMM speed in Mega-Transfers per second.

The system supports Flexible Memory Configuration, enabling the system to be configured and run in any valid chipset architectural configuration. The following are the recommended guidelines for installing memory modules:

- All DIMMs must be DDR4.
- If memory modules with different speeds are installed, they operate at the speed of the slowest installed memory module.
- Populate memory module sockets only if a processor is installed.
 - For single-processor systems, sockets A1 to A4 is available.
- In **Optimizer Mode**, the DRAM controllers operate independently in the 64-bit mode and provide optimized memory performance.

NOTE: DIMM speed is limited to 2933 MT/s when mixing dual rank DIMMs with single rank or dual rank DIMMs in the same channel.

Table 19. Memory population rules

Processor	Configuration	Memory population	Memory population information
Single processor	Optimizer (Independent channel) population order	A{1}, A{2}, A{3}, A{4}	1, 2, 3, 4 DIMMs are allowed.

- Populate all the sockets with white release tabs first, followed by the black release tabs.
- Unbalanced or odd memory configuration results in a performance loss and system may not identify the memory modules being installed, so always populate memory channels identically with equal DIMMs for best performance.

Removing a memory module

Prerequisites

1. Follow the safety guidelines listed in the [Safety instructions](#).
2. Follow the procedure listed in the [Before working inside your system](#).
3. [Remove the air shroud](#).

WARNING: The memory modules are hot to touch for some time after the system has been powered off. Allow the memory modules to cool before handling them.

NOTE: To ensure proper system cooling, memory module blanks must be installed in any memory socket that is not occupied. Remove memory module blanks only if you intend to install memory modules in those sockets.

Steps

1. Locate the appropriate memory module socket.
2. To release the memory module from the socket, simultaneously press the ejectors on both ends of the memory module socket to fully open.

CAUTION: Handle each memory module only by the card edges, ensuring not to touch the middle of the memory module or metallic contacts.

3. Lift the memory module away from the system.

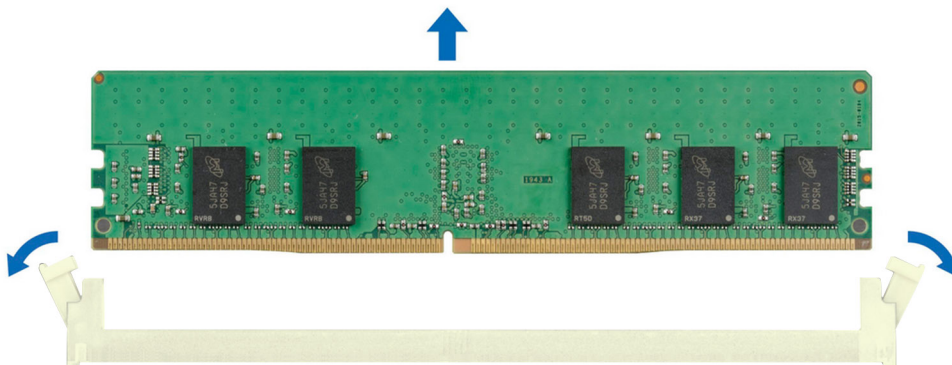

Figure 47. Removing a memory module

Next steps

Replace the memory module.

Installing a memory module

Prerequisites

1. Follow the safety guidelines listed in the [Safety instructions](#).
2. Follow the procedure listed in the [Before working inside your system](#).
3. [Remove the air shroud](#).

Steps

1. Locate the appropriate memory module socket.

CAUTION: Handle each memory module only by the card edges, ensuring not to touch the middle of the memory module or metallic contacts.

2. If a memory module is installed in the socket, remove it.

NOTE: Ensure the socket ejector latches are fully open, before installing the memory module.

3. Align the edge connector of the memory module with the alignment key of the memory module socket, and insert the memory module in the socket.

CAUTION: To prevent damage to the memory module or the memory module socket during installation, do not bend or flex the memory module; insert both ends of the memory module simultaneously.

NOTE: The memory module socket has an alignment key that enables you to install the memory module in the socket in only one orientation.

CAUTION: Do not apply pressure at the center of the memory module; apply pressure at both ends of the memory module evenly.

4. Press the memory module with your thumbs until the ejectors firmly click into place. When the memory module is properly seated in the socket, the levers on the memory module socket align with the levers on the other sockets that have memory modules installed.

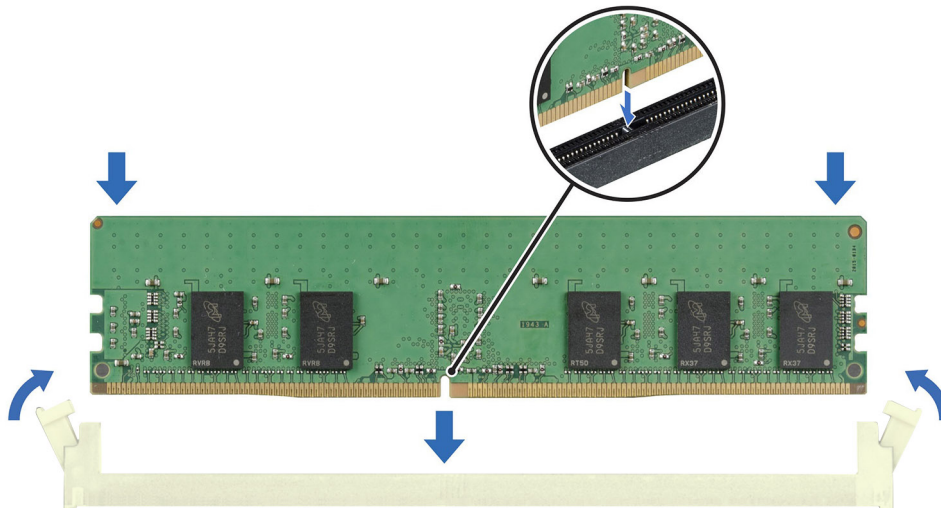

Figure 48. Installing a memory module

Next steps

1. [Install the air shroud.](#)
2. Follow the procedure listed in [After working inside your system.](#)
3. To verify if the memory module has been installed properly, press F2 and navigate to **System Setup Main Menu > System BIOS > Memory Settings**. In the **Memory Settings** screen, the System Memory Size must reflect the updated capacity of the installed memory.
4. If the System Memory Size is incorrect, one or more of the memory modules may not be installed properly. Ensure that the memory modules are firmly seated in their sockets.
5. Run the system memory test in system diagnostics.

Processor and heat sink module

This is a service technician replaceable part only.

Removing the heat sink

Prerequisites

⚠ WARNING: The heat sink may be hot to touch for some time after the system has been powered off. Allow the heat sink to cool before removing it.

1. Follow the safety guidelines listed in the [Safety instructions](#).
2. Follow the procedure listed in [Before working inside your system](#).
3. [Remove the air shroud](#).

Steps

1. Using a Phillips 2 screwdriver, loosen the captive screws on the heat sink in the order mentioned below:
 - a. Loosen the first captive screw three turns.
 - b. Loosen the captive screw diagonally opposite to the screw you loosened first.
 - c. Repeat the procedure for the remaining two captive screws.
 - d. Return to the first screw to loosen it completely.
2. Lift the heat sink away from the system.

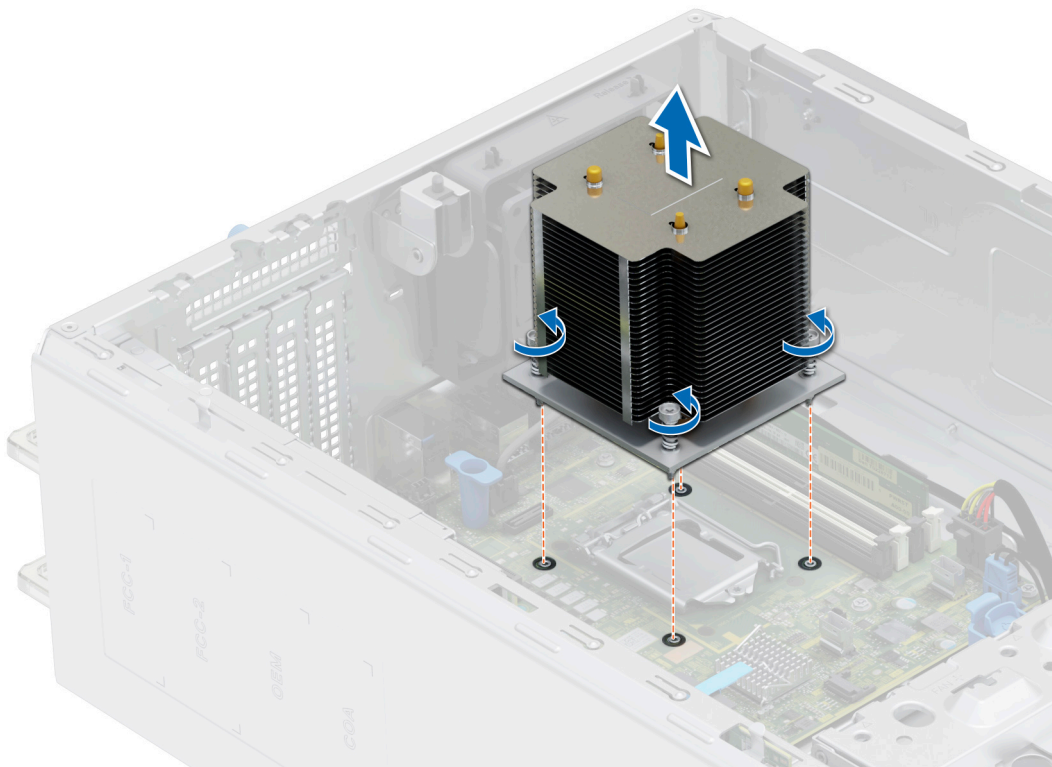

Figure 49. Removing the heat sink

Next steps

[Replace the heat sink.](#)

Removing the processor

Prerequisites

⚠ WARNING: The processor will be hot to touch for some time after the system has been powered down. Allow the processor to cool before removing it.

⚠ CAUTION: The processor is held in its socket under strong pressure. Be aware that the release lever can spring up suddenly if not firmly held.

ⓘ NOTE: Only remove the processor if you are replacing the processor or system board. This procedure is not required when replacing a heat sink module.

1. Follow the safety guidelines listed in the [Safety instructions](#).
2. Follow the procedure listed in [Before working inside your system](#).
3. [Remove the heat sink module](#).

Steps

1. Release the socket lever by pushing the lever down and out from under the tab on the processor shield.
2. Lift the lever upward until the processor shield lifts.

⚠ CAUTION: The processor socket pins are fragile and can be permanently damaged. Be careful not to bend the pins in the processor socket when removing the processor out of the socket.

3. Lift the processor out of the socket.

ⓘ NOTE: Ensure that the processor and the bracket are placed in the tray after you remove the heat sink.

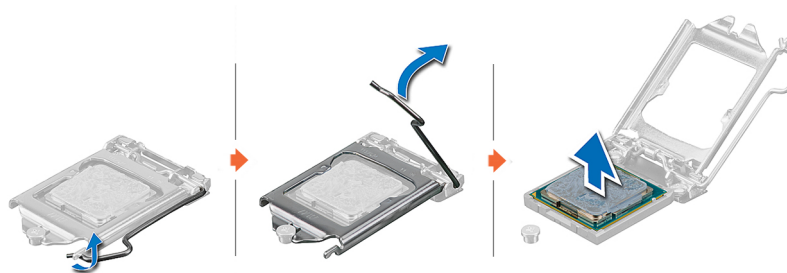

Figure 50. Removing the processor

Next steps

[Replace the processor.](#)

Installing the processor

Prerequisites

⚠ CAUTION: Never remove the heat sink from a processor unless you intend to replace the processor. The heat sink is necessary to maintain proper thermal conditions.

1. Follow the safety guidelines listed in the [Safety instructions](#).
2. Follow the procedure listed in [Before working inside your system](#).
3. [Remove the processor](#).

Steps

1. Align the pin 1 indicator of the processor with the triangle on the socket and place the processor on the socket.

CAUTION: Positioning the processor incorrectly can permanently damage the system board or the processor. Be careful not to bend the pins in the socket.

2. Lower the socket lever and push it under the tab to lock it.

NOTE: If the processor has previously been used in a system, remove any remaining thermal grease from the processor by using a lint-free cloth.

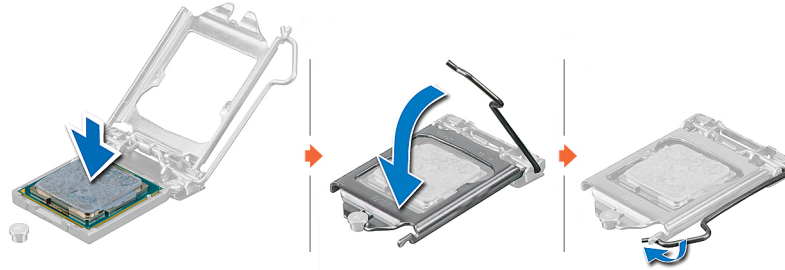

Figure 51. Installing the processor

Next steps

NOTE: Ensure that you install the heat sink after you install the processor. The heat sink is necessary to maintain proper thermal conditions.

1. Install the heat sink module.
2. Follow the procedure listed in [After working inside your system](#).

Installing the heat sink

Prerequisites

CAUTION: Never remove the heat sink from a processor unless you intend to replace the processor. The heat sink is necessary to maintain proper thermal conditions.

1. Follow the safety guidelines listed in the [Safety instructions](#).
2. Follow the procedure listed in [Before working inside your system](#).
3. If removed, [install the processor](#).

Steps

1. If you are using an existing heat sink, remove the thermal grease from the heat sink by using a clean lint-free cloth.
2. Use the thermal grease syringe included with your processor kit to apply the grease in a quadrilateral design on the top of the processor.

CAUTION: Applying too much thermal grease can result in excess grease coming in contact with and contaminating the processor socket.

NOTE: The thermal grease syringe is intended for single use only. Dispose the syringe after you use it.

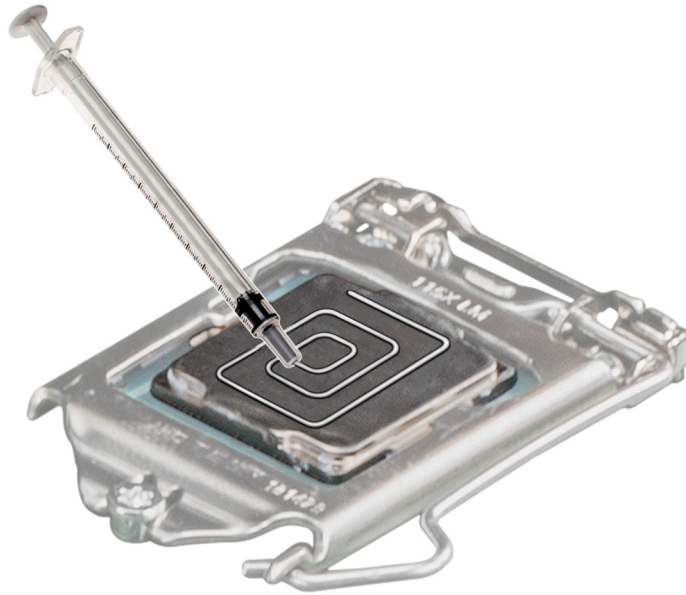

Figure 52. Applying thermal grease on top of the processor

3. Align the captive screws on the heat sink with the hole on the system board.
4. Using the Phillips 2 screwdriver, tighten the captive screws on the heat sink in the order below:
 - a. In a random order, tighten the captive screws three turns.
 - b. Tighten the captive screw diagonally opposite to the screw you tighten first.
 - c. Repeat the procedure for the remaining two captive screws.
 - d. Return to the first screw to tighten it completely.
 - e. Check all the captive screws to ensure they are firmly secured.

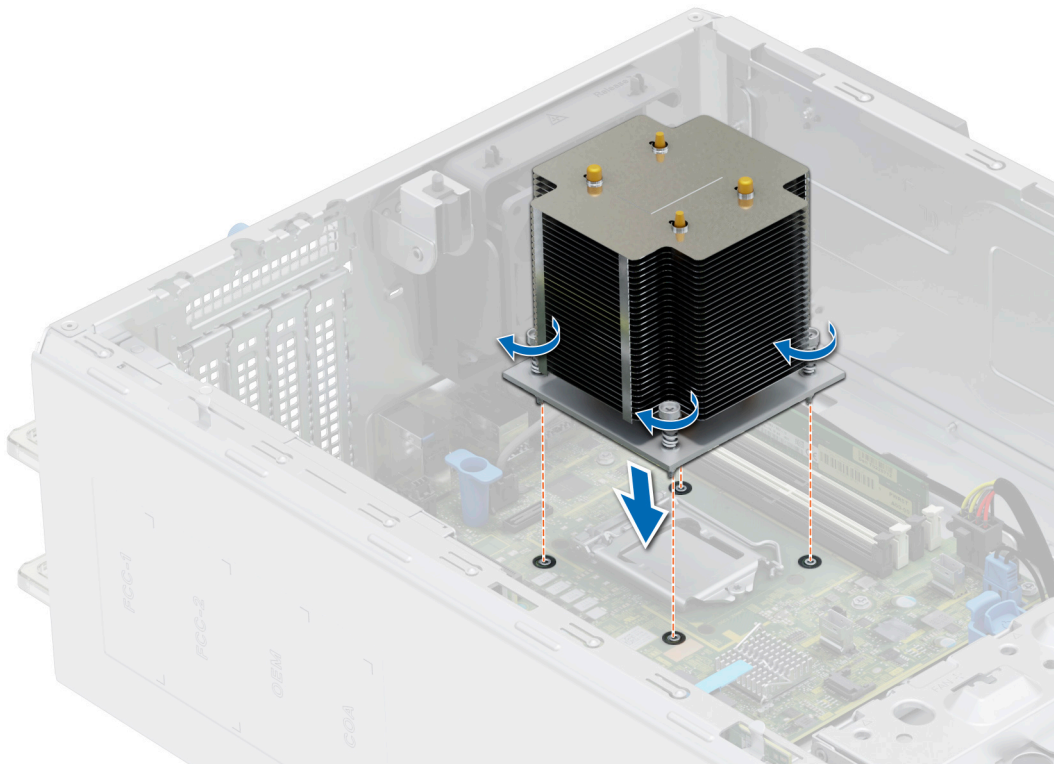

Figure 53. Installing the heat sink

Next steps

1. Install the air shroud.
2. Follow the procedure listed in [After working inside your system](#).
3. While booting, press **F2** to enter **System Setup** and check that the processor information matches the new system configuration.
4. Run the system diagnostics to verify that the new processor operates correctly.

Expansion cards

NOTE: When an expansion card is not supported or missing, the iDRAC and Lifecycle Controller logs an event. This does not prevent your system from booting. However, if a F1/F2 pause occurs with an error message, see *Troubleshooting expansion cards* section in the *Dell EMC PowerEdge Servers Troubleshooting Guide* at www.dell.com/poweredgemanuals.

Expansion card installation guidelines

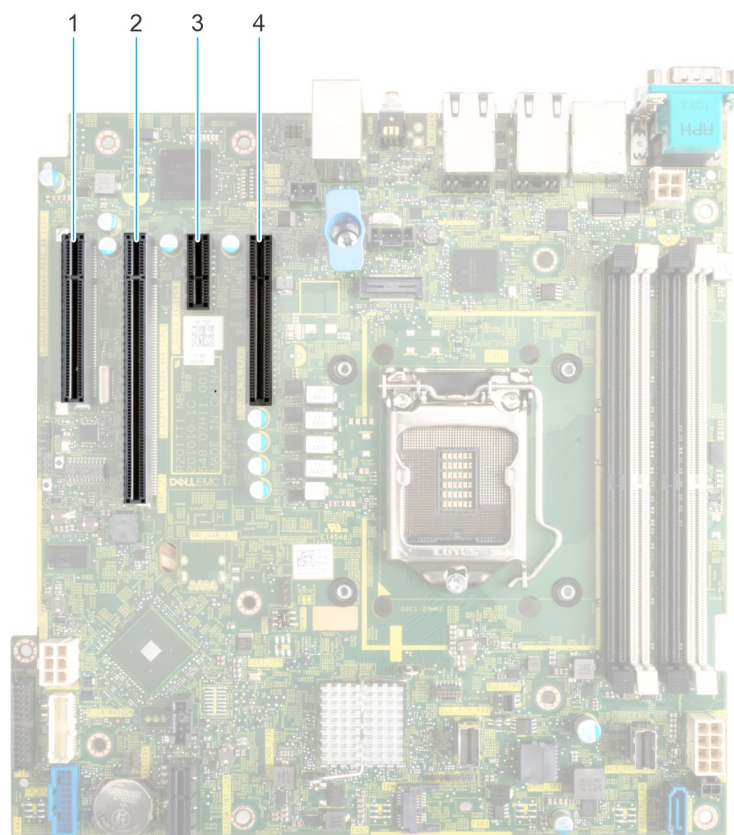

Figure 54. Expansion card slot connectors

- | | |
|-----------|-----------|
| 1. Slot 1 | 2. Slot 2 |
| 3. Slot 3 | 4. Slot 4 |

The following table describes the expansion card riser configurations:

Table 20. Expansion card slots supported on the system board

PCIe slot	Risers	Processor connection	PCIe slot height	PCIe slot length	PCIe slot width
Slot 1 (Gen4)	N/A	Processor 1	Full height	Half length	x4 link in x8 slot

Table 20. Expansion card slots supported on the system board (continued)

PCIe slot	Risers	Processor connection	PCIe slot height	PCIe slot length	PCIe slot width
Slot 2 (Gen4)	N/A	Processor 1	Full height	Full length	x16
Slot 3 (Gen3)	N/A	Platform Controller Hub	Full height	Half length	x1
Slot 4 (Gen3)	N/A	Platform Controller Hub	Full height	Half length	x4 link in x8 slot

NOTE: Slot 1 is disabled, when system is installed with Intel Pentium processor.

NOTE: The expansion-card slots are not hot-swappable.

The following table provides guidelines for installing expansion cards to ensure proper cooling and mechanical fit. The expansion cards with the highest priority should be installed first using the slot priority indicated. All the other expansion cards should be installed in the card priority and slot priority order.

Table 21. Configuration : No Riser

Card type	Slot priority	Maximum number of cards
Foxconn (APERC 11)	2	1
Foxconn (APERC HBA11)	2, 1	2
Foxconn (external adapter)	2, 1	2
Foxconn (APERC 10.15)	2	1
Broadcom (NIC: 1Gb)	2, 1, 4	3
Intel (NIC: 1Gb)	2, 1, 4	3
BOSS S2 Module	Integrated slot	1

Removing an expansion card

Prerequisites

1. Follow the safety guidelines listed in [Safety instructions](#).
2. Follow the procedure listed in [Before working inside your system](#).
3. If required, [remove the air shroud](#).
4. Disconnect any cables that are connected to the expansion card.

Steps

1. Loosen the captive screw and tilt the metal bracket that holds the expansion cards.
2. Hold the expansion card by the edges, and pull the card up to remove it from the expansion card connector on the system board.

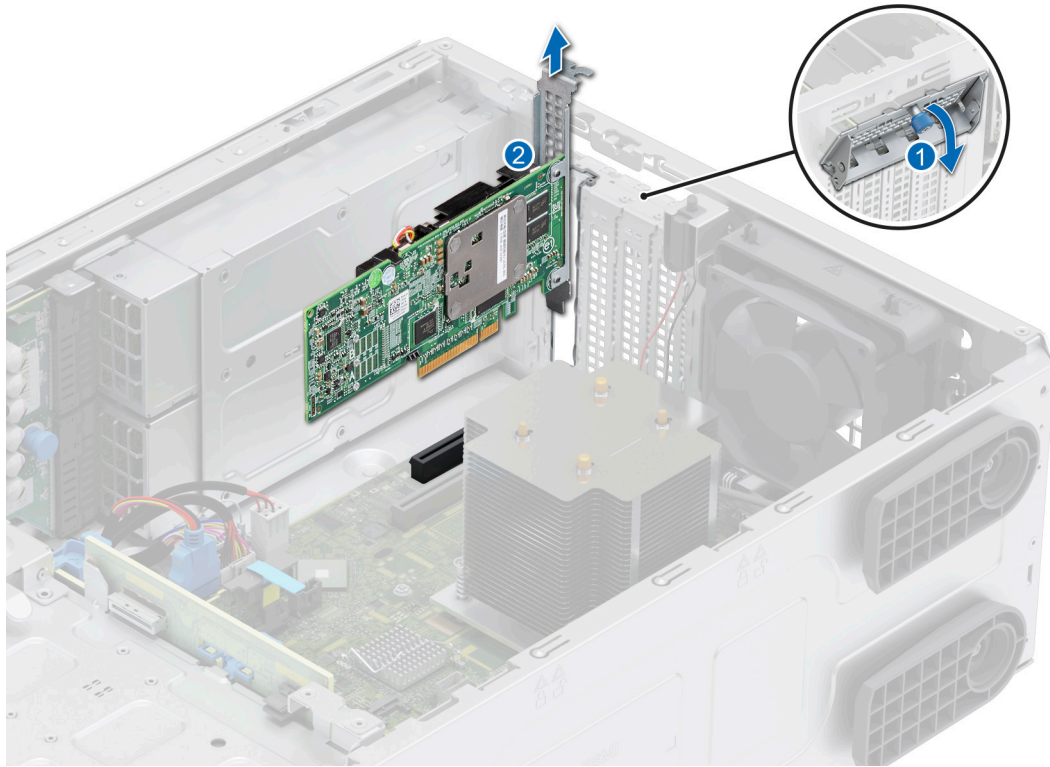

Figure 55. Removing an expansion card

3. If the expansion card is not going to be replaced, install metal filler.
4. Tilt the metal bracket and tighten the captive screw.

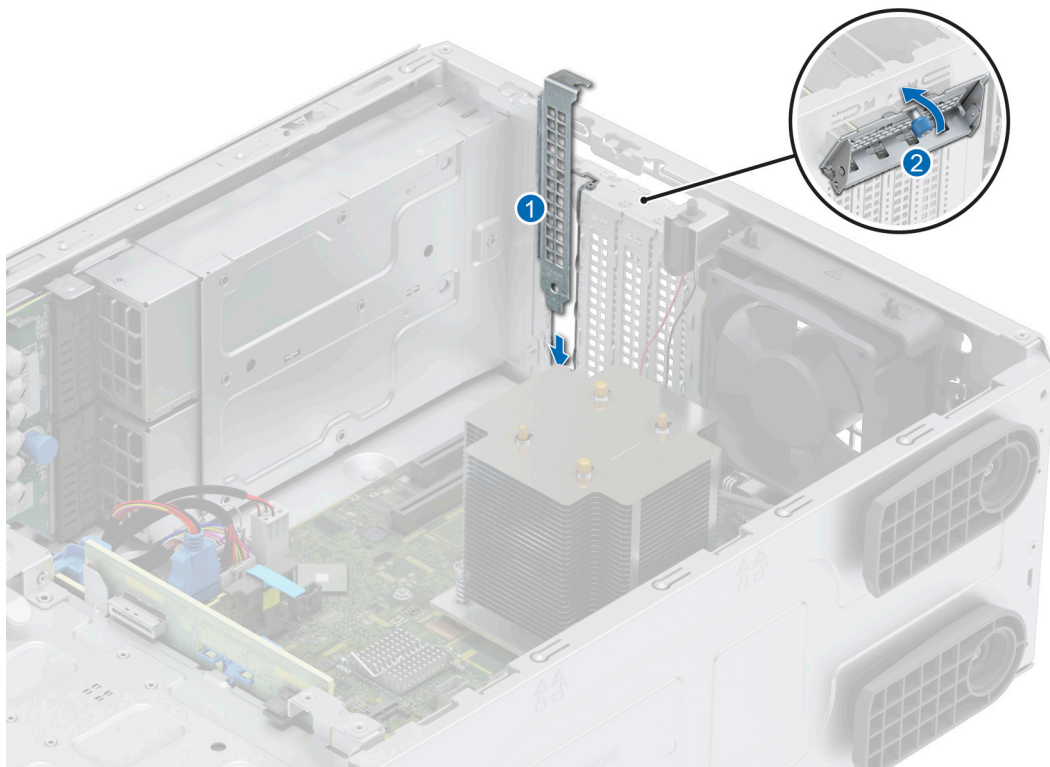

Figure 56. Installing the metal filler

NOTE: Filler brackets must be installed in empty expansion-card slots to maintain FCC certification of the system. The brackets also keep dust and dirt out of the system and aid in proper cooling and airflow inside the system.

Next steps

Replace an expansion card.

Installing an expansion card

Prerequisites

1. Follow the safety guidelines listed in [Safety instructions](#).
2. Follow the procedure listed in [Before working inside your system](#).
3. If required, [remove the air shroud](#).

Steps

1. Loosen the captive screw and tilt the metal bracket that holds the metal filler.

NOTE: Store this bracket for future use. Filler brackets must be installed in empty expansion-card slots to maintain FCC certification of the system. The brackets also keep dust and dirt out of the system and aid in proper cooling and airflow inside the system.

2. Lift the metal filler out of the system.

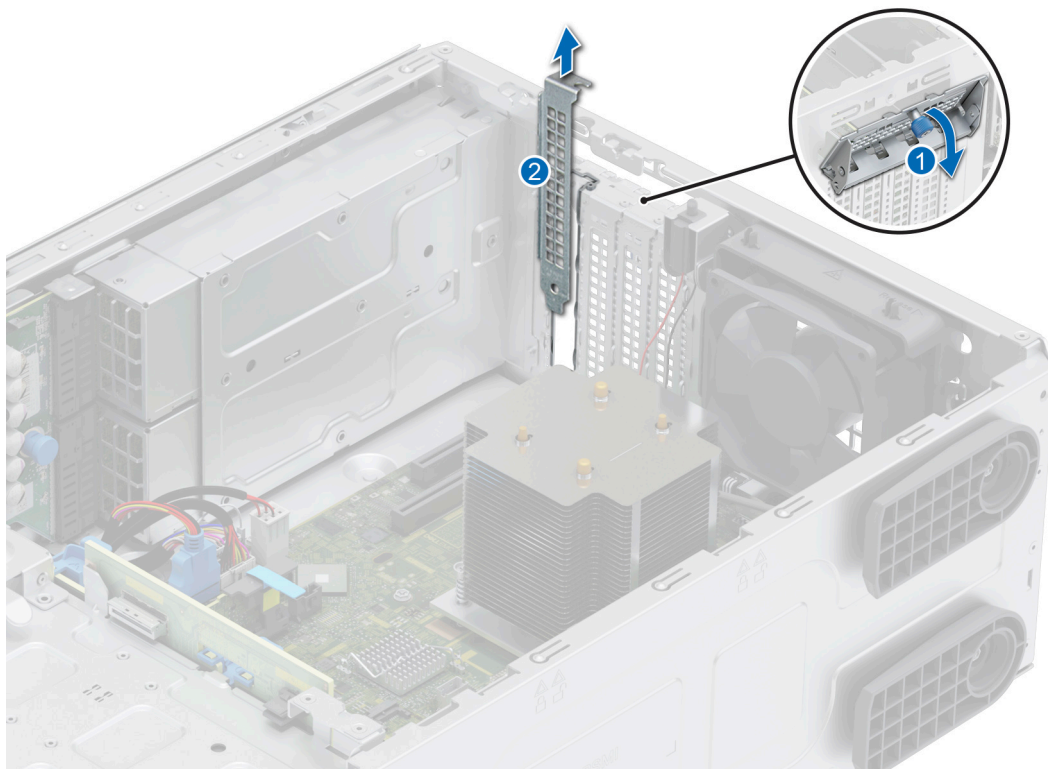

Figure 57. Removing the metal filler

3. Holding the card by the edges, align the card with the expansion card slot on the system board.
4. Insert the card firmly into the expansion card slot until the card is firmly seated.

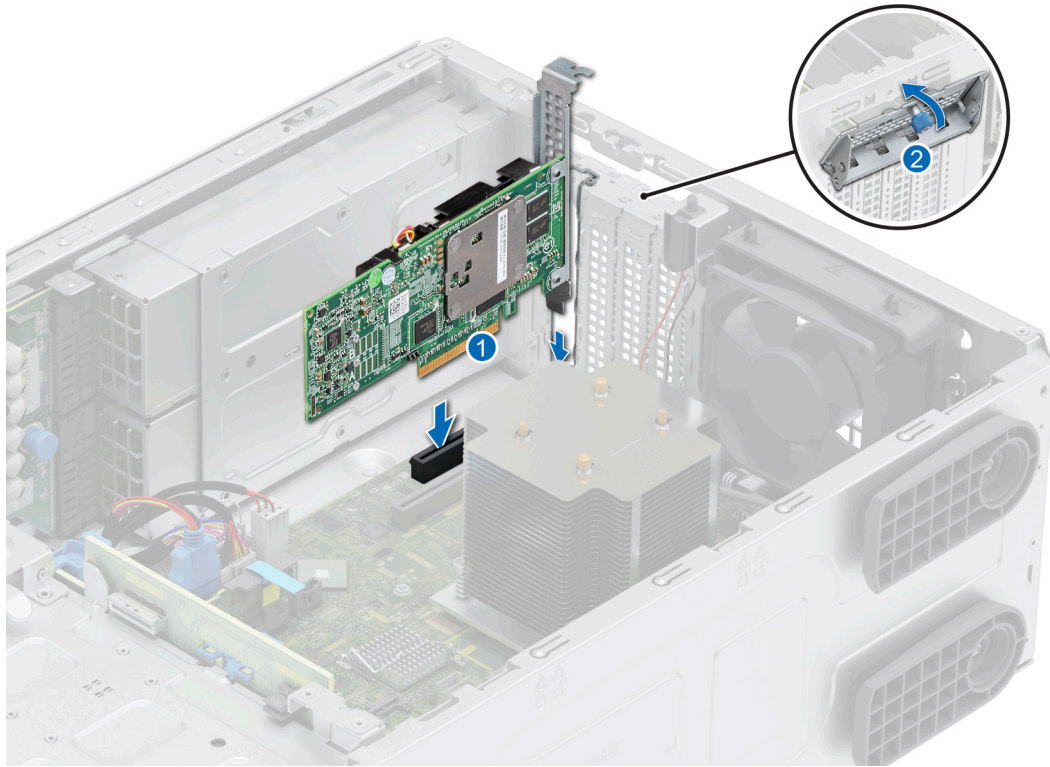

Figure 58. Installing an expansion card

5. Tilt the metal bracket and tighten the captive screw.

Next steps

1. If required, reconnect the cables to the expansion card.
2. [Install the air shroud.](#)
3. Follow the procedure listed in [After working inside your system.](#)

Optional BOSS S2 module

Removing the BOSS S2 module blank

Prerequisites

1. Follow the safety guidelines listed in [Safety instructions.](#)
2. Follow the procedure listed in [Before working inside your system.](#)
3. [Remove the front bezel.](#)

Steps

Loosen the captive screw and pull out the BOSS S2 module blank from the system bay.

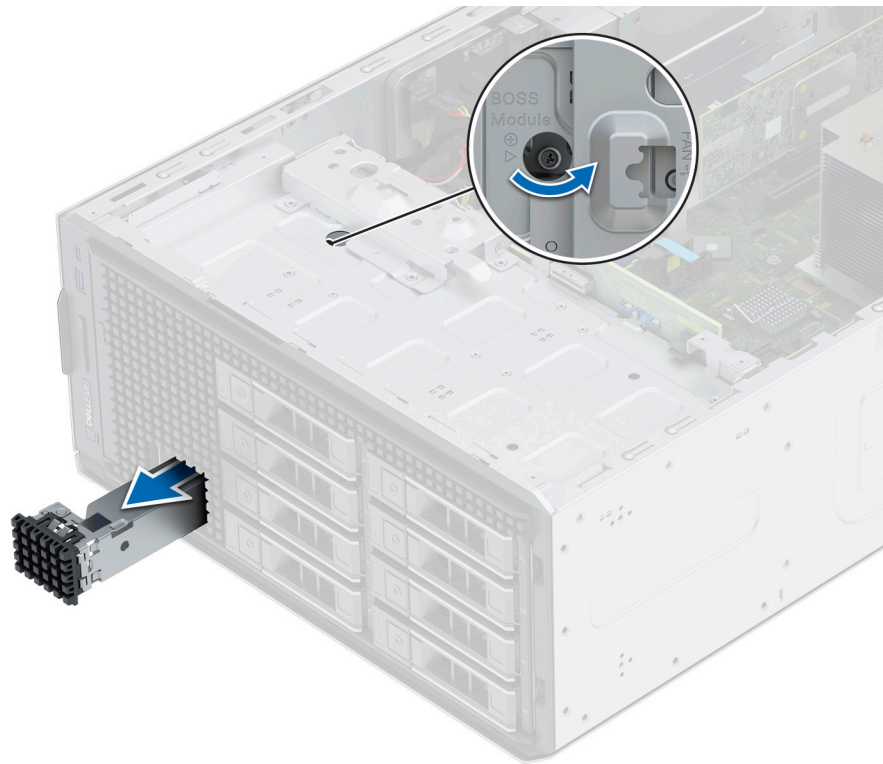

Figure 59. Removing the BOSS S2 module blank

Next steps

1. [Replace the BOSS S2 module blank](#) or install BOSS S2 card module.

Installing the BOSS S2 module blank

Prerequisites

1. Follow the safety guidelines listed in [Safety instructions](#).
2. Follow the procedure listed in [Before working inside your system](#).
3. [Remove the front bezel](#).

Steps

1. Align and slide the BOSS S2 module blank into the system bay.
2. Hold the BOSS S2 module blank into its place and tighten the captive screw.

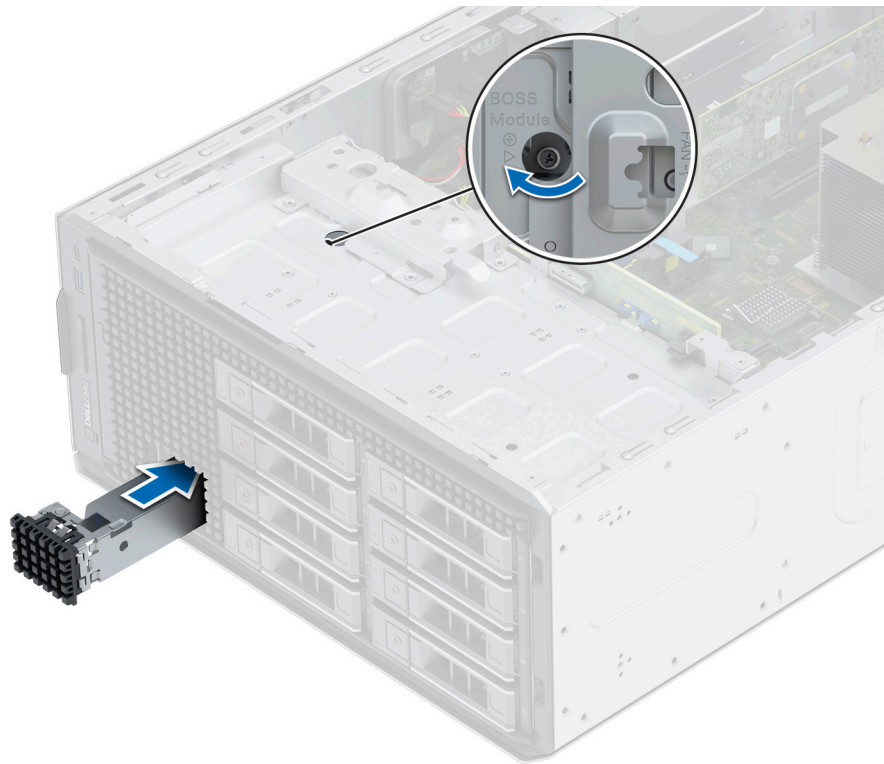

Figure 60. Installing the BOSS S2 module blank

Removing the BOSS S2 card carrier blank

Prerequisites

Follow the safety guidelines listed in the [Safety instructions](#).

Steps

Press and pull the BOSS S2 card carrier blank out from the BOSS S2 module.



Figure 61. Removing the BOSS S2 card carrier blank

Next steps

1. [Replace the BOSS S2 card carrier blank](#) or install BOSS S2 card carrier.

Installing the BOSS S2 card carrier blank

Prerequisites

1. Follow the safety guidelines listed in the [Safety instructions](#).

Steps

Align the blank with the BOSS S2 module bay and push it into the bay until it clicks into place.



Figure 62. Installing the BOSS S2 card carrier blank

Removing the BOSS S2 module

Prerequisites

1. Follow the safety guidelines listed in the [Safety instructions](#).
2. Follow the procedure listed in the [Before working inside your system](#).
3. [Remove the front bezel](#).
4. Disconnect the BOSS S2 power and signal cable from the BOSS S2 module and the system board.

Steps

1. Pull and lift the BOSS S2 card carrier retention latch lock to open.
2. Slide the BOSS S2 card carrier out.



Figure 63. Removing the BOSS S2 card carrier

NOTE: If BOSS S2 card carrier is not being replaced insert BOSS S2 card carrier blank.

3. Using the Phillips 1 screwdriver remove the M3 x 0.5 x 4.5 mm screw that secures the M.2 SSD to the BOSS S2 card carrier.
4. Slide the M.2 SSD out from the BOSS S2 card carrier.

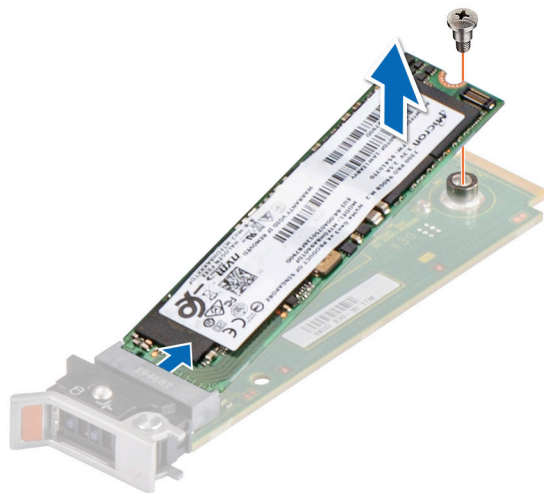

Figure 64. Removing the M.2 SSD

5. Loosen the captive screw and pull out the BOSS module cage along with BOSS S2 module form the system bay.

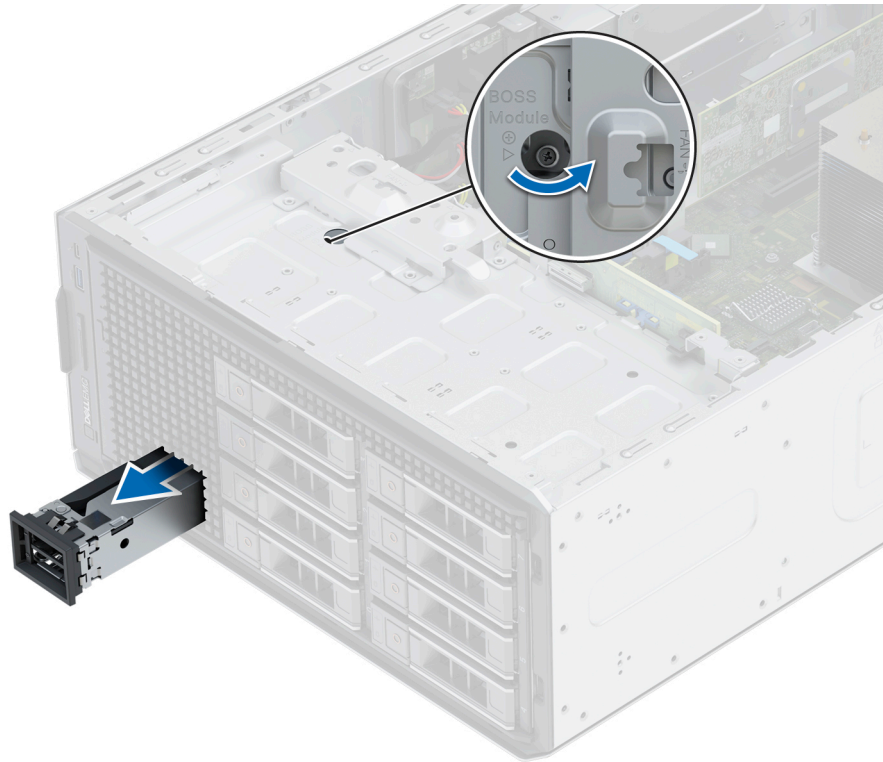

Figure 65. Removing the BOSS module cage

NOTE: If BOSS S2 module cage is not being replaced insert BOSS S2 module blank.

6. Using the Phillips 1 screwdriver remove the screw that secures the BOSS S2 module on BOSS module cage.
7. Slide out and lift the BOSS S2 module from the BOSS module cage.

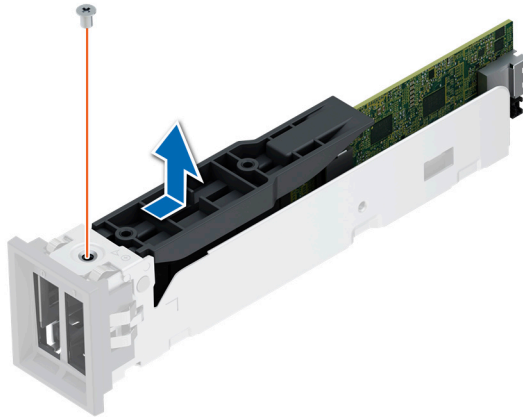

Figure 66. Removing the BOSS S2 module

Next steps

1. [Replace the BOSS S2 module](#) or [Install the BOSS S2 module blank](#).

Installing the BOSS S2 module

Prerequisites

1. Follow the safety guidelines listed in the [Safety instructions](#).
2. Follow the procedure listed in the [Before working inside your system](#).
3. [Remove the front bezel](#).
4. [Remove the BOSS S2 module blank](#).
5. Disconnect the BOSS S2 power and signal cable from the module and system board.

Steps

1. Align and slide the BOSS S2 module into BOSS S2 module cage and secure it with a screw using the Phillips 1 screwdriver.

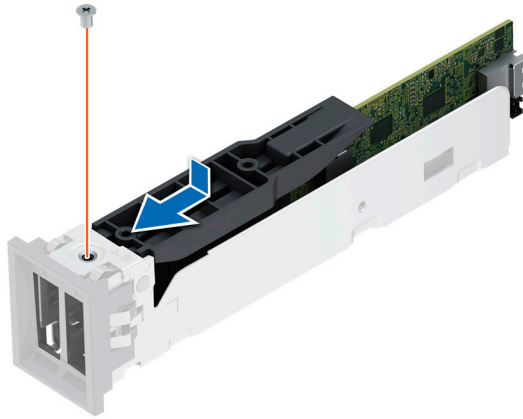

Figure 67. Installing the BOSS S2 module

NOTE: Remove BOSS S2 module blank, if installed.

2. Insert the BOSS S2 module and push the module horizontally towards the rear of the system.
3. Hold the module into place and tighten the captive screw.

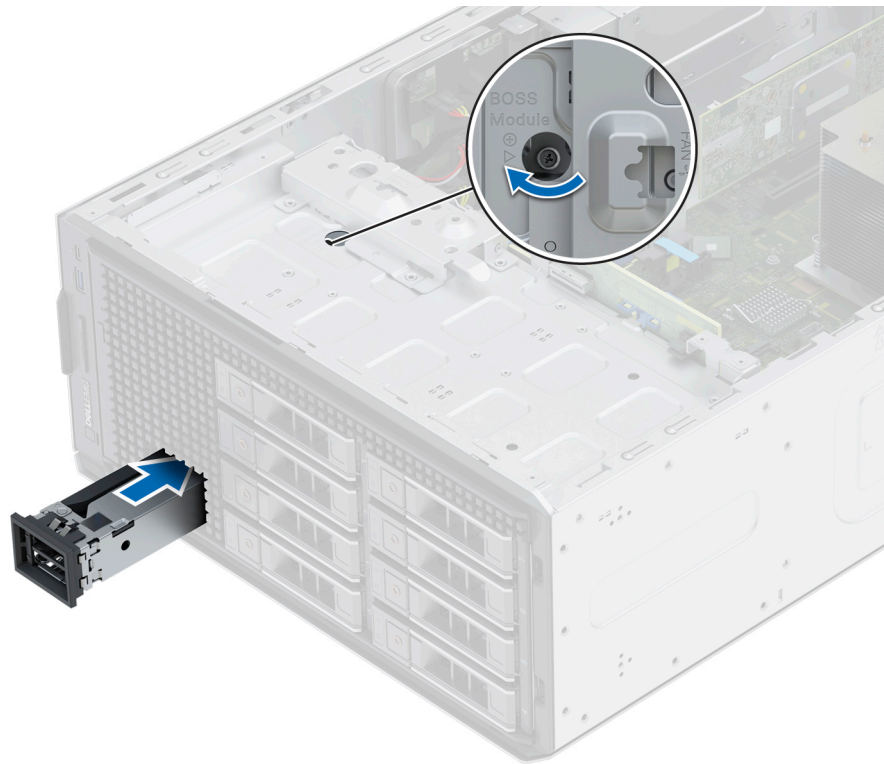

Figure 68. Installing the BOSS S2 module

4. Align the M.2 SSD at an angle with the BOSS S2 card carrier.
5. Insert the M.2 SSD until it is firmly seated in the BOSS S2 card carrier.
6. Using the Phillips 1 screwdriver, secure the M.2 SSD on the BOSS S2 card carrier with the M3 x 0.5 x 4.5 mm screw.

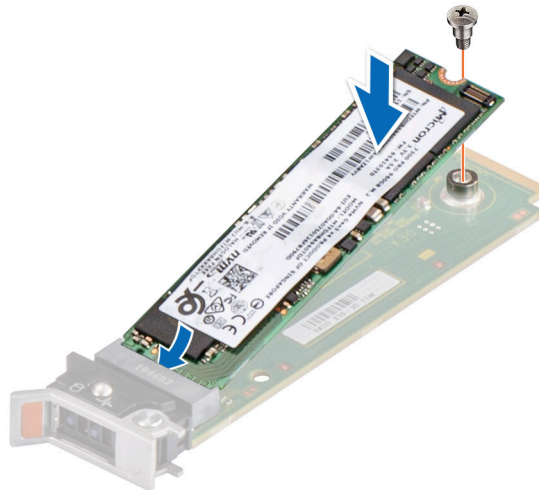

Figure 69. Installing the M.2 SSD

NOTE: Remove BOSS S2 card carrier filler, if installed.

7. Slide the BOSS S2 card carrier into the BOSS S2 module slot.
8. Close the BOSS S2 card carrier release latch to lock the carrier in place.



Figure 70. Installing the BOSS S2 card carrier

Next steps

1. Connect the BOSS S2 power and signal cables to the connectors on the BOSS S2 module and system board.
NOTE: Insert the BOSS S2 power and signal cable through the cable clip.
2. Follow the procedure listed in the [After working inside your system](#).
3. [Install the front bezel](#).

Optional IDSDM module

Removing the IDSDM module

Prerequisites

1. Follow the safety guidelines listed in the [Safety instructions](#).
2. Follow the procedure listed in [Before working inside your system](#).
3. [Remove the air shroud](#).
4. If you are replacing the IDSDM card, remove the MicroSD cards.
NOTE: Temporarily label each SD card with its corresponding slot number before removal. Reinstall the SD cards into the corresponding slots.

Steps

Holding the pull tab, lift the IDSDM card out of the system.

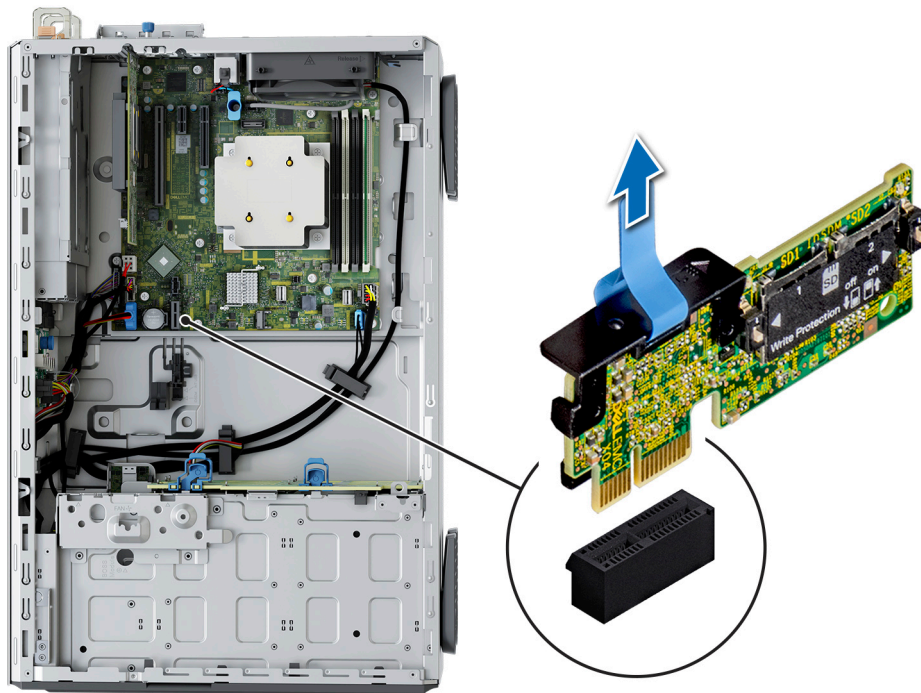

Figure 71. Removing the IDSDM module

Next steps

Replace the IDSDM module.

Installing the IDSDM module

Prerequisites

1. Follow the safety guidelines listed in the [Safety instructions](#).
2. Follow the procedure listed in [Before working inside your system](#).
3. [Remove the air shroud](#).

Steps

1. Locate the IDSDM connector on the system board.
To locate IDSDM, see the [System board jumpers and connectors](#) section.
2. Align IDSDM module with the connector on the system board.
3. Push IDSDM module until it is firmly seated in the connector on the system board.

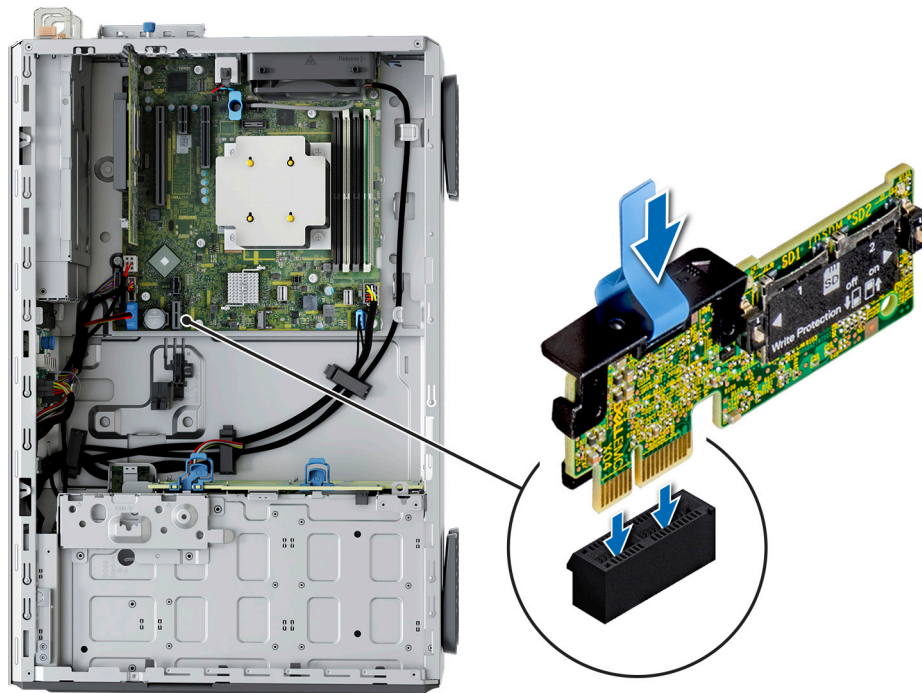

Figure 72. Installing the IDSDM module

Next steps

1. [Install the MicroSD cards.](#)
i **NOTE:** Reinstall the MicroSD cards into the same slots based on the labels you had marked on the cards during removal.
2. [Install the air shroud.](#)
3. Follow the procedure listed in the [After working inside your system.](#)

MicroSD card

Removing the MicroSD card

Prerequisites

1. Follow the safety guidelines listed in the [Safety instructions.](#)
2. Follow the procedure listed in the [Before working inside your system.](#)
3. [Remove the IDSDM module.](#)

Steps

1. Locate the MicroSD card slot on the IDSDM module, and press the card to partially release it from the slot. For more information on the IDSDM module location, see [System board jumpers and connectors](#) section.
2. Hold the MicroSD card, and remove them from the IDSDM module.

i **NOTE:** Temporarily label each MicroSD card with the corresponding slot number after removal.

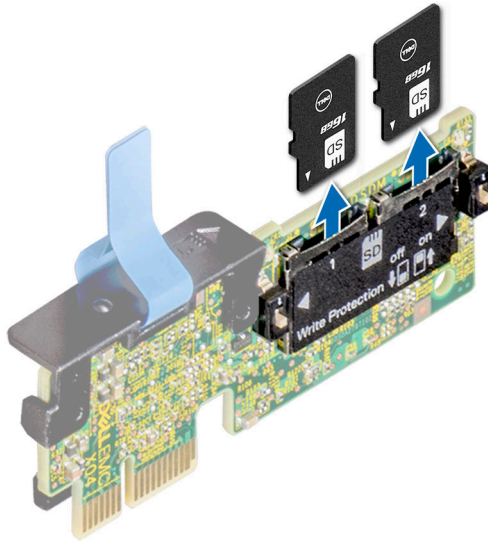

Figure 73. Removing the MicroSD card

Next steps

1. [Replace the MicroSD cards.](#)

Installing the MicroSD card

Prerequisites

1. Follow the safety guidelines listed in the [Safety instructions](#).
2. Follow the procedure listed in [Before working inside your system](#).

NOTE: To use an MicroSD card with your system, ensure that the **Internal SD Card Port** is enabled in System Setup.

NOTE: Ensure that you install the MicroSD cards into the same slots based on the labels you had marked on the cards during removal.

Steps

1. Locate the MicroSD card slot on the IDSDM module. Orient the MicroSD card appropriately and insert the contact-pin end of the card into the slot. To locate IDSDM, see the [System board jumpers and connectors](#) section.

NOTE: The slot is keyed to ensure correct insertion of the card.

2. Press the card into the slot to lock it into place.

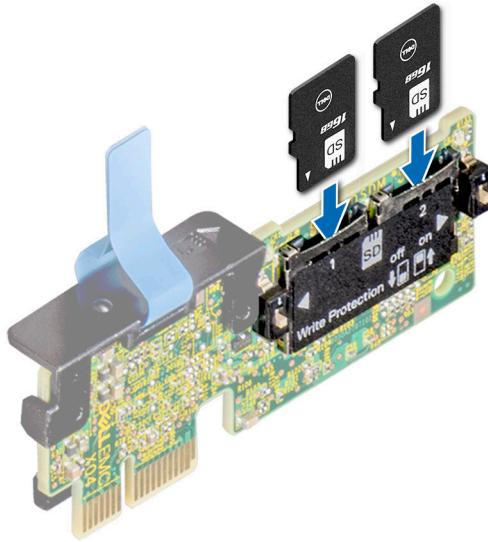

Figure 74. Installing the MicroSD card

Next steps

1. [Install the IDSDM module.](#)
2. Follow the procedure listed in [After working inside your system.](#)

Optional internal USB card

NOTE: To locate the internal USB port on the system board, see the [System board jumpers and connectors](#) section.

Removing the internal USB card

Prerequisites

CAUTION: To avoid interference with other components in the server, the maximum permissible dimensions of the USB memory key are 15.9 mm width x 57.15 mm length x 7.9 mm height.

1. Follow the safety guidelines listed in the [Safety instructions.](#)
2. Follow the procedure listed in the [Before working inside your system.](#)

Steps

1. Holding the blue tag, lift the internal USB card to disconnect from the connector on the system board.
2. Remove the USB memory key from the internal USB card.

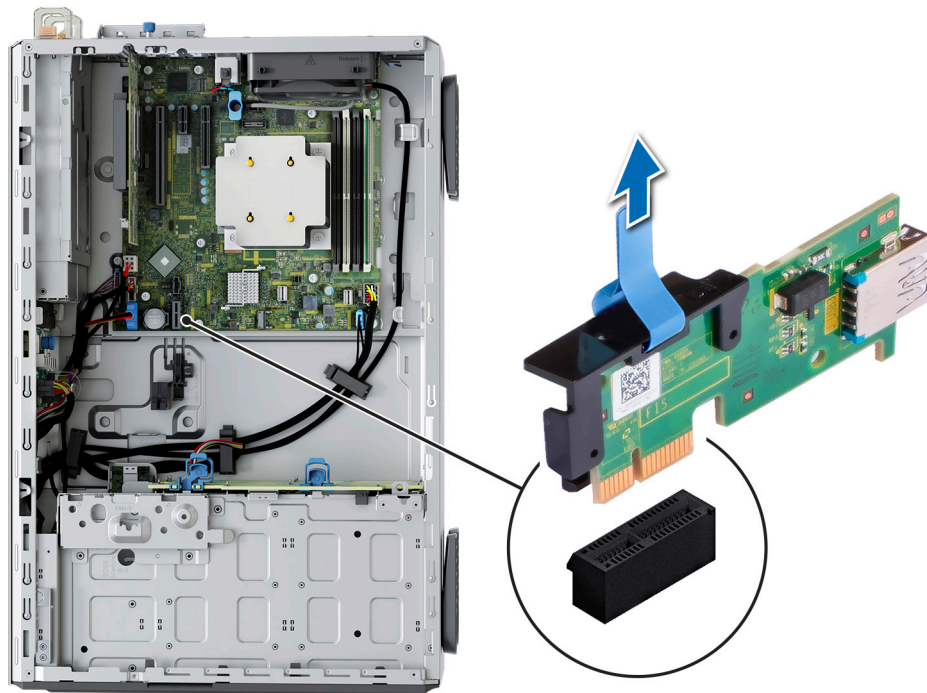

Figure 75. Removing the internal USB card

Next steps

Replace the internal USB card.

Installing the internal USB card

Prerequisites

1. Follow the safety guidelines listed in the [Safety instructions](#).
2. Follow the procedure listed in the [Before working inside your system](#).

Steps

1. Connect the USB memory key to the internal USB card.
2. Align the internal USB card with the connector on the system board and press firmly until the internal USB card is seated.

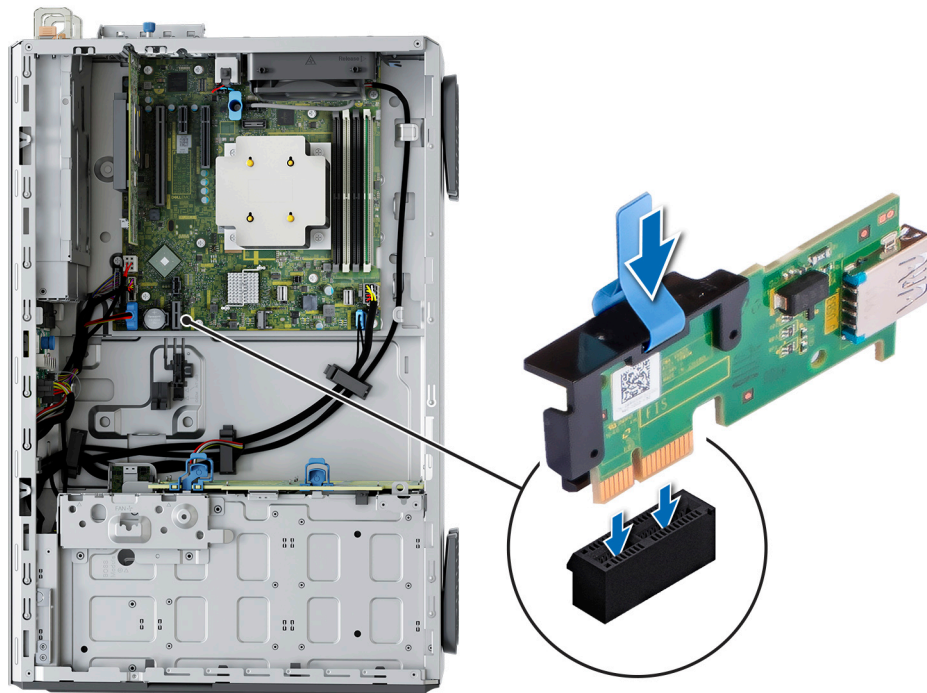

Figure 76. Installing the internal USB card

Next steps

1. Follow the procedure listed in [After working inside your system](#).
2. While booting, press **F2** to enter **System Setup** and verify that the system detects the USB memory key.

Optional internal USB memory key

Removing the internal USB memory key

Prerequisites

CAUTION: To avoid interference with other components in the server, the maximum permissible dimensions of the USB memory key are 15.9 mm width x 57.15 mm length x 7.9 mm height.

1. Follow the safety guidelines listed in [Safety instructions](#).
2. Follow the procedure that is listed in [Before working inside your system](#).

Steps

Remove the USB memory key from the internal USB port.

Next steps

[Replace the internal USB memory key](#).

Installing the internal USB memory key

Prerequisites

1. Follow the safety guidelines listed in [Safety instructions](#).
2. Follow the procedure that is listed in [Before working inside your system](#).

Steps

Connect the USB memory key into the USB port.

Next steps

1. Follow the procedure listed in [After working inside your system](#).
2. While booting, press **F2** to enter **System Setup** and verify that the system detects the USB memory key.

Power supply unit

 **NOTE:** While replacing the hot swappable PSU, after next server boot; the new PSU automatically updates to the same firmware and configuration of the replaced one. For more information about the Part replacement configuration, see the *Lifecycle Controller User's Guide* at <https://www.dell.com/idracmanuals>.

Hot spare feature

Your system supports the hot spare feature that significantly reduces the power overhead associated with the power supply unit (PSU) redundancy.

When the hot spare feature is enabled, one of the redundant PSUs is switched to the sleep state. The active PSU supports 100 percent of the system load, thus operating at higher efficiency. The PSU in the sleep state monitors output voltage of the active PSU. If the output voltage of the active PSU drops, the PSU in the sleep state returns to an active output state.

If having both PSUs active is more efficient than having one PSU in the sleep state, the active PSU can also activate the sleeping PSU.

The default PSU settings are as follows:

- If the load on the active PSU is more than 50 percent of PSU rated power wattage, then the redundant PSU is switched to the active state.
- If the load on the active PSU falls below 20 percent of PSU rated power wattage, then the redundant PSU is switched to the sleep state.

You can configure the hot spare feature by using the iDRAC settings. For more information, see the *iDRAC User's Guide* available at www.dell.com/poweredgemanuals.

Removing a power supply unit blank

Prerequisites

Follow the safety guidelines listed in the [Safety instructions](#).

Steps

Pull the blank out of the system.

 **CAUTION:** For proper system cooling, the PSU blank must be installed in the second PSU bay in a non-redundant configuration. Remove the PSU blank only if you are installing a second PSU.

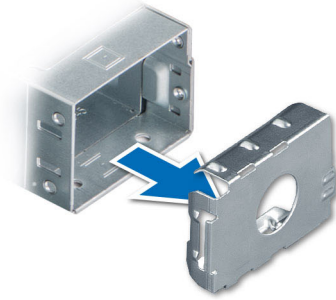

Figure 77. Removing a power supply unit blank

Next steps

Replace the [PSU blank](#) or [install the PSU](#).

Installing a power supply unit blank

Prerequisites

1. Follow the safety guidelines listed in the [Safety instructions](#).
NOTE: Install the power supply unit (PSU) blank only in the second PSU bay.
2. [Remove the PSU](#).

Steps

Align the PSU blank with the PSU bay and push it into the PSU bay until it clicks into place.

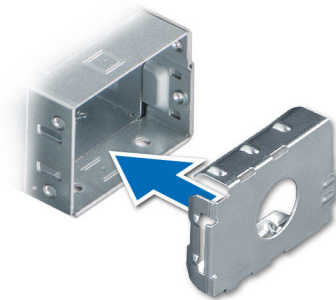

Figure 78. Installing a power supply unit blank

Removing a power supply unit

Prerequisites

CAUTION: The system requires one power supply unit (PSU) for normal operation. On power-redundant systems, remove and replace only one PSU at a time in a system that is powered on.

1. Follow the safety guidelines listed in the [Safety instructions](#).
2. Disconnect the power cable from the power outlet and from the PSU you intend to remove.
3. Remove the cable from the strap on the PSU handle.

Steps

Press the release latch, and holding the PSU handle slide the PSU out of the PSU bay.

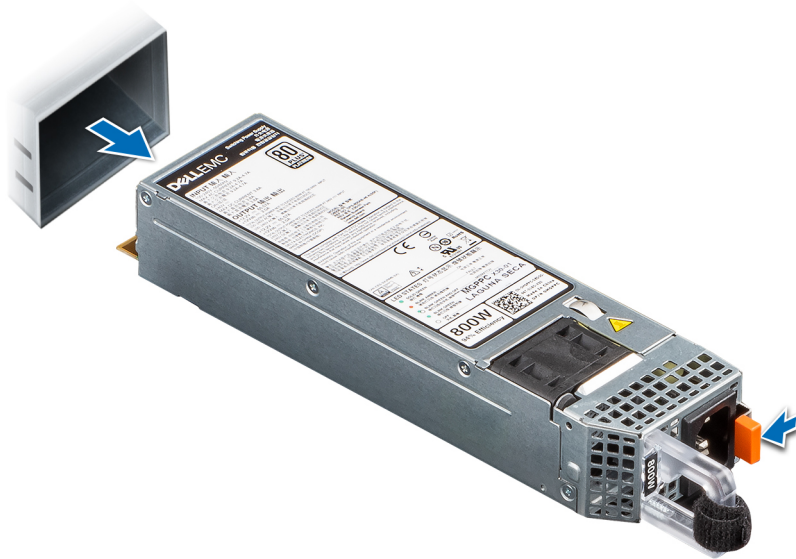

Figure 79. Removing a power supply unit

Next steps

Replace the PSU or install the PSU blank.

Installing a power supply unit

Prerequisites

1. Follow the safety guidelines listed in the [Safety instructions](#).
2. For systems that support redundant PSU, ensure that both the PSUs are of the same type and have the same maximum output power.

i **NOTE:** The maximum output power (shown in watts) is listed on the PSU label.

3. [Remove the PSU blank](#).

Steps

Slide the PSU into the PSU bay until the release latch snaps into place.



Figure 80. Installing a power supply unit

Next steps

1. Connect the power cable to the PSU, and plug the cable into a power outlet.

CAUTION: When connecting the power cable to the PSU, secure the cable to the PSU with the strap.

NOTE: When installing, hot swapping, or hot adding a new PSU, wait for 15 seconds for the system to recognize the PSU and determine its status. The PSU redundancy may not occur until discovery is complete. The PSU status indicator turns green to indicate that the PSU is functioning properly.

NOTE: For certain premium configurations with high power consumption, system PSU might stay with 2+0 mode only, 1+1 redundant mode is not available.

NOTE: While replacing the hot swappable PSU, after next server boot; the new PSU automatically updates to the same firmware and configuration of the replaced one. For more information about the Part replacement configuration, see the *Lifecycle Controller User's Guide* at <https://www.dell.com/idracmanuals>.

Removing a cabled PSU

Prerequisites

1. Follow the safety guidelines listed in [Safety instructions](#).
2. Follow the procedure listed in [Before working inside your system](#).
3. Disconnect the power cables of the PSU from the system board and the drive backplane.
4. Remove the cables from the cable clip.

Steps

1. Using a Phillips 2 screwdriver, remove the screws that secure the PSU cage to the system.
2. Tilt at an angle and slide the PSU cage towards the front of the system.
3. Lift the PSU cage out of the system.

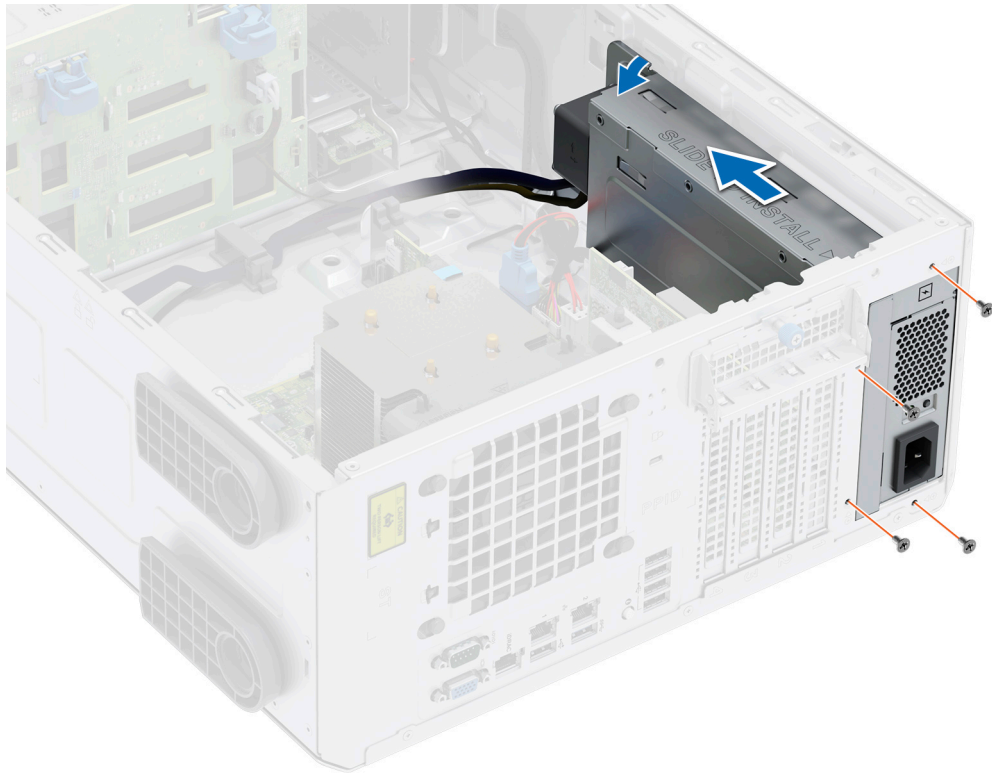

Figure 81. Removing the PSU cage

4. Using a Phillips 2 screwdriver, remove the screw that secures the PSU into PSU cage.
5. Slide the PSU out of the PSU cage.

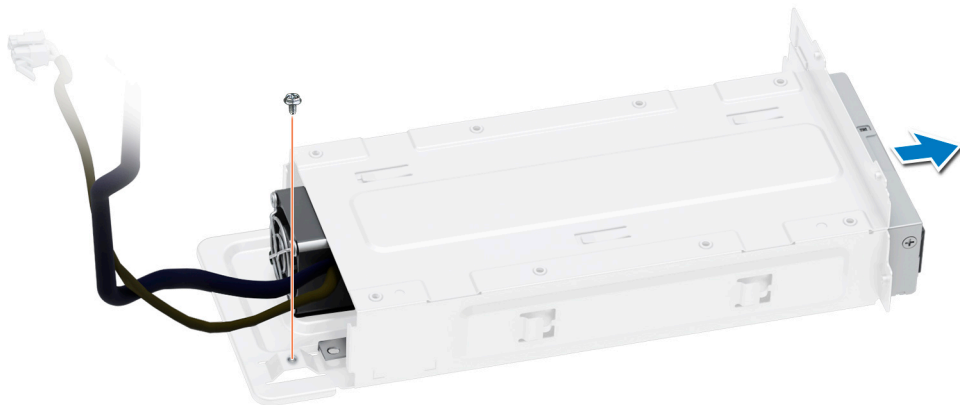

Figure 82. Removing the cabled PSU

Next steps

1. [Replace the cabled PSU.](#)

Installing the cabled PSU

Prerequisites

1. Follow the safety guidelines listed in [Safety instructions](#).
2. Unpack the replacement PSU.

Steps

1. Slide the PSU into the PSU cage and align with screw hole on the PSU cage.
2. Using the Phillips 2 screwdriver, tighten the screw that secures the PSU into PSU cage.

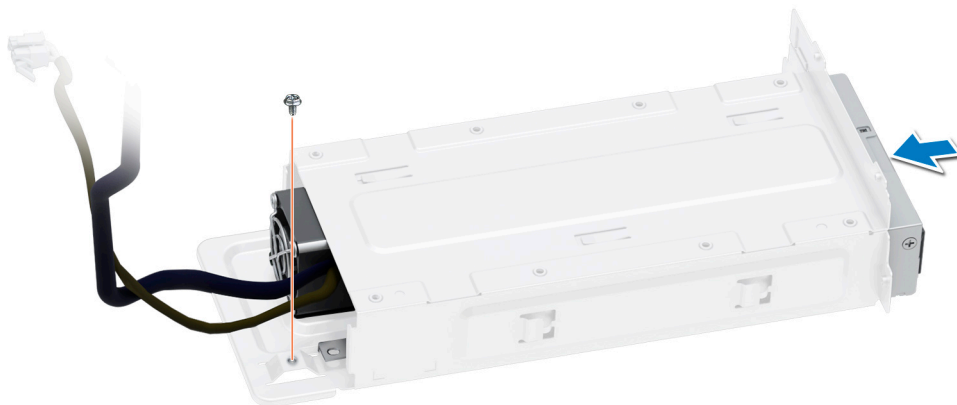

Figure 83. Installing the cabled PSU

3. Tilt at an angle and insert the PSU cage into the slots on the system then slide it towards the rear of the system until the PSU cage is fully seated.
4. Using the Phillips 2 screwdriver, tighten the screws that secure the PSU cage into the system.

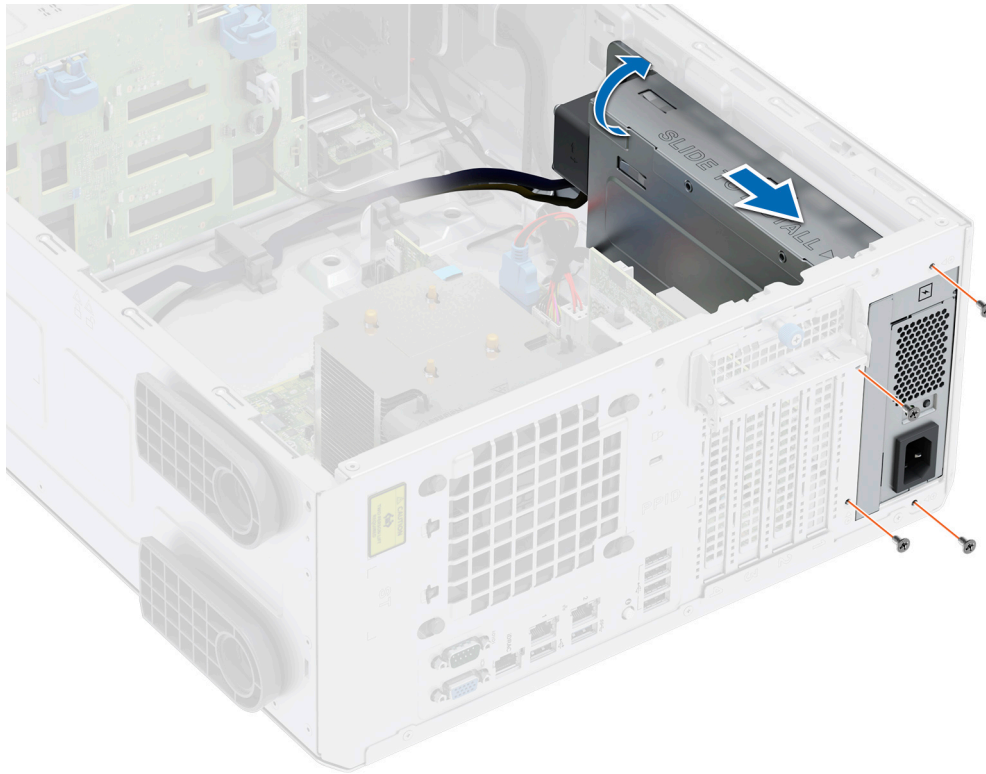

Figure 84. Installing the PSU cage

Next steps

1. Connect all the power cables from the PSU to the system board and the drive backplane.
2. Route the power cables properly and secure them with cable clips.
3. Connect all the power cables from the PSU to the system board and the drive backplane.
4. Follow the procedure listed in [After working inside your system](#).

Power interposer board

This is a service technician replaceable part only.

Removing the power interposer board

Prerequisites

1. Follow the safety guidelines listed in [Safety instructions](#).
2. Follow the procedure listed in [Before working inside your system](#).
3. [Remove the power supply units](#).
4. [Remove the air shroud](#).
5. Disconnect the power cables from the power interposer board (PIB).

CAUTION: To prevent damage to the power interposer board, you must remove the power supply units from the system.

NOTE: Observe the cable routing while removing from PIB.

Steps

To remove the power interposer board (PIB), holding the plunger slide the PIB towards the rear of the system to disengage PIB from the hooks on the system.

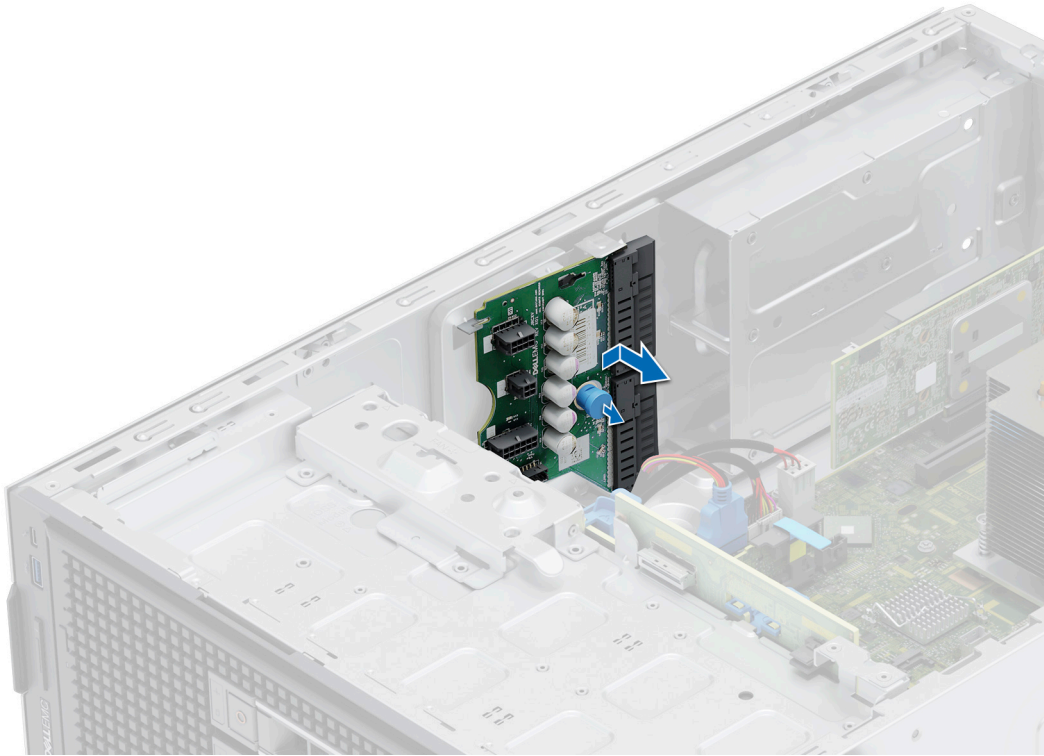

Figure 85. Removing the power interposer board

Next steps

1. [Replace the power interposer board \(PIB\).](#)

Installing the power interposer board

Prerequisites

1. Follow the safety guidelines listed in [Safety instructions](#).
2. Follow the procedure listed in [Before working inside your system](#).
3. [Remove the power supply units](#).
4. [Remove the air shroud](#).

Steps

1. To install power interposer board (PIB), align the PIB at an angle with the hooks on the system.
2. Slide the PIB towards the front of the system until it snaps into place.

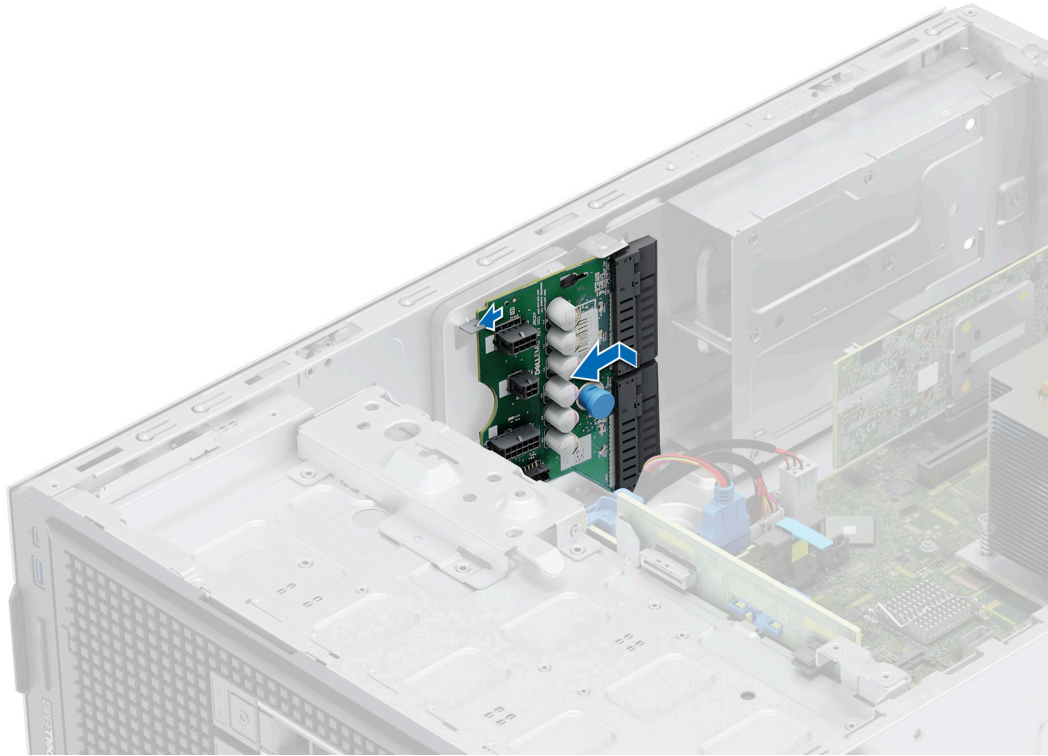

Figure 86. Installing the power interposer board

Next steps

1. Reconnect the power cables to the PIB and route the cables properly to avoid cable damage.
2. [Install the air shroud.](#)
3. [Replace the PSU.](#)
4. Follow the procedure that is listed in [After working inside your system.](#)

System battery

This is a service technician replaceable part only.

Replacing the system battery

Prerequisites

⚠ WARNING: There is a danger of a new battery exploding if it is incorrectly installed. Replace the battery only with the same or equivalent type that is recommended by the manufacturer. Discard used batteries according to the manufacturer's instructions. See the Safety instructions that came with your system for more information.

1. Follow the safety guidelines listed in the [Safety instructions.](#)
2. Follow the procedure listed in [Before working inside your system.](#)

Steps

1. To remove the battery:
 - a. Use a plastic scribe to pry out the system battery.

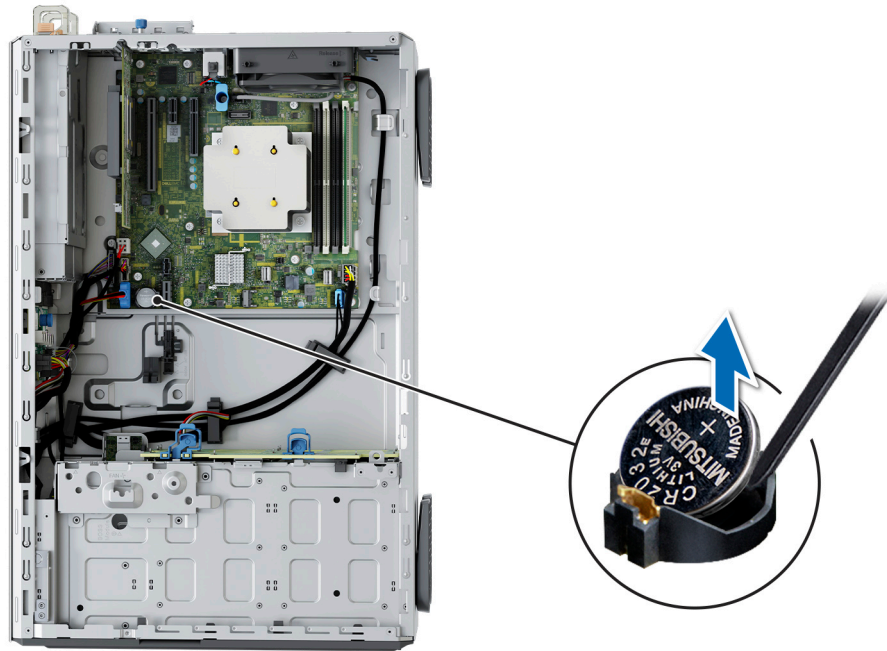

Figure 87. Removing the system battery

CAUTION: To avoid damage to the battery connector, you must firmly support the connector while installing or removing a battery.

2. To install a new system battery:
 - a. Hold the battery with the positive side facing up and slide it under the securing tabs.
 - b. Press the battery into the connector until it snaps into place.

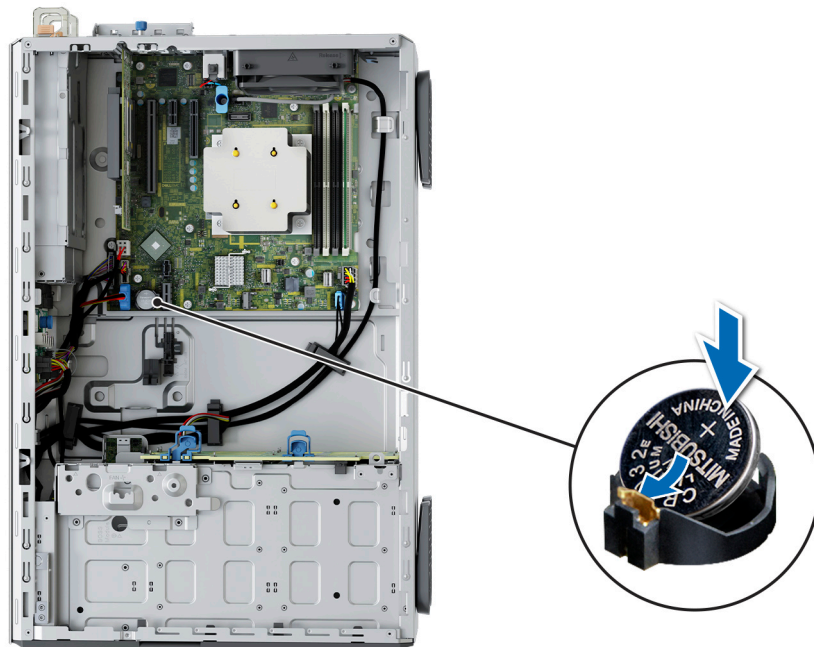

Figure 88. Installing the system battery

Next steps

1. Follow the procedure listed in the [After working inside your system](#).
2. Confirm that the battery is operating properly, by performing the following steps:

- a. Enter the **System Setup**, while booting, by pressing **F2**.
- b. Enter the correct time and date in the System Setup **Time** and **Date** fields.
- c. **Exit** the System Setup.
- d. To test the newly installed battery, remove the system from the enclosure for at least an hour.
- e. Reinstall the system into the enclosure after an hour.
- f. Enter the System Setup and if the time and date are still incorrect, see [Getting help](#) section.

System board

This is a service technician replaceable part only.

Removing the system board

Prerequisites

 **CAUTION:** If you are using the Trusted Platform Module (TPM) with an encryption key, you may be prompted to create a recovery key during program or System Setup. Be sure to create and safely store this recovery key. If you replace this system board, you must supply the recovery key when you restart your system or program before you can access the encrypted data on your drives.

1. Follow the safety guidelines listed in the [Safety instructions](#).
2. Follow the procedure listed in [Before working inside your system](#).
3. Remove the following components:
 - a. [Air shroud](#)
 - b. [Expansion cards](#)
 - c. [Cooling fan](#)
 - d. [IDSDM module \(if installed\)](#)
 - e. [Internal USB \(if installed\)](#)
 - f. [Heat sink](#)
 - g. [Processor](#)
 - h. [Memory modules](#)
 - i. [Trusted Platform Module \(TPM\)](#)
 - j. Disconnect all the cables from the system board.

 **CAUTION:** Take care not to damage the system identification button while removing the system board from the system.

Steps

1. Using a Phillips 2 screwdriver, remove the screws that secure the system board to the system.

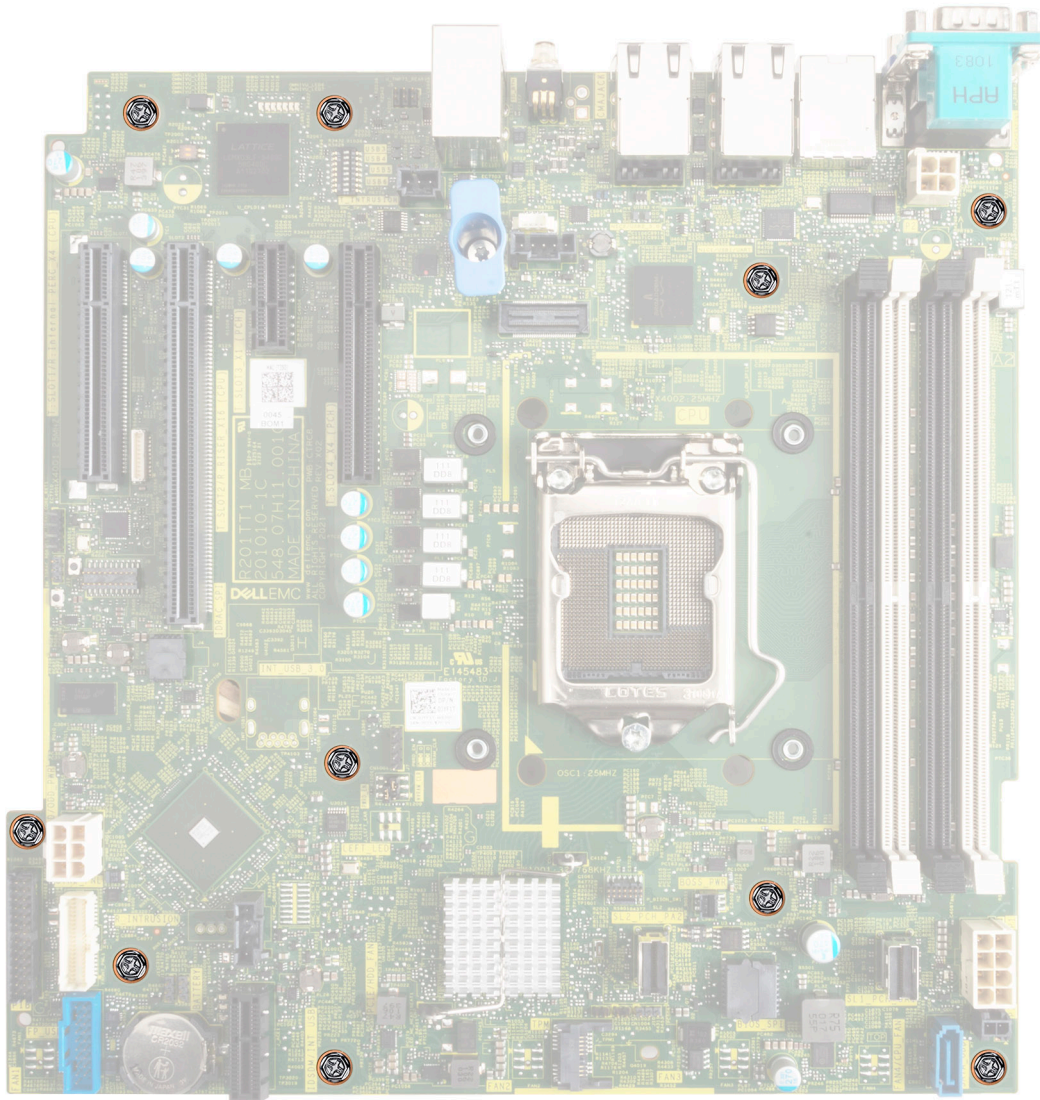

Figure 89. Removing the screws from the system board

2. Using the system board holder, slide the system board toward the front of the chassis.
3. Incline the system board at an angle and lift the system board out of the chassis.

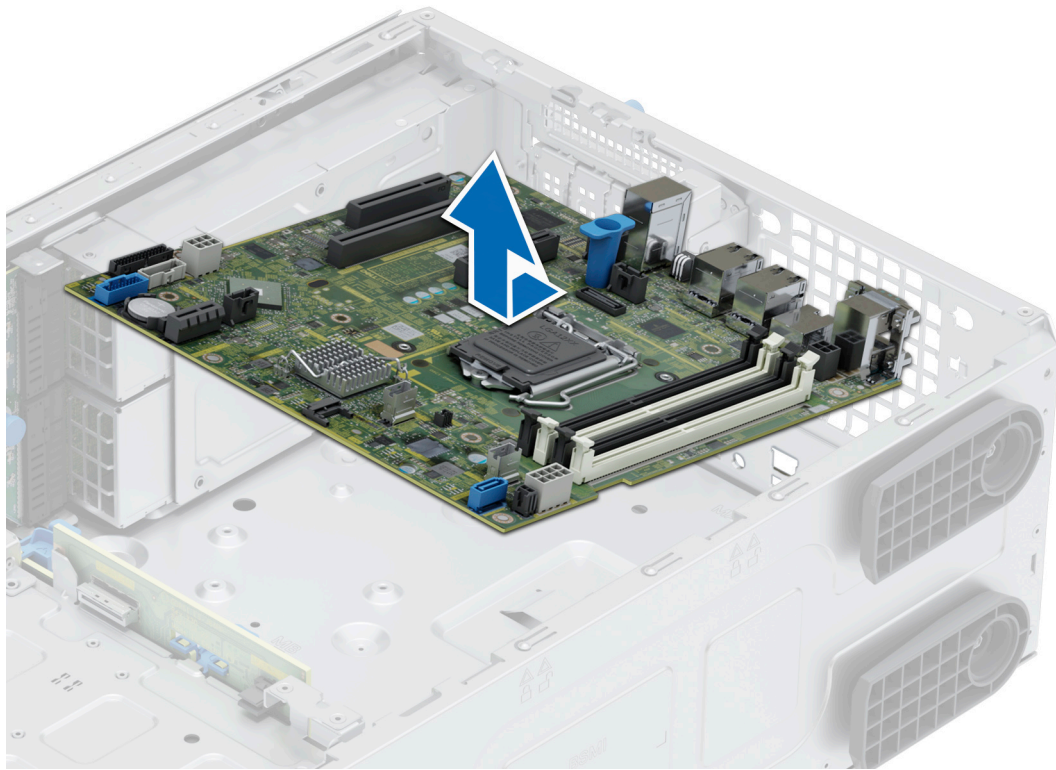

Figure 90. Removing the system board

Next steps

Install the system board.

Installing the system board

Prerequisites

NOTE: Before replacing the system board, replace the old iDRAC MAC address label in the Information tag with the iDRAC MAC address label of the replacement system board.

1. Follow the safety guidelines listed in the [Safety instructions](#).
2. Follow the procedure listed in [Before working inside your system](#).
3. If you are replacing the system board, remove all the components that are listed in the [removing the system board](#) section.

Steps

1. Unpack the new system board assembly.

CAUTION: Do not lift the system board by holding a memory module, processor, or other components.

CAUTION: Take care not to damage the system identification button while placing the system board into the chassis.

2. Using the system board holder, lower the system board it into the system.
3. Incline the system board at an angle and align the connectors on the system board with the slots on the rear of the chassis until the connectors are firmly seated in the slots.

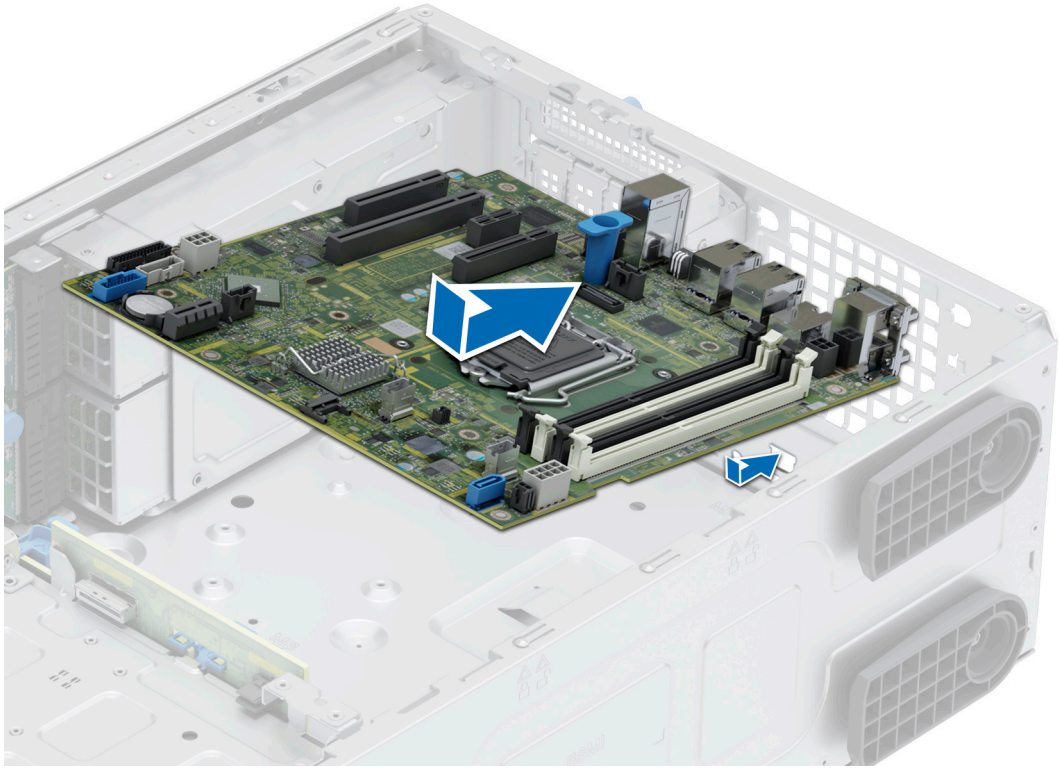

Figure 91. Installing the system board

4. Using the Phillips 2 screwdriver, secure the system board to the system with screws.

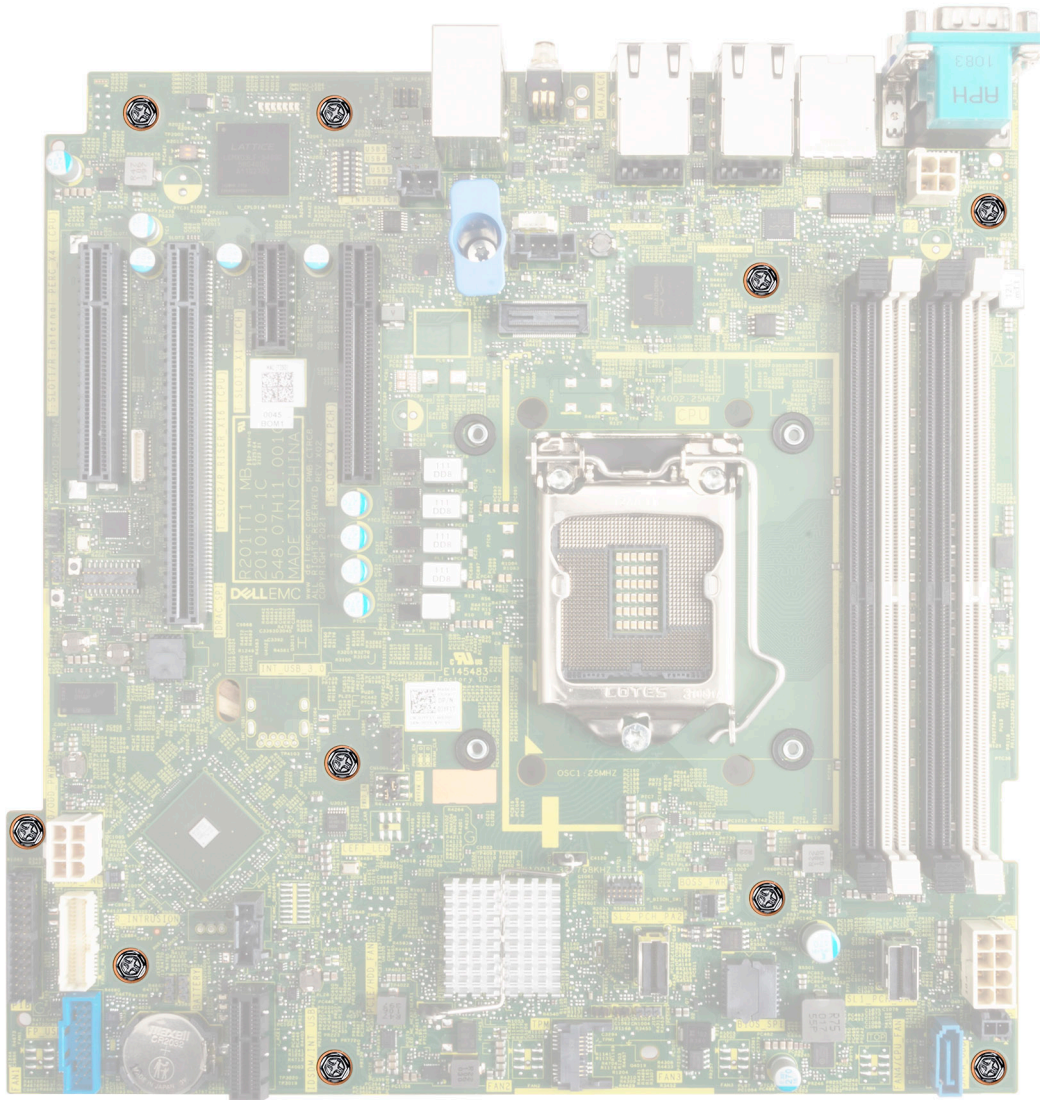



Figure 92. Installing the screws into the system board

Next steps

1. Replace the following components:
 - a. [Trusted Platform Module \(TPM\)](#)
 **NOTE:** The TPM Module must be replaced only while installing new system board.
 - b. [Expansion cards](#)
 - c. [Cooling fan](#)
 - d. [IDSDM module](#) (If removed)
 - e. [Internal USB](#) (If removed)
 - f. [Processor](#)
 - g. [Heat sink](#)
 - h. [Memory modules](#)
 - i. [Air shroud](#)
2. Replace the iDRAC MAC address label from the system with the new iDRAC MAC address label that came with the replacement system board.
3. Reconnect all cables to the system board.

NOTE: Ensure that the cables inside the system are routed along the chassis wall and secured using the cable securing bracket.

4. Ensure that you perform the following steps:
 - a. Use the Easy Restore feature to restore the Service Tag. See the [Restoring the system by using the Easy Restore feature](#) section.
 - b. If the service tag is not backed up in the backup flash device, enter the system service tag manually. See the [Manually update the Service Tag by using System Setup](#) section.
 - c. Update the BIOS and iDRAC versions.

Reenable the Trusted Platform Module (TPM). See the [Upgrading the Trusted Platform Module](#) section

5. If you are not using Easy restore, import your new or existing iDRAC Enterprise license. For more information, see the *Integrated Dell Remote Access Controller User's Guide* available at <https://www.dell.com/idracmanuals>.
6. Follow the procedure listed in [After working inside your system](#).

Restoring the system using Easy Restore

The Easy Restore feature enables you to restore your service tag, license, UEFI configuration, and the system configuration data after replacing the system board. All data is backed up in a backup flash device automatically. If BIOS detects a new system board, and the service tag in the backup flash device, BIOS prompts the user to restore the backup information.

About this task

Below is a list of options/steps available:

- Restore the service tag, license, and diagnostics information, press **Y**
- Navigate to the Lifecycle Controller based restore options, press **N**
- Restore data from a previously created **Hardware Server Profile**, press **F10**
- **NOTE:** When the restore process is complete, BIOS prompts to restore the system configuration data.
- Restore data from a previously created **Hardware Server Profile**, press **F10**
- To restore the system configuration data, press **Y**
- To use the default configuration settings, press **N**
- **NOTE:** After the restore process is complete, system reboots.

Manually update the Service Tag

After replacing a system board, if Easy Restore fails, follow this process to manually enter the Service Tag, using **System Setup**.

About this task

If you know the system service tag, use the **System Setup** menu to enter the service tag.

Steps

1. Power on the system.
2. To enter the **System Setup**, press **F2**.
3. Click **Service Tag Settings**.
4. Enter the service tag.
 - **NOTE:** You can enter the service tag only when the **Service Tag** field is empty. Ensure that you enter the correct service tag. Once the service tag is entered, it cannot be updated or changed.
5. Click **OK**.

Trusted Platform Module

This is a service technician replaceable part only.

Upgrading the Trusted Platform Module

Removing the TPM

Prerequisites

NOTE:

- Ensure that your operating system supports the version of the TPM module being installed.
- Ensure that you download and install the latest BIOS firmware on your system.
- Ensure that the BIOS is configured to enable UEFI boot mode.

 **CAUTION:** After the TPM plug-in module is installed, it is cryptographically bound to that specific system board. When the system is powered on, any attempt to remove an installed TPM plug-in module breaks the cryptographic binding, and the removed TPM cannot be installed on another system board. Ensure any keys you have stored on the TPM have been securely transferred.

Steps

1. Locate the TPM connector on the system board.
2. Press to hold the module down and remove the screw using the security Torx 8-bit shipped with the TPM module.
3. Slide the TPM module out from its connector.
4. Push the plastic rivet away from the TPM connector and rotate it 90° counterclockwise to release it from the system board.
5. Pull the plastic rivet out of its slot on the system board.

Installing the TPM

Steps

1. To install the TPM, align the edge connectors on the TPM with the slot on the TPM connector.
2. Insert the TPM into the TPM connector such that the plastic rivet aligns with the slot on the system board.
3. Press the plastic rivet until the rivet snaps into place.
4. Replace the screw that secures the TPM to the system board.

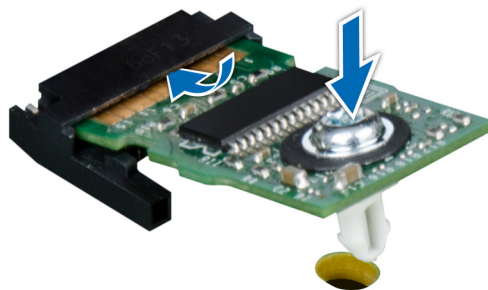

Figure 93. Installing the TPM

Initializing TPM for users

Steps

1. Initialize the TPM.
For more information, see [Initializing the TPM for users](#).
2. The **TPM Status** changes to **Enabled, Activated**.

Initializing the TPM 1.2 for users

Steps

1. While booting your system, press F2 to enter System Setup.
2. On the **System Setup Main Menu** screen, click **System BIOS > System Security Settings**.
3. From the **TPM Security** option, select **On with Preboot Measurements**.
4. From the **TPM Command** option, select **Activate**.
5. Save the settings.
6. Restart your system.

Initializing the TPM 2.0 for users

Steps

1. While booting your system, press F2 to enter System Setup.
2. On the **System Setup Main Menu** screen, click **System BIOS > System Security Settings**.
3. From the **TPM Security** option, select **On**.
4. Save the settings.
5. Restart your system.

Control panel

This is a service technician replaceable part only.

Removing the control panel assembly

Prerequisites

1. Follow the safety guidelines listed in [Safety instructions](#).
2. Follow the procedure listed in [Before working inside your system](#).
3. [Remove the front bezel](#).
4. Disconnect the control panel cable and the control panel USB cable from the connector system board.

 **NOTE:** Remove the control panel cables from the cable tie.

Steps

1. Using a Phillips 2 screwdriver, remove the screws that secure the system side cover to the chassis.
2. Tilt and slide the system side cover towards the rear of the system and remove the system side cover.



Figure 94. Removing the system side cover

3. Pull out the tabs on both sides of the front faceplate and remove the front faceplate out of the system.

i NOTE: For easy removal of tabs on the left side of the faceplate, it is recommended to use screwdriver or plastic scribe.

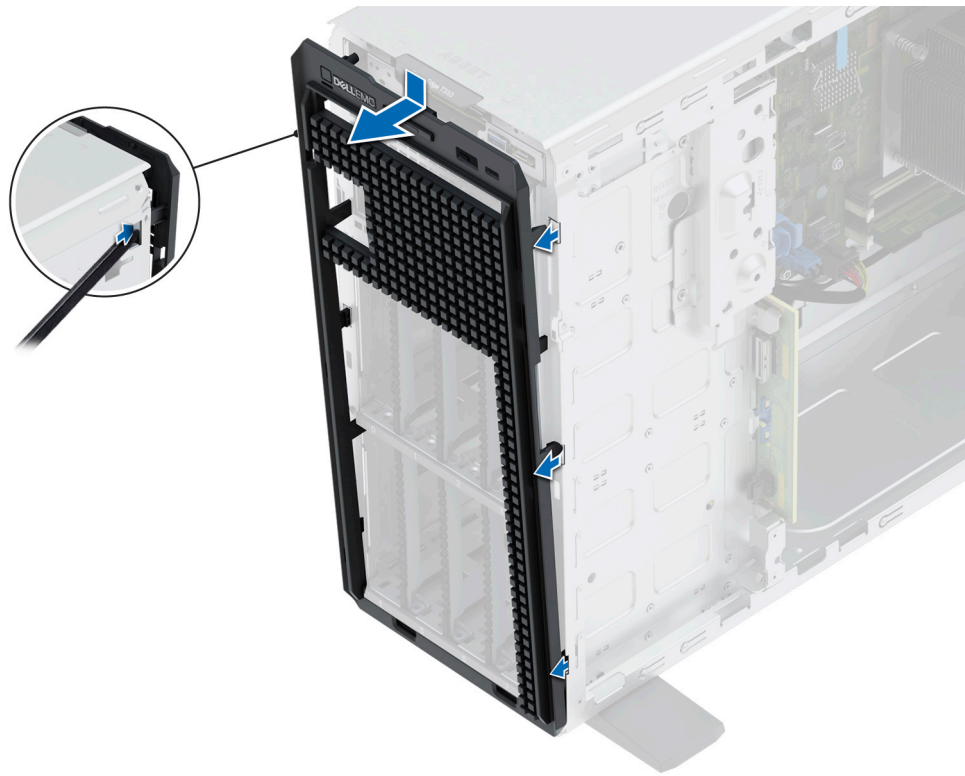

Figure 95. Removing the front faceplate

4. To remove control panel cage:
 - a. Press the side lever and slide out the control module cage from the system.
 - b. Disconnect the cable from the control panel assembly.



Figure 96. Removing the control panel cage

5. To remove control panel assembly:
 - a. Using a Phillips 2 screwdriver, remove the screws that secure the control panel assembly to the cage.
 - b. Slide out and remove the control panel assembly from the cage.

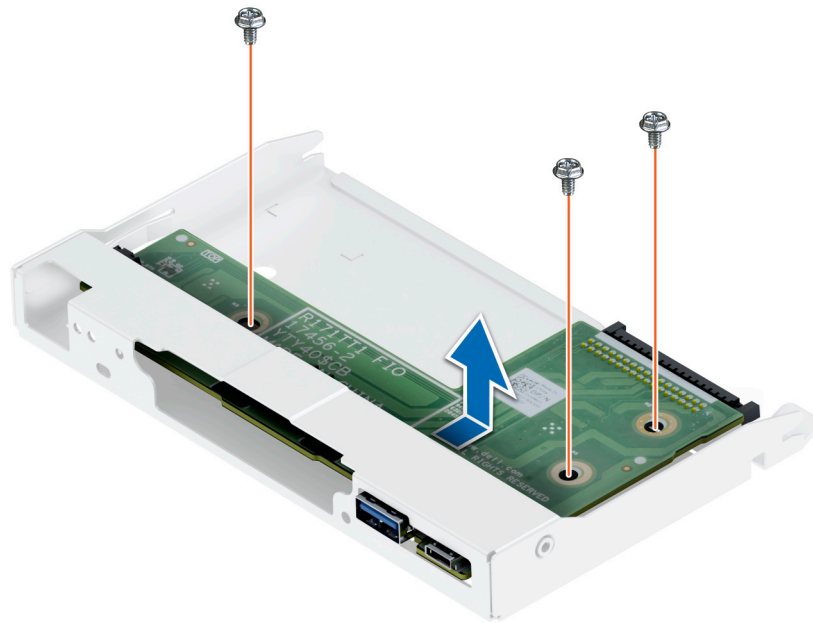

Figure 97. Removing the control panel assembly

Next steps

1. [Replace the control panel assembly.](#)

Installing the control panel assembly

Prerequisites

1. Follow the safety guidelines listed in [Safety instructions](#).
2. Follow the procedure listed in [Before working inside your system](#).
3. [Remove the front bezel.](#)

Steps

1. To install control panel assembly:
 - a. Align and slide the control panel assembly into the control panel cage.
 - b. Using a Phillips 2 screwdriver, tighten the screws that secure the control panel assembly to the cage.

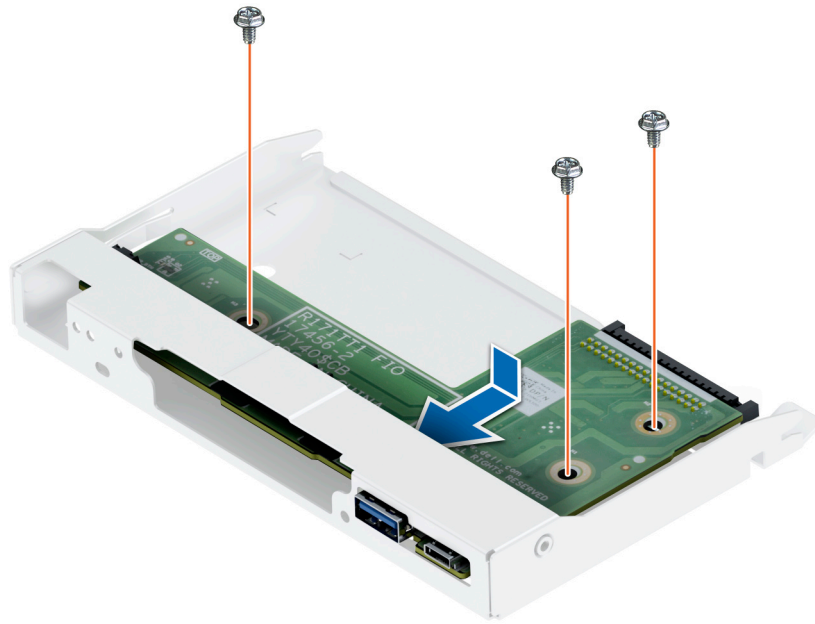

Figure 98. Installing the control panel assembly

2. To install control panel cage:
 - a. Connect the cable to the control panel assembly.
 - b. Slide the control panel cage into the system until clicks into its place.



Figure 99. Installing the control panel cage

3. Insert front faceplate tabs into the slots in the system and press until the front faceplate locks into place.

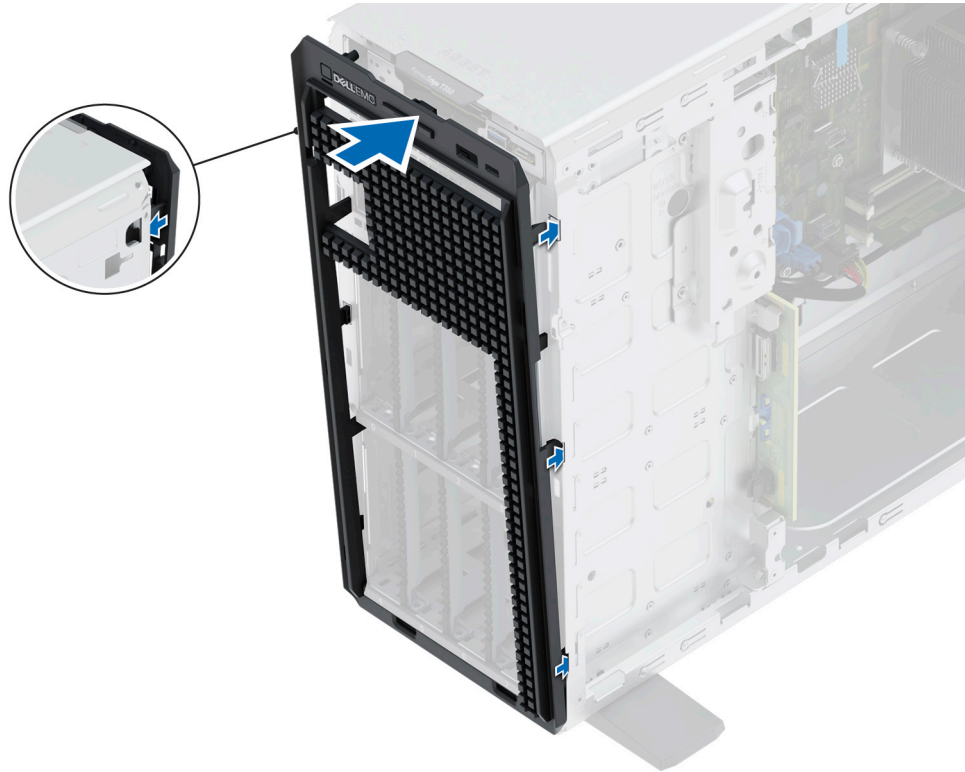

Figure 100. Installing the front faceplate

4. Tilt at an angle and align the system side cover with the slots in the system, then slide the cover towards the front of the system until locks into place.
5. Using a Phillips 2 screwdriver, tighten the screws that secure the system side cover to the chassis.



Figure 101. Installing the system side cover

Next steps

1. Connect the control panel cable and the control panel USB cable to the system board.
i NOTE: Secure the control panel cables with the cable tie to prevent it from being pinched or crimped.
2. Follow the procedure listed in [After working inside your system](#).

Upgrade Kits

Upgrade kits for PowerEdge T350

The table lists the available After Point Of Sale [APOS] kits.

Table 22. Upgrade kits

Kits	Related links to service instructions
Memory modules	See Installing the memory module
SSDs	See Installing the SSDs
Processors	See Installing the processor
Heat sink	See Installing the heat sink
Storage controller cards	See Installing the expansion card into the expansion card riser
HBA/CNA (3rd party card)	
Network cards	
Power supplies	See Installing the power supply units
Cables	See Cable routing
Bezels	See Installing the bezels
Expansion cards	See Installing an expansion card riser
Power cords	N/A
IDSDM	See Installing an IDSDM
BOSS S2	See Installing an BOSS S2 module
Internal USB	See Installing an internal USB

Topics:

- [BOSS S2 module kit](#)
- [IDSDM kit](#)
- [Internal USB card kit](#)

BOSS S2 module kit

The BOSS S2 module supports up to two M.2 SSDs.

Before you begin the installation or removal process, follow the [safety guidelines](#) and [before working inside the system](#) instructions.

Table 23. BOSS S2 module kit components

T350 (quantity)	Components in kit
NA	BOSS cover
1	M3 x 0.05 x 4.5 mm screws

Table 23. BOSS S2 module kit components (continued)

T350 (quantity)	Components in kit
1	BOSS signal cable
1	BOSS power cable
1	BOSS-S2 module
1 or 2*	BOSS-S2 card carrier
1 or 2*	M.2 SSD
2	M.2 240 GB information label
2	M.2 480 GB information label
1	BOSS card filler
1	Tech sheet

To remove the BOSS blank :

1. Power off the system and [remove the system cover](#).
2. Loosen the captive screw and pull out the BOSS module S2 blank from the system bay.

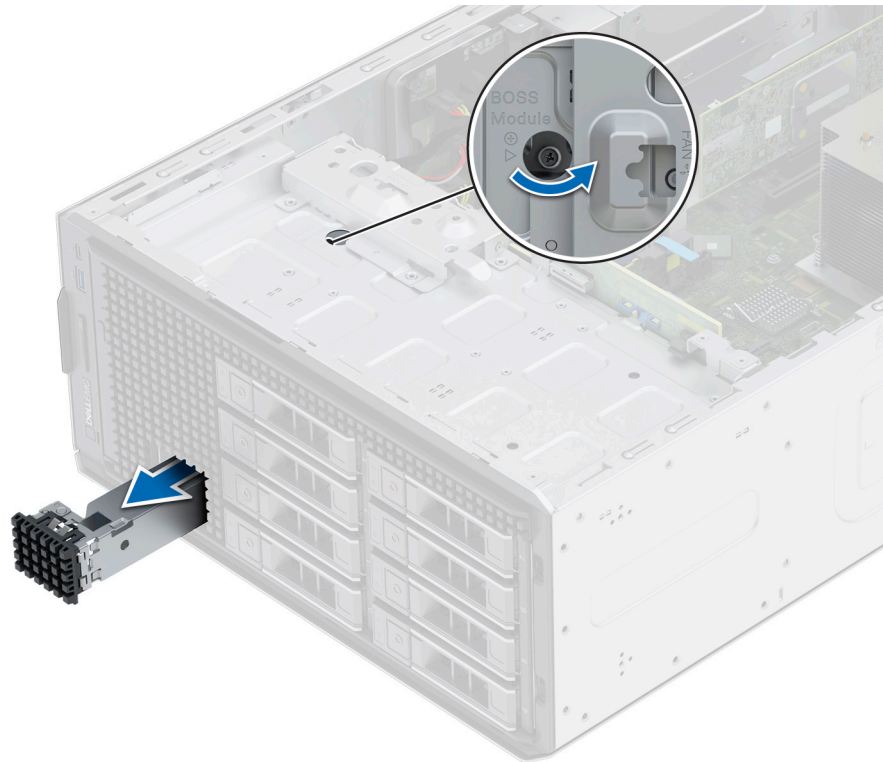

Figure 102. Removing the BOSS S2 module blank

To install the BOSS blank:

1. Align and slide the BOSS S2 module blank into the system bay.
2. Hold the BOSS S2 module blank into its place and tighten the captive screw.

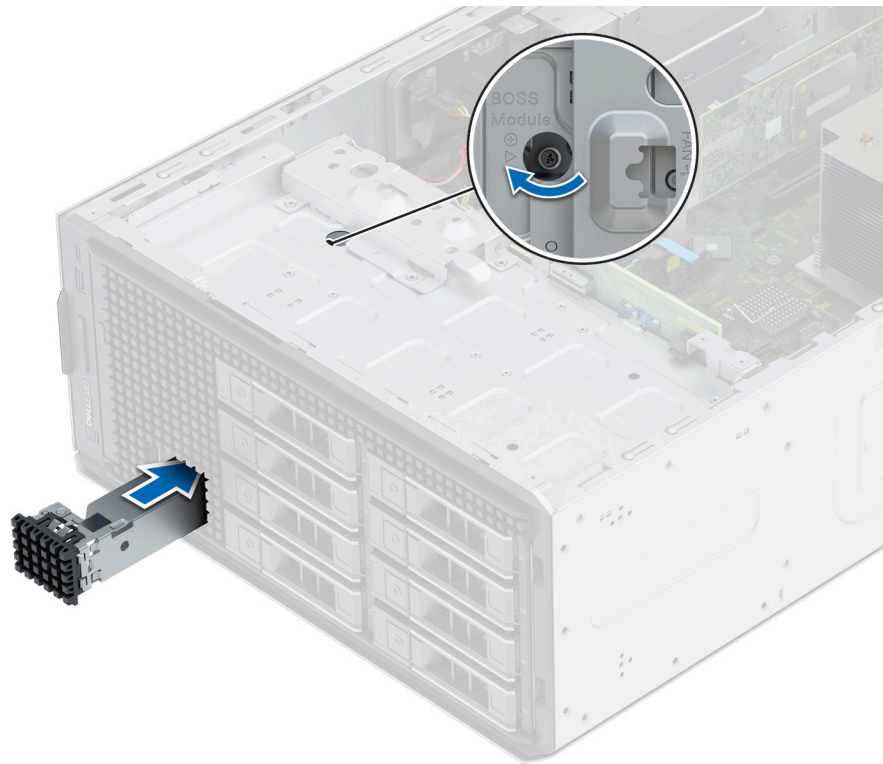

Figure 103. Installing the BOSS S2 module blank

To install the BOSS S2 module:

1. Install the BOSS S2 module . To install the BOSS S2 , see [installing the BOSS S2 module](#) steps 1 to 3.
2. Install the M.2 SSD. To install the M.2 SSD, see [installing the BOSS S2 module](#) steps 4 to 8.

i **NOTE:** Installing the BOSS S2 card carrier does not require the system to be powered off. System shutdown is only required when installing the BOSS S2 controller card module.

To remove the BOSS S2 controller card module:

1. Power off the system and [remove the system cover](#).
2. Remove the M.2 SSD. To remove the M.2 SSD, see [removing the BOSS S2 module](#) steps 1 to 4.
3. Remove the BOSS S2 module. To remove the BOSS S2 controller card module, see [removing the BOSS S2 module](#) steps 5 to 7.
4. Install the BOSS S2 module blank.

i **NOTE:** Removal of the BOSS S2 card carrier does not require the system to be powered off. System shutdown is only required when removing the BOSS S2 module.

i **NOTE:** Disconnect the BOSS signal cable and the BOSS power cable before lifting the module from the system.

IDSDM kit

The IDSDM kit contains one IDSDM card. For installation procedure of IDSDM, see [installing the IDSDM module](#) section.

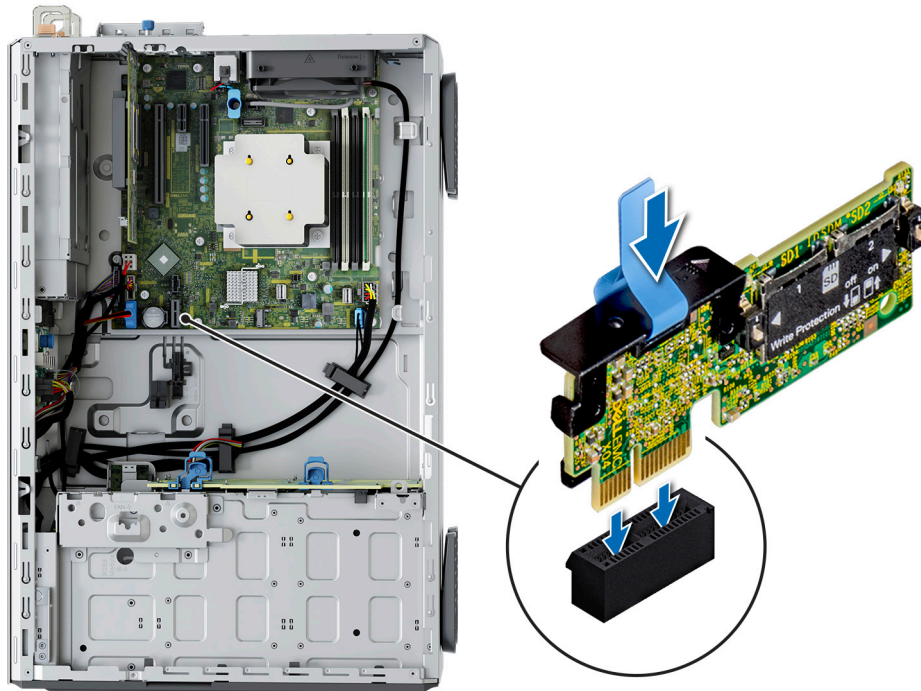

Figure 104. IDSDM port information

Internal USB card kit

The internal USB card kit contains one internal USB card. For installation of internal USB card, see [installing the internal USB card](#) section.

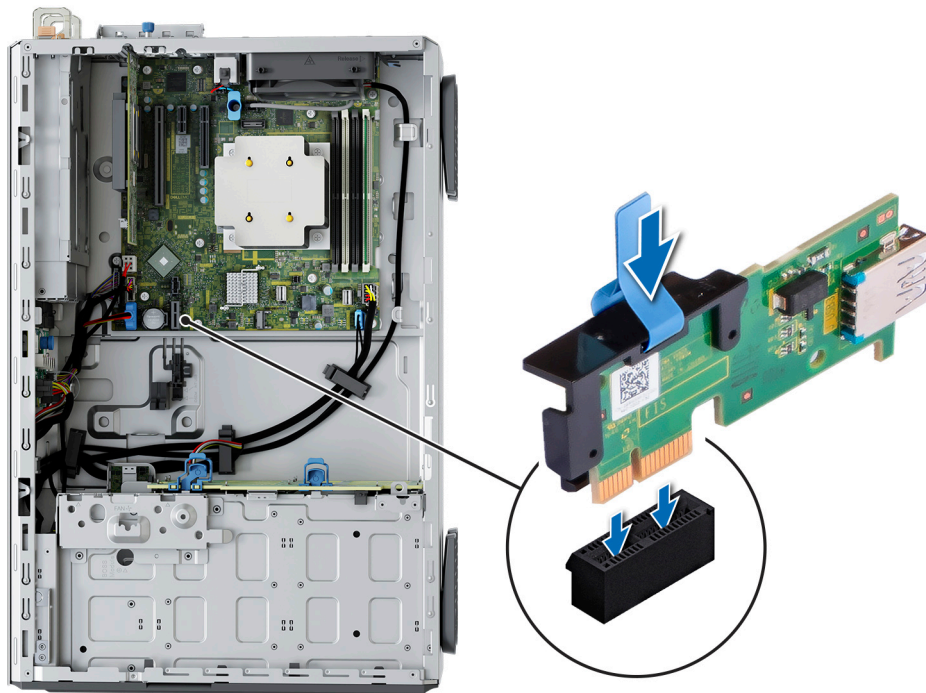

Figure 105. Internal USB card port information

Jumpers and connectors

This section provides essential and specific information about jumpers and switches. It also describes the connectors on the various boards in the system. Jumpers on the system board help to disable the system and reset the passwords. To install components and cables correctly, you must be able to identify the connectors on the system board.

Topics:

- [System board connectors](#)
- [System board jumper settings](#)
- [Disabling a forgotten password](#)

System board connectors

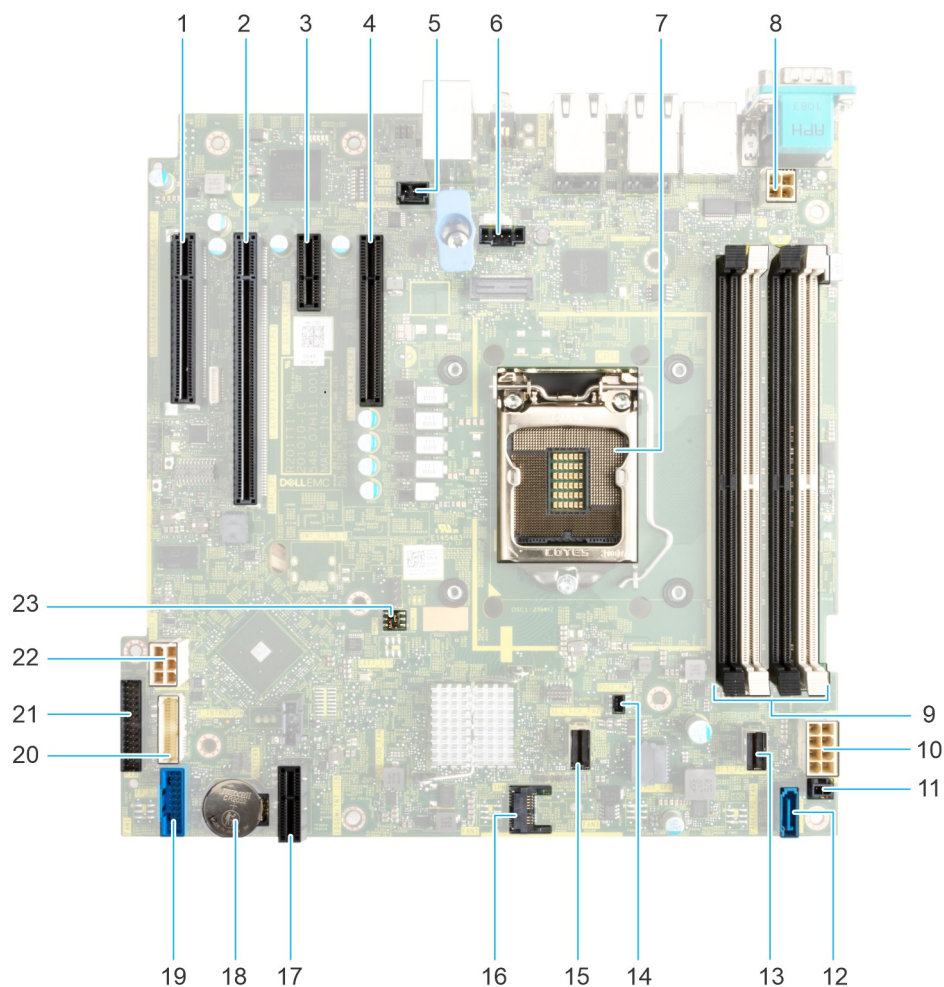

Figure 106. System board jumpers and connectors

Table 24. System board jumpers and connectors

Item	Connector	Description
1	Slot 1: PCIe_G4_X4 CPU	PCIe card connector 1





Table 24. System board jumpers and connectors (continued)

Item	Connector	Description
2	Slot 2: PCIe_G4_X16 CPU	PCIe card connector 2
3	Slot 3: PCIe_G3_X1 PCH	PCIe card connector 3
4	Slot 4: PCIe_G3_X4 PCH	PCIe card connector 4
5	T_INTRUSION	Intrusion connector
6	SYSTEM FAN	System cooling fan connector
7	CPU	Processor socket
8	PWR_CPU 1	CPU power connector P2
9	A3, A1, A4, A2	Memory module sockets
10	PWR_SYSTEM 1	System power connector P1
11	PWR_EVENT1	Power event
12	SATA_ODD/HDD 4	Optical disk drive connector
13	SATA 0-3	Mini SAS connector
14	BOSS_PWR	BOSS power connector
15	SL2_PCH_PA2	BOSS signal connector
16	TPM	Trusted platform module connector
17	IDSDM/Internal USB connector	IDSDM/Internal USB connector
18	BATTERY	CMOS Battery connector
19	FP_USB	Front panel USB connector
20	CTRL_PNL	Control panel
21	PIB connector	PIB connector
22	HDD/ODD_POWER	Hard drive power connector
23	Jumper	NVRAM / Reset BIOS password jumper

System board jumper settings

For information about resetting the password jumper to disable a password, see the [Disabling a forgotten password](#) section.

Table 25. System board jumper settings

Jumper	Setting	Description
PWRD_EN	 2 4 6 (default)	The BIOS password feature is enabled.
	 2 4 6	The BIOS password feature is disabled. The BIOS password is now disabled and you are not allowed to set a new password.
NVRAM_CLR	 1 3 5 (default)	The BIOS configuration settings are retained at system boot.
	 1 3 5	The BIOS configuration settings are cleared at system boot.

CAUTION: Be careful when changing the BIOS settings. The BIOS interface is designed for advanced users. Any change in the setting could prevent your system from starting correctly and you might have potential loss of data.



Disabling a forgotten password

The software security features of the system include a system password and a setup password. The password jumper enables or disables password features and clears any password(s) currently in use.

Prerequisites

 **CAUTION:** Many repairs may only be done by a certified service technician. You should only perform troubleshooting and simple repairs as authorized in your product documentation, or as directed by the online or telephone service and support team. Damage due to servicing that is not authorized by Dell is not covered by your warranty. Read and follow the safety instructions that are shipped with your product.

Steps

1. Power off the system and all attached peripherals. Disconnect the system from the electrical outlet, and disconnect the peripherals.
2. Remove the system cover.
3. Move the jumper on the system board from pins 2 and 4 to pins 4 and 6.
4. Replace the system cover.
 -  **NOTE:** The existing passwords are not disabled (erased) until the system boots with the jumper on pins 4 and 6. However, before you assign a new system and/or setup password, you must move the jumper back to pins 2 and 4.
 -  **NOTE:** If you assign a new system and/or setup password with the jumper on pins 4 and 6, the system disables the new password(s) the next time it boots.
5. Reconnect the peripherals and connect the system to the electrical outlet, and then power on the system.
6. Power off the system.
7. Remove the system cover.
8. Move the jumper on the system board from pins 4 and 6 to pins 2 and 4.
9. Replace the system cover.
10. Reconnect the peripherals and connect the system to the electrical outlet, and then power on the system.
11. Assign a new system and/or setup password.

System diagnostics and indicator codes

This section describes the diagnostic indicators on the system front panel that displays the system status during system startup.

Topics:

- [System health and system ID indicator codes](#)
- [iDRAC Direct LED indicator codes](#)
- [NIC indicator codes](#)
- [Power supply unit indicator codes](#)
- [Non-redundant cabled power supply unit indicator codes](#)
- [Drive indicator codes](#)
- [Using system diagnostics](#)

System health and system ID indicator codes

The system health and system ID indicator is located on the front panel of the system.



Figure 107. System health and system ID indicator

Table 26. System health and system ID indicator codes

System health and system ID indicator code	Condition
Solid blue	Indicates that the system is powered on, is healthy, and system ID mode is not active. Press the system health and system ID button to switch to system ID mode.
Blinking blue	Indicates that the system ID mode is active. Press the system health and system ID button to switch to system health mode.
Solid amber	Indicates that the system is in fail-safe mode. If the problem persists, see the Getting help section.
Blinking amber	Indicates that the system is experiencing a fault. Check the System Event Log for specific error messages. For information about the event and error messages generated by the system firmware and agents that monitor system components, go to qrl.dell.com > Look Up > Error Code , type the error code, and then click Look it up .

iDRAC Direct LED indicator codes

The iDRAC Direct LED indicator lights up to indicate that the port is connected and is being used as a part of the iDRAC subsystem.

You can configure iDRAC Direct by using a USB to micro USB (type AB) cable, which you can connect to your laptop or tablet. Cable length should not exceed 3 feet (0.91 meters). Performance could be affected by cable quality. The following table describes iDRAC Direct activity when the iDRAC Direct port is active:

Table 27. iDRAC Direct LED indicator codes

iDRAC Direct LED indicator code	Condition
Solid green for two seconds	Indicates that the laptop or tablet is connected.
Blinking green (on for two seconds and off for two seconds)	Indicates that the laptop or tablet connected is recognized.
LED Indicator off	Indicates that the laptop or tablet is unplugged.

NIC indicator codes

Each NIC on the back of the system has indicators that provide information about the activity and link status. The activity LED indicator indicates if data is flowing through the NIC, and the link LED indicator indicates the speed of the connected network.

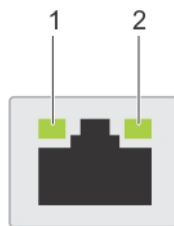

Figure 108. NIC indicator codes

1. Link LED indicator
2. Activity LED indicator

Table 28. NIC indicator codes

NIC indicator codes	Condition
Link and activity indicators are off.	Indicates that the NIC is not connected to the network.
Link indicator is green, and activity indicator is blinking green.	Indicates that the NIC is connected to a valid network at its maximum port speed, and data is being sent or received.
Link indicator is amber, and activity indicator is blinking green.	Indicates that the NIC is connected to a valid network at less than its maximum port speed, and data is being sent or received.
Link indicator is green, and activity indicator is off.	Indicates that the NIC is connected to a valid network at its maximum port speed, and data is not being sent or received.
Link indicator is amber, and activity indicator is off.	Indicates that the NIC is connected to a valid network at less than its maximum port speed, and data is not being sent or received.
Link indicator is blinking green, and activity is off.	Indicates that the NIC identity is enabled through the NIC configuration utility.

Power supply unit indicator codes

AC and DC power supply units (PSUs) have an illuminated translucent handle that serves as an indicator. The indicator shows if power is present or if a power fault has occurred.

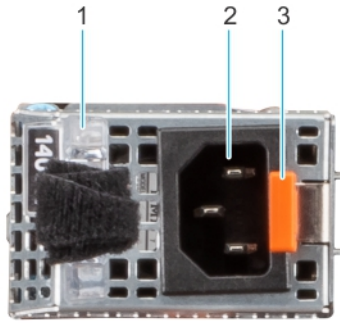

Figure 109. AC PSU status indicator

1. AC PSU handle
2. Socket
3. Release latch

Table 29. AC PSU status indicator codes

Power indicator codes	Condition
Green	Indicates that a valid power source is connected to the PSU and the PSU is operational.
Blinking amber	Indicates an issue with the PSU.
Not powered on	Indicates that the power is not connected to the PSU.
Blinking green	<p>Indicates that the firmware of the PSU is being updated.</p> <p>⚠ CAUTION: Do not disconnect the power cord or unplug the PSU when updating firmware. If firmware update is interrupted, the PSUs will not function.</p>
Blinking green and powers off	<p>When hot-plugging a PSU, it blinks green five times at a rate of 4 Hz and powers off. This indicates a PSU mismatch due to efficiency, feature set, health status, or supported voltage.</p> <p>⚠ CAUTION: If two PSUs are installed, both the PSUs must have the same type of label; for example, Extended Power Performance (EPP) label. Mixing PSUs from previous generations of PowerEdge servers is not supported, even if the PSUs have the same power rating. This results in a PSU mismatch condition or failure to power on the system.</p> <p>⚠ CAUTION: If two PSUs are used, they must be of the same type and have the same maximum output power.</p> <p>⚠ CAUTION: When correcting a PSU mismatch, replace the PSU with the blinking indicator. Swapping the PSU to make a matched pair can result in an error condition and an unexpected system shutdown. To change from a high output configuration to a low output configuration or vice versa, you must power off the system.</p> <p>⚠ CAUTION: AC PSUs support both 240 V and 120 V input voltages with the exception of Titanium PSUs, which support only 240 V. When two identical PSUs receive different input voltages, they can output different wattages, and trigger a mismatch.</p>

Table 30. DC PSU status indicator codes

Power indicator codes	Condition
Green	Indicates that a valid power source is connected to the PSU, and the PSU is operational.
Blinking amber	Indicates an issue with the PSU.
Not powered on	Indicates that the power is not connected to the PSU.
Blinking green	<p>When hot-plugging a PSU, it blinks green five times at a rate of 4 Hz and powers off. This indicates a PSU mismatch due to efficiency, feature set, health status, or supported voltage.</p> <p>⚠ CAUTION: If two PSUs are installed, both the PSUs must have the same type of label; for example, Extended Power Performance (EPP) label. Mixing PSUs from previous generations of PowerEdge servers is not supported, even if the PSUs have the same power rating. This results in a PSU mismatch condition, or failure to power on the system.</p> <p>⚠ CAUTION: If two PSUs are used, they must be of the same type and have the same maximum output power.</p> <p>⚠ CAUTION: When correcting a PSU mismatch, replace the PSU with the blinking indicator. Swapping the PSU to make a matched pair can result in an error condition and an unexpected system shutdown. To change from a High Output configuration to a Low Output configuration or conversely, you must power off the system.</p> <p>⚠ CAUTION: Combining AC and DC PSUs is not supported.</p>

Non-redundant cabled power supply unit indicator codes

Press the self-diagnostic button to perform a quick health check on the non-redundant cabled power supply unit (PSU) of the system.

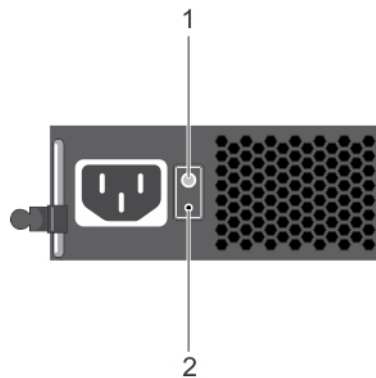

Figure 110. Non-redundant cabled AC PSU status indicator and self-diagnostic button

1. Self-diagnostic button
2. AC PSU status indicator

Table 31. Non-redundant AC PSU status indicator

Power Indicator Pattern	Condition
Not lit	Power is not connected or PSU is faulty.
Green	A valid power source is connected to the PSU and the PSU is operational.

Drive indicator codes

The LEDs on the drive carrier indicate the state of each drive. Each drive carrier has two LEDs: an activity LED (green) and a status LED (bicolor, green/amber). The activity LED blinks whenever the drive is accessed.



Figure 111. Drive indicators on the drive and the mid drive tray backplane

1. Drive activity LED indicator
2. Drive status LED indicator
3. Drive capacity label

NOTE: If the drive is in the Advanced Host Controller Interface (AHCI) mode, the status LED indicator does not power on.

NOTE: Drive status indicator behavior is managed by Storage Spaces Direct. Not all drive status indicators may be used.

Table 32. Drive indicator codes

Drive status indicator code	Condition
Blinks green twice per second	Indicates that the drive is being identified or preparing for removal.
Off	Indicates that the drive is ready for removal. NOTE: The drive status indicator remains off until all drives are initialized after the system is powered on. Drives are not ready for removal during this time.
Blinks green, amber, and then powers off	Indicates that there is an unexpected drive failure.
Blinks amber four times per second	Indicates that the drive has failed.
Blinks green slowly	Indicates that the drive is rebuilding.
Solid green	Indicates that the drive is online.
Blinks green for three seconds, amber for three seconds, and then powers off after six seconds	Indicates that the rebuild has stopped.

Using system diagnostics

If you experience an issue with the system, run the system diagnostics before contacting Dell for technical assistance. The purpose of running system diagnostics is to test the system hardware without using additional equipment or risking data loss. If you are unable to fix the issue yourself, service and support personnel can use the diagnostics results to help you solve the issue.

Dell Embedded System Diagnostics

 **NOTE:** The Dell Embedded System Diagnostics is also known as Enhanced Pre-boot System Assessment (ePSA) diagnostics.

The Embedded System Diagnostics provide a set of options for particular device groups or devices allowing you to:

- Run tests automatically or in an interactive mode
- Repeat tests
- Display or save test results
- Run thorough tests to introduce additional test options to provide extra information about the failed device(s)
- View status messages that inform you if tests are completed successfully
- View error messages that inform you of issues encountered during testing

Running the Embedded System Diagnostics from the Dell Lifecycle Controller

Steps

1. When the system is booting, press F10.
2. Select **Hardware Diagnostics** → **Run Hardware Diagnostics**.
The **ePSA Pre-boot System Assessment** window is displayed, listing all devices detected in the system. The diagnostics start executing the tests on all the detected devices.

Running the Embedded System Diagnostics from Boot Manager

Run the Embedded System Diagnostics (ePSA) if your system does not boot.

Steps

1. When the system is booting, press F11.
2. Use the up arrow and down arrow keys to select **System Utilities** > **Launch Diagnostics**.
3. Alternatively, when the system is booting, press F10, select **Hardware Diagnostics** > **Run Hardware Diagnostics**.
The **ePSA Pre-boot System Assessment** window is displayed, listing all devices detected in the system. The diagnostics starts executing the tests on all the detected devices.

System diagnostic controls

Table 33. System diagnostic controls

Menu	Description
Configuration	Displays the configuration and status information of all detected devices.
Results	Displays the results of all tests that are run.
System health	Provides the current overview of the system performance.
Event log	Displays a time-stamped log of the results of all tests run on the system. This is displayed if at least one event description is recorded.

Getting help

Topics:

- [Recycling or End-of-Life service information](#)
- [Contacting Dell Technologies](#)
- [Accessing system information by using QRL](#)
- [Receiving automated support with SupportAssist](#)

Recycling or End-of-Life service information

Take back and recycling services are offered for this product in certain countries. If you want to dispose of system components, visit www.dell.com/recyclingworldwide and select the relevant country.

Contacting Dell Technologies

Dell provides online and telephone based support and service options. If you do not have an active internet connection, you can find Dell contact information on your purchase invoice, packing slip, bill or Dell product catalog. The availability of services varies depending on the country and product, and some services may not be available in your area. To contact Dell for sales, technical assistance, or customer service issues follow these steps:

Steps

1. Go to www.dell.com/support/home.
2. Select your country from the drop-down menu on the lower right corner of the page.
3. For customized support:
 - a. Enter the system Service Tag in the **Enter a Service Tag, Serial Number, Service Request, Model, or Keyword** field.
 - b. Click **Search**.
The support page that lists the various support categories is displayed.
4. For general support:
 - a. Select your product category.
 - b. Select your product segment.
 - c. Select your product.
The support page that lists the various support categories is displayed.
5. For contact details of Dell Global Technical Support:
 - a. Click [Contact Technical Support](#).
 - b. The **Contact Technical Support** page is displayed with details to call, chat, or e-mail the Dell Global Technical Support team.

Accessing system information by using QRL

You can use the Quick Resource Locator (QRL) located on the information tag in the of the T350 system, to access information about Dell EMC PowerEdge T350. There is also another QRL for accessing product information located on the back of the system cover.

Prerequisites

Ensure that your smartphone or tablet has a QR code scanner installed.

The QRL includes the following information about your system:

- How-to videos
- Reference materials, including the Installation and Service Manual, and mechanical overview
- The system service tag to quickly access the specific hardware configuration and warranty information
- A direct link to Dell to contact technical assistance and sales teams

Steps

1. Go to www.dell.com/qrl, and navigate to your specific product or
2. Use your smart phone or tablet to scan the model-specific Quick Resource (QR) code on your system or in the Quick Resource Locator section.

Quick Resource Locator for PowerEdge T350 system



Figure 112. Quick Resource Locator for PowerEdge T350 system

Receiving automated support with SupportAssist

Dell EMC SupportAssist is an optional Dell EMC Services offering that automates technical support for your Dell EMC server, storage, and networking devices. By installing and setting up a SupportAssist application in your IT environment, you can receive the following benefits:

- Automated issue detection — SupportAssist monitors your Dell EMC devices and automatically detects hardware issues, both proactively and predictively.
- Automated case creation — When an issue is detected, SupportAssist automatically opens a support case with Dell EMC Technical Support.
- Automated diagnostic collection — SupportAssist automatically collects system state information from your devices and uploads it securely to Dell EMC. This information is used by Dell EMC Technical Support to troubleshoot the issue.
- Proactive contact — A Dell EMC Technical Support agent contacts you about the support case and helps you resolve the issue.

The available benefits vary depending on the Dell EMC Service entitlement purchased for your device. For more information about SupportAssist, go to www.dell.com/supportassist.

Documentation resources

This section provides information about the documentation resources for your system.

To view the document that is listed in the documentation resources table:

- From the Dell EMC support site:
 1. Click the documentation link that is provided in the Location column in the table.
 2. Click the required product or product version.
-  **NOTE:** To locate the model number, see the front of your system.
- 3. On the Product Support page, click **Documentation**.
- Using search engines:
 - Type the name and version of the document in the search box.

Table 34. Additional documentation resources for your system

Task	Document	Location
Setting up your system	For information about setting up your system, see the <i>Getting Started Guide</i> document that is shipped with your system.	www.dell.com/poweredgemanuals
Configuring your system	For information about the iDRAC features, configuring and logging in to iDRAC, and managing your system remotely, see the Integrated Dell Remote Access Controller User's Guide.	www.dell.com/poweredgemanuals
	For information about understanding Remote Access Controller Admin (RACADM) subcommands and supported RACADM interfaces, see the RACADM CLI Guide for iDRAC.	
	For information about Redfish and its protocol, supported schema, and Redfish Eventing implemented in iDRAC, see the Redfish API Guide.	
	For information about iDRAC property database group and object descriptions, see the Attribute Registry Guide.	
	For information about Intel QuickAssist Technology, see the Integrated Dell Remote Access Controller User's Guide.	
	For information about earlier versions of the iDRAC documents.	www.dell.com/idracmanuals
	To identify the version of iDRAC available on your system, on the iDRAC web interface, click ? > About .	
	For information about installing the operating system, see the operating system documentation.	www.dell.com/operatingsystemmanuals
	For information about updating drivers and firmware, see the Methods to download firmware and drivers section in this document.	www.dell.com/support/drivers

Table 34. Additional documentation resources for your system (continued)

Task	Document	Location
Managing your system	For information about systems management software offered by Dell, see the Dell OpenManage Systems Management Overview Guide.	www.dell.com/poweredgemanuals
	For information about setting up, using, and troubleshooting OpenManage, see the Dell OpenManage Server Administrator User's Guide.	www.dell.com/openmanagemanuals > OpenManage Server Administrator
	For information about installing and using Dell SupportAssist, see the Dell EMC SupportAssist Enterprise User's Guide.	https://www.dell.com/serviceabilitytools
	For information about partner programs enterprise systems management, see the OpenManage Connections Enterprise Systems Management documents.	www.dell.com/openmanagemanuals
Working with the Dell PowerEdge RAID controllers	For information about understanding the features of the Dell PowerEdge RAID controllers (PERC), Software RAID controllers, or BOSS card and deploying the cards, see the Storage controller documentation.	www.dell.com/storagecontrollermanuals
Understanding event and error messages	For information about the event and error messages generated by the system firmware and agents that monitor system components, go to qrl.dell.com > Look Up > Error Code , type the error code, and then click Look it up .	www.dell.com/qrl
Troubleshooting your system	For information about identifying and troubleshooting the PowerEdge server issues, see the Server Troubleshooting Guide.	www.dell.com/poweredgemanuals