



Lexmark™

B2865, M5255, M5270, MS725, MS821, MS822, MS823, MS825, MS826 Printers

User's Guide

August 2019

www.lexmark.com

Machine type(s):

4064

Models:

210, 230, 235, 295, 410, 430, 438, 630, 635, 695, 830

Contents

- Safety information..... 6**
 - Conventions..... 6
 - Product statements..... 6

- Learning about the printer..... 9**
 - Finding information about the printer.....9
 - Selecting a location for the printer..... 10
 - Printer configurations..... 11
 - Attaching cables..... 13

- Using the control panel..... 15**
 - Lexmark B2865, MS725, MS821, MS823, and MS825 printers..... 15**
 - Lexmark M5255, M5270, MS822, and MS826 printers.....16**
 - Understanding the status of the power button and indicator light..... 16

- Setting up and using the home screen applications..... 17**
 - Using the home screen..... 17
 - Customizing the home screen..... 18
 - Using Display Customization.....18
 - Configuring Eco-Settings..... 19
 - Creating a Cloud Connector profile..... 19
 - Setting up Device Quotas..... 19
 - Using QR Code Generator.....20
 - Using Customer Support.....20
 - Managing bookmarks..... 20
 - Managing contacts.....21

- Setting up and using the accessibility features..... 24**
 - Activating Voice Guidance.....24
 - Navigating the screen using gestures..... 24
 - Enabling Magnification mode..... 25
 - Adjusting the Voice Guidance speech rate.....25
 - Using the keyboard on the display.....25
 - Enabling spoken passwords or personal identification numbers..... 25

Loading paper and specialty media.....	26
Setting the paper size and type.....	26
Configuring Universal paper settings.....	26
Loading the 250- or 550-sheet tray.....	26
Loading the 2100-sheet tray.....	29
Loading the multipurpose feeder.....	34
Linking trays.....	35
Paper support.....	36
Supported paper sizes.....	36
Supported paper types.....	39
Supported paper weights.....	41
Printing.....	44
Printing from a computer.....	44
Printing from a mobile device.....	44
Printing from a flash drive.....	45
Supported flash drives and file types.....	46
Configuring confidential jobs.....	47
Printing confidential and other held jobs.....	47
Printing from a Cloud Connector profile.....	48
Printing a font sample list.....	48
Printing a directory list.....	49
Understanding the printer menus.....	50
Menu map.....	50
Device.....	51
Print.....	63
Paper.....	71
USB Drive.....	73
Network/Ports.....	74
Security.....	87
Reports.....	95
Help.....	95
Troubleshooting.....	96
Printing the Menu Settings Page.....	96

Securing the printer.....	97
Locating the security slot.....	97
Erasing printer memory.....	97
Erasing printer hard disk memory.....	97
Encrypting the printer hard disk.....	98
Restoring factory default settings.....	98
Statement of Volatility.....	98
Maintaining the printer.....	100
Adjusting the speaker volume.....	100
Networking.....	101
Cleaning the printer.....	103
Ordering parts and supplies.....	104
Replacing parts and supplies.....	108
Moving the printer.....	126
Saving energy and paper.....	127
Recycling.....	128
Clearing jams.....	129
Avoiding jams.....	129
Identifying jam locations.....	131
Paper jam in trays.....	133
Paper jam in door A.....	133
Paper jam in door C.....	136
Paper jam in the standard bin.....	137
Paper jam in the multipurpose feeder.....	138
Paper jam in the output expander.....	139
Paper jam in the high-capacity output expander.....	139
Paper jam in the 4-bin mailbox.....	140
Paper jam in the staple finisher.....	141
Paper jam in the staple, hole punch finisher.....	142
Staple jam in the staple finisher.....	143
Staple jam in the staple, hole punch finisher.....	146
Troubleshooting.....	149
Network connection problems.....	149

- Hardware options problems..... 151
- Issues with supplies..... 152
- Paper feed problems..... 154
- Printing problems..... 157
- Contacting customer support..... 188

- Upgrading and migrating..... 190**
 - Hardware..... 190
 - Software..... 215
 - Firmware..... 216

- Notices.....218**

- Index.....230**

Safety information







Conventions

Note: A *note* identifies information that could help you.







Warning: A *warning* identifies something that could damage the product hardware or software.

CAUTION: A *caution* indicates a potentially hazardous situation that could injure you.

Different types of caution statements include:

-  **CAUTION—POTENTIAL INJURY:** Indicates a risk of injury.
-  **CAUTION—SHOCK HAZARD:** Indicates a risk of electrical shock.
-  **CAUTION—HOT SURFACE:** Indicates a risk of burn if touched.
-  **CAUTION—TIPPING HAZARD:** Indicates a crush hazard.
-  **CAUTION—PINCH HAZARD:** Indicates a risk of being caught between moving parts.
-  **CAUTION—ROTATING FAN BLADES:** Indicates a risk of laceration from moving fan blades.

Product statements

-  **CAUTION—POTENTIAL INJURY:** To avoid the risk of fire or electrical shock, connect the power cord to an appropriately rated and properly grounded electrical outlet that is near the product and easily accessible.
-  **CAUTION—POTENTIAL INJURY:** To avoid the risk of fire or electrical shock, use only the power cord provided with this product or the manufacturer's authorized replacement.
-  **CAUTION—POTENTIAL INJURY:** Do not use this product with extension cords, multioutlet power strips, multioutlet extenders, or UPS devices. The power capacity of these types of accessories can be easily overloaded by a laser printer and may result in a risk of fire, property damage, or poor printer performance.
-  **CAUTION—POTENTIAL INJURY:** Only a Lexmark Inline Surge Protector that is properly connected between the printer and the power cord provided with the printer may be used with this product. The use of non-Lexmark surge protection devices may result in a risk of fire, property damage, or poor printer performance.
-  **CAUTION—SHOCK HAZARD:** To avoid the risk of electrical shock, do not place or use this product near water or wet locations.
-  **CAUTION—SHOCK HAZARD:** To avoid the risk of electrical shock, do not set up this product or make any electrical or cabling connections, such as the power cord, fax feature, or telephone, during a lightning storm.

 **CAUTION—POTENTIAL INJURY:** Do not cut, twist, bind, crush, or place heavy objects on the power cord. Do not subject the power cord to abrasion or stress. Do not pinch the power cord between objects such as furniture and walls. If any of these things happen, a risk of fire or electrical shock results. Inspect the power cord regularly for signs of such problems. Remove the power cord from the electrical outlet before inspecting it.

 **CAUTION—SHOCK HAZARD:** To avoid the risk of electrical shock, make sure that all external connections (such as Ethernet and telephone system connections) are properly installed in their marked plug-in ports.

 **CAUTION—SHOCK HAZARD:** To avoid the risk of electrical shock, if you are accessing the controller board or installing optional hardware or memory devices sometime after setting up the printer, then turn the printer off, and unplug the power cord from the electrical outlet before continuing. If you have any other devices attached to the printer, then turn them off as well, and unplug any cables going into the printer.

 **CAUTION—SHOCK HAZARD:** To avoid the risk of electrical shock when cleaning the exterior of the printer, unplug the power cord from the electrical outlet and disconnect all cables from the printer before proceeding.





 **CAUTION—POTENTIAL INJURY:** If the printer weight is greater than 18 kg (40 lb), then it requires two or more trained personnel to lift it safely.

 **CAUTION—POTENTIAL INJURY:** When moving the printer, follow these guidelines to avoid personal injury or printer damage:

- Make sure that all doors and trays are closed.
- Turn off the printer, and then unplug the power cord from the electrical outlet.
- Disconnect all cords and cables from the printer.
- If the printer has separate floor-standing optional trays or output options attached to it, then disconnect them before moving the printer.
- If the printer has a caster base, then carefully roll it to the new location. Use caution when passing over thresholds and breaks in flooring.
- If the printer does not have a caster base but is configured with optional trays or output options, then remove the output options and lift the printer off the trays. Do not try to lift the printer and any options at the same time.
- Always use the handholds on the printer to lift it.
- Any cart used to move the printer must have a surface able to support the full footprint of the printer.
- Any cart used to move the hardware options must have a surface able to support the dimensions of the options.
- Keep the printer in an upright position.
- Avoid severe jarring movements.
- Make sure that your fingers are not under the printer when you set it down.
- Make sure that there is adequate clearance around the printer.

 **CAUTION—TIPPING HAZARD:** Installing one or more options on your printer or MFP may require a caster base, furniture, or other feature to prevent instability causing possible injury. For more information on supported configurations, see www.lexmark.com/multifunctionprinters.

 **CAUTION—TIPPING HAZARD:** To reduce the risk of equipment instability, load each tray separately. Keep all other trays closed until needed.

-  **CAUTION—HOT SURFACE:** The inside of the printer might be hot. To reduce the risk of injury from a hot component, allow the surface to cool before touching it.
-  **CAUTION—PINCH HAZARD:** To avoid the risk of a pinch injury, use caution in areas marked with this label. Pinch injuries may occur around moving parts, such as gears, doors, trays, and covers.
-  **CAUTION—ROTATING FAN BLADES:** To avoid the risk of laceration from moving fan blades, turn off the printer and unplug the power cord from the electrical outlet before accessing areas marked with this symbol.
-  **CAUTION—POTENTIAL INJURY:** This product uses a laser. Use of controls or adjustments or performance of procedures other than those specified in the *User's Guide* may result in hazardous radiation exposure.
-  **CAUTION—POTENTIAL INJURY:** The lithium battery in this product is not intended to be replaced. There is a danger of explosion if a lithium battery is incorrectly replaced. Do not recharge, disassemble, or incinerate a lithium battery. Discard used lithium batteries according to the manufacturer's instructions and local regulations.

This product is designed, tested, and approved to meet strict global safety standards with the use of specific manufacturer's components. The safety features of some parts may not always be obvious. The manufacturer is not responsible for the use of other replacement parts.

Refer service or repairs, other than those described in the user documentation, to a service representative.

This product uses a printing process that heats the print media, and the heat may cause the media to release emissions. You must understand the section in your operating instructions that discusses the guidelines for selecting print media to avoid the possibility of harmful emissions.

This product may produce small amounts of ozone during normal operation, and may be equipped with a filter designed to limit ozone concentrations to levels well below the recommended exposure limits. To avoid high ozone concentration levels during extensive usage, install this product in a well-ventilated area and replace the ozone and exhaust filters if instructed to do so in the product maintenance instructions. If there are no references to filters in the product maintenance instructions, then there are no filters requiring replacement for this product.

SAVE THESE INSTRUCTIONS.

Learning about the printer

Finding information about the printer

What are you looking for?	Find it here
Initial setup instructions: <ul style="list-style-type: none"> • Connecting the printer • Installing the printer software 	See the setup documentation that came with the printer or go to http://support.lexmark.com .
More setup and instructions for using the printer: <ul style="list-style-type: none"> • Selecting and storing paper and specialty media • Loading paper • Configuring printer settings • Viewing and printing documents and photos • Setting up and using the printer software • Configuring the printer on a network • Caring for and maintaining the printer • Troubleshooting and solving problems 	<i>Information Center</i> —Go to http://infoserve.lexmark.com . <i>Help Menu Pages</i> —Access the guides on the printer firmware or go to http://support.lexmark.com . <i>Touch Screen Guide</i> —Go to http://support.lexmark.com . Product videos—Go to http://infoserve.lexmark.com/idv/ .
Information on setting up and configuring the accessibility features of your printer	<i>Lexmark Accessibility Guide</i> —Go to http://support.lexmark.com .
Help using the printer software	Help for Microsoft® Windows® or Macintosh operating systems—Open a printer software program or application, and then click Help . Click  to view context-sensitive information. Notes: <ul style="list-style-type: none"> • Help is automatically installed with the printer software. • Depending on the operating system, the printer software is located in the printer program folder or on the desktop.

What are you looking for?	Find it here
<p>The latest supplemental information, updates, and customer support:</p> <ul style="list-style-type: none"> • Documentation • Driver downloads • Live chat support • E-mail support • Voice support 	<p>Go to http://support.lexmark.com.</p> <p>Note: Select your country or region, and then select your product to view the appropriate support site.</p> <p>Support contact information for your country or region can be found on the website or on the printed warranty that came with the printer.</p> <p>Have the following information ready when you contact customer support:</p> <ul style="list-style-type: none"> • Place and date of purchase • Machine type and serial number 
<ul style="list-style-type: none"> • Safety information • Regulatory information • Warranty information • Environmental information 	<p>Warranty information varies by country or region:</p> <ul style="list-style-type: none"> • In the U.S.—See the Statement of Limited Warranty included with the printer, or go to http://support.lexmark.com. • In other countries and regions—See the printed warranty that came with the printer. <p><i>Product Information Guide</i>—See the documentation that came with the printer or go to http://support.lexmark.com.</p>

Selecting a location for the printer

When selecting a location for the printer, leave enough room to open trays, covers, and doors and to install hardware options.

- Set up the printer near an electrical outlet.

 **CAUTION—POTENTIAL INJURY:** To avoid the risk of fire or electrical shock, connect the power cord to an appropriately rated and properly grounded electrical outlet that is near the product and easily accessible.

 **CAUTION—SHOCK HAZARD:** To avoid the risk of electrical shock, do not place or use this product near water or wet locations.

- Make sure that airflow in the room meets the latest revision of the ASHRAE 62 standard or the CEN Technical Committee 156 standard.
- Provide a flat, sturdy, and stable surface.

- Keep the printer:
 - Clean, dry, and free of dust.
 - Away from stray staples and paper clips.
 - Away from the direct airflow of air conditioners, heaters, or ventilators.
 - Free from direct sunlight and humidity extremes.
- Observe the recommended temperatures and avoid fluctuations:

Ambient temperature	10 to 32.2°C (50 to 90°F)
Storage temperature	-40 to 43.3°C (-40 to 110°F)

- Allow the following recommended amount of space around the printer for proper ventilation:

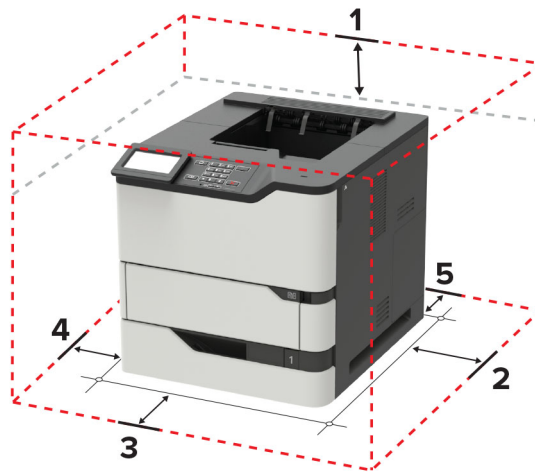

1	Top	152 mm (6 in.)
2	Right side	152 mm (6 in.)
3	Front	406 mm (16 in.) Note: The minimum space needed in front of the printer is 76 mm (3 in.).
4	Left side	152 mm (6 in.)
5	Rear	152 mm (6 in.)

Printer configurations

CAUTION—TIPPING HAZARD: Installing one or more options on your printer or MFP may require a caster base, furniture, or other feature to prevent instability causing possible injury. For more information on supported configurations, see www.lexmark.com/multifunctionprinters.

CAUTION—TIPPING HAZARD: To reduce the risk of equipment instability, load each tray separately. Keep all other trays closed until needed.

You can configure your printer by adding optional 250-, 550-, or 2100-sheet trays. For more information, see [“Installing the 250- or 550-sheet tray” on page 199](#) or [“Installing the 2100-sheet tray” on page 200](#).

Basic model



1	Standard 550-sheet tray
2	Multipurpose feeder
3	Control panel Note: The appearance may vary depending on your printer model.
4	Standard bin

Fully-configured model

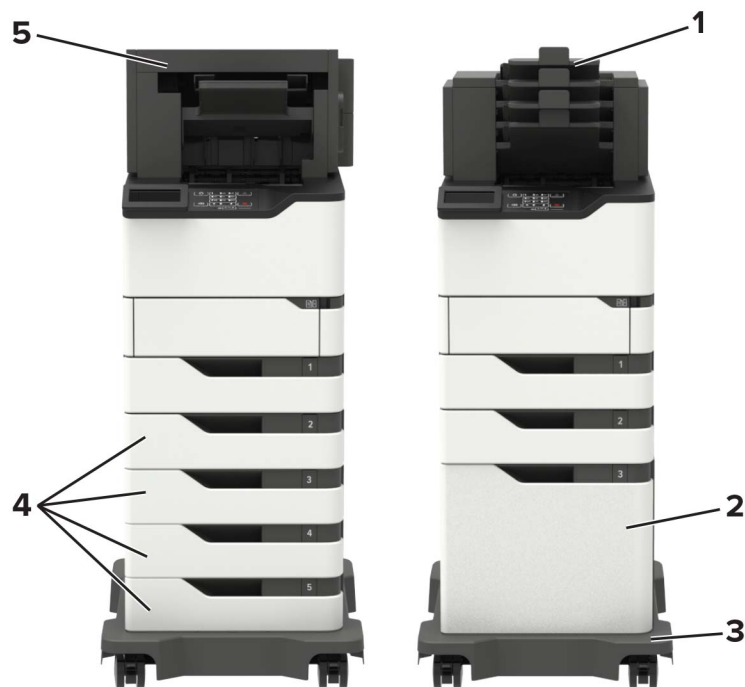

	Hardware option	Alternative hardware option
1	4-bin mailbox	<ul style="list-style-type: none"> • Output expander • High-capacity output • Staple finisher • Staple, hole punch finisher
2	Optional 2100-sheet tray	None
3	Caster base	None
4	Optional 550-sheet tray	Optional 250-sheet tray
5	Staple, hole punch finisher	<ul style="list-style-type: none"> • Output expander • High-capacity output • 4-bin mailbox • Staple finisher

The staple, hole punch finisher must not be combined with any other output options.

In a configuration with two or more optional finishers:

- The staple finisher must always be on top.
- The high-capacity output expander must always be at the bottom.
- The output expander is the only option that can be placed on top of the high-capacity output expander.
- The output expander and mailbox may be installed in any order.

When using optional trays:

- Always use a caster base when the printer is configured with a 2100-sheet tray.
- The 2100-sheet tray must always be at the bottom of a configuration.
- A maximum of four optional trays may be configured with the printer.
- The optional 250- and 550-sheet trays may be installed in any order.

Attaching cables

 **CAUTION—SHOCK HAZARD:** To avoid the risk of electrical shock, do not set up this product or make any electrical or cabling connections, such as the power cord, fax feature, or telephone, during a lightning storm.

 **CAUTION—POTENTIAL INJURY:** To avoid the risk of fire or electrical shock, connect the power cord to an appropriately rated and properly grounded electrical outlet that is near the product and easily accessible.

 **CAUTION—POTENTIAL INJURY:** To avoid the risk of fire or electrical shock, use only the power cord provided with this product or the manufacturer's authorized replacement.

Warning—Potential Damage: To avoid loss of data or printer malfunction, do not touch the USB cable, any wireless network adapter, or the printer in the areas shown while actively printing.

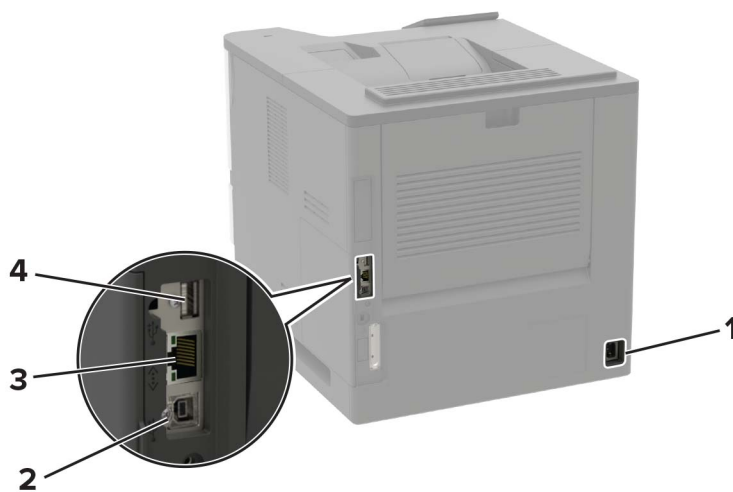

	Use the	To
1	Power cord socket	Connect the printer to an electrical outlet.
2	USB printer port	Connect the printer to a computer.
3	Ethernet port	Connect the printer to a network.
4	USB port	Attach a keyboard or any compatible option.

Using the control panel

Lexmark B2865, MS725, MS821, MS823, and MS825 printers

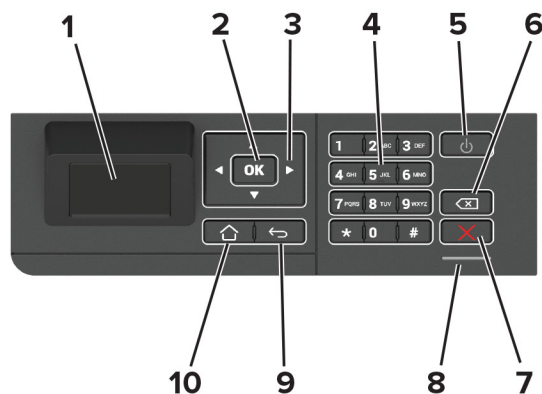

	Use the	To
1	Display	<ul style="list-style-type: none"> View printer messages and supply status. Set up and operate the printer.
2	Select button	<ul style="list-style-type: none"> Select a menu option. Save the changes in a setting.
3	Arrow buttons	<ul style="list-style-type: none"> Scroll through menus or move between screens and menu options. Adjust the numeric value of a setting.
4	Numeric keypad	Enter numbers or symbols in an input field.
5	Power button	Turn on or turn off the printer. Note: To turn off the printer, press and hold the power button for five seconds.
6	Backspace button	Move the cursor backward and delete a character in an input field.
7	Stop or Cancel button	Stop the current printer task.
8	Indicator light	Check the printer status.
9	Back button	Return to the previous screen.
10	Home button	Go to the home screen.

Lexmark M5255, M5270, MS822, and MS826 printers

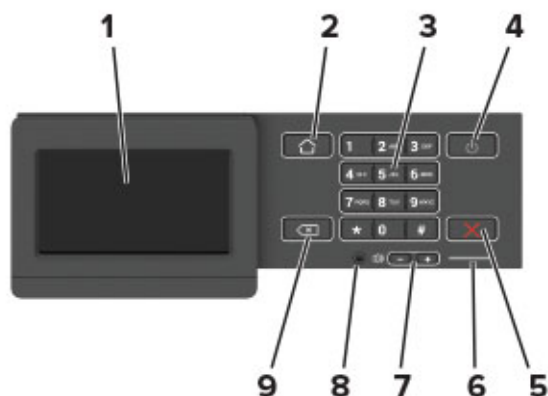

	Use the	To
1	Display	<ul style="list-style-type: none"> View printer messages and supply status. Set up and operate the printer.
2	Home button	Go to the home screen.
3	Numeric keypad	Enter numbers or symbols in an input field.
4	Power button	Turn on or turn off the printer. Note: To turn off the printer, press and hold the power button for five seconds.
5	Stop or Cancel button	Stop the current printer task.
6	Indicator light	Check the printer status.
7	Volume buttons	Adjust the speaker volume.
8	Headset or speaker port	Attach a headset or speaker. Note: This feature is available only in some printer units.
9	Back button	Return to the previous screen.

Understanding the status of the power button and indicator light

Indicator light	Printer status
Off	The printer is off or in Hibernate mode.
Blue	The printer is ready or processing data.
Red	The printer requires user intervention.

Power button light	Printer status
Off	The printer is off, ready, or processing data.
Solid amber	The printer is in Sleep mode.
Blinking amber	The printer is in Hibernate mode.

Setting up and using the home screen applications

Note: These applications are supported only in some printer models.

Using the home screen

Note: Your home screen may vary depending on your home screen customization settings, administrative setup, and active embedded solutions.

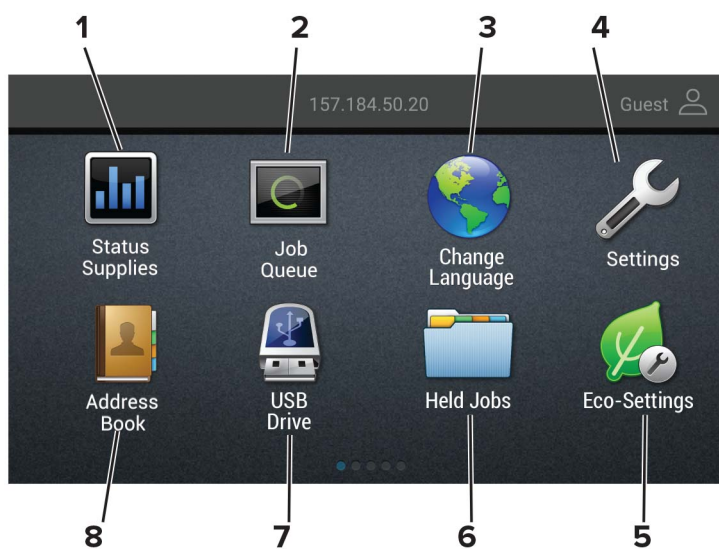

Touch		To
1	Status/Supplies	<ul style="list-style-type: none"> Show a warning or error message whenever the printer requires intervention to continue processing. View more information on the printer warning or message, and on how to clear it. <p>Note: You can also access this setting by touching the top section of the home screen.</p>
2	Job Queue	<p>Show all the current print jobs.</p> <p>Note: You can also access this setting by touching the top section of the home screen.</p>
3	Change Language	Change the language on the display.
4	Settings	Access the printer menus.
5	Eco-Settings	Manage energy consumption, noise, toner, and paper usage settings.
6	Held Jobs	Show the print jobs that are held in the printer memory.
7	USB Drive	Print photos and documents from a flash drive.
8	Address Book	Manage a contact list that other applications on the printer can access.

Customizing the home screen

- 1 Open a web browser, and then type the printer IP address in the address field.

Notes:

- View the printer IP address on the printer home screen. The IP address appears as four sets of numbers separated by periods, such as 123.123.123.123.
- If you are using a proxy server, then temporarily disable it to load the web page correctly.

- 2 Click **Settings > Device > Visible Home Screen Icons**.
- 3 Select the icons that you want to appear on the home screen.
- 4 Apply the changes.

Using Display Customization

Before using the application, make sure to do the following:

- From the Embedded Web Server, click **Apps > Display Customization > Configure**.
- Enable and configure the screen saver, slideshow, and wallpaper settings.

Managing screen saver and slide show images

- 1 From the Screen Saver and Slideshow Images section, add, edit, or delete an image.

Notes:

- You can add up to 10 images.
- When enabled, the status icons appear on the screen saver only when there are errors, warnings, or cloud-based notifications.

- 2 Apply the changes.

Changing the wallpaper image

- 1 From the home screen, touch **Change Wallpaper**.
- 2 Select an image to use.
- 3 Apply the changes.

Running a slide show from a flash drive

- 1 Insert a flash drive into the USB port.
- 2 From the home screen, touch **Slideshow**.
Images appear in alphabetical order.

Note: You can remove the flash drive after the slide show starts, but the images are not stored in the printer. If the slide show stops, then insert the flash drive again to view the images.

Configuring Eco-Settings

- 1 From the home screen, touch **Eco-Settings**.
- 2 Configure Eco-Mode or Schedule Power Modes.
- 3 Apply the changes.

Creating a Cloud Connector profile

We recommend logging in to the printer before you create a profile. To enable a login method, see the *Embedded Web Server - Security Admin Guide*.

- 1 From the home screen, touch **Cloud Connector**.
- 2 Select a cloud service provider.
- 3 Touch **Create a Profile** or .
- 4 Type a unique profile name.
- 5 If necessary, enter a PIN.
Note: When using the printer as guest, protect the profile with a PIN.
- 6 Touch **Create**, and then take note of the authorization code.
Note: The authorization code is valid only for 24 hours.
- 7 Open a web browser, and then go to <https://lexmark.cloud-connect.co>.
- 8 Click **Next**, and then accept the Terms of Use.
- 9 Enter the authorization code, and then click **Connect**.
- 10 Log in to your cloud service provider account.
- 11 Grant permissions.

Note: To complete the authorization process, open the profile within 72 hours.

Setting up Device Quotas

You may need administrative rights to access the application.

- 1 Open a Web browser, and then type the printer IP address in the address field.

Notes:

- View the printer IP address on the printer home screen. The IP address appears as four sets of numbers separated by periods, such as 123.123.123.123.
- If you are using a proxy server, then temporarily disable it to load the Web page correctly.

- 2 Click **Apps > Device Quotas > Configure**.
- 3 From the User Accounts section, add or edit a user, and then set the user quota.
- 4 Apply the changes.

Note: For information on how to configure the application and its security settings, see the *Device Quotas Administrator's Guide*.

Using QR Code Generator

You may need administrative rights to access the application.

- 1 Open a Web browser, and then type the printer IP address in the address field.

Notes:

- View the printer IP address on the printer home screen. The IP address appears as four sets of numbers separated by periods, such as 123.123.123.123.
- If you are using a proxy server, then temporarily disable it to load the Web page correctly.

- 2 Click **Apps > QR Code Generator > Configure**.

- 3 Do either of the following:

- Select a default QR code value.
- Type a QR code value.

- 4 Apply the changes.

Using Customer Support

- 1 From the home screen, touch **Customer Support**.

- 2 Print or e-mail the information.

Note: For information on configuring the application settings, see the *Customer Support Administrator's Guide*.

Managing bookmarks

Creating bookmarks

Use bookmarks to print frequently accessed documents that are stored in servers or on the web.

- 1 Open a web browser, and then type the printer IP address in the address field.

Notes:

- View the printer IP address on the printer home screen. The IP address appears as four sets of numbers separated by periods, such as 123.123.123.123.
- If you are using a proxy server, then temporarily disable it to load the web page correctly.

- 2 Click **Bookmark Setup > Add Bookmark**, and then type a unique name for the bookmark.

3 Select an Address protocol type, and then do one of the following:

- For HTTP and HTTPS, type the URL that you want to bookmark.
- For HTTPS, make sure to use the host name instead of the IP address. For example, type **myWebsite.com/sample.pdf** instead of typing **123.123.123.123/sample.pdf**. Make sure that the host name also matches the Common Name (CN) value in the server certificate. For more information on obtaining the CN value in the server certificate, see the help information for your web browser.
- For FTP, type the FTP address. For example, **myServer/myDirectory**. Enter the FTP port. Port 21 is the default port for sending commands.
- For SMB, type the network folder address. For example, **myServer/myShare/myFile.pdf**. Type the network domain name.
- If necessary, select the Authentication type for FTP and SMB.

To limit access to the bookmark, enter a PIN.

Note: The application supports the following file types: PDF, JPEG, TIFF, and HTML-based web pages. Other file types such as DOCX and XLXS are supported in some printer models.

4 Click **Save**.

Note: To manage bookmarks, click **Bookmark Setup**.

Creating folders

1 Open a web browser, and then type the printer IP address in the address field.

Notes:

- View the printer IP address on the printer home screen. The IP address appears as four sets of numbers separated by periods, such as 123.123.123.123.
- If you are using a proxy server, then temporarily disable it to load the web page correctly.

2 Click **Bookmark Setup > Add Folder**, and then type a unique name for the folder.

Note: To limit access to the folder, enter a PIN.

3 Click **Save**.

Notes:

- You can create folders or bookmarks inside a folder. To create a bookmark, see [“Creating bookmarks” on page 20](#).
- To manage folders, click **Bookmark Setup**.

Managing contacts

Adding contacts

1 Open a web browser, and then type the printer IP address in the address field.

Notes:

- View the printer IP address on the printer home screen. The IP address appears as four sets of numbers separated by periods, such as 123.123.123.123.

- If you are using a proxy server, then temporarily disable it to load the web page correctly.

2 Click **Address Book**.

3 From the Contacts section, add a contact.

Note: You can assign the contact to one or more groups.

4 If necessary, specify a login method to allow application access.

5 Apply the changes.

Adding groups

1 Open a web browser, and then type the printer IP address in the address field.

Notes:

- View the printer IP address on the printer home screen. The IP address appears as four sets of numbers separated by periods, such as 123.123.123.123.
- If you are using a proxy server, then temporarily disable it to load the web page correctly.

2 Click **Address Book**.

3 From the Contact Groups section, add a group name.

Note: You can assign one or more contacts to the group.

4 Apply the changes.

Editing contacts or groups

1 Open a web browser, and then type the printer IP address in the address field.

Notes:

- View the printer IP address on the printer home screen. The IP address appears as four sets of numbers separated by periods, such as 123.123.123.123.
- If you are using a proxy server, then temporarily disable it to load the web page correctly.

2 Click **Address Book**.

3 Do either of the following:

- From the Contacts section, click a contact name, and then edit the information.
- From the Contact Groups section, click a group name, and then edit the information.

4 Apply the changes.

Deleting contacts or groups

1 Open a web browser, and then type the printer IP address in the address field.

Notes:

- View the printer IP address on the printer home screen. The IP address appears as four sets of numbers separated by periods, such as 123.123.123.123.

- If you are using a proxy server, then temporarily disable it to load the web page correctly.

2 Click **Address Book**.

3 Do either of the following:

- From the Contacts section, select a contact that you want to delete.
- From the Contact Groups section, select a group name that you want to delete.

Setting up and using the accessibility features

Notes:

- These features are supported only in some printer models.
- For more information on the accessibility features of your printer model, see the Accessibility Guide at <http://support.lexmark.com>.

Activating Voice Guidance

From the control panel

- 1 Press and hold the **5** key until you hear a voice message.
- 2 Select **OK**.

From the keyboard

- 1 Press and hold the **5** key until you hear a voice message.
- 2 Press **Tab** to navigate the focus cursor to the OK button, and then press **Enter**.

Notes:

- Voice Guidance is also activated when you insert headphones into the headphone jack.
- To adjust the volume, use the volume buttons at the bottom part of the control panel.

Navigating the screen using gestures

Notes:

- The gestures are applicable only when Voice Guidance is activated.
- Enable Magnification to use the zoom and pan gestures.
- Use a physical keyboard to type characters and adjust certain settings.

Gesture	Function
Double-tap	Select an option or item on the screen.
Triple-tap	Zoom in or zoom out text and images.
Swipe right or swipe down	Move to the next item on the screen.
Swipe left or swipe up	Move to the previous item on the screen.
Pan	Access parts of the zoomed image that are beyond the limits of the screen. Note: This gesture requires the use of two fingers to drag across a zoomed image.
Swipe up then left	Exit an application and return to the home screen.

Gesture	Function
Swipe down then left	<ul style="list-style-type: none">• Cancel a job.• Go back to the previous setting.• Exit the screen that appears without changing any setting or value.
Swipe up then down	Repeat a spoken prompt.

Enabling Magnification mode

- 1 From the control panel, press and hold the **5** key until you hear a voice message.
- 2 Select **Magnification mode**.
- 3 Select **OK**.

For more information on navigating a magnified screen, see [“Navigating the screen using gestures” on page 24](#).

Adjusting the Voice Guidance speech rate

- 1 From the home screen, select **Settings > Device > Accessibility > Speech Rate**.
- 2 Select the speech rate.

Using the keyboard on the display

Do one or more of the following:

- Drag a finger over the key to announce the character.
- Lift the finger to enter or type the character in the field.
- Select **Backspace** to delete characters.
- To hear the content in the input field, select **Tab**, and then select **Shift + Tab**.

Enabling spoken passwords or personal identification numbers

- 1 From the home screen, select **Settings > Device > Accessibility > Speak Passwords/PINs**.
- 2 Enable the setting.

Loading paper and specialty media

Setting the paper size and type

- 1 From the control panel, navigate to:
Settings > Paper > Tray Configuration > Paper Size/Type > select a paper source

For non-touch-screen printer models, press  to navigate through the settings.
- 2 Set the paper size and type.

Configuring Universal paper settings

- 1 From the control panel, navigate to:
Settings > Paper > Media Configuration > Universal Setup

For non-touch-screen printer models, press  to navigate through the settings.
- 2 Configure the settings.

Loading the 250- or 550-sheet tray

 **CAUTION—POTENTIAL INJURY:** To reduce the risk of equipment instability, load each tray separately. Keep all other trays closed until needed.

- 1 Remove the tray.
Note: To avoid paper jams, do not remove trays while the printer is busy.



- 2 Adjust the guides to match the size of the paper that you are loading.
Note: Use the indicators on the bottom of the tray to position the guides.

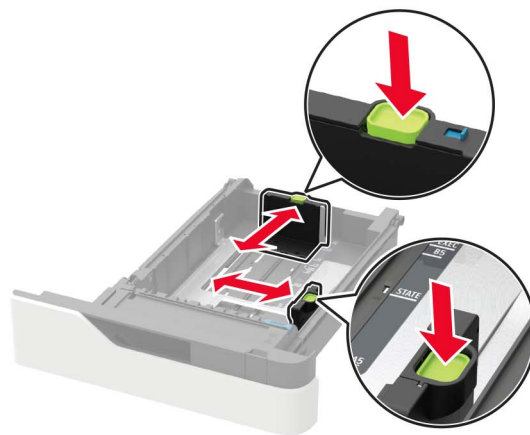
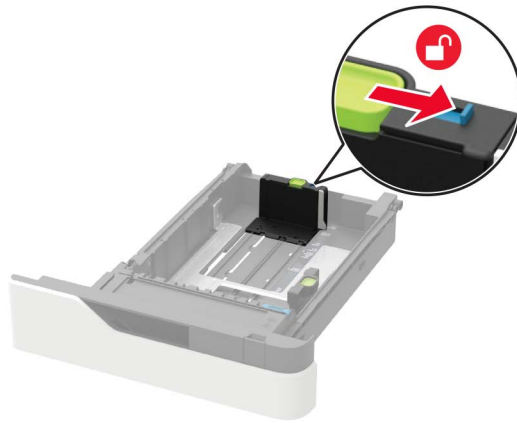

3 Flex, fan, and align the paper edges before loading.

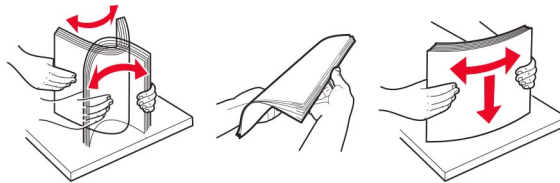

4 Load the paper stack with the printable side facedown, and then make sure that the side guides fit snugly against the paper.

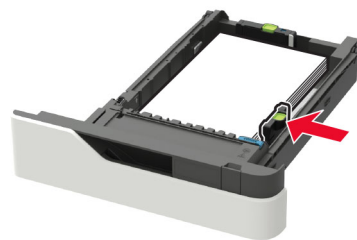

- Do not slide paper into the tray.
- To avoid paper jams, make sure that the stack height is below the maximum paper fill indicator.



- Load letterhead depending on whether an optional staple finisher is installed or not.

Without an optional staple finisher	With an optional staple finisher
<p>One-sided printing</p>	<p>One-sided printing</p>
<p>Two-sided printing</p>	<p>Two-sided printing</p>

- When loading prepunched paper, make sure that the holes on the long edge of the paper are against the right side of the tray.

One-sided printing	Two-sided printing

- Load envelopes with the flap side up and against the left side of the tray.

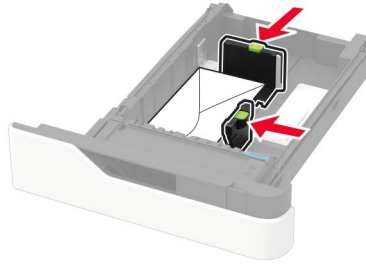

Warning—Potential Damage: Do not use envelopes with stamps, clasps, snaps, windows, coated linings, or self-stick adhesives.

- 5 Insert the tray.
- 6 From the control panel, set the paper size and paper type to match the paper loaded.

Loading the 2100-sheet tray

CAUTION—TIPPING HAZARD: To reduce the risk of equipment instability, load each tray separately. Keep all other trays closed until needed.

- 1 Pull out the tray.
- 2 Adjust the guides.

Loading A5-size paper

- a Pull up and slide the width guide to the position for A5.



- b** Squeeze and slide the length guide to the position for A5 until it *clicks* into place.

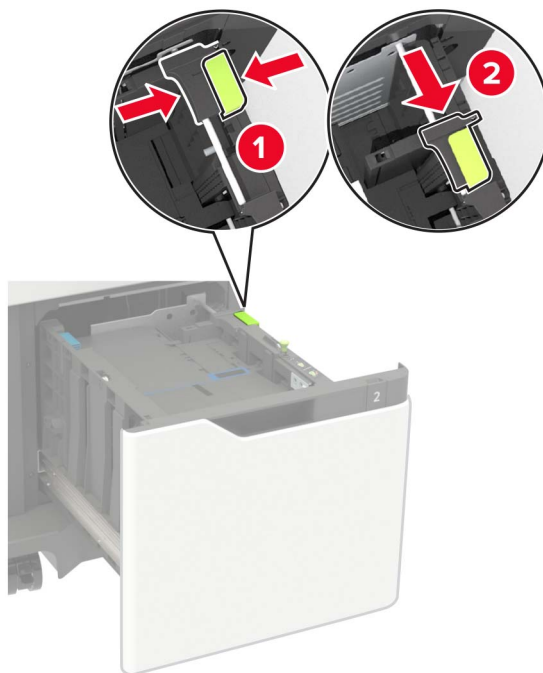

- c** Remove the A5 length guide from its holder.

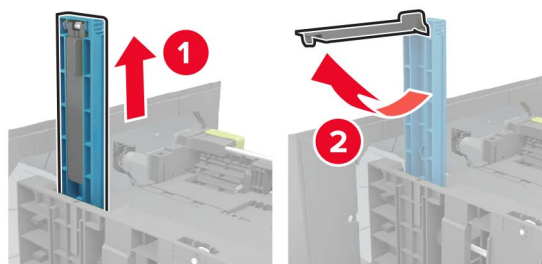

- d** Insert the guide into its designated slot, and then press until it *clicks* into place.

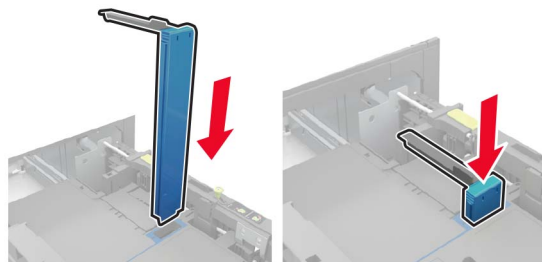

Loading A4-, letter-, legal-, Oficio-, and folio-size paper

- a Pull up and slide the width guide to the correct position for the size of the paper being loaded.



- b If the A5 length guide is still attached, then remove it. If the guide is not attached, then proceed to [step d on page 32](#).

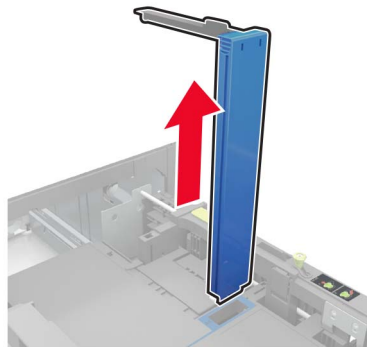

- c Place the A5 length guide in its holder.

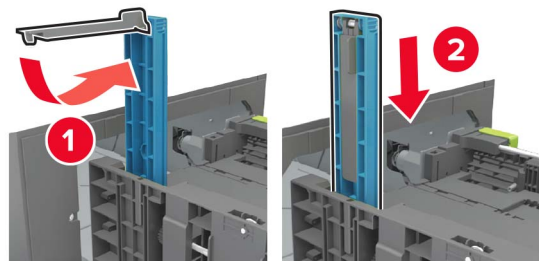

- d Squeeze, and then slide the length guide to the correct position for the size of the paper being loaded.

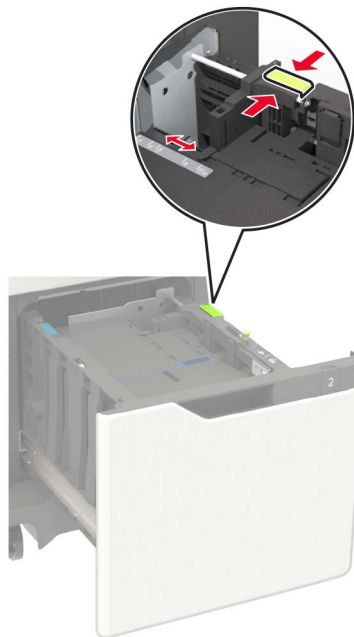

- 3 Flex, fan, and align the paper edges before loading.

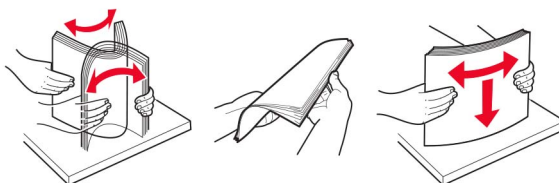

- 4 Load the paper stack with the printable side facedown.

- Load letterhead depending on whether an optional staple finisher is installed or not.

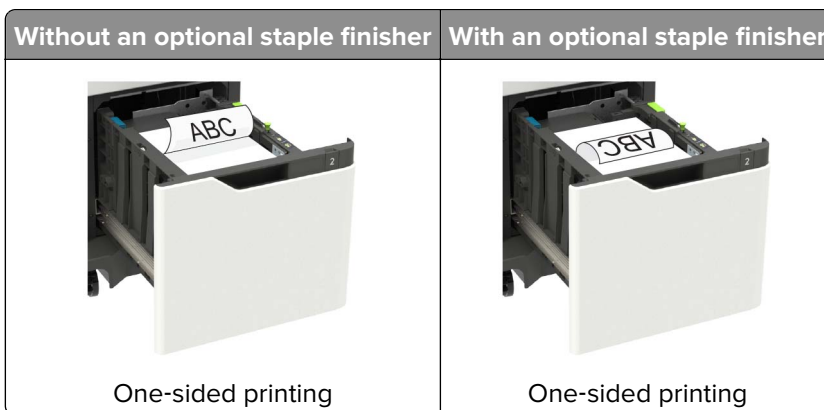

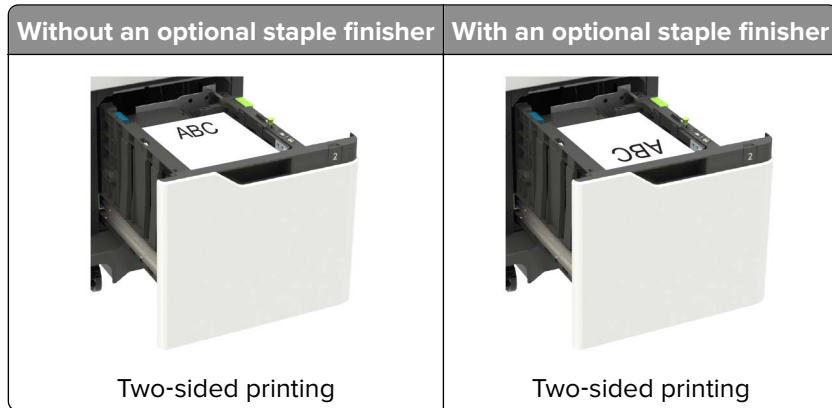

- When loading prepunched paper, make sure that the holes on the long edge of the paper are against the right side of the tray.

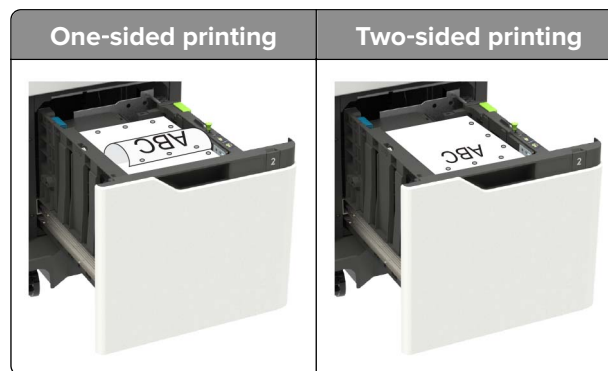

5 Insert the tray.

Note: Press down the paper stack while inserting the tray.

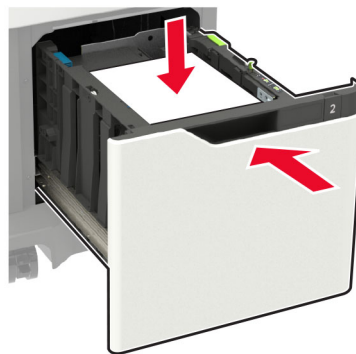

6 From the control panel, set the paper size and paper type to match the paper loaded.

Loading the multipurpose feeder

1 Open the multipurpose feeder.



2 Adjust the guide to match the size of the paper that you are loading.



3 Flex, fan, and align the paper edges before loading.

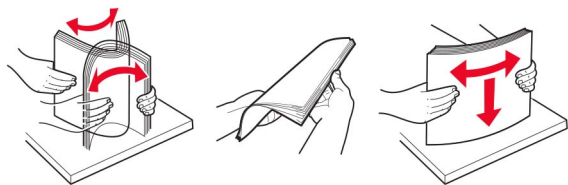

4 Load paper with the printable side faceup.

- Load letterhead depending on whether an optional staple finisher is installed or not.

Without an optional staple finisher	With an optional staple finisher
<p>A 3D view of the printer's multipurpose feeder with a sheet of paper labeled 'ABC' loaded. The paper is oriented with the printable side (top) facing up.</p>	<p>A 3D view of the printer's multipurpose feeder with a sheet of paper labeled 'ABC' loaded. The paper is oriented with the printable side (top) facing up.</p>
One-sided printing	One-sided printing

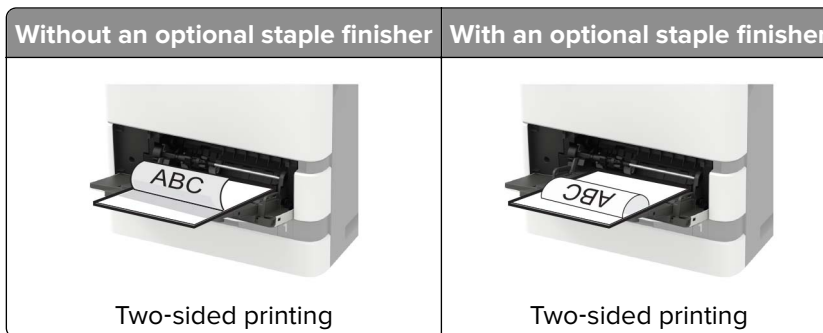

- When loading prepunched paper, make sure that the holes on the long edge of the paper are against the right side of the paper guide.

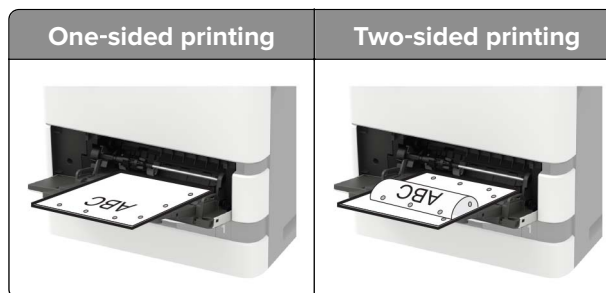

- Load envelopes with the flap side down and against the left side of the paper guide.

Warning—Potential Damage: Do not use envelopes with stamps, clasps, snaps, windows, coated linings, or self-stick adhesives.

- 5 From the control panel, set the paper size and paper type to match the paper loaded.

Linking trays

- 1 Open a web browser, and then type the printer IP address in the address field.

Notes:

- View the printer IP address on the printer home screen. The IP address appears as four sets of numbers separated by periods, such as 123.123.123.123.
- If you are using a proxy server, then temporarily disable it to load the web page correctly.

- 2 Click **Settings > Paper > Tray Configuration**.

- 3 Set the same paper size and paper type for the trays that you are linking.

- 4 Save the settings.

- 5 Click **Settings > Device > Maintenance > Configuration Menu > Tray Configuration**.

- 6 Set Tray Linking to **Automatic**.

- 7 Save the settings.

To unlink trays, make sure that no trays have the same paper size and paper type settings.

Warning—Potential Damage: The temperature of the fuser varies according to the specified paper type. To avoid printing issues, match the paper type setting in the printer with the paper loaded in the tray.

Paper support

Supported paper sizes

Paper sizes supported by the printer

Paper size	Standard 550-sheet tray, optional 250- or 550-sheet tray	Optional 2100-sheet tray	Multipurpose feeder	Two-sided printing
A4 210 x 297 mm (8.3 x 11.7 in.)	✓	✓	✓	✓
A5 LEF¹ 210 x 148 mm (8.3 x 5.8 in.)	✓	✓	✓	✓
A5 SEF¹ 148 x 210 mm (5.8 x 8.3 in.)	✓	x	✓	x
A6 105 x 148 mm (4.1 x 5.8 in.)	✓	x	✓	✓
JIS B5 182 x 257 mm (7.2 x 10.1 in.)	✓	x	✓	✓
Oficio (Mexico) 216 x 340 mm (8.5 x 13.4 in.)	✓	✓	✓	✓
Statement 140 x 216 mm (5.5 x 8.5 in.)	✓	x	✓	✓
Executive 184 x 267 mm (7.3 x 10.5 in.)	✓	x	✓	✓
Letter 216 x 279 mm (8.5 x 11 in.)	✓	✓	✓	✓
Legal 216 x 356 mm (8.5 x 14 in.)	✓	✓	✓	✓
Folio 216 x 330 mm (8.5 x 13 in.)	✓	✓	✓	✓
Universal 105 x 148 mm (4.1 x 5.8 in.) to 216 x 356 mm (8.5 x 14 in.)	✓	x	✓	✓
7 3/4 Envelope (Monarch)³ 98 x 191 mm (3.9 x 7.5 in.)	✓	x	✓	x

¹ A5 long edge feed (LEF) is recommended over A5 short edge feed (SEF).

² Envelopes wider than 101.6 mm (4.5 in.) may crease. This paper type must be tested for acceptability.

³ Envelopes are not supported on Lexmark MS725.

Paper size	Standard 550-sheet tray, optional 250- or 550-sheet tray	Optional 2100-sheet tray	Multipurpose feeder	Two-sided printing
9 Envelope ³ 98 x 225 mm (3.9 x 8.9 in.)	✓	X	✓	X
10 Envelope ^{2,3} 105 x 241 mm (4.1 x 9.5 in.)	✓	X	✓	X
DL Envelope ^{2,3} 110 x 220 mm (4.3 x 8.7 in.)	✓	X	✓	X
C5 Envelope ^{2,3} 162 x 229 mm (6.4 x 9 in.)	✓	X	✓	X
B5 Envelope ^{2,3} 176 x 250 mm (6.9 x 9.8 in.)	✓	X	✓	X
Other Envelope ^{2,3} 98.4 x 162 mm (3.9 x 6.4 in.) to 176 x 250 mm (6.9 x 9.8 in.)	✓	X	✓	X

¹ A5 long edge feed (LEF) is recommended over A5 short edge feed (SEF).

² Envelopes wider than 101.6 mm (4.5 in.) may crease. This paper type must be tested for acceptability.

³ Envelopes are not supported on Lexmark MS725.

Paper sizes supported by the output options or finishers

Paper size	Output expander or high-capacity output expander	4-bin mailbox	Staple finisher		Staple, hole punch finisher		
			Stack	Staple	Stack	Staple	Hole punch
A4 210 x 297 mm (8.3 x 11.7 in.)	✓	✓	✓	✓	✓	✓	✓
A5 LEF 210 x 148 mm (8.3 x 5.8 in.)	✓	✓	✓	✓	✓	✓	X
A5 SEF 148 x 210 mm (5.8 x 8.3 in.)	✓	✓	✓	X	✓	X	X
A6 105 x 148 mm (4.1 x 5.8 in.)	✓	✓	X	X	X	X	X
JIS B5 182 x 257 mm (7.2 x 10.1 in.)	✓	✓	✓	X	✓	X	X

Paper size	Output expander or high-capacity output expander	4-bin mailbox	Staple finisher		Staple, hole punch finisher		
			Stack	Staple	Stack	Staple	Hole punch
Oficio (Mexico) 216 x 340 mm (8.5 x 13.4 in.)	✓	✓	✓	✓	✓	✓	✓
Statement 140 x 216 mm (5.5 x 8.5 in.)	✓	✓	✓	X	✓	X	X
Executive 184 x 267 mm (7.3 x 10.5 in.)	✓	✓	✓	X	✓	X	X
Letter 216 x 279 mm (8.5 x 11 in.)	✓	✓	✓	✓	✓	✓	✓
Legal 216 x 356 mm (8.5 x 14 in.)	✓	✓	✓	✓	✓	✓	X
Folio 216 x 330 mm (8.5 x 13 in.)	✓	✓	✓	✓	✓	✓	✓
Universal 105 x 148 mm (4.1 x 5.8 in.) to 216 x 356 mm (8.5 x 14 in.)	✓	✓	X	X	X	X	X
7 3/4 Envelope (Monarch) 98 x 191 mm (3.9 x 7.5 in.)	✓	X	X	X	X	X	X
9 Envelope 98 x 225 mm (3.9 x 8.9 in.)	✓	X	X	X	X	X	X
10 Envelope 105 x 241 mm (4.1 x 9.5 in.)	✓	X	X	X	X	X	X
DL Envelope 110 x 220 mm (4.3 x 8.7 in.)	✓	X	X	X	X	X	X
C5 Envelope 162 x 229 mm (6.4 x 9 in.)	✓	X	X	X	X	X	X

Paper size	Output expander or high-capacity output expander	4-bin mailbox	Staple finisher		Staple, hole punch finisher		
			Stack	Staple	Stack	Staple	Hole punch
B5 Envelope 176 x 250 mm (6.9 x 9.8 in.)	✓	X	X	X	X	X	X
Other Envelopes 98.4 x 162 mm (3.9 x 6.4 in.) to 176 x 250 mm (6.9 x 9.8 in.)	✓	X	X	X	X	X	X

Supported paper types

Paper types supported by the printer

Paper type	Standard 550-sheet tray, optional 250- or 550-sheet tray	Optional 2100-sheet tray	Multipurpose feeder	Two-sided printing
Plain paper	✓	✓	✓	✓
Card stock	✓	X	✓	✓
Transparency ¹	✓	X	✓	X
Labels	✓	X	✓	X
Vinyl labels ²	✓	X	✓	X
Bond	✓	✓	✓	✓
Envelope	✓	X	✓	X
Rough envelope	✓	X	✓	X
Letterhead	✓	✓	✓	✓
Preprinted	✓	✓	✓	✓
Colored paper	✓	X	✓	✓

¹ To prevent transparencies from sticking together, print up to 20 pages only. Print the succeeding pages after three minutes.

² Supported only in the Lexmark MS725 printer model.

Paper type	Standard 550-sheet tray, optional 250- or 550-sheet tray	Optional 2100-sheet tray	Multipurpose feeder	Two-sided printing
Light	✓	X	✓	✓
Heavy	✓	X	✓	✓
Rough/Cotton	✓	X	✓	✓
Custom type [x]	✓	X	✓	✓

¹ To prevent transparencies from sticking together, print up to 20 pages only. Print the succeeding pages after three minutes.

² Supported only in the Lexmark MS725 printer model.

Paper types supported by the output options or finishers

Paper type	Output expander or high-capacity output expander	4-bin mailbox	Staple finisher		Staple, hole punch finisher		
			Stack	Staple	Stack	Staple	Hole punch
Plain paper	✓	✓	✓	✓	✓	✓	✓
Card stock	✓	X	X	X	X	X	X
Transparencies	✓	X	✓	X	✓	X	X
Labels	✓	X	X	X	X	X	X
Vinyl labels	✓	X	X	X	X	X	X
Bond	✓	✓	✓	✓	✓	✓	✓
Envelope	✓	X	X	X	X	X	X
Rough envelope	✓	X	X	X	X	X	X
Letterhead	✓	✓	✓	✓	✓	✓	✓
Preprinted	✓	✓	✓	✓	✓	✓	✓
Colored paper	✓	X	X	X	X	X	X
Light	✓	X	X	X	X	X	X
Heavy	✓	X	X	X	X	X	X

Paper type	Output expander or high-capacity output expander	4-bin mailbox	Staple finisher		Staple, hole punch finisher		
			Stack	Staple	Stack	Staple	Hole punch
Rough/Cotton	✓	X	X	X	X	X	X
Custom type [x]	✓	X	X	X	X	X	X

Supported paper weights

Paper weights supported by the printer

Paper type and weight	Standard 550-sheet tray, optional 250- or 550-sheet tray	Optional 2100-sheet tray	Multipurpose feeder	Two-sided printing
Plain paper or Bond¹ 60–176 g/m ² grain long (16–47-lb bond)	✓	✓	✓	✓
Card stock 203 g/m ² grain long (125-lb bond)	✓	X	✓	✓
Card stock 199 g/m ² grain long (110-lb bond)	✓	X	✓	✓
Card stock 176 g/m ² grain long (65-lb bond)	✓	X	✓	✓
Transparency 138–146 g/m ² grain long (37–39-lb bond)	✓	X	✓	X
Paper labels 180 g/m ² (48-lb bond)	✓	X	✓	✓
Integrated forms² 140–175 g/m ² (37–47-lb bond)	✓	X	✓	✓

¹ Grain short is preferred for paper over 176 g/m² (47 lb).

² Pressure-sensitive area must enter the printer first.

³ 28-lb bond envelopes are limited to 25% cotton content.

Paper type and weight	Standard 550-sheet tray, optional 250- or 550-sheet tray	Optional 2100-sheet tray	Multipurpose feeder	Two-sided printing
Integrated forms 75–135 g/m ² (20–36-lb bond)	✓	X	✓	✓
Envelopes³ 60–105 g/m ² (16–28-lb bond)	✓	X	✓	✓

¹ Grain short is preferred for paper over 176 g/m² (47 lb).
² Pressure-sensitive area must enter the printer first.
³ 28-lb bond envelopes are limited to 25% cotton content.

Paper weights supported by the output options or finishers

Paper type and weight	Output expander or high-capacity output expander	4-bin mailbox	Staple finisher		Staple, hole punch finisher		
			Stack	Staple	Stack	Staple	Hole punch
Plain paper or Bond 60–176 g/m ² grain long (16–47-lb bond)	✓	X	✓	X	✓	X	X
Plain paper or Bond 60–90 g/m ² grain long (16–24-lb bond)	✓	✓	✓	✓	✓	✓	✓
Card stock 203 g/m ² grain long (125-lb bond)	✓	X	✓	X	✓	X	X
Card stock 199 g/m ² grain long (110-lb bond)	✓	X	✓	X	✓	X	X
Card stock 176 g/m ² grain long (65-lb bond)	✓	X	X	X	X	X	X

Paper type and weight	Output expander or high-capacity output expander	4-bin mailbox	Staple finisher		Staple, hole punch finisher		
			Stack	Staple	Stack	Staple	Hole punch
Card stock 163 g/m ² grain long (90-lb bond)	✓	X	✓	X	✓	X	X
Transparency 138–146 g/m ² grain long (37–39-lb bond)	✓	X	✓	X	✓	X	X
Paper labels 180 g/m ² (48-lb bond)	✓	X	X	X	X	X	X
Integrated forms 140–175 g/m ² (37–47-lb bond)	✓	X	X	X	X	X	X
Integrated forms 75–135 g/m ² (20–36-lb bond)	✓	X	X	X	X	X	X
Envelopes 60–105 g/m ² (16–28-lb bond)	✓	X	X	X	X	X	X

Printing

Printing from a computer

Note: For labels, card stock, and envelopes, set the paper size and type in the printer before printing the document.

- 1 From the document that you are trying to print, open the Print dialog.
- 2 If necessary, adjust the settings.
- 3 Print the document.

Printing from a mobile device

Printing from a mobile device using Lexmark Mobile Print

Lexmark™ Mobile Print allows you to send documents and images directly to a supported Lexmark printer.

- 1 Open the document, and then send or share the document to Lexmark Mobile Print.

Note: Some third-party applications may not support the send or share feature. For more information, see the documentation that came with the application.

- 2 Select a printer.
- 3 Print the document.

Printing from a mobile device using Google Cloud Print

Google Cloud Print™ is a printing service that allows you to print to any Google Cloud Print-ready printer.

Before you begin, make sure that:

- The printer is registered to the Google Cloud Print server.
- The Cloud Print plugin is downloaded from the Google Play™ store and is enabled in the mobile device.

- 1 From your Android™ mobile device, open a document or select a document from your file manager.

- 2 Tap  > **Print**.

- 3 Select a printer, and then tap .

Printing from a mobile device using Mopria Print Service

Mopria® Print Service is a mobile printing solution for mobile devices running on Android version 4.4 or later. It allows you to print directly to any Mopria-certified printer.

Note: Before printing, make sure that the Mopria Print Service is enabled.

- 1 From the home screen of your mobile device, launch a compatible application.
- 2 Tap **Print**, and then select the printer.
- 3 Send the print job.

Printing from a mobile device using AirPrint

AirPrint is a mobile printing solution that allows you to print directly from Apple devices to an AirPrint-certified printer.

Notes:

- This application is supported only in some Apple devices.
 - This application is supported only in some printer models.
- 1 From the home screen of your mobile device, launch a compatible application.
 - 2 Select an item to print, and then tap the share icon.
 - 3 Tap **Print**, and then select a printer.
 - 4 Print the document.

Printing from a flash drive

- 1 Insert the flash drive.



Notes:

- If you insert the flash drive when an error message appears, then the printer ignores the flash drive.
 - If you insert the flash drive while the printer is processing other print jobs, then **Busy** appears on the display.
- 2 From the display, touch the document that you want to print.
If necessary, configure other print settings.
 - 3 Send the print job.

To print another document, touch **USB Drive**.

Warning—Potential Damage: To avoid loss of data or printer malfunction, do not touch the flash drive or the printer in the area shown while actively printing, reading, or writing from the memory device.



Supported flash drives and file types

Flash drives

- Lexar JumpDrive S70 (16GB and 32GB)
- SanDisk Cruzer (16GB and 32GB)
- PNY Attache (16GB and 32GB)

Notes:

- The printer supports high-speed USB flash drives with full-speed standard.
- USB flash drives must support the File Allocation Table (FAT) system.

File types

Documents

- PDF (version 1.7 or earlier)
- HTML
- XPS
- Microsoft file formats (.doc, .docx, .xls, .xlsx, .ppt, .pptx)

Images

- .dcx
- .gif
- .JPEG or .jpg
- .bmp
- .pcx
- .TIFF or .tif
- .png

Configuring confidential jobs

- From the control panel, navigate to:
Settings > Security > Confidential Print Setup

For non-touch-screen printer models, press  to navigate through the settings.

- Configure the settings.

Use	To
Max Invalid PIN	Set the number of times an invalid PIN can be entered. Note: When the limit is reached, the print jobs for that user name are deleted.
Confidential Job Expiration	Set the expiration time for confidential print jobs. Note: Confidential held jobs are stored in the printer until they are released or deleted manually.
Repeat Job Expiration	Set the expiration time for a repeat print job. Note: Repeat held jobs are stored in the printer memory for reprinting.
Verify Job Expiration	Set the expiration time that the printer prints a copy before printing the remaining copies. Note: Verify jobs print one copy to check if it is satisfactory before printing the remaining copies.
Reserve Job Expiration	Set the expiration time that the printer stores print jobs. Note: Reserve held jobs are automatically deleted after printing.
Require All Jobs to be Held	Set the printer to hold all print jobs.

Printing confidential and other held jobs

For Windows users

- With a document open, click **File > Print**.
- Click **Properties, Preferences, Options, or Setup**.
- Click **Print and Hold**.
- Select **Use Print and Hold**, and then assign a user name.
- Select the print job type (Confidential, Repeat, Reserve, or Verify).
If the print job is confidential, then enter a four-digit PIN.
- Click **OK** or **Print**.

7 From the printer home screen, release the print job.

- For confidential print jobs, navigate to:
Held jobs > select your user name > **Confidential** > enter the PIN > select the print job > configure the settings > **Print**
- For other print jobs, navigate to:
Held jobs > select your user name > select the print job > configure the settings > **Print**

For Macintosh users

1 With a document open, choose **File** > **Print**.

If necessary, click the disclosure triangle to see more options.

2 From the print options or Copies & Pages menu, choose **Job Routing**.

3 Select the print job type (Confidential, Repeat, Reserve, or Verify).

If the print job is confidential, then assign a user name and a four-digit PIN.

4 Click **OK** or **Print**.

5 From the printer home screen, release the print job.

- For confidential print jobs, navigate to:
Held jobs > select your user name > **Confidential** > enter the PIN > select the print job > configure the settings > **Print**
- For other print jobs, navigate to:
Held jobs > select your user name > select the print job > configure the settings > **Print**

Printing from a Cloud Connector profile

1 From the home screen, touch **Cloud Connector**.

2 Select a cloud service provider, and then select a profile.

Note: For more information on creating a Cloud Connector profile, see [“Creating a Cloud Connector profile” on page 19](#).

3 Select a file.

Note: You cannot select an unsupported file.

4 If necessary, change the settings.

5 Touch **Print**.

Printing a font sample list

1 From the control panel, navigate to:

Settings > **Reports** > **Print** > **Print Fonts**

For non-touch-screen printer models, press  to navigate through the settings.

2 Select a font sample.

Printing a directory list

From the control panel, navigate to:

Settings > Reports > Print > Print Directory

For non-touch-screen printer models, press  to navigate through the settings.

Understanding the printer menus

Menu map

Device	<ul style="list-style-type: none"> • Preferences • Remote Operator Panel • Notifications • Power Management • Information Sent to Lexmark 	<ul style="list-style-type: none"> • Accessibility • Restore Factory Defaults • Maintenance • Visible Home Screen Icons • About this Printer
Print	<ul style="list-style-type: none"> • Layout • Setup • Quality • Job Accounting • XPS 	<ul style="list-style-type: none"> • PDF • PostScript • PCL • HTML • Image
Paper	<ul style="list-style-type: none"> • Tray Configuration 	<ul style="list-style-type: none"> • Media Configuration
Network/Ports	<ul style="list-style-type: none"> • Network Overview • Wireless • Ethernet • TCP/IP • SNMP • IPSec 	<ul style="list-style-type: none"> • 802.1x • LPD Configuration • HTTP/FTP Settings • ThinPrint • USB • Google Cloud Print
USB Drive	<ul style="list-style-type: none"> • Flash Drive Print 	
Security	<ul style="list-style-type: none"> • Login methods • Schedule USB Devices • Security Audit Log • Login Restrictions • Confidential Print Setup 	<ul style="list-style-type: none"> • Solutions LDAP Settings • Disk Encryption • Erase Temporary Data Files • Mobile Services Management • Miscellaneous
Reports	<ul style="list-style-type: none"> • Menu Settings Page • Device 	<ul style="list-style-type: none"> • Print • Network
Help	<ul style="list-style-type: none"> • Print All Guides • Connection Guide • Information Guide • Media Guide 	<ul style="list-style-type: none"> • Mono Quality Guide • Moving Guide • Print Quality Guide • Supplies Guide
Troubleshooting	<ul style="list-style-type: none"> • Print Quality Test Pages 	

Device

Preferences

Menu item	Description
Display Language [List of languages]	Set the language of the text that appears on the display.
Country/Region [List of countries or regions]	Identify the country or region where the printer is configured to operate.
Run initial setup Off* On	Run the setup wizard.
Keyboard Keyboard Type [List of languages]	Select a language as a keyboard type. Notes: <ul style="list-style-type: none"> All the Keyboard Type values may not appear or may require special hardware to appear. This menu item appears only in some printer models.
Displayed information Display Text 1 [IP Address*] Display Text 2 [Date/Time*] Custom Text 1 Custom Text 2	Specify the information to appear on the home screen. Note: Custom Text 1 and Custom Text 2 appear only in some printer models.
Date and Time Configure Current Date and Time Manually Set Date and Time Date Format [MM-DD-YYYY*] Time Format [12 hour A.M./P.M.*] Time Zone [GMT*]	Configure the printer date and time.
Date and Time Network Time Protocol Enable NTP [On*] NTP Server Enable Authentication	Configure the settings for Network Time Protocol (NTP). Notes: <ul style="list-style-type: none"> Enable Authentication appears only in some printer models. When Enable Authentication is set to MD5 key, Key ID and Password appear.
Paper Sizes U.S.* Metric	Specify the unit of measurement for paper sizes. Note: The country or region selected in the initial setup wizard determines the initial paper size setting.
Screen Brightness 20–100% (100*)	Adjust the brightness of the display. Note: This menu item appears only in some printer models.
Note: An asterisk (*) next to a value indicates the factory default setting.	

Menu item	Description
Flash Drive Access Enabled* Disabled	Enable access to the flash drive. Note: This menu item appears only in some printer models.
Audio Feedback Button Feedback On* Off	Enable audio feedback for button presses, panel interactions, paper loaded prompts, and error notifications. Note: This menu item appears only in some printer models.
Audio Feedback Volume 1–10 (5*)	Adjust the volume of the printer speakers. Notes: <ul style="list-style-type: none"> • Changes to the volume are applied after the current user session ends. • This menu item appears only in some printer models.
Screen Timeout 5–300 (60*)	Set the idle time in seconds before the display shows the home screen, or before the printer logs out a user account automatically.
Note: An asterisk (*) next to a value indicates the factory default setting.	

Remote Operator Panel

Menu item	Description
External VNC Connection Don't Allow* Allow	Connect an external Virtual Network Computing (VNC) client to the remote control panel.
Authentication Type None* Standard Authentication	Set the authentication type when accessing the VNC client server. Note: When set to Standard Authentication, VNC Password appears.
Note: An asterisk (*) next to a value indicates the factory default setting.	

Notifications

Menu item	Description
Error Lighting Off On*	Set the indicator light to come on when a printer error occurs.
Alarm Control Off Single* Continuous	Set the number of times that the alarm sounds when the printer requires user intervention.
Note: An asterisk (*) next to a value indicates the factory default setting.	

Menu item	Description
Supplies Show Supply Estimates Show estimates* Do not show estimates	Show the estimated status of the supplies.
Supplies Display Estimates Pages* Percent	Set the unit that the printer uses to estimate supply usage and trigger custom notifications when user intervention is required. Note: This menu item appears only in the Embedded Web Server.
Supplies Cartridge Alarm Off Single* Continuous	Set the number of times that the alarm sounds when the toner cartridge is low.
Supplies Custom Supply Notifications	Configure notification settings when the printer requires user intervention. Note: This menu item appears only in the Embedded Web Server.
E-mail Alerts Setup E-mail Setup Primary SMTP Gateway	Type the IP address or host name of the primary SMTP server for sending e-mail.
E-mail Alerts Setup E-mail Setup Primary SMTP Gateway Port 1–65535 (25*)	Enter the port number of the primary SMTP server.
E-mail Alerts Setup E-mail Setup Secondary SMTP Gateway	Type the server IP address or host name of your secondary or backup SMTP server. Note: This menu item appears only in some printer models.
E-mail Alerts Setup E-mail Setup Secondary SMTP Gateway Port 1–65535 (25*)	Enter the server port number of your secondary or backup SMTP server.
E-mail Alerts Setup E-mail Setup SMTP Timeout 5–30 seconds (30*)	Specify how long before the printer times out if the SMTP server does not respond.
E-mail Alerts Setup E-mail Setup Reply Address	Specify a reply address in the e-mail.
Note: An asterisk (*) next to a value indicates the factory default setting.	

Menu item	Description
<p>E-mail Alerts Setup E-mail Setup Always use SMTP default Reply Address Off* On</p>	<p>Use the SMTP default Reply Address.</p>
<p>E-mail Alerts Setup E-mail Setup Use SSL/TLS Disabled* Negotiate Required</p>	<p>Send an e-mail using an encrypted link.</p>
<p>E-mail Alerts Setup E-mail Setup Require Trusted Certificate On* Off</p>	<p>Require a trusted certificate when accessing the SMTP server.</p>
<p>E-mail Alerts Setup E-mail Setup SMTP Server Authentication No authentication required* Login / Plain NTLM CRAM-MD5 Digest-MD5 Kerberos 5</p>	<p>Set the authentication type for the SMTP server.</p>
<p>E-mail Alerts Setup E-mail Setup Device-Initiated E-mail None* Use Device SMTP Credentials</p>	<p>Set whether credentials are required for device-initiated e-mails.</p>
<p>E-mail Alerts Setup E-mail Setup User-Initiated E-mail None Use Device SMTP Credentials Use Session User ID and Password Use Session E-mail address and Password* Prompt user</p>	<p>Set whether credentials are required for user-initiated e-mails.</p>

Note: An asterisk (*) next to a value indicates the factory default setting.

Menu item	Description
E-mail Alerts Setup E-mail Setup Use Active Directory Device Credentials Off On*	Enable user credentials and group designations to connect to the SMTP server.
E-mail Alerts Setup E-mail Setup Device Userid	Specify the user ID to connect to the SMTP server.
E-mail Alerts Setup E-mail Setup Device Password	Specify the password to connect to the SMTP server.
E-mail Alerts Setup E-mail Setup Kerberos 5 REALM	Specify the realm for the Kerberos 5 authentication protocol.
E-mail Alerts Setup E-mail Setup NTLM Domain	Specify the domain name for the NTLM security protocol.
E-mail Alerts Setup E-mail Setup Disable "SMTP server not set up" error Off* No	Disable an SMTP setup error message to appear on the display.
Error Prevention Jam Assist Off On*	Set the printer to flush blank pages or pages with partial prints automatically after a jammed page has been cleared.
Error Prevention Auto Continue Off On* (5 seconds)	Let the printer continue processing or printing a job automatically after clearing certain printer conditions that require user intervention.
Error Prevention Auto Reboot Auto Reboot Reboot when idle Reboot always* Reboot never	Set the printer to restart when an error occurs.
Error Prevention Auto Reboot Max Auto Reboots 1–20 (2*)	Set the number of automatic reboots that the printer can perform.

Note: An asterisk (*) next to a value indicates the factory default setting.

Menu item	Description
Error Prevention Auto Reboot Auto Reboot Window 1–525600 (720*)	Set the number of seconds before the printer performs an automatic reboot.
Error Prevention Auto Reboot Auto Reboot Counter	Show a read-only information of the reboot counter.
Error Prevention Auto Reboot Reset Auto Reboot Counter Cancel Continue	Reset the Auto Reboot Counter.
Error Prevention Display Short Paper Error On Auto-clear*	Set the printer to show a message when a short paper error occurs. Note: Short paper refers to the size of the paper loaded.
Error Prevention Page Protect Off* On	Set the printer to process the entire page into the memory before printing it.
Jam Content Recovery Jam Recovery Off On Auto*	Set the printer to reprint jammed pages.
Note: An asterisk (*) next to a value indicates the factory default setting.	

Power Management

Menu item	Description
Sleep Mode Profile Print With Display Off Display on when printing Allow printing with display off*	Allow printing with the display turned off.
Timeouts Sleep Mode 1–120 minutes (15*)	Set the idle time before the printer begins operating in Sleep mode.
Note: An asterisk (*) next to a value indicates the factory default setting.	

Menu item	Description
Timeouts Hibernate Timeout Disabled 1 hour 2 hours 3 hours 6 hours 1 day 2 days 3 days* 1 week 2 weeks 1 month	Set the time before the printer enters Hibernate mode.
Timeouts Hibernate Timeout on Connection Hibernate Do Not Hibernate*	Set the printer to Hibernate mode even when an active Ethernet connection exists.
Eco-Mode Off* Energy Energy/Paper Paper	Minimize the use of energy, paper, or specialty media. Note: Setting Eco-Mode to Energy or Paper may affect printer performance, but not print quality.
Schedule Power Modes Schedules	Schedule the printer when to enter Sleep or Hibernate mode. Note: This menu item appears only in some printer models.
Note: An asterisk (*) next to a value indicates the factory default setting.	

Information Sent to Lexmark

Menu item	Description
Information Sent to Lexmark Supplies and Page Usage (Anonymous) Device Performance (Anonymous) None of the Above	Send printer usage and performance information to Lexmark. Note: Information Send Time and User Information - Level appear only when you select any of the settings in Information Sent to Lexmark, except None of the Above.
Information Send Time Start Time Stop Time	
User Information - Level Anonymous Session Information Only* Session Information with Generic User Information Session Information with Actual User IDs	

Accessibility

Note: This menu appears only in some printer models.

Menu item	Description
Duplicate Key Strike Interval 0–5 (0*)	Set the interval in seconds during which the printer ignores duplicate key presses on an attached keyboard.
Key Repeat Initial Delay 0.25–5 (1*)	Set the initial length of delay in seconds before a repeating key starts repeating. Note: This menu item appears only when a keyboard is attached to the printer.
Key Repeat Rate 0.5–30 (30*)	Set the number of presses per second for a repeating key. Note: This menu item appears only when a keyboard is attached to the printer.
Prolong Screen Timeout Off* On	Let the user remain in the same location and reset the Screen Timeout timer when it expires instead of returning to the home screen.
Headphone Volume 1–10 (5*)	Adjust the headphone volume. Note: This menu item appears only when a headphone is attached to the printer.
Enable Voice Guidance When Headphone Is Attached Off* On	Enable Voice Guidance when a headphone is attached to the printer.
Note: An asterisk (*) next to a value indicates the factory default setting.	

Menu item	Description
Speak Passwords/PINs Off* On	Set the printer to read out loud passwords or personal identification numbers. Note: This menu item appears only when a headphone or a speaker is attached to the printer.
Speech Rate Very Slow Slow Normal* Fast Faster Very Fast Rapid Very Rapid Fastest	Set the Voice Guidance speech rate. Note: This menu item appears only when a headphone or a speaker is attached to the printer.
Note: An asterisk (*) next to a value indicates the factory default setting.	

Restore Factory Defaults

Menu item	Description
Restore Settings Restore all settings Restore printer settings Restore network settings Restore app settings	Restore the printer factory default settings. Note: Restore app settings appears only in some printer models.

Maintenance

Configuration Menu

Menu item	Description
USB Configuration USB PnP 1* 2	Change the USB driver mode of the printer to improve its compatibility with a personal computer.
USB Configuration USB Speed Full Auto*	Set the USB port to run at full speed and disable its high-speed capabilities.
Note: An asterisk (*) next to a value indicates the factory default setting.	

Menu item	Description
Tray Configuration Size Sensing Tray [x] Sensing Off On*	Set the printer to detect the size of the paper loaded in the tray.
Tray Configuration Tray Linking Automatic* Off	Set the printer to link the trays that have the same paper type and paper size settings.
Tray Configuration Show Tray Insert Message Off Only for unknown sizes* Always	Set the printer to show the Tray Insert message.
Tray Configuration A5 Loading Short Edge Long Edge*	Specify the page orientation when loading for A5 paper size.
Tray Configuration Paper Prompts Auto* Multipurpose Feeder Manual Paper	Set the paper source that the user fills when a prompt to load paper appears. Note: For Multipurpose Feeder to appear, set Configure MP to Cassette from the Paper menu.
Tray Configuration Envelope Prompts Auto* Multipurpose Feeder Manual Envelope	Set the paper source that the user fills when a prompt to load envelope appears. Note: For Multipurpose Feeder to appear, set Configure MP to Cassette from the Paper menu.
Tray Configuration Action for Prompts Prompt user* Continue Use current	Set the printer to resolve paper- or envelope-related change prompts.
Reports Menu Settings Page Event Log Event Log Summary HealthCheck Statistics	Print reports about printer menu settings, printer events, and event logs.
Supply Usage And Counters Clear Supply Usage History	Clear the supply page counter or view the total printed pages.
Note: An asterisk (*) next to a value indicates the factory default setting.	

Menu item	Description
Printer Emulations PPDS Emulation Off* On	Set the printer to recognize and use the PPDS data stream.
Print Configuration Font Sharpening 0–150 (24*)	Set a text point-size value below which the high-frequency screens are used when printing font data. For example, if the value is 24, then all fonts sized 24 points or less use the high-frequency screens.
Print Configuration Print Density Disabled 1–5 (3*)	Adjust the toner density when printing or copying documents.
Print Configuration A4 Fuser Compress* Clip	Select the fuser to use.
Device Operations Quiet Mode Off* On	Set the printer to operate in Quiet Mode. Note: Enabling this setting slows down the printer performance.
Device Operations Panel Menus Off On*	Enable access to the control panel menus.
Device Operations Minimum Copy Memory 80MB* 100MB	Set the memory allocation for storing copy jobs. Notes: <ul style="list-style-type: none"> • The values appear only if the amount of installed DRAM is at least twice the amount of the value. • This menu item appears only in some printer models.
Device Operations Safe Mode Off* On	Set the printer to operate in a special mode, in which it attempts to continue offering as much functionality as possible, despite known issues. For example, when set to On, and the duplex motor is nonfunctional, the printer performs one-sided printing of the documents even if the job is two-sided printing.
Device Operations Clear Custom Status	Erase user-defined strings for the Default or Alternate custom messages.
Device Operations Clear all remotely-installed messages	Erase messages that were remotely installed.
Note: An asterisk (*) next to a value indicates the factory default setting.	

Menu item	Description
Device Operations Automatically Display Error Screens Off On*	Show existing error messages on the display after the printer remains inactive on the home screen for a length of time equal to the Screen Timeout setting.
Device Operations Enable Optional Parallel Port Off* On	Enable an optional parallel port. Note: When set to On, the printer restarts.
App Configuration LES Applications Off On*	Enable the Lexmark Embedded Solutions (LES) applications. Notes: <ul style="list-style-type: none"> • When set to On, this setting does not affect built-in applications. • This menu item appears only in some printer models.
Note: An asterisk (*) next to a value indicates the factory default setting.	

Out of Service Erase

Menu item	Description
Out of Service Erase Memory Last Sanitized Hard Disk Last Sanitized	Show information on when the printer memory or hard disk was last sanitized. Note: Hard Disk Last Sanitized appears only in printers with a hard disk installed.
Out of Service Erase Sanitize all information on nonvolatile memory Erase all printer and network settings Erase all apps and app settings Sanitize all information on hard disk	Clear all settings and applications that are stored in the printer memory or hard disk. Note: Sanitize all information on hard disk appears only in printers with a hard disk installed.

Visible Home Screen Icons

Note: This menu appears only in some printer models.

Menu	Description
Status/Supplies Job Queue Change Language Address Book Bookmarks Held Jobs USB App Profiles Display Customization Eco-Settings	Specify which icons to show on the home screen.

About this Printer

Menu item	Description
Asset Tag	Show the serial number of the printer.
Printer's Location	Identify the printer location. Maximum length is 63 characters.
Contact	Personalize the printer name. Maximum length is 63 characters.
Export Configuration File to USB	Export configuration files to a flash drive.
Export Compressed Logs to USB	Export compressed log files to a flash drive.

Print

Layout

Menu item	Description
Sides 1-sided* 2-sided	Specify whether to print on one side or two sides of the paper.
Flip Style Long Edge* Short Edge	Determine which side of the paper (long edge or short edge) is bound when performing two-sided printing. Note: Depending on the option selected, the printer automatically offsets each printed information of the page to bind the job correctly.
Blank Pages Print Do Not Print*	Print blank pages that are included in a print job.
Collate Off [1,1,1,2,2,2]* On [1,2,1,2,1,2]	Keep the pages of a print job stacked in sequence, particularly when printing multiple copies of the job.
Note: An asterisk (*) next to a value indicates the factory default setting.	

Menu item	Description
Separator Sheets None* Between Copies Between Jobs Between Pages	Insert blank separator sheets when printing.
Separator Sheet Source Tray [x] (1*) Multipurpose Feeder	Specify the paper source for the separator sheet.
Pages per Side Off* 2 pages per side 3 pages per side 4 pages per side 6 pages per side 9 pages per side 12 pages per side 16 pages per side	Print multiple page images on one side of a sheet of paper.
Pages per Side Ordering Horizontal* Reverse Horizontal Vertical Reverse Vertical	Specify the positioning of multiple page images when using Pages per Side. Note: The positioning depends on the number of page images and their page orientation.
Pages per Side Orientation Auto* Landscape Portrait	Specify the orientation of a multiple-page document when using Pages per Side.
Pages per Side Border None* Solid	Print a border around each page image when using Pages per Side.
Copies 1–9999 (1*)	Specify the number of copies for each print job.
Print Area Normal* Fit to page Whole Page	Set the printable area on a sheet of paper.
Note: An asterisk (*) next to a value indicates the factory default setting.	

Setup

Menu item	Description
Printer Language PCL Emulation* PS Emulation	Set the printer language. Note: Setting a printer language default does not prevent a software program from sending print jobs that use another printer language.
Job Waiting Off* On	Preserve print jobs requiring supplies so that jobs not requiring the missing supplies can print. Note: This menu item appears only when a printer hard disk is installed.
Job Hold Timeout 0–255 (30*)	Set the time in seconds that the printer waits for user intervention before it holds jobs that require unavailable resources and continues to print other jobs in the print queue. Note: This menu item appears only when a printer hard disk is installed.
Download Target RAM* Disk	Specify where to save all permanent resources, such as fonts and macros, that have been downloaded to the printer. Note: This menu item appears only when a printer hard disk is installed.
Resource Save Off* On	Determine what the printer does with downloaded resources, such as fonts and macros, when it receives a job that requires more than the available memory. Notes: <ul style="list-style-type: none"> • When set to Off, the printer retains downloaded resources only until memory is needed. Resources associated with the inactive printer language are deleted. • When set to On, the printer preserves all the permanent downloaded resources across all language switches. When necessary, the printer shows memory full messages instead of deleting permanent resources.
Print All Order Alphabetical* Newest First Oldest First	Specify the order in which held and confidential jobs are printed when Print All is selected. Note: This menu item appears only when a printer hard disk is installed.
Note: An asterisk (*) next to a value indicates the factory default setting.	

Quality

Menu item	Description
Print Resolution 300 dpi 600 dpi* 1200 dpi 1200 Image Q 2400 Image Q	Set the resolution for the text and images on the printed output. Note: Resolution is determined in dots per inch or image quality.
Note: An asterisk (*) next to a value indicates the factory default setting.	

Menu item	Description
Pixel Boost Off* Fonts Horizontally Vertically Both directions	Enable more pixels to print in clusters for clarity to enhance text and images.
Toner Darkness 1–10 (8*)	Determine the lightness or darkness of text images.
Halftone Normal* Detail	Enhance the printed output to have smoother lines with sharper edges.
Brightness -6 to 6 (0*)	Adjust the brightness of the printed output.
Contrast 0 to 5 (0*)	Adjust the contrast of the printed output.
Gray Correction Off Auto*	Adjust the contrast enhancement applied to images.
Note: An asterisk (*) next to a value indicates the factory default setting.	

Job Accounting

Note: This menu appears only when a printer hard disk is installed.

Menu item	Description
Job Accounting Off* On	Set the printer to create a log of the print jobs that it receives.
Accounting Log Frequency Daily Weekly Monthly*	Specify how often the printer creates a log file.
Log Action at End of Frequency None* E-mail Current Log E-mail & Delete Current Log Post Current Log Post & Delete Current Log	Specify how the printer responds when the frequency threshold expires. Note: The value defined in Accounting Log Frequency determines when this action is triggered.
Note: An asterisk (*) next to a value indicates the factory default setting.	

Menu item	Description
Log Near Full Level Off* On	Specify the maximum size of the log file before the printer executes the Log Action at Near Full.
Log Action at Near Full None* E-mail Current Log E-mail & Delete Current Log E-mail & Delete Oldest Log Post Current Log Post & Delete Current Log Post & Delete Oldest Log Delete Current Log Delete Oldest Log Delete All But Current Delete All Logs	Specify how the printer responds when the hard disk is nearly full. Note: The value defined in Log Near Full Level determines when this action is triggered.
Log Action at Full None* E-mail & Delete Current Log E-mail & Delete Oldest Log Post & Delete Current Log Post & Delete Oldest Log Delete Current Log Delete Oldest Log Delete All But Current Delete All Logs	Specify how the printer responds when disk usage reaches the maximum limit (100MB).
URL to Post Log	Specify where the printer posts job accounting logs.
E-mail Address to Send Logs	Specify the e-mail address to which the printer sends job accounting logs.
Log File Prefix	Specify the prefix for the log file name. Note: The current host name defined in the TCP/IP menu is used as the default log file prefix.
Note: An asterisk (*) next to a value indicates the factory default setting.	

XPS

Menu item	Description
Print Error Pages Off* On	Print a test page that contains information on errors, including XML markup errors.
Minimum Line Width 1–30 (2*)	Set the minimum stroke width of any job printed in 1200 dpi.
Note: An asterisk (*) next to a value indicates the factory default setting.	

PDF

Menu item	Description
Scale to Fit Off* On	Scale the page content to fit the selected paper size.
Annotations Print Do Not Print*	Specify whether to print annotations in the PDF.
Note: An asterisk (*) next to a value indicates the factory default setting.	

PostScript

Menu item	Description
Print PS Error Off* On	Print a page that contains the PostScript error. Note: When an error occurs, processing of the job stops, the printer prints an error message, and the rest of the print job is flushed.
Minimum Line Width 1-30 (2*)	Set the minimum stroke width. Note: Jobs printed in 1200 dpi use the value directly.
Lock PS Startup Mode Off* On	Disable the PostScript SysStart file.
Wait Timeout Off On* (40)	Set the printer to wait for more data before canceling a print job.
Note: An asterisk (*) next to a value indicates the factory default setting.	

PCL

Menu item	Description
Font Source Resident* Disk Flash All	Select the source which contains the default font selection. Notes: <ul style="list-style-type: none"> Flash and Disk appear only in some printer models. For Flash and Disk to appear, make sure that they are not read- or write-protected.
Font Name [List of available fonts] (Courier*)	Select a font from the specified font source.
Symbol Set [List of available symbol set] (10U PC-8*)	Specify the symbol set for each font name. Note: A symbol set is a set of alphabetic and numeric characters, punctuation, and special symbols. Symbol sets support the different languages or specific programs such as math symbols for scientific text.
Note: An asterisk (*) next to a value indicates the factory default setting.	

Menu item	Description
Pitch 0.08–100 (10*)	Specify the pitch for fixed or monospaced fonts. Note: Pitch refers to the number of fixed-space characters in a horizontal inch of type.
Orientation Portrait* Landscape	Specify the orientation of text and graphics on the page.
Lines per Page 1–255	Specify the number of lines of text for each page printed through the PCL® datastream. Notes: <ul style="list-style-type: none"> This menu item activates vertical escapement that causes the selected number of requested lines to print between the default margins of the page. 60 is the U.S. factory default setting. 64 is the international factory default setting.
PCL5 Minimum Line Width 1–30 (2*)	Set the initial minimum stroke width. Note: Jobs printed in 1200 dpi use the value directly.
PCLXL Minimum Line Width 1–30 (2*)	
A4 Width 198 mm* 203 mm	Set the width of the logical page on A4-size paper. Note: Logical page is the space on the physical page where data is printed.
Auto CR after LF Off* On	Set the printer to perform a carriage return after a line feed control command. Note: Carriage return is a mechanism that commands the printer to move the position of the cursor to the first position on the same line.
Auto LF after CR Off* On	Set the printer to perform a line feed after a carriage return control command.
Tray Renumber Assign MP Feeder Assign Tray [x] Assign Manual Paper Assign Manual Envelope	Configure the printer to work with a different print driver or custom application that uses a different set of source assignments to request a given paper source. Choose from the following options: <ul style="list-style-type: none"> 0–199—A numeric value to assign a custom value to a paper source. 200—The printer uses the factory default paper source assignments. 201—The paper source ignores the Select Paper Feed command.
Tray Renumber View Factory Defaults	Show the factory default value assigned for each paper source.
Tray Renumber Restore Defaults	Restore the tray renumber values to their factory defaults.
Note: An asterisk (*) next to a value indicates the factory default setting.	

Menu item	Description
Print Timeout Off On* (90)	Set the printer to end a print job after it has been idle for the specified amount of time in seconds.
Note: An asterisk (*) next to a value indicates the factory default setting.	

HTML

Menu item	Description
Font Name [List of fonts] (Times*)	Set the font to use for HTML documents.
Font Size 1–255 (12*)	Set the font size to use for HTML documents.
Scale 1–400% (100*)	Scale HTML documents.
Orientation Portrait* Landscape	Set the page orientation for HTML documents.
Margin Size 8–255 mm (19*)	Set the page margin for HTML documents.
Backgrounds Do Not Print Print*	Print background information or graphics for HTML documents.
Note: An asterisk (*) next to a value indicates the factory default setting.	

Image

Menu item	Description
Auto Fit On Off*	Select the best available paper size and orientation setting for an image. Note: When set to On, this menu item overrides the scaling and orientation settings for the image.
Invert Off* On	Invert bitonal monochrome images. Note: This menu item does not apply to GIF or JPEG image formats.
Scaling Anchor Top Left Best Fit* Anchor Center Fit Height/Width Fit Height Fit Width	Adjust the image to fit the printable area. Note: When Auto Fit is set to On, Scaling is automatically set to Best Fit.
Note: An asterisk (*) next to a value indicates the factory default setting.	

Menu item	Description
Orientation Portrait* Landscape Reverse Portrait Reverse Landscape	Specify the orientation of text and graphics on the page.
Note: An asterisk (*) next to a value indicates the factory default setting.	

Paper

Tray Configuration

Menu item	Description
Default Source Tray [x] (1*) Multipurpose Feeder Manual Paper Manual Envelope	Set the paper source for all print jobs. Note: Multipurpose Feeder only appears when Configure MP is set to Cassette.
Paper Size/Type Tray [x] Multipurpose Feeder Manual Paper Manual Envelope	Specify the paper size or paper type loaded in each paper source.
Substitute Size Off Letter/A4 All Listed*	Set the printer to substitute a specified paper size if the requested size is not loaded in any paper source. Notes: <ul style="list-style-type: none"> • Off prompts the user to load the required paper size. • Letter/A4 prints A4-size document on letter when loading letter and letter-size jobs on A4 paper size when loading letter. • All Listed substitutes Letter/A4.
Configure MP Cassette* Manual First	Set the printer when to pick paper loaded in the multipurpose feeder. Notes: <ul style="list-style-type: none"> • When set to Cassette, the printer treats the multipurpose feeder like a tray. • When set to Manual, the printer treats the multipurpose feeder like a manual feeder. • When set to First, the printer picks paper from the multipurpose feeder until it is empty, regardless of the required paper source or paper size.
Note: An asterisk (*) next to a value indicates the factory default setting.	

Media Configuration

Universal Setup

Menu item	Description
Units of Measure Inches Millimeters	Specify the unit of measurement for the universal paper. Note: Inches is the U.S. factory default setting. Millimeters is the international factory default setting.
Portrait Width 3–14.17 inches (8.50*) 76–359.91 mm (216*)	Set the portrait width of the universal paper.
Portrait Height 3–14.17 inches (14*) 76–359.91 mm (356*)	Set the portrait height of the universal paper.
Feed Direction Short Edge* Long Edge	Set the printer to pick paper from the short edge or long edge direction. Note: Long Edge appears only when the longest edge is shorter than the maximum width supported.
Note: An asterisk (*) next to a value indicates the factory default setting.	

Media Types

Menu item	Description
Plain Card Stock Transparency Recycled Labels Vinyl Labels Bond Envelope Rough Envelope Letterhead Preprinted Colored Paper Light Heavy Rough/Cotton Custom Type [x]	Specify the texture, weight, and orientation of the paper loaded.

USB Drive

Flash Drive Print

Menu item	Description
Number of Copies 1–9999 (1*)	Set the number of copies.
Paper Source Tray [x] (1*) Multipurpose Feeder Manual Paper Manual Envelope	Set the paper source for the print job.
Collate (1,1)(2,2) (1,2,3)(1,2,3)*	Print multiple copies in sequence.
Sides 1-Sided* 2-Sided	Specify whether to print on one side or two sides of the paper.
Flip Style Long Edge* Short Edge	Determine which side of the paper (long edge or short edge) is bound when performing two-sided printing. Note: Depending on the option selected, the printer automatically offsets each printed information of the page to bind the job correctly.
Pages per Side Off* [n] pages per side	Print multiple page images on one side of a sheet of paper.
Pages per Side Ordering Horizontal* Reverse Horizontal Reverse Vertical Vertical	Specify the positioning of multiple page images when using Pages per Side. Note: The positioning depends on the number of page images and their page orientation.
Pages per Side Orientation Auto* Landscape Portrait	Specify the orientation of a multiple-page document when using Pages per Side.
Pages per Side Border None* Solid	Print a border around each page image when using Pages per Side.
Note: An asterisk (*) next to a value indicates the factory default setting.	

Menu item	Description
Separator Sheets Off* Between Copies Between Jobs Between Pages	Specify whether to insert blank separator sheets when printing.
Separator Sheet Source Tray [x] (1*) Multipurpose Feeder	Specify the paper source for the separator sheet. Note: For Multipurpose Feeder to appear, set Configure MP to Cassette from the Paper menu.
Blank Pages Do Not Print* Print	Specify whether to print blank pages in a print job.
Note: An asterisk (*) next to a value indicates the factory default setting.	

Network/Ports

Network Overview

Menu item	Description
Active Adapter Auto* Standard Network Wireless	Specify how a network is connected. Note: Wireless appears only when a wireless network adapter is installed.
Network Status	Show the connection status of the printer network.
Display Network Status on Printer On* Off	Show the network status on the display.
Speed, Duplex	Show the speed of the currently active network card.
IPv4	Show the IPv4 address.
All IPv6 Addresses	Show all IPv6 addresses.
Reset Print Server	Reset all active network connections to the printer. Note: This setting removes all network configuration settings.
Network Job Timeout Off On* (90 seconds)	Set the time before the printer cancels a network print job.
Banner Page Off* On	Print a banner page.
Note: An asterisk (*) next to a value indicates the factory default setting.	

Wireless

Note: This menu is available only in printers connected to a Wi-Fi network or printers that have a wireless network adapter.

Menu item	Description
Setup Using Mobile App	Configure the Wi-Fi connection using Lexmark Mobile Assistant.
Setup On Printer Panel Choose Network Add Wi-Fi Network Network Name Network Mode Infrastructure Wireless Security Mode Disabled* WEP WPA2/WPA - Personal WPA2 - Personal 802.1x - RADIUS	Configure the Wi-Fi connection using the control panel. Note: 802.1x - RADIUS can be configured only from the Embedded Web Server.
Wi-Fi Protected Setup Start Push Button Method Start PIN Method	Establish a Wi-Fi network and enable network security. Notes: <ul style="list-style-type: none"> • Start Push-Button Method connects the printer to a Wi-Fi network when buttons on both the printer and the access point (wireless router) are pressed within a given time. • Start PIN Method connects the printer to a Wi-Fi network when a PIN on the printer is entered into the wireless settings of the access point.
Network Mode BSS Type Infrastructure*	Set the network mode.
Enable Wi-Fi Direct On Off*	Enable Wi-Fi Direct-capable devices to connect directly to the printer.
Compatibility 802.11b/g/n (2.4GHz)* 802.11a/b/g/n/ac (2.4GHz/5GHz) 802.11a/n/ac (5GHz)	Specify the standard for the Wi-Fi network. Note: 802.11a/b/g/n/ac (2.4GHz/5GHz) and 802.11a/n/ac (5GHz) only appear when a Wi-Fi option is installed.
Wireless Security Mode Disabled* WEP WPA2/WPA-Personal WPA2-Personal 802.1x - RADIUS	Set the security mode for connecting the printer to Wi-Fi devices. Note: 802.1x - RADIUS can be configured only from the Embedded Web Server.

Menu item	Description
WEP Authentication Mode Auto* Open Shared	Set the type of Wireless Encryption Protocol (WEP) for the printer. Note: This menu item appears only when the Wireless Security Mode is set to WEP.
Set WEP Key	Specify a WEP password for secure Wi-Fi connection.
WPA2/WPA Personal AES	Enable Wi-Fi security through Wi-Fi Protected Access (WPA). Note: This menu item appears only when the Wireless Security Mode is set to WPA2/WPA-Personal.
Set Pre-Shared Key	Set the password for secure Wi-Fi connection.
WPA2-Personal AES	Enable Wi-Fi security through WPA2. Note: This menu item appears only when the Wireless Security Mode is set to WPA2-Personal.
802.1x Encryption Mode WPA+ WPA2*	Enable Wi-Fi security through 802.1x standard. Notes: <ul style="list-style-type: none"> • This menu item appears only when the Wireless Security Mode is set to 802.1x - RADIUS. • 802.1x - RADIUS can be configured only from the Embedded Web Server.
IPv4 Enable DHCP On* Off Set Static IP Address IP Address Netmask Gateway	Enable Dynamic Host Configuration Protocol (DHCP) and configure static IP address. Note: DHCP is a standard protocol that allows a server to distribute IP addressing and configuration information dynamically to clients.
IPv6 Enable IPv6 On* Off Enable DHCPv6 On Off* Stateless Address Autoconfiguration On* Off DNS Server Address Manually Assigned IPv6 Address Manually Assigned IPv6 Router Address Prefix All IPv6 Addresses All IPv6 Router Addresses	Enable and configure IPv6 settings in the printer.

Menu item	Description
Network Address UAA LAA	View the network addresses.
PCL SmartSwitch Off On*	Set the printer to switch automatically to PCL emulation when a print job requires it, regardless of the default printer language. Note: If PCL SmartSwitch is off, then the printer does not examine incoming data and uses the default printer language specified in the Setup menu.
PS SmartSwitch Off On*	Set the printer to switch automatically to PS emulation when a print job requires it, regardless of the default printer language. Note: If PS SmartSwitch is off, then the printer does not examine incoming data and uses the default printer language specified in the Setup menu.
Job Buffering On Off*	Temporarily store print jobs in the printer hard disk before printing. Note: This menu item appears only when a hard disk is installed.
Mac Binary PS Auto* On Off	Set the printer to process Macintosh binary PostScript print jobs. Notes: <ul style="list-style-type: none"> • On processes raw binary PostScript print jobs. • Off filters print jobs using the standard protocol.

Ethernet

Menu item	Description
Network Speed	Show the speed of an active network adapter.
IPv4 Enable DHCP On* Off	Enable Dynamic Host Configuration Protocol (DHCP). Note: DHCP is a standard protocol that allows a server to distribute IP addressing and configuration information to clients dynamically.
IPv4 Set Static IP Address IP Address Netmask Gateway	Set the static IP address of your printer.
IPv6 Enable IPv6 Off* On	Enable IPv6 in the printer.
Note: An asterisk (*) next to a value indicates the factory default setting.	

Menu item	Description
IPv6 Enable DHCPv6 Off* On	Enable DHCPv6 in the printer.
IPv6 Stateless Address Autoconfiguration Off On*	Set the network adapter to accept the automatic IPv6 address configuration entries provided by a router.
IPv6 DNS Server Address	Specify the DNS server address.
IPv6 Manually Assigned IPv6 Address	Assign the IPv6 address.
IPv6 Manually Assigned IPv6 Router	Assign the IPv6 address.
IPv6 Address Prefix 0–128 (64*)	Specify the address prefix.
IPv6 All IPv6 Addresses	Show all IPv6 addresses.
IPv6 All IPv6 Router Addresses	Show all IPv6 router addresses.
Network Address UAA LAA	Show the printer Media Access Control (MAC) addresses: Locally Administered Address (LAA) and Universally Administered Address (UAA). Note: You can change the printer LAA manually.
PCL SmartSwitch Off On*	Set the printer to switch automatically to PCL emulation when a print job requires it, regardless of the default printer language. Note: If PCL SmartSwitch is off, then the printer does not examine incoming data and uses the default printer language specified in the Setup menu.
PS SmartSwitch Off On*	Set the printer to switch automatically to PS emulation when a print job requires it, regardless of the default printer language. Note: If PS SmartSwitch is off, then the printer does not examine incoming data and uses the default printer language specified in the Setup menu.
Job Buffering Off On*	Temporarily store jobs on the printer hard disk before printing. Notes: <ul style="list-style-type: none"> • This menu item appears only when a hard disk is installed. • This menu item appears only in some printer models.
Note: An asterisk (*) next to a value indicates the factory default setting.	

Menu item	Description
Mac Binary PS Auto* On Off	Set the printer to process Macintosh binary PostScript print jobs. Notes: <ul style="list-style-type: none"> • On processes raw binary PostScript print jobs. • Off filters print jobs using the standard protocol.
Energy Efficient Ethernet Off On*	Reduce power consumption when the printer does not receive data from the Ethernet network.
Note: An asterisk (*) next to a value indicates the factory default setting.	

TCP/IP

Note: This menu appears only in network printers or printers attached to print servers.

Menu item	Description
Set Hostname	Set the current TCP/IP host name.
Domain Name	Set the domain name.
Allow DHCP/BOOTP to update NTP server Off On*	Allow the DHCP and BOOTP clients to update the NTP settings of the printer.
Zero Configuration Name	Specify a service name for the zero configuration network.
Enable Auto IP Off* On	Assign an IP address automatically.
DNS Server Address	Specify the current Domain Name System (DNS) server address.
Backup DNS Address	Specify the backup DNS server addresses.
Backup DNS Address 2	
Backup DNS Address 3	
Domain Search Order	Specify a list of domain names to locate the printer and its resources that reside in different domains on the network.
Enable DDNS Off* On	Update the Dynamic DNS settings.
Note: An asterisk (*) next to a value indicates the factory default setting.	

Menu item	Description
DDNS TTL 300-31536000 (3600*)	Specify the current DDNS settings.
Default TTL 5-254 (254*)	
DDNS Refresh Time 300-31536000 (604800*)	
Enable mDNS Off On*	Update multicast DNS settings.
WINS Address	Specify a server address for Windows Internet Name Service (WINS).
Enable BOOTP Off* On	Allow the BOOTP to assign a printer IP address.
Restricted Server List	Specify an IP address for the TCP connections. Notes: <ul style="list-style-type: none"> • Use a comma to separate each IP address. • You can add up to 50 IP addresses.
Restricted Server List Options Block All Ports* Block Printing Only Block Printing and HTTP Only	Specify how the IP addresses in the list can access the printer functionality.
MTU 256-1500 (1500*)	Specify a maximum transmission unit (MTU) parameter for the TCP connections.
Raw Print Port 1-65535 (9100*)	Specify a raw port number for printers connected on a network.
Outbound Traffic Maximum Speed Off* On	Enable the printer maximum transfer rate.
Enable SSLv2 Off* On	Enable the SSLv2 protocol.
Enable SSLv3 Off* On	Enable the SSLv3 protocol.
Enable TLSv1.0 Off On*	Enable the TLSv1.0 protocol.
Note: An asterisk (*) next to a value indicates the factory default setting.	

Menu item	Description
Enable TLSv1.1 Off On*	Enable the TLSv1.1 protocol.
SSL Cipher List	Specify the cipher algorithms to use for the SSL or the TLS connections.
Note: An asterisk (*) next to a value indicates the factory default setting.	

SNMP

Note: This menu appears only in network printers or printers that are attached to print servers.

Menu item	Description
SNMP Versions 1 and 2c Enabled Off On* Allow SNMP Set Off On* Enable PPM MIB Off On* SNMP Community	Configure Simple Network Management Protocol (SNMP) versions 1 and 2c to install print drivers and applications.
SNMP Version 3 Enabled Off On* Set Read/Write Credentials User Name Password Set Read-only Credentials User Name Password Authentication Hash MD5 SHA1* Minimum Authentication Level No Authentication, No Privacy Authentication, No Privacy Authentication, Privacy* Privacy Algorithm DES AES-128*	Configure SNMP version 3 to install and update the printer security.
Note: An asterisk (*) next to a value indicates the factory default setting.	

IPSec

Note: This menu appears only in network printers or printers that are attached to print servers.

Menu item	Description
Enable IPSec Off* On	Enable Internet Protocol Security (IPSec).
Base Configuration Default* Compatibility Secure	Set the IPSec base configuration. Note: This menu item appears only when Enable IPSec is set to On.
DH (Diffie-Hellman) Group Proposal modp2048 (14)* modp3072 (15) modp4096 (16) modp6144 (17)	Set the IPSec encryption. Note: This menu item appears only when Base Configuration is set to Compatibility.
Proposed Encryption Method 3DES AES*	Specify the encryption and authentication methods to connect to a network securely. Note: These menu items appear only when Base Configuration is set to Compatibility.
Proposed Authentication Method SHA1 SHA256* SHA512	
IKE SA Lifetime (Hours) 1 2 4 8 24*	Set the amount of time before a new authentication key is generated. Note: These menu items appear only when Base Configuration is set to Secure.
IPSec SA Lifetime (Hours) 1 2 4 8* 24	
IPSec Device Certificate	Specify an IPSec certificate. Note: This menu item appears only when Enable IPSec is set to On.
Note: An asterisk (*) next to a value indicates the factory default setting.	

Menu item	Description
Pre-Shared Key Authenticated Connections Host [x] Address Key	Configure the authenticated connections of the printer. Note: These menu items appear only when Enable IPsec is set to On.
Certificate Authenticated Connections Host [x] Address[/subnet] Address[/subnet]	
Note: An asterisk (*) next to a value indicates the factory default setting.	

802.1x

Note: This menu appears only in network printers or printers that are attached to print servers.

Menu item	Description
Active Off* On	Let the printer join networks that require authentication before allowing access. Note: To configure the settings of this menu item, access the Embedded Web Server.
Note: An asterisk (*) next to a value indicates the factory default setting.	

LPD Configuration

Note: This menu appears only in network printers or printers that are attached to print servers.

Menu item	Description
LPD Timeout 0–65535 seconds (90*)	Set the time-out value to stop the Line Printer Daemon (LPD) server from waiting indefinitely for hung or invalid print jobs.
LPD Banner Page Off* On	Print a banner page for all LPD print jobs. Note: A banner page is the first page of a print job used as a separator of print jobs and to identify the originator of the print job request.
LPD Trailer Page Off* On	Print a trailer page for all LPD print jobs. Note: A trailer page is the last page of a print job.
LPD Carriage Return Conversion Off* On	Enable carriage return conversion. Note: Carriage return is a mechanism that commands the printer to move the position of the cursor to the first position on the same line.
Note: An asterisk (*) next to a value indicates the factory default setting.	

HTTP/FTP Settings

Note: This menu appears only in network printers or printers attached to print servers.

Menu item	Description
Enable HTTP Server Off On*	Access the Embedded Web Server to monitor and manage the printer.
Enable HTTPS Off On*	Configure the Hypertext Transfer Protocol Secure (HTTPS) settings.
Force HTTPS Connections Off* On	Force the printer to use the HTTPS connections.
Enable FTP/TFTP Off On*	Send files using FTP.
Local Domains	Specify domain names for HTTP and FTP servers. Note: This menu item appears only in some printer models.
HTTP Proxy IP Address	Configure the HTTP and FTP server settings. Note: These menu items appear only in some printer models.
FTP Proxy IP Address	
HTTP Default IP Port 1–65535 (80*)	
HTTPS Device Certificate	
FTP Default IP Port 1–65535 (21*)	
Timeout for HTTP/FTP Requests 1–299 (30*)	Specify the amount of time before the server connection stops.
Retries for HTTP/FTP Requests 1–299 (3*)	Set the number of retries to connect to the HTTP/FTP server.
Note: An asterisk (*) next to a value indicates the factory default setting.	

ThinPrint

Menu item	Description
Enable ThinPrint Off On*	Print using ThinPrint.
Port Number 4000–4999 (4000*)	Set the port number for the ThinPrint server.
Note: An asterisk (*) next to a value indicates the factory default setting.	

Menu item	Description
Bandwidth (bits/sec) 100–1000000 (0*)	Set the speed to transmit data in a ThinPrint environment.
Packet Size (kbytes) 0–64000 (0*)	Set the packet size for data transmission.
Note: An asterisk (*) next to a value indicates the factory default setting.	

USB

Note: This menu appears only in some printer models.

Menu item	Description
PCL SmartSwitch Off On*	Set the printer to switch to PCL emulation when a print job received through a USB port requires it, regardless of the default printer language. Note: If PCL SmartSwitch is off, then the printer does not examine incoming data and uses the default printer language specified in the Setup menu.
PS SmartSwitch Off On*	Set the printer to switch to PS emulation when a print job received through a USB port requires it, regardless of the default printer language. Note: If PS SmartSwitch is off, then the printer does not examine incoming data and uses the default printer language specified in the Setup menu.
Job Buffering Off* On	Temporarily store jobs on the printer hard disk before printing. Note: This menu item appears only when a hard disk installed.
Mac Binary PS On Auto* Off	Set the printer to process Macintosh binary PostScript print jobs. Notes: <ul style="list-style-type: none"> • When set to On, the printer processes raw binary PostScript print jobs from computers using the Macintosh operating system. • When set to Auto, the printer processes print jobs from computers using either Windows or Macintosh operating systems • When set to Off, the printer filters PostScript print jobs using the standard protocol.
Enable USB Port Off On*	Enable the standard USB port.
Note: An asterisk (*) next to a value indicates the factory default setting.	

Google Cloud Print

Menu item	Description
Registration Register	Register the printer to the Google Cloud Print server.
Note: An asterisk (*) next to a value indicates the factory default setting.	

Menu item	Description
Options Enable Google Cloud Print Off On*	Print directly from your Google account.
Options Enable Local Discovery Off On*	Allow the registered user and other users on the same subnet to send jobs to the printer locally.
Options Enable SSL Peer Verification Off On*	Verify authenticity of the peer certificate to connect to your Google account.
Options Always Print As Image Off* On	Set the printer to process PDF files as an image for faster printing.
Note: An asterisk (*) next to a value indicates the factory default setting.	

Wi-Fi Direct

Note: This menu appears only when a direct Wi-Fi network is the active network.

Menu item	Description
SSID	Specify the service set identifier (SSID) of the Wi-Fi network.
Set Preshared Key	Set the preshared key (PSK) to authenticate and validate users on a Wi-Fi connection.
Show PSK on Setup Page Off On*	Show the PSK on the Network Setup Page.
Group Owner IP Address	Specify the IP address of the group owner.
Auto-Accept Push Button Requests Off* On	Accept requests to connect to the network automatically. Note: Accepting clients automatically is not secured.
Note: An asterisk (*) next to a value indicates the factory default setting.	

Security

Login Methods

Manage Permissions

Menu item	Description
Function Access Modify Address Book Create Profiles Manage Bookmarks Flash Drive Print Held Jobs Access User Profiles Cancel Jobs at the Device Change Language Internet Printing Protocol (IPP) B/W Print	Control access to the printer functions.
Administrative Menus Security Menu Network/Ports Menu Paper Menu Reports Menu Function Configuration Menus Supplies Menu Option Card Menu SE Menu Device Menu	Control access to the printer menus.
Device Management Remote Management Firmware Updates Apps Configuration Operator Panel Lock Import / Export All Settings Out of Service Erase	Control access to the printer management options.
Apps New Apps Slideshow Change Wallpaper Screen Saver Eco-Settings	Control access to the printer applications. Note: The list may vary depending on the applications that are enabled from the Embedded Web Server.

Local Accounts

Menu item	Description
Manage Groups/Permissions Add Group Import Access Controls Function Access Administrative Menus Device Management Apps All Users Import Access Controls Function Access Administrative Menus Device Management Apps Admin	Control group or user access to the printer functions, applications, and security settings.
Add User User Name/Password User Name Password PIN	Create local accounts to manage access to the printer functions.
User Name/Password Accounts Add User	
User Name Accounts Add User	
Password Accounts Add User	
PIN Accounts Add User	

Default Login Methods

Note: This menu appears only when you configure the settings in the Local Accounts menu.

Menu item	Description
Control Panel User Name/Password User Name Password PIN	Specify the default login method to access the control panel.

Menu item	Description
Browser User Name/Password User Name Password PIN	Specify the default login method to access the browser.

Schedule USB Devices

Menu item	Description
Schedules Add New Schedule	Schedule access to the USB ports.

Security Audit Log

Menu item	Description
Enable Audit Off* On	Record the events in the secure audit log and remote syslog.
Enable Remote Syslog Off* On	Send audit logs to a remote server.
Remote Syslog Server	Specify the remote syslog server.
Remote Syslog Port 1–65535 (514*)	Specify the remote syslog port.
Remote Syslog Method Normal UDP* Stunnel	Specify a syslog method to transmit logged events to a remote server.

Note: An asterisk (*) next to a value indicates the factory default setting.

Menu item	Description
<p>Remote Syslog Facility</p> <ul style="list-style-type: none"> 0 - Kernel Messages 1 - User-Level Messages 2 - Mail System 3 - System Daemons 4 - Security/Authorization Messages* 5 - Messages Generated Internally by Syslogs 6 - Line Printer Subsystem 7 - Network News Subsystem 8 - UUCP Subsystem 9 - Clock Daemon 10 - Security/Authorization Messages 11 - FTP Daemon 12 - NTP Subsystem 13 - Log Audit 14 - Log Alert 15 - Clock Daemon 16 - Local Use 0 (local0) 17 - Local Use 1 (local1) 18 - Local Use 2 (local2) 19 - Local Use 3 (local3) 20 - Local Use 4 (local4) 21 - Local Use 5 (local5) 22 - Local Use 6 (local6) 23 - Local Use 7 (local7) 	<p>Specify a facility code that the printer uses when sending log events to a remote server.</p>
<p>Severity of Events to Log</p> <ul style="list-style-type: none"> 0 - Emergency 1 - Alert 2 - Critical 3 - Error 4 - Warning* 5 - Notice 6 - Informational 7 - Debug 	<p>Specify the priority level cutoff for logging messages and events.</p>
<p>Remote Syslog Non-Logged Events</p> <ul style="list-style-type: none"> Off* On 	<p>Send all events, regardless of severity level, to the remote server.</p>
<p>Admin's E-mail Address</p>	<p>Send e-mail notification of logged events to the administrator.</p>
<p>Note: An asterisk (*) next to a value indicates the factory default setting.</p>	

Menu item	Description
E-mail Log Cleared Alert Off* On	Send e-mail notification to the administrator when a log entry is deleted.
E-mail Log Wrapped Alert Off* On	Send e-mail notification to the administrator when the log becomes full and begins to overwrite the oldest entries.
Log Full Behavior Wrap Over Older Entries* E-mail Log Then Delete All Entries	Resolve log storage issues when the log fills its allotted memory.
E-mail % Full Alert Off* On	Send e-mail notification to the administrator when the log fills its allotted memory.
% Full Alert Level 1–99 (90*)	
E-mail Log Exported Alert Off* On	Send e-mail notification to the administrator when a log is exported.
E-mail Log Settings Changed Alert Off* On	Send e-mail notification to the administrator when Enable Audit is set.
Log Line Endings LF (\n)* CR (\r) CRLF (\r\n)	Specify how the log file terminates the end of each line.
Digitally Sign Exports Off* On	Add a digital signature to each exported log file.
Clear Log	Delete all audit logs.
Export Log Syslog (RFC 5424) Syslog (RFC 3164) CSV	Export a security log to a flash drive.
Note: An asterisk (*) next to a value indicates the factory default setting.	

Login Restrictions

Menu item	Description
Login failures 1–10 (3*)	Specify the number of failed login attempts before the user gets locked out.
Failure time frame 1–60 minutes (5*)	Specify the time frame between failed login attempts before the user gets locked out.
Lockout time 1–60 minutes (5*)	Specify the lockout duration.
Web Login Timeout 1–120 minutes (10*)	Specify the delay for a remote login before the user is logged off automatically.
Note: An asterisk (*) next to a value indicates the factory default setting.	

Confidential Print Setup

Menu item	Description
Max Invalid PIN 2–10	Set the number of times an invalid PIN can be entered. Notes: <ul style="list-style-type: none"> • A value of zero turns off this setting. • When the limit is reached, the print jobs for that user name and PIN are deleted. • This menu item appears only when a hard disk is installed.
Confidential Job Expiration Off* 1 Hour 4 Hours 24 Hours 1 Week	Set the expiration time for confidential print jobs. Notes: <ul style="list-style-type: none"> • If this menu item is changed while confidential print jobs reside in the printer memory or hard disk, then the expiration time for those print jobs does not change to the new default value. • If the printer is turned off, then all confidential jobs held in the printer memory are deleted.
Repeat Job Expiration Off* 1 Hour 4 Hours 24 Hours 1 Week	Set the expiration time for a print job that you want to repeat.
Verify Job Expiration Off* 1 Hour 4 Hours 24 Hours 1 Week	Set the expiration time that the printer prints a copy for the user to examine its quality, before printing the remaining copies.
Note: An asterisk (*) next to a value indicates the factory default setting.	

Menu item	Description
Reserve Job Expiration Off* 1 Hour 4 Hours 24 Hours 1 Week	Set the expiration time that the printer stores print jobs for printing later.
Require All Jobs to be Held Off* On	Set the printer to hold all print jobs.
Keep duplicate documents Off* On	Set the printer to print other documents with the same file name without overwriting any of the print jobs.
Note: An asterisk (*) next to a value indicates the factory default setting.	

Erase Temporary Data Files

Menu item	Description
Stored in onboard memory Off* On	Delete all files stored on the printer memory.
Note: An asterisk (*) next to a value indicates the factory default setting.	

Solutions LDAP Settings

Use	To
Follow LDAP Referrals Off* On	Search the different servers in the domain for the logged-in user account.
LDAP Certificate Verification No* Yes	Enable verification of LDAP certificates.

Disk Encryption

Note: This menu appears only when a printer hard disk is installed.

Menu item	Description
Status Enabled Disabled	Determine whether Disk Encryption is enabled.

Menu item	Description
Start encryption	Prevent the loss of sensitive data in case the printer or its hard disk is stolen. Note: Enabling disk encryption erases all contents in the hard disk. If necessary, back up important data from the printer before starting the encryption.

Mobile Services Management

Use	To
AirPrint Print Off On*	Enable AirPrint printing.

Miscellaneous

Menu item	Description
Protected Features Show* Hide	Show all the features that Function Access Control (FAC) protects regardless of the security permission that the user has. Notes: <ul style="list-style-type: none"> FAC manages access to specific menus and functions or disables them entirely. This menu item appears only in some printer models.
Print Permission Off* On	Let the user log in before printing.
Default Print Permission Login User Name/Password* User Name Solutions LDAP	Set the default login for Print Permission.
Security Reset Jumper Enable "Guest" access* No Effect	Specify the effect of using the security reset jumper. Notes: <ul style="list-style-type: none"> The jumper is located beside a lock icon on the controller board. Enable "Guest" access provides full access control to users who are not logged in. No Effect means that the reset has no effect on the printer security configuration.
Minimum Password Length 0–32 (0*)	Specify the minimum characters that are allowed for a password.
Note: An asterisk (*) next to a value indicates the factory default setting.	

Reports

Menu Settings Page

Menu item	Description
Menu Settings Page	Print a report that contains the printer preferences, settings, and configurations.

Device

Menu item	Description
Device Information	Print a report that contains information about the printer.
Device Statistics	Print a report about printer usage and supply status.
Profile List	Print a list of profiles that are stored in the printer.
Asset Report	Print a report that contains the printer serial number and model name.

Print

Menu item	Description
Print Fonts PCL Fonts PS Fonts	Print samples and information about the fonts that are available in each printer language.
Print Directory	Print the resources that are stored in the flash drive or printer hard disk. Note: This menu item appears only when a flash drive or printer hard disk is installed.
Print Demo Demo Page	Print a page that shows the printer capabilities and supported solutions.

Network

Menu item	Description
Network Setup Page	Print a page that shows the configured network and wireless settings on the printer. Note: This menu item appears only in network printers or printers connected to print servers.

Help

Menu item	Description
Print All Guides	Prints all the guides
Media Guide	Provides information about loading paper and specialty media

Menu item	Description
Print Quality Guide	Provides information about solving print quality issues
Mono Quality Guide	Provides information about mono print quality settings
Information Guide	Provides more information sources about the printer
Connection Guide	Provides information about connecting the printer locally (USB) or to a network
Moving Guide	Provides information about moving, locating, or shipping the printer
Supplies Guide	Provides information about ordering supplies

Troubleshooting

Troubleshooting

Menu item	Description
Print Quality Test Pages	Print sample pages to identify and correct print quality defects.

Printing the Menu Settings Page

From the control panel, navigate to:

Settings > Reports > Menu Settings Page

For non-touch-screen printer models, press  to navigate through the settings.

Securing the printer

Note: The hard disk is supported only in some printer models.

Locating the security slot

The printer is equipped with a security lock feature. Attach a security lock compatible with most laptop computers in the location shown to secure the printer in place.

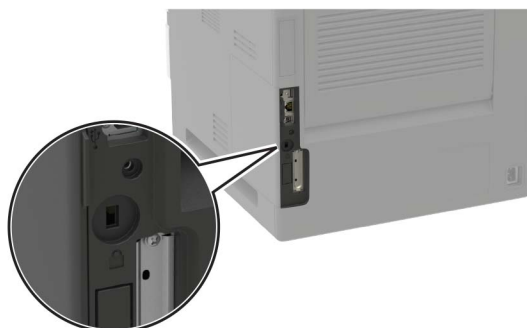

Erasing printer memory

To erase volatile memory or buffered data in your printer, turn off the printer.

To erase non-volatile memory or individual settings, device and network settings, security settings, and embedded solutions, do the following:

- 1 From the control panel, navigate to:
Settings > Device > Maintenance > Out of Service Erase > Sanitize all information on nonvolatile memory

For non-touch-screen printer models, press  to navigate through the settings.

- 2 Depending on your printer model, select **ERASE** or **Continue**.
- 3 Follow the instructions on the display.

Erasing printer hard disk memory

- 1 From the control panel, navigate to:
Settings > Device > Maintenance > Out of Service Erase > Sanitize all information on hard disk

For non-touch-screen printer models, press  to navigate through the settings.

- 2 Depending on your printer model, select **ERASE** or **Continue**.
- 3 Follow the instructions on the display.

Note: This process can take from several minutes to more than an hour, making the printer unavailable for other tasks.

Encrypting the printer hard disk

This process erases all contents in the hard disk. If necessary, back up important data from the printer before starting the encryption.

1 From the control panel, navigate to:

Settings > Security > Disk Encryption > Start encryption

For non-touch-screen printer models, press  to navigate through the settings.

2 Follow the instructions on the display.

Notes:

- To avoid loss of data, do not turn off the printer during the encryption process.
- This process can take from several minutes to more than an hour, making the printer unavailable for other tasks.
- After encryption, the printer automatically restarts.

Restoring factory default settings

1 From the control panel, navigate to:

Settings > Device > Restore Factory Defaults

For non-touch-screen printer models, press  to navigate through the settings.

2 In the Restore Settings menu, select the settings that you want to restore.

3 Select **RESTORE**.

4 Follow the instructions on the display.

Statement of Volatility

Type of memory	Description
Volatile memory	The printer uses standard random access memory (RAM) to buffer temporarily user data during simple print and copy jobs.
Non-volatile memory	The printer may use two forms of non-volatile memory: EEPROM and NAND (flash memory). Both types are used to store the operating system, printer settings, network information, scanner and bookmark settings, and embedded solutions.

Type of memory	Description
Hard disk memory	Some printers may have a hard disk drive installed. The printer hard disk is designed for printer-specific functionality. The hard disk lets the printer retain buffered user data from complex print jobs, form data, and font data.

Erase the content of any installed printer memory in the following circumstances:

- The printer is decommissioned.
- The printer hard disk is replaced.
- The printer is moved to a different department or location.
- The printer is serviced by someone from outside your organization.
- The printer is removed from your premises for service.
- The printer is sold to another organization.

Disposing of a printer hard disk

- **Degaussing**—Flushes the hard disk with a magnetic field that erases stored data
- **Crushing**—Physically compresses the hard disk to break component parts and render them unreadable
- **Milling**—Physically shreds the hard disk into small metal bits

Note: To guarantee that all data are completely erased, destroy physically each hard disk where data is stored.

Maintaining the printer

Warning—Potential Damage: Failure to maintain optimum printer performance, or to replace parts and supplies, may cause damage to your printer.

Adjusting the speaker volume

Adjusting the default internal speaker volume

- 1 From the control panel, navigate to:
Settings > Device > Preferences > Audio Feedback
- 2 Adjust the volume.

Notes:

- If Quiet Mode is enabled, then audible alerts are turned off. This setting also slows the printer performance.
- The volume resets to the default value after the session is logged out or when the printer wakes from Sleep or Hibernate mode.

Adjusting the default headphone volume

Note: The headphone jack is available only in some printer models.

- 1 From the control panel, navigate to:
Settings > Device > Accessibility
- 2 Adjust Headphone Volume.

Note: The volume resets to the default value after the session is logged out or when the printer wakes from Sleep or Hibernate mode.

Networking

Note: For information on installing the wireless network adapter, see the setup sheet that came with the adapter.

Connecting the printer to a Wi-Fi network

Using the control panel

- 1 From the home screen, navigate to:

Settings > Network/Ports > Wireless

For non-touch-screen printer models, press  to navigate through the settings.

- 2 Select **Setup On Printer Panel**, and then follow the instructions on the display.

Note: For Wi-Fi-network-ready printer models, a prompt for Wi-Fi network setup appears during initial setup.

Using Lexmark Mobile Assistant

- 1 Depending on your mobile device, download the Lexmark Mobile Assistant application from either the Google Play store or App Store online store.

- 2 From the control panel, navigate to:

Settings > Network/Ports > Wireless > Setup Using Mobile App > Continue for Printer ID

For non-touch-screen printer models, press  to navigate through the settings.

- 3 From your mobile device, launch the application, and then accept the Terms of Use.
- 4 Grant permissions.
- 5 Tap **Start Wi-Fi Setup**, and then select the printer.
- 6 Select a Wi-Fi network, and then enter your credentials.
- 7 Tap **Finish Wi-Fi Setup**.

Connecting the printer to a wireless network using Wi-Fi Protected Setup (WPS)

Before you begin, make sure that:

- The access point (wireless router) is WPS-certified or WPS-compatible. For more information, see the documentation that came with your access point.
- A wireless network adapter is installed in your printer. For more information, see the instructions that came with the adapter.

Using the Push Button method

- 1 From the control panel, navigate to:
Settings > Network/Ports > Wireless > Wi-Fi Protected Setup > Start Push Button Method
- 2 Follow the instructions on the display.

Using the personal identification number (PIN) method

- 1 From the control panel, navigate to:
Settings > Network/Ports > Wireless > Wi-Fi Protected Setup > Start PIN Method
- 2 Copy the eight-digit WPS PIN.
- 3 Open a Web browser, and then type the IP address of your access point in the address field.

Notes:

- View the printer IP address on the printer home screen. The IP address appears as four sets of numbers separated by periods, such as 123.123.123.123.
 - If you are using a proxy server, then temporarily disable it to load the Web page correctly.
- 4 Access the WPS settings. For more information, see the documentation that came with your access point.
 - 5 Enter the eight-digit PIN, and then save the changes.

Deactivating the Wi-Fi network

- 1 From the printer control panel, navigate to:
Settings > Network/Ports > Network Overview > Active Adapter > Standard Networking

For non-touch-screen printer models, press  to navigate through the settings.

- 2 Follow the instructions on the display.

Changing the printer port settings after installing an internal solutions port

Notes:

- If the printer has a static IP address, then do not change the configuration.
- If the computers are configured to use the network name instead of an IP address, then do not change the configuration.
- If you are adding a wireless internal solutions port (ISP) to a printer previously configured for an Ethernet connection, then disconnect the printer from the Ethernet network.

For Windows users

- 1 Open the printers folder.
- 2 From the shortcut menu of the printer with the new ISP, open the printer properties.
- 3 Configure the port from the list.

- 4 Update the IP address.
- 5 Apply the changes.

For Macintosh users

- 1 From System Preferences in the Apple menu, navigate to the list of printers, and then select + > **IP**.
- 2 Type the IP address in the address field.
- 3 Apply the changes.

Cleaning the printer

 **CAUTION—SHOCK HAZARD:** To avoid the risk of electrical shock when cleaning the exterior of the printer, unplug the power cord from the electrical outlet and disconnect all cables from the printer before proceeding.

Notes:

- Perform this task after every few months.
 - Damage to the printer caused by improper handling is not covered by the printer warranty.
- 1 Turn off the printer, and then unplug the power cord from the electrical outlet.
 - 2 Remove paper from the standard bin and multipurpose feeder.
 - 3 Remove any dust, lint, and pieces of paper around the printer using a soft brush or vacuum.
 - 4 Wipe the outside of the printer with a damp, soft, lint-free cloth.

Notes:

- Do not use household cleaners or detergents, as they may damage the finish of the printer.
 - Make sure that all areas of the printer are dry after cleaning.
- 5 Connect the power cord to the electrical outlet, and then turn on the printer.

 **CAUTION—POTENTIAL INJURY:** To avoid the risk of fire or electrical shock, connect the power cord to an appropriately rated and properly grounded electrical outlet that is near the product and easily accessible.

Ordering parts and supplies

To order parts and supplies in the U.S., contact Lexmark at 1-800-539-6275 for information about Lexmark authorized supplies dealers in your area. In other countries or regions, go to www.lexmark.com or contact the place where you purchased the printer.

Note: All life estimates for printer supplies assume printing on letter- or A4-size plain paper.

Checking the status of parts and supplies

1 From the control panel, navigate to:

Settings > Reports > Device > Device Statistics

For non-touch-screen printer models, press  to navigate through the settings.

2 From the Supply Information section of the pages printed, check the status of parts and supplies.

Using genuine Lexmark parts and supplies

Your Lexmark printer is designed to function best with genuine Lexmark parts and supplies. Use of third-party supplies or parts may affect the performance, reliability, or life of the printer and its imaging components. It can also affect warranty coverage. Damage caused by the use of third-party parts and supplies is not covered by the warranty. All life indicators are designed to function with Lexmark parts and supplies, and may deliver unpredictable results if third-party parts and supplies are used. Imaging component usage beyond the intended life may damage your Lexmark printer or its associated components.

Ordering a toner cartridge

Notes:

- The estimated cartridge yield is based on the ISO/IEC 19752 standard.
- Extremely low print coverage for extended periods of time may negatively affect actual yield.

Lexmark MS821, MS822, MS823, MS725, MS825, and MS826 Return Program toner cartridges

Item	United States and Canada	European Economic Area	Asia Pacific	Latin America	Rest of Europe, Middle East, and Africa	Australia and New Zealand	Worldwide
Return Program toner cartridge	58D1000	58D2000	58D3000	58D4000	58D5000	58D6000	58D000G

¹ Available only for contract-managed printers. For more information, contact your Lexmark representative or system administrator.

² Supported only in Lexmark MS725, MS823, MS825, and MS826 printer models.

Item	United States and Canada	European Economic Area	Asia Pacific	Latin America	Rest of Europe, Middle East, and Africa	Australia and New Zealand	Worldwide
High yield Return Program toner cartridge	58D1H00	58D2H00	58D3H00	58D4H00	58D5H00	58D6H00	58D0H0G
High yield Corporate Return Program toner cartridge ¹	58D1H0E	58D2H0E	58D3H0E	58D4H0E	58D5H0E	58D6H0E	N/A
Extra high yield Return Program toner cartridge ²	58D1X00	58D2X00	58D3X00	58D4X00	58D5X00	58D6X00	58D0X0G
Extra high yield Corporate Return Program toner cartridge ^{1,2}	58D1X0E	58D2X0E	58D3X0E	58D4X0E	58D5X0E	58D6X0E	N/A
Ultra high yield Return Program toner cartridge ²	58D1U00	58D2U00	58D3U00	58D4U00	58D5U00	58D6U00	58D0U0G
Ultra high yield Corporate Return Program toner cartridge ^{1,2}	58D1U0E	58D2U0E	58D3U0E	58D4U0E	58D5U0E	58D6U0E	N/A

¹ Available only for contract-managed printers. For more information, contact your Lexmark representative or system administrator.

² Supported only in Lexmark MS725, MS823, MS825, and MS826 printer models.

Lexmark M5255 and M5270 Return Program toner cartridges

Item	United States, Canada, Australia, and New Zealand	Europe, Middle East, and Africa	Asia Pacific	Latin America
Return Program toner cartridge	25B3074	25B3079	25B3120	25B3124

Lexmark B2865 Return Program toner cartridges

Item	United States and Canada	European Economic Area	Asia Pacific	Latin America	Rest of Europe, Middle East, and Africa	Australia and New Zealand
Return Program toner cartridge	B281000	B282000	B283000	B284000	B285000	B286000
High yield Return Program toner cartridge	B281H00	B282H00	B283H00	B284H00	B285H00	B286H00
Extra high yield Return Program toner cartridge	B281X00	B282X00	B283X00	B284X00	B285X00	B286X00

Regular toner cartridges

Item	Worldwide
High yield toner cartridge ¹	58D0HA0
Extra high yield toner cartridge ²	B280XA0
Ultra high yield toner cartridge ³	58D0UA0
¹ Supported only in Lexmark MS821 and MS822 printer models. ² Supported only in the Lexmark B2865 printer model. ³ Supported only in Lexmark MS725, MS823, MS825, and MS826 printer models.	

Ordering an imaging unit

Extremely low print coverage for extended periods of time may cause imaging unit parts to fail before the toner exhaustion.

Item	Lexmark Return Program	Corporate Return Program*	Regular
Imaging unit	58D0Z00	58D0Z0E	58D0ZA0

* This imaging unit is available only for contract-managed printers. For more information, contact your Lexmark representative or system administrator.

Ordering a staple cartridge

Part name	Part number
Staple cartridge	35S8500

Ordering a maintenance kit

To identify the fuser type, open door A, and then remove the toner cartridge and imaging unit. Find the two-digit fuser type in front of the fuser, for example, 00 or 01.

Warning—Potential Damage: Do not expose the imaging unit to direct light for more than 10 minutes. Extended exposure to light may cause print quality problems.

Notes:

- Using certain types of paper may require more frequent replacement of the maintenance kit.
- The separator assembly, fuser, pick roller assembly, and transfer roller are included in the maintenance kit and can be ordered individually and replaced if necessary.
- For more information on replacing the maintenance kit, see the documentation that came with the kit.

Return Program fuser maintenance kits

Fuser maintenance kit type	Part number
Type 00	41X2233
Type 01	41X2234
Type 02	41X2235
Type 03	41X2236
Type 04	41X2237
Type 11	41X2242
Type 13	41X2243
Type 32	41X2250
Type 33	41X2251
Type 35	41X2252
Type 36	41X2253

Regular fuser maintenance kits

Fuser maintenance kit type	Part number
Type 05	41X2238
Type 06	41X2239
Type 07	41X2240
Type 08	41X2241

Fuser maintenance kit type	Part number
Type 17	41X2244
Type 19	41X2245

Roller maintenance kit

Item	Part number
Printer engine roller maintenance kit	41X2352

Configuring supply notifications

- 1 Open a web browser, and then type the printer IP address in the address field.

Notes:

- View the printer IP address on the printer home screen. The IP address appears as four sets of numbers separated by periods, such as 123.123.123.123.
- If you are using a proxy server, then temporarily disable it to load the web page correctly.

- 2 Click **Settings** > **Device** > **Notifications**.
- 3 From the Supplies menu, click **Custom Supply Notifications**.
- 4 Select a notification for each supply item.
- 5 Apply the changes.

Replacing parts and supplies

Replacing the toner cartridge

- 1 Open door A.

Warning—Potential Damage: To prevent damage from electrostatic discharge, touch any exposed metal frame of the printer before accessing or touching interior areas of the printer.



- 2 Remove the used toner cartridge.

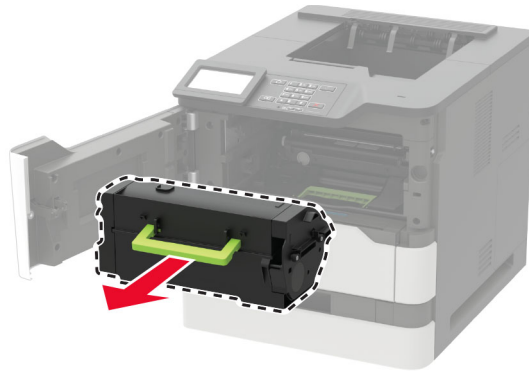

- 3 Unpack the new toner cartridge, and then shake it to redistribute the toner.

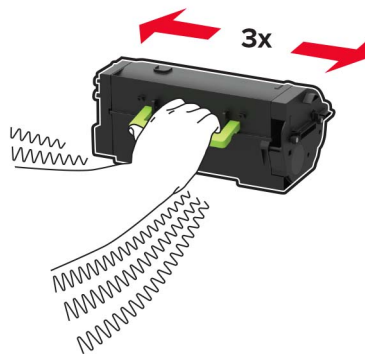

- 4 Insert the new toner cartridge.



- 5 Close the door.

Replacing the imaging unit

- 1 Open door A.

Warning—Potential Damage: To prevent damage from electrostatic discharge, touch any exposed metal frame of the printer before accessing or touching interior areas of the printer.



2 Remove the toner cartridge.

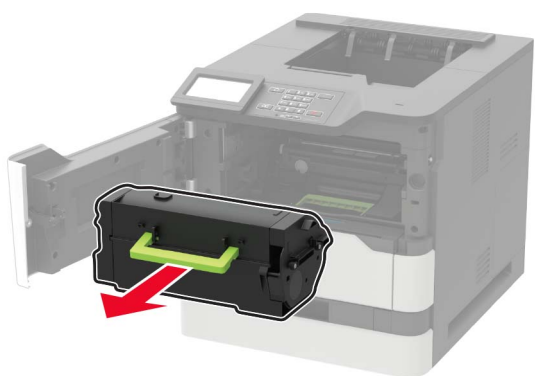

3 Remove the used imaging unit.

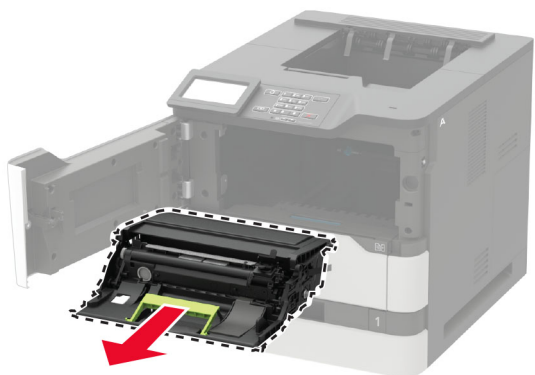

- 4 Unpack the new imaging unit, and then shake it to redistribute the toner.

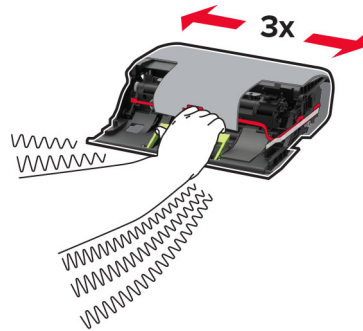

Warning—Potential Damage: Do not expose the imaging unit to direct light for more than 10 minutes. Extended exposure to light may cause print quality problems.

Warning—Potential Damage: Do not touch the photoconductor drum. Doing so may affect the quality of future print jobs.



- 5 Remove the packing material.
- 6 Insert the new imaging unit.



- 7 Insert the toner cartridge.



- 8 Close the door.

Replacing the fuser

- 1 Open door C.

 **CAUTION—HOT SURFACE:** The inside of the printer might be hot. To reduce the risk of injury from a hot component, allow the surface to cool before touching it.

Warning—Potential Damage: To prevent damage from electrostatic discharge, touch any exposed metal frame of the printer before accessing or touching interior areas of the printer.

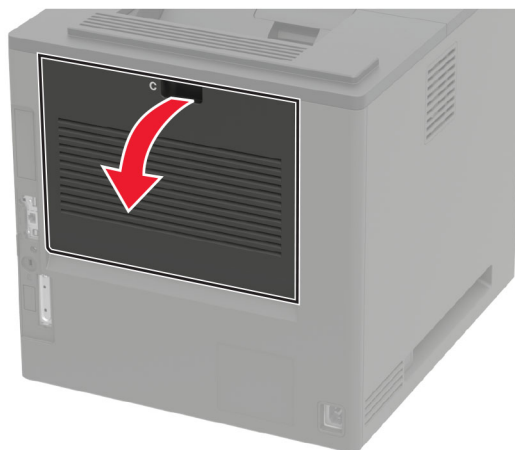

2 Unlock the fuser.

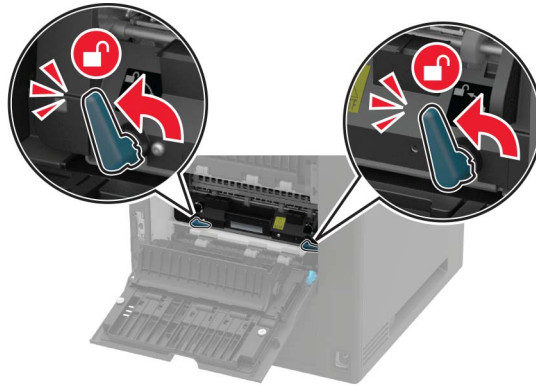

3 Remove the used fuser.

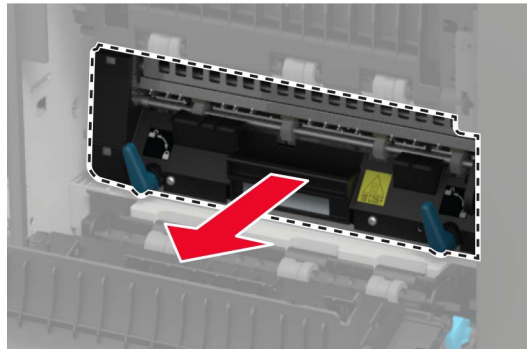

4 Unpack the new fuser.

5 Insert the new fuser until it *clicks* into place.

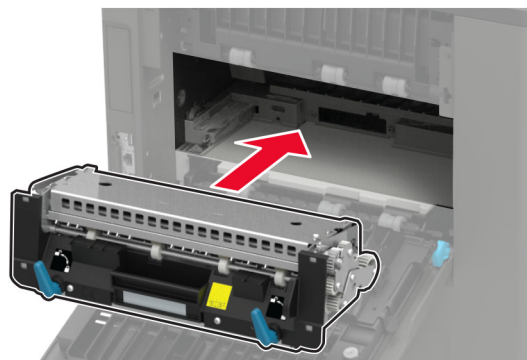

- 6 Lock the fuser.

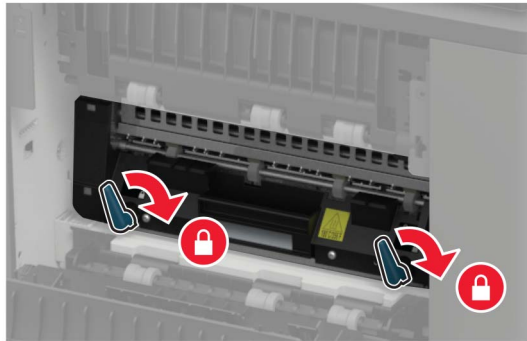

- 7 Close the door.

Replacing the hot roll fuser

- 1 Remove the standard bin cover.

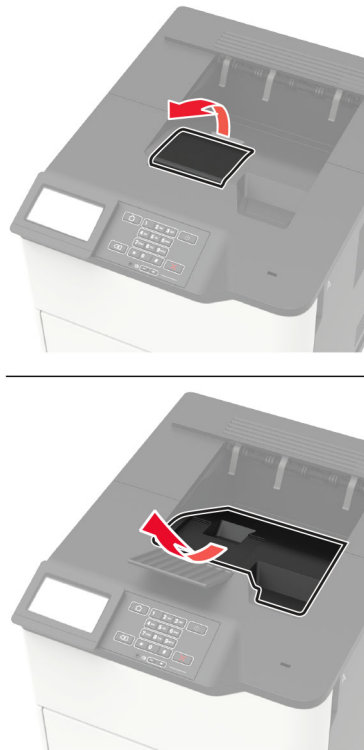

- 2 Open door C.

 **CAUTION—HOT SURFACE:** The inside of the printer might be hot. To reduce the risk of injury from a hot component, allow the surface to cool before touching it.

Warning—Potential Damage: To prevent damage from electrostatic discharge, touch any exposed metal frame of the printer before accessing or touching interior areas of the printer.

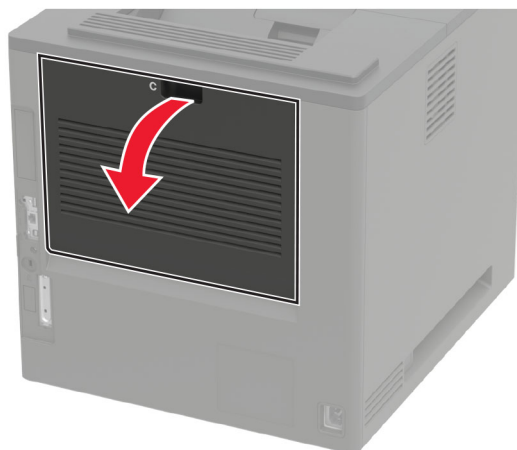

3 Unlock the hot roll fuser.

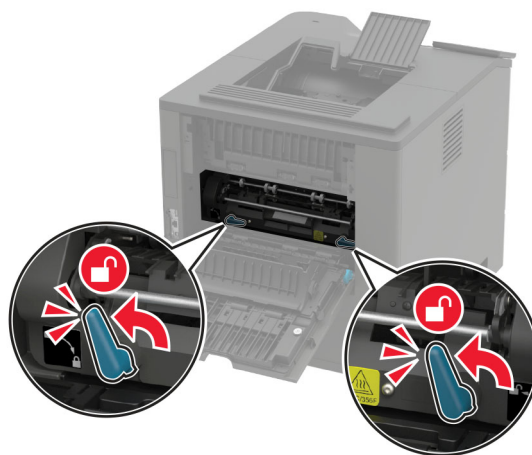

4 Remove the used hot roll fuser.

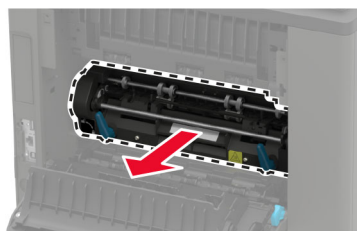

5 Unpack the new hot roll fuser.

- 6 Insert the new hot roll fuser until it *clicks* into place.

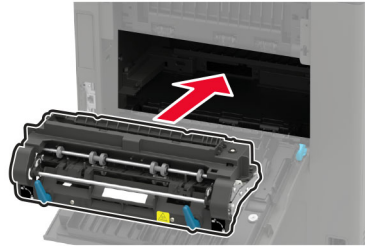

- 7 Lock the hot roll fuser.

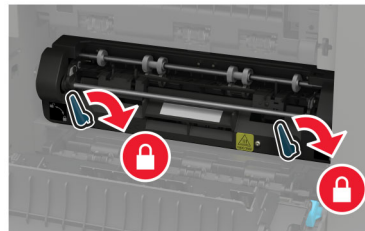

- 8 Close the door.

- 9 Install the standard bin cover.

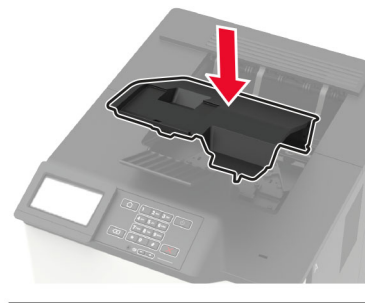

Replacing the transfer roller

- 1 Open door A.

Warning—Potential Damage: To prevent damage from electrostatic discharge, touch any exposed metal frame of the printer before accessing or touching interior areas of the printer.



2 Remove the toner cartridge.

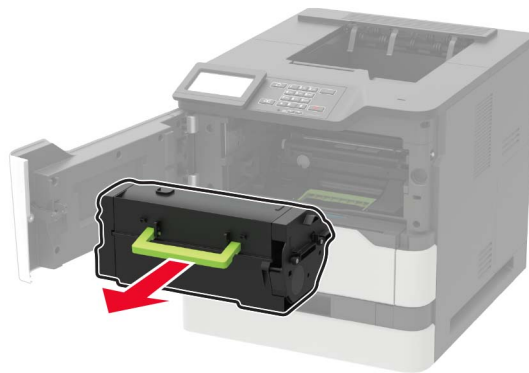

3 Remove the imaging unit.



4 Remove the used transfer roller.

 **CAUTION—HOT SURFACE:** The inside of the printer might be hot. To reduce the risk of injury from a hot component, allow the surface to cool before touching it.

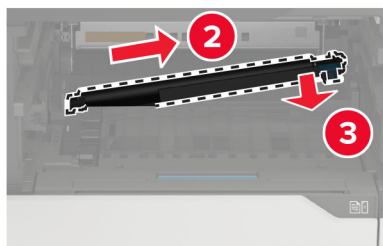
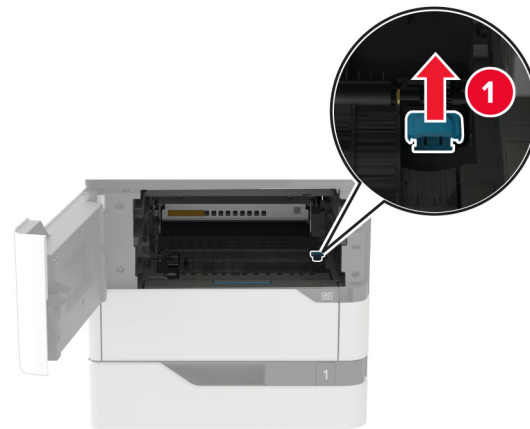

5 Unpack the new transfer roller.

6 Insert the new transfer roller until it *clicks* into place.

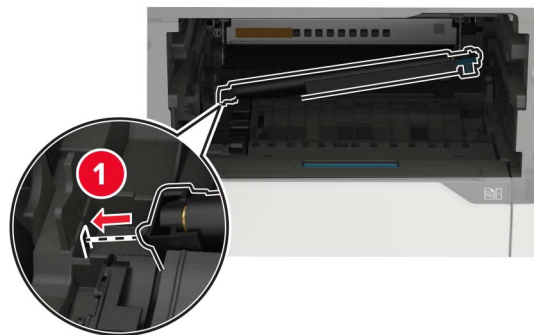

7 Insert the imaging unit.

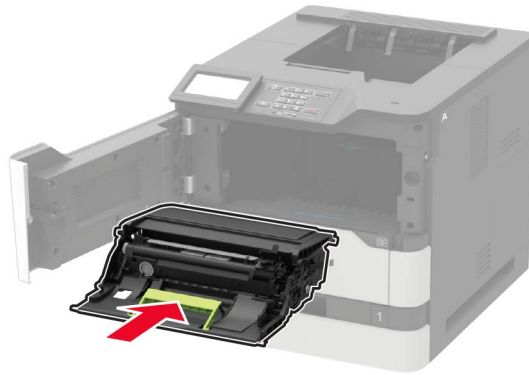

8 Insert the toner cartridge.

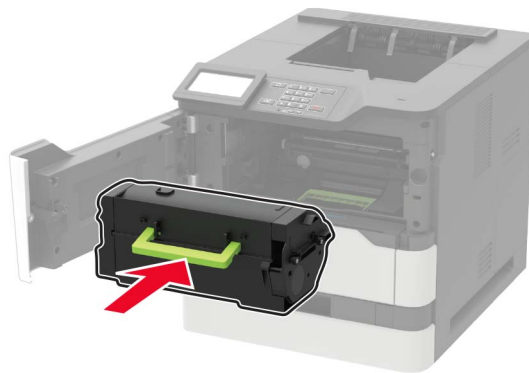

9 Close the door.

Replacing the pick roller

1 Remove the tray.

Warning—Potential Damage: To prevent damage from electrostatic discharge, touch any exposed metal frame of the printer before accessing or touching interior areas of the printer.



- 2 Remove the used pick roller.

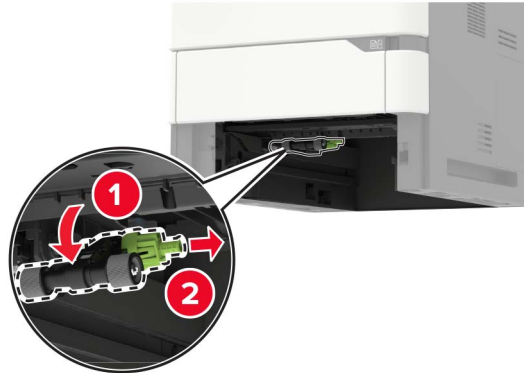

- 3 Unpack the new pick roller.
- 4 Install the new pick roller.

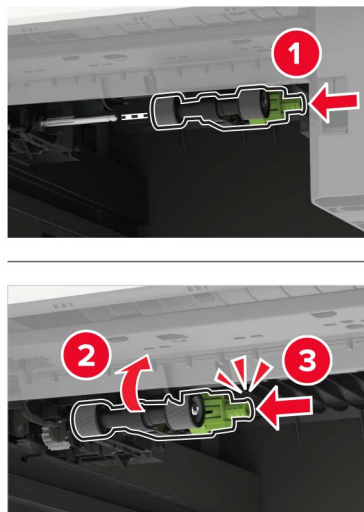

- 5 Insert the tray.

Replacing the pick roller in the multipurpose feeder

- 1 Open the multipurpose feeder.

Warning—Potential Damage: To prevent damage from electrostatic discharge, touch any exposed metal frame of the printer before accessing or touching interior areas of the printer.



2 Remove the used pick roller.

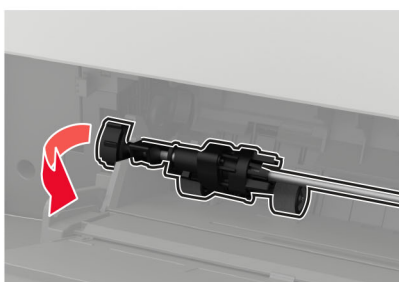

3 Unpack the new pick roller.

4 Install the new pick roller.

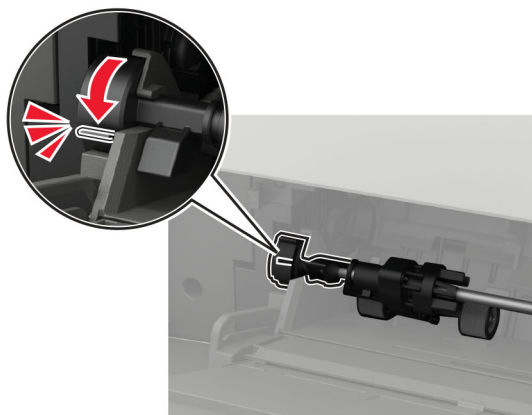
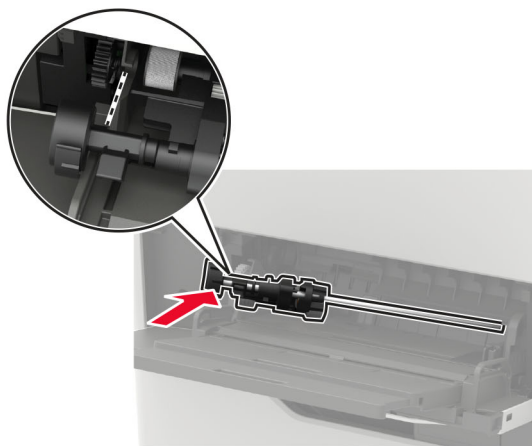
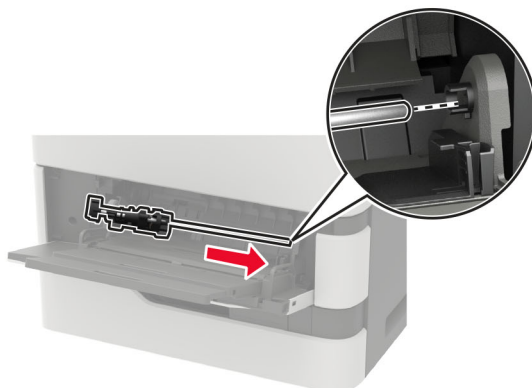

5 Close the multipurpose feeder.

Replacing the staple cartridge in the staple finisher

1 Open door F.

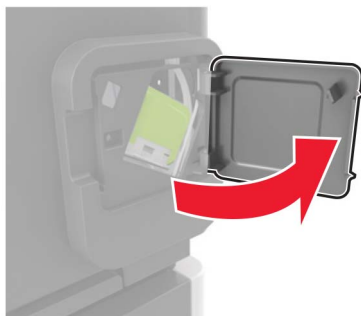

2 Remove the staple cartridge holder.

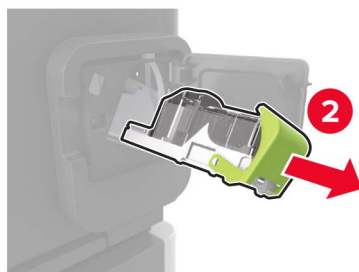
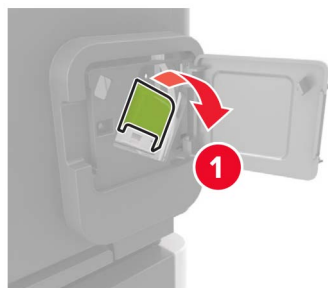

3 Remove the empty staple cartridge.

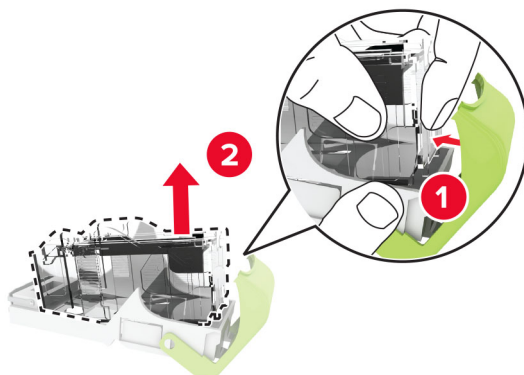

4 Insert the new staple cartridge.

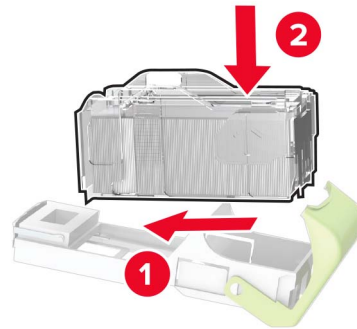

5 Insert the staple cartridge holder.

6 Close the door.

Replacing the staple cartridge in the staple, hole punch finisher

1 Depending on the staple cartridge to replace, open either door F or door G.

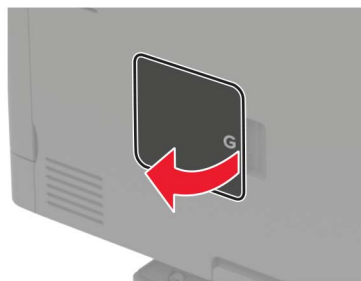
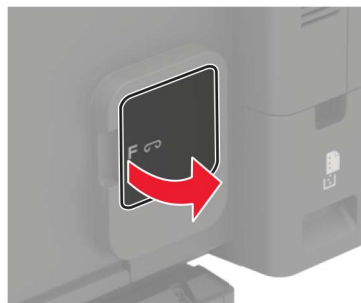

2 Remove the staple cartridge holder.

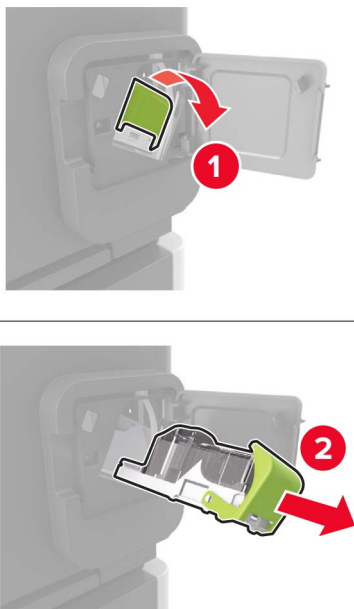

3 Remove the empty staple cartridge.

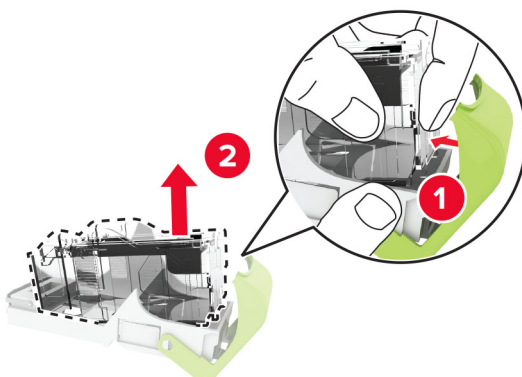

4 Insert the new staple cartridge.

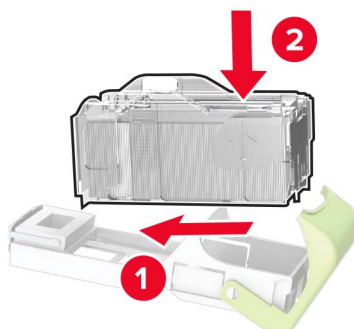



5 Insert the staple cartridge holder.

6 Close the door.

Moving the printer

Moving the printer to another location

 **CAUTION—POTENTIAL INJURY:** If the printer weight is greater than 18 kg (40 lb), then it requires two or more trained personnel to lift it safely.

 **CAUTION—POTENTIAL INJURY:** To avoid the risk of fire or electrical shock, use only the power cord provided with this product or the manufacturer's authorized replacement.

 **CAUTION—POTENTIAL INJURY:** When moving the printer, follow these guidelines to avoid personal injury or printer damage:

- Make sure that all doors and trays are closed.
- Turn off the printer, and then unplug the power cord from the electrical outlet.
- Disconnect all cords and cables from the printer.
- If the printer has separate floor-standing optional trays or output options attached to it, then disconnect them before moving the printer.
- If the printer has a caster base, then carefully roll it to the new location. Use caution when passing over thresholds and breaks in flooring.
- If the printer does not have a caster base but is configured with optional trays or output options, then remove the output options and lift the printer off the trays. Do not try to lift the printer and any options at the same time.
- Always use the handholds on the printer to lift it.
- Any cart used to move the printer must have a surface able to support the full footprint of the printer.
- Any cart used to move the hardware options must have a surface able to support the dimensions of the options.
- Keep the printer in an upright position.
- Avoid severe jarring movements.
- Make sure that your fingers are not under the printer when you set it down.
- Make sure that there is adequate clearance around the printer.

Note: Damage to the printer caused by improper moving is not covered by the printer warranty.

Shipping the printer

For shipping instructions, go to <http://support.lexmark.com> or contact customer support.

Saving energy and paper

Configuring the power save mode settings

For non-touch-screen printer models, press  to navigate through the settings.

Eco-Mode

- 1 From the control panel, navigate to:
Settings > Device > Power Management > Eco-Mode
- 2 Select a setting.

Sleep mode

- 1 From the control panel, navigate to:
Settings > Device > Power Management > Timeouts > Sleep Mode
- 2 Specify the amount of time that the printer stays idle before it enters Sleep mode.

Hibernate mode

- 1 From the control panel, navigate to:
Settings > Device > Power Management > Timeouts > Hibernate Timeout
- 2 Select the amount of time that the printer stays idle before it enters Hibernate mode.

Notes:

- For Hibernate Timeout to work, set Hibernate Timeout on Connection to Hibernate.
- The Embedded Web Server is disabled when the printer is in Hibernate mode.

Adjusting the brightness of the display

Note: This setting is available only in some printer models.

- 1 From the control panel, navigate to:
Settings > Device > Preferences

For non-touch-screen printer models, press  to navigate through the settings.

- 2 In the Screen Brightness menu, adjust the setting.

Conserving supplies

- Print on both sides of the paper.
Note: Two-sided printing is the default setting in the print driver.
- Print multiple pages on a single sheet of paper.
- Use the preview feature to see how the document looks like before printing it.
- Print one copy of the document to check its content and format for accuracy.

Recycling

Recycling Lexmark products

To return Lexmark products for recycling:

- 1 Go to www.lexmark.com/recycle.
- 2 Select the product you want to recycle.

Note: Printer supplies and hardware not listed in the Lexmark Collection and Recycling Program may be recycled through your local recycling center.

Recycling Lexmark packaging

Lexmark continually strives to minimize packaging. Less packaging helps to ensure that Lexmark printers are transported in the most efficient and environmentally sensitive manner and that there is less packaging to dispose of. These efficiencies result in fewer greenhouse emissions, energy savings, and natural resource savings. Lexmark also offers recycling of packaging components in some countries or regions. For more information, go to www.lexmark.com/recycle, and then choose your country or region. Information on available packaging recycling programs is included with the information on product recycling.

Lexmark cartons are 100% recyclable where corrugated recycling facilities exist. Facilities may not exist in your area.

The foam used in Lexmark packaging is recyclable where foam recycling facilities exist. Facilities may not exist in your area.

When you return a cartridge to Lexmark, you can reuse the box that the cartridge came in. Lexmark recycles the box.

Returning Lexmark cartridges for reuse or recycling

The Lexmark Cartridge Collection Program allows you to return used cartridges for free to Lexmark for reuse or recycling. One hundred percent of the empty cartridges returned to Lexmark are either reused or demanufactured for recycling. The boxes used to return the cartridges are also recycled.

To return Lexmark cartridges for reuse or recycling, do the following:

- 1 Go to www.lexmark.com/recycle.
- 2 Select the product that you want to recycle.

Clearing jams

Avoiding jams

Load paper properly

- Make sure paper lies flat in the tray.

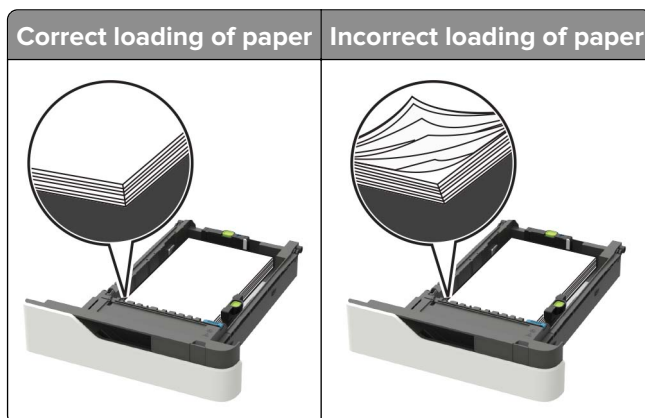

- Do not remove a tray while the printer is printing.
- Do not load a tray while the printer is printing. Load it before printing, or wait for a prompt to load it.
- Do not load too much paper. Make sure the stack height is below the maximum paper fill indicator.
- Do not slide the paper into the tray. Load paper as shown in the illustration.

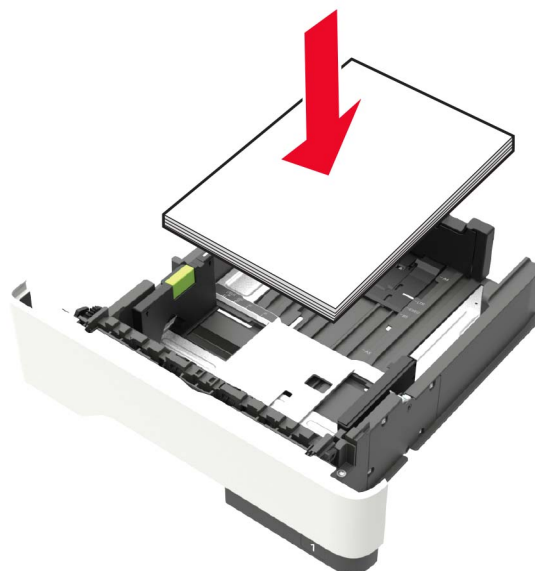

- Make sure the guides in the tray or the multipurpose feeder are properly positioned and are not pressing tightly against the paper or envelopes.
- Push the tray firmly into the printer after loading paper.
- If you are loading prepunched paper for use with the staple finisher, then make sure the holes on the long edge of the paper are on the right side of the tray. For more information, see the “Loading paper and specialty media” section of the *User’s Guide*.

Allow the paper to enter the optional mailbox bins properly

- Make sure to adjust the bin extender so that the paper size indicators match the size of the paper used.

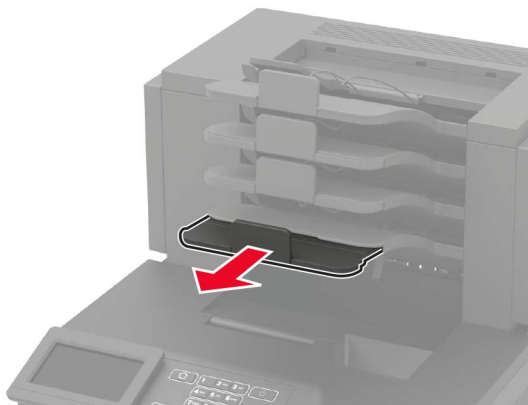

Notes:

- If the bin extender is shorter than the size of the paper you are printing on, then the paper causes a jam in the mailbox bin. For example, if you are printing on a legal-size paper and the bin extender is set to letter-size, then a jam occurs.
- If the bin extender is longer than the size of the paper you are printing on, then the edges become uneven and the paper is not stacked properly. For example, if you are printing on a letter-size paper and the bin extender is set to legal-size, then the paper does not stack properly.
- If paper needs to be returned to the mailbox bin, then insert the paper under the bin arm, and then push the paper all the way back.

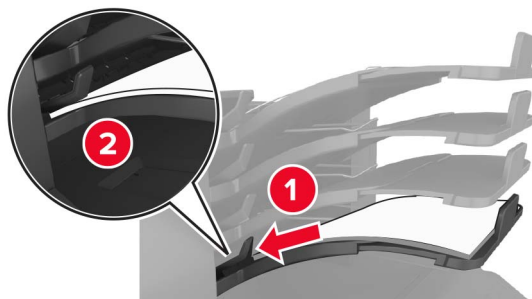

Note: If the paper is not under the bin arm, then a jam occurs due to an overfilled bin.

Use recommended paper

- Use only recommended paper or specialty media.
- Do not load wrinkled, creased, damp, bent, or curled paper.

- Flex, fan, and straighten paper or specialty media before loading it.

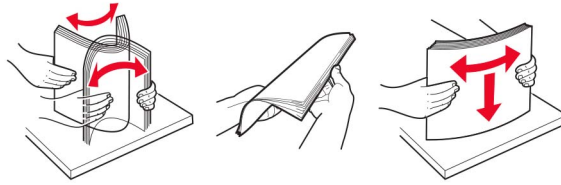

- Do not use paper that has been cut or trimmed by hand.
- Do not mix paper sizes, weights, or types in the same tray.
- Make sure the paper size and type are set correctly on the computer or printer control panel.
- Store paper per manufacturer recommendations.

Identifying jam locations

Notes:

- When Jam Assist is set to On, the printer flushes blank pages or pages with partial prints after a jammed page has been cleared. Check your printed output for blank pages.
- When Jam Recovery is set to On or Auto, the printer reprints jammed pages.

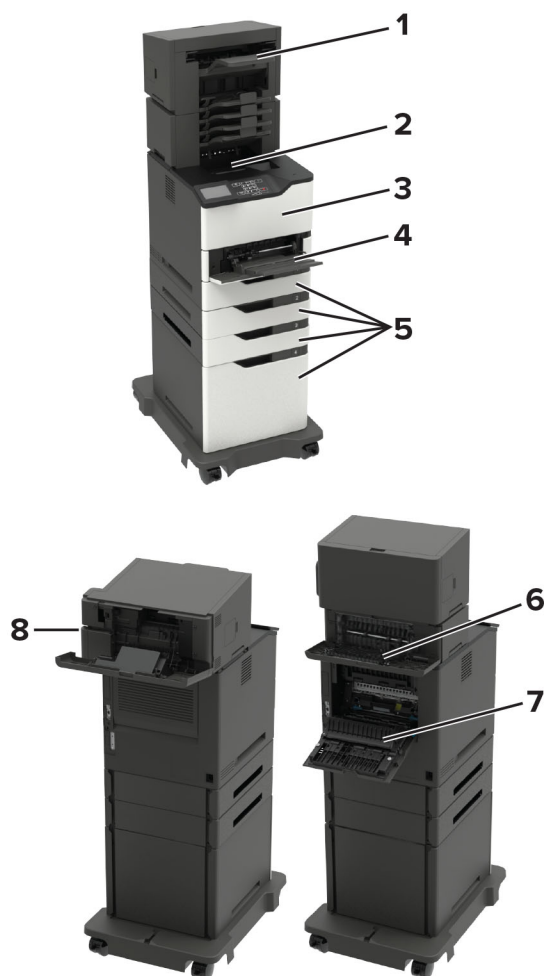

Jam locations	
1	Finisher or output option bin
2	Standard bin
3	Door A
4	Multipurpose feeder
5	Trays
6	Finisher or output option rear door <ul style="list-style-type: none"> • Door H • Door K • Door L • Door N • Door P
7	Door C
8	Staple cartridge access door <ul style="list-style-type: none"> • Door F • Door G

Paper jam in trays

- 1 Remove the tray.



- 2 Remove the jammed paper.

Note: Make sure that all paper fragments are removed.



- 3 Insert the tray.

Paper jam in door A

- 1 Open door A.

Warning—Potential Damage: To prevent damage from electrostatic discharge, touch any exposed metal frame of the printer before accessing or touching interior areas of the printer.



2 Remove the toner cartridge.



3 Remove the imaging unit.



Warning—Potential Damage: Do not expose the imaging unit to direct light for more than 10 minutes. Extended exposure to light may cause print quality problems.

Warning—Potential Damage: Do not touch the photoconductor drum. Doing so may affect the quality of future print jobs.



- 4 Pull out the duplex unit.

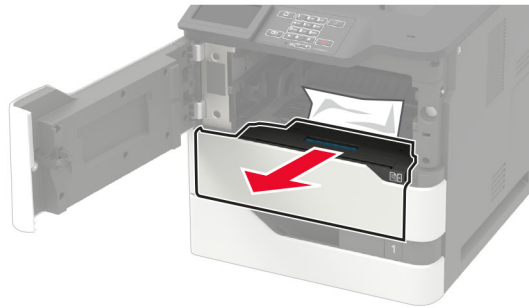

- 5 Remove the jammed paper.

Note: Make sure that all paper fragments are removed.

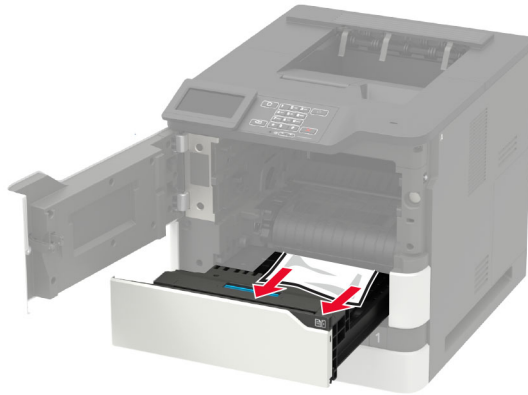

- 6 Insert the duplex unit.

- 7 Insert the imaging unit.



- 8 Insert the toner cartridge.

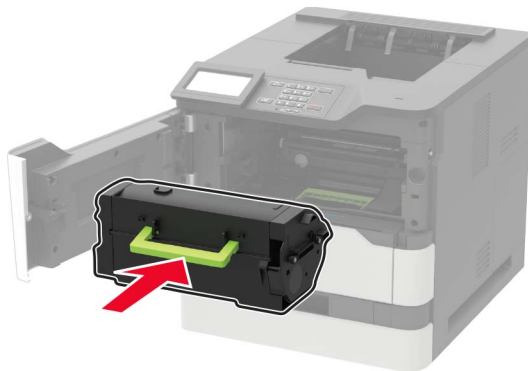

- 9 Close the door.

Paper jam in door C

- 1 Open door C.

 **CAUTION—HOT SURFACE:** The inside of the printer might be hot. To reduce the risk of injury from a hot component, allow the surface to cool before touching it.

Warning—Potential Damage: To prevent damage from electrostatic discharge, touch any exposed metal frame of the printer before accessing or touching interior areas of the printer.

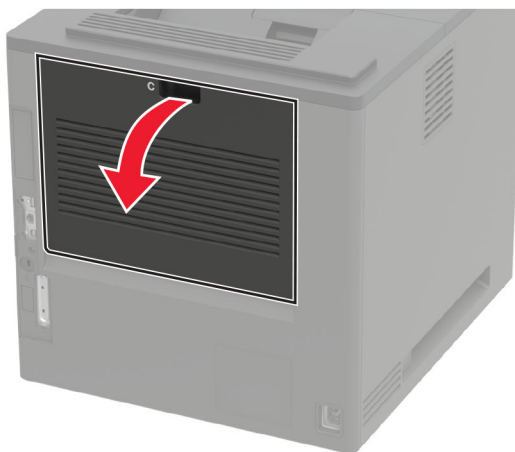

- 2 Remove the jammed paper from any of the following areas:

Note: Make sure that all paper fragments are removed.

- Fuser area



- Below the fuser area

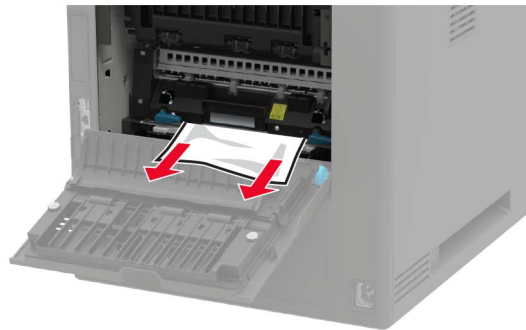

- Duplex area



3 Close the door.

Paper jam in the standard bin

Remove the jammed paper.

Note: Make sure that all paper fragments are removed.



Paper jam in the multipurpose feeder

- 1 Remove paper from the multipurpose feeder.



- 2 Remove the jammed paper.

Note: Make sure that all paper fragments are removed.

- 3 Flex, fan, and align the paper edges before loading.

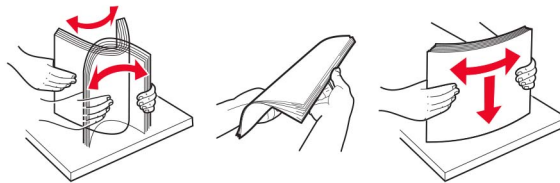

- 4 Reload paper.



Paper jam in the output expander

- 1 Open door K.

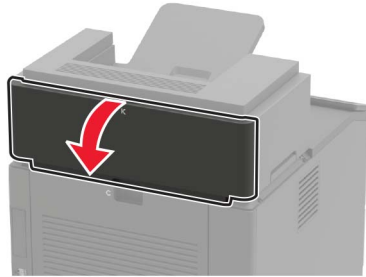

- 2 Remove the jammed paper.

Note: Make sure that all paper fragments are removed.

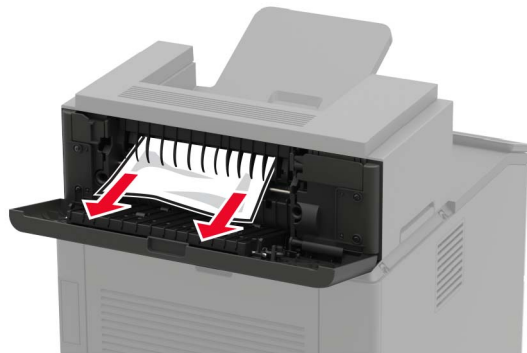

- 3 Close the door.

Paper jam in the high-capacity output expander

- 1 Open door L.

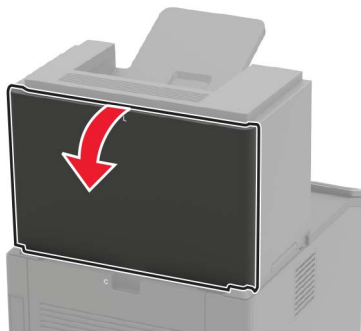

- 2 Remove the jammed paper.

Note: Make sure that all paper fragments are removed.



3 Close the door.

Paper jam in the 4-bin mailbox

Paper jam in door N

1 Open door N.

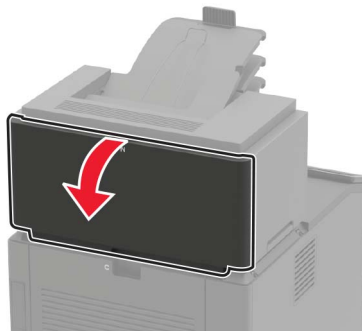

2 Remove the jammed paper.

Note: Make sure that all paper fragments are removed.

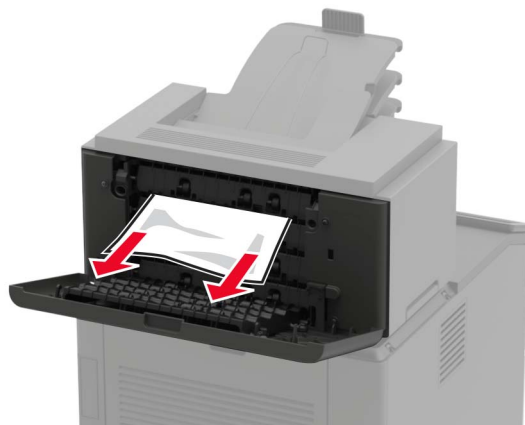

- 3 Close the door.

Paper jam in the mailbox bin

Remove the jammed paper.

Note: Make sure that all paper fragments are removed.

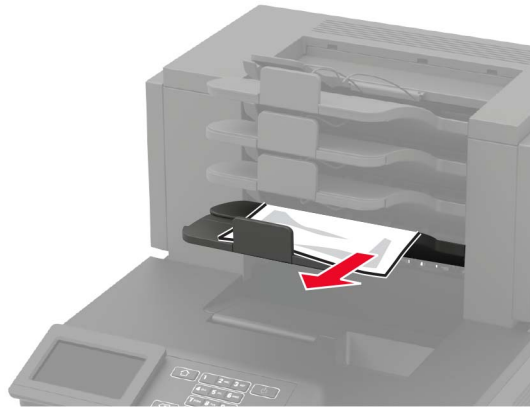

Paper jam in the staple finisher

Paper jam in door H

- 1 Open door H.

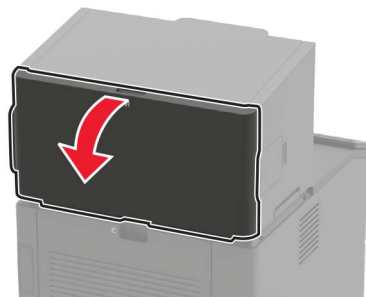

- 2 Remove the jammed paper.

Note: Make sure that all paper fragments are removed.



3 Close the door.

Paper jam in the staple finisher bin

Remove the jammed paper.

Note: Make sure that all paper fragments are removed.



Paper jam in the staple, hole punch finisher

Paper jam in door P

1 Open door P.

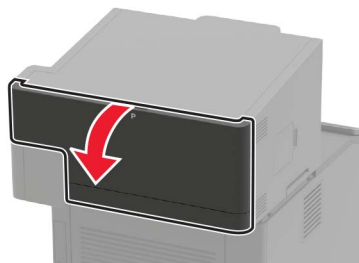

2 Remove the jammed paper.

Note: Make sure that all paper fragments are removed.



3 Close the door.

Paper jam in the staple, hole punch finisher bin

Remove the jammed paper.

Note: Make sure that all paper fragments are removed.



Staple jam in the staple finisher

1 Open door F.

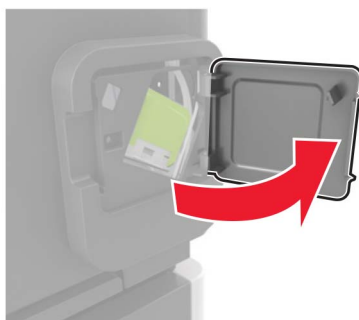

2 Remove the staple cartridge holder.

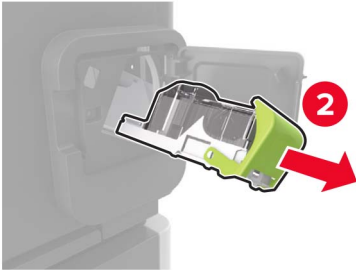
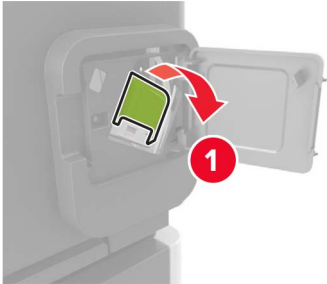

3 Remove the loose staples.

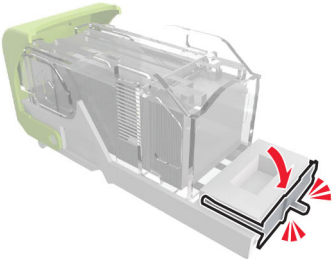
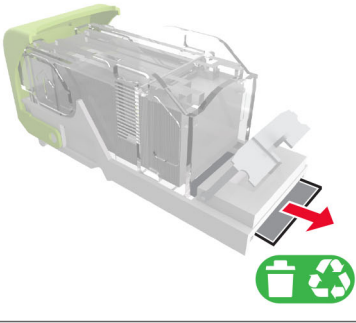
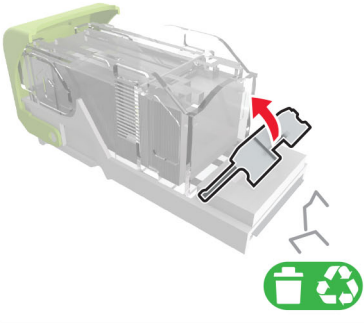

- 4 Press the staples against the metal bracket.



Note: If the staples are at the rear of the cartridge, then shake the cartridge downward to bring the staples near the metal bracket.

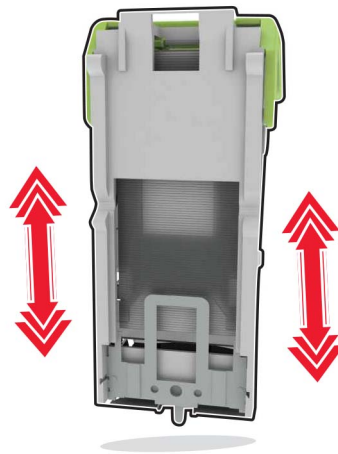

- 5 Insert the staple cartridge holder until it *clicks* into place.

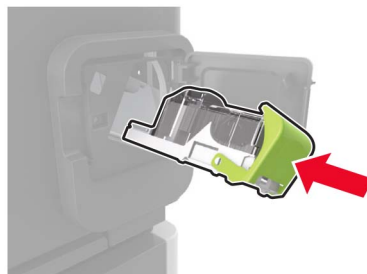

- 6 Close the door.

Staple jam in the staple, hole punch finisher

- 1 Depending on the staple jam location, open either door F or door G.

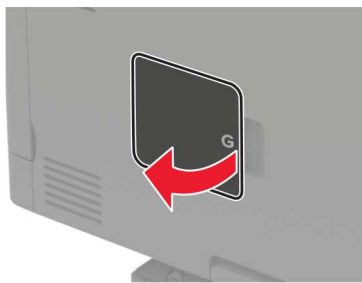
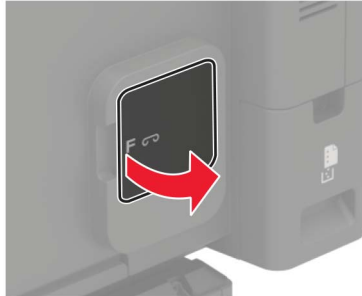

- 2 Remove the staple cartridge holder.

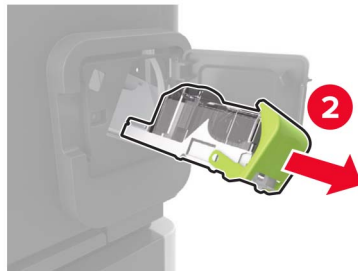
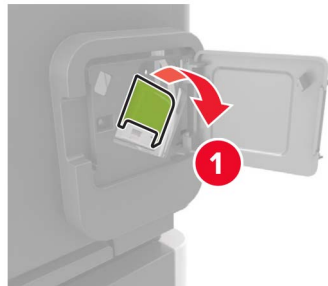

3 Remove the loose staples.

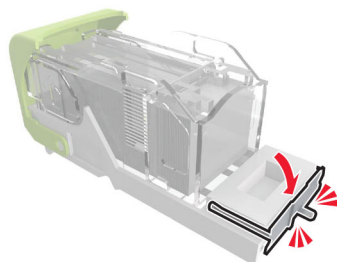
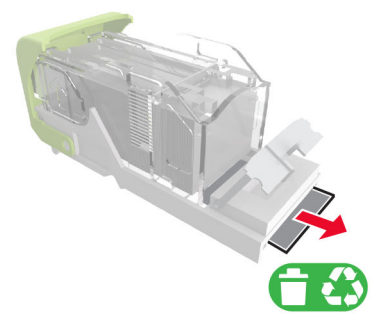
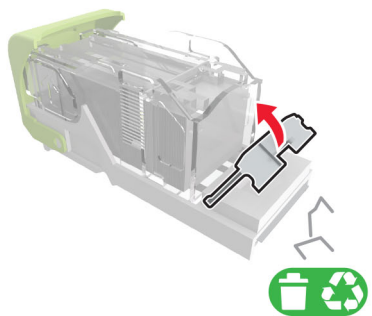

4 Press the staples against the metal bracket.



Note: If the staples are at the rear of the cartridge, then shake the cartridge downward to bring the staples near the metal bracket.

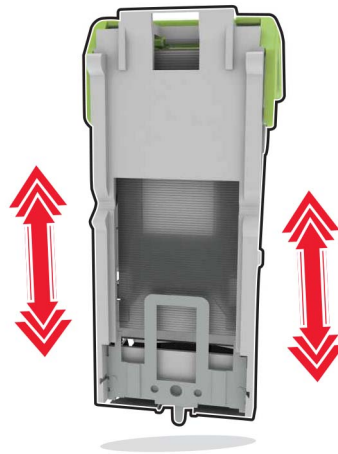

5 Insert the staple cartridge holder until it *clicks* into place.

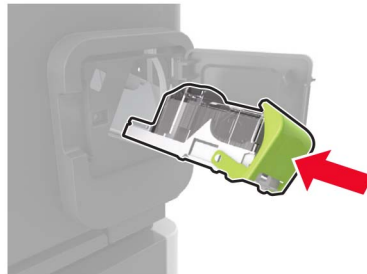

6 Close the door.

Troubleshooting

Network connection problems

Cannot open Embedded Web Server

Action	Yes	No
<p>Step 1 Check if the printer is on.</p> <p>Is the printer on?</p>	Go to step 2.	Turn on the printer.
<p>Step 2 Make sure that the printer IP address is correct.</p> <p>View the printer IP address:</p> <ul style="list-style-type: none"> • From the home screen • From the TCP/IP section in the Network/Ports menu • By printing a network setup page or menu settings page, and then finding the TCP/IP section <p>Note: An IP address appears as four sets of numbers separated by periods, such as 123.123.123.123.</p> <p>Is the printer IP address correct?</p>	Go to step 3.	Type the correct printer IP address in the address field.
<p>Step 3 Check if you are using a supported browser:</p> <ul style="list-style-type: none"> • Internet Explorer® version 11 or later • Microsoft Edge™ • Safari version 6 or later • Google Chrome™ version 32 or later • Mozilla Firefox version 24 or later <p>Is your browser supported?</p>	Go to step 4.	Install a supported browser.
<p>Step 4 Check if the network connection is working.</p> <p>Is the network connection working?</p>	Go to step 5.	Contact your administrator.
<p>Step 5 Make sure that the cable connections to the printer and print server are secure. For more information, see the documentation that came with the printer.</p> <p>Are the cable connections secure?</p>	Go to step 6.	Secure the cable connections.

Action	Yes	No
<p>Step 6 Check if the web proxy servers are disabled.</p> <p>Are the web proxy servers disabled?</p>	Go to step 7.	Contact your administrator.
<p>Step 7 Access the Embedded Web Server.</p> <p>Did the Embedded Web Server open?</p>	The problem is solved.	Contact customer support .

Unable to read flash drive

Action	Yes	No
<p>Step 1 Check if the printer is not busy processing another print, copy, scan, or fax job.</p> <p>Is the printer ready?</p>	Go to step 2.	Wait for the printer to finish processing the other job.
<p>Step 2 Check if the flash drive is inserted into the front USB port.</p> <p>Note: The flash drive does not work when it is inserted into the rear USB port.</p> <p>Is the flash drive inserted into the correct port?</p>	Go to step 3.	Insert the flash drive into the correct port.
<p>Step 3 Check if the flash drive is supported. For more information, see “Supported flash drives and file types” on page 46.</p> <p>Is the flash drive supported?</p>	Go to step 4.	Insert a supported flash drive.
<p>Step 4</p> <p>a Check if the USB port is enabled. For more information, see “Enabling the USB port” on page 150.</p> <p>b Remove, and then insert the flash drive.</p> <p>Does the printer recognize the flash drive?</p>	The problem is solved.	Contact customer support .

Enabling the USB port

From the control panel, navigate to:

Settings > Network/Ports > USB > Enable USB Port

For non-touch-screen printer models, press  to navigate through the settings.

Checking the printer connectivity

1 Print the Network Setup Page.

From the control panel, navigate to:

Settings > Reports > Network > Network Setup Page

For non-touch-screen printer models, press  to navigate through the settings.

2 Check the first section of the page and confirm that the status is connected.

If the status is not connected, then the LAN drop may be inactive or the network cable may be unplugged or malfunctioning. Contact your administrator for assistance.

Hardware options problems

Cannot detect internal option

Action	Yes	No
<p>Step 1 Turn off the printer, wait for about 10 seconds, and then turn on the printer.</p> <p>Does the internal option operate correctly?</p>	The problem is solved.	Go to step 2.
<p>Step 2 Print the Menu Settings Page, and then check if the internal option appears in the Installed Features list.</p> <p>Is the internal option listed in the menu settings page?</p>	Go to step 4.	Go to step 3.
<p>Step 3 Check if the internal option is installed properly into the controller board.</p> <ul style="list-style-type: none"> a Turn off the printer, and then unplug the power cord from the electrical outlet. b Make sure that the internal option is installed in the appropriate connector in the controller board. c Connect the power cord to the electrical outlet, and then turn on the printer. <p> CAUTION—POTENTIAL INJURY: To avoid the risk of fire or electrical shock, connect the power cord to an appropriately rated and properly grounded electrical outlet that is near the product and easily accessible.</p> <p>Does the internal option operate correctly?</p>	The problem is solved.	Go to step 4.

Action	Yes	No
<p>Step 4</p> <p>a Check if the internal option is available in the print driver.</p> <p>Note: If necessary, manually add the internal option in the print driver to make it available for print jobs. For more information, see “Adding available options in the print driver” on page 216.</p> <p>b Resend the print job.</p> <p>Does the internal option operate correctly?</p>	<p>The problem is solved.</p>	<p>Contact customer support.</p>

Defective flash detected

Try one or more of the following:

- Replace the defective flash memory.
- From the printer control panel, select **Continue** to ignore the message and continue printing.
- Cancel the current print job.

Not enough free space in flash memory for resources

Try one or more of the following:

- From the printer control panel, select **Continue** to clear the message and continue printing.
- Delete fonts, macros, and other data stored in the flash memory.
- Install flash memory with larger capacity.

Note: Downloaded fonts and macros that are not previously stored in the flash memory are deleted.

Unformatted flash detected

Try one or more of the following:

- From the control panel, select **Continue** to stop the defragmentation and continue printing.
- Format the flash memory.

Note: If the error message remains, then the flash memory may be defective and needs to be replaced.

Issues with supplies

Replace cartridge, printer region mismatch

To correct this problem, purchase a cartridge with the correct region that matches the printer region, or purchase a worldwide cartridge.

- The first number in the message after 42 indicates the region of the printer.
- The second number in the message after 42 indicates the region of the cartridge.

Printer and toner cartridge regions

Region	Numeric code
Worldwide or Undefined region	0
North America (United States, Canada)	1
European Economic Area, Western Europe, Nordic countries, Switzerland	2
Asia Pacific	3
Latin America	4
Rest of Europe, Middle East, Africa	5
Australia, New Zealand	6
Invalid region	9

Note: To find the region settings of the printer and toner cartridge, print the print quality test pages. From the control panel, navigate to: **Settings > Troubleshooting > Print Quality Test Pages.**

Non-Lexmark supply

The printer has detected a non-Lexmark supply or part installed in the printer.

Your Lexmark printer is designed to function best with genuine Lexmark supplies and parts. Use of third-party supplies or parts may affect the performance, reliability, or life of the printer and its imaging components.

All life indicators are designed to function with Lexmark supplies and parts and may deliver unpredictable results if third-party supplies or parts are used. Imaging component usage beyond the intended life may damage your Lexmark printer or associated components.

Warning—Potential Damage: Use of third-party supplies or parts can affect warranty coverage. Damage caused by the use of third-party supplies or parts may not be covered by the warranty.

To accept any and all of these risks and to proceed with the use of non-genuine supplies or parts in your printer, depending on your printer model, from the control panel, press and hold **X** and **#**, or **X** and **OK**, simultaneously for 15 seconds.

If you do not want to accept these risks, then remove the third-party supply or part from your printer and install a genuine Lexmark supply or part. For more information, see [“Using genuine Lexmark parts and supplies” on page 104.](#)

If the printer does not print after pressing and holding **X** and **#**, or **X** and **OK**, simultaneously for 15 seconds, then reset the supply usage counter.

- From the control panel, navigate to:
Settings > Device > Maintenance > Configuration Menu > Supply Usage And Counters

For non-touch-screen printer models, press **OK** to navigate through the settings.

- Select the part or supply that you want to reset, and then select **Start**.

3 Read the warning message, and then select **Continue**.

4 Press and hold **X** and **#**, or **X** and **OK**, simultaneously for 15 seconds to clear the message.

Note: If you are unable to reset the supply usage counters, then return the item to the place of purchase.

Paper feed problems

Envelope seals when printing

Action	Yes	No
<p>Step 1</p> <p>a Use an envelope that has been stored in a dry environment. Note: Printing on envelopes with high moisture content can seal the flaps.</p> <p>b Send the print job.</p> <p>Does the envelope seal when printing?</p>	Go to step 2.	The problem is solved.
<p>Step 2</p> <p>a Make sure that paper type is set to Envelope. From the control panel, navigate to: Settings > Paper > Tray Configuration > Paper Size/Type</p> <p>For non-touch-screen printer models, press OK to navigate through the settings.</p> <p>b Send the print job.</p> <p>Does the envelope seal when printing?</p>	Contact customer support .	The problem is solved.

Collated printing does not work

Action	Yes	No
<p>Step 1</p> <p>a From the printer control panel, navigate to: Settings > Print > Layout > Collate</p> <p>For non-touch-screen printer models, press OK to navigate through the settings.</p> <p>b Set Collate to On.</p> <p>c Print the document.</p> <p>Are the pages collated correctly?</p>	The problem is solved.	Go to step 2.

Action	Yes	No
<p>Step 2</p> <p>a From the document that you are trying to print, open the Print dialog, and then select Collate.</p> <p>b Print the document.</p> <p>Are the pages collated correctly?</p>	The problem is solved.	Go to step 3.
<p>Step 3</p> <p>a Reduce the number of pages to print.</p> <p>b Print the document.</p> <p>Are the pages collated correctly?</p>	The problem is solved.	Contact customer support .

Tray linking does not work

Action	Yes	No
<p>Step 1</p> <p>a Check if the trays contain the same paper size and paper type.</p> <p>b Check if the paper guides are positioned correctly.</p> <p>c Print the document.</p> <p>Do the trays link correctly?</p>	The problem is solved.	Go to step 2.
<p>Step 2</p> <p>a From the control panel, navigate to: Settings > Paper > Tray Configuration > Paper Size/Type</p> <p>For non-touch-screen printer models, press  to navigate through the settings.</p> <p>b Set the paper size and paper type to match the paper loaded in the linked trays.</p> <p>c Print the document.</p> <p>Do the trays link correctly?</p>	The problem is solved.	Go to step 3.
<p>Step 3</p> <p>a Make sure that Tray Linking is set to Automatic. For more information, see “Linking trays” on page 35.</p> <p>b Print the document.</p> <p>Do the trays link correctly?</p>	The problem is solved.	Contact customer support .

Paper frequently jams

Action	Yes	No
<p>Step 1</p> <p>a Remove the tray.</p> <p>b Check if paper is loaded correctly.</p> <p>Notes:</p> <ul style="list-style-type: none"> • Make sure that the paper guides are positioned correctly. • Make sure that the stack height is below the maximum paper fill indicator. • Make sure to print on recommended paper size and type. <p>c Insert the tray.</p> <p>d Print the document.</p> <p>Do paper jams occur frequently?</p>	Go to step 2.	The problem is solved.
<p>Step 2</p> <p>a From the control panel, navigate to: Settings > Paper > Tray Configuration > Paper Size/Type</p> <p>For non-touch-screen printer models, press  to navigate through the settings.</p> <p>b Set the correct paper size and type.</p> <p>c Print the document.</p> <p>Do paper jams occur frequently?</p>	Go to step 3.	The problem is solved.
<p>Step 3</p> <p>a Load paper from a fresh package.</p> <p>Note: Paper absorbs moisture due to high humidity. Store paper in its original wrapper until you are ready to use it.</p> <p>b Print the document.</p> <p>Do paper jams occur frequently?</p>	Contact customer support .	The problem is solved.

Jammed pages are not reprinted

Action	Yes	No
<p>a From the control panel, navigate to: Settings > Device > Notifications > Jam Content Recovery</p> <p>For non-touch-screen printer models, press  to navigate through the settings.</p> <p>b Select On or Auto, and then apply the changes.</p> <p>c Print the document.</p> <p>Are the jammed pages reprinted?</p>	<p>The problem is solved.</p>	<p>Contact customer support.</p>

Printing problems

Print quality is poor

Blank or white pages



Note: Before solving the problem, print the Print Quality Test Pages. From the control panel, navigate to **Settings > Troubleshooting > Print Quality Test Pages**. For non-touch-screen printer models, press  to navigate through the settings.

Action	Yes	No
<p>Step 1</p> <p>a Check if the printer is using a genuine and supported Lexmark toner cartridge.</p> <p>Note: If the cartridge is not supported, then install a supported one.</p> <p>b Print the document.</p> <p>Is the printer printing blank or white pages?</p>	<p>Go to step 2.</p>	<p>The problem is solved.</p>

Action	Yes	No
<p>Step 2</p> <p>a Remove any packing material that is left on the imaging unit.</p> <p>1 Remove the toner cartridge, and then remove the imaging unit.</p> <p>Warning—Potential Damage: Do not expose the imaging unit to direct light for more than 10 minutes. Extended exposure to light may cause print quality problems.</p> <p>Warning—Potential Damage: Do not touch the photoconductor drum under the imaging unit. Doing so may affect the quality of future print jobs.</p> <p>2 Check the imaging unit for signs of damage.</p> <p>Note: Make sure that the photoconductor drum contact is not bent or out of place.</p> <p>3 Firmly shake the imaging unit to redistribute the toner.</p> <p>4 Insert the imaging unit, and then insert the toner cartridge.</p> <p>b Print the document.</p> <p>Is the printer printing blank or white pages?</p>	<p>Go to step 3.</p>	<p>The problem is solved.</p>
<p>Step 3</p> <p>Check the transfer roller for proper installation.</p> <p>Is the transfer roller installed properly?</p>	<p>Go to step 5.</p>	<p>Go to step 4.</p>
<p>Step 4</p> <p>a Remove, and then insert the transfer roller.</p> <p>b Print the document.</p> <p>Is the printer printing blank or white pages?</p>	<p>Go to step 5.</p>	<p>The problem is solved.</p>
<p>Step 5</p> <p>a Replace the imaging unit.</p> <p>b Print the document.</p> <p>Is the printer printing blank or white pages?</p>	<p>Contact customer support.</p>	<p>The problem is solved.</p>

Dark print





Note: Before solving the problem, print the Print Quality Test Pages. From the control panel, navigate to **Settings > Troubleshooting > Print Quality Test Pages**. For non-touch-screen printer models, press  to navigate through the settings.

Action	Yes	No
<p>Step 1</p> <p>a Check if the printer is using a genuine and supported Lexmark toner cartridge.</p> <p>Note: If the cartridge is not supported, then install a supported one.</p> <p>b Print the document.</p> <p>Is the print dark?</p>	Go to step 2.	The problem is solved.
<p>Step 2</p> <p>a Turn off the printer, wait for about 10 seconds, and then turn on the printer.</p> <p>b Reduce toner darkness. From the control panel, navigate to: Settings > Print > Quality</p> <p>c Print the document.</p> <p>Is the print dark?</p>	Go to step 3.	The problem is solved.
<p>Step 3</p> <p>a Depending on your operating system, specify the paper type from the Printing Preferences or Print dialog.</p> <p>Notes:</p> <ul style="list-style-type: none"> • Make sure that the setting matches the paper loaded. • You can also change the setting on the printer control panel. <p>b Print the document.</p> <p>Is the print dark?</p>	Go to step 4.	The problem is solved.
<p>Step 4</p> <p>Check if the paper has texture or rough finishes.</p> <p>Are you printing on textured or rough paper?</p>	Go to step 5.	Go to step 6.
<p>Step 5</p> <p>a Replace textured paper with plain paper.</p> <p>b Print the document.</p> <p>Is the print dark?</p>	Go to step 6.	The problem is solved.

Action	Yes	No
<p>Step 6</p> <p>a Load paper from a fresh package.</p> <p>Note: Paper absorbs moisture due to high humidity. Store paper in its original wrapper until you are ready to use it.</p> <p>b Print the document.</p> <p>Is the print dark?</p>	Go to step 7.	The problem is solved.
<p>Step 7</p> <p>a Remove, and then insert the imaging unit.</p> <p>Warning—Potential Damage: Do not expose the imaging unit to direct light for more than 10 minutes. Extended exposure to light may cause print quality problems.</p> <p>Warning—Potential Damage: Do not touch the photoconductor drum under the imaging unit. Doing so may affect the quality of future print jobs.</p> <p>b Print the document.</p> <p>Is the print dark?</p>	Go to step 8.	The problem is solved.
<p>Step 8</p> <p>a Replace the imaging unit.</p> <p>b Print the document.</p> <p>Is the print dark?</p>	Contact customer support .	The problem is solved.

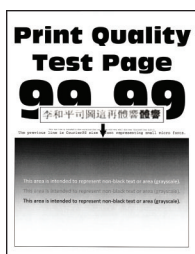
Fine lines are not printed correctly



Note: Before solving the problem, print the Print Quality Test Pages. From the control panel, navigate to **Settings > Troubleshooting > Print Quality Test Pages**. For non-touch-screen printer models, press  to navigate through the settings.

Action	Yes	No
<p>Step 1</p> <p>a Check if the printer is using a genuine and supported Lexmark toner cartridge.</p> <p>Note: If the cartridge is not supported, then install a supported one.</p> <p>b Print the document.</p> <p>Are fine lines not printed correctly?</p>	Go to step 2.	The problem is solved.
<p>Step 2</p> <p>a Adjust the print quality settings.</p> <p>1 From the control panel, navigate to: Settings > Print > Quality > Pixel Boost > Fonts</p> <p>2 Adjust Toner Darkness to 7. From the control panel, navigate to: Settings > Print > Quality</p> <p>b Print the document.</p> <p>Are fine lines not printed correctly?</p>	Contact customer support .	The problem is solved.

Folded or wrinkled paper

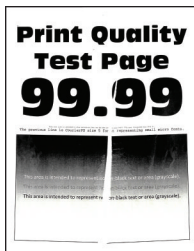



Note: Before solving the problem, print the Print Quality Test Pages. From the control panel, navigate to **Settings > Troubleshooting > Print Quality Test Pages**. For non-touch-screen printer models, press  to navigate through the settings.

Action	Yes	No
<p>Step 1</p> <p>a Check if the printer is using a genuine and supported Lexmark toner cartridge.</p> <p>Note: If the cartridge is not supported, then install a supported one.</p> <p>b Print the document.</p> <p>Is the paper folded or wrinkled?</p>	Go to step 2.	The problem is solved.

Action	Yes	No
<p>Step 2</p> <p>a Load paper from a fresh package.</p> <p>Note: Paper absorbs moisture due to high humidity. Store paper in its original wrapper until you are ready to use it.</p> <p>b Print the document.</p> <p>Is the paper folded or wrinkled?</p>	Go to step 3.	The problem is solved.
<p>Step 3</p> <p>a Depending on your operating system, specify the paper type from the Printing Preferences or Print dialog.</p> <p>Notes:</p> <ul style="list-style-type: none"> • Make sure that the setting matches the paper loaded. • You can also change the setting from the printer control panel. <p>b Print the document.</p> <p>Is the paper folded or wrinkled?</p>	Contact customer support .	The problem is solved.

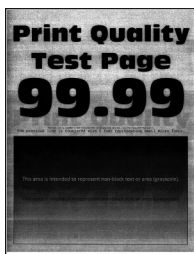
Gray background



Note: Before solving the problem, print the Print Quality Test Pages. From the control panel, navigate to **Settings > Troubleshooting > Print Quality Test Pages**. For non-touch-screen printer models, press  to navigate through the settings.

Action	Yes	No
<p>Step 1</p> <p>a Turn off the printer, wait for 10 seconds, and then turn on the printer.</p> <p>b Decrease toner darkness.</p> <p>From the control panel, navigate to:</p> <p>Settings > Print > Quality</p> <p>c Print the document.</p> <p>Does gray background appear on prints?</p>	Go to step 2.	The problem is solved.

Action	Yes	No
<p>Step 2</p> <p>a Check if the printer is using a genuine and supported Lexmark toner cartridge.</p> <p>Note: If the toner cartridge is not supported, then install a supported one.</p> <p>b Print the document.</p> <p>Does gray background appear on prints?</p>	<p>Go to step 3.</p>	<p>The problem is solved.</p>
<p>Step 3</p> <p>a Depending on your operating system, specify the paper type from the Printing Preferences or Print dialog.</p> <p>Notes:</p> <ul style="list-style-type: none"> • Make sure that the setting matches the paper loaded. • You can also change the setting from the printer control panel. <p>b Print the document.</p> <p>Does gray background appear on prints?</p>	<p>Go to step 4.</p>	<p>The problem is solved.</p>

Action	Yes	No
<p>Step 4</p> <p>a Remove the imaging unit.</p> <p>Warning—Potential Damage: Do not expose the imaging unit to direct light for more than 10 minutes. Extended exposure to light may cause print quality problems.</p> <p>Warning—Potential Damage: Do not touch the photoconductor drum under the imaging unit. Doing so may affect the quality of future print jobs.</p> <p>b Remove any packing material that is stuck on the imaging unit.</p> <div data-bbox="402 625 781 1178" style="text-align: center;"> </div> <p>Note: Make sure to remove any obstruction between the charge roller and photoconductor drum.</p> <p>c Insert the imaging unit.</p> <p>d Print the document.</p> <p>Does gray background appear on prints?</p>	<p>Go to step 5.</p>	<p>The problem is solved.</p>
<p>Step 5</p> <p>a Replace the imaging unit.</p> <p>b Print the document.</p> <p>Does gray background appear on prints?</p>	<p>Contact customer support.</p>	<p>The problem is solved.</p>

Incorrect margins



Action	Yes	No
<p>Step 1</p> <p>a Adjust the paper guides to the correct position for the paper loaded.</p> <p>b Print the document.</p> <p>Are the margins correct?</p>	<p>The problem is solved.</p>	<p>Go to step 2.</p>
<p>Step 2</p> <p>a Depending on your operating system, specify the paper size from the Printing Preferences or Print dialog.</p> <p>Notes:</p> <ul style="list-style-type: none"> • Make sure that the setting matches the paper loaded. • You can also change the setting from the printer control panel. <p>b Print the document.</p> <p>Are the margins correct?</p>	<p>The problem is solved.</p>	<p>Contact customer support.</p>

Light print

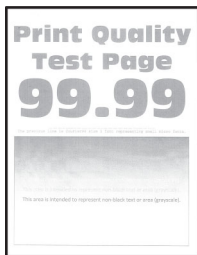

Note: Before solving the problem, print the Print Quality Test Pages. From the control panel, navigate to

Settings > Troubleshooting > Print Quality Test Pages. For non-touch-screen printer models, press  to navigate through the settings.

Action	Yes	No
<p>Step 1</p> <p>a Check if the printer is using a genuine and supported Lexmark toner cartridge.</p> <p>Note: If the cartridge is not supported, then install a supported one.</p> <p>b Print the document.</p> <p>Is the print light?</p>	<p>Go to step 2.</p>	<p>The problem is solved.</p>
<p>Step 2</p> <p>a Turn off the printer, wait for about 10 seconds, and then turn on the printer.</p> <p>b Increase toner darkness. From the control panel, navigate to: Settings > Print > Quality</p> <p>c Print the document.</p> <p>Is the print light?</p>	<p>Go to step 3.</p>	<p>The problem is solved.</p>
<p>Step 3</p> <p>a Depending on your operating system, specify the paper type from the Printing Preferences or Print dialog.</p> <p>Notes:</p> <ul style="list-style-type: none"> • Make sure that the setting matches the paper loaded. • You can also change the setting on the printer control panel. <p>b Print the document.</p> <p>Is the print light?</p>	<p>Go to step 4.</p>	<p>The problem is solved.</p>
<p>Step 4</p> <p>Check if the print resolution is set to 600 dpi.</p> <p>a From the control panel, navigate to: Settings > Print > Quality > Print Resolution</p> <p>b Print the document.</p> <p>Is the print light?</p>	<p>Go to step 5.</p>	<p>The problem is solved.</p>

Action	Yes	No
<p>Step 5</p> <p>a Remove the toner cartridge, and then remove the imaging unit.</p> <p>Warning—Potential Damage: Do not expose the imaging unit to direct light for more than 10 minutes. Extended exposure to light can cause print quality problems.</p> <p>Warning—Potential Damage: Do not touch the photoconductor drum under the imaging unit. Doing so may affect the quality of future print jobs.</p> <p>b Remove any packing material that is left on the imaging unit.</p> <p>c Firmly shake the imaging unit to redistribute the toner, and then insert it.</p> <p>d Insert the toner cartridge.</p> <p>e Turn off the printer, wait for 10 seconds, and then turn on the printer.</p> <p>f Print the document.</p> <p>Is the print light?</p>	<p>Go to step 6.</p>	<p>The problem is solved.</p>
<p>Step 6</p> <p>a If the issue happens after installing a new maintenance kit, then check whether the transfer roller included with the kit is installed.</p> <p>Note: If necessary, replace the transfer roller.</p> <p>b Print the document.</p> <p>Is the print light?</p>	<p>Go to step 7.</p>	<p>The problem is solved.</p>
<p>Step 7</p> <p>Check the status of the imaging unit. From the control panel, navigate to:</p> <p>Status/Supplies > Supplies</p> <p>Is the imaging unit near end of life?</p>	<p>Go to step 8.</p>	<p>Contact customer support.</p>
<p>Step 8</p> <p>a Replace the imaging unit.</p> <p>b Print the document.</p> <p>Is the print light?</p>	<p>Contact customer support.</p>	<p>The problem is solved.</p>

Mottled print and dots



Note: Before solving the problem, print the Print Quality Test Pages. From the control panel, navigate to **Settings > Troubleshooting > Print Quality Test Pages**. For non-touch-screen printer models, press **OK** to navigate through the settings.

Action	Yes	No
<p>Step 1</p> <p>a Check if the printer is using a genuine and supported Lexmark toner cartridge.</p> <p>Note: If the cartridge is not supported, then install a supported one.</p> <p>b Print the document.</p> <p>Is the print mottled?</p>	Go to step 2.	The problem is solved.
<p>Step 2</p> <p>Check the printer for leaked toner contamination.</p> <p>Is the printer free of leaked toner?</p>	Go to step 3.	Contact customer support .
<p>Step 3</p> <p>Check the status of the imaging unit. From the control panel, navigate to:</p> <p>Status/Supplies > Supplies</p> <p>Is the imaging unit near end of life?</p>	Go to step 4.	Contact customer support .
<p>Step 4</p> <p>a Replace the imaging unit.</p> <p>b Print the document.</p> <p>Is the print mottled?</p>	Contact customer support .	The problem is solved.

Paper curl



Note: Before solving the problem, print the Print Quality Test Pages. From the control panel, navigate to **Settings > Troubleshooting > Print Quality Test Pages**. For non-touch-screen printer models, press **OK** to navigate through the settings.

Action	Yes	No
<p>Step 1</p> <p>a Check if the printer is using a genuine and supported Lexmark toner cartridge.</p> <p>Note: If the cartridge is not supported, then install a supported one.</p> <p>b Print the document.</p> <p>Is the paper curled?</p>	Go to step 2.	The problem is solved.
<p>Step 2</p> <p>a Adjust the guides in the tray to the correct position for the paper loaded.</p> <p>b Print the document.</p> <p>Is the paper curled?</p>	Go to step 3.	The problem is solved.
<p>Step 3</p> <p>a Depending on your operating system, specify the paper size and paper type from the Printing Preferences or Print dialog.</p> <p>Notes:</p> <ul style="list-style-type: none"> • Make sure that the settings match the paper loaded. • You can also change the settings from the printer control panel. <p>b Print the document.</p> <p>Is the paper curled?</p>	Go to step 4.	The problem is solved.
<p>Step 4</p> <p>a Remove paper from the tray, and then turn over the paper.</p> <p>b Print the document.</p> <p>Is the paper curled?</p>	Go to step 5.	The problem is solved.

Action	Yes	No
<p>Step 5</p> <p>a Load paper from a fresh package.</p> <p>Note: Paper absorbs moisture due to high humidity. Store paper in its original wrapper until you are ready to use it.</p> <p>b Print the document.</p> <p>Is the paper curled?</p>	Go to step 6.	The problem is solved.
<p>Step 6</p> <p>a Check if the paper loaded is supported.</p> <p>Note: If paper is not supported, then load a supported paper.</p> <p>b Print the document.</p> <p>Is the paper curled?</p>	Contact customer support .	The problem is solved.

Print crooked or skewed



Note: Before solving the problem, print the Print Quality Test Pages. From the control panel, navigate to

Settings > Troubleshooting > Print Quality Test Pages. For non-touch-screen printer models, press  to navigate through the settings.

Action	Yes	No
<p>Step 1</p> <p>a Adjust the guides in the tray to the correct position for the paper loaded.</p> <p>b Print the document.</p> <p>Is the print crooked or skewed?</p>	Go to step 2.	The problem is solved.
<p>Step 2</p> <p>a Check if the paper loaded is supported.</p> <p>Note: If paper is not supported, then load a supported paper.</p> <p>b Print the document.</p> <p>Is the print crooked or skewed?</p>	Go to step 3.	The problem is solved.

Action	Yes	No
<p>Step 3</p> <p>a Check the pick tire in the tray for signs of damage and contamination, and replace if necessary.</p> <p>b Print the document.</p> <p>Is the print crooked or skewed?</p>	<p>Contact customer support.</p>	<p>The problem is solved.</p>

Solid black pages

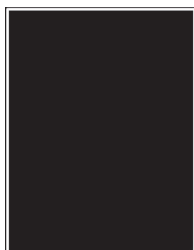

Note: Before solving the problem, print the Print Quality Test Pages. From the control panel, navigate to **Settings > Troubleshooting > Print Quality Test Pages**. For non-touch-screen printer models, press  to navigate through the settings.

Action	Yes	No
<p>Step 1</p> <p>a Check if the printer is using a genuine and supported Lexmark toner cartridge.</p> <p>Note: If the toner cartridge is not supported, then install a supported one.</p> <p>b Print the document.</p> <p>Is the printer printing solid black pages?</p>	<p>Go to step 2.</p>	<p>The problem is solved.</p>
<p>Step 2</p> <p>a Remove, and then insert the imaging unit.</p> <p>Warning—Potential Damage: Do not expose the imaging unit to direct light for more than 10 minutes. Extended exposure to light may cause print quality problems.</p> <p>Warning—Potential Damage: Do not touch the photoconductor drum under the imaging unit. Doing so may affect the quality of future print jobs.</p> <p>b Print the document.</p> <p>Is the printer printing solid black pages?</p>	<p>Go to step 3.</p>	<p>The problem is solved.</p>

Action	Yes	No
<p>Step 3</p> <p>a Remove the imaging unit.</p> <p>Warning—Potential Damage: Do not expose the imaging unit to direct light for more than 10 minutes. Extended exposure to light may cause print quality problems.</p> <p>Warning—Potential Damage: Do not touch the photoconductor drum under the imaging unit. Doing so may affect the quality of future print jobs.</p> <p>b Remove any packing material that is stuck on the imaging unit.</p> <div data-bbox="402 625 781 1178" style="text-align: center;"> </div> <p>Note: Make sure to remove any obstruction between the charge roller and photoconductor drum.</p> <p>c Insert the imaging unit.</p> <p>d Print the document.</p> <p>Is the printer printing solid black pages?</p>	<p>Go to step 4.</p>	<p>The problem is solved.</p>
<p>Step 4</p> <p>Check the imaging unit for signs of damage.</p> <p>Is the imaging unit free from damage?</p>	<p>Contact customer support.</p>	<p>Go to step 5.</p>
<p>Step 5</p> <p>a Replace the imaging unit.</p> <p>b Print the document.</p> <p>Is the printer printing solid black pages?</p>	<p>Contact customer support.</p>	<p>The problem is solved.</p>

Text or images cut off



Note: Before solving the problem, print the Print Quality Test Pages. From the control panel, navigate to **Settings > Troubleshooting > Print Quality Test Pages**. For non-touch-screen printer models, press **OK** to navigate through the settings.

Action	Yes	No
<p>Step 1</p> <p>a Check if the printer is using a genuine and supported Lexmark toner cartridge.</p> <p>Note: If the toner cartridge is not supported, then install a supported one.</p> <p>b Print the document.</p> <p>Are text or images cut off?</p>	Go to step 2.	The problem is solved.
<p>Step 2</p> <p>a Remove, and then insert the imaging unit.</p> <p>Warning—Potential Damage: Do not expose the imaging unit to direct light for more than 10 minutes. Extended exposure to light may cause print quality problems.</p> <p>Warning—Potential Damage: Do not touch the photoconductor drum under the imaging unit. Doing so may affect the quality of future print jobs.</p> <p>b Print the document.</p> <p>Are text or images cut off?</p>	Go to step 3.	The problem is solved.

Action	Yes	No
<p>Step 3</p> <p>a Remove the imaging unit.</p> <p>Warning—Potential Damage: Do not expose the imaging unit to direct light for more than 10 minutes. Extended exposure to light may cause print quality problems.</p> <p>Warning—Potential Damage: Do not touch the photoconductor drum under the imaging unit. Doing so may affect the quality of future print jobs.</p> <p>b Remove any packing material that is stuck on the imaging unit.</p> <div data-bbox="402 625 781 1178" style="text-align: center;"> </div> <p>Note: Make sure to remove any obstruction between the charge roller and photoconductor drum.</p> <p>c Insert the imaging unit.</p> <p>d Print the document.</p> <p>Are text or images cut off?</p>	<p>Go to step 4.</p>	<p>The problem is solved.</p>
<p>Step 4</p> <p>a Replace the imaging unit.</p> <p>b Print the document.</p> <p>Are text or images cut off?</p>	<p>Contact customer support.</p>	<p>The problem is solved.</p>

Toner easily rubs off



Note: Before solving the problem, print the Print Quality Test Pages. From the control panel, navigate to **Settings > Troubleshooting > Print Quality Test Pages**. For non-touch-screen printer models, press **OK** to navigate through the settings.

Action	Yes	No
<p>Step 1</p> <p>a Check if the printer is using a genuine and supported Lexmark toner cartridge.</p> <p>Note: If the cartridge is not supported, then install a supported one.</p> <p>b Print the document.</p> <p>Does toner easily rub off?</p>	Go to step 2.	The problem is solved.
<p>Step 2</p> <p>a Depending on your operating system, specify the paper type from the Printing Preferences or Print dialog.</p> <p>Notes:</p> <ul style="list-style-type: none"> • Make sure that the setting matches the paper loaded. • You can also change the setting on the printer control panel. <p>b Print the document.</p> <p>Does toner easily rub off?</p>	Go to step 3.	The problem is solved.
<p>Step 3</p> <p>a Remove, and then insert the fuser.</p> <p>b Print the document.</p> <p>Does toner easily rub off?</p>	Contact customer support .	The problem is solved.

Horizontal light bands

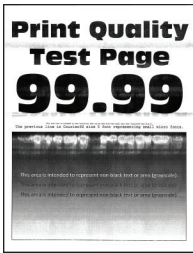

Note: Before solving the problem, print the Print Quality Test Pages. From the control panel, navigate to **Settings > Troubleshooting > Print Quality Test Pages**. For non-touch-screen printer models, press **OK** to navigate through the settings.

Action	Yes	No
<p>Step 1</p> <p>a Check if the printer is using a genuine and supported Lexmark toner cartridge.</p> <p>Note: If the cartridge is not supported, then install a supported one.</p> <p>b Print the document.</p> <p>Do horizontal light bands appear on prints?</p>	<p>Go to step 2.</p>	<p>The problem is solved.</p>
<p>Step 2</p> <p>a Turn off the printer, wait for about 10 seconds, and then turn on the printer.</p> <p>b Print the document.</p> <p>Do horizontal light bands appear on prints?</p>	<p>Contact customer support.</p>	<p>The problem is solved.</p>

Vertical light bands



Note: Before solving the problem, print the Print Quality Test Pages. From the control panel, navigate to **Settings > Troubleshooting > Print Quality Test Pages**. For non-touch-screen printer models, press **OK** to navigate through the settings.

Action	Yes	No
<p>a Check if the printer is using a genuine and supported Lexmark toner cartridge.</p> <p>Note: If the cartridge is not supported, then install a supported one.</p> <p>b Print the document.</p> <p>Do vertical light bands appear on prints?</p>	Contact customer support .	The problem is solved.

Vertical white lines



Note: Before solving the problem, print the Print Quality Test Pages. From the control panel, navigate to **Settings > Troubleshooting > Print Quality Test Pages**. For non-touch-screen printer models, press  to navigate through the settings.

Action	Yes	No
<p>Step 1</p> <p>a Check if the printer is using a genuine and supported Lexmark toner cartridge.</p> <p>Note: If the cartridge is not supported, then install a supported one.</p> <p>b Print the document.</p> <p>Do vertical white lines appear on prints?</p>	Go to step 2.	The problem is solved.
<p>Step 2</p> <p>Fix slow printing problems. For more information, see “Slow printing” on page 184.</p> <p>Do vertical white lines appear on prints?</p>	Go to step 3.	The problem is solved.
<p>Step 3</p> <p>a Replace the imaging unit.</p> <p>b Print the document.</p> <p>Do vertical white lines appear on prints?</p>	Contact customer support .	The problem is solved.

Vertical dark bands

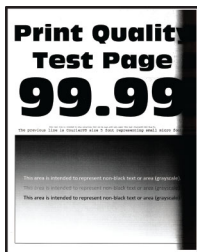

Note: Before solving the problem, print the Print Quality Test Pages. From the control panel, navigate to **Settings > Troubleshooting > Print Quality Test Pages**. For non-touch-screen printer models, press **OK** to navigate through the settings.

Action	Yes	No
<p>Step 1</p> <p>a Check if the printer is using a genuine and supported Lexmark toner cartridge.</p> <p>Note: If the toner cartridge is not supported, then install a supported one.</p> <p>b Print the document.</p> <p>Do vertical dark bands appear on prints?</p>	Go to step 2.	The problem is solved.
<p>Step 2</p> <p>a Remove the toner cartridge, and then remove the imaging unit.</p> <p>Warning—Potential Damage: Do not expose the imaging unit to direct light for more than 10 minutes. Extended exposure to light may cause print quality problems.</p> <p>Warning—Potential Damage: Do not touch the photoconductor drum under the imaging unit. Doing so may affect the quality of future print jobs.</p> <p>b Insert the imaging unit, and then insert the cartridge.</p> <p>c Print the document.</p> <p>Do vertical dark bands appear on prints?</p>	Go to step 3.	The problem is solved.

Action	Yes	No
<p>Step 3</p> <p>a Remove the imaging unit.</p> <p>Warning—Potential Damage: Do not expose the imaging unit to direct light for more than 10 minutes. Extended exposure to light may cause print quality problems.</p> <p>Warning—Potential Damage: Do not touch the photoconductor drum under the imaging unit. Doing so may affect the quality of future print jobs.</p> <p>b Remove any packing material that is stuck on the imaging unit.</p> <div data-bbox="402 625 781 1178" style="text-align: center;"> </div> <p>Note: Make sure to remove any obstruction between the charge roller and photoconductor drum.</p> <p>c Insert the imaging unit.</p> <p>d Print the document.</p> <p>Do vertical dark bands appear on prints?</p>	<p>Go to step 4.</p>	<p>The problem is solved.</p>
<p>Step 4</p> <p>a Check if a bright light enters the right side of the printer, and move the printer if necessary.</p> <p>b Print the document.</p> <p>Do vertical dark bands appear on prints?</p>	<p>Contact customer support.</p>	<p>The problem is solved.</p>

Vertical dark lines or streaks



Note: Before solving the problem, print the Print Quality Test Pages. From the control panel, navigate to **Settings > Troubleshooting > Print Quality Test Pages**. For non-touch-screen printer models, press **OK** to navigate through the settings.

Action	Yes	No
<p>Step 1</p> <p>a Check if the printer is using a genuine and supported Lexmark toner cartridge.</p> <p>Note: If the toner cartridge is not supported, then install a supported one.</p> <p>b Print the document.</p> <p>Do vertical dark lines or streaks appear on prints?</p>	Go to step 2.	The problem is solved.
<p>Step 2</p> <p>a Remove, and then reinstall the imaging unit.</p> <p>Warning—Potential Damage: Do not expose the imaging unit to direct light for more than 10 minutes. Extended exposure to light can cause print quality problems.</p> <p>Warning—Potential Damage: Do not touch the photoconductor drum under the imaging unit. Doing so may affect the quality of future print jobs.</p> <p>b Print the document.</p> <p>Do vertical dark lines or streaks appear on prints?</p>	Go to step 3.	The problem is solved.
<p>Step 3</p> <p>a Replace the imaging unit.</p> <p>b Print the document.</p> <p>Do vertical dark lines or streaks appear on prints?</p>	Contact customer support .	The problem is solved.

Vertical dark streaks with print missing

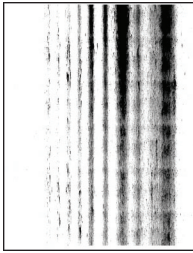

Note: Before solving the problem, print the Print Quality Test Pages. From the control panel, navigate to **Settings > Troubleshooting > Print Quality Test Pages**. For non-touch-screen printer models, press **OK** to navigate through the settings.

Action	Yes	No
<p>Step 1</p> <p>a Remove the imaging unit.</p> <p>Warning—Potential Damage: Do not expose the imaging unit to direct light for more than 10 minutes. Extended exposure to light may cause print quality problems.</p> <p>Warning—Potential Damage: Do not touch the photoconductor drum under the imaging unit. Doing so may affect the quality of future print jobs.</p> <p>b Remove any packing material that is stuck on the imaging unit.</p> <div style="text-align: center;"> </div> <p>Note: Make sure to remove any obstruction between the charge roller and photoconductor drum.</p> <p>c Insert the imaging unit.</p> <p>d Print the document.</p> <p>Do vertical dark streaks with missing images appear on prints?</p>	<p>Go to step 2.</p>	<p>The problem is solved.</p>

Action	Yes	No
<p>Step 2</p> <p>a Check if the printer is using a genuine and supported Lexmark toner cartridge.</p> <p>Note: If the toner cartridge is not supported, then install a supported one.</p> <p>b Print the document.</p> <p>Do vertical dark streaks with missing images appear on prints?</p>	<p>Contact customer support.</p>	<p>The problem is solved.</p>

Repeating defects





Note: Before solving the problem, print the Print Quality Test Pages. From the control panel, navigate to **Settings > Troubleshooting > Print Quality Test Pages**. For non-touch-screen printer models, press **OK** to navigate through the settings.

Action	Yes	No
<p>Step 1</p> <p>Using the Print Quality Test Pages, check if the distance between the repeating defects is equal to any of the following:</p> <ul style="list-style-type: none"> • 96 mm (3.78 in.) • 49 mm (1.93 in.) • 47.5 mm (1.87 in.) • 30.2 mm (1.18 in.) <p>Does the distance between the repeating defects match any of the measurements?</p>	<p>Go to step 2.</p>	<p>Take note of the distance, and then contact customer support.</p>
<p>Step 2</p> <p>a Replace the imaging unit.</p> <p>b Print the document.</p> <p>Do the repeating defects appear?</p>	<p>Contact customer support.</p>	<p>The problem is solved.</p>

Confidential and other held documents do not print

Action	Yes	No
<p>Step 1</p> <p>a From the control panel, check if the documents appear in the Held Jobs list.</p> <p>Note: If the documents are not listed, then print the documents using the Print and Hold options.</p> <p>b Print the documents.</p> <p>Are the documents printed?</p>	The problem is solved.	Go to step 2.
<p>Step 2</p> <p>The print job may contain a formatting error or invalid data.</p> <ul style="list-style-type: none"> • Delete the print job, and then send it again. • For PDF files, generate a new file, and then print the documents. <p>Are the documents printed?</p>	The problem is solved.	Go to step 3.
<p>Step 3</p> <p>If you are printing from the Internet, then the printer may be reading the multiple job titles as duplicates.</p> <p>For Windows users</p> <p>a Open the Printing Preferences dialog.</p> <p>b From the Print and Hold section, select Keep duplicate documents.</p> <p>c Enter a PIN.</p> <p>d Resend the print job.</p> <p>For Macintosh users</p> <p>a Save and name each job differently.</p> <p>b Send the job individually.</p> <p>Are the documents printed?</p>	The problem is solved.	Go to step 4.
<p>Step 4</p> <p>a Delete some held jobs to free up printer memory.</p> <p>b Resend the print job.</p> <p>Are the documents printed?</p>	The problem is solved.	Go to step 5.
<p>Step 5</p> <p>a Add printer memory.</p> <p>b Resend the print job.</p> <p>Are the documents printed?</p>	The problem is solved.	Contact customer support .

Slow printing

Action	Yes	No
<p>Step 1</p> <p>Make sure that the printer cable is securely connected to the printer and to the computer, print server, option, or other network device.</p> <p>Is the printer printing slow?</p>	Go to step 2.	The problem is solved.
<p>Step 2</p> <p>a Make sure that the printer is not in Eco-Mode or Quiet Mode.</p> <ul style="list-style-type: none"> From the control panel, navigate to: Settings > Device > Power Management > Eco-Mode From the control panel, navigate to: Settings > Device > Maintenance > Configuration Menu > Device Operations > Quiet Mode <p>For non-touch-screen printer models, press  to navigate through the settings.</p> <p>b Print the document.</p> <p>Is the printer printing slow?</p>	Go to step 3.	The problem is solved.
<p>Step 3</p> <p>a Depending on your operating system, specify the print resolution from the Printing Preferences or Print dialog.</p> <p>b Set the resolution to 600 dpi.</p> <p>c Print the document.</p> <p>Is the printer printing slow?</p>	Go to step 4.	The problem is solved.
<p>Step 4</p> <p>a From the control panel, navigate to: Settings > Print > Quality > Print Resolution</p> <p>For non-touch-screen printer models, press  to navigate through the settings.</p> <p>b Set the resolution to 600 dpi.</p> <p>c Print the document.</p> <p>Is the printer printing slow?</p>	Go to step 5.	The problem is solved.

Action	Yes	No
<p>Step 5</p> <p>a Depending on your operating system, specify the paper type from the Printing Preferences or Print dialog.</p> <p>Notes:</p> <ul style="list-style-type: none"> • Make sure that the setting matches the paper loaded. • Heavier paper prints more slowly. • Paper narrower than letter, A4, and legal may print more slowly. <p>b Print the document.</p> <p>Is the printer printing slow?</p>	Go to step 6.	The problem is solved.
<p>Step 6</p> <p>a Make sure that the printer settings for Texture and Weight match the paper being loaded.</p> <p>Note: Rough paper textures and heavy paper weights may print more slowly.</p> <p>b Print the document.</p> <p>Is the printer printing slow?</p>	Go to step 7.	The problem is solved.
<p>Step 7</p> <p>Remove held jobs.</p> <p>Is the printer printing slow?</p>	Go to step 8.	The problem is solved.
<p>Step 8</p> <p>a Make sure that the printer is not overheating.</p> <p>Notes:</p> <ul style="list-style-type: none"> • Allow the printer to cool down after a long print job. • Observe the recommended ambient temperature for the printer. For more information, see “Selecting a location for the printer” on page 10. <p>b Print the document.</p> <p>Is the printer printing slow?</p>	Go to step 9.	The problem is solved.
<p>Step 9</p> <p>a Add more printer memory.</p> <p>b Print the document.</p> <p>Is the printer printing slow?</p>	Contact customer support .	The problem is solved.

Print jobs do not print

Action	Yes	No
<p>Step 1</p> <p>a From the document you are trying to print, open the Print dialog, and then check if you have selected the correct printer.</p> <p>b Print the document.</p> <p>Is the document printed?</p>	The problem is solved.	Go to step 2.
<p>Step 2</p> <p>a Check if the printer is on.</p> <p>b Resolve any error messages that appear on the display.</p> <p>c Print the document.</p> <p>Is the document printed?</p>	The problem is solved.	Go to step 3.
<p>Step 3</p> <p>a Check if the ports are working and if the cables are securely connected to the computer and the printer. For more information, see the setup documentation that came with the printer.</p> <p>b Print the document.</p> <p>Is the document printed?</p>	The problem is solved.	Go to step 4.
<p>Step 4</p> <p>a Turn off the printer, wait for about 10 seconds, and then turn on the printer.</p> <p>b Print the document.</p> <p>Is the document printed?</p>	The problem is solved.	Go to step 5.
<p>Step 5</p> <p>a Remove, and then reinstall the print driver.</p> <p>b Print the document.</p> <p>Is the document printed?</p>	The problem is solved.	Contact customer support .

The printer is not responding

Action	Yes	No
<p>Step 1 Check if the power cord is connected to the electrical outlet.</p> <p> CAUTION—POTENTIAL INJURY: To avoid the risk of fire or electrical shock, connect the power cord to an appropriately rated and properly grounded electrical outlet that is near the product and easily accessible.</p> <p>Is the printer responding?</p>	The problem is solved.	Go to step 2.
<p>Step 2 Check if the electrical outlet is turned off by a switch or breaker.</p> <p>Is the electrical outlet turned off by a switch or breaker?</p>	Turn on the switch or reset the breaker.	Go to step 3.
<p>Step 3 Check if the printer is on.</p> <p>Is the printer on?</p>	Go to step 4.	Turn on the printer.
<p>Step 4 Check if the printer is in Sleep or Hibernate mode.</p> <p>Is the printer in Sleep or Hibernate mode?</p>	Press the power button to wake the printer.	Go to step 5.
<p>Step 5 Check if the cables connecting the printer and the computer are inserted to the correct ports.</p> <p>Are the cables inserted to the correct ports?</p>	Go to step 6.	Insert the cables to the correct ports.
<p>Step 6 Turn off the printer, install the hardware options, and then turn on the printer. For more information, see the documentation that came with the option.</p> <p>Is the printer responding?</p>	The problem is solved.	Go to step 7.
<p>Step 7 Install the correct print driver.</p> <p>Is the printer responding?</p>	The problem is solved.	Go to step 8.
<p>Step 8 Turn off the printer, wait for about 10 seconds, and then turn on the printer.</p> <p>Is the printer responding?</p>	The problem is solved.	Contact customer support .

Adjusting toner darkness

- 1 From the control panel, navigate to:
Settings > Print > Quality > Toner Darkness

For non-touch-screen printer models, press  to navigate through the settings.

- 2 Adjust the setting.
- 3 Apply the changes.

Job prints from the wrong tray or on the wrong paper

Action	Yes	No
<p>Step 1</p> <p>a Check if you are printing on the correct paper.</p> <p>b Print the document.</p> <p>Is the document printed on the correct paper?</p>	Go to step 2.	Load the correct paper size and paper type.
<p>Step 2</p> <p>a Depending on your operating system, specify the paper size and paper type from the Printing Preferences or Print dialog.</p> <p>Note: You can also change the settings on the printer control panel. Navigate to: Settings > Paper > Tray Configuration > Paper Size/Type</p> <p>For non-touch-screen printer models, press  to navigate through the settings.</p> <p>b Make sure that the settings match the paper loaded.</p> <p>c Print the document.</p> <p>Is the document printed on the correct paper?</p>	The problem is solved.	Go to step 3.
<p>Step 3</p> <p>a Check if the trays are linked. For more information, see “Linking trays” on page 35.</p> <p>b Print the document.</p> <p>Is the document printed from the correct tray?</p>	The problem is solved.	Contact customer support .

Contacting customer support

Before contacting customer support, make sure to have the following information:

- Printer problem
- Error message
- Printer model type and serial number

Go to <http://support.lexmark.com> to receive e-mail or chat support, or browse through the library of manuals, support documentation, drivers, and other downloads.

Technical support via telephone is also available. In the U.S. or Canada, call 1-800-539-6275. For other countries or regions, go to <http://support.lexmark.com>.

Upgrading and migrating

Hardware

Available internal options

- Flash memory
- Font cards
- Firmware cards
 - Forms and Bar Code
 - PRESCRIBE
 - IPDS
- Printer hard disk
- Internal solutions port
 - Parallel 1284-B Interface Card
 - RS-232C Serial Interface Card
 - Fiber Interface Card
 - N8370 802.11a/b/g/n Wireless Print Server Interface Card

Accessing the controller board



CAUTION—SHOCK HAZARD: To avoid the risk of electrical shock, if you are accessing the controller board or installing optional hardware or memory devices sometime after setting up the printer, then turn the printer off, and unplug the power cord from the electrical outlet before continuing. If you have any other devices attached to the printer, then turn them off as well, and unplug any cables going into the printer.

- 1 Turn off the printer.
- 2 Unplug the power cord from the electrical outlet, and then from the printer.
- 3 Using a flat-head screwdriver, open the controller board access cover.

Warning—Potential Damage: Controller board electronic components are easily damaged by static electricity. Touch a metal surface on the printer before touching any controller board components or connectors.

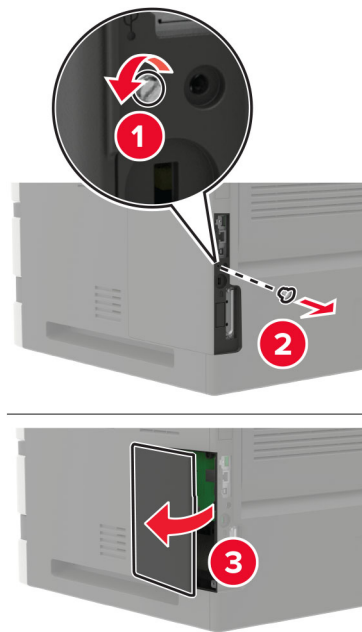

- 4 Install any supported internal options. For more information, see the documentation that came with the option.
- 5 Close the access cover.
- 6 Connect the power cord to the printer, and then to the electrical outlet.

⚠ CAUTION—POTENTIAL INJURY: To avoid the risk of fire or electrical shock, connect the power cord to an appropriately rated and properly grounded electrical outlet that is near the product and easily accessible.

- 7 Turn on the printer.

Installing a memory card

⚠ CAUTION—SHOCK HAZARD: To avoid the risk of electrical shock, if you are accessing the controller board or installing optional hardware or memory devices sometime after setting up the printer, then turn the printer off, and unplug the power cord from the electrical outlet before continuing. If you have any other devices attached to the printer, then turn them off as well, and unplug any cables going into the printer.

- 1 Turn off the printer.
- 2 Unplug the power cord from the electrical outlet, and then from the printer.
- 3 Using a flat-head screwdriver, open the controller board access cover.

Warning—Potential Damage: Controller board electronic components are easily damaged by static electricity. Touch a metal surface on the printer before touching any controller board components or connectors.

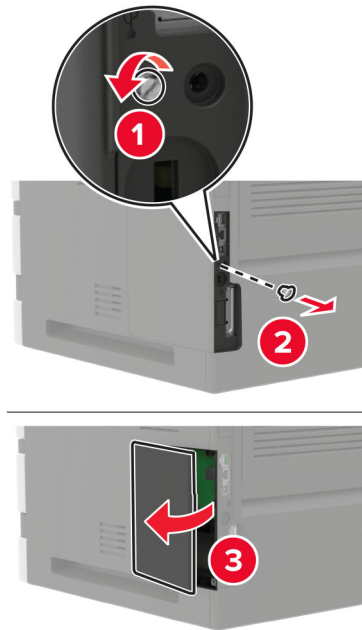

- 4 Unpack the memory card.

Warning—Potential Damage: Do not touch the connection points along the edge of the card.

- 5 Insert the memory card until it *clicks* into place.

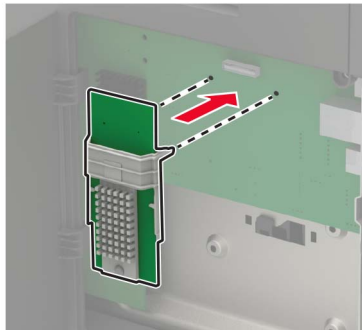

- 6 Close the access cover.
- 7 Connect the power cord to the printer, and then to the electrical outlet.

CAUTION—POTENTIAL INJURY: To avoid the risk of fire or electrical shock, connect the power cord to an appropriately rated and properly grounded electrical outlet that is near the product and easily accessible.

- 8 Turn on the printer.

Installing an optional card

⚠ CAUTION—SHOCK HAZARD: To avoid the risk of electrical shock, if you are accessing the controller board or installing optional hardware or memory devices sometime after setting up the printer, then turn the printer off, and unplug the power cord from the electrical outlet before continuing. If you have any other devices attached to the printer, then turn them off as well, and unplug any cables going into the printer.

- 1 Turn off the printer.
- 2 Unplug the power cord from the electrical outlet, and then from the printer.
- 3 Using a flat-head screwdriver, open the controller board access cover.

Warning—Potential Damage: Controller board electronic components are easily damaged by static electricity. Touch a metal surface on the printer before touching any components or connectors.

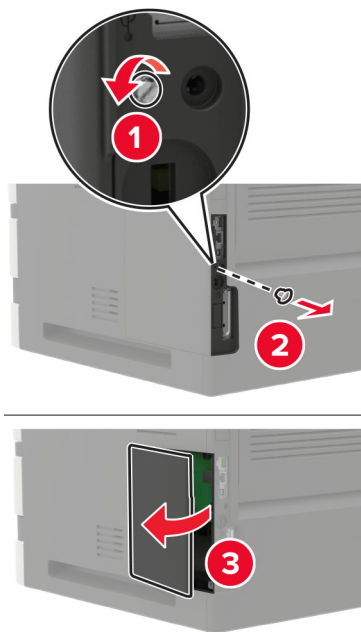

- 4 Unpack the optional card.

Warning—Potential Damage: Do not touch the connection points along the edge of the card.

- 5 Push the card firmly into place.

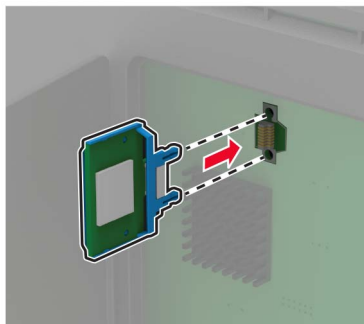

Note: The entire length of the connector on the card must touch and be flush against the controller board.

Warning—Potential Damage: Improper installation of the card may cause damage to the card and the controller board.

- 6 Close the access cover.
- 7 Connect the power cord to the printer, and then to the electrical outlet.

CAUTION—POTENTIAL INJURY: To avoid the risk of fire or electrical shock, connect the power cord to an appropriately rated and properly grounded electrical outlet that is near the product and easily accessible.

- 8 Turn on the printer.

Installing a printer hard disk

CAUTION—SHOCK HAZARD: To avoid the risk of electrical shock, if you are accessing the controller board or installing optional hardware or memory devices sometime after setting up the printer, then turn the printer off, and unplug the power cord from the electrical outlet before continuing. If you have any other devices attached to the printer, then turn them off as well, and unplug any cables going into the printer.

- 1 Turn off the printer.
- 2 Unplug the power cord from the electrical outlet, and then from the printer.
- 3 Using a flat-head screwdriver, open the controller board access cover.

Warning—Potential Damage: Controller board electronic components are easily damaged by static electricity. Touch a metal surface on the printer before touching any controller board components or connectors.

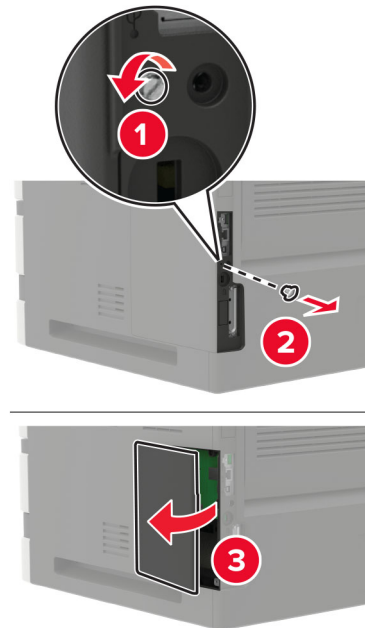

- 4 Unpack the printer hard disk.

- 5 Attach the hard disk, and then connect the hard disk interface cable to the controller board.

Warning—Potential Damage: Do not touch or press the center of the hard disk.

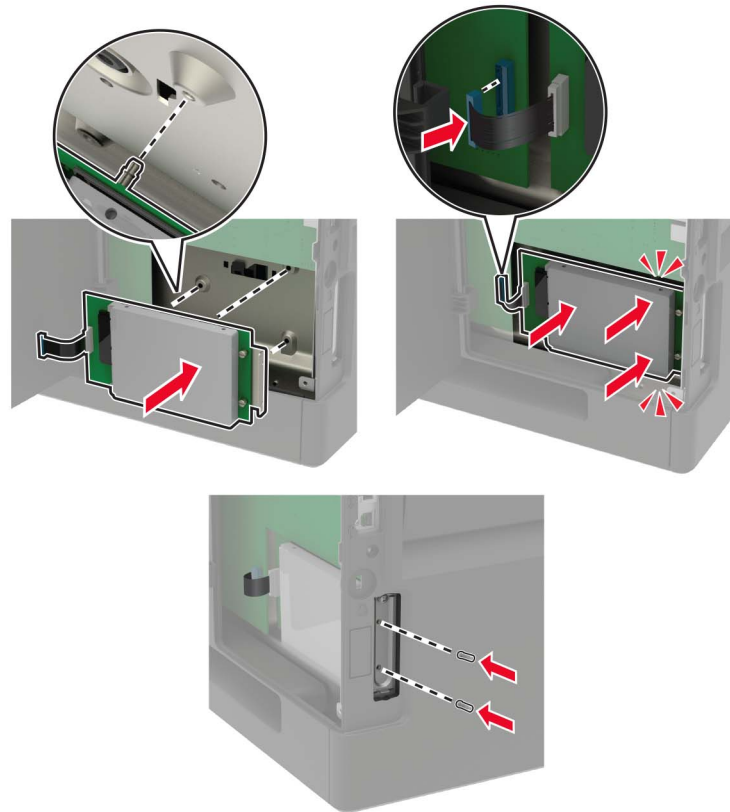

- 6 Close the access cover.
- 7 Connect the power cord to the printer, and then to the electrical outlet.

CAUTION—POTENTIAL INJURY: To avoid the risk of fire or electrical shock, connect the power cord to an appropriately rated and properly grounded electrical outlet that is near the product and easily accessible.

- 8 Turn on the printer.

Installing an internal solutions port

CAUTION—SHOCK HAZARD: To avoid the risk of electrical shock, if you are accessing the controller board or installing optional hardware or memory devices sometime after setting up the printer, then turn the printer off, and unplug the power cord from the electrical outlet before continuing. If you have any other devices attached to the printer, then turn them off as well, and unplug any cables going into the printer.

- 1 Turn off the printer, and then unplug the power cord from the electrical outlet.
- 2 Using a flat-head screwdriver, open the controller board access cover.

Warning—Potential Damage: Controller board electronic components are easily damaged by static electricity. Touch a metal surface on the printer before touching any controller board components or connectors.

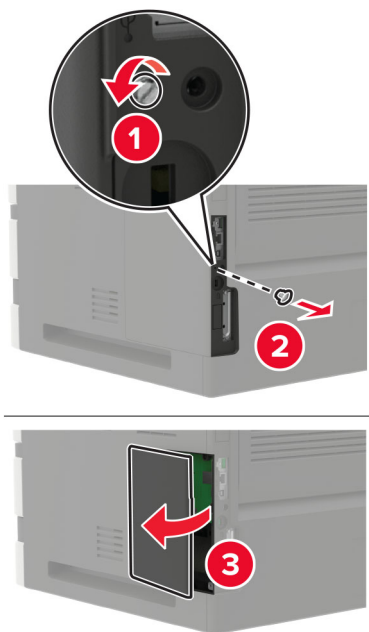

3 Unpack the internal solutions port (ISP) kit.

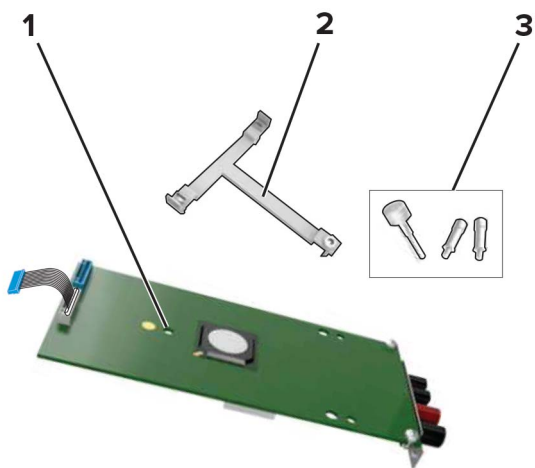

1	ISP
2	Mounting bracket
3	Thumbscrews

4 If necessary, remove the printer hard disk.

5 Insert the bracket into the board until it *clicks* into place.

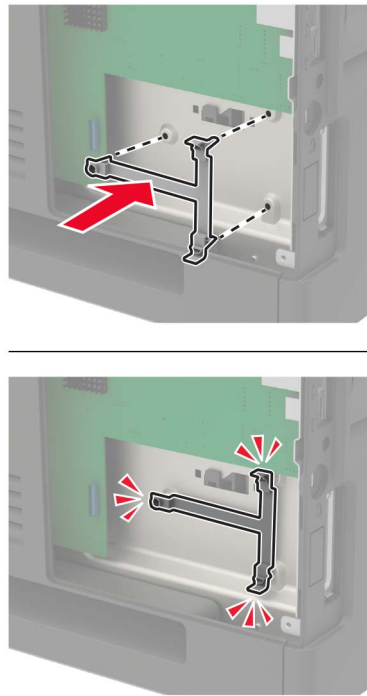

6 Attach the ISP to the bracket.

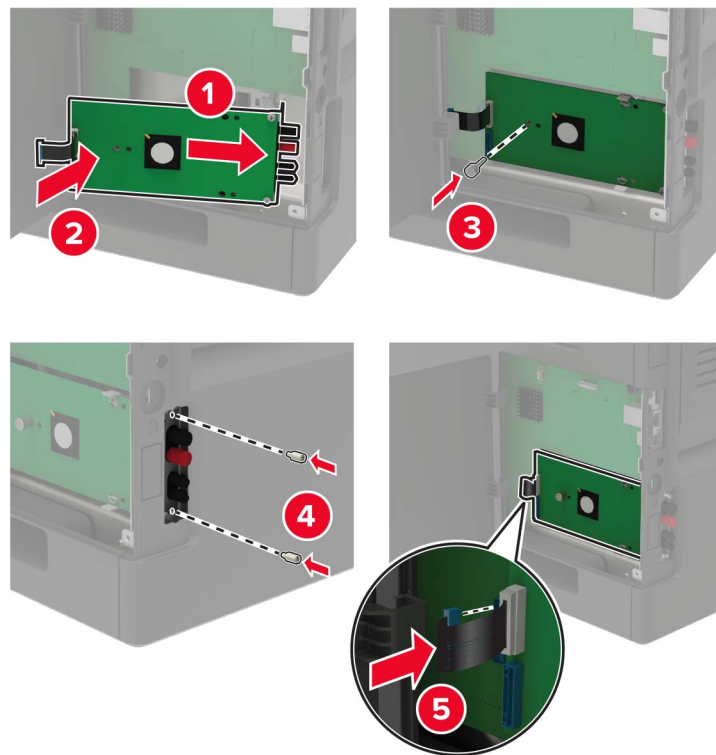

7 If necessary, attach the hard disk to the ISP.

a Remove the hard disk bracket.

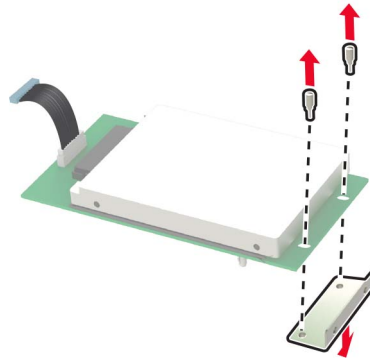

b Connect the hard disk to the ISP.

Warning—Potential Damage: Do not touch or press the center of the hard disk.

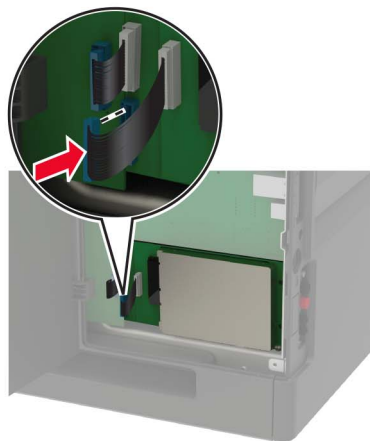
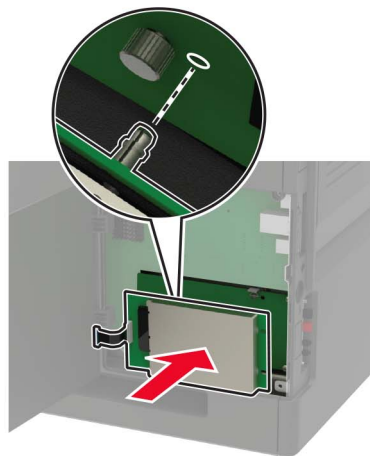

- 8 Close the access cover.
- 9 Connect the power cord to the electrical outlet, and then turn on the printer.

⚠ CAUTION—POTENTIAL INJURY: To avoid the risk of fire or electrical shock, connect the power cord to an appropriately rated and properly grounded electrical outlet that is near the product and easily accessible.

Installing the 250- or 550-sheet tray

⚠ CAUTION—SHOCK HAZARD: To avoid the risk of electrical shock, if you are accessing the controller board or installing optional hardware or memory devices sometime after setting up the printer, then turn the printer off, and unplug the power cord from the electrical outlet before continuing. If you have any other devices attached to the printer, then turn them off as well, and unplug any cables going into the printer.

⚠ CAUTION—TIPPING HAZARD: Installing one or more options on your printer or MFP may require a caster base, furniture, or other feature to prevent instability causing possible injury. For more information on supported configurations, see www.lexmark.com/multifunctionprinters.

- 1 Turn off the printer.
- 2 Unplug the power cord from the electrical outlet, and then from the printer.
- 3 Unpack the optional tray, and then remove all packing material.

Note: If optional trays are already installed, then unlock them from the printer before lifting the printer. Do not try to lift the printer and trays at the same time.

- 4 Align the printer with the optional tray, and then lower the printer until it *clicks* into place.

⚠ CAUTION—POTENTIAL INJURY: If the printer weight is greater than 18 kg (40 lb), then it requires two or more trained personnel to lift it safely.

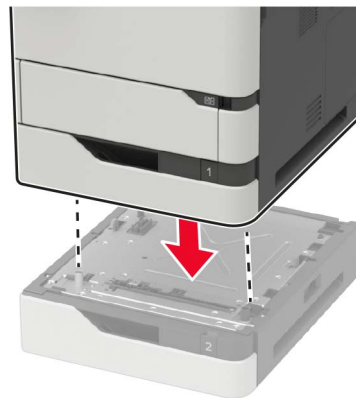

- 5 Connect the power cord to the printer, and then to the electrical outlet.

⚠ CAUTION—POTENTIAL INJURY: To avoid the risk of fire or electrical shock, connect the power cord to an appropriately rated and properly grounded electrical outlet that is near the product and easily accessible.

- 6 Turn on the printer.

Add the tray in the print driver to make it available for print jobs. For more information, see [“Adding available options in the print driver” on page 216](#).

Installing the 2100-sheet tray

⚠ CAUTION—SHOCK HAZARD: To avoid the risk of electrical shock, if you are accessing the controller board or installing optional hardware or memory devices sometime after setting up the printer, then turn the printer off, and unplug the power cord from the electrical outlet before continuing. If you have any other devices attached to the printer, then turn them off as well, and unplug any cables going into the printer.

⚠ CAUTION—TIPPING HAZARD: Installing one or more options on your printer or MFP may require a caster base, furniture, or other feature to prevent instability causing possible injury. For more information on supported configurations, see www.lexmark.com/multifunctionprinters.

- 1 Turn off the printer.
- 2 Unplug the power cord from the electrical outlet, and then from the printer.
- 3 Unpack the tray, and then remove all packing material.

Note: If optional trays are already installed, then unlock them from the printer before lifting the printer. Do not try to lift the printer and trays at the same time.

- 4 Install the tray on the caster base.

Note: Make sure that the caster base wheels are locked.

⚠ CAUTION—POTENTIAL INJURY: If the tray weight is greater than 18 kg (40 lb), then it requires two or more trained personnel to lift it safely.

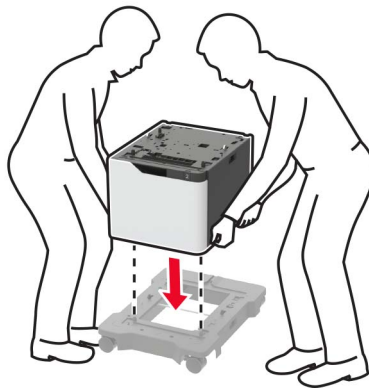

- 5 Align the printer with the tray, and then lower the printer until it *clicks* into place.

⚠ CAUTION—POTENTIAL INJURY: If the printer weight is greater than 18 kg (40 lb), then it requires two or more trained personnel to lift it safely.

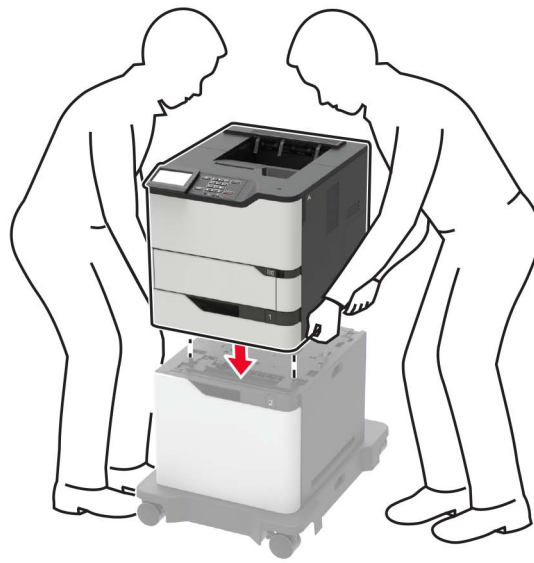

6 Connect the power cord to the printer, and then to the electrical outlet.

⚠ CAUTION—POTENTIAL INJURY: To avoid the risk of fire or electrical shock, connect the power cord to an appropriately rated and properly grounded electrical outlet that is near the product and easily accessible.

7 Turn on the printer.

Add the tray in the print driver to make it available for print jobs. For more information, see [“Adding available options in the print driver” on page 216](#).

Installing the 4-bin mailbox

⚠ CAUTION—TIPPING HAZARD: Installing one or more options on your printer or MFP may require a caster base, furniture, or other feature to prevent instability causing possible injury. For more information on supported configurations, see www.lexmark.com/multifunctionprinters.

- 1 Turn off the printer.
- 2 Unplug the power cord from the electrical outlet, and then from the printer.
- 3 Unpack the mailbox.
- 4 Attach the guide bar to the mailbox.

Note: When installing multiple options, attach the guide bar only to the option that is connected directly to the printer.

- a Position the mailbox on its side.

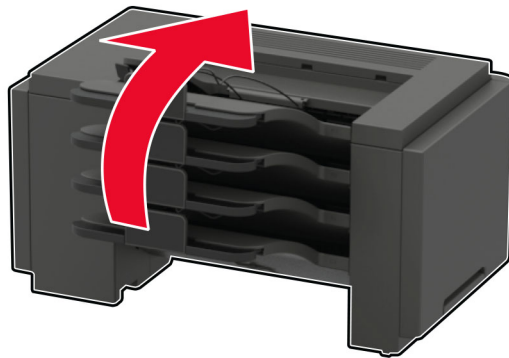

b Insert the tabs of the guide bar into the mailbox.

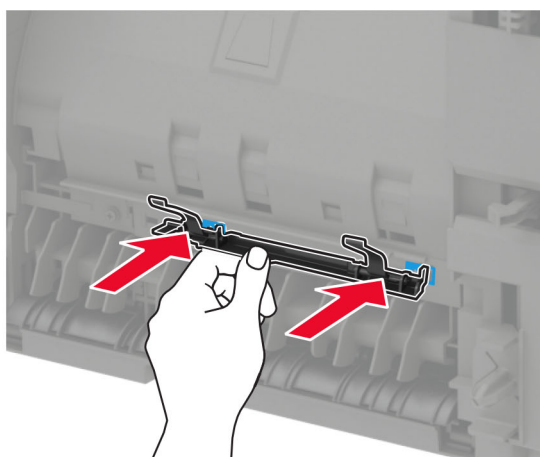
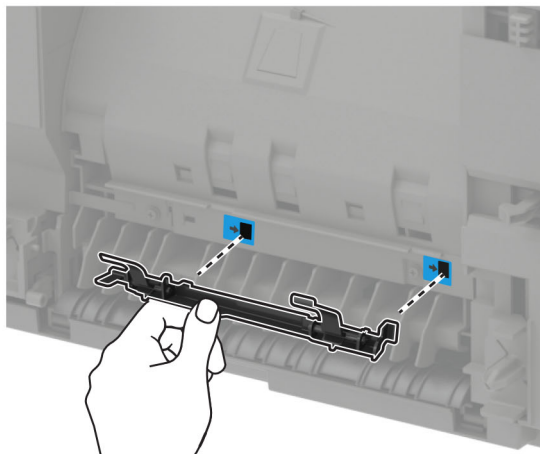

c Slide the guide bar to the right until it *clicks* into place.

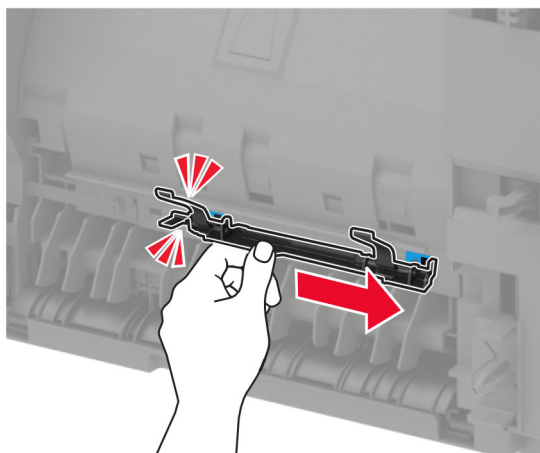

5 Remove the printer top cover.

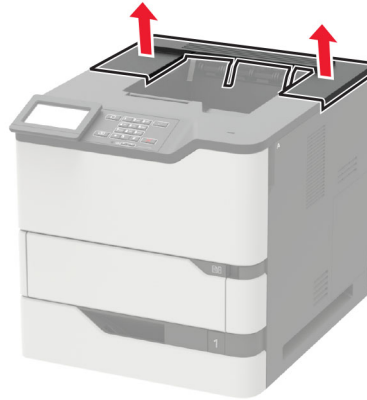

6 Install the mailbox on the printer.

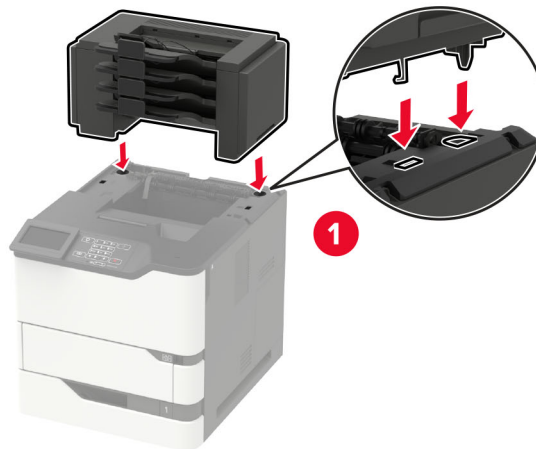

- A maximum of three mailboxes may be configured with the printer.
- When configured with the output expander, the mailbox and output expander may be installed in any order.

7 Connect the power cord to the printer, and then to the electrical outlet.

⚠ CAUTION—POTENTIAL INJURY: To avoid the risk of fire or electrical shock, connect the power cord to an appropriately rated and properly grounded electrical outlet that is near the product and easily accessible.

8 Turn on the printer.

Add the mailbox in the print driver to make it available for print jobs. For more information, see [“Adding available options in the print driver” on page 216](#).

Installing the output expander or high-capacity output expander

⚠ CAUTION—TIPPING HAZARD: Installing one or more options on your printer or MFP may require a caster base, furniture, or other feature to prevent instability causing possible injury. For more information on supported configurations, see www.lexmark.com/multifunctionprinters.

1 Turn off the printer.

2 Unplug the power cord from the electrical outlet, and then from the printer.

3 Unpack the output expander or high-capacity output expander.

4 Attach the guide bar to the output expander or high-capacity output expander.

Note: When installing multiple options, attach the guide bar only to the option that is connected directly to the printer.

a Position the output expander on its side.

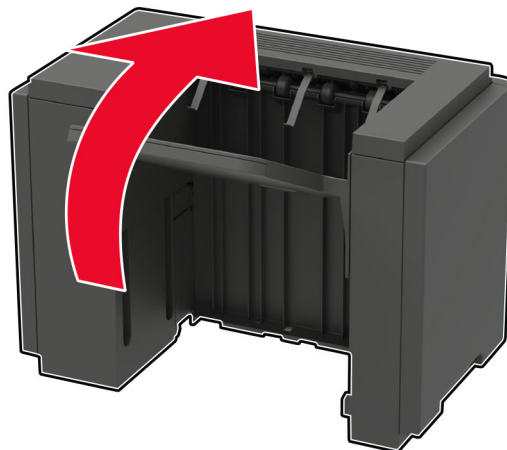

b Insert the tabs of the guide bar into the output expander.

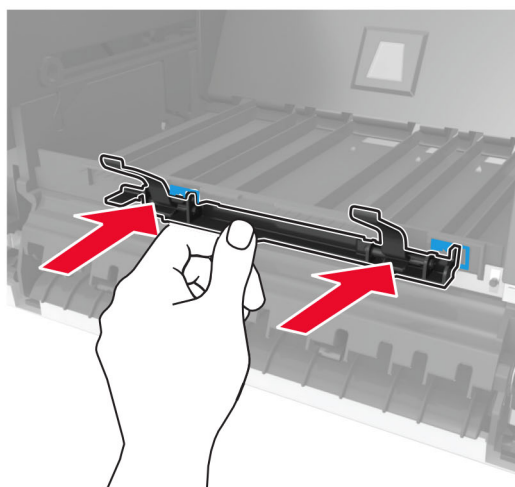
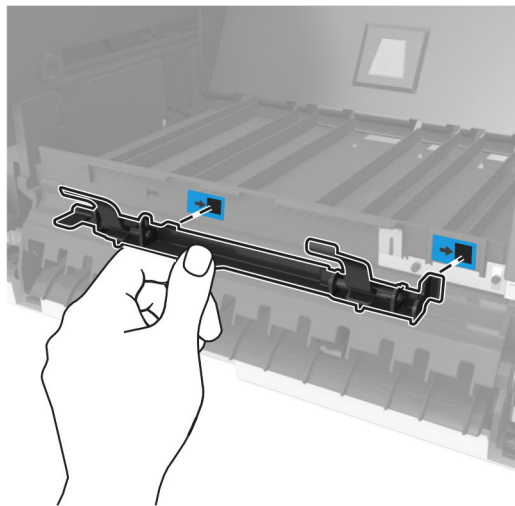

- c Slide the guide bar to the right until it *clicks* into place.

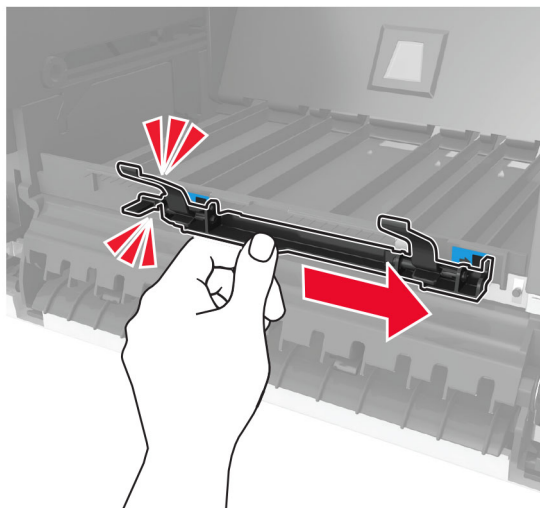

- 5 Remove the printer top cover.

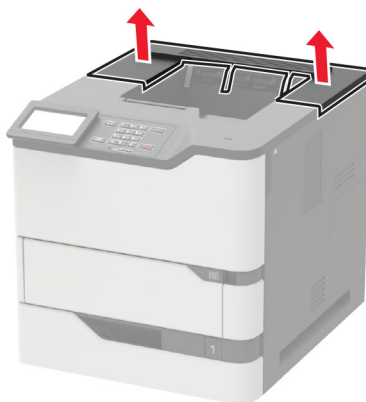

6 Install the output expander on the printer.

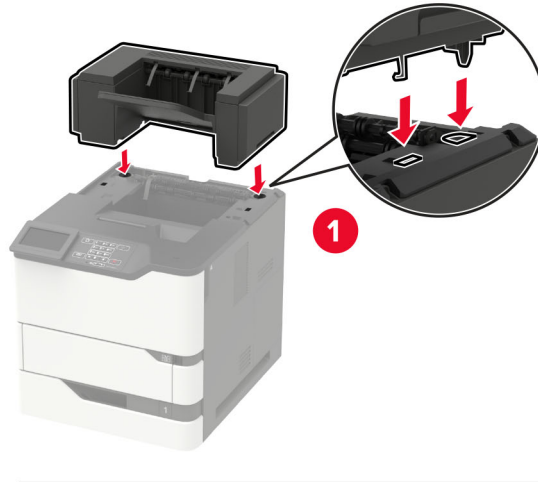

In configuration with two or more hardware options:

- The output expander is the only option that can be placed on top of the high-capacity output expander.
- The high-capacity output expander must always be at the bottom of the configuration.

7 Connect the power cord to the printer, and then to the electrical outlet.

⚠ CAUTION—POTENTIAL INJURY: To avoid the risk of fire or electrical shock, connect the power cord to an appropriately rated and properly grounded electrical outlet that is near the product and easily accessible.

8 Turn on the printer.

Add the output expander in the print driver to make it available for print jobs. For more information, see [“Adding available options in the print driver” on page 216.](#)

Installing the staple finisher

CAUTION—TIPPING HAZARD: Installing one or more options on your printer or MFP may require a caster base, furniture, or other feature to prevent instability causing possible injury. For more information on supported configurations, see www.lexmark.com/multifunctionprinters.

- 1 Turn off the printer.
- 2 Unplug the power cord from the electrical outlet, and then from the printer.
- 3 Unpack the staple finisher.
- 4 Attach the guide bar to the staple finisher.

Note: When installing multiple options, attach the guide bar only to the option that is connected directly to the printer.

- a Position the staple finisher on its side.

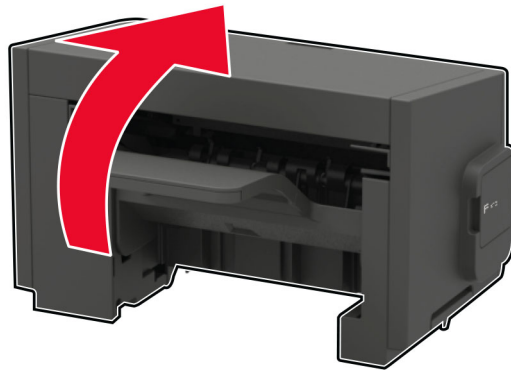

- b** Insert the tabs of the guide bar into the staple finisher.

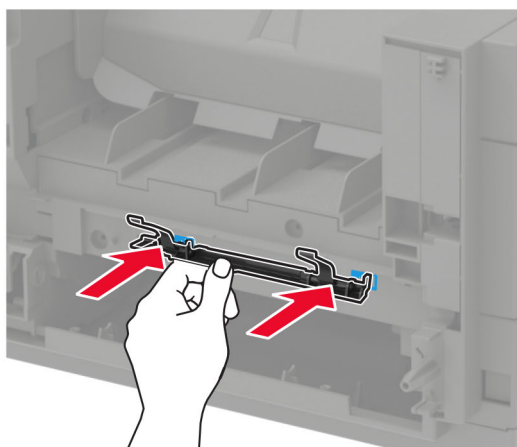
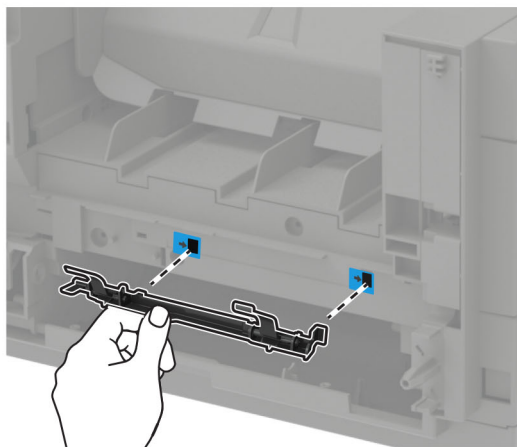

- c** Slide the guide bar to the right until it *clicks* into place.

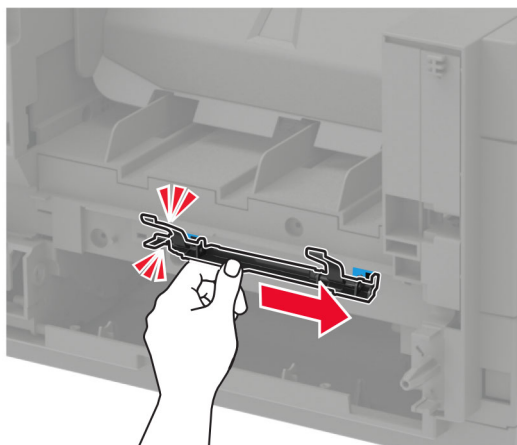

5 Remove the printer top cover.

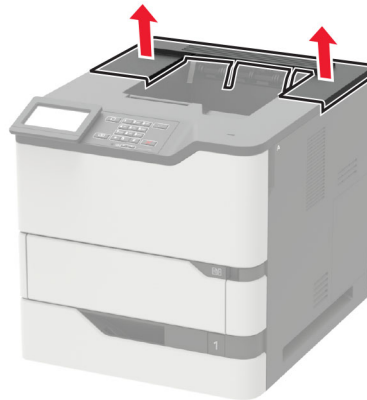

6 Install the staple finisher on the printer.

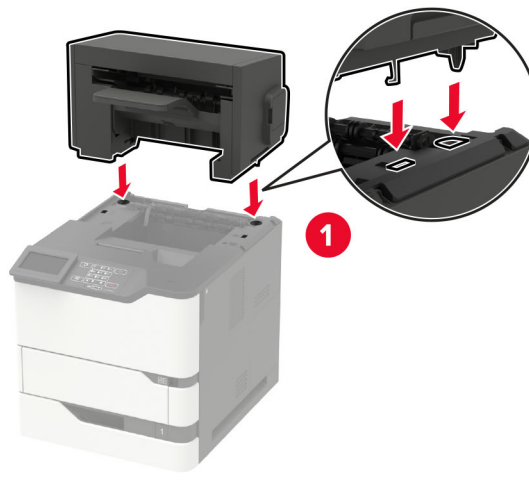

When configured with two or more options, the staple finisher must always be on top.

7 Connect the power cord to the printer, and then to the electrical outlet.

⚠ CAUTION—POTENTIAL INJURY: To avoid the risk of fire or electrical shock, connect the power cord to an appropriately rated and properly grounded electrical outlet that is near the product and easily accessible.

8 Turn on the printer.

Add the staple finisher in the print driver to make it available for print jobs. For more information, see [“Adding available options in the print driver” on page 216](#).

Installing the staple, hole punch finisher

⚠ CAUTION—TIPPING HAZARD: Installing one or more options on your printer or MFP may require a caster base, furniture, or other feature to prevent instability causing possible injury. For more information on supported configurations, see www.lexmark.com/multifunctionprinters.

1 Turn off the printer.

2 Unplug the power cord from the electrical outlet, and then from the printer.

3 Unpack the staple, hole punch finisher.

4 Attach the guide bar to the staple, hole punch finisher.

Note: When installing multiple options, attach the guide bar only to the option that is connected directly to the printer.

a Position the staple, hole punch finisher on its side.

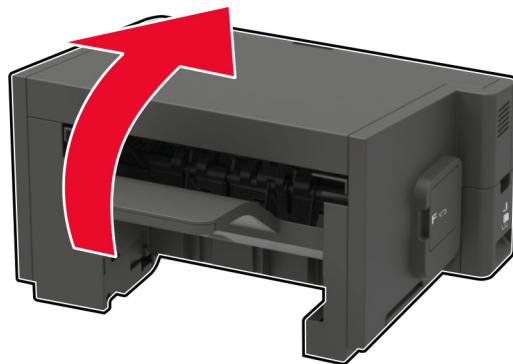

- b** Insert the tabs of the guide bar into the staple, hole punch finisher.

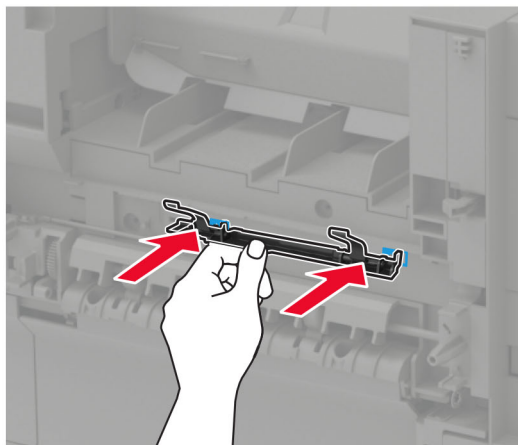
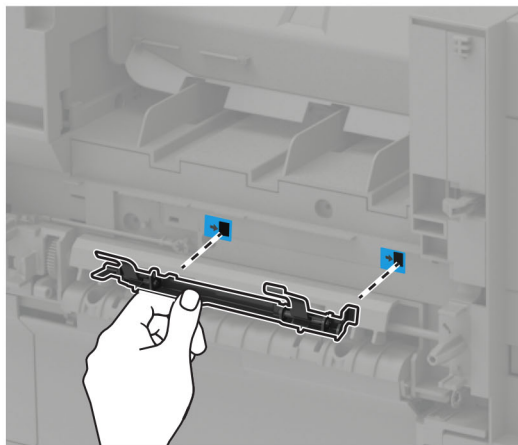

- c** Slide the guide bar to the right until it *clicks* into place.

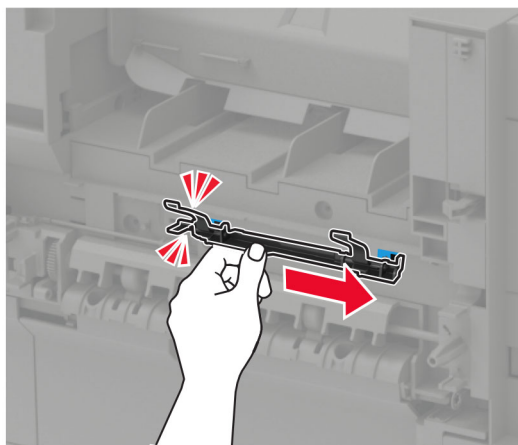

5 Remove the printer top cover.



6 Install the finisher on the printer.

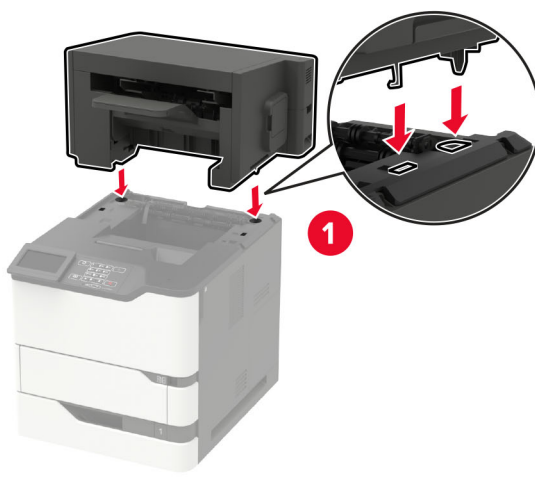

The finisher must not be combined with any other options.

7 Connect the power cord to the printer, and then to the electrical outlet.



CAUTION—POTENTIAL INJURY: To avoid the risk of fire or electrical shock, connect the power cord to an appropriately rated and properly grounded electrical outlet that is near the product and easily accessible.

8 Turn on the printer.

Add the finisher in the print driver to make it available for print jobs. For more information, see [“Adding available options in the print driver” on page 216](#).

Software

Supported operating systems

Using the software CD, you can install the printer software on the following operating systems:

- Windows 10
- Windows 8.1
- Windows Server 2012 R2
- Windows Server 2012
- Windows 7 SP1
- Windows Server 2008 R2 SP1
- Windows Server 2008 SP2
- Windows Vista SP2
- Mac OS X version 10.7 or later
- Red Hat Enterprise Linux WS
- openSUSE Linux
- SUSE Linux Enterprise Server
- Debian GNU/Linux
- Ubuntu
- Fedora
- IBM AIX
- Oracle Solaris SPARC
- Oracle Solaris x86

Notes:

- For Windows operating systems, the print drivers and utilities are supported in both 32- and 64-bit versions.
- For drivers and utilities that are compatible with Mac OS X version 10.6 or earlier and for specific supported Linux or UNIX operating system versions, go to <http://support.lexmark.com>.
- For more information on software compatibility with all other operating systems, contact customer support.

Installing the printer software

- 1 Obtain a copy of the software installer package.
 - From the software CD that came with your printer.
 - Go to <http://support.lexmark.com>, and then select your printer and operating system.
- 2 Run the installer, and then follow the instructions on the computer screen.
- 3 For Macintosh users, add the printer.

Note: Obtain the printer IP address from the TCP/IP section in the Network/Ports menu.

Adding available options in the print driver

For Windows users

- 1 Open the printers folder.
- 2 Select the printer you want to update, and then do either of the following:
 - For Windows 7 or later, select **Printer properties**.
 - For earlier versions, select **Properties**.
- 3 Navigate to the Configuration tab, and then select **Update Now - Ask Printer**.
- 4 Apply the changes.

For Macintosh users

- 1 From System Preferences in the Apple menu, navigate to your printer, and then select **Options & Supplies**.
- 2 Navigate to the list of hardware options, and then add any installed options.
- 3 Apply the changes.

Firmware

Exporting or importing a configuration file

You can export the configuration settings of your printer into a text file, and then import the file to apply the settings to other printers.

- 1 Open a web browser, and then type the printer IP address in the address field.

Notes:

- View the printer IP address on the printer home screen. The IP address appears as four sets of numbers separated by periods, such as 123.123.123.123.
 - If you are using a proxy server, then temporarily disable it to load the web page correctly.
- 2 Export or import a configuration file for one or multiple applications.

For one application

- a** From the Embedded Web Server, click **Apps** > the application that you want > **Configure**.
- b** Click **Export** or **Import**.

For multiple applications

- a** From the Embedded Web Server, click **Export Configuration** or **Import Configuration**.
- b** Follow the instructions on the screen.

Updating firmware

Some applications require a minimum device firmware level to operate correctly.

For more information on updating the device firmware, contact your Lexmark representative.

- 1** From the Embedded Web Server, click **Settings** > **Device** > **Update Firmware**.
- 2** Browse to locate the required flash file.
- 3** Apply the changes.

Notices

Product information

Product name:

Lexmark B2865dw, Lexmark M5255, Lexmark M5270, Lexmark MS725dvn; Lexmark MS821n, Lexmark MS821dn; Lexmark MS822de; Lexmark MS823n, Lexmark MS823dn; Lexmark MS825dn, Lexmark MS826de printers

Machine type:

4064

Model(s):

210, 230, 235, 295, 410, 430, 438, 630, 635, 695, 830

Edition notice

August 2019

The following paragraph does not apply to any country where such provisions are inconsistent with local law: LEXMARK INTERNATIONAL, INC., PROVIDES THIS PUBLICATION "AS IS" WITHOUT WARRANTY OF ANY KIND, EITHER EXPRESS OR IMPLIED, INCLUDING, BUT NOT LIMITED TO, THE IMPLIED WARRANTIES OF MERCHANTABILITY OR FITNESS FOR A PARTICULAR PURPOSE. Some states do not allow disclaimer of express or implied warranties in certain transactions; therefore, this statement may not apply to you.

This publication could include technical inaccuracies or typographical errors. Changes are periodically made to the information herein; these changes will be incorporated in later editions. Improvements or changes in the products or the programs described may be made at any time.

References in this publication to products, programs, or services do not imply that the manufacturer intends to make these available in all countries in which it operates. Any reference to a product, program, or service is not intended to state or imply that only that product, program, or service may be used. Any functionally equivalent product, program, or service that does not infringe any existing intellectual property right may be used instead. Evaluation and verification of operation in conjunction with other products, programs, or services, except those expressly designated by the manufacturer, are the user's responsibility.

For Lexmark technical support, go to <http://support.lexmark.com>.

For information on Lexmark's privacy policy governing the use of this product, go to www.lexmark.com/privacy.

For information on supplies and downloads, go to www.lexmark.com.

© 2018 Lexmark International, Inc.

All rights reserved.

GOVERNMENT END USERS

The Software Program and any related documentation are "Commercial Items," as that term is defined in 48 C.F.R. 2.101, "Computer Software" and "Commercial Computer Software Documentation," as such terms are used in 48 C.F.R. 12.212 or 48 C.F.R. 227.7202, as applicable. Consistent with 48 C.F.R. 12.212 or 48 C.F.R.

227.7202-1 through 227.7207-4, as applicable, the Commercial Computer Software and Commercial Software Documentation are licensed to the U.S. Government end users (a) only as Commercial Items and (b) with only those rights as are granted to all other end users pursuant to the terms and conditions herein.

Trademarks

Lexmark and the Lexmark logo are trademarks or registered trademarks of Lexmark International, Inc. in the United States and/or other countries.

Google Cloud Print and Google Chrome are trademarks of Google Inc. Android and Google Play are trademarks of Google LLC.

Macintosh, Mac, App Store, and Safari are trademarks of Apple Inc. AirPrint and the AirPrint logo are trademarks of Apple, Inc.

Microsoft, Windows, and Internet Explorer are either registered trademarks or trademarks of the Microsoft group of companies in the United States and other countries.

Mopria®, the Mopria® logo, and the Mopria® Alliance logo are registered trademarks and service marks of Mopria Alliance, Inc. in the United States and other countries. Unauthorized use is strictly prohibited.

PCL® is a registered trademark of the Hewlett-Packard Company. PCL is Hewlett-Packard Company’s designation of a set of printer commands (language) and functions included in its printer products. This printer is intended to be compatible with the PCL language. This means the printer recognizes PCL commands used in various application programs, and that the printer emulates the functions corresponding to the commands.

PostScript is a registered trademark of Adobe Systems Incorporated in the United States and/or other countries.

All other trademarks are the property of their respective owners.

Licensing notices

All licensing notices associated with this product can be viewed from the CD:\NOTICES directory of the installation software CD.

Noise emission levels

The following measurements were made in accordance with ISO 7779 and reported in conformance with ISO 9296.

Note: Some modes may not apply to your product.

1-meter average sound pressure, dBA	
Printing	56 (MS725dvn); 57 (B2865dw, M5255, MS821n, MS821dn, MS822de, MS823n, MS823dn); 58 (M5270, MS825dn, MS826de)
Ready	28 (MS725dvn); 14 (B2865dw, M5255, M5270, MS821n, MS821dn, MS822de, MS823n, MS823dn, MS825dn, MS826de)

Values are subject to change. See www.lexmark.com for current values.

Waste from Electrical and Electronic Equipment (WEEE) directive



The WEEE logo signifies specific recycling programs and procedures for electronic products in countries of the European Union. We encourage the recycling of our products.

If you have further questions about recycling options, visit the Lexmark Web site at www.lexmark.com for your local sales office phone number.

India E-Waste notice



This product complies with the India E-Waste (Management and Handling) Rules, 2011, which prohibit use of lead, mercury, hexavalent chromium, polybrominated biphenyls, or polybrominated diphenyl ethers in concentrations exceeding 0.1% by weight and 0.01% by weight for cadmium, except for the exemption set in Schedule II of the Rules.

Product disposal

Do not dispose of the printer or supplies in the same manner as normal household waste. Consult your local authorities for disposal and recycling options.

Static sensitivity notice



This symbol identifies static-sensitive parts. Do not touch the areas near these symbols without first touching a metal surface in an area away from the symbol.

To prevent damage from electrostatic discharge when performing maintenance tasks such as clearing paper jams or replacing supplies, touch any exposed metal frame of the printer before accessing or touching interior areas of the printer even if the symbol is not present.

ENERGY STAR

Any Lexmark product bearing the ENERGY STAR® emblem on the product or on a start-up screen is certified to comply with Environmental Protection Agency (EPA) ENERGY STAR requirements as configured when shipped by Lexmark.



Temperature information

Operating temperature and relative humidity	15.3 to 32.2°C (60 to 90°F) and 8 to 80% RH
Printer / cartridge / imaging unit long-term storage ¹	1.1 to 35°C (34 to 95°F) and 8 to 80% RH Maximum wet-bulb temperature ² : 22.8°C (73°F) Non-condensing environment
Printer / cartridge / imaging unit short-term shipping	-40 to 43.3°C (-40 to 110°F)
¹ Supplies shelf life is approximately 2 years. This is based on storage in a standard office environment at 22°C (72°F) and 45% humidity. ² Wet-bulb temperature is determined by the air temperature and the relative humidity.	

Laser notice

The printer is certified in the U.S. to conform to the requirements of DHHS 21 CFR, Chapter I, Subchapter J for Class I (1) laser products, and elsewhere is certified as a Class I laser product conforming to the requirements of IEC 60825-1: 2014.

Class I laser products are not considered to be hazardous. The laser system and printer are designed so there is never any human access to laser radiation above a Class I level during normal operation, user maintenance, or prescribed service conditions. The printer has a non-serviceable printhead assembly that contains a laser with the following specifications:

Class: IIIb (3b) AlGaAs

Nominal output power (milliwatts): 25

Wavelength (nanometers): 755–800

Power consumption

Product power consumption

The following table documents the power consumption characteristics of the product.

Note: Some modes may not apply to your product.

Mode	Description	Power consumption (Watts)
Printing	The product is generating hard-copy output from electronic inputs.	800 (MS725dvn); 670 (M5255, MS821n, MS821dn); 700 (MS822de); 770 (B2865dw, MS823n, MS823dn); 830 (M5270, MS825dn, MS826de)
Copy	The product is generating hard-copy output from hard-copy original documents.	N/A
Scan	The product is scanning hard-copy documents.	N/A
Ready	The product is waiting for a print job.	High power usage: 95 (MS725dvn); 39 (M5255, MS821n, MS821dn, MS822de); 34 (B2865dw, MS823n, MS823dn); 38.5 (M5270, MS825dn, MS826de) Low power usage: 75 (MS725dvn); 21.5 (M5255, MS821n, MS821dn, MS822de); 20 (B2865dw, MS823n, MS823dn); 21 (M5270, MS825dn, MS826de)
Sleep Mode	The product is in a high-level energy-saving mode.	1.3 (MS725dvn); 1.4 (M5255, M5270, MS821n, MS821dn, MS822de, MS825dn, MS826de); 1.6 (B2865dw, MS823n, MS823dn)
Hibernate	The product is in a low-level energy-saving mode.	0.2
Off	The product is plugged into an electrical outlet, but the power switch is turned off.	0.2

The power consumption levels listed in the previous table represent time-averaged measurements. Instantaneous power draws may be substantially higher than the average.

Values are subject to change. See www.lexmark.com for current values.

Sleep Mode

This product is designed with an energy-saving mode called *Sleep Mode*. The Sleep Mode saves energy by lowering power consumption during extended periods of inactivity. The Sleep Mode is automatically engaged after this product is not used for a specified period of time, called the *Sleep Mode Timeout*.

Factory default Sleep Mode Timeout for this product (in minutes):	15
---	----

By using the configuration menus, the Sleep Mode Timeout can be modified between 1 minute and 120 minutes. Setting the Sleep Mode Timeout to a low value reduces energy consumption, but may increase the response time of the product. Setting the Sleep Mode Timeout to a high value maintains a fast response, but uses more energy.

Hibernate Mode

This product is designed with an ultra-low power operating mode called *Hibernate mode*. When operating in Hibernate Mode, all other systems and devices are powered down safely.

The Hibernate mode can be entered in any of the following methods:

- Using the Hibernate Timeout
- Using the Schedule Power modes

Factory default Hibernate Timeout for this product in all countries or regions	3 days
--	--------

The amount of time the printer waits after a job is printed before it enters Hibernate mode can be modified between one hour and one month.

Off mode

If this product has an off mode which still consumes a small amount of power, then to completely stop product power consumption, disconnect the power supply cord from the electrical outlet.

Total energy usage

It is sometimes helpful to estimate the total product energy usage. Since power consumption claims are provided in power units of Watts, the power consumption should be multiplied by the time the product spends in each mode in order to calculate energy usage. The total product energy usage is the sum of each mode's energy usage.

Regulatory notices for wireless products

This section contains regulatory information that applies only to wireless models.

If in doubt as to whether your model is a wireless model, go to <http://support.lexmark.com>.

Modular component notice

Wireless-equipped models contain the following modular component(s):

Lexmark Regulatory Type/Model: LEX-M07-001; FCC ID: IYLLEXM07001; Industry Canada IC: 2376A-M07001

Exposure to radio frequency radiation

The radiated output power of this device is far below the radio frequency exposure limits of the FCC and other regulatory agencies. A minimum separation of 20 cm (8 inches) must be maintained between the antenna and any persons for this device to satisfy the RF exposure requirements of the FCC and other regulatory agencies.

Industry Canada (Canada)

Under Industry Canada regulations, this radio transmitter may only operate using an antenna of a type and maximum (or lesser) gain approved for the transmitter by Industry Canada. To reduce potential radio

interference to other users, the antenna type and its gain should be so chosen that the equivalent isotropically radiated power (EIRP) is not more than that necessary for successful communication.

This device complies with Industry Canada license-exempt RSS standards. Operation is subject to the following two conditions: (1) this device may not cause interference, and (2) this device must accept any interference, including interference that may cause undesired operation of the device.

To prevent radio interference to the licensed service and to reduce the potential for harmful interference to co-channel mobile satellite systems, this device is intended to be operated indoors and away from windows to provide maximum shielding.

High-power radars are allocated as primary users (i.e., priority users) of the bands 5250–5350MHz and 5650–5850MHz. These radars could cause interference and/or damage to LE-LAN devices.

Industrie Canada (Canada)

Selon la réglementation d'Industrie Canada, l'émetteur radio ne fonctionne qu'avec une antenne dont le type et le gain maximal (ou inférieur) ont été approuvés par Industrie Canada. Pour réduire les interférences radio potentielles auprès d'autres utilisateurs, le type d'antenne et son gain doivent être choisis de telle sorte que la puissance isotrope rayonnée équivalente (PIRE) ne soit pas supérieure à ce qui est nécessaire pour assurer la réussite de la communication.

Cet appareil est conforme aux normes RSS exemptes de licence d'Industrie Canada. Son fonctionnement est soumis aux deux conditions suivantes : (1) cet appareil ne doit pas causer d'interférences et (2) il doit accepter toutes les interférences, y compris les celles qui peuvent entraîner un fonctionnement indésirable.

Afin de prévenir les interférences radio des services sous licence et pour réduire le risque d'interférences nuisibles aux systèmes de satellites mobiles utilisant les mêmes canaux, cet appareil est destiné à être utilisé à l'intérieur et loin des fenêtres afin de fournir une protection maximale.

Les radars à haute puissance sont définis comme les utilisateurs principaux (p. ex., utilisateurs prioritaires) dans les bandes de 5250-5350 MHz et 5650-5850 MHz. Ces radars peuvent causer des interférences ou des dommages aux appareils RELOC-EL.

European Community (EC) directives conformity

This product is in conformity with the protection requirements of EC Council directive 2014/53/EU on the approximation and harmonization of the laws of the Member States relating to radio equipment.

The manufacturer of this product is: Lexmark International, Inc., 740 West New Circle Road, Lexington, KY, 40550 USA. The authorized representative is: Lexmark International Technology Hungária Kft., 8 Lechner Ödön fasor, Millennium Tower III, 1095 Budapest HUNGARY. A declaration of conformity to the requirements of the Directives is available upon request from the Authorized Representative or may be obtained at www.lexmark.com/en_us/about/regulatory-compliance/european-union-declaration-of-conformity.html.

Compliance is indicated by the CE marking:



Restrictions

This radio equipment is restricted to indoor use only. Outdoor use is prohibited. This restriction applies to all the countries listed in the table below:

								
AT	BE	BG	CH	CY	CZ	DE	DK	EE
EL	ES	FI	FR	HR	HU	IE	IS	IT
LI	LT	LU	LV	MT	NL	NO	PL	PT
RO	SE	SI	SK	TR	UK			

EU statement of radio transmitter operational frequency bands and maximum RF power

This radio product transmits in either the 2.4GHz (2.412–2.472 GHz in the EU) or 5GHz (5.15–5.35, 5.47–5.725 in the EU) bands. The maximum transmitter EIRP power output, including antenna gain, is ≤ 20dBm for both bands.

Federal Communications Commission (FCC) compliance information statement

This product has been tested and found to comply with the limits for a Class A digital device, pursuant to Part 15 of the FCC Rules. Operation is subject to the following two conditions: (1) this device may not cause harmful interference, and (2) this device must accept any interference received, including interference that may cause undesired operation.

The FCC Class A limits are designed to provide reasonable protection against harmful interference when the equipment is operated in a commercial environment. This equipment generates, uses, and can radiate radio frequency energy and, if not installed and used in accordance with the instruction manual, may cause harmful interference to radio communications. Operation of this equipment in a residential area is likely to cause harmful interference, in which case the user will be required to correct the interference at his own expense.

The manufacturer is not responsible for any radio or television interference caused by using other than recommended cables or by unauthorized changes or modifications to this equipment. Unauthorized changes or modifications could void the user's authority to operate this equipment.

Note: To assure compliance with FCC regulations on electromagnetic interference for a Class A computing device, use a properly shielded and grounded cable such as Lexmark part number 1021231 for parallel attach or 1021294 for USB attach. Use of a substitute cable not properly shielded and grounded may result in a violation of FCC regulations.

Any questions regarding this compliance information statement should be directed to:

Director of Lexmark Technology & Services
Lexmark International, Inc.
740 West New Circle Road
Lexington, KY 40550
Telephone: (859) 232-2000
E-mail: regulatory@lexmark.com

Industry Canada compliance statement

This Class A digital apparatus meets all requirements of the Canadian Interference-Causing Equipment Standard ICES-003.

Avis de conformité aux normes de l'industrie du Canada

Cet appareil numérique de classe A est conforme aux exigences de la norme canadienne relative aux équipements pouvant causer des interférences NMB-003.

Notice to users of Class A products in Brazil

Este produto não é apropriado para uso em ambientes domésticos, pois poderá causar interferências eletromagnéticas que obrigam o usuário a tomar medidas necessárias para minimizar estas interferências.

European Community (EC) directives conformity

This product is in conformity with the protection requirements of EC Council directives 2014/30/EU, 2014/35/EU, and 2011/65/EU on the approximation and harmonization of the laws of the Member States relating to electromagnetic compatibility, safety of electrical equipment designed for use within certain voltage limits, and on the restrictions of use of certain hazardous substances in electrical and electronic equipment.

The manufacturer of this product is: Lexmark International, Inc., 740 West New Circle Road, Lexington, KY, 40550 USA. The authorized representative is: Lexmark International Technology Hungária Kft., 8 Lechner Ödön fasor, Millennium Tower III, 1095 Budapest HUNGARY. A declaration of conformity to the requirements of the Directives is available upon request from the Authorized Representative or may be obtained at www.lexmark.com/en_us/about/regulatory-compliance/european-union-declaration-of-conformity.html.

This product satisfies the Class A limits of EN 55022 and EN55032 and safety requirements of EN 60950-1 or EN 62368-1.

Radio interference notice

Warning

This is a product that complies with the emission requirements of EN55022 and EN55032 Class A limits and immunity requirements of EN55024. This product is not intended to be used in residential/domestic environments.

This is a Class A product. In a domestic environment, this product may cause radio interference, in which case the user may be required to take adequate measures.

STATEMENT OF LIMITED WARRANTY FOR LEXMARK LASER PRINTERS, LEXMARK LED PRINTERS, AND LEXMARK MULTIFUNCTION LASER PRINTERS

Lexmark International, Inc., Lexington, KY

This limited warranty applies to the United States and Canada. For customers outside the U.S., refer to the country-specific warranty information that came with your product.

This limited warranty applies to this product only if it was originally purchased for your use, and not for resale, from Lexmark or a Lexmark Remarketer, referred to in this statement as “Remarketer.”

Limited warranty

Lexmark warrants that this product:

- Is manufactured from new parts, or new and serviceable used parts, which perform like new parts
- Is, during normal use, free from defects in material and workmanship

If this product does not function as warranted during the warranty period, contact a Remarketer or Lexmark for repair or replacement (at Lexmark's option).

If this product is a feature or option, this statement applies only when that feature or option is used with the product for which it was intended. To obtain warranty service, you may be required to present the feature or option with the product.

If you transfer this product to another user, warranty service under the terms of this statement is available to that user for the remainder of the warranty period. You should transfer proof of original purchase and this statement to that user.

Limited warranty service

The warranty period starts on the date of original purchase as shown on the purchase receipt and ends 12 months later provided that the warranty period for any supplies and for any maintenance items included with the printer shall end earlier if it, or its original contents, are substantially used up, depleted, or consumed. Fuser Units, Transfer/Transport Units, Paper Feed items, if any, and any other items for which a Maintenance Kit is available are substantially consumed when the printer displays a “Life Warning” or “Scheduled Maintenance” message for such item.

To obtain warranty service you may be required to present proof of original purchase. You may be required to deliver your product to the Remarketer or Lexmark, or ship it prepaid and suitably packaged to a Lexmark designated location. You are responsible for loss of, or damage to, a product in transit to the Remarketer or the Lexmark designated location.

When warranty service involves the exchange of a product or part, the item replaced becomes the property of the Remarketer or Lexmark. The replacement may be a new or repaired item.

The replacement item assumes the remaining warranty period of the original product.

Replacement is not available to you if the product you present for exchange is defaced, altered, in need of a repair not included in warranty service, damaged beyond repair, or if the product is not free of all legal obligations, restrictions, liens, and encumbrances.

As part of your warranty service and/or replacement, Lexmark may update the firmware in your printer to the latest version. Firmware updates may modify printer settings and cause counterfeit and/or unauthorized products, supplies, parts, materials (such as toners and inks), software, or interfaces to stop working. Authorized use of genuine Lexmark products will not be impacted.

Before you present this product for warranty service, remove all print cartridges, programs, data, and removable storage media (unless directed otherwise by Lexmark).

For further explanation of your warranty alternatives and the nearest Lexmark authorized servicer in your area contact Lexmark on the World Wide Web.

Remote technical support is provided for this product throughout its warranty period. For products no longer covered by a Lexmark warranty, technical support may not be available or only be available for a fee.

Extent of limited warranty

Lexmark does not warrant uninterrupted or error-free operation of any product or the durability or longevity of prints produced by any product.

Warranty service does not include repair of failures caused by:

- Modification or unauthorized attachments
- Accidents, misuse, abuse or use inconsistent with Lexmark user's guides, manuals, instructions or guidance
- Unsuitable physical or operating environment
- Maintenance by anyone other than Lexmark or a Lexmark authorized servicer
- Operation of a product beyond the limit of its duty cycle
- Use of printing media outside of Lexmark specifications
- Refurbishment, repair, refilling or remanufacture by a third party of products, supplies or parts
- Products, supplies, parts, materials (such as toners and inks), software, or interfaces not furnished by Lexmark

TO THE EXTENT PERMITTED BY APPLICABLE LAW, NEITHER LEXMARK NOR ITS THIRD PARTY SUPPLIERS OR REMARKETERS MAKE ANY OTHER WARRANTY OR CONDITION OF ANY KIND, WHETHER EXPRESS OR IMPLIED, WITH RESPECT TO THIS PRODUCT, AND SPECIFICALLY DISCLAIM THE IMPLIED WARRANTIES OR CONDITIONS OF MERCHANTABILITY, FITNESS FOR A PARTICULAR PURPOSE, AND SATISFACTORY QUALITY. ANY WARRANTIES THAT MAY NOT BE DISCLAIMED UNDER APPLICABLE LAW ARE LIMITED IN DURATION TO THE WARRANTY PERIOD. NO WARRANTIES, EXPRESS OR IMPLIED, WILL APPLY AFTER THIS PERIOD. ALL INFORMATION, SPECIFICATIONS, PRICES, AND SERVICES ARE SUBJECT TO CHANGE AT ANY TIME WITHOUT NOTICE.

Limitation of liability

Your sole remedy under this limited warranty is set forth in this document. For any claim concerning performance or nonperformance of Lexmark or a Remarketer for this product under this limited warranty, you may recover actual damages up to the limit set forth in the following paragraph.

Lexmark's liability for actual damages from any cause whatsoever will be limited to the amount you paid for the product that caused the damages. This limitation of liability will not apply to claims by you for bodily injury or damage to real property or tangible personal property for which Lexmark is legally liable. **IN NO EVENT WILL LEXMARK BE LIABLE FOR ANY LOST PROFITS, LOST SAVINGS, INCIDENTAL DAMAGE, OR OTHER ECONOMIC OR CONSEQUENTIAL DAMAGES.** This is true even if you advise Lexmark or a Remarketer of the possibility of such damages. Lexmark is not liable for any claim by you based on a third party claim.

This limitation of remedies also applies to claims against any Suppliers and Remarketers of Lexmark. Lexmark's and its Suppliers' and Remarketers' limitations of remedies are not cumulative. Such Suppliers and Remarketers are intended beneficiaries of this limitation.

Additional rights

Some states do not allow limitations on how long an implied warranty lasts, or do not allow the exclusion or limitation of incidental or consequential damages, so the limitations or exclusions contained above may not apply to you.

This limited warranty gives you specific legal rights. You may also have other rights that vary from state to state.

Index

Numerics

- 2100-sheet tray
 - installing 200
 - loading 29

A

- About this Printer menu 63
- accessing the controller board 190
- activating Voice Guidance 24
- adding contacts 21
- adding groups 22
- adding hardware options
 - print driver 216
- adding internal options
 - print driver 216
- adjusting default volume
 - speaker 100
- adjusting speech rate
 - Voice Guidance 25
- adjusting the brightness
 - display 127
- adjusting the default headphone volume 100
- adjusting toner darkness 188
- AirPrint
 - using 45
- Android device
 - printing from 44
- attaching cables 13
- avoiding paper jams 129

B

- blank pages 157
- bookmarks
 - creating 20
 - creating folders for 21

C

- cannot open Embedded Web Server 149
- changing the printer port settings after installing ISP 102
- changing the wallpaper 18
- checking the printer connectivity 151

- checking the status of parts and supplies 104
- cleaning
 - exterior of the printer 103
 - interior of the printer 103
- cleaning the printer 103
- clearing jam
 - in door A 133
 - in door H 141
 - in door N 140
 - in high-capacity output expander 139
 - in mailbox bin 140
 - in output expander 139
 - in the duplex unit 136
 - in the fuser 136
 - in the multipurpose feeder 138
 - in the staple finisher 143
 - in the staple finisher bin 141
 - in the staple, hole punch finisher 142
 - in the staple, hole punch finisher bin 142
 - in trays 133
- clearing staple jam
 - in the staple, hole punch finisher 146
- Cloud Connector profile
 - creating 19
 - printing from 48
- collated printing does not work 154
- confidential print jobs 47
 - printing from a Macintosh computer 47
 - printing from Windows 47
- configuring Eco-Mode setting 19
- configuring Eco-Settings 19
- configuring supply notifications 108
- configuring Universal paper 26
- connecting the printer
 - to a wireless network 101
- connecting to a wireless network
 - using PIN method 101
 - using Push Button method 101
- conserving supplies 127
- contacting customer support 188

- contacts
 - adding 21
 - deleting 22
 - editing 22
- controller board
 - accessing 190
- creating a Cloud Connector profile 19
- creating bookmarks 20
- creating folders
 - for bookmarks 21
- crooked print 170
- Customer Support
 - using 20
- customer support
 - contacting 188
- customizing the display 18

D

- deactivating the Wi-Fi network 102
- default headphone volume
 - adjusting 100
- default speaker volume
 - adjusting 100
- Defective flash detected 152
- deleting contacts 22
- deleting groups 22
- Device Quotas
 - setting up 19
- directory list
 - printing 49
- display brightness
 - adjusting 127
- Display Customization
 - using 18
- documents, printing
 - from a computer 44
 - from a mobile device 44, 45

E

- Eco-Mode
 - configuring 127
- Eco-Settings
 - configuring 19
- editing contacts 22
- editing groups 22
- emission notices 219, 223, 226

- enabling Magnification mode 25
- enabling personal identification numbers 25
- enabling spoken passwords 25
- enabling the USB port 150
- encrypting the printer hard disk 98
- envelopes
 - loading 34
- environmental setting
 - Eco-Mode 127
 - Hibernate mode 127
 - sleep mode 127
- erasing memory
 - from the printer hard disk 97
- erasing non-volatile memory 97
- erasing printer hard disk memory 97
- erasing printer memory 97, 98
- erasing volatile memory 97
- Ethernet port 13
- exporting a configuration file
 - using the Embedded Web Server 216
- exporting compressed logs 63
- exporting configuration file 63

F

- factory default settings
 - restoring 98
- FCC notices 223
- finding more information about the printer 9
- firmware
 - update 217
- flash drive
 - printing from 45
- folder paper 161
- font sample list
 - printing 48
- fuser
 - replacing 112

G

- Google Cloud Print
 - using 44
- groups
 - adding 22
 - deleting 22
 - editing 22

H

- hardware options
 - installing 195, 200
 - memory card 191
 - trays 199
- hardware options, adding
 - print driver 216
- held jobs 47
 - printing from a Macintosh computer 47
 - printing from Windows 47
- Hibernate mode
 - configuring 127
- home screen
 - customizing 18
 - showing icons 18
 - using 17
- home screen icons 17
- hot roll fuser
 - replacing 114
- humidity around the printer 221

I

- icons on the home screen
 - showing 18
- identifying jam locations 131
- imaging unit
 - ordering 106
 - replacing 109
- importing a configuration file
 - using the Embedded Web Server 216
- indicator light
 - understanding the status 16
- installing a memory card 191
- installing an optional card 193
- installing options
 - printer hard disk 194
- installing the 2100-sheet tray 200
- installing the printer software 216
- installing trays 199
- internal option is not detected 151
- internal options
 - firmware card 190
 - flash memory 190
 - font card 190
 - internal solutions port 190
 - printer hard disk 190

- internal options, adding
 - print driver 216
- internal solutions port
 - installing 195

J

- jams
 - avoiding 129
- jams, clearing
 - in the standard bin 137

K

- keyboard on the display
 - using 25

L

- letterhead
 - loading 34
 - loading, 2100-sheet tray 29
- Lexmark Mobile Print
 - using 44
- linking trays 35
- loading
 - 2100-sheet tray 29
 - letterhead in 2100-sheet tray 29
- loading the multipurpose feeder 34
- loading trays 26
- locating jam areas 131
- locating the security slot 97

M

- Magnification mode
 - enabling 25
- maintenance kit
 - ordering 107
- managing screen saver 18
- memory card
 - installing 191
- menu
 - 802.1x 83
 - Accessibility 58
 - Confidential Print Setup 92
 - Configuration Menu 59
 - Default Login Methods 88
 - Device 95
 - Erase Temporary Data Files 93
 - Ethernet 77
 - Flash Drive Print 73
 - Google Cloud Print 85

- Help 95
 - HTML 70
 - HTTP/FTP Settings 84
 - Image 70
 - Information Sent to Lexmark 58
 - IPSec 82
 - Job Accounting 66
 - Layout 63
 - Local Accounts 88
 - Login Restrictions 92
 - LPD Configuration 83
 - Manage Permissions 87
 - Media Types 72
 - Menu Settings Page 95
 - Miscellaneous 94
 - Mobile Services
 - Management 94
 - Network 95
 - Network Overview 74
 - Notifications 52
 - Out of Service Erase 62
 - PCL 68
 - PDF 68
 - PostScript 68
 - Power Management 56
 - Preferences 51
 - Print 95
 - Quality 65
 - Remote Operator Panel 52
 - Restore Factory Defaults 59
 - Security Audit Log 89
 - Setup 65
 - SNMP 81
 - Solutions LDAP Settings 93
 - TCP/IP 79
 - ThinPrint 84
 - Tray Configuration 71
 - Troubleshooting 96
 - Universal Setup 72
 - USB 85
 - Visible Home Screen Icons 62
 - Wireless 75
 - Wi-Fi Direct 86
 - XPS 67
 - Menu map 50
 - Menu Settings Page
 - printing 96
 - menus
 - About this Printer 63
 - Disk Encryption 93
 - Schedule USB Devices 89
 - mobile device
 - printing from 44, 45
 - Mopria Print Service
 - using 44
 - moving the printer 10, 126
 - multipurpose feeder
 - loading 34
- N**
- navigating the screen
 - using gestures 24
 - navigating the screen using gestures 24
 - noise emission levels 219
 - Non-Lexmark supply 153
 - non-volatile memory 98
 - Not enough free space in flash memory for resources 152
 - notices 219, 220, 221, 222, 223, 226
- O**
- operating systems
 - supported 215
 - optional card
 - installing 193
 - ordering
 - maintenance kit 107
 - ordering supplies
 - imaging unit 106
 - staple cartridge 107
 - toner cartridge 104
- P**
- paper jam
 - in the duplex area 136
 - in the fuser 136
 - paper jam in door A 133
 - paper jam in door C 136
 - paper jam in door H 141
 - paper jam in door N 140
 - paper jam in the 4-bin mailbox 140
 - paper jam in the high-capacity output expander 139
 - paper jam in the multipurpose feeder 138
 - paper jam in the output expander 139
 - paper jam in the staple finisher bin 141
 - paper jam in trays 133
 - paper jams
 - avoiding 129
 - location 131
 - paper jams, clearing
 - in the standard bin 137
 - personal identification number method 101
 - personal identification numbers
 - enabling 25
 - pick roller
 - replacing 119
 - pick roller in the multipurpose feeder
 - replacing 120
 - power button light
 - understanding the status 16
 - power cord socket 13
 - prepunched paper
 - loading 34
 - print driver
 - hardware options, adding 216
 - print jobs not printed 186
 - Print Quality Test Pages 96
 - print quality troubleshooting
 - blank or white pages 157
 - crooked or skewed print 170
 - dark print 158
 - fine lines are not printed
 - correctly 160
 - folded or wrinkled paper 161
 - gray background on prints 162
 - horizontal light bands 176
 - light print 165
 - mottled print and dots 168
 - paper curl 169
 - repeating defects 182
 - solid black pages 171
 - text or images cut off 173
 - toner easily rubs off 175
 - vertical dark bands 178
 - vertical dark lines or streaks 180
 - vertical dark streaks with print missing 181
 - vertical light bands 176
 - vertical white lines 177
 - print troubleshooting
 - confidential and other held documents do not print 183
 - envelope seals when printing 154

- incorrect margins 165
 - jammed pages are not reprinted 157
 - job prints from the wrong tray 188
 - job prints on the wrong paper 188
 - paper frequently jams 156
 - print jobs do not print 186
 - slow printing 184
 - tray linking does not work 155
 - unable to read flash drive 150
 - printer
 - minimum clearances 10
 - moving 10
 - selecting a location 10
 - shipping 126
 - printer configurations 11
 - printer connectivity
 - checking 151
 - printer hard disk
 - encrypting 98
 - installing 194
 - printer hard disk memory 98
 - erasing 97
 - printer information
 - finding 9
 - printer is not responding 187
 - printer menus 63
 - printer messages
 - Defective flash detected 152
 - Non-Lexmark supply 153
 - Not enough free space in flash memory for resources 152
 - Replace cartridge, printer region mismatch 152
 - Unformatted flash detected 152
 - printer options troubleshooting
 - cannot detect internal option 151
 - printer port settings
 - changing 102
 - printer ports 13
 - printer settings
 - restoring factory default 98
 - printer software, installing 216
 - printer status 16
 - printing
 - AirPrint 94
 - directory list 49
 - font sample list 48
 - from a Cloud Connector profile 48
 - from a computer 44
 - from a flash drive 45
 - from a mobile device 44
 - from an Android device 44
 - Menu Settings Page 96
 - using Google Cloud Print 44
 - printing confidential and other held jobs
 - from a Macintosh computer 47
 - from Windows 47
 - printing from a computer 44
 - printing from a flash drive 45
 - Push Button method 101
- Q**
- QR codes
 - adding 20
- R**
- recycling
 - Lexmark packaging 128
 - Lexmark products 128
 - toner cartridges 128
 - removing paper jam
 - in door A 133
 - in door H 141
 - in door N 140
 - in high-capacity output expander 139
 - in mailbox bin 140
 - in the duplex unit 136
 - in the fuser 136
 - in the multipurpose feeder 138
 - in the output expander 139
 - in the staple finisher bin 141
 - in the staple, hole punch finisher 142
 - in the staple, hole punch finisher bin 142
 - in trays 133
 - removing staple jam 143, 146
 - repeat print jobs 47
 - printing from a Macintosh computer 47
 - printing from Windows 47
 - Replace cartridge, printer region mismatch 152
- replacing
 - pick roller in the multipurpose feeder 120
- replacing parts
 - fuser 112
 - hot roll fuser 114
 - pick roller 119
 - transfer roller 116
 - replacing supplies
 - imaging unit 109
 - staple cartridge 123, 124
 - toner cartridge 108
 - reserve print jobs
 - printing from a Macintosh computer 47
 - printing from Windows 47
 - resetting
 - supply usage counters 153
 - restoring factory default settings 98
 - running a slideshow 18
- S**
- safety information 7, 8
 - scheduling power modes 19
 - securing printer memory 98
 - security slot
 - locating 97
 - selecting a location for the printer 10
 - setting the paper size 26
 - setting the paper type 26
 - setting up Device Quotas 19
 - shipping the printer 126
 - showing icons on the home screen 18
 - skewed print 170
 - sleep mode
 - configuring 127
 - spoken passwords
 - enabling 25
 - staple cartridge
 - ordering 107
 - replacing 123, 124
 - statement of volatility 98
 - status of parts
 - checking 104
 - status of supplies
 - checking 104
 - storing print jobs 47
 - supplies
 - conserving 127

- supply notifications
 - configuring 108
- supply usage counters
 - resetting 153
- supported file types 46
- supported flash drives 46
- supported operating systems 215
- supported paper sizes 36
- supported paper types 39
- supported paper weights 41

T

- temperature around the printer 221
- toner cartridge
 - ordering 104
 - replacing 108
- toner cartridges
 - recycling 128
- toner darkness
 - adjusting 188
- transfer roller
 - replacing 116
- trays
 - loading 26
- troubleshooting
 - cannot open Embedded Web Server 149
 - printer is not responding 187
- troubleshooting, print
 - collated printing does not work 154
 - confidential and other held documents do not print 183
 - envelope seals when printing 154
 - incorrect margins 165
 - jammed pages are not reprinted 157
 - job prints from the wrong tray 188
 - job prints on the wrong paper 188
 - paper frequently jams 156
 - print jobs do not print 186
 - slow printing 184
 - tray linking does not work 155
- troubleshooting, print quality
 - blank or white pages 157
 - crooked or skewed print 170
 - dark print 158

- fine lines are not printed
 - correctly 160
- folded or wrinkled paper 161
- gray background on prints 162
- horizontal light bands 176
- light print 165
- mottled print and dots 168
- paper curl 169
- repeating defects 182
- solid black pages 171
- text or images cut off 173
- toner easily rubs off 175
- vertical dark bands 178
- vertical dark lines or streaks 180
- vertical dark streaks with print missing 181
- vertical light bands 176
- vertical white lines 177

troubleshooting, printer options

- cannot detect internal option 151

U

- unable to read flash drive
 - troubleshooting, print 150
- Unformatted flash detected 152
- Universal paper
 - configuring 26
- unlinking trays 35
- updating firmware
 - flash file 217
- USB port 13
 - enabling 150
- using
 - genuine Lexmark parts 104
 - genuine Lexmark supplies 104
 - using Customer Support 20
 - using Display Customization 18
 - using QR Code Generator 20
 - using the control panel
 - Lexmark M5255 16
 - Lexmark M5265 16
 - Lexmark M5270 16
 - Lexmark MS725 15
 - Lexmark MS821 15
 - Lexmark MS822 16
 - Lexmark MS823 15
 - Lexmark MS825 15
 - Lexmark MS826 16
 - using the home screen 17

V

- verify print jobs 47
 - printing from a Macintosh computer 47
 - printing from Windows 47
- vertical dark lines on prints 180
- vertical streaks on prints 180
- virtual keyboard
 - using 25
- Voice Guidance
 - activating 24
 - speech rate 25
- Voice Guidance speech rate
 - adjusting 25
- volatile memory 98

W

- white lines 177
- white pages 157
- wireless network
 - connecting the printer to 101
 - Wi-Fi Protected Setup 101
- wireless networking 101
- Wi-Fi network
 - deactivating 102
- Wi-Fi Protected Setup
 - wireless network 101
- wrinkled paper 161