



UA-XVL810, UA-XVL1610, UA-XVR810

User's Manual



Before attempting to connect or operate this product, please read these instructions carefully and save this manual for future use.

UVSUA-UM-A



© 2022 GeoVision, Inc. All rights reserved.

Under the copyright laws, this manual may not be copied, in whole or in part, without the written consent of GeoVision.

Every effort has been made to ensure that the information in this manual is accurate. GeoVision, Inc. makes no expressed or implied warranty of any kind and assumes no responsibility for errors or omissions. No liability is assumed for incidental or consequential damages arising from the use of the information or products contained herein. Features and specifications are subject to change without notice.

GeoVision, Inc.
9F, No. 246, Sec. 1, Neihu Rd.,
Neihu District, Taipei, Taiwan
Tel: +886-2-8797-8377
Fax: +886-2-8797-8335
<http://www.geovision.com.tw>

Trademarks used in this manual: *GeoVision*, the *GeoVision* logo and *GV* series products are trademarks of GeoVision, Inc. *Windows* is the registered trademark of Microsoft Corporation.

March 2022

Scan the following QR codes for product warranty and technical support policy:



[Warranty]



[Technical Support Policy]

Contents

Contents	1
Safety Instruction	4
Chapter 1 Product Overview	1
1.1 UA- XVL810 Front Panel	1
1.2 UA- XVL810 Rear Panel	2
1.3 UA-XVL1610 Front Panel	3
1.4 UA-XVL1610 Rear Panel	4
1.5 UA- XVR810 Front Panel	5
1.6 UA- XVR810 Rear Panel	6
Chapter 2 DVR Installation & Connection	7
2.1 HDD Installation	7
2.2 Connection Diagram	8
2.3 Power Supply Connection	9
Chapter 3 DVR Common Operations	10
3.1 Using the Supplied Mouse	10
3.2 Using the Virtual Keyboard	11
3.3 Password	11
Chapter 4 DVR Starting up	14
4.1 Start Wizard	14
4.1.1 Start Wizard	14
4.1.2 Network Configuration	15
4.1.3 Date/Time.....	16
4.1.4 IP Camera	18
4.1.5 Disk	20
4.1.6 Resolution	20
4.1.7 Mobile	21
4.1.8 Summary.....	22
4.2 Live View Screen Overview	23
4.2.1 Camera Quick Toolbar	24
4.2.2 Task Menu Bar	25
4.2.3 Start Menu	26
Chapter 5 DVR System Setup	28
5.1 Channel	28
5.1.1 Channel.....	29
5.1.2 Live.....	32
5.1.3 PTZ	33
5.1.4 Video Cover	35

5.1.5 Motion	36
5.1.6 Intelligent.....	38
5.2 Record.....	63
5.2.1 Encode.....	63
5.2.2 Record	65
5.2.3 Capture	67
5.3 Alarm.....	69
5.3.1 Motion	69
5.3.2 PIR	69
5.3.3 I / O	69
5.3.4 Intelligent.....	70
5.3.5 PTZ Linkage.....	71
5.3.6 Exception	72
5.3.7 Alarm Schedule.....	73
5.4 Network.....	74
5.4.1 General	75
5.4.2 DDNS (Dynamic Domain Name Server).....	78
5.4.3 Email	79
5.4.4 FTP	81
5.4.5 IP Filter.....	83
5.4.6 Voice Assistant.....	84
5.4.7 Platform Access	84
5.5 Device.....	85
5.5.1 Disk	85
5.5.2 Cloud.....	87
5.6 System	88
5.6.1 General	89
5.6.2 Multi-User.....	93
5.6.3 Maintenance	96
5.6.4 IP Camera Maintain	101
5.6.5 Information	104
Chapter 6 Search, Playback, and Backup.....	107
6.1 Using Search Function.....	107
6.1.1 Search and Play Video in General.....	109
6.1.2 Event Search, Playback, and Backup.....	111
6.1.3 Sub-periods Playback	113
6.1.4 Smart Search and Playback	114
6.1.5 Tag Playback.....	116
6.1.6 External File Playback	118
6.1.7 Picture Search and View.....	119
6.1.8 Split Playback (Slice)	121

- Chapter 7 Remote Access via Web Client..... 123**
 - 7.1 Basic System Environment Requirements123**
 - 7.2 Web Plugin Download and Installation124**
 - 7.3 Web Client Manager125**
 - 7.3.1 Live Interface 125
 - 7.3.2 Playback 129
 - 7.3.3 Remote Setting 133
 - 7.3.4 Local Setting 133
- Chapter 8 Remote Access via Mobile Devices 135**
- Appendix 136**
 - A. Troubleshooting.....136**
 - B. Usage Maintenance138**

Safety Instruction

Please carefully read the following safety instruction so as to avoid personal injuries and prevent the equipment and other connection devices from being damaged.

1. Power sources (note: please use the power supply attached or specified by the manufacturer)

Never operate the equipment by using unspecified power supply.

2. Never push objects of any kind through openings of DVR

Never push objects of any kind through openings of DVR so as to avoid electric shock or other accidents.

3. Do not put the equipment in the dusty field

Do not put the equipment in the dusty field.

4. Do not place the equipment under rain or humid environment

Do not place the equipment under humid environment like basement. If the equipment is accidentally in contact with water, please unplug the power cable and immediately contact your local dealer.

5. Keep the surface of the equipment clean and dry

Use soft damp cloth to clean the outer case of DVR (do not use liquid aerosol cleaners)

6. Do not operate if any problems are found

If there are any strange smell or sound from DVR, unplug the power cable and contact the authorized dealer or service center.

7. Do not try to remove the upper cover

Warning: Do not remove the cap of DVR so as to avoid electric shock.

8. Handle with care

If DVR does not work normally because of hitting on the hard object, please contact the authorized dealer for repair or replacement.

9. Use standard lithium battery (Note: Use the batteries attached or specified by the manufacturer)

After cutting off the power supply, if the system clock cannot continue to work, please replace the standard 3V lithium battery on the main board.

Warning: Turn off DVR before replacing the batteries, or you may be suffered from serious electric shock. Please properly dispose of the used batteries.

10. Put the equipment in a place with good ventilation

The DVR system includes HDD, which produces large amount of heat during operation. As a result, do not block the ventilation openings (on the top, bottom, both sides and the reverse side) for cooling the system during operation. Install or put the equipment in the place with good ventilation.

11. The attached power adapter can only be used for 1 set of DVR. Do not connect more equipment, or DVR may be restarted repeatedly because of insufficient power.

12. Prevent the equipment from water dropping or splashing. Do not place objects containing water, such as flower vase, on the equipment.

13. Do not ingest battery, Chemical Burn Hazard,

This product contains a coin / button cell battery.

If the coin / button cell battery is swallowed, it can cause severe internal burns in just 2 hours and can lead to death.

Keep new and used batteries away from children.

If the battery compartment does not close securely, stop using the product and keep it away from children.

If you think batteries might have been swallowed or placed inside any part of the body, seek immediate medical attention.

Chapter 1 Product Overview

1.1 UA-XVL810 Front Panel



Item	Description
Power LED	Show constant green when power is supplied.
HDD LED	Blink red when the HDD is writing or reading data. No LED when no HDD is installed.
USB port	Connect the supplied mouse or USB flash memory.

1.2 UA-XVL810 Rear Panel



Item	Description
Audio Input	Connect with audio input signals, RCA port.
CVBS	Connect with video input signals, BNC port.
Audio Output	Audio signal output, RCA port.
Video Input	Connect with video input devices, BNC port.
HDMI	Connect to your digital TV or monitor with HDMI input.
VGA	Connect to your TV or a monitor with VGA input.
LAN	Connect to your home network.
USB port	Connect the supplied mouse or USB flash memory.
Reset	Load default settings of the DVR. Note: The Reset button is below the USB port. Poke the Reset button to load default settings.
RS-485	Connect to PTZ devices.
Power	Connect to the supplied power adaptor.

1.3 UA-XVL1610 Front Panel



Item	Description
Power LED	Show constant green when power is supplied.
HDD LED	Blink red when the HDD is writing or reading data. Show no LED when no HDD is installed.
SB port	Connect the supplied mouse or USB flash memory.

1.4 UA-XVL1610 Rear Panel



Item	Description
Video Input	Connect with video input devices, BNC port.
Audio Input	Connect with audio input signals, RCA port.
Audio Output	Audio signal output, RCA port.
VGA	Connect to your TV or a monitor with VGA input.
HDMI	Connect to your digital TV or monitor with HDMI input.
LAN	Connect to your home network.
USB port	Connect the supplied mouse or USB flash memory.
Reset	Load default settings of the DVR. Note: The Reset button is below the USB port. Poke the Reset button to load default settings.
Power	Connect to the supplied power adaptor.
RS-485	Connect to PTZ devices.
Sensor & Alarm	Optional. Connect to external sensor & alarm devices.
Power Switch	Turn on / off power supply.

1.5 UA- XVR810 Font Panel



Item	Description
Power LED	Show constant green when power is supplied.
HDD LED	Blink red when the HDD is writing or reading data. No LED when no HDD is installed.
USB port	Connect the supplied mouse or USB flash memory.

1.6 UA-XVR810 Rear Panel



Item	Description
CVBS	Connect with video input signals, BNC port.
Audio Output	Audio signal output, RCA port.
Video Input	Connect with video input devices, BNC port.
Audio Input	Connect with audio input signals, RCA port.
Reset	Load default settings of the DVR. Note: The Reset button is next to the HDMI port. Poke the Reset button to load default settings.
VGA	Connect to your TV or a monitor with VGA input.
HDMI	Connect to your digital TV or monitor with HDMI input.
LAN	Connect to your home network.
USB port	Connect the supplied mouse or USB flash memory.
Power	Connect to the supplied power adaptor.
RS-485	Connect to PTZ devices.
Sensor & Alarm	Optional. Connect to external sensor & alarm devices.
Power Switch	Turn on / off power supply.

Chapter 2 DVR Installation & Connection

2.1 HDD Installation

Follow the instructions below to install the HDD in the DVR for video data storage.

Caution: DO NOT install or remove the hard drive while the power is turned ON.

Note:

1. The DVR supports 3.5" and 2.5" SATA HDD of up to 8 TB only.
 2. The following procedures are for reference only. The practical operation may be different depending on the model you purchased.
-

(1) Cut power firstly. Unscrew both sides and rear panel to open the upper cover.

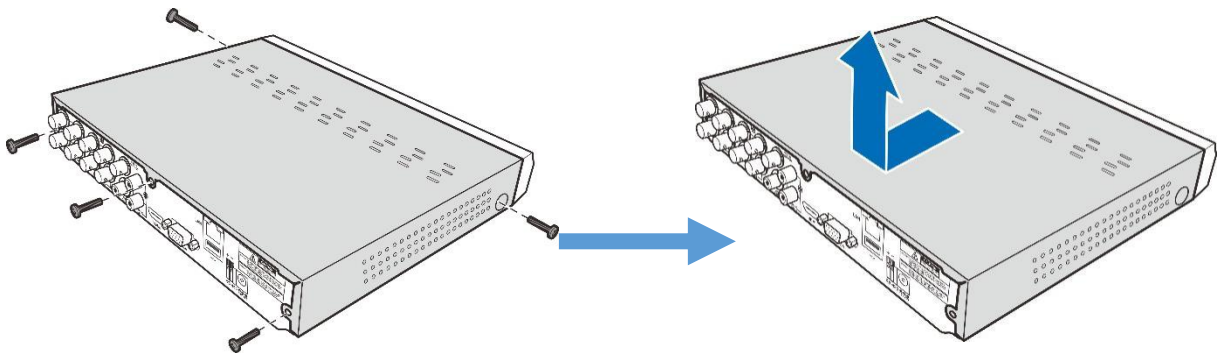

(2) Connect the data and power cables to the HDD and place the HDD on the DVR case. Carefully flip the DVR case and secure the HDD to the DVR with screws.

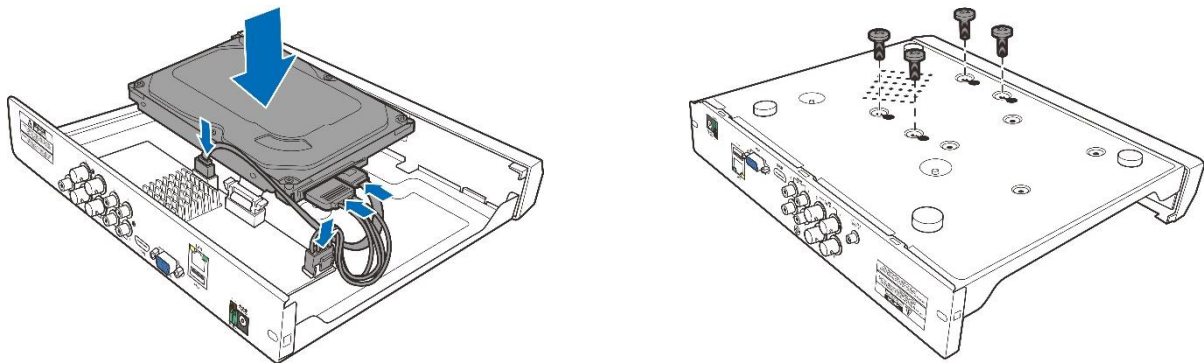

(3) Put the upper cover back carefully and fix the cover with screws.

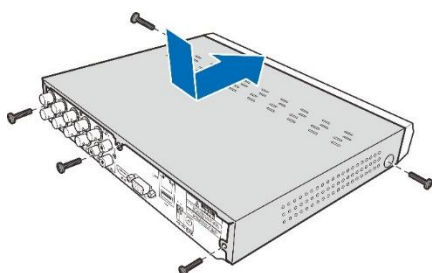

2.2 Connection Diagram

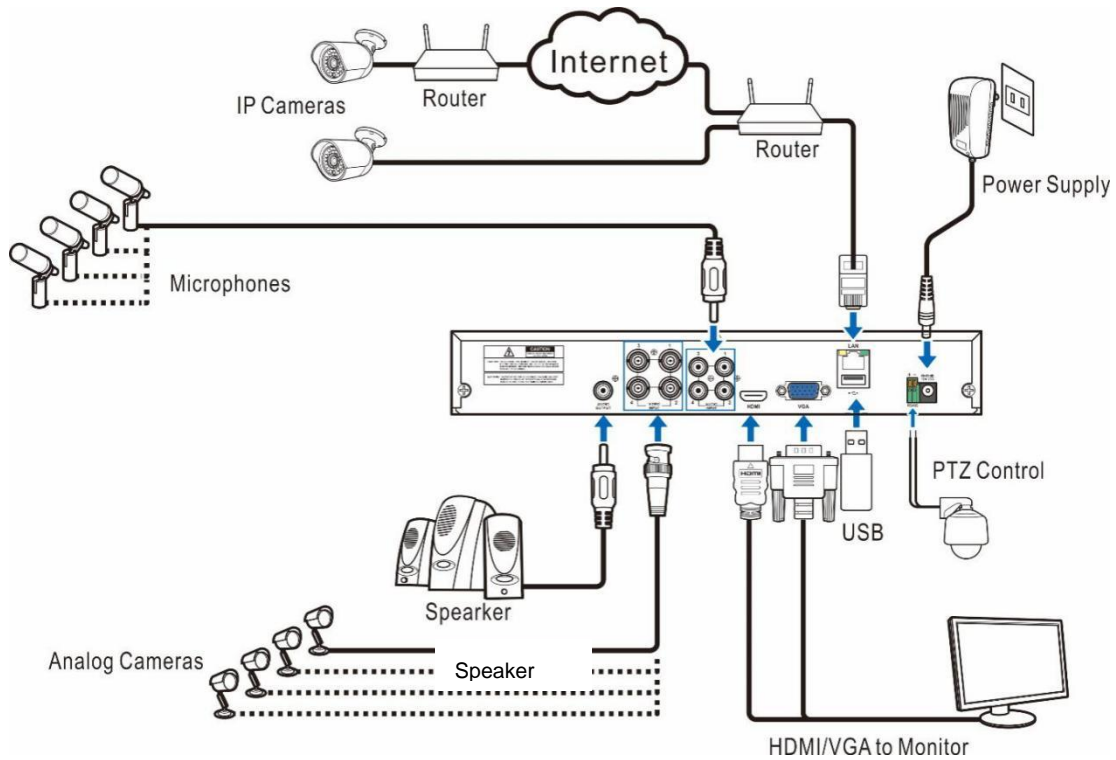

Note: Above diagram is for reference only. The practical connection may be different depending on the DVR you purchased.

2.3 Power Supply Connection

Caution: Use only the supplied power adapter of the DVR.

Connect one end of the power adapter to the power connector on the back of the DVR. Plug the other end of the power adapter into the wall outlet.

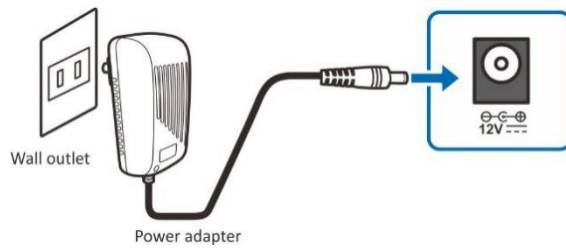

For specific models, press the **Power Switch** to turn on the power.

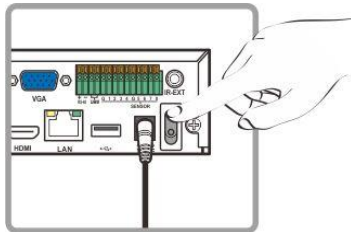

Chapter 3 DVR Common Operations

3.1 Using the Supplied Mouse

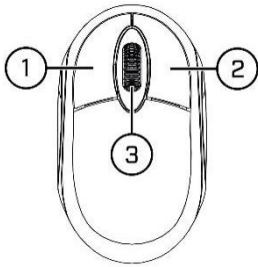

[Left Button]

- Click to select menu options.
- During live viewing in split-screen view, double-click a channel to view it in full-screen. Double-click the channel again to return to split-screen viewing.
- Click a channel on Live Viewing screen to open Camera Quick Toolbar.
- Click and hold to drag sliders and scales on menu mode.

[Right Button]

- Click once to open the Taskbar on the Live Viewing screen. View Taskbar on *4.2.2 Task Menu Bar*.
- In menus, click to go back / close menus.

[Scroll Wheel]

- In menus, scroll to move up / down through the menu content.
- While hovering over the volume control wheel, scroll to turn system volume up / down.

3.2 Using the Virtual Keyboard

You will see the virtual keyboard automatically on the screen when you need to enter data.

Click to toggle the keyboard to upper case and more punctuation

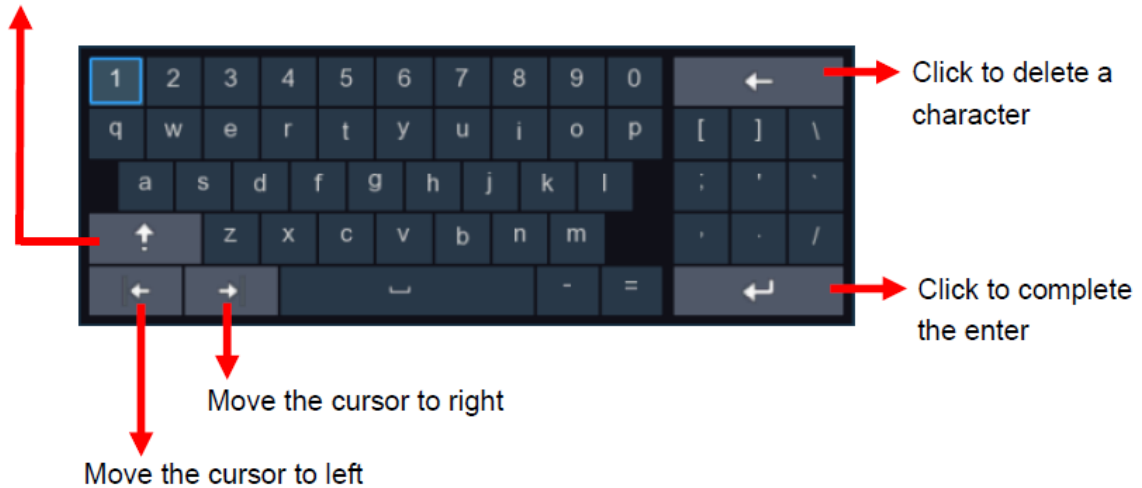

3.3 Password

For the first time when you run the DVR, set your own password immediately in order to protect your privacy. Please be sure to record your username and password and save them in a secure place.

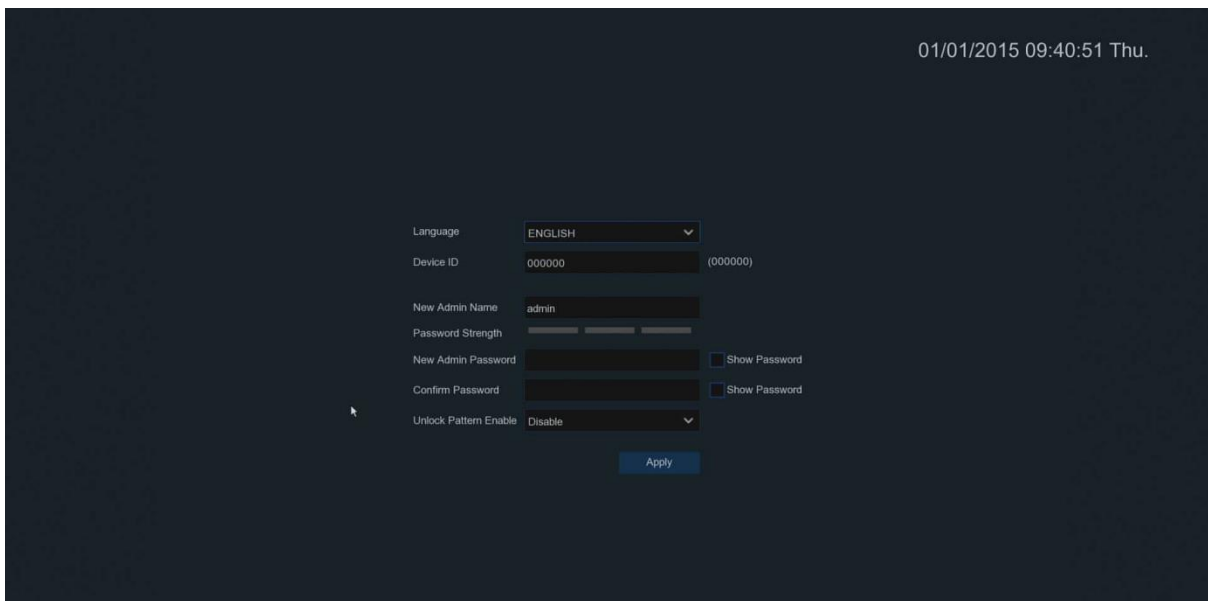

The screenshot shows the password configuration screen with the following fields and options:

- Language: ENGLISH (dropdown menu)
- Device ID: 000000 (text field)
- New Admin Name: admin (text field)
- Password Strength: (progress bar)
- New Admin Password: (password field) with a "Show Password" checkbox.
- Confirm Password: (password field) with a "Show Password" checkbox.
- Unlock Pattern Enable: Disable (dropdown menu)
- Apply button

The top right corner of the screen displays the date and time: 01/01/2015 09:40:51 Thu.

- **Language:** Choose an OSD language.

- **Device ID:** Set a six-digit combination for your device ID or leave the ID as default (000000). Refer to *5.6.1 General* for more details.
- **New Admin Name:** Set your own administrator's name.
- **New Admin Password:** Set your own password. The password must be a combination of 8 characters.
- **Confirm Password:** Enter your password again.
- **Unlock Pattern Enable:** Optionally select **Enable** from the drop-down list and draw the pattern to set the gesture password. After confirming twice, the gesture password is set successfully.

Click **Apply** to confirm your settings and the login interface will appear. Select your user name and enter your password to login the DVR system.

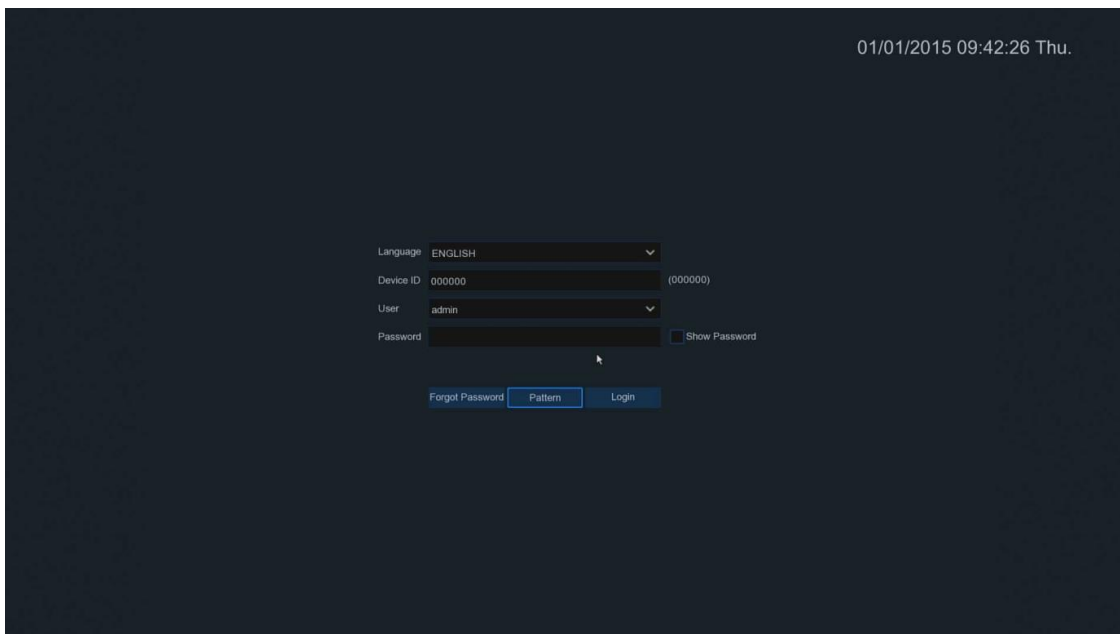

If you enable **Unlock Pattern Enable** function on the setup page, the following page appears. Draw the set pattern to log in the system.

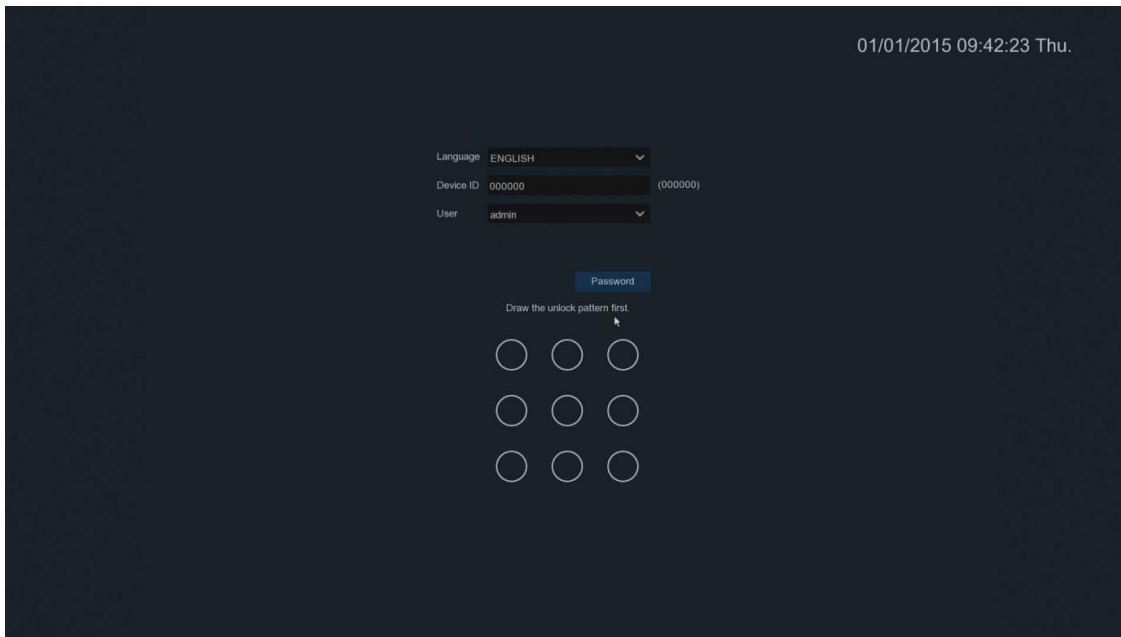

Notice:

If you forget two kinds of password, select **Forgot Password** on the unlock window to reset password. This password is used on the login interface and User setting to change password.

Chapter 4 DVR Starting up

4.1 Start Wizard

Startup Wizard will help to configure the system and get the DVR works quickly.

4.1.1 Start Wizard

Click **Start Wizard** to proceed to the next step.

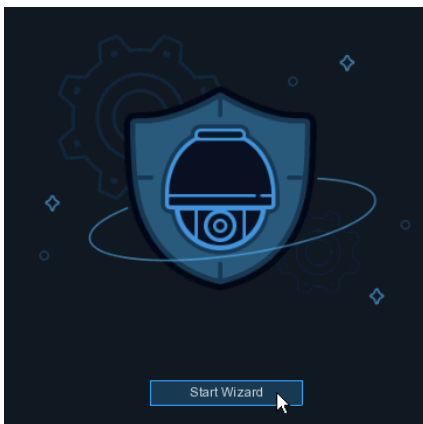

4.1.2 Network Configuration

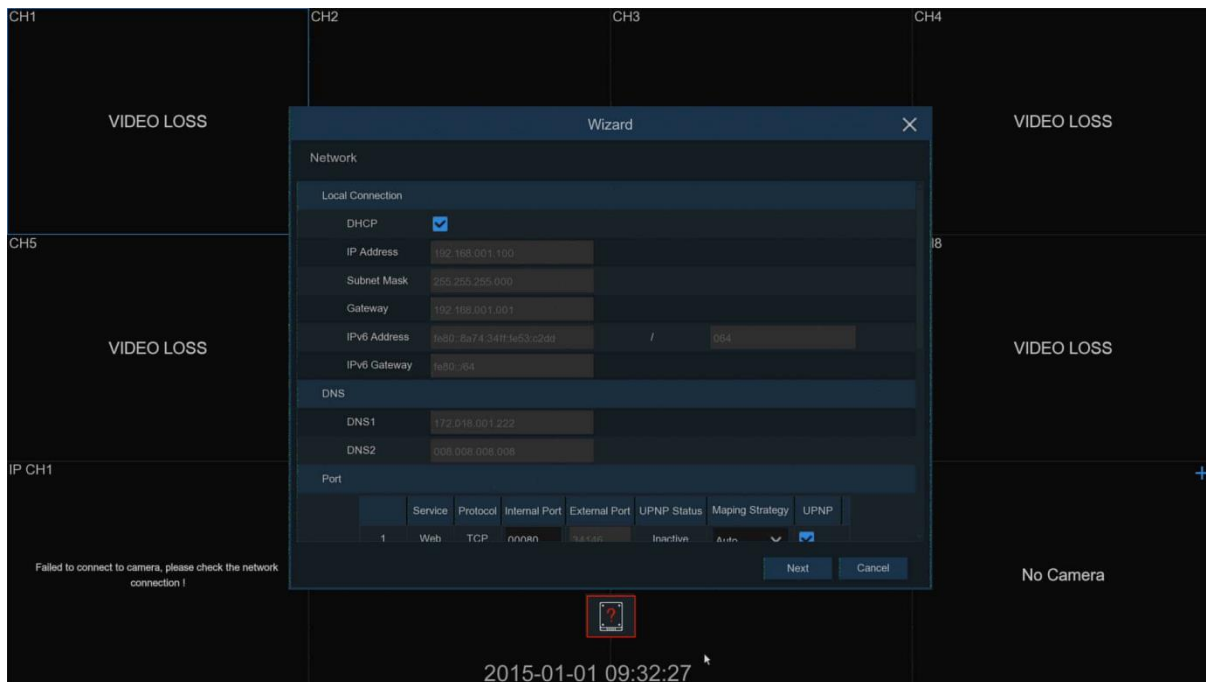

If you connect to a router that allows you to use DHCP, please check the **DHCP** box. The router will automatically assign all the network parameters for your DVR. Unless the network is manually addressed as the parameters below:

[Local Connection]

- **IP Address:** The IP address identifies the DVR in the network. It consists of four groups of numbers between 0 to 255, separated by periods. For example, “192.168.001.100”.
- **Subnet Mask:** Subnet mask is a network parameter which defines a range of IP addresses that can be used in a network. The subnet address also consists of four groups of numbers, separated by periods. For example, “255.255.000.000”.
- **Gateway:** This address allows the DVR to access the Internet. The format of the Gateway address is the same as the IP Address. For example, “192.168.001.001”.

[DNS]

- **DNS1/DNS2:** DNS1 is the primary DNS server and DNS2 is a backup DNS server.

[Port]

- **Web Port:** This is the port that you will use to remotely log in to the DVR. If the default port 80 is already taken by other applications, please change it.
- **Client Port:** This is the port that the DVR will use to send information through (e.g. using the mobile app). If the default port 9000 is already taken by other applications, please change it.

- **RTSP Port:** This is the port that the DVR will be allowed to transmit real-time streaming to other devices.
- **UPnP:** If you want to remotely log in to the DVR using **Web Client**, you need to complete the port forwarding in your router. Enable this option if your router supports the UPnP. In this case, you do not need to manually configure port forwarding on your router. If your router does not support UPnP, make sure the port forwarding is completed manually in your router.

[PPPoE]

This is an advanced protocol that allows the DVR to connect to the network more directly via DSL modem. Check the “Enable PPPOE” box and enter the User name and the password of the PPPoE.

4.1.3 Date/Time

This menu allows you to configure the Date, Time, Date Format, Time Format, Time Zone, NTP and DST.

[Date and Time] Click on the calendar icon to set the current system date.



	Date and Time	NTP	DST
Date	10/25/2017		
Time	15:39:21		
Date Format	MM/DD/YY		
Time Format	24Hour		
Time Zone	GMT+08:00		

- **Date:** Click the calendar icon to set the system date.
- **Time:** Click to set the system time.
- **Date Format:** Choose from the drop-down list to set preferred date format.
- **Time Format:** Choose time format between 24Hour and 12Hour.
- **Time Zone:** Set the correct time zone.

[NTP]

NTP stands for Network Time Protocol. This feature allows you to synchronize the date and time automatically on the DVR over Internet. Note that the DVR needs to be connected to the Internet to enable this function.

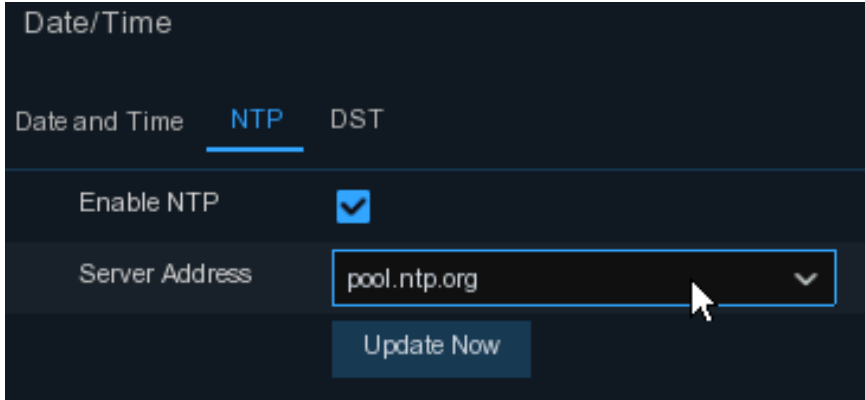

Check the **Enable NTP** box and select the desired NTP server address.

[DST]

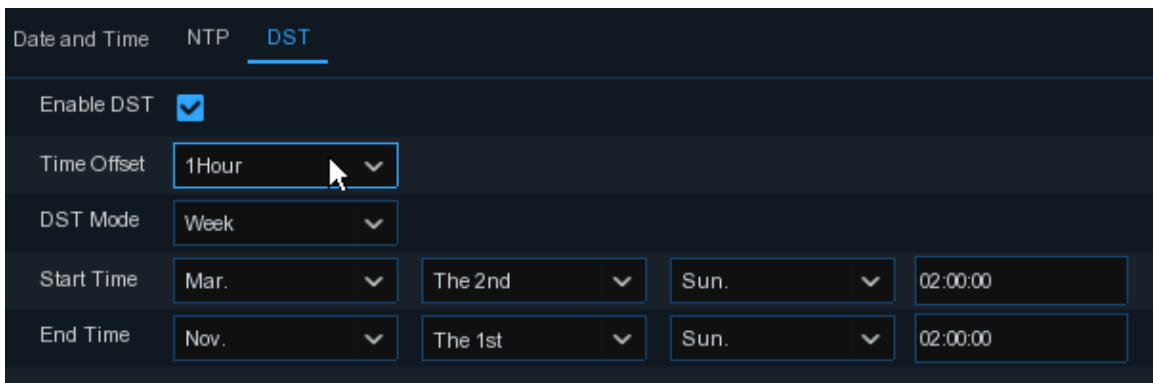

- **Enable DST:** Enable if Daylight Saving Time (DST) is observed in your region.
- **Time Offset:** Select the amount of time to offset for DST.
- **Time Mode:** Choose to set the daylight saving time in weeks or in days.
- **Start Time/End Time:** Set the start time and end time for daylight saving.

4.1.4 IP Camera

This menu allows you to add IP cameras to the DVR.

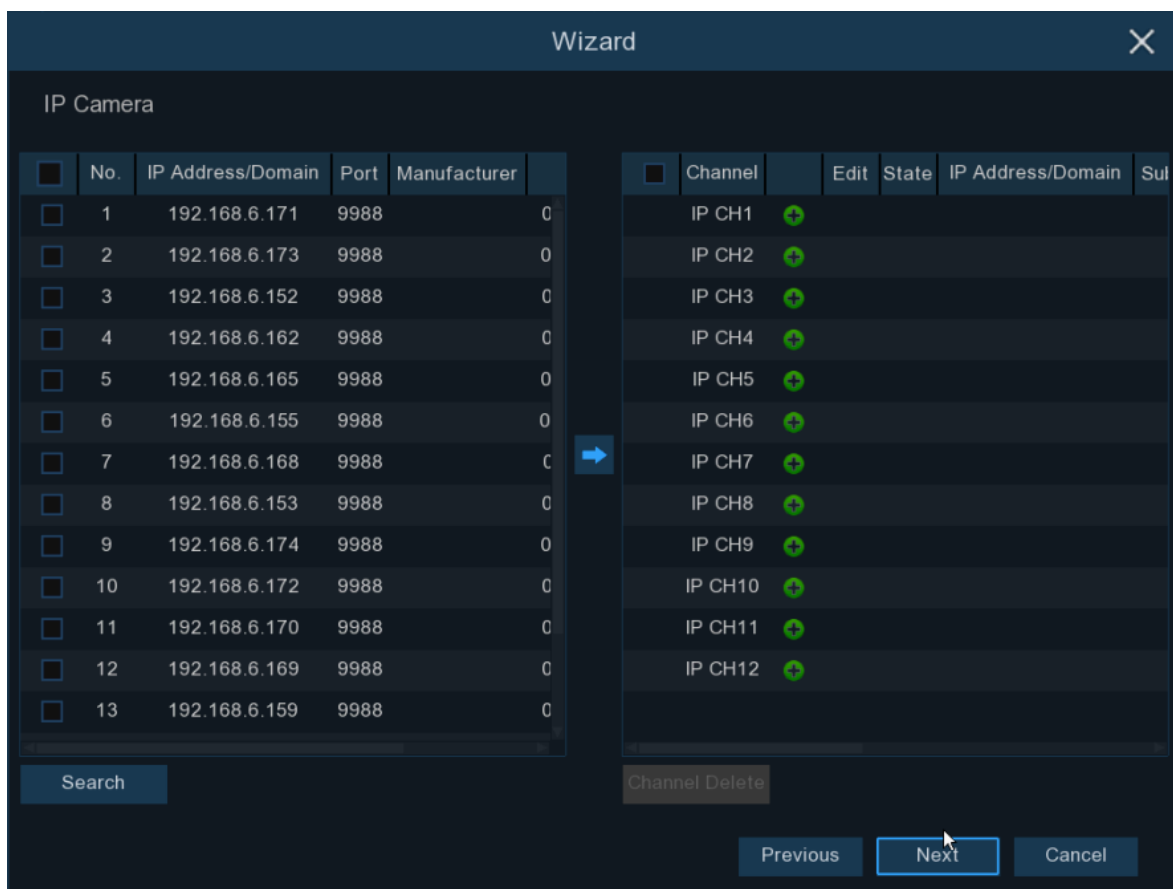

Click **Search** to search IP cameras in the same network. Choose the IP camera(s) you want to add, and then click  icon to add to the DVR.

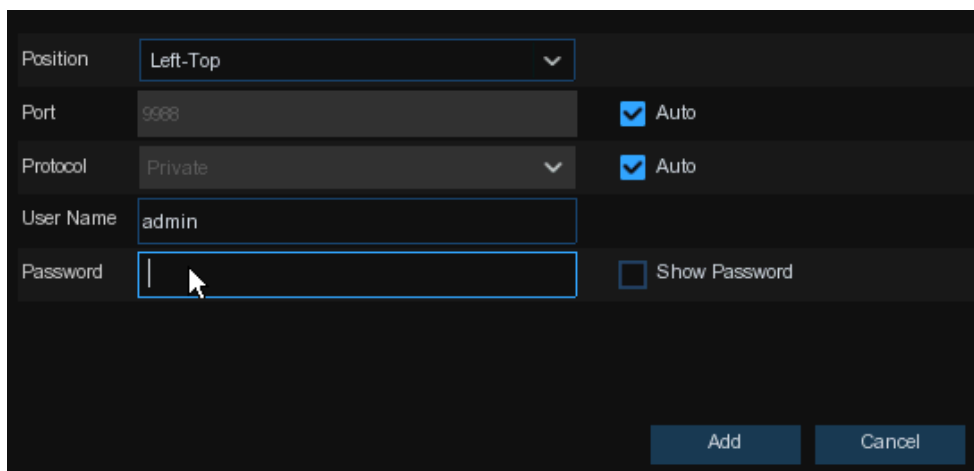

Enter the camera's user name and password to add the camera(s).

You can also click  button to manually add individual IP camera to a single channel.

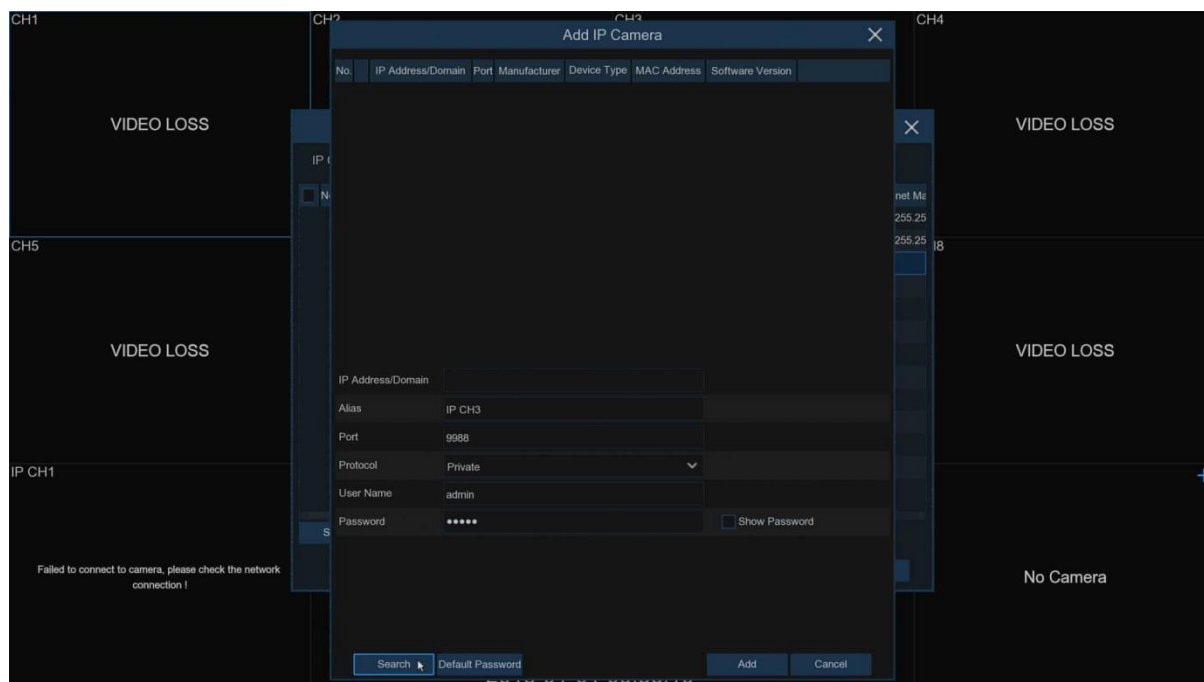

Click **Search** button to search IP cameras, and click one of the IP camera in the device list.

- **IP Address/Domain:** IP address or domain name of the IP camera.
- **Alias:** Name of the IP camera.
- **Port:** Port of the IP camera. (Type **80** for UA-B40004F / UA-B4000VF-S / UA-D40002F / UA-D4000VF-S / UA-R40002F-SA / GV-IP cameras)
- **Protocol:** Choose the protocol of the IP camera from the dropdown menu. (Select **ONVIF** for UA-B40004F / UA-B4000VF-S / UA-D40002F / UA-D4000VF-S / UA-R40002F-SA / GV-IP cameras)
- **User Name:** User Name of the IP camera.
- **Password:** Password of the IP camera.

Note:

1. The system fills in the ID and password using admin/admin by default. Make sure to enter the correct ID and password of the IP cameras when adding them to the DVR.
 2. The default password is 123456 for the following IP camera models: UA-B40004F / UA-B4000VF-S / UA-D40002F / UA-D4000VF-S / UA-R40002F-SA. To modify the password on the camera's Web interface, refer to [Network Cameras User Manual](#) for details.
-

4.1.5 Disk

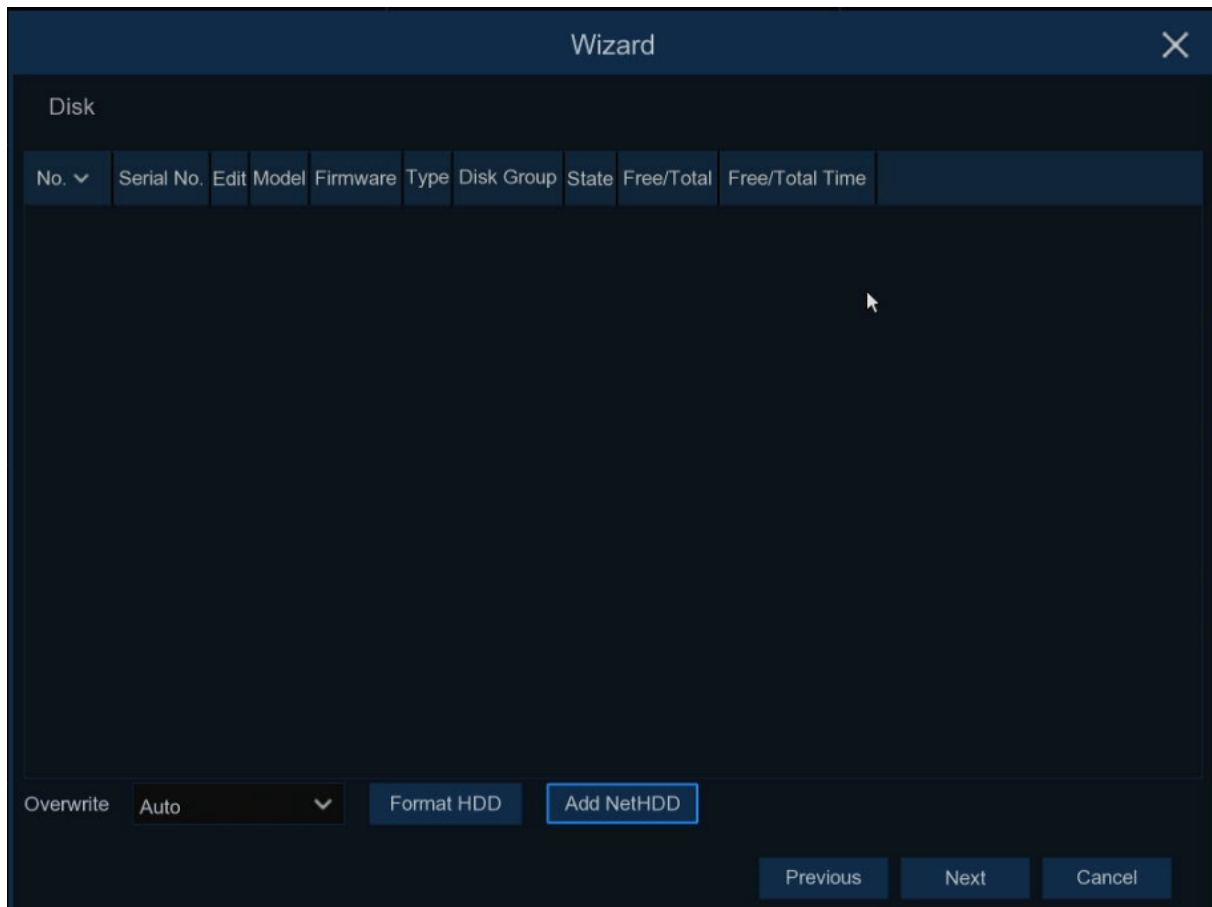

- **Format HDD:** If the HDD is installed in the DVR for the first time, it must be formatted. Select the HDD and click **Format HDD** button to format the HDD.
- **Overwrite:** Use this option to overwrite the old recordings on the HDD when the HDD is full. For example, if you choose **7 days**, only the last 7 days recordings will be stored on the HDD. To prevent overwriting any old recordings, select **Disable**. If you have disabled this function, please check the HDD status regularly to make sure the HDD is not full.
- **Add NetHDD:** Refer to *5.5.1.1 Disk* for details.

4.1.6 Resolution

Choose an output resolution that matches to your monitor. The DVR can automatically adjust the output resolution to match the best resolution of your monitor when the system is starting up.

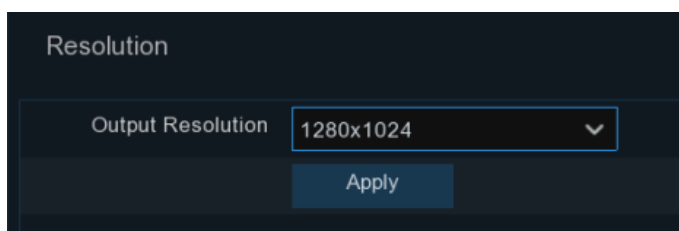

4.1.7 Mobile

Scan the QR code with your mobile app GV-Eye to view the DVR remotely. Refer to *Chapter 8 Remote Access via Mobile Devices* for details.

Mobile	
P2P ID	
P2P ID	RSV1907010420595
Local Connection	
IP Address	192.168.6.28
Subnet Mask	255.255.255.0
Port	
Web Port	80
Client Port	9000



Note: This function is only applicable to GV-Eye V2.9 or later.

4.1.8 Summary

You can check the system summary information you had set in the start wizard and finish the wizard.

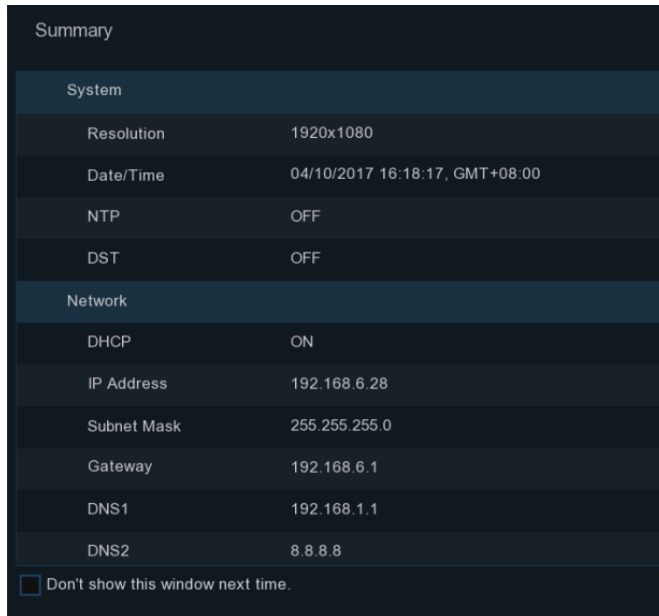

Click **Don't show this window next time** if you don't want to display Start Wizard when the system reboots. Click **Finish** button to save and exit **Start Wizard**.



4.2 Live View Screen Overview





No.	Name	Description
1	Camera Title	<p>A-: This indicates that the camera connected is an AHD camera.</p> <p>T-: This indicates that the camera connected is a TVI camera.</p> <p>C-: This indicates that the camera connected is a CVI camera.</p> <p>IP: This indicates that the camera connected is an IP camera.</p>
2	Status Icon	<p> This indicates that the DVR is currently recording.</p> <p> This icon appears when the camera has detected motion.</p> <p> The icon indicates that the external I/O alarm device is triggered.</p> <p> This icon indicates that the HDD is in error to work.</p> <p> This icon indicates the HDD is unformatted.</p> <p> This icon indicates the HDD is full.</p> <p> This icon indicates the HDD is read-only.</p>
3	Camera Quick Toolbar	Left-click on the screen to quickly access the camera's toolbar. Refer to <i>4.2.1 Camera Quick Toolbar</i> for details.
4	Start Menu	<p>■ admin: To switch user.</p>

		<ul style="list-style-type: none"> ■ Search: Search & Playback. ■ Setup: DVR System Setup. ■ Lock Screen: Lock and unlock screen. ■ Shutdown: Shut down, reboot, and log out the system.
5	Task Menu Bar	Locates at the bottom of the live view screen. Refer to <i>4.2.2 Task Menu Bar</i> for details.
6	System Date and Time	Displays the system's date and time.
7	OSD	<ul style="list-style-type: none"> ■ VIDEO LOSS: The analog camera is disconnected. ■ No Camera: IP camera is disconnected. ■ Decoding Failed: The DVR doesn't support the current IP camera compression standard. Change the compression standard to H.264. ■ Click  to open Quick Add menu to add IP camera. ■ Click  to edit the current IP camera.

4.2.1 Camera Quick Toolbar

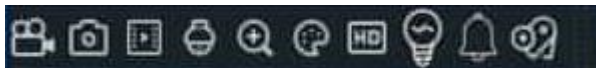
In live viewing, click the left button of your mouse on a connected camera to display the **Camera Quick Toolbar**.





 Click to manually record the channel. If the manual recording is in process, the icon will be in red color. Click one more time to stop manual record.

 Click to save a snapshot of the current camera image. **Manual Capture** must be enabled to use this feature. Refer to *5.2.3.1 Capture* for details.



[5.2.3.1 Capture](#)  Click to play the last 5 minutes of recording of this channel.

 Click to enter PTZ control panel.

 Click to zoom-in the channel. When the  icon appears, press and hold the left button of your mouse to drag the area you want to zoom in.











 Click to adjust the image color of the channel. You can adjust the HUE, BRIGHT, CONTRAST & SATURATION of the image.

 Click to switch main/sub stream

-  Click to enable/disable white light alarm. Note that this menu won't change the white light setting parameter.
-  Click to enable/disable alarm of this channel. This menu won't change the white light setting parameter.
-  Click to add customized tag. It can be found in **Tag** playback. Refer to *6.1.5 Tag Playback* for details.

4.2.2 Task Menu Bar



-  Click to open the **Start Menu**.
-  **+layout20 icon** Click to choose different layouts for live view.
-  **More Layout:** Click to choose more layouts for live view.
-  **Auto SEQ:** Click to start viewing channels in a sequence.
-  **Playback:** You can choose to play the latest recording for all channels from the beginning of the day, or you can choose the playback from the latest 5s, 10s, 30s, 1Min, 5Min.
-  **Audio:** Click to adjust audio volume.
-  **Preview Policy:** Click to switch among real-time, balanced, or smooth view. This function only effects the live view video quality by bitrate and frame rate without impacting the recording quality.
-  **Manual:** To start or stop **Manual Record** and **Manual Alarm**.
-  **System:** To view system information, channel information, record info, and network state.
-  This icon appears if the network is disconnected.

4.2.3 Start Menu

With the **Start Menu**, you can switch user, search and playback, enter system setup menu, lock and unlock the screen, shut down, reboot and log out the system.

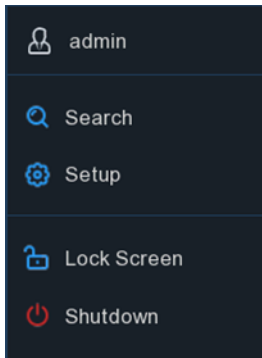

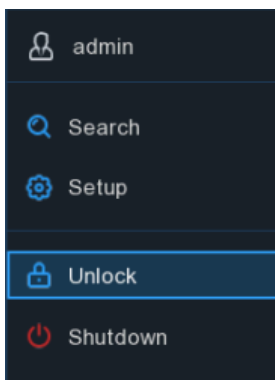

- **admin:** To switch user. To enable multi-user, refer to *5.6.3 Multi-user*.
- **Search:** Search & Playback. Refer to *Chapter 6 Search, Playback and Backup* for details.
- **Setup:** DVR System Setup. Refer to *Chapter 5 DVR System Setup* for details.
- **Lock Screen:** Lock and unlock screen. Refer to *4.2.3.1 Unlock and Lock Screen* for details.
- **Shutdown:** Shut down, reboot, and log out the system. Refer to *4.2.3.2 Shutdown* for details.

4.2.3.1 Unlock and Lock Screen



The screen will be locked to protect unauthorized OSD operation while the DVR is not in menu operation for over 1 minute.

If necessary, you can also lock the screen operation manually. To do so, go to **Start Menu** and click the **Lock Screen**  icon to lock the system.

If the system is locked, you can click the **Unlock**  icon to unlock the system for further operation. You can optionally click **Pattern** to unlock the system.

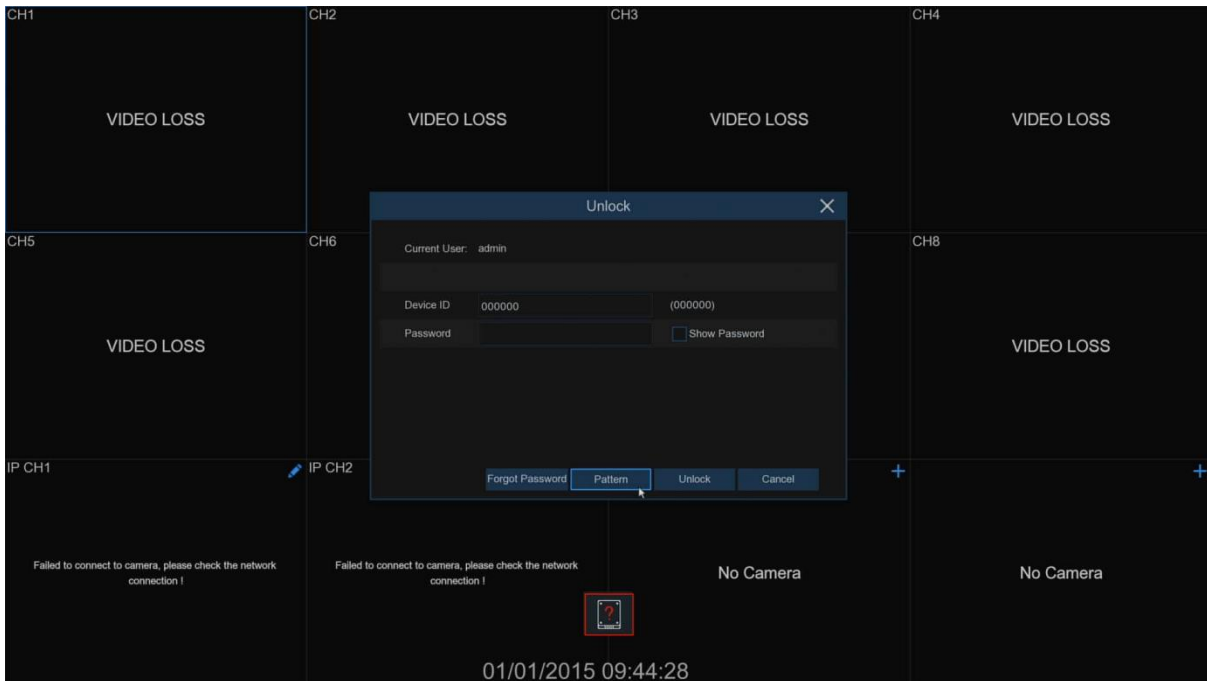

4.2.3.2 Shutdown

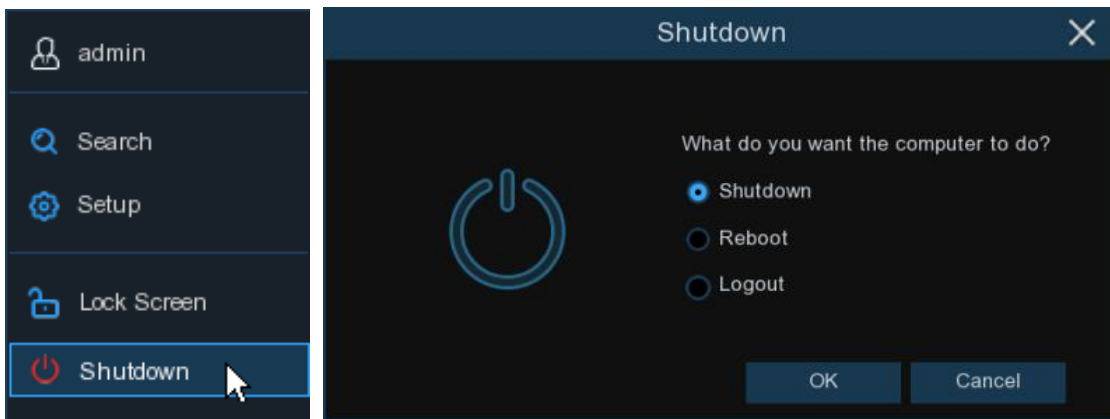

Click the **Shutdown** button from **Start Menu** and select the desired action. Click **OK** and type the password when the **Authentication** window appears.

Chapter 5 DVR System Setup

You are able to configure the DVR for Channel, Record, Alarm, Network, Device & System from **Start Menu → Setup**.

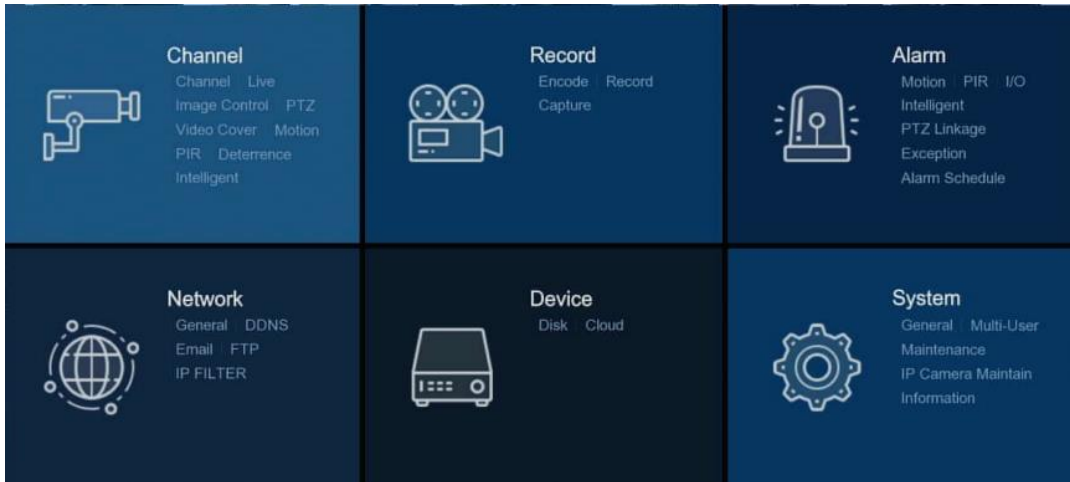

5.1 Channel

In this section, you are allowed to configure the camera, live view display, manage IP cameras, adjust IP camera's image, PTZ setup, motion setup, convert mode, and more.

5.1.1 Channel

5.1.1.1 Analog Channels

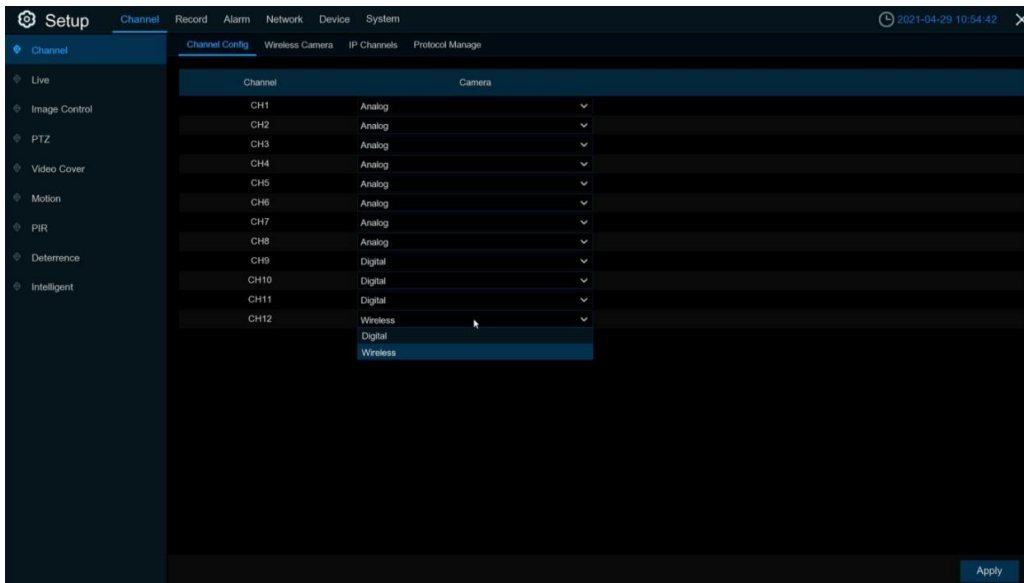

UA-XVL1610/XVR810 allow you to disable analog channels to increase IP channels.

To disable an analog channel, uncheck the box and click **Apply** to save. To do so, you need to enable the XVR mode in advance at **System → General → Mode**. Refer to *5.6.1 General* for details.

Moreover, part of the device supports adding wireless channels. Choose the **Wireless**, the sub channel will become wireless channel. Choose the **Digital**, it will back to digital channel. Please note, analog channel can't switch to wireless channel.

5.1.1.2 IP Channels

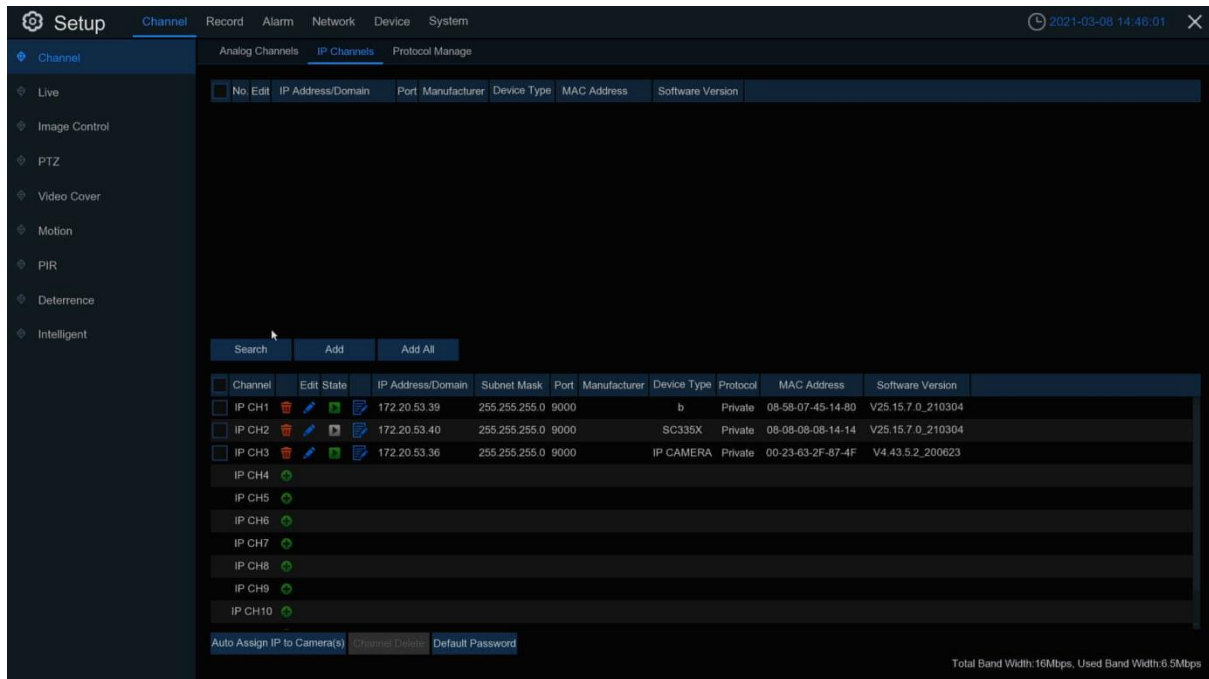

Enable the XVR mode for the DVR to add IP cameras and modify IP channels.

Click **Search** to search IP cameras from local network, click **Add** to add individual IP camera, or click **Add All** to add all IP cameras.

Click **Search** to search IP cameras and double click one of the IP camera in the device list.

- **IP Address/Domain:** IP address or domain name of the IP camera.
- **Alias:** Name of the IP camera.
- **Port:** Port of the IP camera. (Type **80** for UA-B40004F / UA-B4000VF-S / UA-D40002F / UA-D4000VF-S / UA-R40002F-SA / GV-IP cameras).

- **Protocol:** Choose the protocol of the IP camera from the drop-down list. (Select **ONVIF** for UA-B40004F / UA-B4000VF-S / UA-D40002F / UA-D4000VF-S / UA-R40002F-SA / GV-IP cameras).
 - **User Name:** User Name of the IP camera.
 - **Password:** Password of the IP camera.
 - **Bind channel:** Choose a channel of the DVR you want to attach to.
 - **Auto Assign IP to Camera(s):** The added IP camera would not be able to connect to the NVR if its IP address is not under the same network segment with NVR. Enable this function to reassign IP addresses to all added IP cameras.
 - **Channel Delete:** Choose one or more added IP cameras and click this button to delete the channel.
 - **Default Password:** To set an IP camera's default password.
- Modify IP Cam Settings:** Click the **Edit** icon  and the page appears.

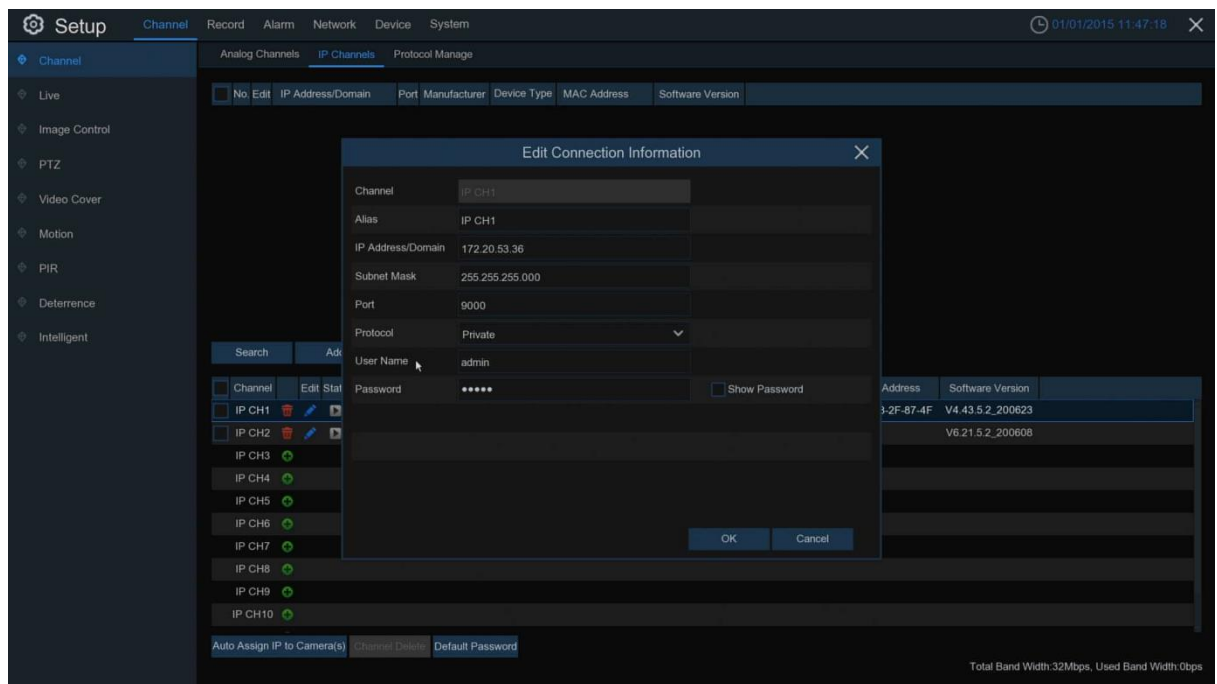

5.1.2 Live

To configure camera parameters.

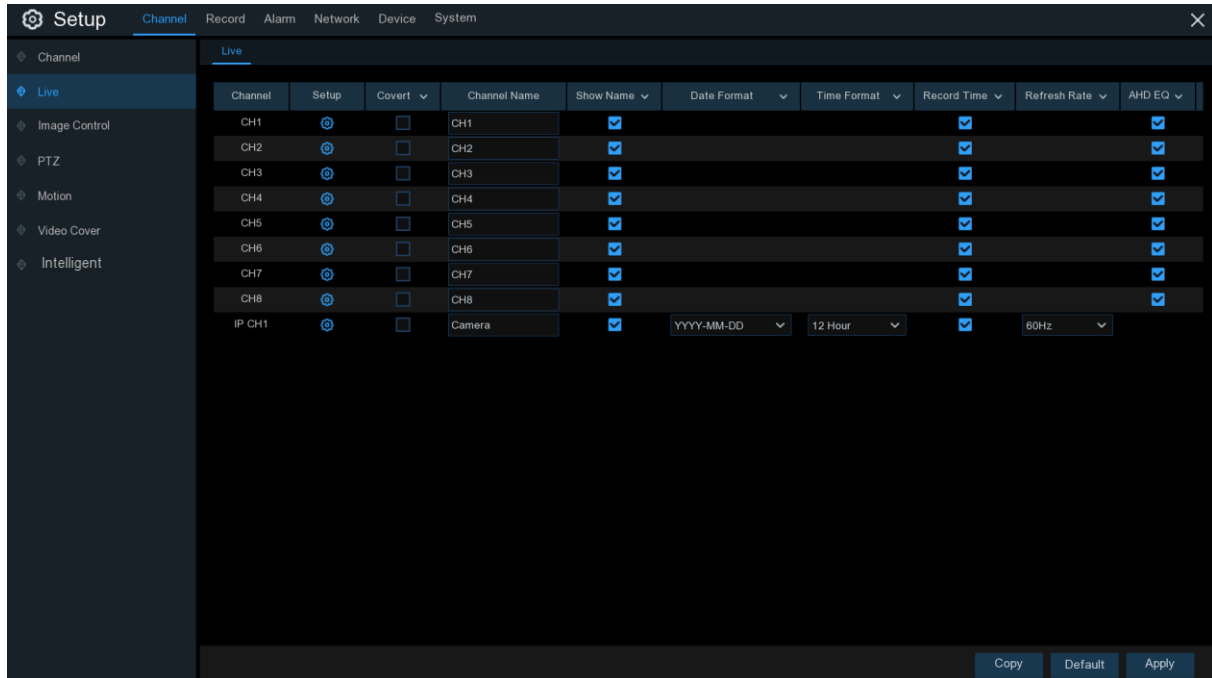

- **Channel:** Display channel name.
- **Setup:** Click  icon into the setup page.
 - ⊙ **Channel:** Choose a channel to configure.
 - ⊙ **Channel Name:** Name the camera.
 - ⊙ **Date Format:** Date format to display for the camera (for IP camera only).
 - ⊙ **Time Format:** Time format to display for the camera (for IP camera only).
 - ⊙ **Camera Type:** Choose a camera type (Auto, AHD, TVI, CVI) for analog camera(s).
 - ⊙ **Covert:** Check the box If you want to hide the live image of this channel.
 - ⊙ **Show Name:** To show the camera name on live view.
 - ⊙ **Show Time:** To show the system time on live view.
 - ⊙ **HUE:** Adjust the hue value for the image color.
 - ⊙ **BRIGHT:** To adjust the bright value for the image color.
 - ⊙ **CONTRAST:** To adjust the contrast value for the image color.
 - ⊙ **SATURATION:** To adjust the saturation value for the image color.
 - ⊙ **SHARPNESS:** To adjust the sharpness value for the image color.
 - ⊙ **Default:** Click **Default** to load default settings.

Click **Apply** to save settings, or right-click on your mouse to exit.

5.1.3 PTZ

This menu allows you to set up your PTZ camera(s).

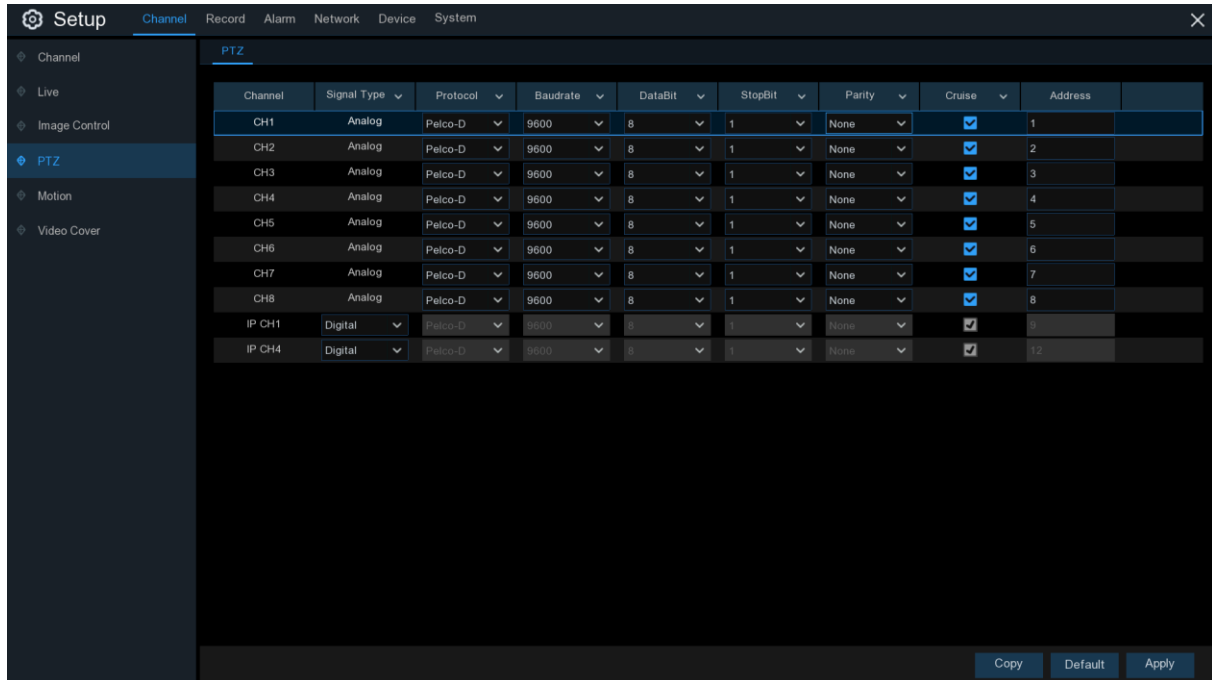



- **Channel:** Channel name.
- **Signal Type:** **Analog** for analog channels, **Analog / Digital** for IP channels.
- **Protocol:** Choose the communication protocol between the PTZ camera and DVR. If your camera supports UTC (Up the Coax) function, choose COAX1 or COAX2 to display your camera OSD menu or control the UTC PTZ function.
- **Baudrate:** The speed of the information sent from the DVR to the PTZ camera. Make sure it matches the compatibility level of your PTZ camera.
- **DataBit / StopBit:** The information between the DVR and PTZ camera is sent in individual packages. **DataBit** indicates the number of bits sent, while the **StopBit** indicates the end of the package and the beginning of the next (information) package. The available **DataBit** parameters are: **8, 7, 6, 5**, and the available parameters for the **StopBit** are **1 or 2**.
- **Parity:** For error check. See the documentation of your PTZ camera, to configure this setting.
- **Address:** Set the command address of the PTZ system. Note that each PTZ camera needs a unique address to function properly.

5.1.3.1 PTZ Control

After finishing the PTZ setup, you can use the PTZ function to control your PTZ camera.

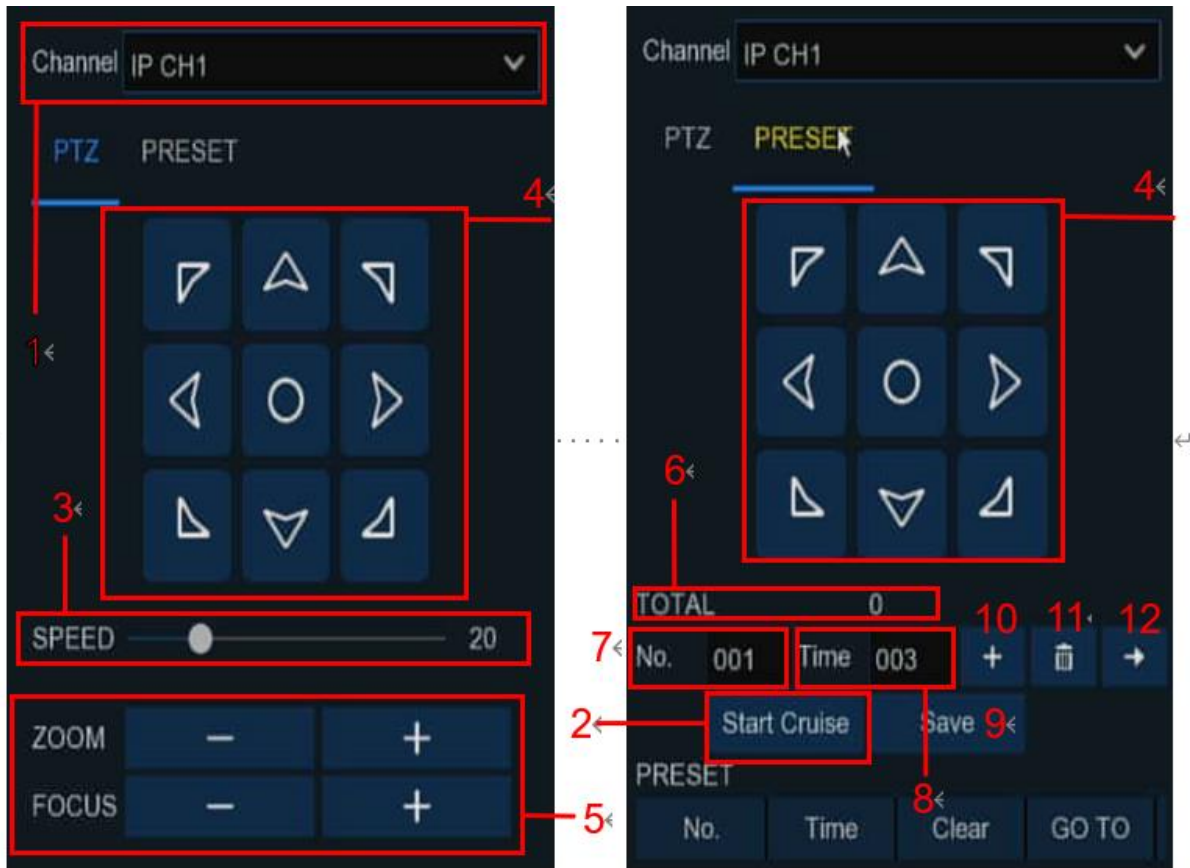
- 1) Left-click your mouse upon a channel on Live Viewing screen to open *4.2.1 Camera Quick Toolbar*, and choose the PTZ control icon .
- 2) PTZ control panel will be displayed.



No.	Item	Description
1	Channel	Click to select the channel of the PTZ camera.
2	Cruise	Start / stop PTZ cruise by preset points.
3	Speed	Adjust the PTZ speed.
4	Pointer Panel	<p>A) Click the direction arrow to select the direction of the PTZ camera.</p> <p>B) Click up / down / left / right arrow to move cursor in UTC OSD menu.</p> <p>C) Click  to switch to auto pan mode.</p>
5	Zoom	Click to zoom in / out.

	Focus	Click to adjust the focus.
	Iris	Click to adjust the iris setting (if the device supports).
6	Total	Display the total number of preset points.
7	No	Number of preset points.
8	Time	Set the time duration for the camera to stay in the preset point.
9	Save	Click to save the settings and preset points.
10	Set	Click to set preset points for PTZ cameras. A maximum of 255 preset points is available for each DVR.
11	Clear	Click to delete the selected preset point.
12	GO TO	Click to move your PTZ camera to the preset point.

5.1.4 Video Cover

This menu allows you to create privacy zone(s) if you want to partially cover certain part of the image. You can create up to 4 privacy zones in any size and location on the camera image. Select **Enable Privacy Zone** and choose the number of zones you need. Click the edge of the red box and drag it to adjust its size.

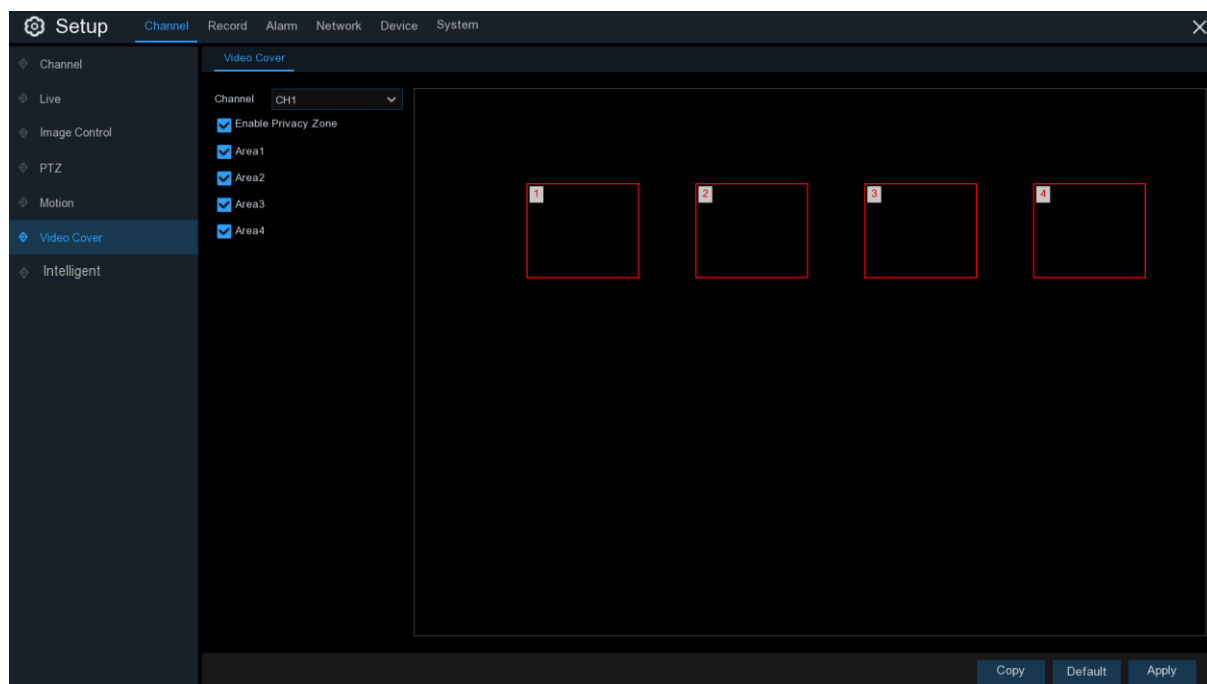

Note: The area of privacy zones you have set will be invisible in both live view and recording video.

5.1.5 Motion

This menu allows you to configure motion parameters. When motion has been detected by one or more cameras, your DVR will send an email alert with an attached image from the camera (if this option is enabled) and / or send push notifications via the mobile app.

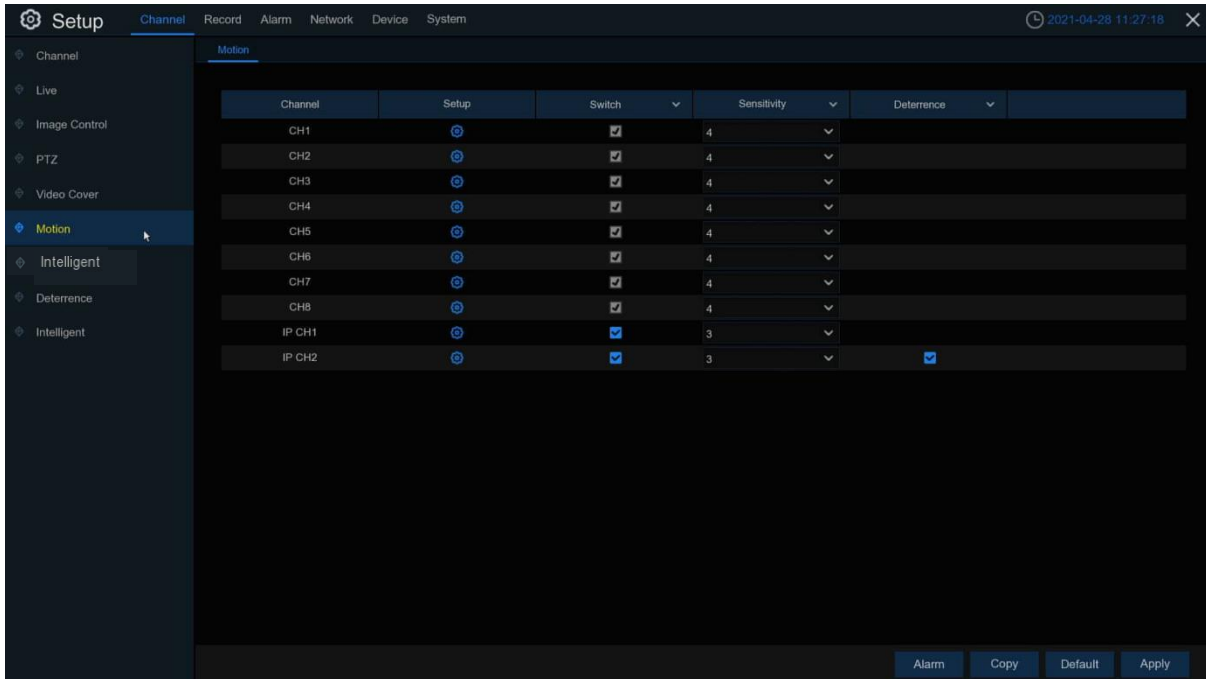

- **Setup:** Click the icon to enter the setup page.

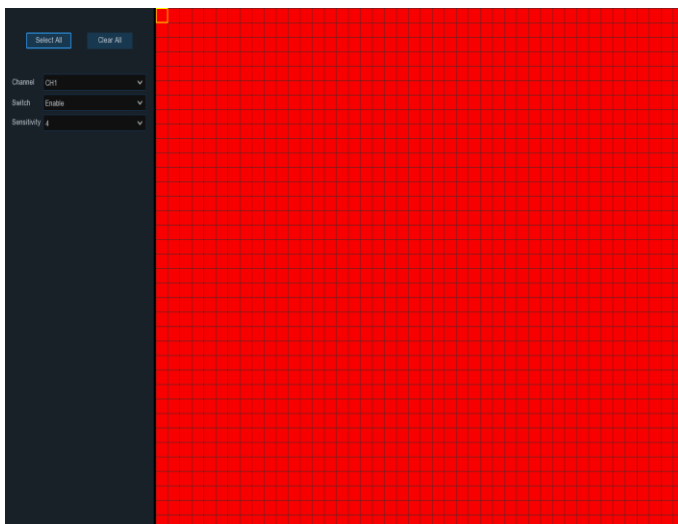

Motion Detection Area: The whole screen is marked for motion detection (red blocks) by default. If you want to disable the motion detection on a certain area, drag your mouse to highlight the scope to unmark the area. Right-right to save the setting and return to the **Motion** setting page.

- **Switch:** Check the box to enable motion detection.

- **Sensitivity:** Set the sensitivity level. The sensitivity level ranks from Level 1 the lowest to level 8 the highest.
- **Deterrent:** Enable spotlight linkage alarm. When PIR alarm is triggered, the spotlight will be triggered [5.1.7 spotlight alarm settings](#).

Click **Alarm** to configure the motion detection alarm function:

Channel	Buzzer	Alarm Out	Latch Time	Record	Post Recording	Show Message	Send Email	Full Screen
CH1	Disable	<input type="checkbox"/>	10 s	ON	30 s	<input checked="" type="checkbox"/>	<input checked="" type="checkbox"/>	<input type="checkbox"/>
CH2	Disable	<input type="checkbox"/>	10 s	ON	30 s	<input checked="" type="checkbox"/>	<input checked="" type="checkbox"/>	<input type="checkbox"/>
CH3	Disable	<input type="checkbox"/>	10 s	ON	30 s	<input checked="" type="checkbox"/>	<input checked="" type="checkbox"/>	<input type="checkbox"/>
CH4	Disable	<input type="checkbox"/>	10 s	ON	30 s	<input checked="" type="checkbox"/>	<input checked="" type="checkbox"/>	<input type="checkbox"/>
CH5	Disable	<input type="checkbox"/>	10 s	ON	30 s	<input checked="" type="checkbox"/>	<input checked="" type="checkbox"/>	<input type="checkbox"/>
CH6	Disable	<input type="checkbox"/>	10 s	ON	30 s	<input checked="" type="checkbox"/>	<input checked="" type="checkbox"/>	<input type="checkbox"/>
CH7	Disable	<input type="checkbox"/>	10 s	ON	30 s	<input checked="" type="checkbox"/>	<input checked="" type="checkbox"/>	<input type="checkbox"/>
CH8	Disable	<input type="checkbox"/>	10 s	ON	30 s	<input checked="" type="checkbox"/>	<input checked="" type="checkbox"/>	<input type="checkbox"/>
IP CH1	Disable	<input type="checkbox"/>	10 s	ON	30 s	<input checked="" type="checkbox"/>	<input checked="" type="checkbox"/>	<input type="checkbox"/>
IP CH4	Disable	<input type="checkbox"/>	10 s	ON	30 s	<input checked="" type="checkbox"/>	<input checked="" type="checkbox"/>	<input type="checkbox"/>

Copy Default Save

- **Buzzer:** The DVR can use its internal buzzer to emit an alarm tone. You can set the buzzer duration up to 1 minute when the motion is detected.
- **Alarm Out:** Set to emit an alarm tone.
- **Latch Time:** To configure the external alarm time when motion is detected.
- **Record:** Click the icon and choose the channel(s) you wish to record when motion detection is triggered.

Record Channel

Analog Channels 1 2 3 4 5 6 7 8

IP Camera 1 2 3 4 5 6 7 8 9 10 11 12

- **Post Recording:** Set the time length for the DVR to continue recording after an event occurs. The recommended recording length is 30 seconds but the DVR is able to record for up to 5 minutes.
- **Show Message:** Check the box to display icon on the live view screen when the motion is detected.
- **Send Email:** Check to enable the DVR to send email(s) when the motion is detected.

- **FTP Picture Upload:** To upload alarm images to FTP server when alerts are triggered. Refer to 5.4.4 *FTP* for details.
- **FTP Video Upload:** To upload alarm videos to FTP server when alerts are triggered. Refer to 5.4.4 *FTP* for details.
- **Picture to Cloud:** To upload alarm images to cloud when alerts are triggered. Refer to 5.5.2 *Cloud* for details.
- **Video to Cloud:** To upload alarm videos to cloud when alerts are triggered. Refer to 5.5.2 *Cloud* for details.
- **Full Screen:** If this function is enabled and a motion is detected on a certain channel, the channel will be in full screen.

5.1.6 Intelligent

The optional intelligent functions include **Perimeter Intrusion Detection, Line Crossing Detection, Stationary Object Detection, Pedestrian Detection, Face Detection, and Cross Counting.**

5.1.6.1 PID (Perimeter Intrusion Detection)

Perimeter Intrusion Detection function detects people, vehicles or other objects that enter and loiter in a pre-defined virtual region, and certain actions can be taken when the alarm is triggered.

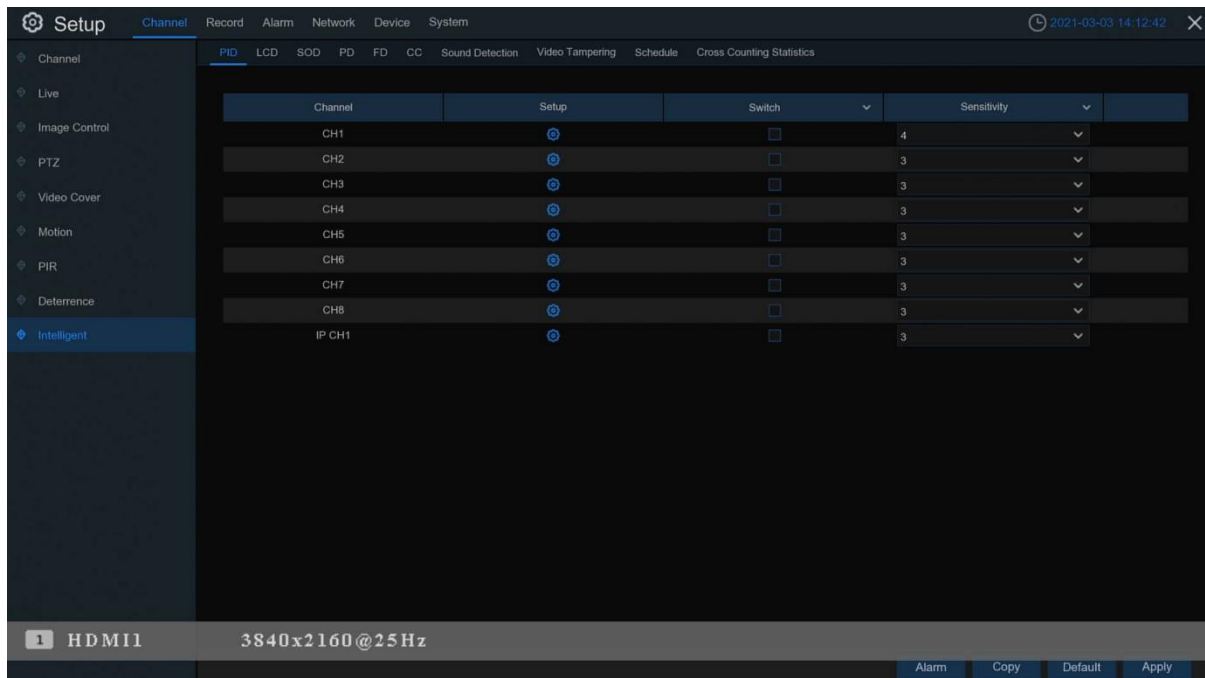

Switch: Enable or disable the PID function

Sensitive: The sensitivity level is from 1 to 4. Higher sensitivity will be easier to trigger the detection.

Area: Click [**Setup**] to draw a virtual region in the camera picture.

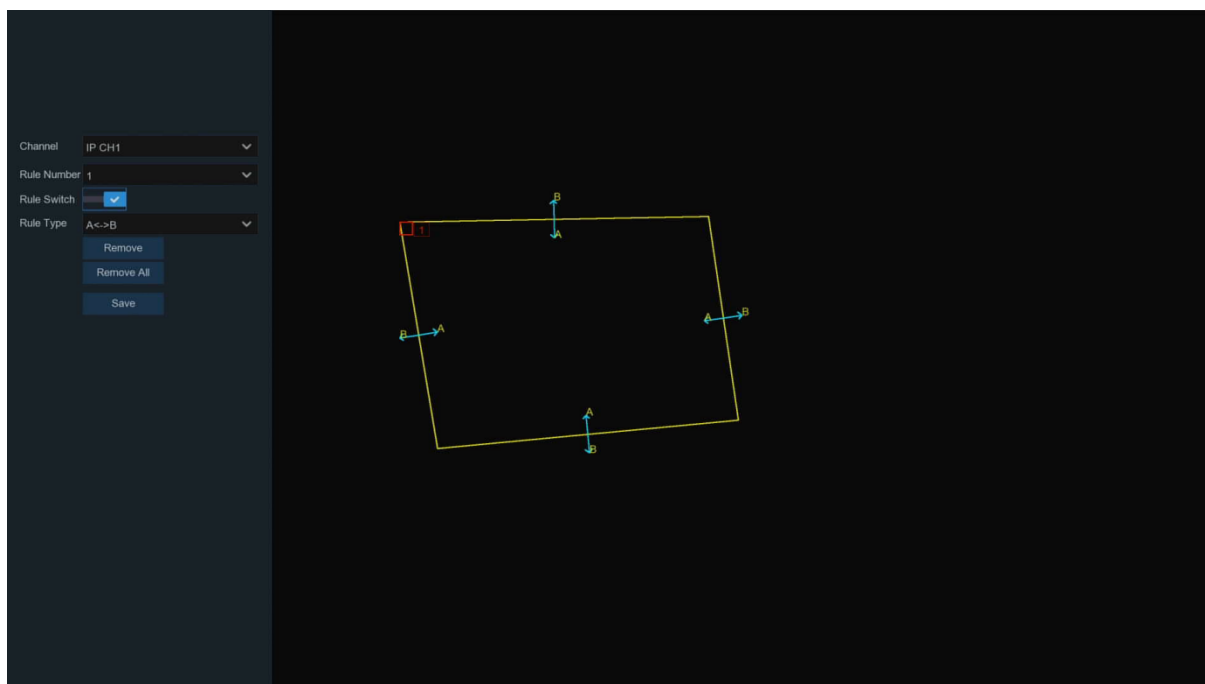

1. **Channel:** Select the channel you want to configure
2. Choose one of the Rule Number. It is the number of PID area. Maximum 4 areas you can set for PID function
3. To enable the detection in **Rule Switch**
4. Choose a **Rule Type**.
 A→B: DVR will only detect the action from side A to side B;
 B→A: DVR will only detect the action from side B to side A;
 A↔B: DVR will detect the action from either side B to side A or side A to side B.
5. Use your mouse to click 4 points in the camera picture to draw a virtual region. The sharp of the region should be a convex polygon. Concave polygon will be not able to save.
6. Click **Save** to save your settings.
7. If you want to modify the position or sharp of region, click the red box in the region, the borders of the region will be changed to red color. Long press the left button of your mouse to move the position of the region, or drag the corners to resize the region.
8. If you want to remove one of the regions from the camera picture, click the red box in the region and then click **Remove** button. Click **Remove All** will delete all regions.

Notice:

- 1) The perimeter shall not be too close to the edges/corners of the camera picture, since it may fail to trigger the detection when the target pass through the edges/corners.
- 2) The shape of the regions shall not be too narrow/small, since it may fail to trigger the detection when the target passes through outside the perimeter.

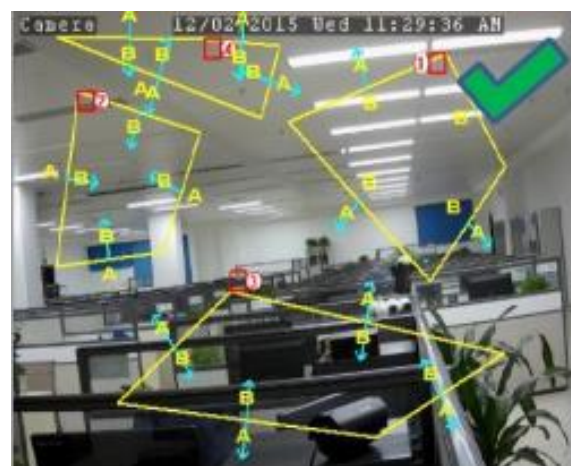

Click “Alarm” button to configure PID alarm function:

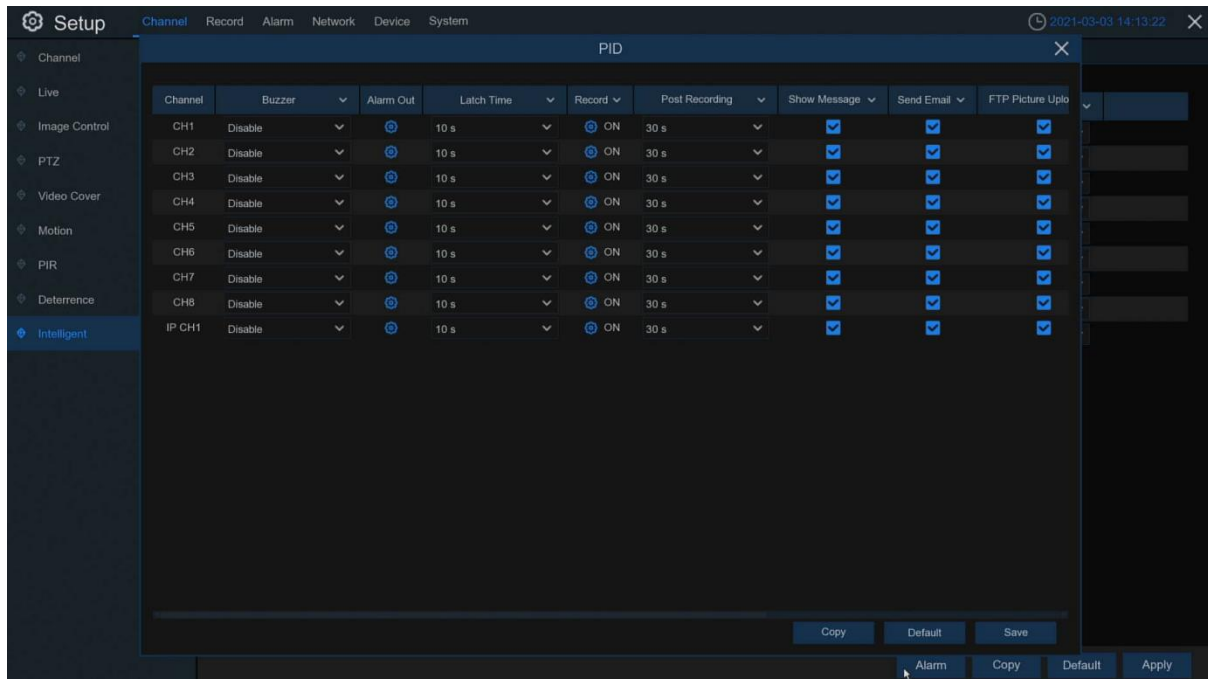

Buzzer: After the detection is triggered, disable the buzzer or activate the buzzer within 10/20/40/60 seconds to emit an alarm sound

Post Recording: You can set how long after an event occurs that the DVR will continue to record.

Latch Time: Configure the external alarm trigger time.

Alarm Out: If your DVR support to connect to external alarm device, you can set to emit an alarm tone.

Show Message: Live view screen will show “S” when alarm is triggered.

Send Email: You can let the DVR to send you an auto-email when alarm is triggered.

Full Screen: If this function is enabled and alarm is detected in a channel, you will see that channel in full screen.

Record: Choose which channel(s) you want to record when the alarm is triggered.

FTP Picture Upload: To upload alarm images to FTP server when alerts are triggered. Please view 5.4.4 FTP.

FTP Video Upload: To upload alarm videos to FTP server when alerts are triggered. Please view 5.4.4 FTP.

Picture to Cloud: To upload alarm images to cloud when alerts are triggered. Please view 5.5.2 Cloud.

Video to Cloud: To upload alarm videos to cloud when alerts are triggered. Please view 5.5.2 Cloud.

5.1.6.2 LCD (Line Crossing Detection)

Line Crossing Detection function detects people, vehicle or other objects which cross a pre-defined virtual line, and some certain actions can be taken when the alarm is triggered.

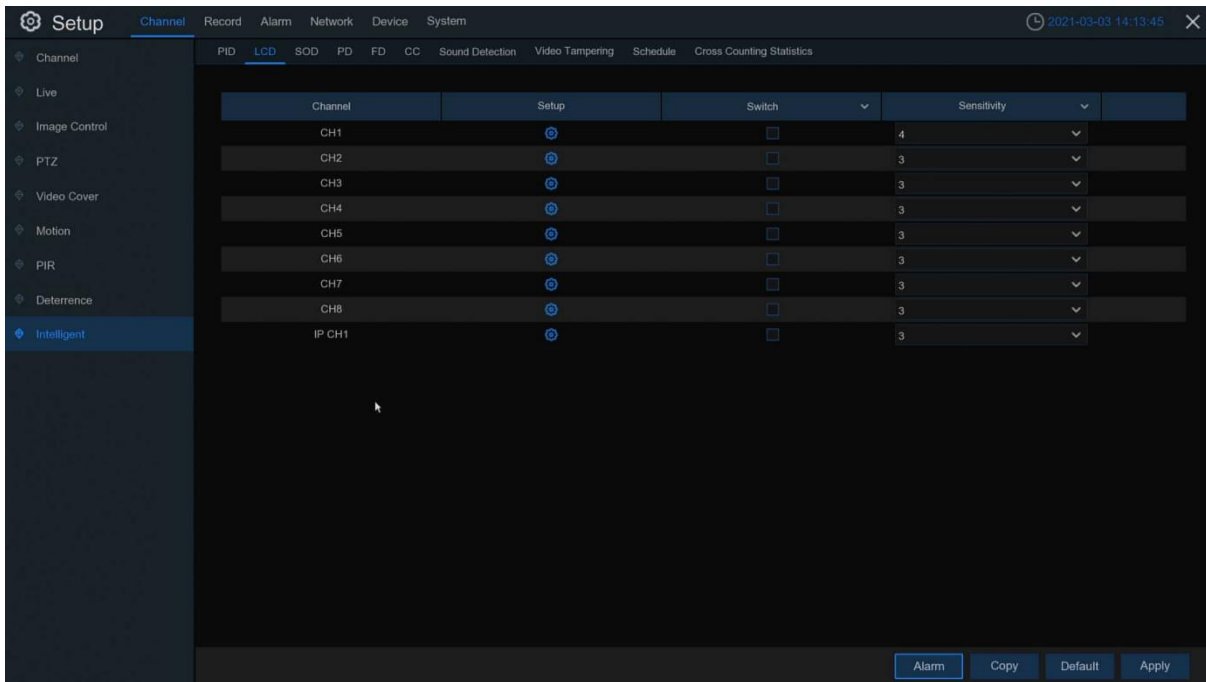

Sensitive: The sensitivity level is from 1 to 4. Higher sensitivity will be easier to trigger the detection.

Switch: Enable or disable the LCD function

Area: Click [**Setup**] to draw a virtual line in the camera picture.

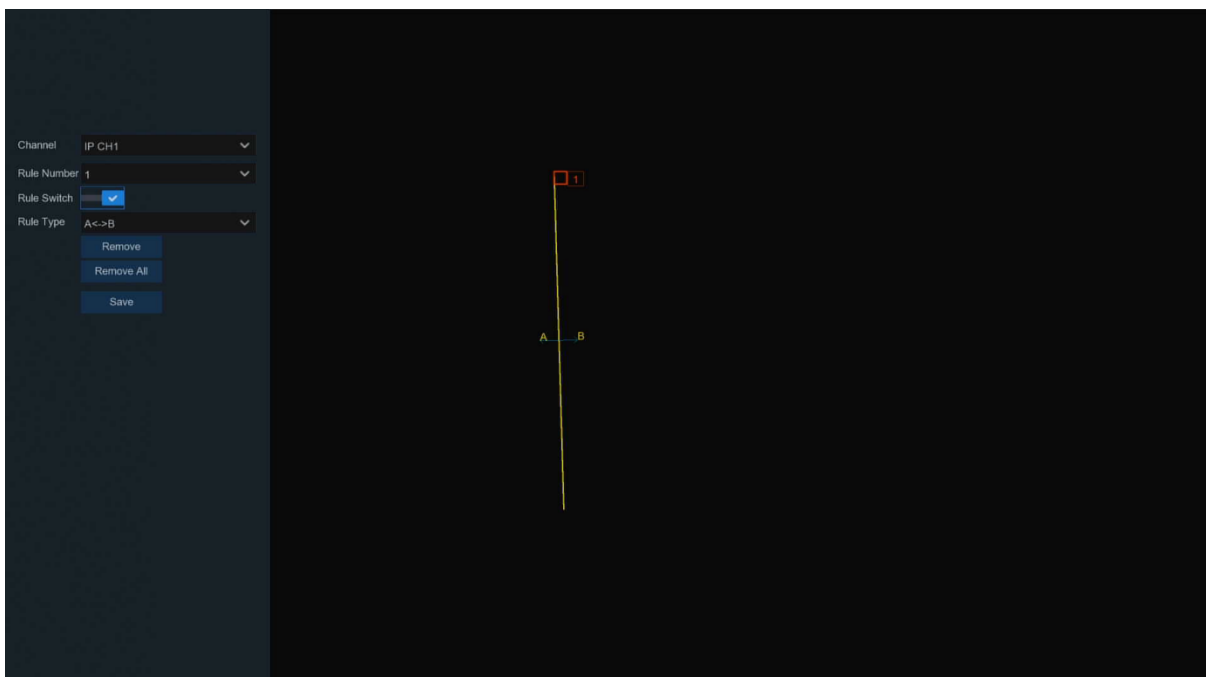

1. **Channel:** Select the channel you want to configure
2. Choose one of the Rule Number. It is the number of LCD lines. Maximum 4 lines you can draw
3. To enable the detection in **Rule Switch**
4. Choose a **Rule Type**.
 - A→B: DVR will only detect the action from side A to side B;
 - B→A: DVR will only detect the action from side B to side A;
 - A↔B: DVR will detect the action from either side B to side A or side A to side B.
5. Use your mouse to click 2 points in the camera picture to draw a virtual line.
6. Click **Save** to save your settings.
7. If you want to modify the position or length of the line, click the red box in the line, the color of the line will be changed to red color. Long press the left button of your mouse to move the line, or drag the terminals to modify the length or position of the line.
8. If you want to remove one of the lines from the camera picture, click the red box in the line and then click **Remove** button. Click **Remove All** will delete all lines.

Notice:

- 1) The lines shall not be too close to the edges of the camera picture, to avoid any failure to trigger an alarm when the target cross through it.

2) The lines shall not be set too short, to avoid any failure to trigger an alarm when the target passes outside it.

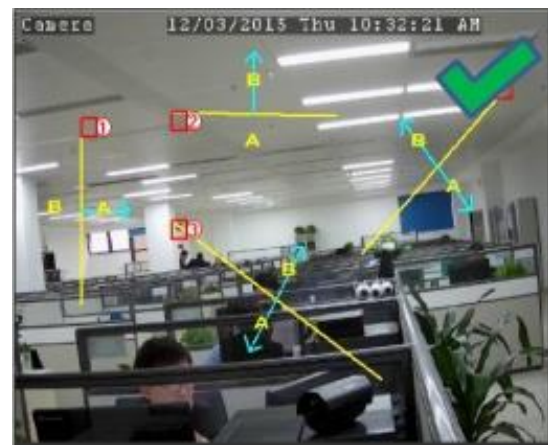

Click **“Alarm”** button to configure LCD alarm function:

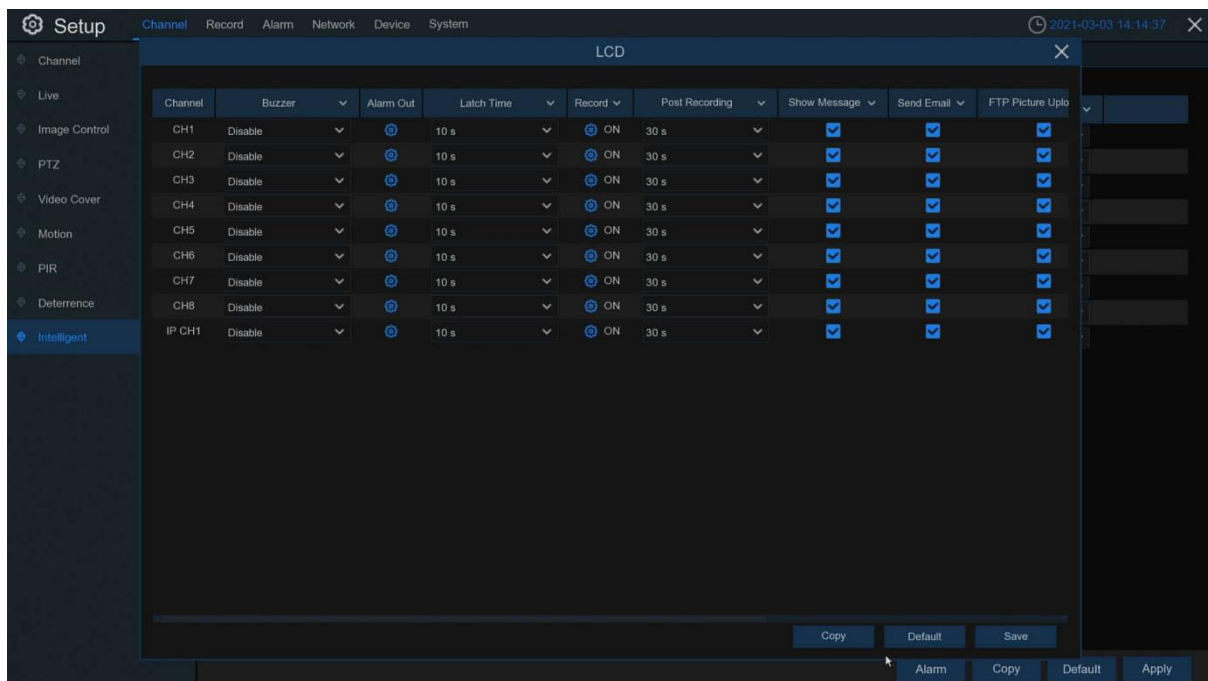

Buzzer: After the detection is triggered, disable the buzzer or activate the buzzer within 10/20/40/60 seconds to emit an alarm sound

Post Recording: You can set how long after an event occurs that the DVR will continue to record.

Latch Time: Configure the external alarm trigger time.

Alarm Out: If your DVR support to connect to external alarm device, you can set to emit an alarm tone.

Show Message: Live view screen will show “S” when alarm is triggered.

Send Email: You can let the DVR to send you an auto-email when alarm is triggered.

Full Screen: If this function is enabled and alarm is detected in a channel, you will see that channel in full screen.

Record Channel: Choose which channel(s) you want to record when the alarm is triggered.

FTP Picture Upload: To upload alarm images to FTP server when alerts are triggered. Please view *5.4.4 FTP*.

FTP Video Upload: To upload alarm videos to FTP server when alerts are triggered. Please view *5.4.4 FTP*.

Picture to Cloud: To upload alarm images to cloud when alerts are triggered. Please view *5.5.2 Cloud*.

Video to Cloud: To upload alarm videos to cloud when alerts are triggered. Please view *5.5.2 Cloud*.

5.1.6.3 SOD (Stationary Object Detection)

Stationary Object Detection function detects the objects left over or lost in the pre-defined region such as the baggage, purse, dangerous materials, etc., and a series of actions can be taken when the alarm is triggered.

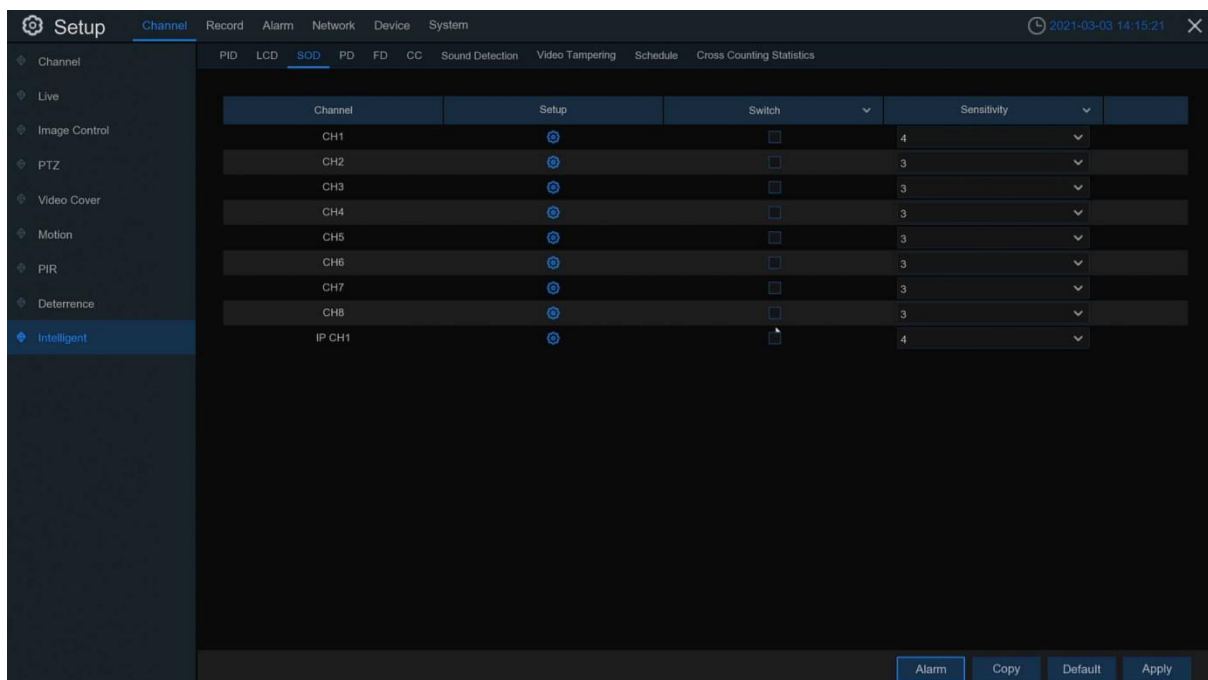

Sensitive: The sensitivity level is from 1 to 4, with a default value of 2. Higher sensitivity will be easier to trigger the detection.

Switch: to enable or disable the SOD function

Area: Click [**Setup**] to draw a virtual region in the camera picture.



1. **Channel:** to select the channel you want to configure
2. Choose one of the Rule Number. It is the number of SOD area. Maximum 4 areas you can set for SOD function.
3. To enable the detection in **Rule Switch**.
4. Choose a **Rule Type**.
 Legacy: DVR will only detect the left-over objects;
 Lost: DVR will only detect the lost objects;
 Legacy & Lost: DVR will detect both left-over & lost objects.
5. Use your mouse to click 4 points in the camera picture to draw a virtual region. The sharp of the region should be a convex polygon. Concave polygon will be not able to save.
6. Click **Save** to save your settings.
7. If you want to adjust the size of the region, click the red box in the region, the borders of the region will be changed to red color. Long press the left button of your mouse to move the whole region, or drag the corners to resize the region.

If you want to remove one of the regions from the camera picture, click the red box in the region and then click **Remove** button. Click **Remove All** will delete all regions.

Notice:

- 1) The area for detection shall be greater than or equal to the size of the detected object, such as the detection of a white bottle.

2) The detected object cannot be covered.



Click “Alarm” button to configure SOD alarm function:

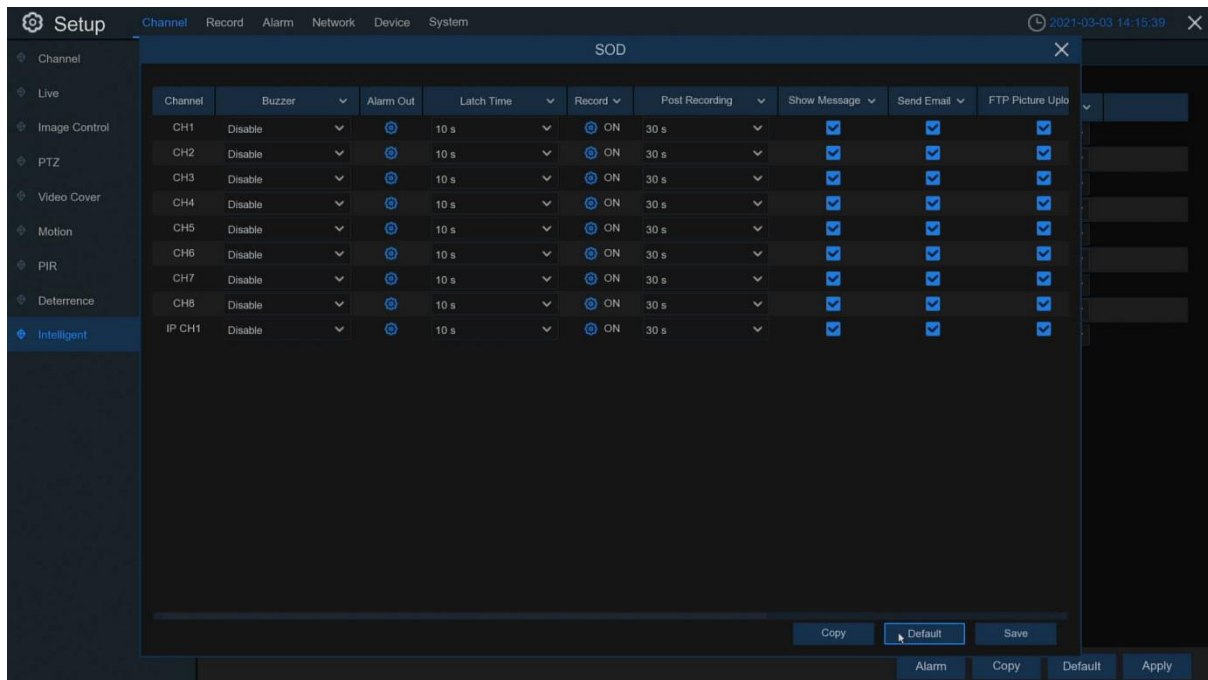

Buzzer: After the detection is triggered, disable the buzzer or activate the buzzer within 10/20/40/60 seconds to emit an alarm sound

Post Recording: You can set how long after an event occurs that the DVR will continue to record.

Latch Time: Configure the external alarm trigger time.

Alarm Out: If your DVR support to connect to external alarm device, you can set to emit an alarm tone.

Show Message: Live view screen will show “S” when alarm is triggered.

Send Email: You can let the DVR to send you an auto-email when alarm is triggered.

Full Screen: If this function is enabled and alarm is detected in a channel, you will see that channel in full screen.

Record Channel: Choose which channel(s) you want to record when the alarm is triggered.

FTP Picture Upload: To upload alarm images to FTP server when alerts are triggered. Please view 5.4.4 FTP.

FTP Video Upload: To upload alarm videos to FTP server when alerts are triggered. Please view *5.4.4 FTP*.

Picture to Cloud: To upload alarm images to cloud when alerts are triggered. Please view *5.5.2 Cloud*.

Video to Cloud: To upload alarm videos to cloud when alerts are triggered. Please view *5.5.2 Cloud*.

5.1.6.4 PD (Pedestrian Detection)

Pedestrian Detection function detects the moving people in a pre-defined region, and a series of actions can be taken when the alarm is triggered.

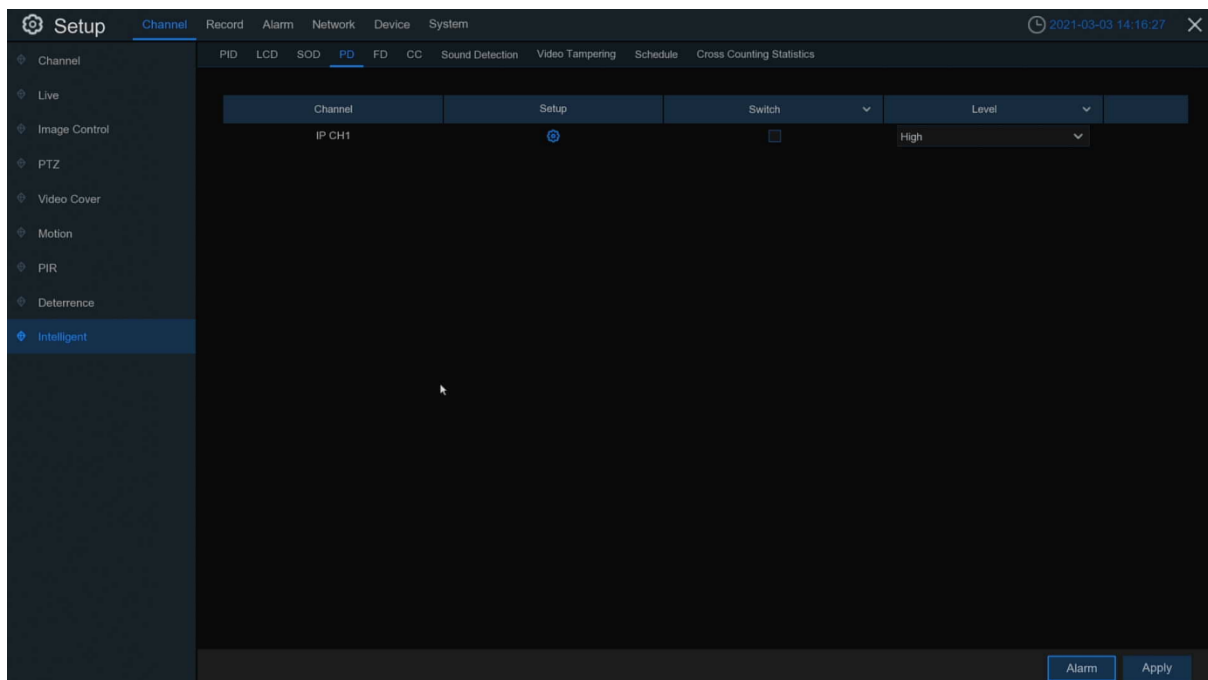

Level: Small, Middle & Big. Small level is recommended to detect objects in long distance. Big level is recommended to detect objects in short distance.

Switch: to enable or disable the PD function

Area: Click [**Setup**] to draw a virtual region in the camera picture.

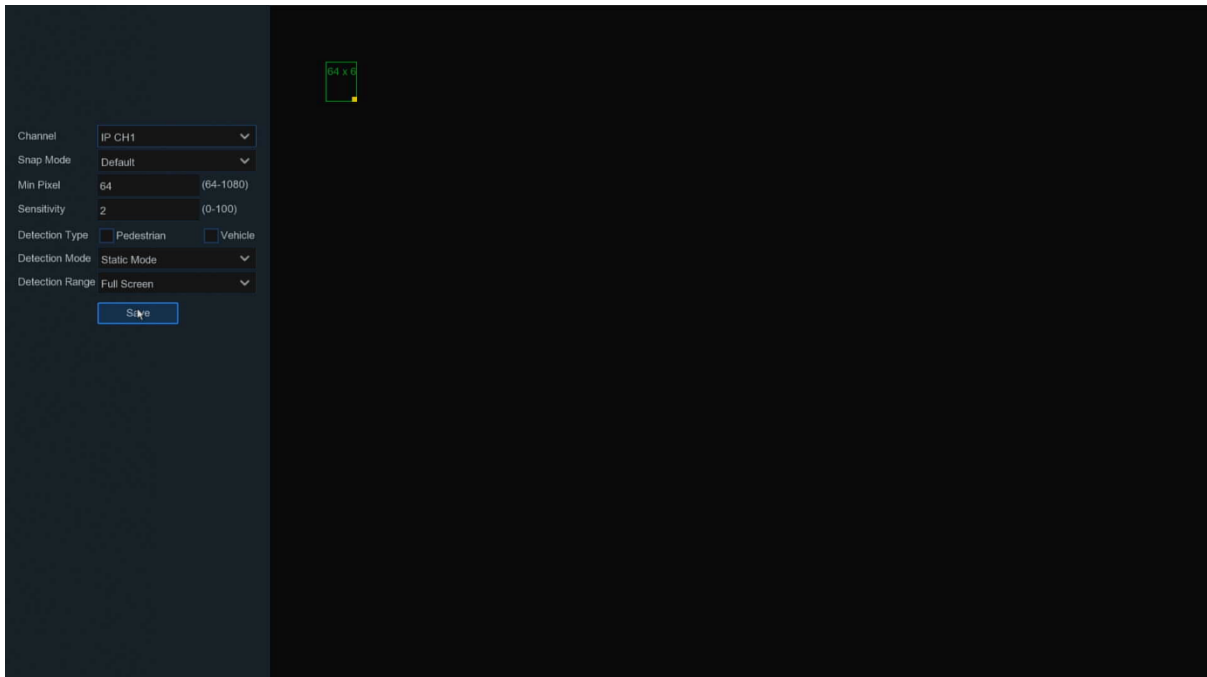

1. **Channel:** to select the channel you want to configure
2. **Snap Mode:** Select snap mode. There are advanced mode (select the best image to push from the time when the face appears to disappear), real-time mode (push once when the face appears and push again when it disappears) and interval mode (customize the time and interval of push).
3. **Min Pixel:** Set the minimum recognition pixel box, and the face can be recognized only when it is larger than the set pixel.
4. **Sensitivity:** The sensitivity level is from 0 to 100, higher sensitivity will be easier to trigger the detection.
5. **Detection Type:** Select the detection type. When selecting pedestrians, only pedestrians can trigger the alarm, and when selecting vehicles, only vehicles can trigger the alarm.
6. **Detection Mode:** Select the detection mode. In static mode, only stationary people and vehicles will be detected, while in dynamic mode, stationary or moving people and vehicles can trigger detection
7. **Detection Range:** Set the detection range, Full Screen is full screen detection, Customize can customize the detection range. You can use the mouse to click 4 points in the camera picture to draw a virtual area. The sharpness of this area should be a convex polygon. Concave polygons will not be saved. If you want to adjust the size of the area, click the red box in the area, and the border of the area will turn red. Long press the left mouse button to move the entire area, or drag the corners to adjust the size of the area.

Notice:

- 1) The region for detection shall not be in the area that people cannot reach.
- 2) The region should include the complete front face.



Click **“Alarm”** button to configure PD alarm function:

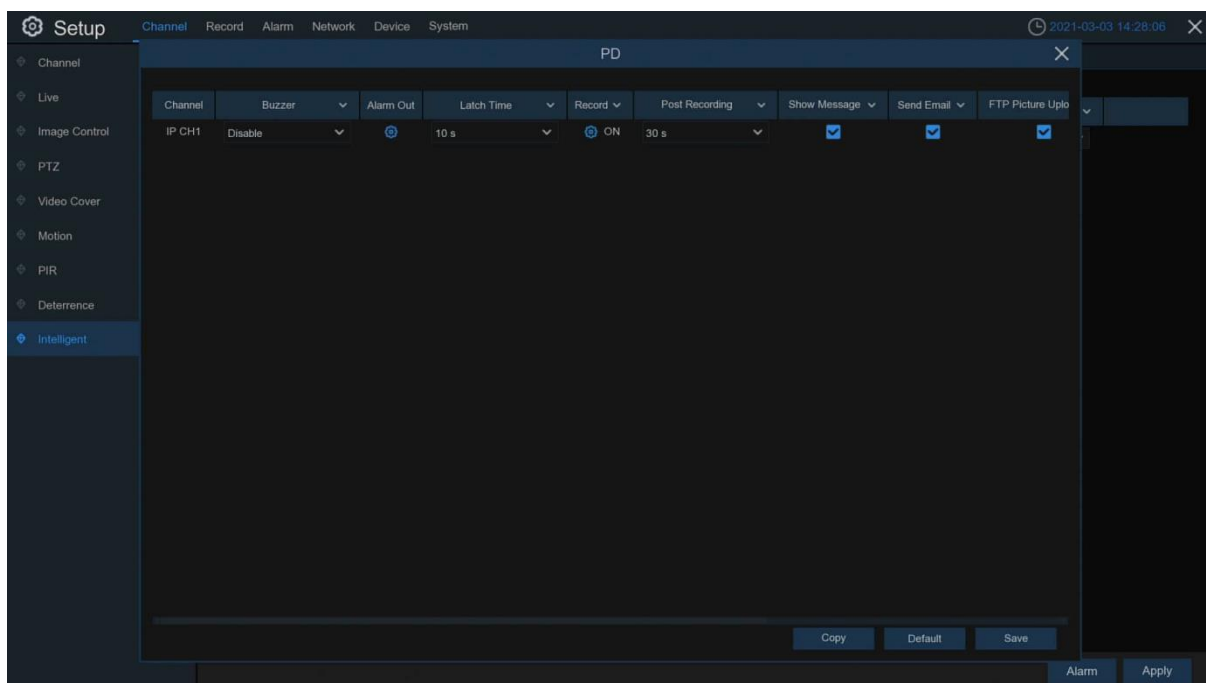

Buzzer: After the detection is triggered, disable the buzzer or activate the buzzer within 10/20/40/60 seconds to emit an alarm sound

Post Recording: You can set how long after an event occurs that the DVR will continue to record.

Latch Time: Configure the external alarm trigger time.

Alarm Out: If your DVR support to connect to external alarm device, you can set to emit an alarm tone.

Show Message: Live view screen will show “S” when alarm is triggered.

Send Email: You can let the DVR to send you an auto-email when alarm is triggered.

Full Screen: If this function is enabled and alarm is detected in a channel, you will see that channel in full screen.

Record Channel: Choose which channel(s) you want to record when the alarm is triggered.

FTP Picture Upload: To upload alarm images to FTP server when alerts are triggered. Please view *5.4.4 FTP*.

FTP Video Upload: To upload alarm videos to FTP server when alerts are triggered. Please view *5.4.4 FTP*.

Picture to Cloud: To upload alarm images to cloud when alerts are triggered. Please view *5.5.2 Cloud*.

Video to Cloud: To upload alarm videos to cloud when alerts are triggered. Please view *5.5.2 Cloud*.

5.1.6.5 FD (Face Detection)

Face Detection function detects the faces of moving people appear in a pre-defined region, and a series of actions can be taken when the alarm is triggered.

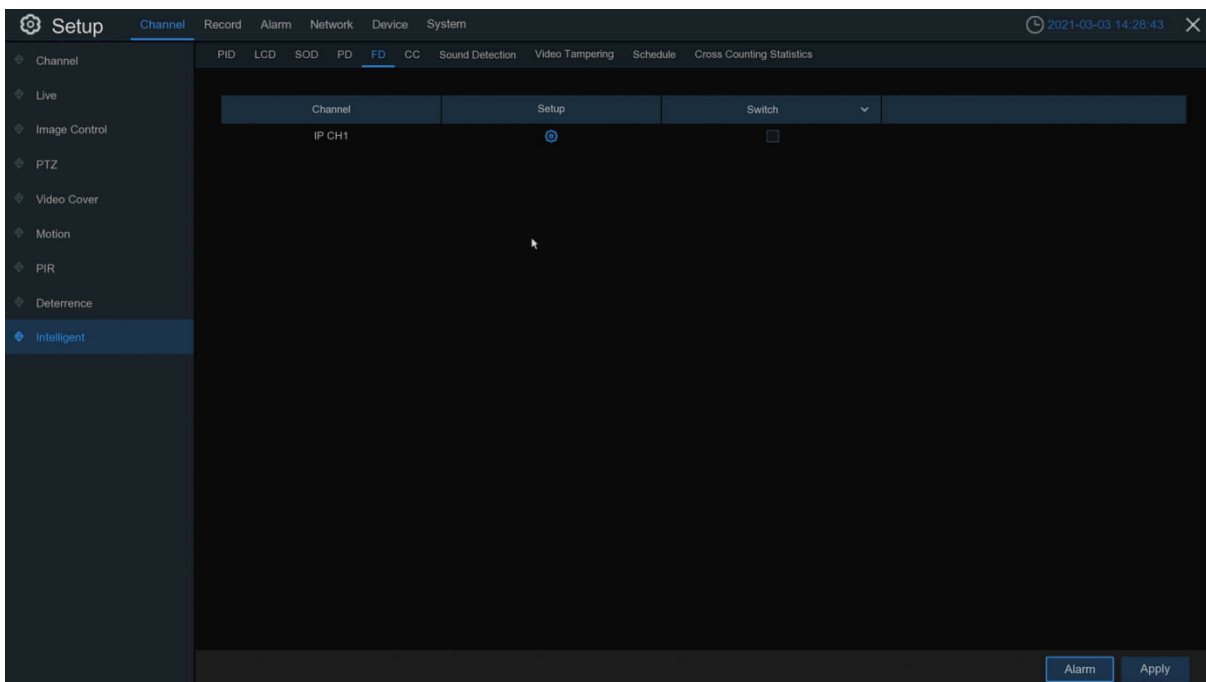

Switch: to enable or disable the FD function

Area: Click [**Setup**] to draw a virtual region in the camera picture.

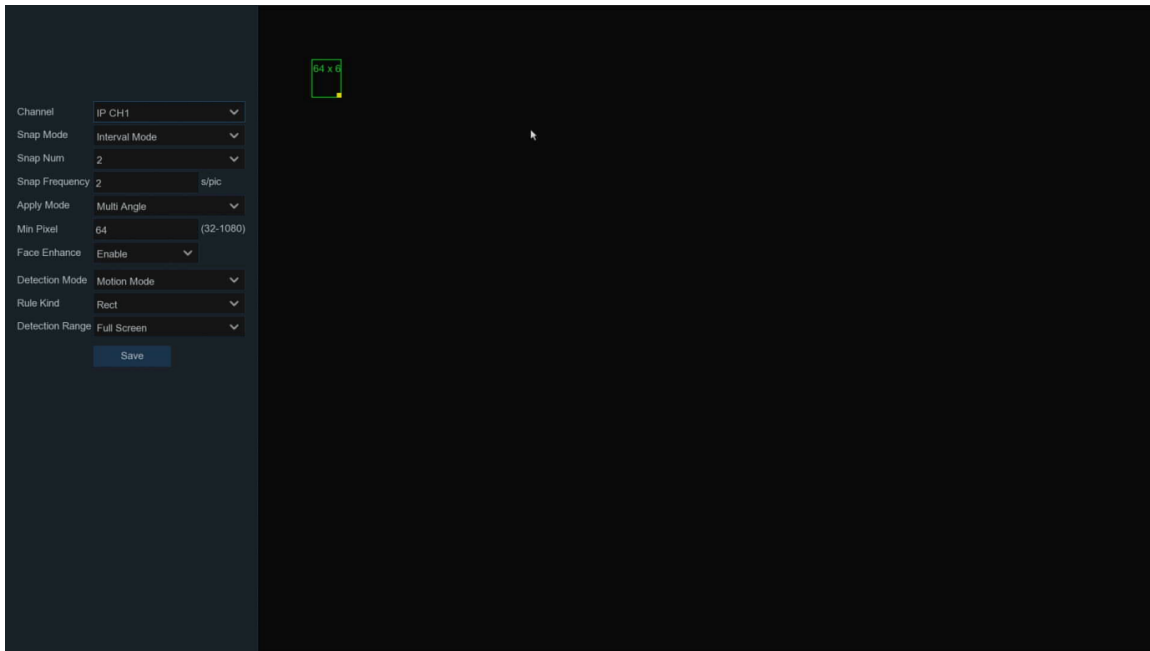

1. **Channel:** to select the channel you want to configure
2. **Snap Mode:** Select snap mode. There are advanced mode (select the best image to push from the time when the face appears to disappear), real-time mode (push once when the face appears and push again when it disappears) and interval mode (customize the time and interval of push).
3. **Apply Mode:** Select the application mode, there are frontal angles, multi-angles and custom angles to choose from. The alarm can only be triggered when a face that meets these angles appears.
4. **Min Pixel:** Set the minimum recognition pixel box, and the face can be recognized only when it is larger than the set pixel.
5. **Face Enhance:** Face enhancement makes it easier to recognize faces when turned on.
6. **Detection Mode:** Select the detection mode. In static mode, only static faces are detected, while in dynamic mode, static or moving faces can trigger detection.
7. **Rule Kind:** Rule type. To set the cross-line shape, you need to select the cross-line rule and set the position of the line in the screen. The face can pass through the line according to the set rule to trigger the detection. The regional shape can be triggered only when the face is in the set area.
8. **Detection Range:** Set the detection range, Full Screen is full screen detection, Customize can customize the detection range. Use the mouse to click 4 points in the camera picture to draw a virtual area. The sharpness of this area should be a convex polygon. Concave polygons will not be saved. If you want to adjust the size of the area, click the red box in the area, and the border of the area will turn red. Long press the left mouse button to move the entire area, or drag the corners to adjust the size of the area.

Notice:

- 1) The region for detection shall not be in the area that people cannot reach.
- 2) The region should include the complete front face.



Click “Alarm” button to configure alarm function:

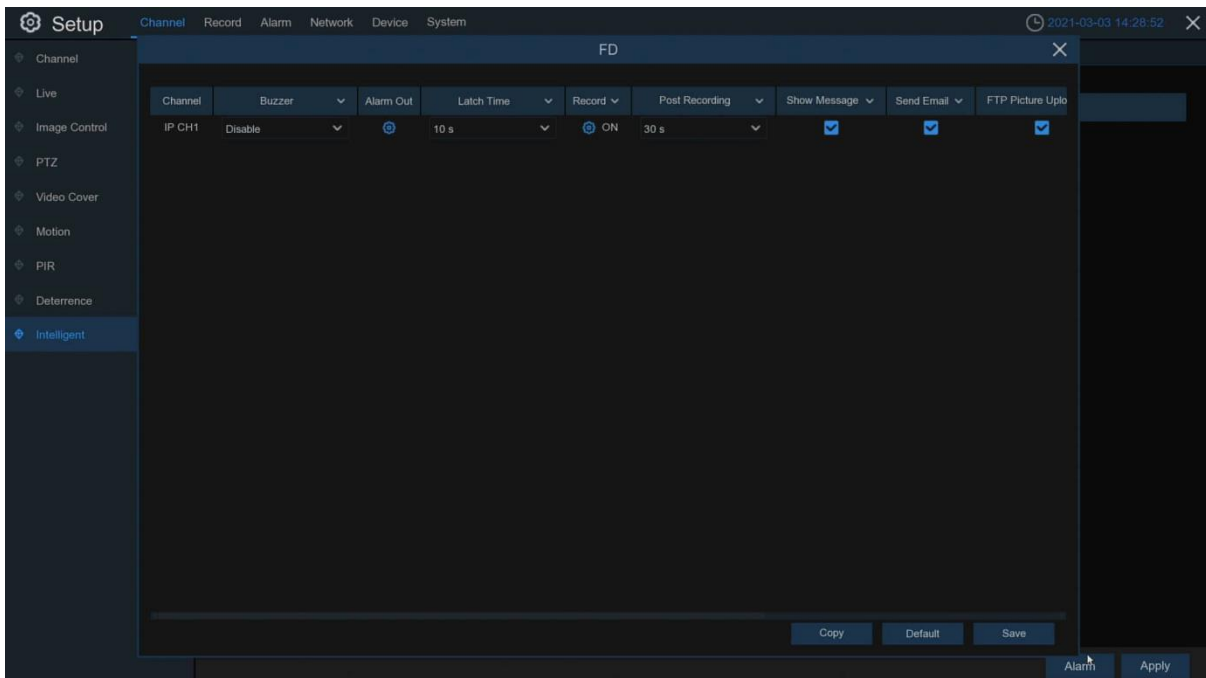

Buzzer: After the detection is triggered, disable the buzzer or activate the buzzer within 10/20/40/60 seconds to emit an alarm sound

Post Recording: You can set how long after an event occurs that the DVR will continue to record.

Latch Time: Configure the external alarm trigger time.

Alarm Out: If your DVR support to connect to external alarm device, you can set to emit an alarm tone.

Show Message: Live view screen will show “S” when alarm is triggered.

Send Email: You can let the DVR to send you an auto-email when alarm is triggered.

Full Screen: If this function is enabled and alarm is detected in a channel, you will see that channel in full screen.

Record Channel: Choose which channel(s) you want to record when the alarm is triggered.

FTP Picture Upload: To upload alarm images to FTP server when alerts are triggered. Please view *5.4.4 FTP*.

FTP Video Upload: To upload alarm videos to FTP server when alerts are triggered. Please view *5.4.4 FTP*.

Picture to Cloud: To upload alarm images to cloud when alerts are triggered. Please view *5.5.2 Cloud*.

Video to Cloud: To upload alarm videos to cloud when alerts are triggered. Please view *5.5.2 Cloud*.

5.1.6.6 CC (Cross-Counting)

Cross-Counting function counts the times for moving objects or people across the virtual lines.

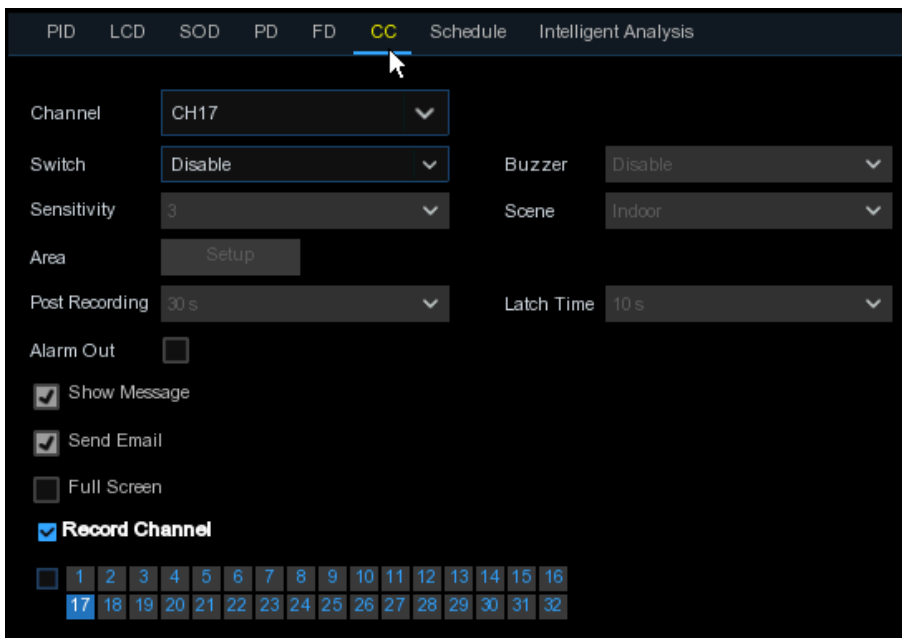

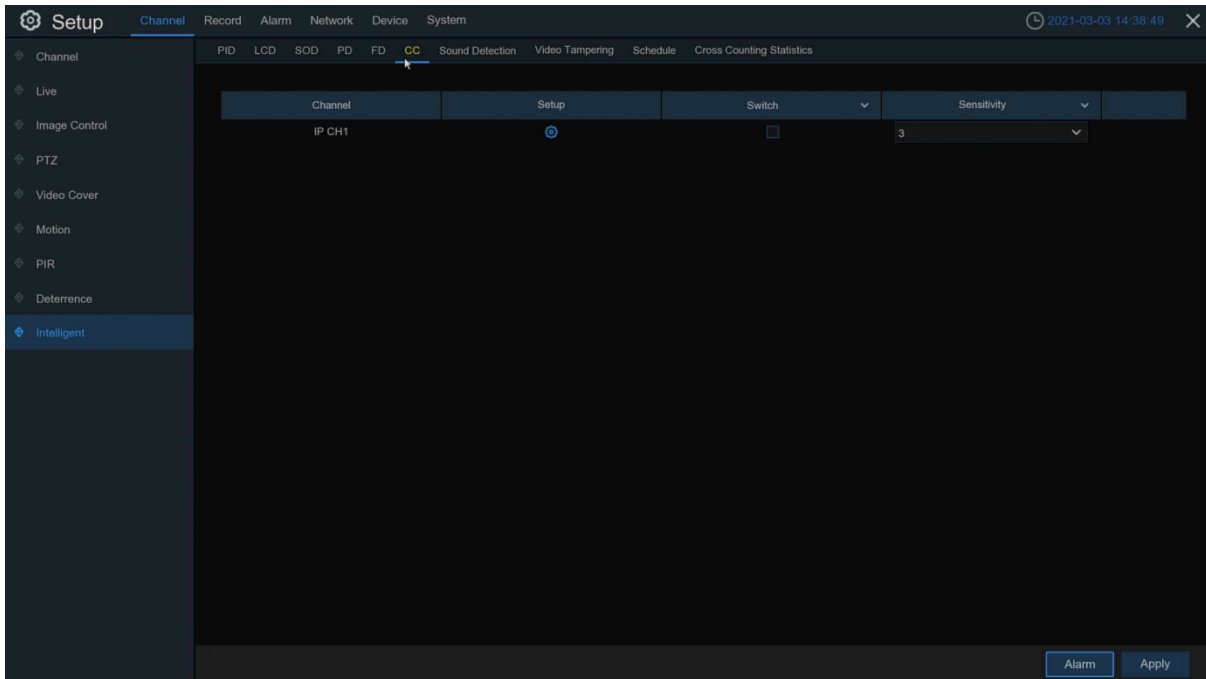

Sensitive: The sensitivity level is from 1 to 4, with a default value of 2. Higher sensitivity will be easier to trigger the detection.

Switch: to enable or disable the CC function

Area: Click [**Setup**] to draw a virtual region in the camera picture.

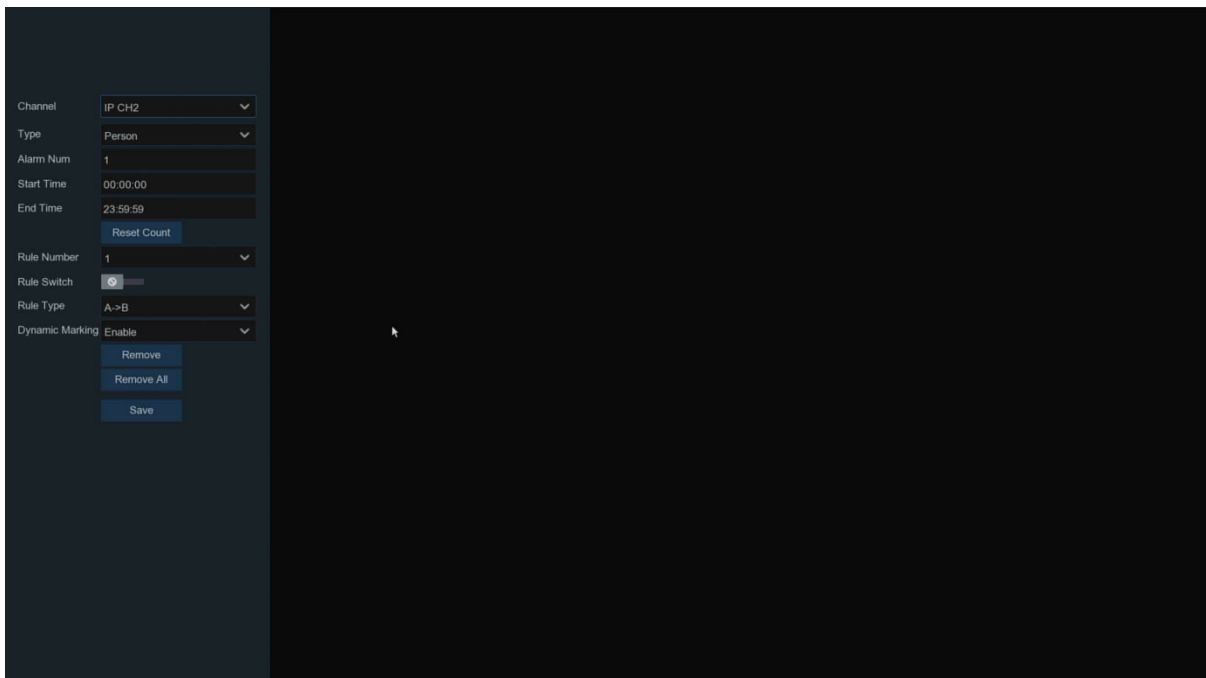

1. **Channel:** to select the channel you want to configure
2. Choose one of the Rule Number. It is the number of virtual lines you can draw. Maximum 4 lines.
3. To enable the detection in **Rule Switch**.

4. Choose a **Rule Type**

Person: Will count for only pedestrians crossing the line.

Motion: Count any moving objects that cross the line.

Vehicle: Will count for only vehicles crossing the line.

5. **Start Time:** Set the count start time.

6. **End Time:** Set the count end time.

7. **Reset Count:** Clear the count and count again.

8. **Rule Number:** Rule number, there can only be one set of rules

9. **Rule Type:**

- a) A->B, DVR will count people or objects from side A to side B
- b) B->A, DVR will count people or objects from side B to side A.

10. Click **Save** to save your settings.

11. If you want to modify the position or length of the line, click the red box in the line, the color of the line will be changed to red color. Long press the left button of your mouse to move the line, or drag the terminals to modify the length or position of the line.

12. If you want to remove one of the lines from the camera picture, click the red box in the line and then click **Remove** button. Click **Remove All** will delete all lines.

Notice:

- 1) The lines shall not be too close to the edges of the camera picture, to avoid any failure to trigger an alarm when the target cross through it.
- 2) The lines should be in the area that detected object can be reach.
- 3) The lines shall not be set too short, to avoid any failure to trigger an alarm when the target passes outside it.

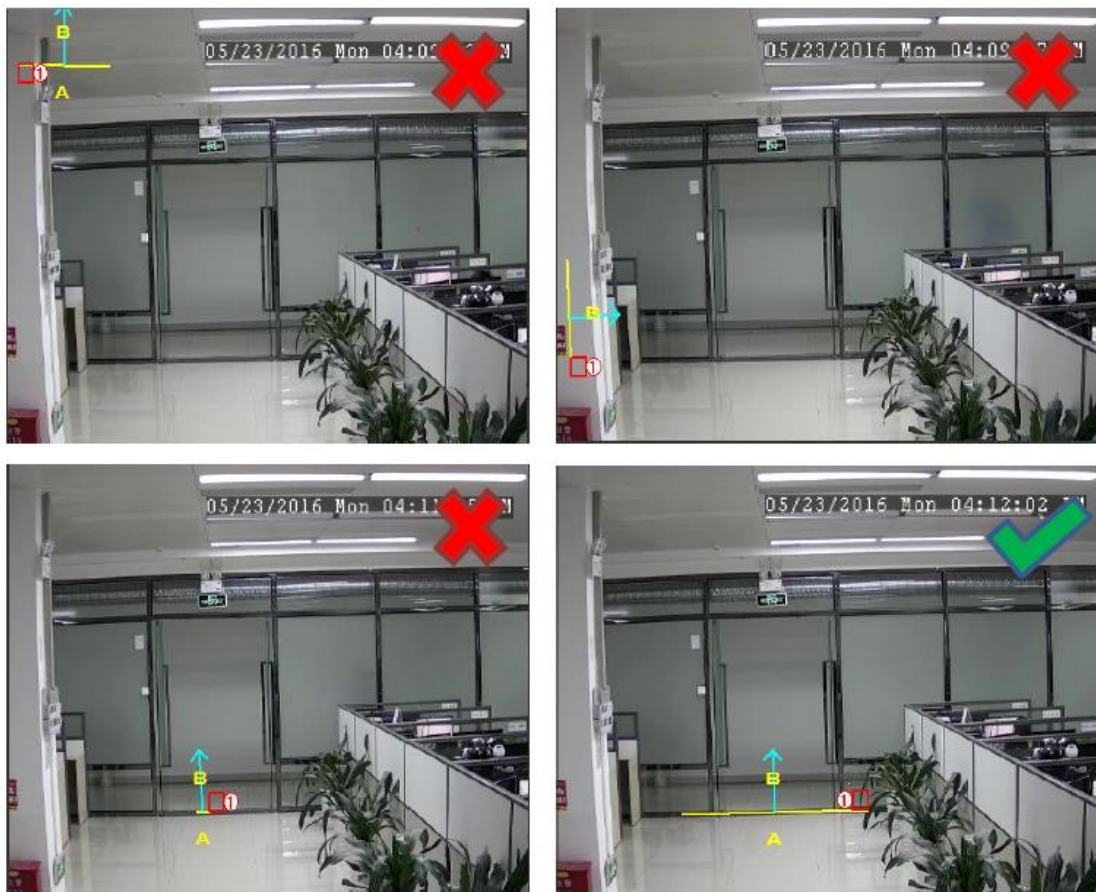

You are able to search & view the statistical result of cross counting in 5.3.4 *Intelligent*
 Click **Alarm** button to configure CC alarm function:

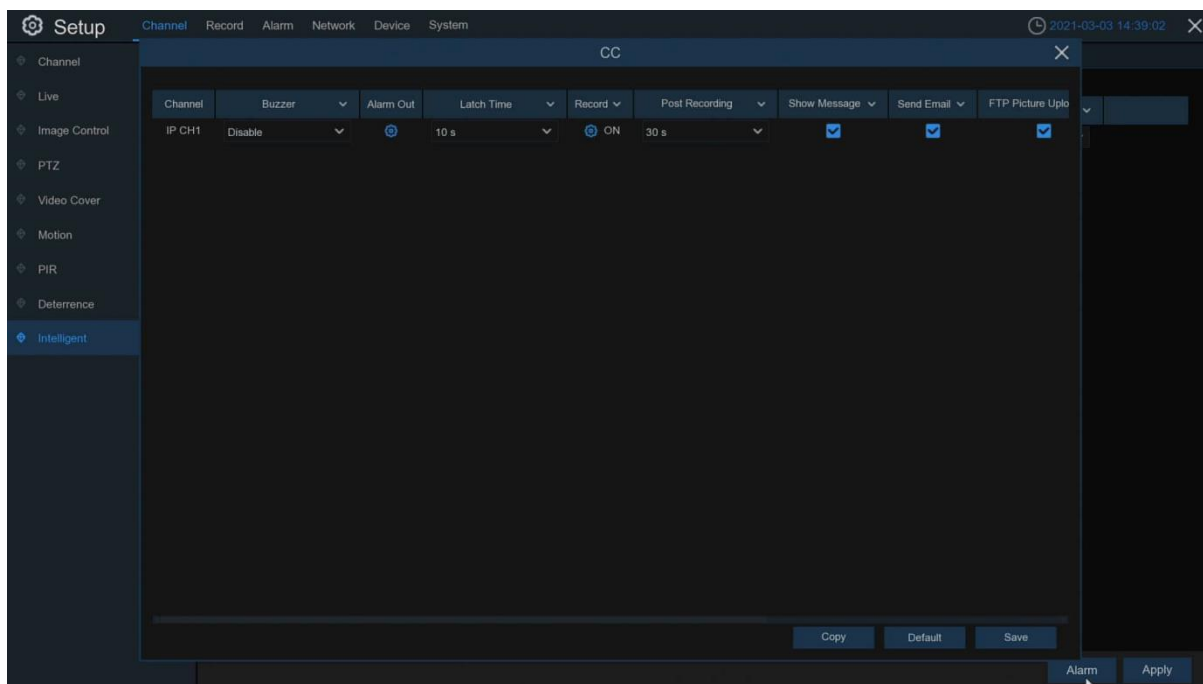

Buzzer: After the detection is triggered, disable the buzzer or activate the buzzer within 10/20/40/60 seconds to emit an alarm sound

Post Recording: You can set how long after an event occurs that the DVR will continue to record.

Latch Time: Configure the external alarm trigger time.

Alarm Out: If your DVR support to connect to external alarm device, you can set to emit an alarm tone.

Show Message: Live view screen will show “S” when alarm is triggered.

Send Email: You can let the DVR to send you an auto-email when alarm is triggered.

Full Screen: If this function is enabled and alarm is detected in a channel, you will see that channel in full screen.

Record Channel: Choose which channel(s) you want to record when the alarm is triggered.

FTP Picture Upload: To upload alarm images to FTP server when alerts are triggered. Please view *5.4.4 FTP*.

FTP Video Upload: To upload alarm videos to FTP server when alerts are triggered. Please view *5.4.4 FTP*.

Picture to Cloud: To upload alarm images to cloud when alerts are triggered. Please view *5.5.2 Cloud*.

Video to Cloud: To upload alarm videos to cloud when alerts are triggered. Please view *5.5.2 Cloud*.

5.1.6.7 Sound Detection

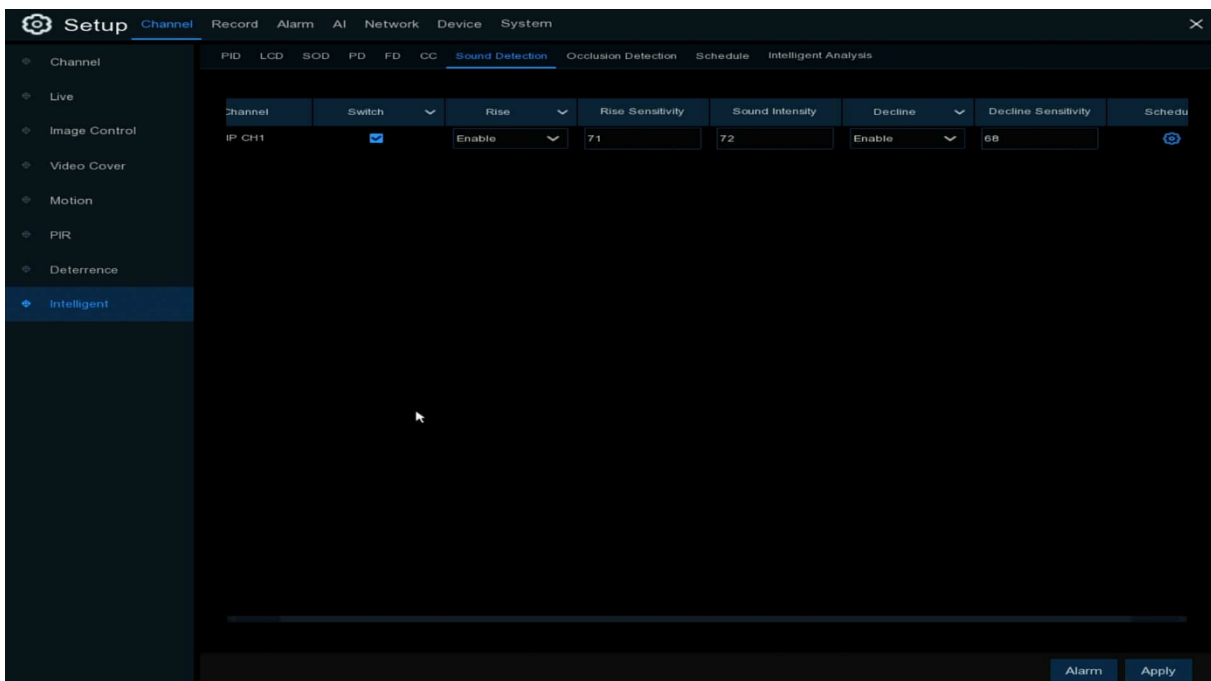

With the sound detection, it can trigger an alarm while detecting the sound rise or decline, and some certain actions can be taken when the alarm is triggered.

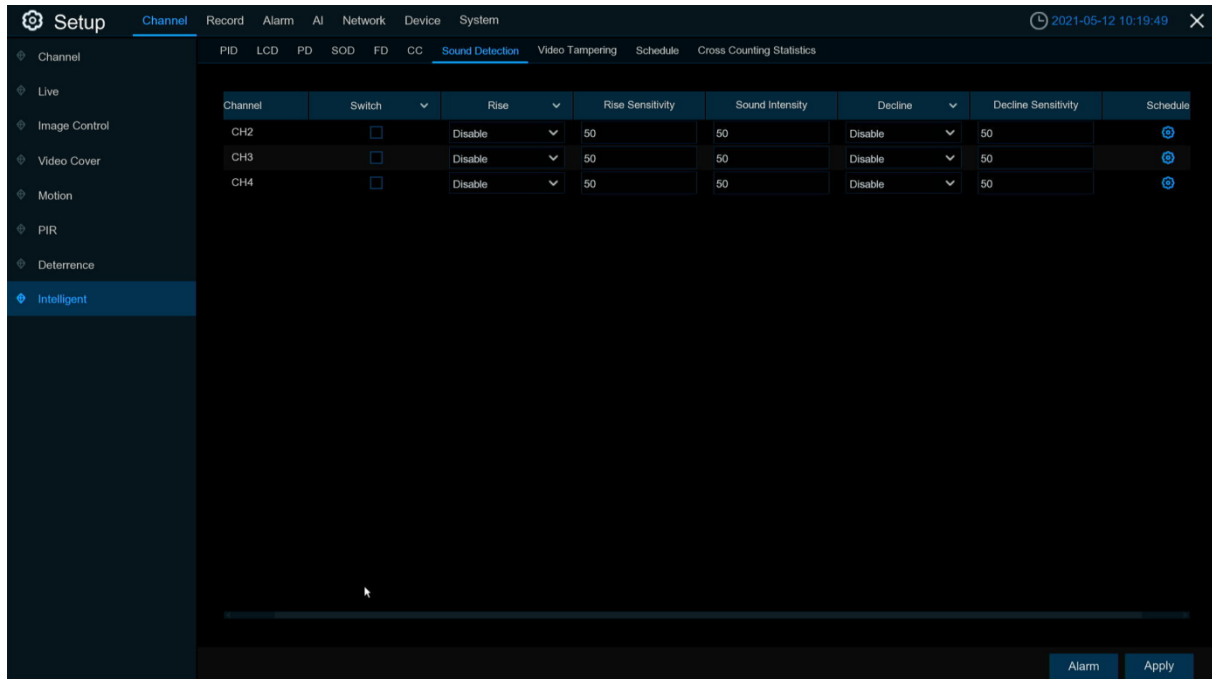

Switch: Switch of sound detection

Rise: Switch of volume raised, the alarm will be triggered only when volume rise sharply

Rise Sensitivity: The sensitivity of volume raised, the larger the value, the easier to trigger the alarm

Sound Intensity: Configuration of sound intensity, it is the sound threshold. The higher the threshold, the louder the spike alarm needs to be to trigger

Decline: Switch of volume drop sharply, the alarm will be triggered only when volume rise sharply.

Decline Sensitivity: The sensitivity of drop sharply, the larger the value, the easier to trigger the alarm.

Schedule: Schedule of sound alarm setting. Only will be triggered during the schedule time.

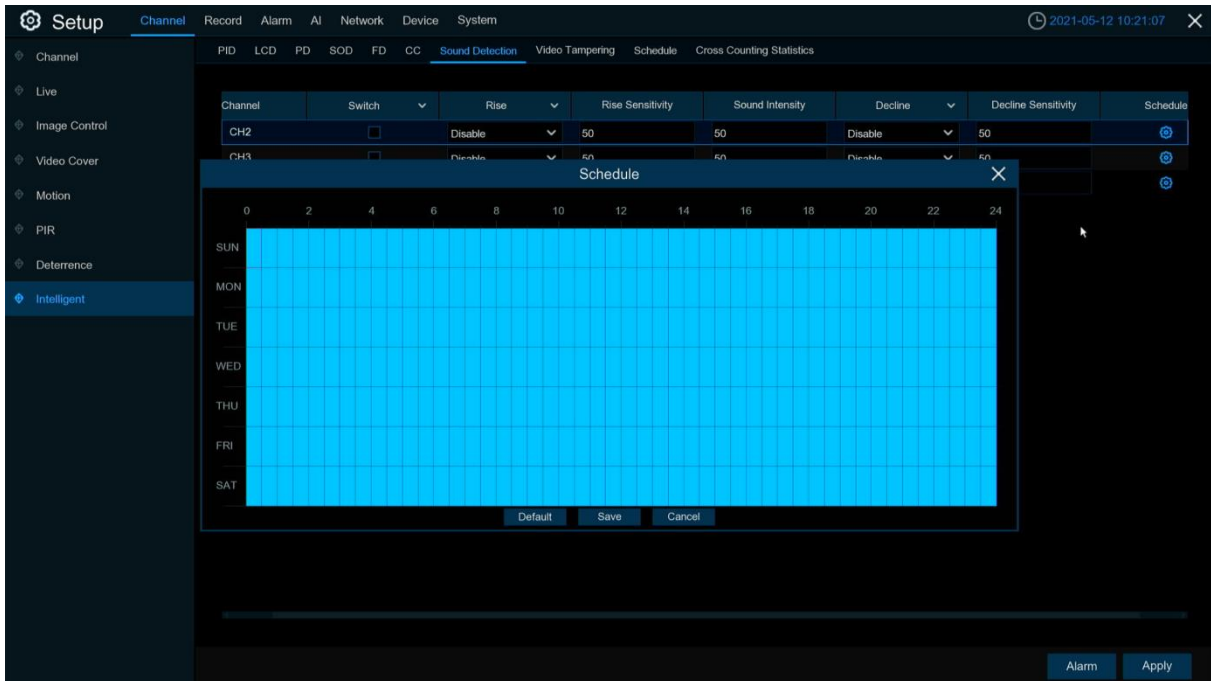

5.1.6.8 Video Tampering

The alarm triggered when the camera be covered largely.

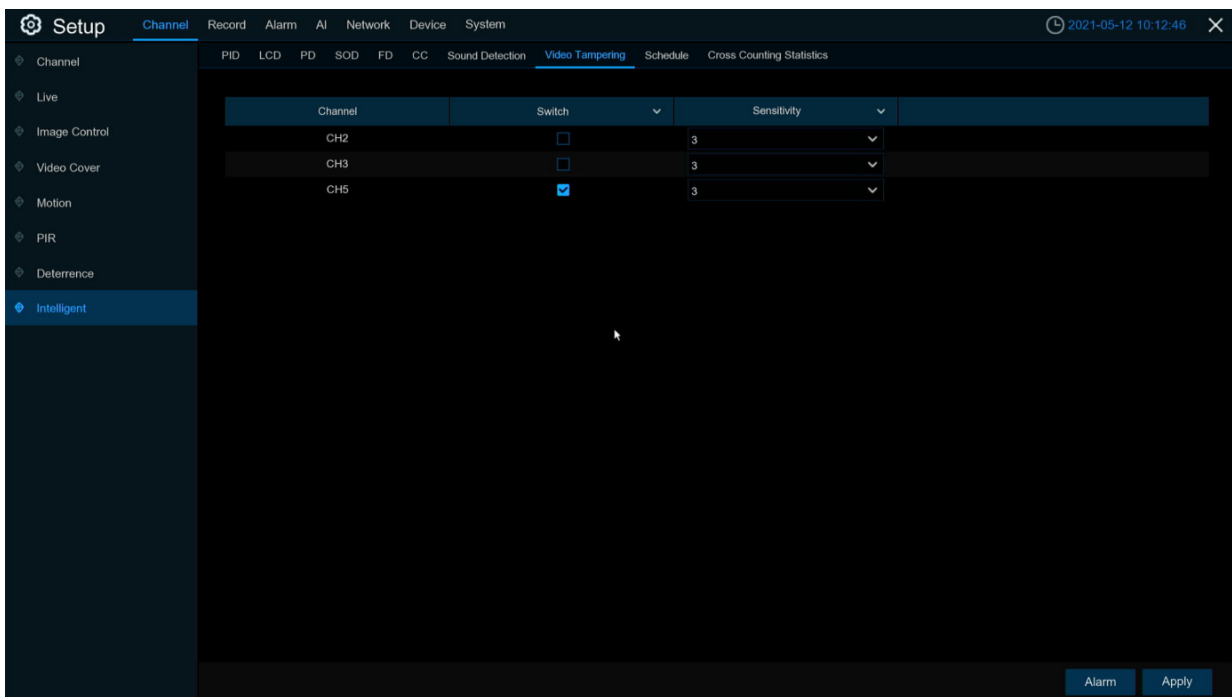

Switch: Enable or disable the alarm caused by video cover.

Sensitivity: Sensitivity setting, the larger the value, the easier to trigger the alarm.

5.1.6.9 Cross Counting Statics

This menu can make statics for alarms caused by the cross counting and draw a linear or bar chart.

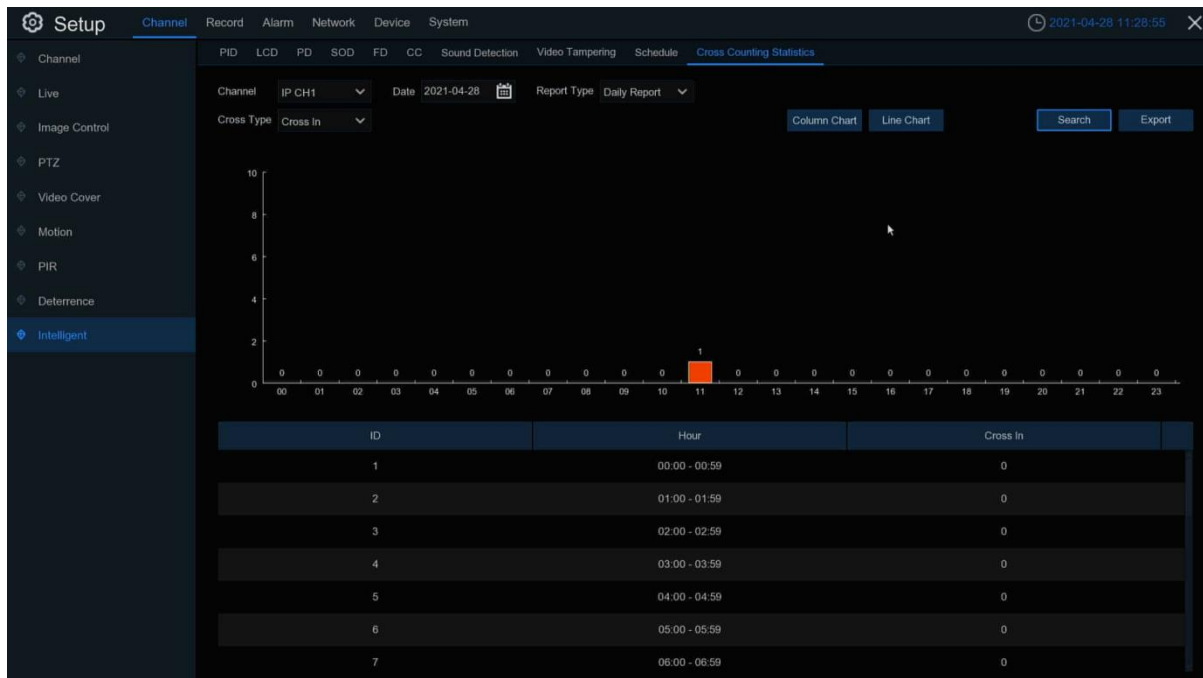

Channel: Select the channel wanted.

Date: Select the date wanted

Report Type: Select the report type, reports can be generated by day, week, month and year

Cross Type: Select the cross type, cross in and cross out for option.

Column Chart: by default, click **Line Chart** to change to line graph.

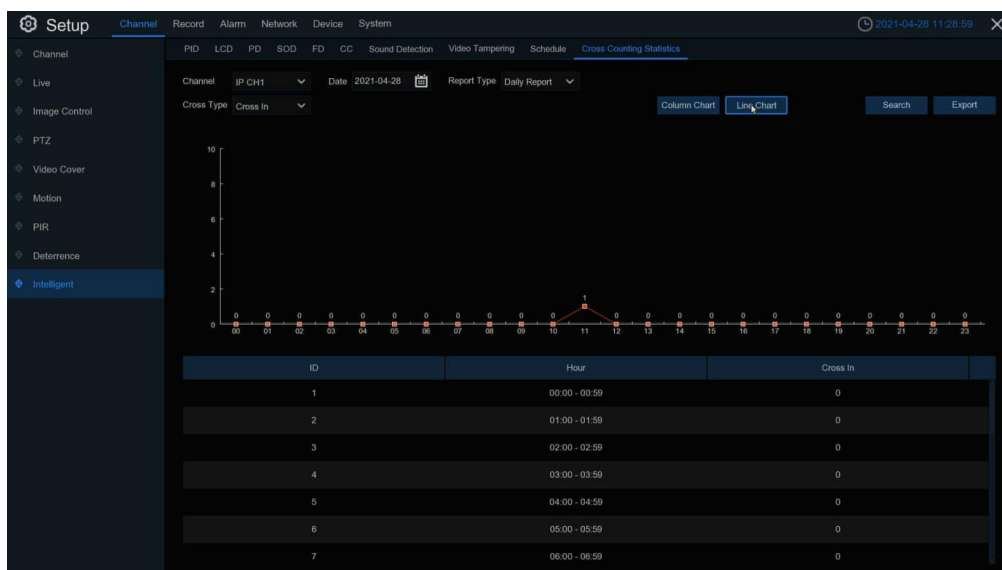

5.1.6.10 Intelligent Schedule

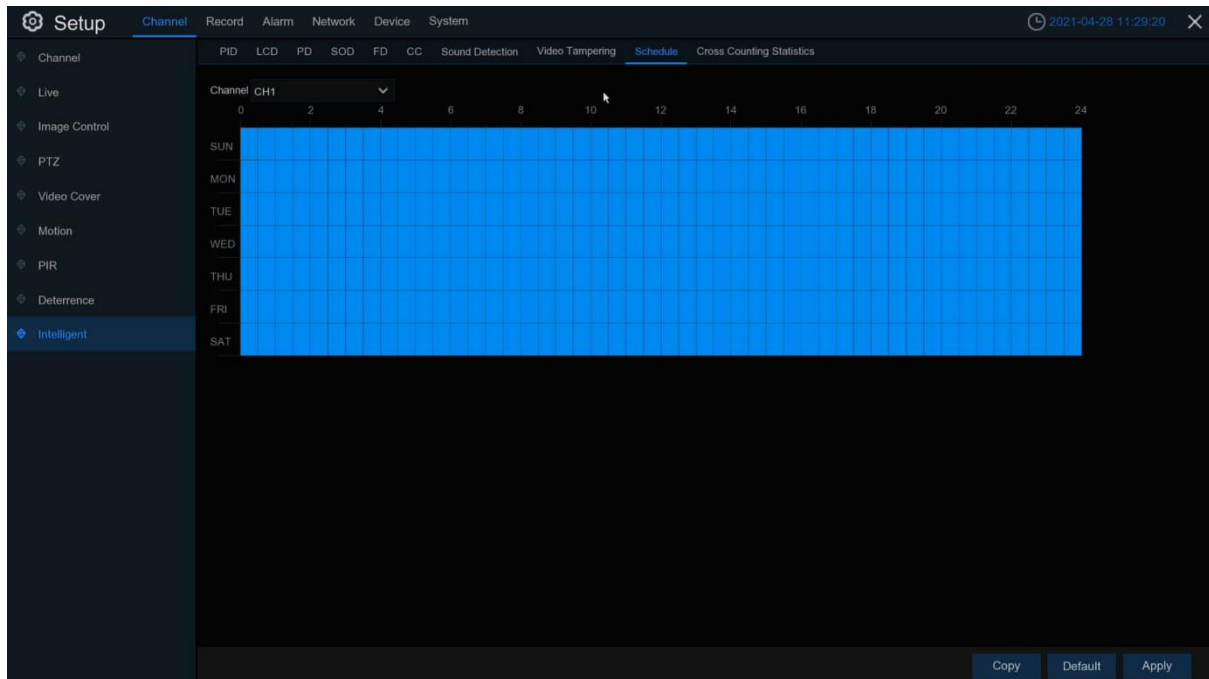

In order to activate the intelligent function, you need to config the schedule. The schedule will be active in 24 hours x 7 days.

To set the schedule, choose one channel then drag the cursor to mark the slots. The sky-blue blocks in the time slots will be active for Intelligent detections. The schedule is valid only for the selected channel each time when you set. If you want to use the same schedule for other channels, use **Copy** function. Click **Save** to save your settings.

5.2 Record

This menu allows you to configure the recording parameters.

5.2.1 Encode

This menu allows you to configure the recording video or network transmission picture quality.

The **Mainstream** tab defines the quality of the videos to be saved in the HDD; the **Substream** tab defines the quality of the videos to be viewed via remote access such as web client & CMS; the **Mobilestream** tab defines the quality of the videos to be via remote access on mobile devices.

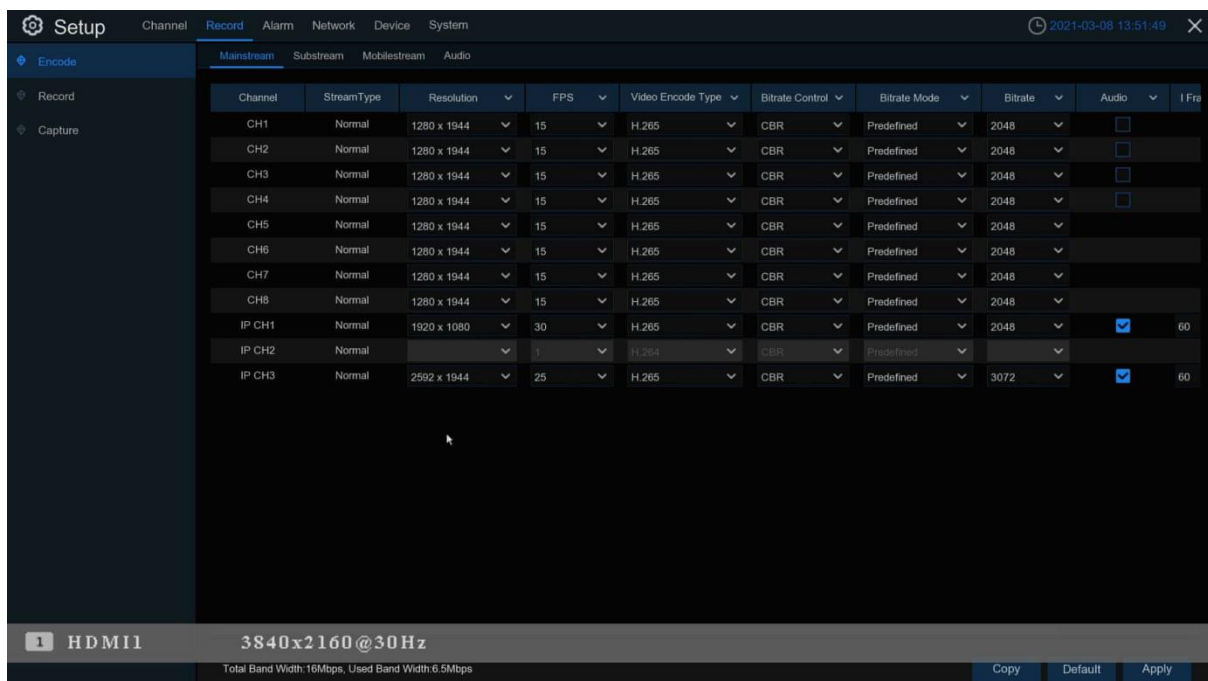

Channel	StreamType	Resolution	FPS	Video Encode Type	Bitrate Control	Bitrate Mode	Bitrate	Audio	I Fra
CH1	Normal	1280 x 1944	15	H.265	CBR	Predefined	2048	<input type="checkbox"/>	
CH2	Normal	1280 x 1944	15	H.265	CBR	Predefined	2048	<input type="checkbox"/>	
CH3	Normal	1280 x 1944	15	H.265	CBR	Predefined	2048	<input type="checkbox"/>	
CH4	Normal	1280 x 1944	15	H.265	CBR	Predefined	2048	<input type="checkbox"/>	
CH5	Normal	1280 x 1944	15	H.265	CBR	Predefined	2048	<input type="checkbox"/>	
CH6	Normal	1280 x 1944	15	H.265	CBR	Predefined	2048	<input type="checkbox"/>	
CH7	Normal	1280 x 1944	15	H.265	CBR	Predefined	2048	<input type="checkbox"/>	
CH8	Normal	1280 x 1944	15	H.265	CBR	Predefined	2048	<input type="checkbox"/>	
IP CH1	Normal	1920 x 1080	30	H.265	CBR	Predefined	2048	<input checked="" type="checkbox"/>	60
IP CH2	Normal		1	H.264	CBR	Predefined		<input type="checkbox"/>	
IP CH3	Normal	2592 x 1944	25	H.265	CBR	Predefined	3072	<input checked="" type="checkbox"/>	60

Mainstream, Substream, Mobilestream:

- **Resolution:** This parameter indicates the size of the recorded image.
- **FPS:** This parameter defines the number of frames recorded on the DVR per second.
- **Video Encode Type:** For IP cameras only. DVR support H.264 IP camera only. If you choose H.265, live view screen of the IP channel will display “Decoding Failed”.
- **Bitrate Control:** Select the bitrate level. Select **CBR** for a simple scene and **VBR** for a more complex scene.
- **Video Quality:** Set the video quality from the lowest to the highest from the drop-down list.
- **Bitrate Mode:** Select **Predefined** to set a predefined bitrate. Or, select **User-defined** to customize the desired bitrate.
- **Bitrate:** This parameter corresponds to the speed of data transmission for the DVR to record videos. Recordings that are encoded at higher bitrates will be of better quality.

- **Audio:** Check the box to record audio along with video. To enable this function, connect an external microphone or camera with audio capability to the DVR.
- **ETR:** Enable this function to define two frames and resolutions when alarm is triggered and untriggered.

Audio: To configure relevant parameters of camera audio. Note that this tab is only applicable when the DVR is connected to devices with audio function.

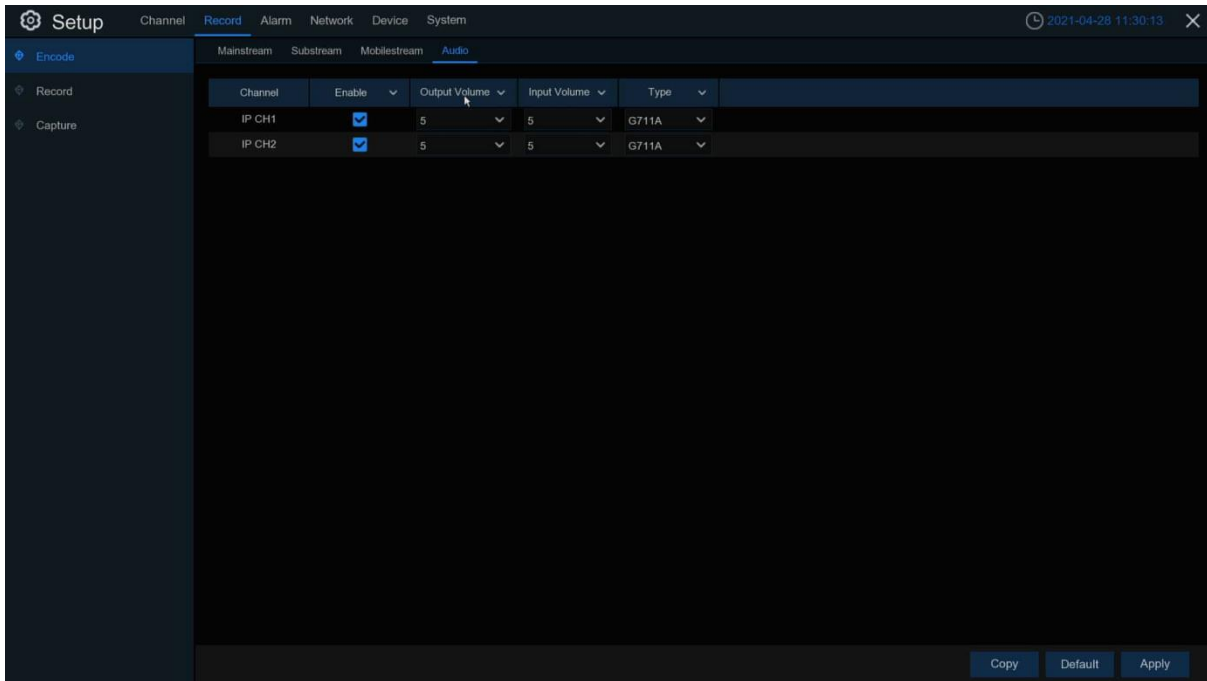

- **Enable:** Switch for camera audio setting.
- **Output Volume:** Set the output volume of the camera.
- **Input Volume:** Set the input volume of the camera.
- **Type:** Set the audio decoding type for the camera.

5.2.2 Record

This menu allows you to configure the channel recording parameters.

5.2.2.1 Record

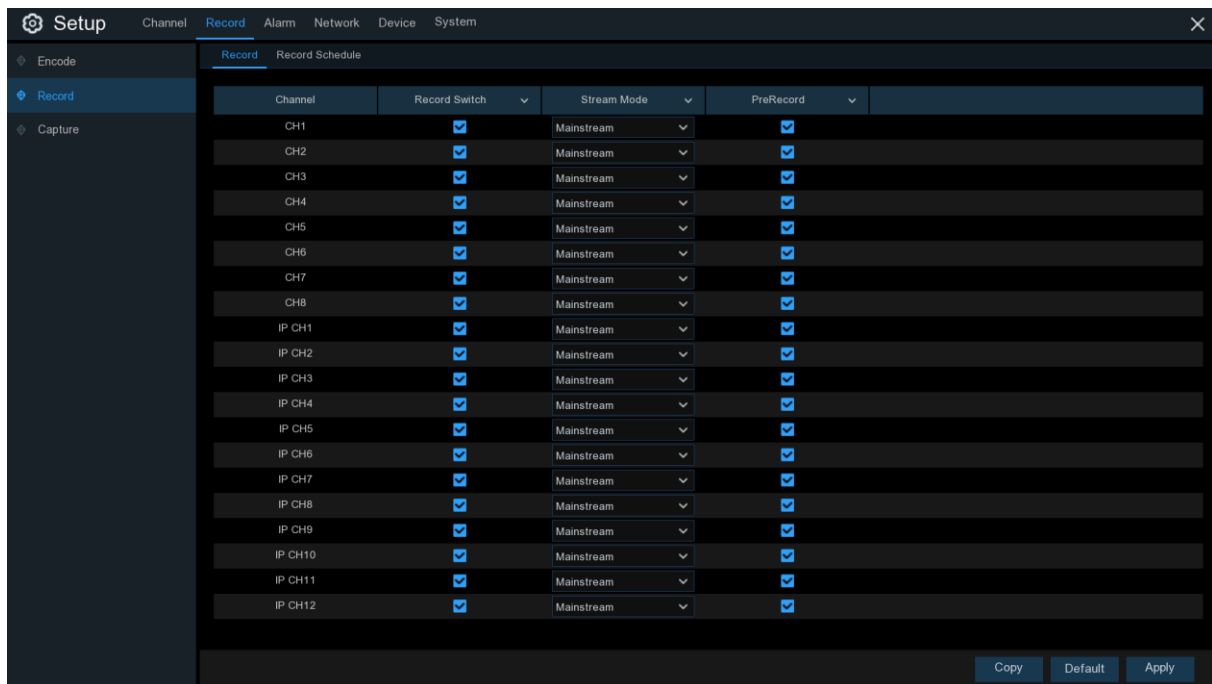

- **Record Switch:** Check the box to enable recording on the channel.
- **Stream Mode:** Choose the recording quality. Select **Mainstream** to only record videos on Mainstream or select **Dualstream** to record videos on both Mainstream and Substream.
- **PreRecord:** If this option is enabled, the DVR starts recording a few seconds before an alarm event occurs. Use this option if your primary recording type is motion or I/O alarm-based.

5.2.2.2 Record Schedule

This tab allows you to specify when the DVR records video and defines the recording mode for each channel. The recording schedule allows you to set up a daily / hourly schedule under 4 recording mode, including normal (continuous) recording, motion recording, I / O alarm recording, and PIR recording (if your DVR supports). To set the recording mode, click on the mode radio button (**Normal, Motion, IO, PIR**) and drag the cursor to mark the slots. The recording schedule is valid only for one channel. Click **Apply** to save your settings. You can optionally click **Copy** and select the date and target channel to paste the recording schedule.

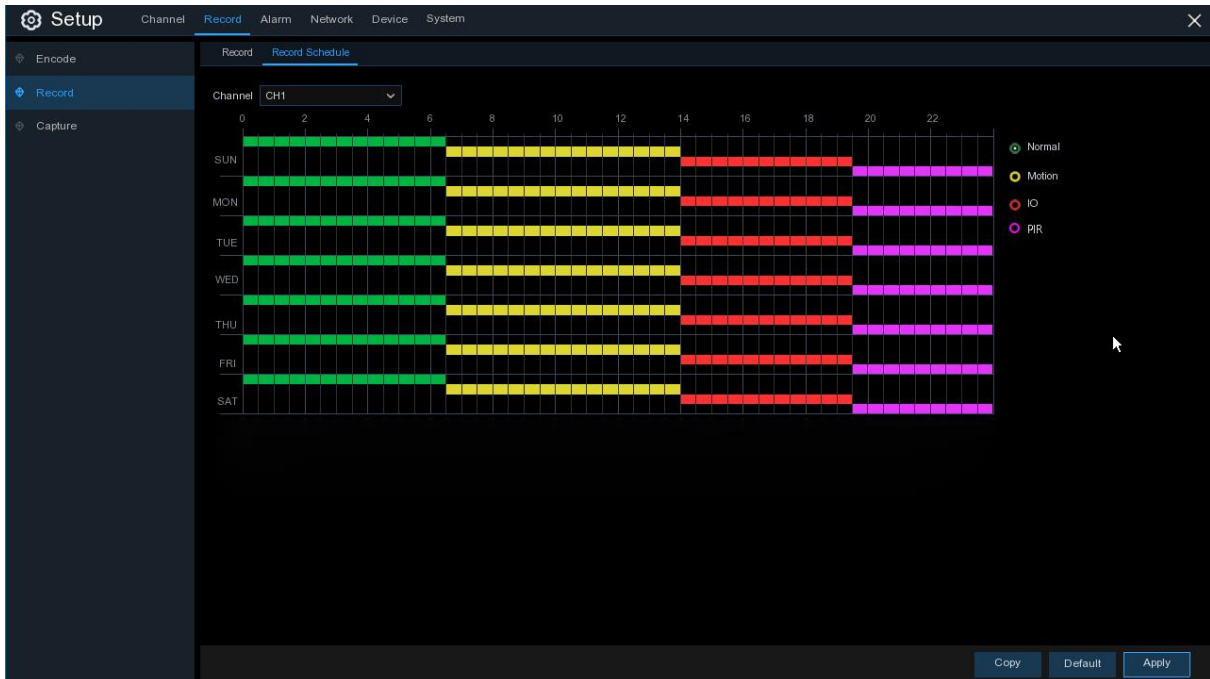

- **Channel:** Select the channel to set its recording schedule.
- **Normal:** When the time slot is marked green, this indicates the channel performs normal recording for that time slot.
- **Motion:** When the time slot is marked yellow, this indicates the channel records only when a motion is detected during the specified time slot.
- **IO:** When the time slot is marked red, this indicates the channel records only when the sensor is triggered during the specified time slot.
- **PIR:** When the time slot is marked purple, this indicates the channel records only when the PIR is triggered during the specified time slot.
- **No Record:** A time slot marked black means that there is no recording scheduled for the specific time slot.

5.2.3 Capture

This menu allows to configure the image capture function.

5.2.3.1 Capture

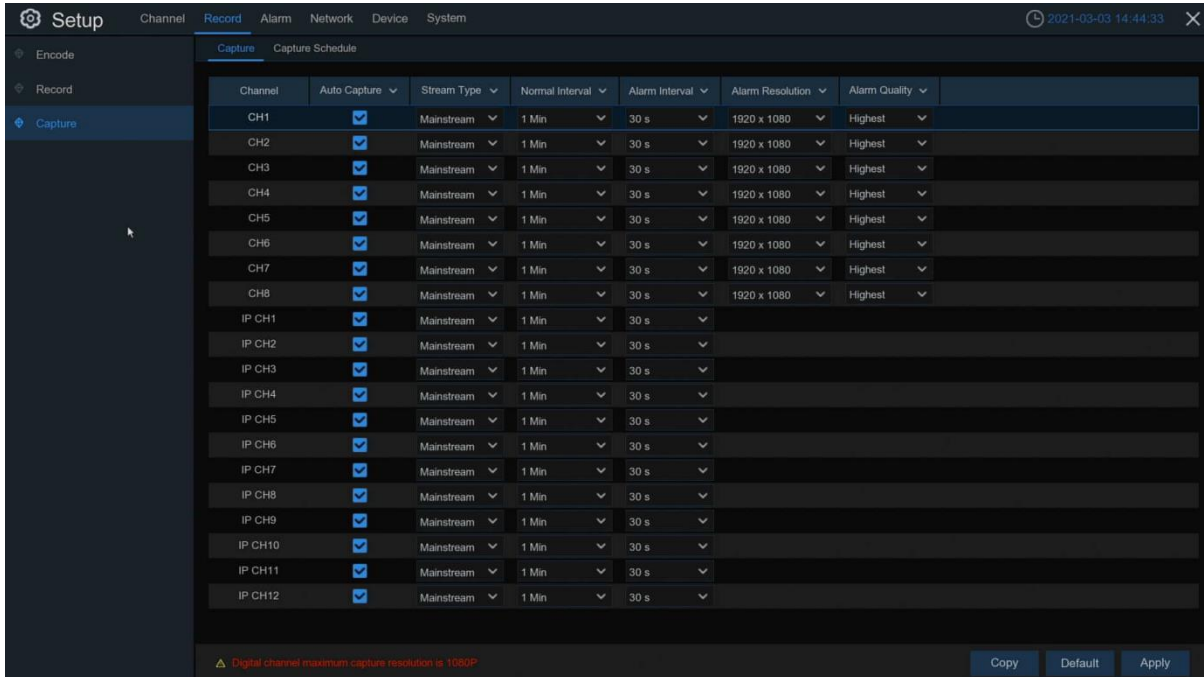

Channel	Auto Capture	Stream Type	Normal Interval	Alarm Interval	Alarm Resolution	Alarm Quality
CH1	<input checked="" type="checkbox"/>	Mainstream	1 Min	30 s	1920 x 1080	Highest
CH2	<input checked="" type="checkbox"/>	Mainstream	1 Min	30 s	1920 x 1080	Highest
CH3	<input checked="" type="checkbox"/>	Mainstream	1 Min	30 s	1920 x 1080	Highest
CH4	<input checked="" type="checkbox"/>	Mainstream	1 Min	30 s	1920 x 1080	Highest
CH5	<input checked="" type="checkbox"/>	Mainstream	1 Min	30 s	1920 x 1080	Highest
CH6	<input checked="" type="checkbox"/>	Mainstream	1 Min	30 s	1920 x 1080	Highest
CH7	<input checked="" type="checkbox"/>	Mainstream	1 Min	30 s	1920 x 1080	Highest
CH8	<input checked="" type="checkbox"/>	Mainstream	1 Min	30 s	1920 x 1080	Highest
IP CH1	<input checked="" type="checkbox"/>	Mainstream	1 Min	30 s		
IP CH2	<input checked="" type="checkbox"/>	Mainstream	1 Min	30 s		
IP CH3	<input checked="" type="checkbox"/>	Mainstream	1 Min	30 s		
IP CH4	<input checked="" type="checkbox"/>	Mainstream	1 Min	30 s		
IP CH5	<input checked="" type="checkbox"/>	Mainstream	1 Min	30 s		
IP CH6	<input checked="" type="checkbox"/>	Mainstream	1 Min	30 s		
IP CH7	<input checked="" type="checkbox"/>	Mainstream	1 Min	30 s		
IP CH8	<input checked="" type="checkbox"/>	Mainstream	1 Min	30 s		
IP CH9	<input checked="" type="checkbox"/>	Mainstream	1 Min	30 s		
IP CH10	<input checked="" type="checkbox"/>	Mainstream	1 Min	30 s		
IP CH11	<input checked="" type="checkbox"/>	Mainstream	1 Min	30 s		
IP CH12	<input checked="" type="checkbox"/>	Mainstream	1 Min	30 s		

△ Digital channel maximum capture resolution is 1080P

Copy Default Apply

- **Auto Capture:** Check the box to enable automatic image capture on the channel.
- **Stream Type:** Select the image resolution by mainstream or sub-stream.
- **Normal Interval:** Select the time interval to capture an image during normal recording.
- **Alarm Interval:** Select the time interval to capture an image when motion, I / O alarm or PIR is triggered.
- **Alarm Resolution:** Set the capture resolution when alarm triggered. Only optional for analog channels.
- **Alarm Quality:** Select the capture image quality when the alarm is triggered.

5.2.3.2 Capture Schedule

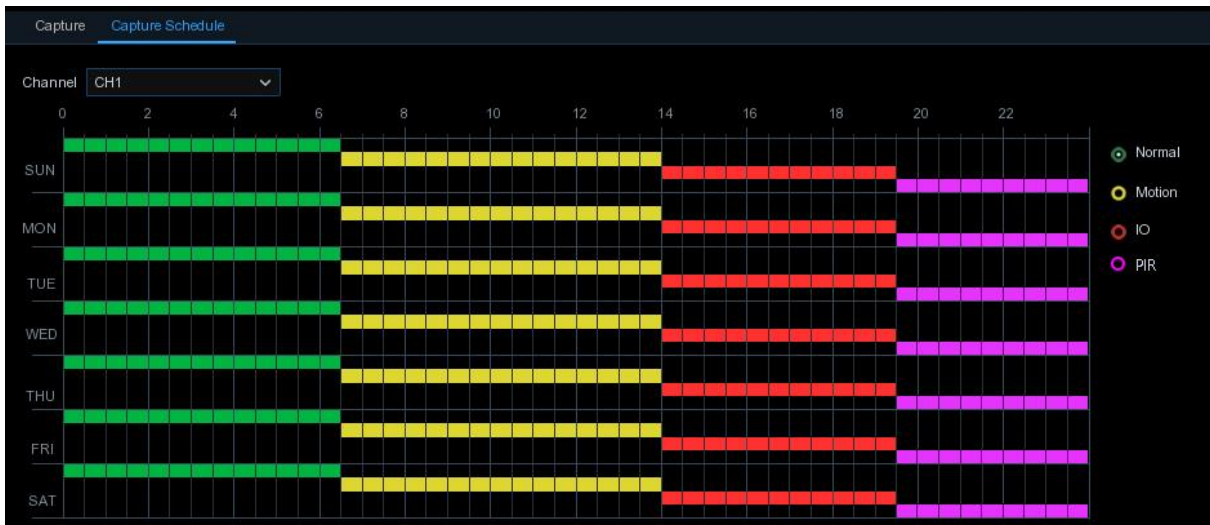

- **Normal:** When the time slot is marked green, this indicates the channel performs normal image capture for the specified time slot.
- **Motion:** When the time slot is marked yellow, this indicates the channel captures images only when a motion is detected during the specified time slot.
- **IO:** When the time slot is marked red, this indicates the channel captures images only when the sensor is triggered during the specified time slot.
- **PIR:** When the time slot is marked purple, this indicates the channel captures images only when the PIR is triggered during the specified time slot.
- **No Capture:** A time slot marked black means that it won't capture any images for the specified time slot, but you can manually capture images if you enable the manual capture function in the channel.

5.3 Alarm

In this section, you can configure the alarm parameters.

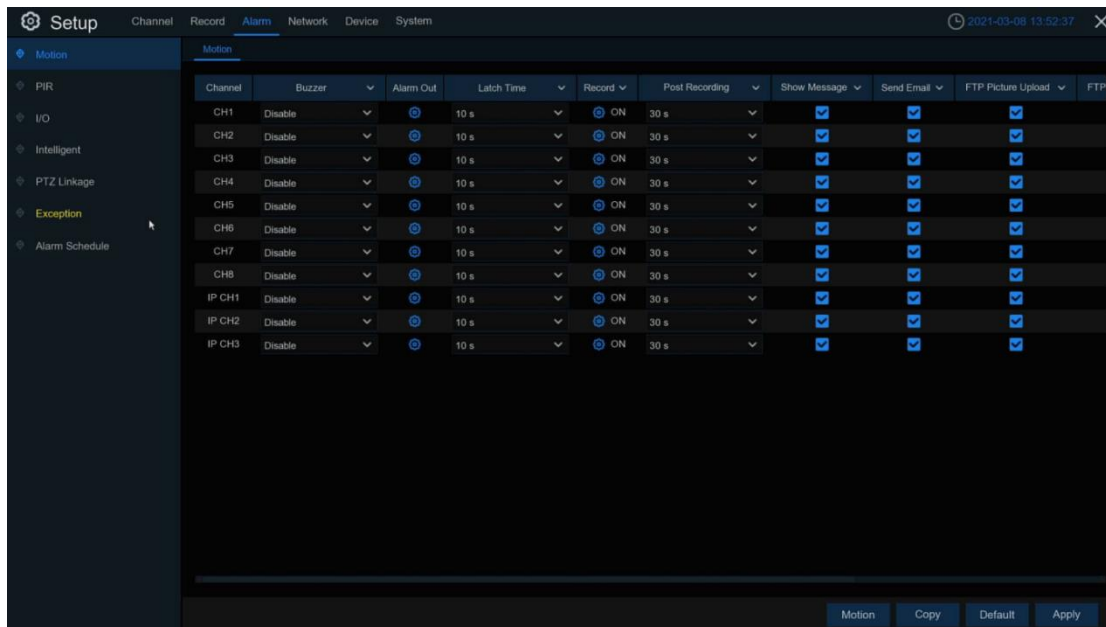

5.3.1 Motion

Refer to *5.1.6 Motion* for details.



5.3.2 PIR

Refer to *5.1.6 Motion* for details.

5.3.3 I / O

You can connect external sensor I / O alarm devices to work with the DVR.

Alarm In	Alarm Type	Buzzer	Alarm Out	Latch Time	Record	Post Recording	Show Message	Send Email	Full Screen
IO-1	Normally-Open	Disable	<input type="checkbox"/>	10 s	ON	30 s	<input checked="" type="checkbox"/>	<input checked="" type="checkbox"/>	<input type="checkbox"/>
IO-2	Normally-Open	Disable	<input type="checkbox"/>	10 s	ON	30 s	<input checked="" type="checkbox"/>	<input checked="" type="checkbox"/>	<input type="checkbox"/>
IO-3	Normally-Open	Disable	<input type="checkbox"/>	10 s	ON	30 s	<input checked="" type="checkbox"/>	<input checked="" type="checkbox"/>	<input type="checkbox"/>
IO-4	Normally-Open	Disable	<input type="checkbox"/>	10 s	ON	30 s	<input checked="" type="checkbox"/>	<input checked="" type="checkbox"/>	<input type="checkbox"/>
IO-5	Normally-Open	Disable	<input type="checkbox"/>	10 s	ON	30 s	<input checked="" type="checkbox"/>	<input checked="" type="checkbox"/>	<input type="checkbox"/>
IO-6	Normally-Open	Disable	<input type="checkbox"/>	10 s	ON	30 s	<input checked="" type="checkbox"/>	<input checked="" type="checkbox"/>	<input type="checkbox"/>
IO-7	Normally-Open	Disable	<input type="checkbox"/>	10 s	ON	30 s	<input checked="" type="checkbox"/>	<input checked="" type="checkbox"/>	<input type="checkbox"/>
IO-8	Normally-Open	Disable	<input type="checkbox"/>	10 s	ON	30 s	<input checked="" type="checkbox"/>	<input checked="" type="checkbox"/>	<input type="checkbox"/>

- **Alarm In:** I / O channel.
- **Alarm Type:** There are 3 types of alarms: **Normally-Open**, **Normally-Close**, and **OFF**. Choose the one to match your sensor type, or choose OFF to close the sensor trigger function.
- **Buzzer:** The DVR can use its internal buzzer to emit an alarm tone. You can set the buzzer duration up to one minute when a sensor is triggered.
- **Alarm out:** Click  and check the box to enable the external alarm device to emit an alarm tone when a sensor is triggered.
- **Latch Time:** You can set the time duration for the buzzer to sound when the external sensor is triggered.
- **Channel:** Click  and choose the channel(s) you wish to record when the motion detection is triggered.

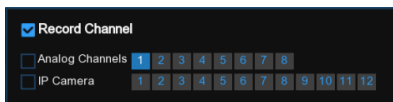

- **Post Recording:** Set the time length for the DVR to continue recording after the alarm ends.
- **Show Message:** Display the alarm messages on screen when the sensor is triggered.
- **Send Email:** Set to send email alerts when sensor is triggered.
- **FTP Picture Upload:** Check the box to upload alarm images to FTP server when the I / O alarm is triggered. To enable FTP, refer to *5.4.4 FTP*.
- **FTP Video Upload:** Check the box to upload alarm videos to FTP server when the I / O alarm is triggered. To enable FTP, refer to *5.4.4 FTP*.
- **Picture to Cloud:** Check the box to upload alarm images to cloud storage when the I / O alarm is triggered. Refer to *5.5.2 Cloud* for details.
- **Video to Cloud:** Check the box to upload alarm videos to cloud storage when the I / O alarm is triggered. Refer to *5.5.2 Cloud* for details.
- **Full Screen:** When the sensor is triggered, the corresponding channel will be switched to the full screen mode.

5.3.4 Intelligent

Refer to *5.1.9 Intelligent* for details.

5.3.5 PTZ Linkage

If a PTZ camera is connected to the DVR, you can set the linkage between the PTZ camera and Motion Alarm / external I / O sensor alarm. With this function, you can turn your PTZ camera's focus to the preset point when a motion or I / O alarm is triggered.

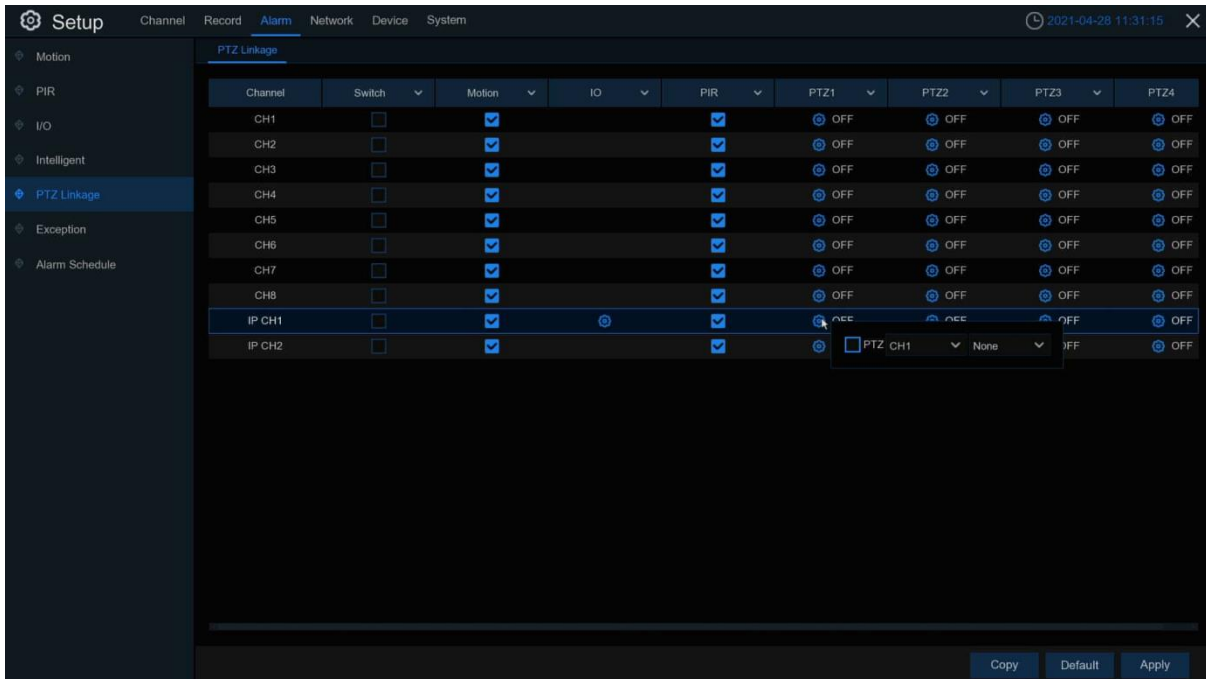

- **Switch:** Check the box to enable the PTZ linkage function.
- **Motion:** Motion detection alarm will trigger the specified PTZ camera's linkage function.
- **IO:** IO alarm will trigger the specified PTZ camera's linkage function.
- **PIR:** PIR Alarm will trigger the specified PTZ camera's linkage function.
- **PTZ1-4:** A maximum of 4 preset points can be set. Click  to associate the PTZ cameras with preset points. Refer to 5.1.4.1 PTZ for more details.
 - ⊙ Select the desired PTZ camera and preset points from the drop-down list for the linkage.
 - ⊙ Select the **PTZ** box to enable the linkage.

5.3.6 Exception

This menu allows you to set the type of events for DVR to display notifications.

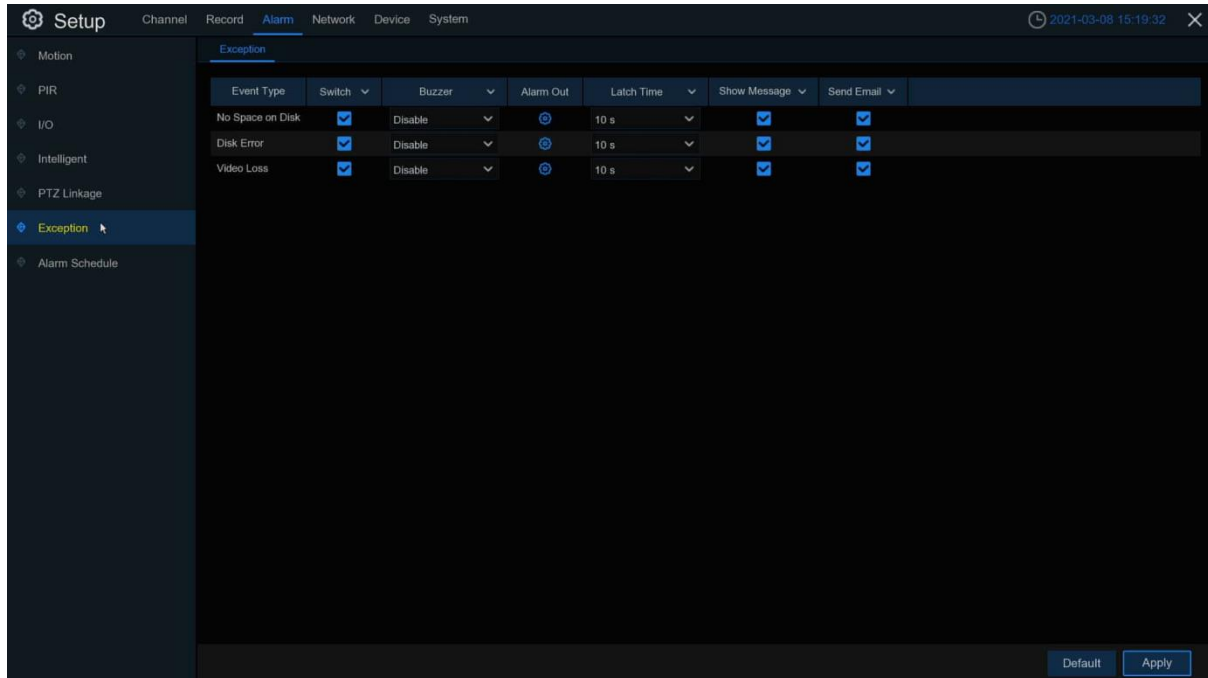

- **Event Type:** Select the event type from the options below:
 - ⊙ **No Space on Disk:** When the HDD storage is full.
 - ⊙ **Disk Error:** When the HDD is not detected properly.
 - ⊙ **Video Loss:** When a camera is not connected properly.
- **Switch:** Check the box to enable the monitoring of the event.
- **Buzzer:** Set the buzzer duration when the event occurs. To disable the buzzer, select **OFF**.
- **Alarm Out:** Click  and check the box to enable the external alarm device to sound. This is only applicable to models that support to connect to external alarm devices.
- **Latch Time:** Set the time length for the external alarm device to sound. This is only applicable to models that support to connect external alarm devices.
- **Show Message:** Check the box for the DVR to display a message on the screen when the specified event happens.
- **Send Email:** Check the box for the DVR to send an e-mail notification when the specified event happens.

5.3.7 Alarm Schedule

You can set the schedule of various alarms under this tab.

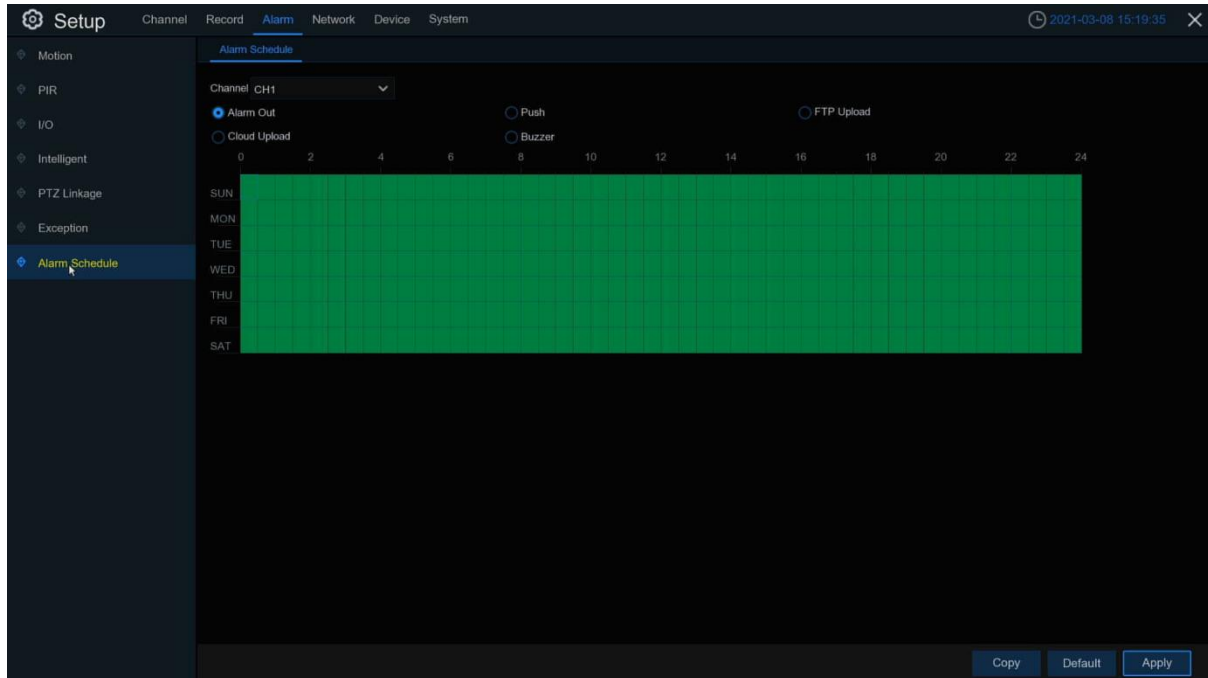

- **Channel:** Select the channel.
- **Alarm Out:** Set the schedule for alarm out.
- **FTP Upload:** Set the schedule for FTP uploading.
- **Cloud Upload:** Set the schedule for cloud upload.
- **Buzzer:** Set the schedule for buzzer.

5.4 Network

This menu allows you to configure network parameters, such as PPPoE, DHCP, and 3G. The most common types are DHCP. Most probably your network type is DHCP, unless the network is manually addressed. If you need an authentication user name and password to the Internet, choose PPPoE. If you want to use mobile network connection, choose 3G.

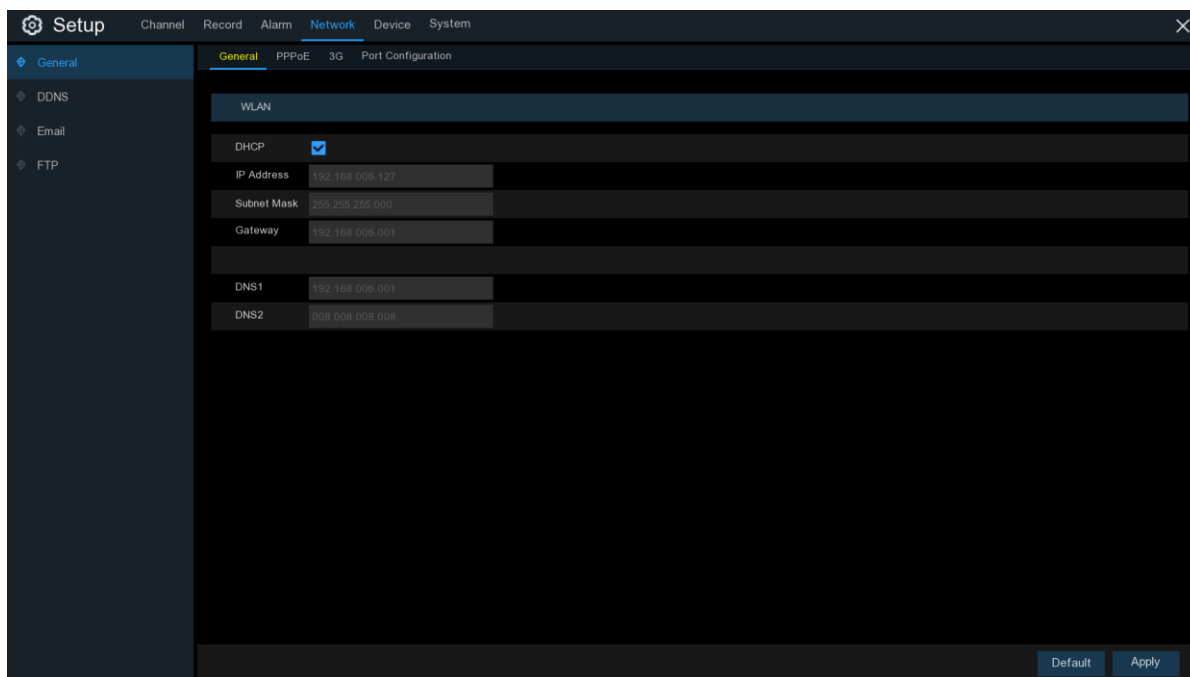

The screenshot shows the 'Setup' window with the 'Network' tab selected. The 'General' sub-tab is active, showing the following configuration options:

- WLAN**: A toggle switch that is currently turned off.
- DHCP**: A checked checkbox, indicating that DHCP is enabled.
- IP Address**: 192.168.0.05.127
- Subnet Mask**: 255.255.255.000
- Gateway**: 192.168.0.05.001
- DNS1**: 192.168.0.05.001
- DNS2**: 008.008.008.008

At the bottom right of the configuration area, there are two buttons: 'Default' and 'Apply'.

5.4.1 General

5.4.1.1 General

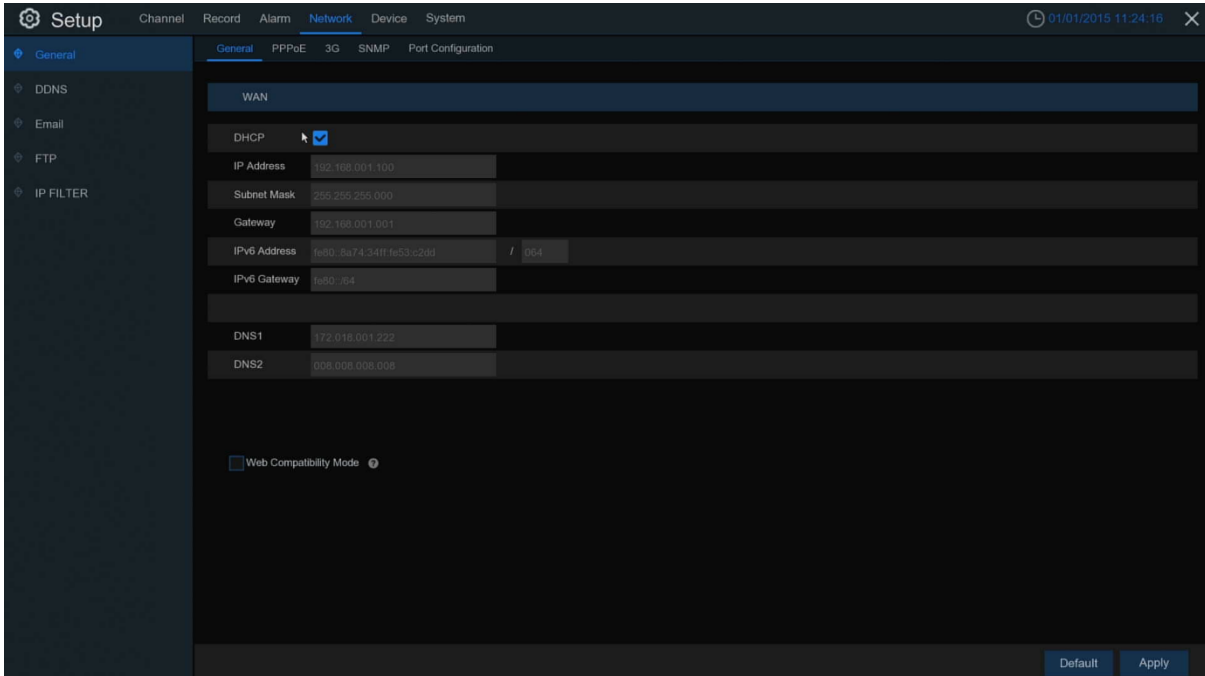

The screenshot shows the 'Setup' interface for a USA Vision DVR. The 'Network' tab is selected, and the 'General' sub-tab is active. The 'WAN' section is expanded, showing the following configuration:

- DHCP:** (checked)
- IP Address:** 192.168.001.100
- Subnet Mask:** 255.255.000.000
- Gateway:** 192.168.001.001
- IPv6 Address:** fe80::9a74:34ff:fe53:c28d / 64
- IPv6 Gateway:** fe80::64
- DNS1:** 172.16.001.222
- DNS2:** 008.008.008.008
- Web Compatibility Mode:** (unchecked)

Buttons for 'Default' and 'Apply' are visible at the bottom right of the configuration area.

If you connect to a router that allows you to use DHCP, check the **DHCP** box. The router will automatically assign all the network parameters for your DVR. Unless the network is manually addressed below parameters:

- **IP Address:** The IP address identifies the DVR in the network. It consists of four groups of numbers between 0 to 255, separated by periods. For example, “192.168.001.100”.
- **Subnet Mask:** Subnet mask is a network parameter which defines a range of IP addresses that can be used in a network. The subnet address also consists of four groups of numbers, separated by periods. For example, “255.255.000.000”.
- **Gateway:** This address allows the DVR to access the Internet. The format of the **Gateway** address is the same as the **IP Address**. For example, “192.168.001.001”.
- **IPv6 Address:** Please fill the IPv6 address to be set if your network support IPv6.
- **IPv6 Gateway:** Please fill the gateway to be set if your network support IPv6.
- **DNS1/DNS2:** DNS1 is the primary DNS server and DNS2 is a backup DNS server. Usually should be enough just to enter the DNS1 server address.
- **Web Compatibility Mode:** If the selected browser does not support web page connection to the device, enable this mode. The system will select a less secure decryption method, so choose it carefully.

5.4.1.2 PPPoE

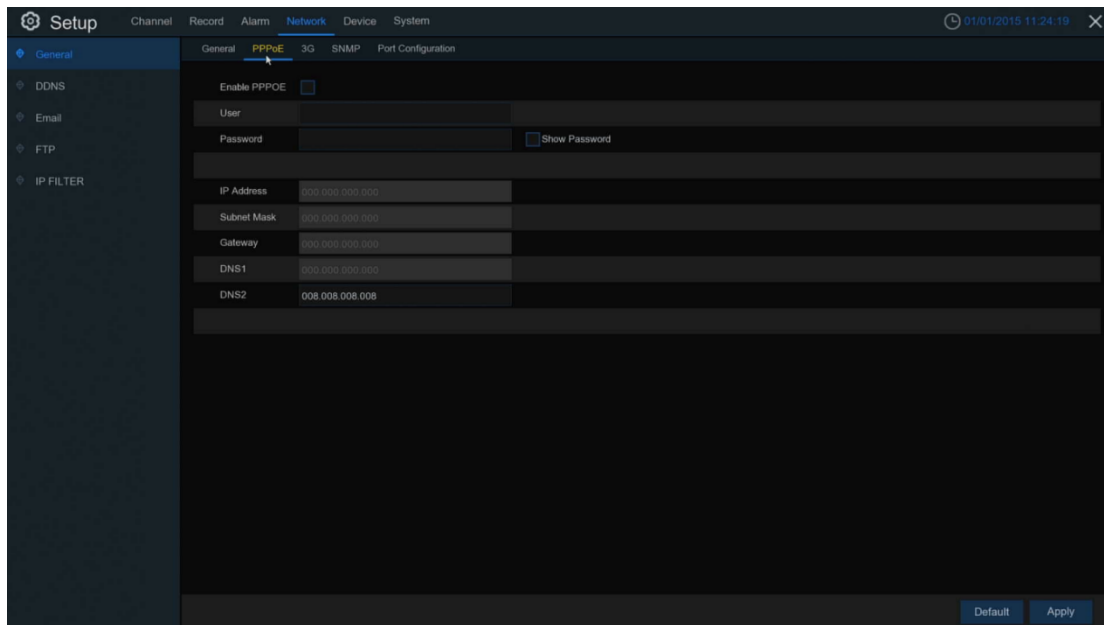

This is an advanced protocol that allows the DVR to connect to the network more directly via DSL modem.

1. Check the **Enable PPPOE** box and enter the User name and Password of the PPPoE.
2. Click **Apply** to save. The system will reboot to activate the PPPoE setting.

5.4.1.3 Port Configuration

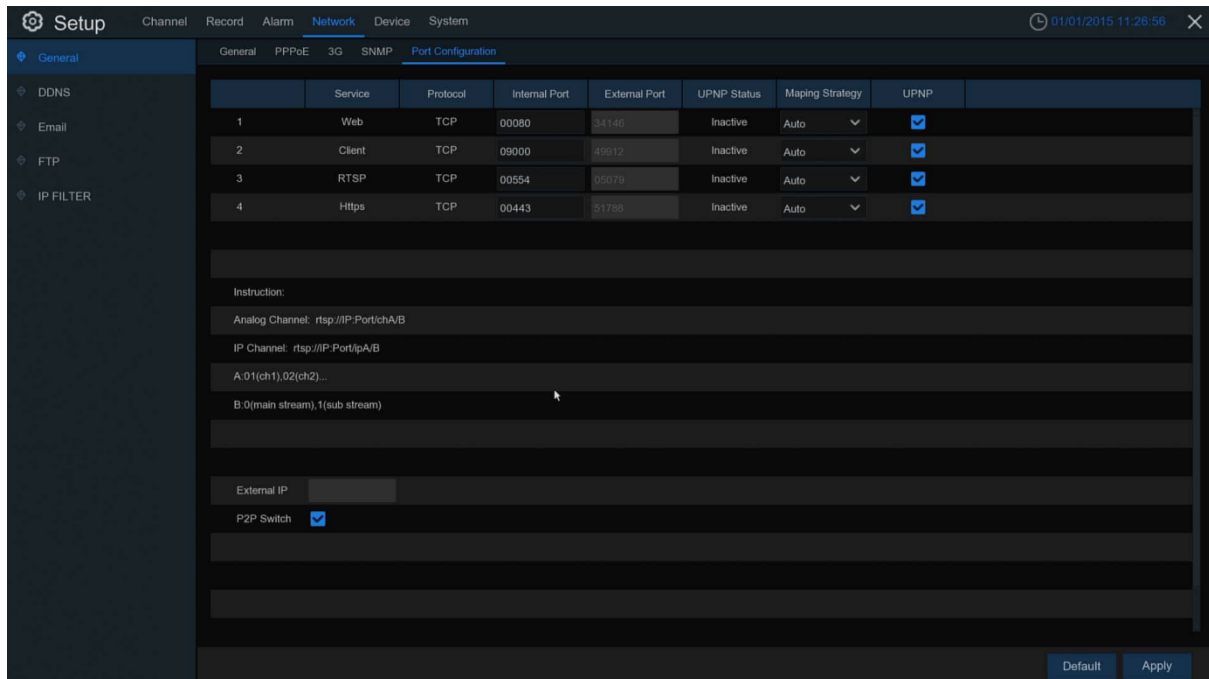

- **Web Port:** This is the port that you will use to log in remotely to the DVR (e.g. using the Web Client). If the default port 80 is already taken by other applications, please change it.
- **RTSP Port:** Default is 554, if the default port 554 is already taken by other applications, please change it.
- **UPnP:** If you want to log in remotely to the DVR using Web Client, you need to complete the port forwarding. Enable this option if your router supports the UPnP. You need to enable UPnP both, on DVR and router. In this case, you do not need to configure manually port forwarding on your router. If your router does not support UPnP, make sure the port forwarding is completed manually
- **P2P Switch:** P2P connection can't work once switch disable.

Note:

1. The RTSP commands of the DVR are shown as below:
 For main stream display: `rtsp://<IP address>:554/ch#/0`
 For sub stream display: `rtsp://<IP address>:554/ch#/1`
2. For how to connect GV-IP Decoder Box Ultra to the DVR through RTSP, see the [technical notice](#).

5.4.2 DDNS (Dynamic Domain Name Server)

This menu allows you to configure DDNS settings. The DDNS provides a static address to simplify remote connection to your DVR. To use the DDNS, you first need to open an account on the DDNS service provider's web page.

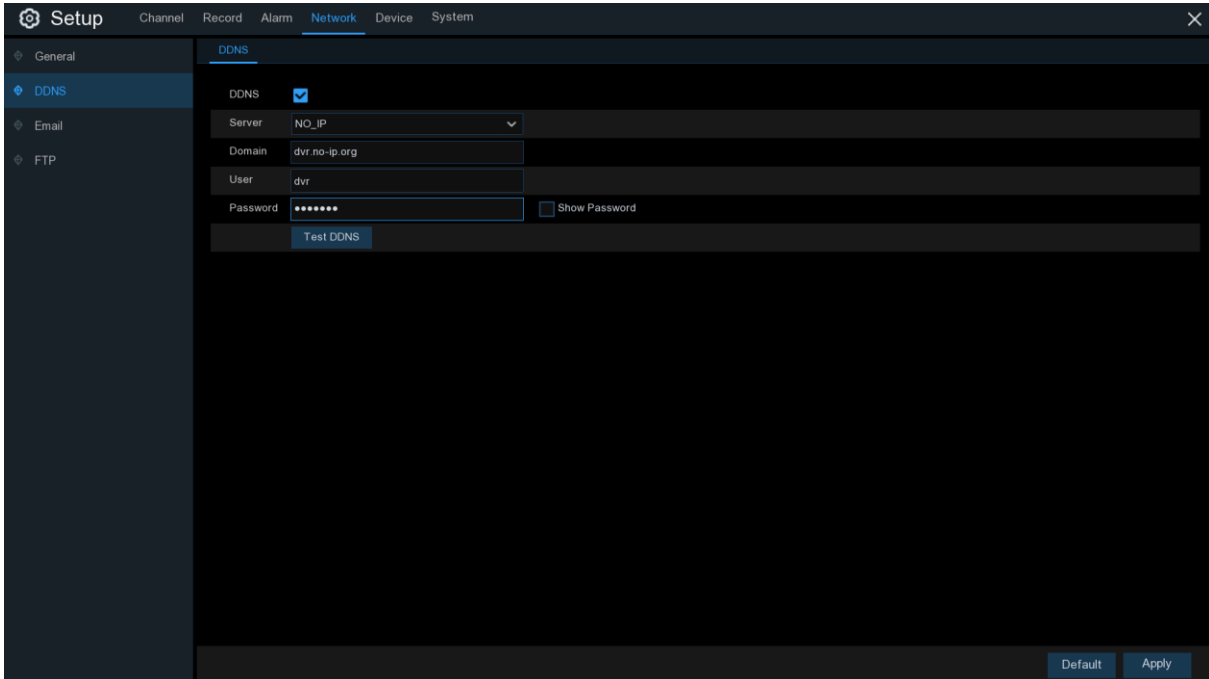

- **DDNS:** Check to enable DDNS.
- **Server:** Select the preferred DDNS server.
- **Domain:** Enter the domain name you created on the DDNS service provider's web page. This will be the address you type in the URL box when you want to connect remotely to the DVR via PC. For example: dvr.no-ip.org.
- **User / Password:** Enter the user name and password you obtained when creating an account on the DDNS service provider's web page.

After all parameters are entered, click **Test** to test the DDNS settings. If the test result is "Network is unreachable or DNS is incorrect", please check whether the network works fine, or the DDNS information is correct or not.

5.4.3 Email

This menu allows you to configure email settings. Please complete these settings if you want to receive the system notifications on your email when an alarm is triggered, HDD becomes full, HDD is in error state, or Video Loss occurs.

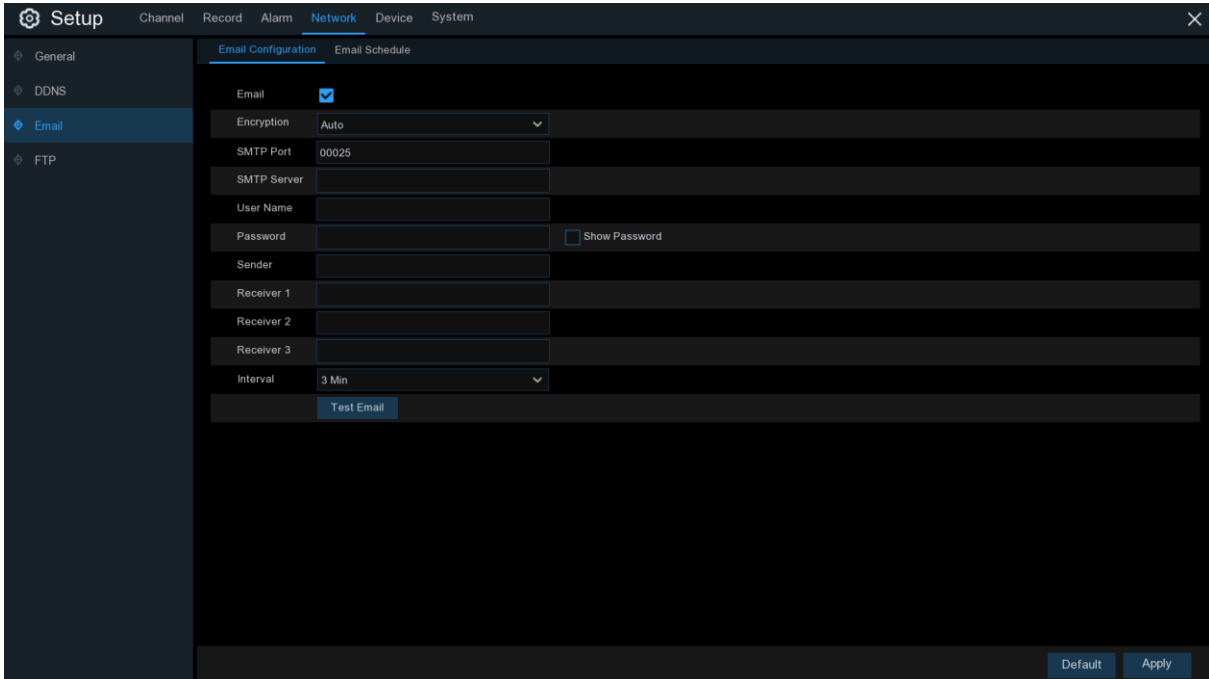

The screenshot shows the 'Setup' interface with the 'Network' tab selected. Under 'Network', the 'Email Configuration' sub-tab is active. The 'Email' checkbox is checked. The 'Encryption' dropdown is set to 'Auto'. The 'SMTP Port' is set to '00025'. The 'SMTP Server', 'User Name', 'Password', 'Sender', 'Receiver 1', 'Receiver 2', and 'Receiver 3' fields are empty. The 'Interval' dropdown is set to '3 Min'. A 'Test Email' button is visible at the bottom of the configuration area. At the bottom right of the window, there are 'Default' and 'Apply' buttons.

5.4.3.1 Email Configuration

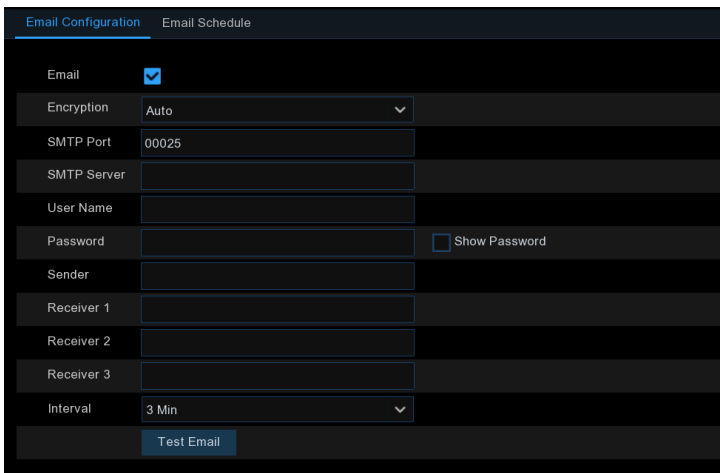

This close-up screenshot shows the 'Email Configuration' settings. The 'Email' checkbox is checked. The 'Encryption' dropdown is set to 'Auto'. The 'SMTP Port' is set to '00025'. The 'SMTP Server', 'User Name', 'Password', 'Sender', 'Receiver 1', 'Receiver 2', and 'Receiver 3' fields are empty. The 'Interval' dropdown is set to '3 Min'. A 'Test Email' button is visible at the bottom of the configuration area.

- **Email:** Check to enable.
- **Encryption:** Enable if your email server requires the SSL or TLS verification. If you are not sure, set to be **Auto**.
- **SMTP Port:** Enter the SMTP port of your email server.
- **SMTP Server:** Enter the SMTP server address of your email.

- **User Name:** Enter your email address.
- **Password:** Enter the password of your email.
- **Receiver 1~3:** Enter the email addresses where you want to receive the event notifications from the DVR.
- **Interval:** Configure the length of the time interval between the notification emails from the DVR.

To make sure all settings are correct, click **Test**. The system sends an automated email message to your inbox. If you received the test email, it means the configuration parameters are correct.

5.4.3.2 Email Schedule

You need to configure the schedule to fully implement the email notification.

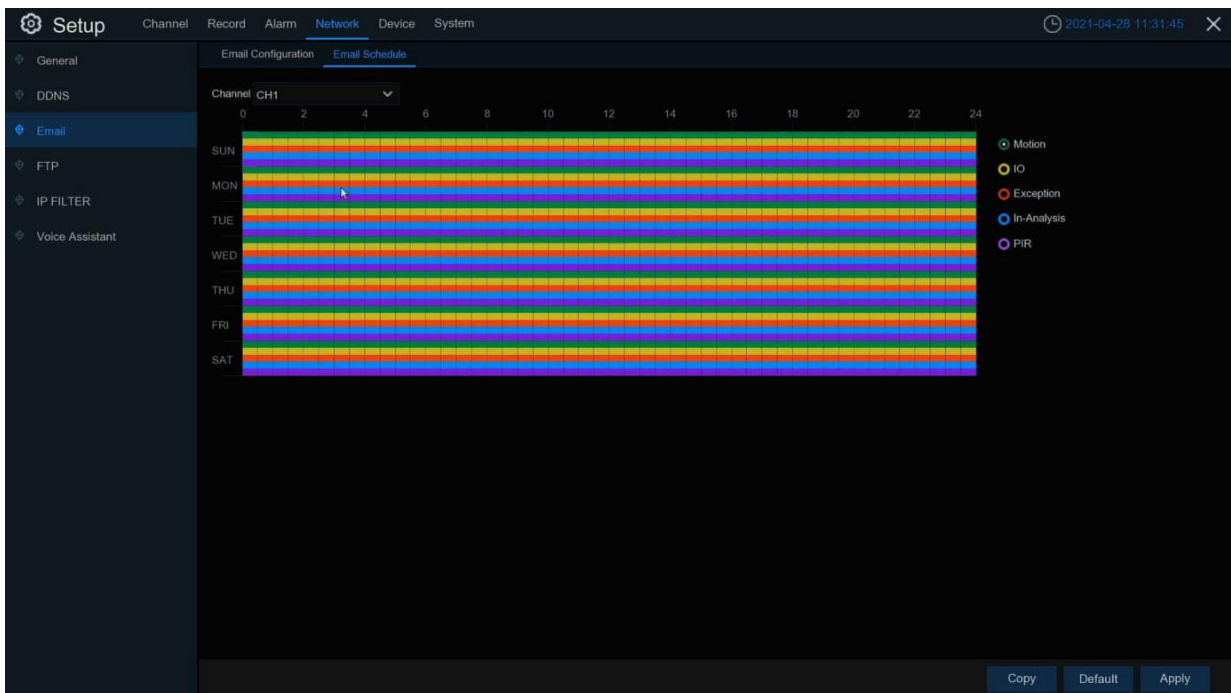

The color codes on email schedule have the following meanings:

- **Green:** Motion
- **Yellow:** IO
- **Red:** Exception
- **Blue:** In-Analysis
- **Purple:** PIR

5.4.4 FTP

This menu allows you to enable FTP function to view and load captured snapshots from DVR to your storage device over FTP.

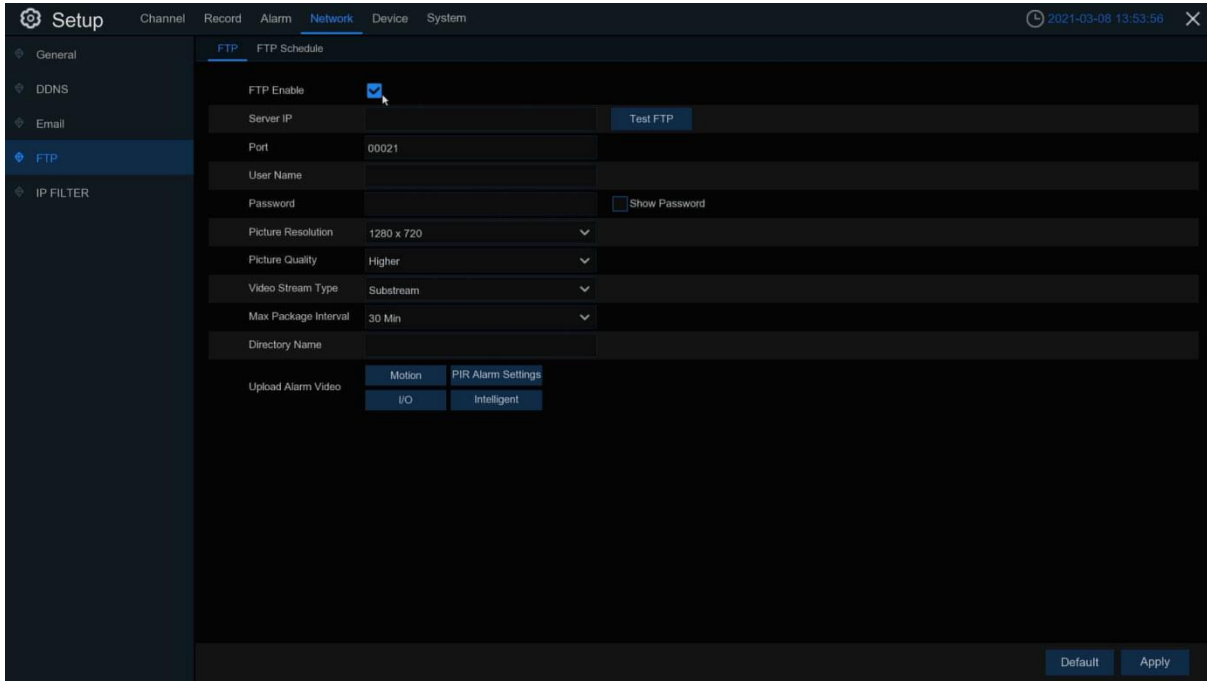

5.4.4 FTP

- **FTP Enable:** Click to enable FTP function.
- **Server IP:** Enter your FTP server IP address or domain name.
- **Port:** Enter the FTP port for file exchanges.
- **User Name/ Password:** Enter your FTP server user name and password.
- **Picture Resolution:** Set the resolution of the image uploaded to FTP.
- **Picture Quality:** Set the quality of the image uploaded to FTP.
- **Video Stream Type:** Set the video stream type uploaded to FTP.
- **Max Package Interval:** Set the Max Package Interval of videos.
- **Directory Name:** Enter the default directory name for the FTP file exchanges.
- **Test FTP:** Click to test the FTP settings.

5.4.4.2 FTP Schedule

You can configure the plan to perform FTP file uploading.



The color codes on email schedule have the following meanings:

- **Green:** Motion
- **Yellow:** IO
- **Blue:** In-Analysis
- **Purple:** PIR

5.4.5 IP Filter

This function allows you to set a allow list and black list so that only the IP addresses on the allow list can connect to the device.

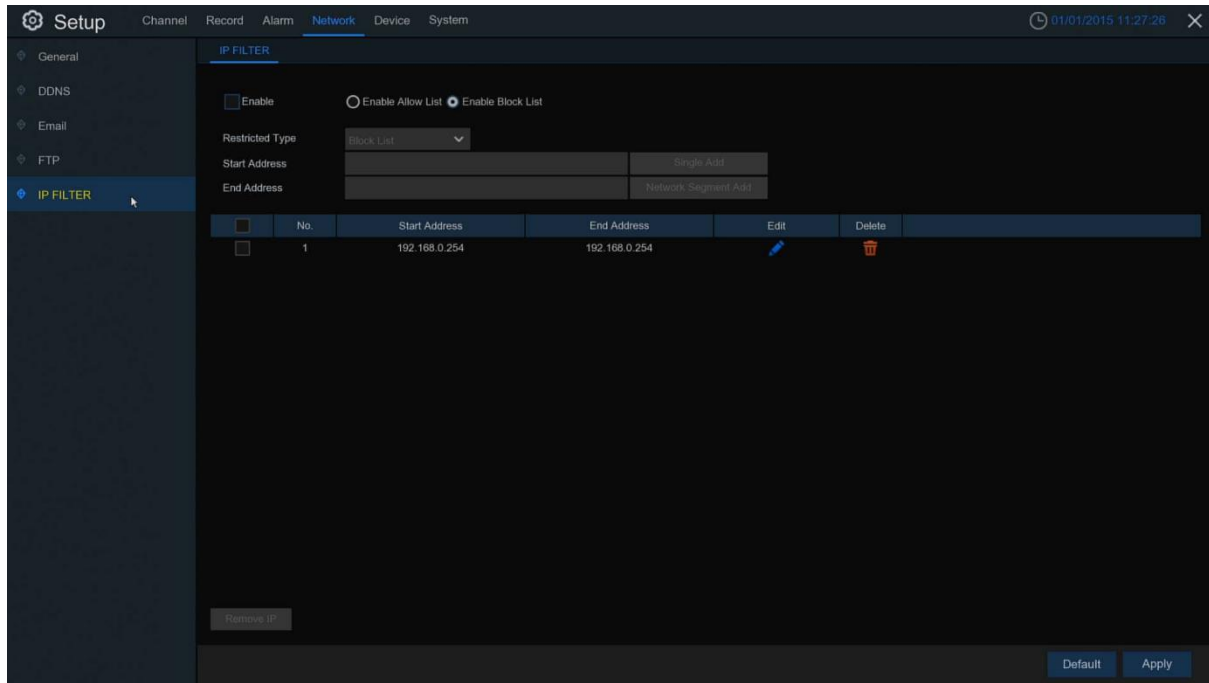

- **Enable:** Enable or disable the IP filter function. Once enabled, you can select to filter the IP addresses by allow list or black list.
- **Restricted Type:** Select the list (**Black List** or **Allow List**) to finish relevant configurations.
- **Single Add:** Enter the IP address to add to the list.
- **Network Segment Add:**
 - ⊙ **Start Address:** Input the **Start Address**.
 - ⊙ **End Address:** Input the **End Address**.

5.4.6 Voice Assistant

This menu allows you to project a preview onto the screen via Amazon or Google cast Screen.

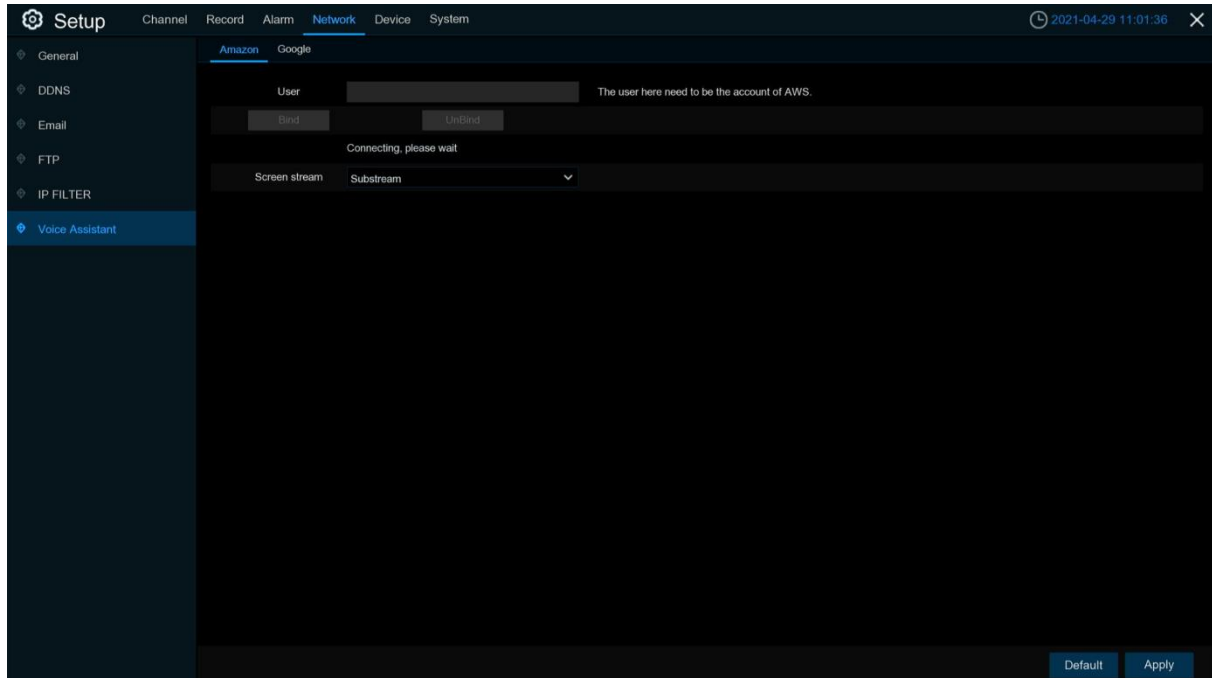

- **User:** Input the Google / AWS account.
- **Bind:** Click to bind the account.
- **UnBind:** Click to unbind the account.
- **Screen stream:** Set the cast screen stream.

For Amazon: After the binding is finished, give a voice command Discover to the remote controller of fire stick TV, then can add the device bound to the linked account. Open Amazon Alexa APP, click the **Device** at the right corner to check the added devices.

5.4.7 Platform Access

- **Enable:** Check the box to enable the function.
- **Authentication:**
- **Protocol:**
- **User Name / Password:**

5.5 Device

In this section, you can configure the internal HDD and Cloud storage function.

5.5.1 Disk

This menu allows you to check and configure the internal HDD(s). You need to format the HDD only at the first startup and if you replace a new HDD.

5.5.1.1 Disk

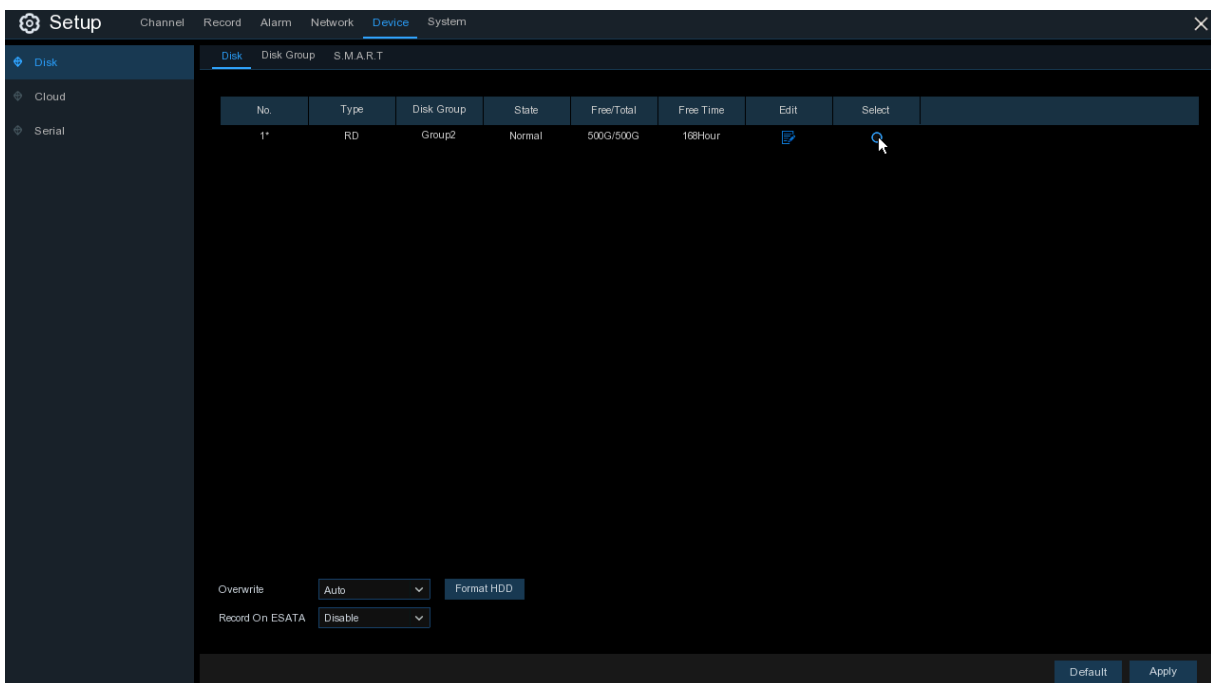

- **Format HDD:** Select the HDD you want to format and click **Format HDD**. To start formatting, you need to enter your password and click **Authenticate** to confirm to continue formatting.
- **Overwrite:** Use this option to overwrite the old recordings on the HDD when the HDD is full. For example, if you choose the option 7 days then only the last 7 days recordings are kept on the HDD. To prevent overwriting any old recordings, select **OFF**. If you have disabled this function, please check the HDD status regularly to make sure the HDD is not full. Recording will be stopped if HDD is full.
- **Add NetHDD:** Click to add net HDD.

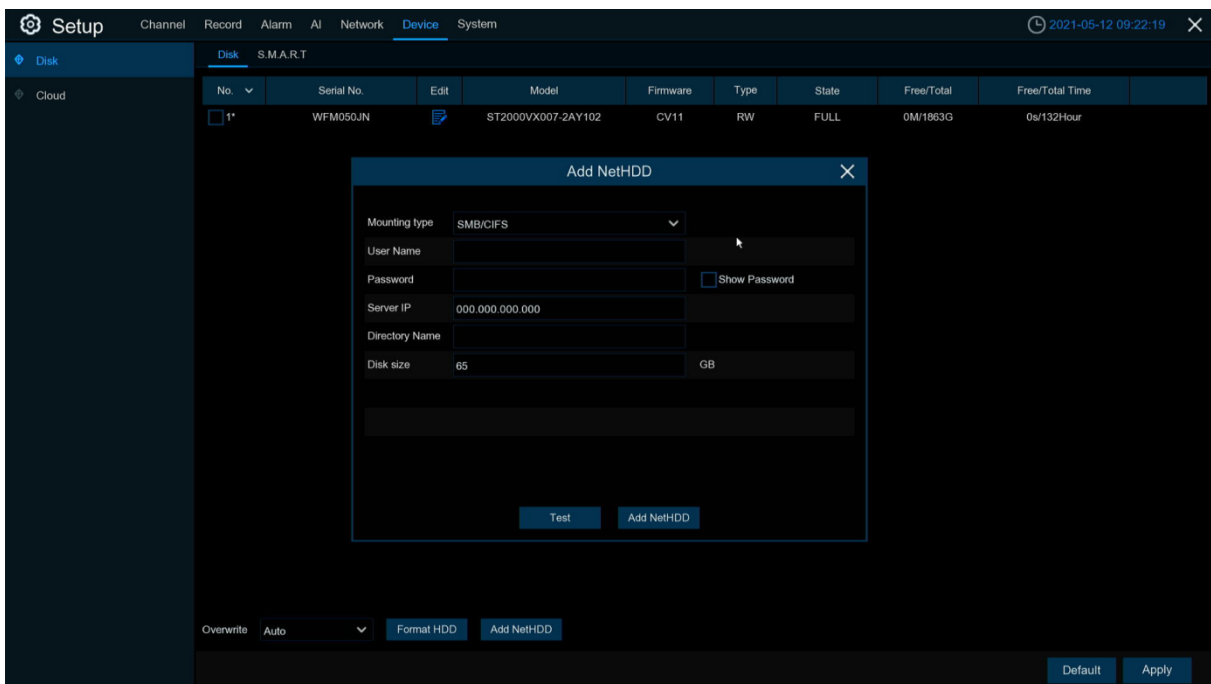
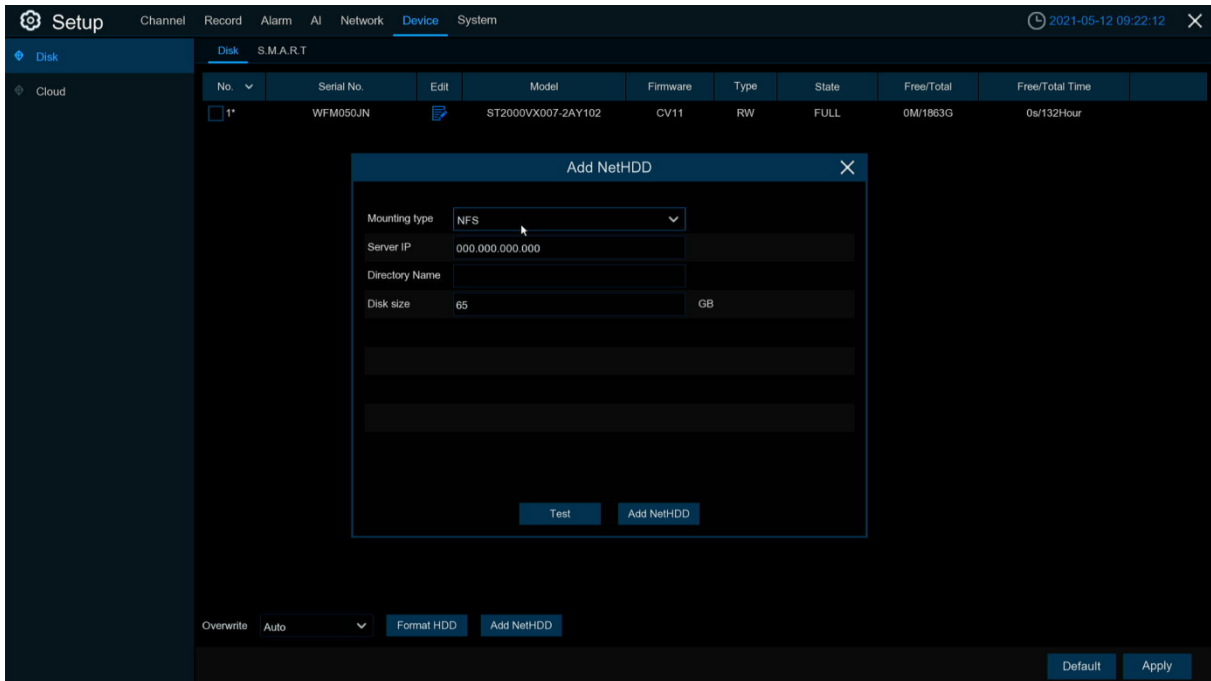

Choose the mounting type, there are two types: **NFS** and **SMB/CIFS**. Enter the NAS server address in the **Server IP** field, the path name in the **Directory Name** field, and the disk size **Disk size**. Under the **CIFS** protocol, you also need to enter the username and password of the NAS. Click **Test** to test whether the network hard disk is connected. Click **Add NetHDD** to add a network hard disk. The network hard disk settings are equivalent to ordinary hard disks.

5.5.1.2 S.M.A.R.T

This function can be used to display technical information on the hard drive installed inside your DVR. You can also perform a test (there are three types available) to evaluate and detect potential drive errors.

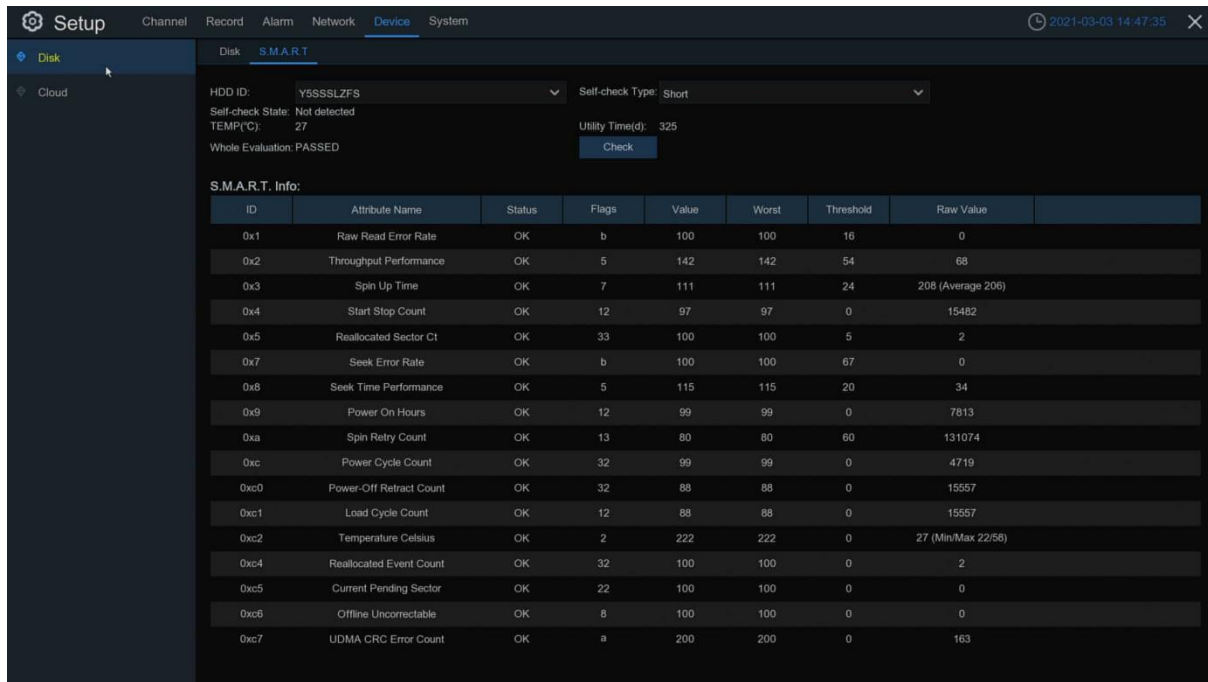

- **Self-check Type:** There are three types available:
 - ⊙ **Short:** This test verifies major components of the hard drive such as read / write heads, electronics and internal memory.
 - ⊙ **Long:** This is a longer test that verifies the above as well as performing a surface scan to reveal problematic areas (if any) and forces bad sector relocation
 - ⊙ **Conveyance:** This is a very quick test that verifies the mechanical parts of the hard drive are working.

Note: When performing the test, your DVR will continue to work normally. If you find a hard disk S.M.A.R.T error, you can continue to use the hard disk, but there is a risk of losing recorded data. It is recommended to replace the hard disk with a new one.

5.5.2 Cloud

Your DVR has the ability to upload snapshots to the cloud service via Dropbox / Google Drive which is a free service that allows you to easily store and share snapshots and always have them on hand when you need them.

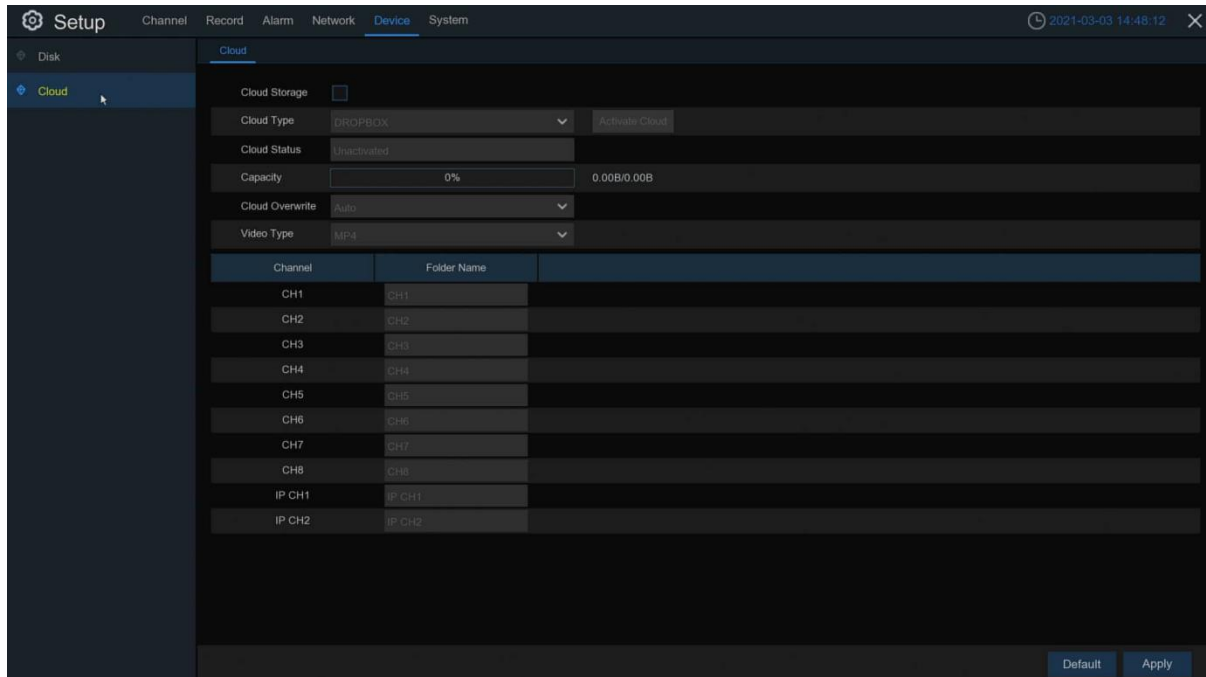

Before activating the cloud function, we recommend that you create a Dropbox account using the same email address and password used for your DVR. Go to www.dropbox.com, input your name, email address and password, agree to the terms & conditions then click the sign up button.

- **Cloud Storage:** Check to enable the function.
- **Cloud Type:** To select cloud type, Dropbox and Google Drive are optional.
- ⊙ **Activate Cloud:** Click to activate the function. After a short moment, you will see a message on-screen. An activation link has been sent to your email (the email address which you have set to receive email alerts in [5.4.3 Email](#)). Check your email and click the link to activate. You will be taken to the Dropbox website. Click “Allow” to finalize the activation. Repeat these steps if you would like to enable cloud storage for the other cameras available.
- **Cloud Status:** To show cloud activation status.
- **Capacity:** To show the remaining space of cloud storage.

5.6 System

Change general system information such as date, time and region, edit passwords and permissions, and more.

5.6.1 General

5.6.1.1 General

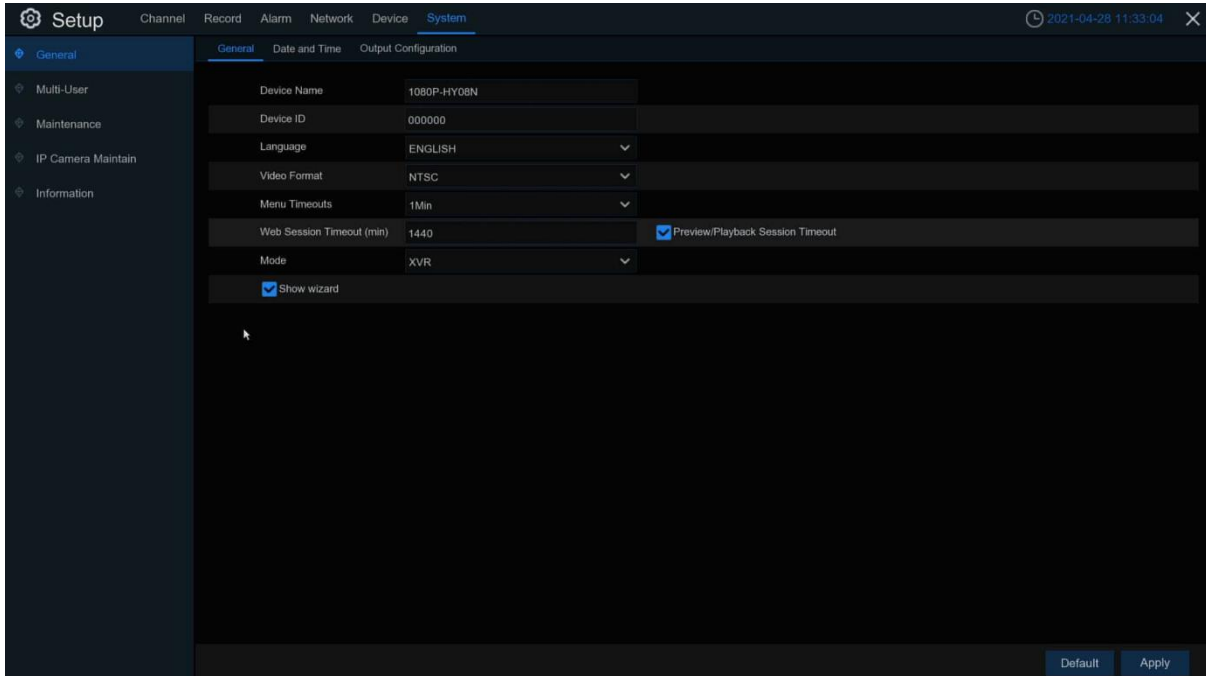

The screenshot shows the 'Setup' interface for a USA Vision DVR. The 'System' tab is selected, and the 'General' section is active. The configuration fields are as follows:

Field	Value	Notes
Device Name	1080P-HY08N	
Device ID	000000	
Language	ENGLISH	Dropdown menu
Video Format	NTSC	Dropdown menu
Menu Timeouts	1Min	Dropdown menu
Web Session Timeout (min)	1440	
Preview/Playback Session Timeout	<input checked="" type="checkbox"/>	Checkbox
Mode	XVR	Dropdown menu
Show wizard	<input checked="" type="checkbox"/>	Checkbox

Buttons for 'Default' and 'Apply' are located at the bottom right of the configuration area.

- **Device Name:** Enter the DVR name. The name can contain letters and numbers.
- **Device ID:** Enter the DVR device ID. The device ID is used to identify the DVR and can only be made up of numbers. For example, two DVRs are installed in the same location, one of which has a device ID of 000000, and the other has a device ID of 111111.
- **Language:** Select the language in which you want to display the system menu. Multiple languages are available.
- **Video Format:** Choose a video format that suits your region.
- **Menu Timeouts:** Click the drop-down menu and select the time to exit the main menu when the DVR is idle. You can also disable this function by selecting off (password protection will be temporarily disabled)
- **Web Session Timeout (min):** Set the time to automatically log out of the web after a period of no operation when using the web side to log in.
- **Preview/Playback Session Timeout:** After enable, in the preview or playback, to avoid automatic logout of the web side.
- **Mode:** XVR or DVR, XVR mode will allow you to add IP cameras to the DVR. If the mode is changed from XVR to DVR, all added IP cameras will be removed.
- **Show wizard:** Check this option if you want to display the startup wizard every time you open or restart a DVR.

5.6.1.2 Date and Time

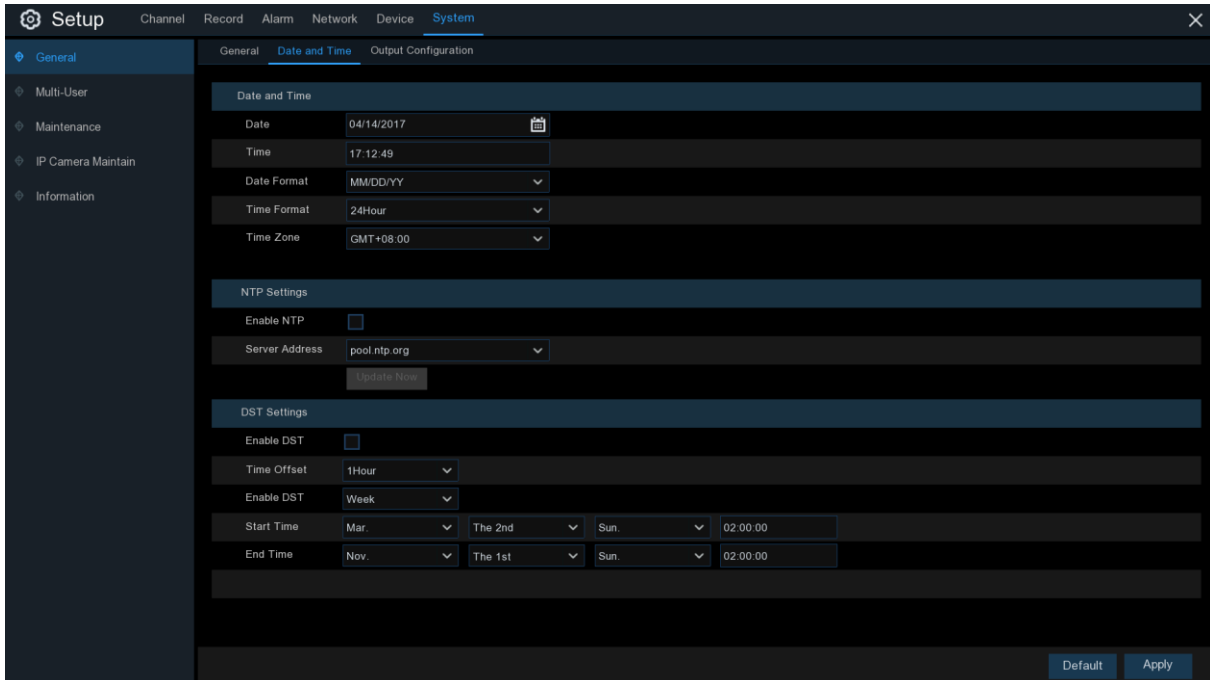

The screenshot shows the 'Setup' interface for 'System' configuration. The 'Date and Time' tab is selected, showing the following settings:

- Date and Time:**
 - Date: 04/14/2017 (with a calendar icon)
 - Time: 17:12:49
 - Date Format: MM/DD/YY
 - Time Format: 24Hour
 - Time Zone: GMT+08:00
- NTP Settings:**
 - Enable NTP:
 - Server Address: pool.ntp.org
 - Update Now button
- DST Settings:**
 - Enable DST:
 - Time Offset: 1Hour
 - Enable DST: Week
 - Start Time: Mar. The 2nd Sun. 02:00:00
 - End Time: Nov. The 1st Sun. 02:00:00

Buttons for 'Default' and 'Apply' are located at the bottom right of the configuration area.

[Date and Time]

- **Date:** Click the calendar to change the date.
- **Time:** Click the time box to change the time.
- **Date Format:** Select the preferred date format.
- **Time Format:** Select the preferred time format.
- **Time Zone:** Select the time zone associated with your region or city.

[NTP Settings]

The NTP (Network Time Protocol) function allows your DVR to automatically sync its clock with a time server. This gives it the ability to constantly have an accurate time setting (your DVR will periodically sync automatically).

Check to enable the NTP and select a **Server Address**, click **Update Now** to manually sync the date & time.

Click **Apply** to save your settings.

When NTP function is enabled, system will update the system time at 00:07:50 per day, or every time when the system is starting up.

[DST Settings]

The DST (Daylight Saving Time) function allows you to select the amount of time that Daylight Saving has increased by in your particular time zone or region.

- **Enable DST:** If Daylight Saving applies to your time zone or region, check this option to enable.
- **Time Offset:** Select the amount of time that Daylight Saving has increased by in your time zone. This refers to the difference in minutes, between Coordinated Universal Time (UTC) and the local time.
- **Enable DST:** You can select how Daylight Saving starts and ends:
 - ⊙ **Week:** Select the month, a particular day and time when Daylight Saving starts and ends. For example, 2 a.m. on the first Sunday of a particular month.
 - ⊙ **Date:** Select the start date (click the calendar icon), end date and time when Daylight Saving starts and ends.
- **Start Time / End Time:** Set the start time and end time for Daylight Saving.

5.6.1.3 Output Configuration

This menu allows you to configure video output parameters. There are two video output methods.

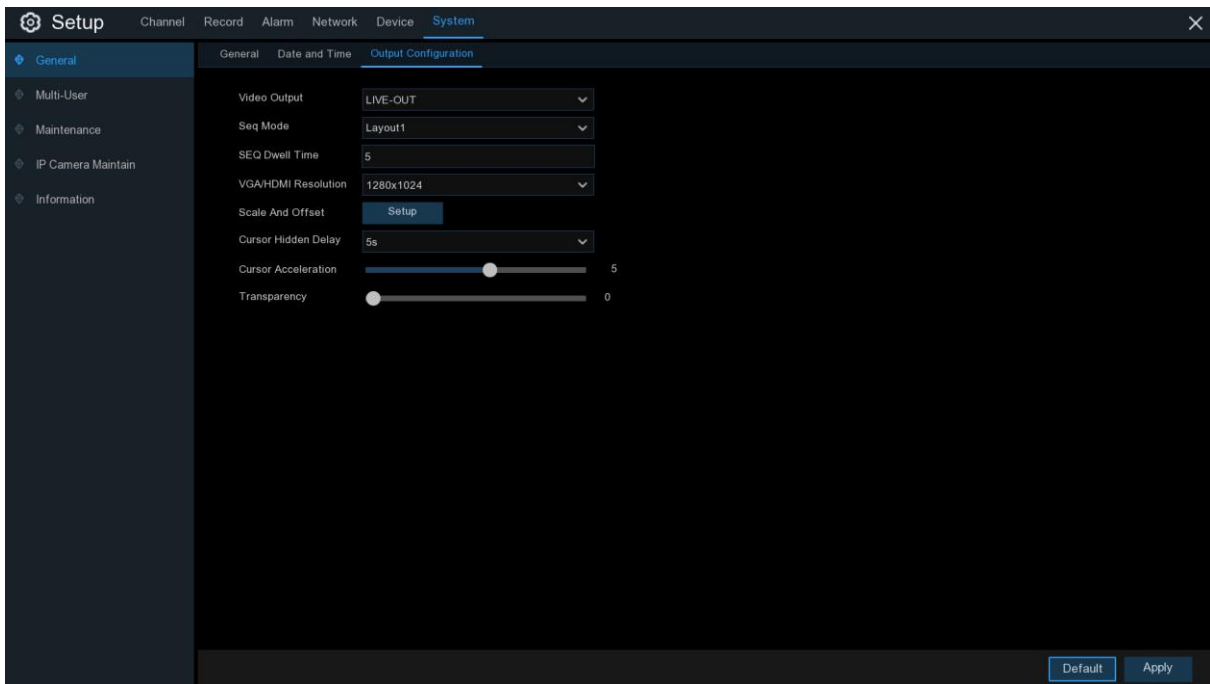

[LIVE-OUT] This is used to configure the main output parameters.

- **Seq Mode:** Select how many video channels you would like to display when your DVR is in sequence mode.
- **SEQ Dwell Time:** Enter in seconds the maximum length of time you would like to display a video channel in sequence mode before displaying the next video channel (300 seconds is the maximum).
- **Output Resolution:** Select a display resolution that is suitable for your TV. 1920 x 1080 will suit most TVs. If your DVR supports 4K output resolution, you can select either 2K (2560 x 1440) or 4K (3840 x 2160) to take advantage of the higher resolution that your 4K TV provides.
- **Scale and Offset:** The DVR supports to adjust the size & position of the display screen to match your monitor or TV. Click **Setup** button to adjust. Click once or long press the left button of your mouse on the arrow to adjust the size and position, or you can scroll the wheel of the mouse to adjust. Click the right button of your mouse to exit, and click **Apply** to save your modifications.
 - ⊙ **Scale:** To adjust the size of the displayed screen by scale.
 - ⊙ **X Offset:** To move the displayed screen to left or right.
 - ⊙ **Y Offset:** To move the displayed screen to up or down.









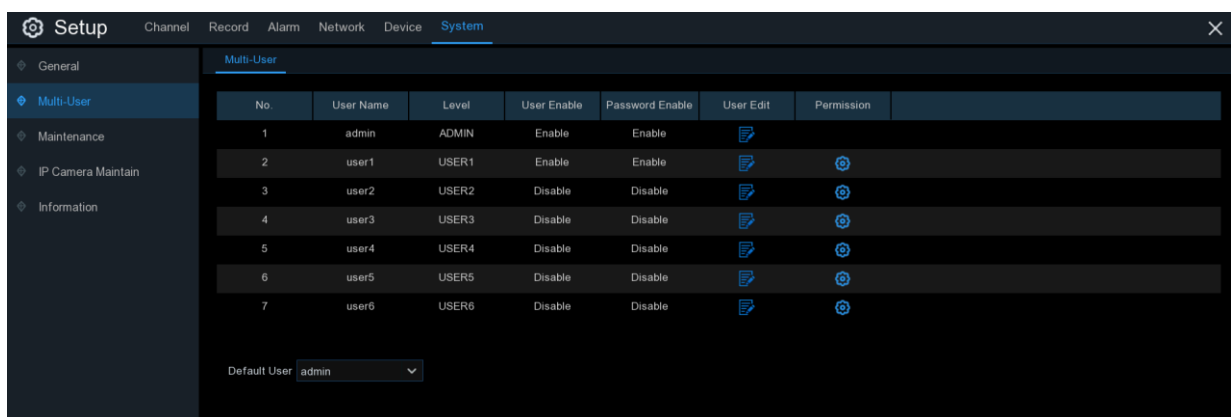



- **Cursor Hidden Delay:** Click the drop-down menu to select the time your DVR will hide the mouse cursor when idle. You can also disable this by selecting **OFF** (password protection will be temporarily disabled).
- **Cursor Acceleration:** To adjust the speed to move the mouse cursor.
- **Transparency:** Click and hold the slider left or right to change how transparent the Menu Bar and Main Menu will appear on-screen. Adjust accordingly.

[SPOT-OUT] You can optionally select this function to configure the VGA spot output parameters.

5.6.2 Multi-User

This menu allows you to configure the user name, password and user permission.



No.	User Name	Level	User Enable	Password Enable	User Edit	Permission
1	admin	ADMIN	Enable	Enable		
2	user1	USER1	Enable	Enable		
3	user2	USER2	Disable	Disable		
4	user3	USER3	Disable	Disable		
5	user4	USER4	Disable	Disable		
6	user5	USER5	Disable	Disable		
7	user6	USER6	Disable	Disable		

Default User:

The system supports the following account types:

- ⊙ **ADMIN** (System Administrator): The administrator has full control of the system, and can change both administrator and user passwords and enable/disable password protection.
- ⊙ **USER** (Normal User): Users only have access to live viewing, search, playback, and other functions. You may set up multiple user accounts with varying levels of access to the system.

[Changing password]

To change the password for the administrator or user accounts, click the **User Edit** icon . The password has to be a minimum of 8 characters and can contain a mixture of numbers and letters. Enter your new password again to confirm, and then click **Save** to save your new password. You will be required to input your old password to authenticate.

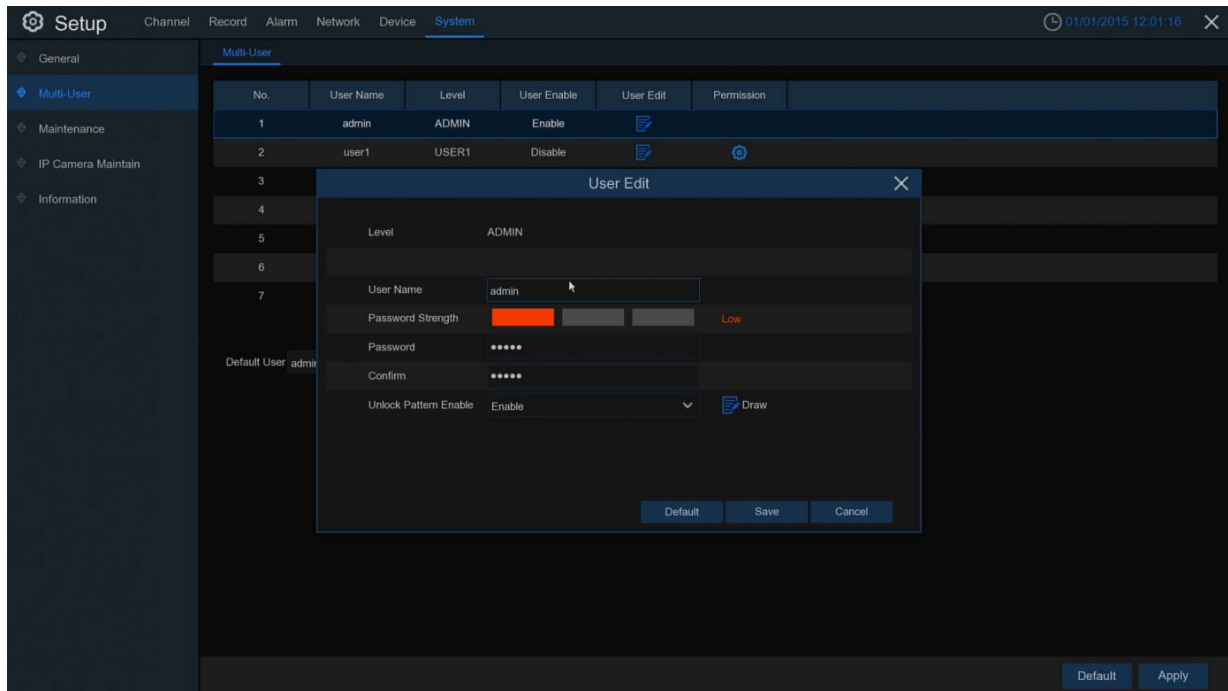



[Adding new users]

1. Select one of the user accounts that is currently disabled, click the **User Edit** icon .
2. Select **Enable** from the drop-down list of **User Enable**.
3. Click the field next to **User Name** to change the user name for the account.
4. Select **Enable** from the drop-down list of **User Enable**.
5. Click the field of **Password** to enter the desired password.
6. Click the field of **Confirm** to re-enter the password.
7. Click **Save**. You will be required to input your Admin password to authenticate.

[Setting user permissions]

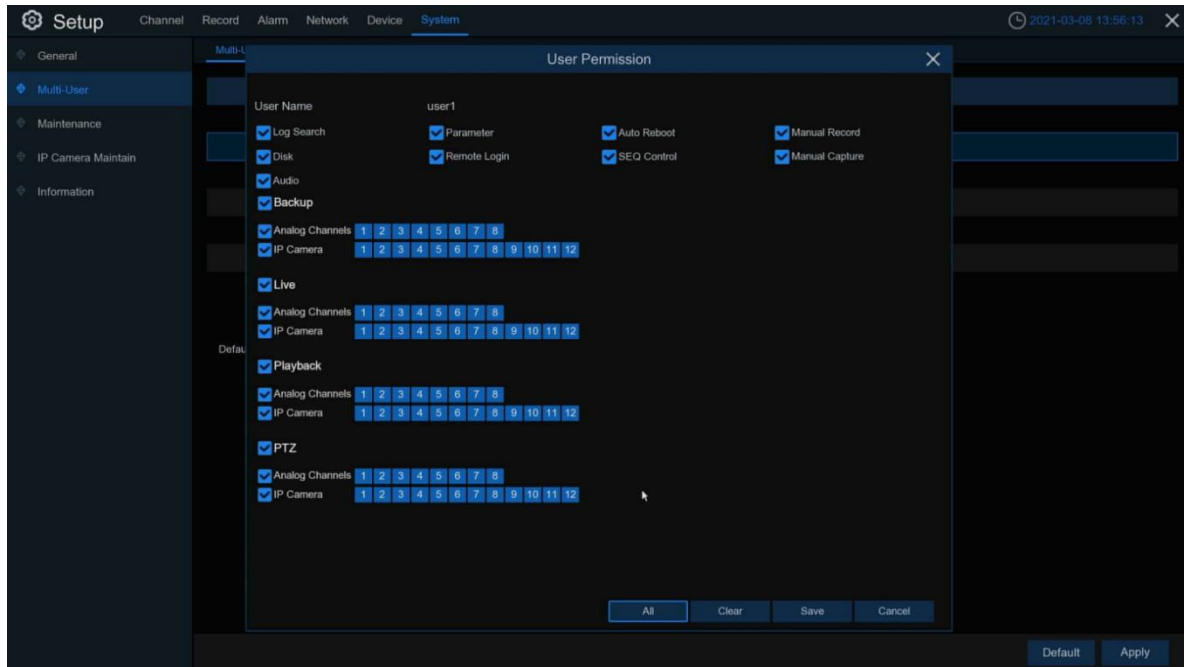
The administrator account is the only account that has full control of all system functions. You can enable or disable access to certain menus and functions of each user account.



1. Click the edit icon  under Permission tab.
2. Check the boxes next to any system menus or capabilities you would like the user to access. Click **All** to check all boxes. Click **Clear** to check none of the boxes.
3. Click **Save** to save your modifications.

5.6.3 Maintenance

In this section, you will be able to search and view the system log, load default settings, upgrade the system, export and import system parameters, manager system auto reboot and perform relevant configurations.

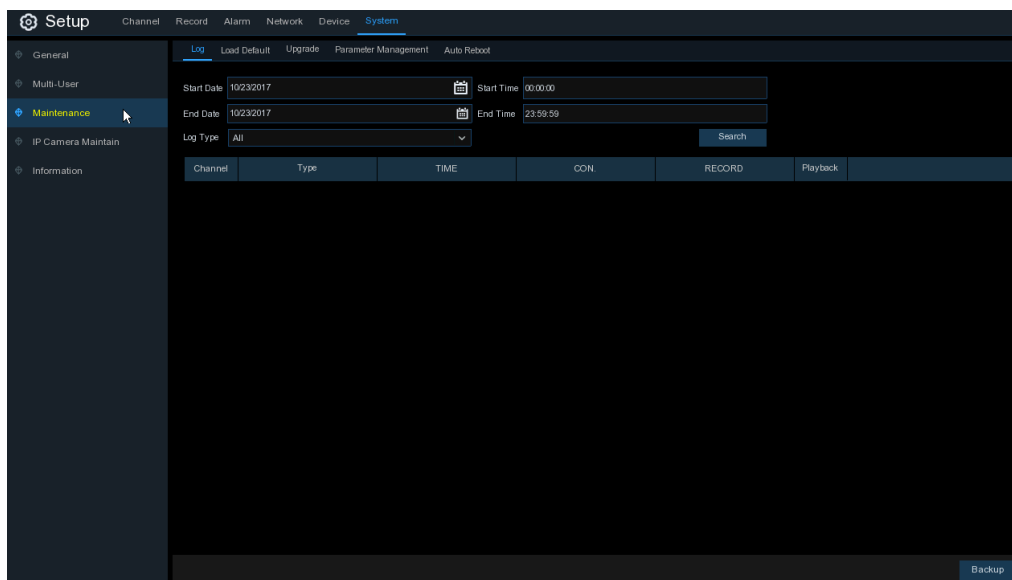

5.6.3.1 Log

The system log shows you important system events, such as motion alarms and system warnings. You can easily create a backup file of the system log for a set time period to a USB flash drive.

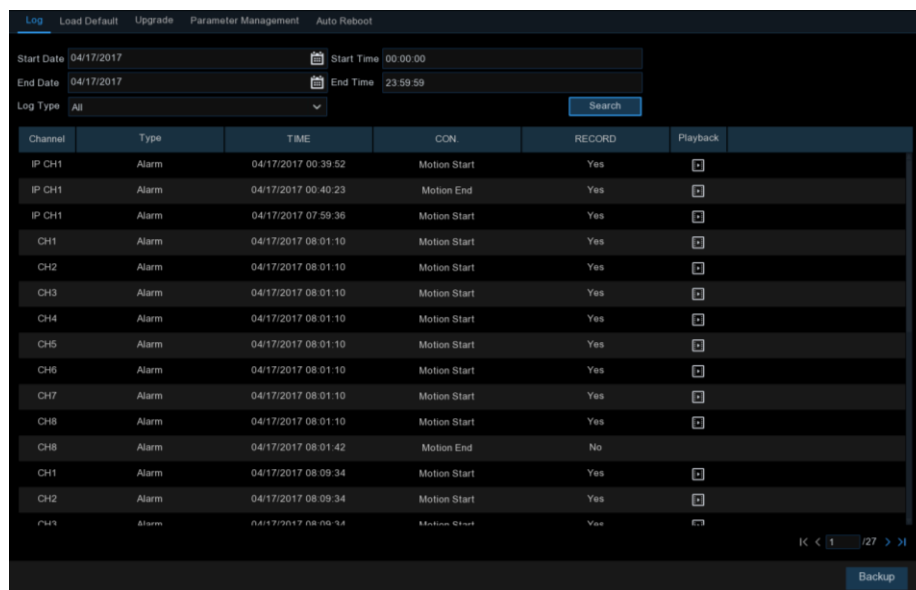

[Log searching and backing up]

1. Click the fields of **Start Date / Start Time** to choose the starting date / time for your search from the on-screen calendar.
2. Click the fields of **End Date / End Time** to choose the end date / time for your search from the on-screen calendar.
3. Select the type of events you would like to search for from the drop-down list of **Log Type**, or select **All** to see the entire system log for the selected time period.
4. Click **Search**.
5. Browse system log events from your search period:
 - ⊙ Video events can be played back instantly by clicking in the **Playback** column. Right-click to return to your search results.
 - ⊙ Use the **◀ / ▶** buttons in the bottom-right corner of the menu to move between pages of system log events.
6. Click **Backup** to create a backup of the system log for your search period. Make sure your flash drive has been connected to the DVR's USB port.
7. The backup drive menu appears. Navigate to the folder you want the backup file to be saved in, then click **OK** to begin.

5.6.3.2 Load Default

Reset the DVR settings to its out-of-box state. You can choose to reset all settings at once, or just settings on specific menus. Restoring default settings will not delete recordings and snapshots saved to the hard drive.

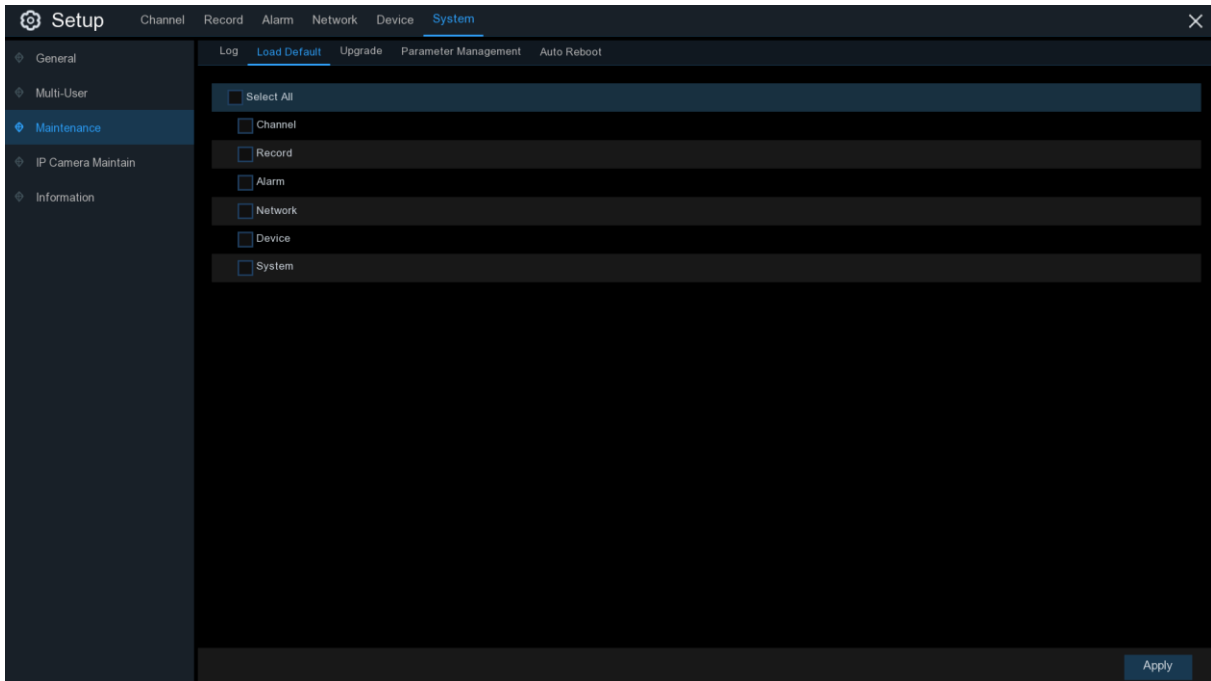

Check the items you want restore, or check **Select All** to choose all items. Click **Apply** to load default settings of your chosen items.

5.6.3.3 Reset Settings

Check **Load Default** or **Format HDD** to restore the selected item.

5.6.3.4 Upgrade

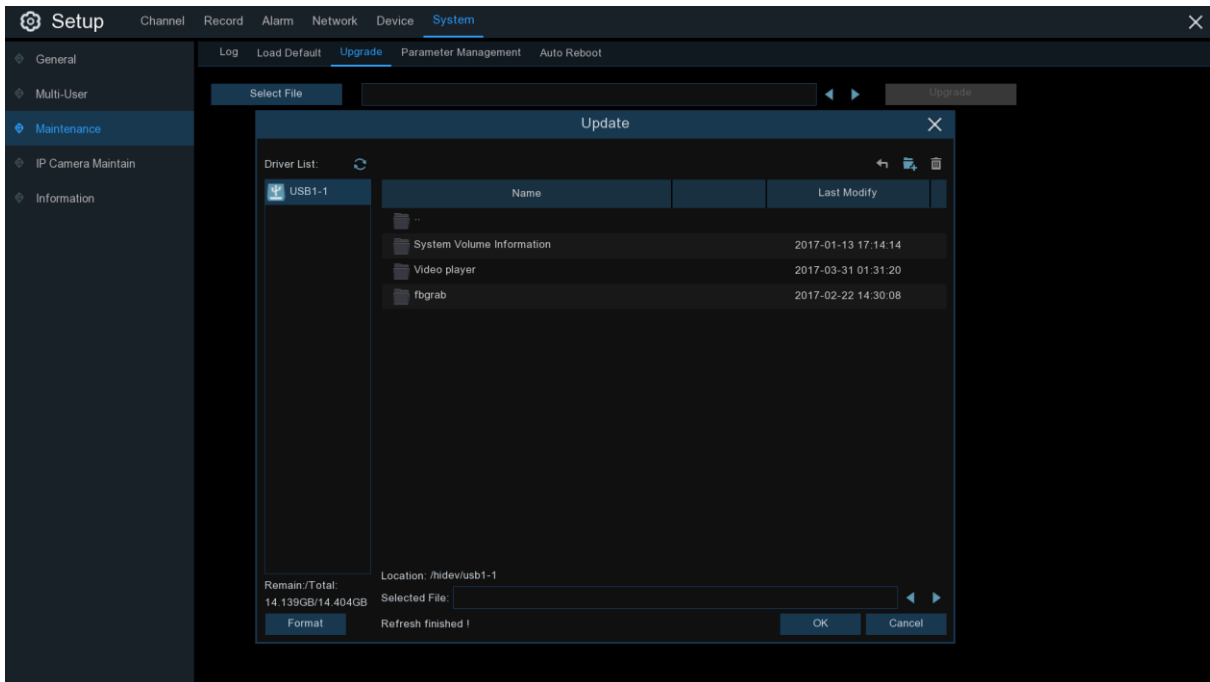

1. Copy the firmware file (.sw file) to your USB drive, and insert the USB flash drive into the DVR's USB port.
2. Click **Select File** button to choose the firmware file in your USB flash drive, then Click **OK**.
3. Click **Upgrade** button to start system upgrade. The system upgrade will last around 5-10 minutes, please do NOT power off the DVR or remove the USB from DVR during firmware upgrade.

Note: You can optionally upgrade the firmware using **UVS Device Utility**. Refer to *Chapter 5 Upgrading Firmware* in *UA-XVL XVR Quick Start Guide* for details.

5.6.3.4 Parameter Management

You can export the main menu settings you have configured to a USB flash drive, or import an exported setting file from USB flash drive to the DVR.

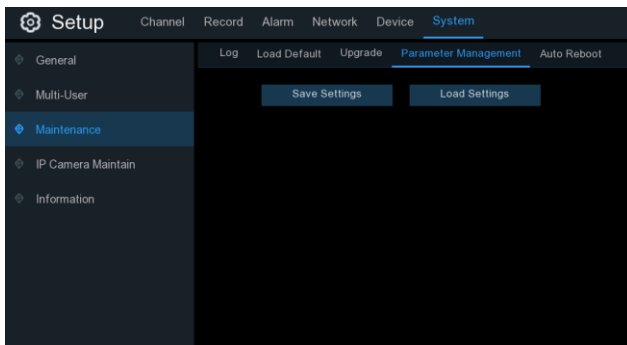

- **Save Settings:** Click to save the DVR current system settings to the USB device. You will be required to input the Admin password to authenticate.
- **Load Settings:** Once you have created a system settings export, you can import the settings on another DVR. Click **Load Settings** button to navigate to the system settings file you want to import from your USB flash driver. You will be required to input the Admin password to authenticate.

5.6.3.5 Auto Reboot

This menu allows the system to auto reboot the DVR regularly. It is recommended to leave this function enabled, as it maintains the operational integrity of your DVR.

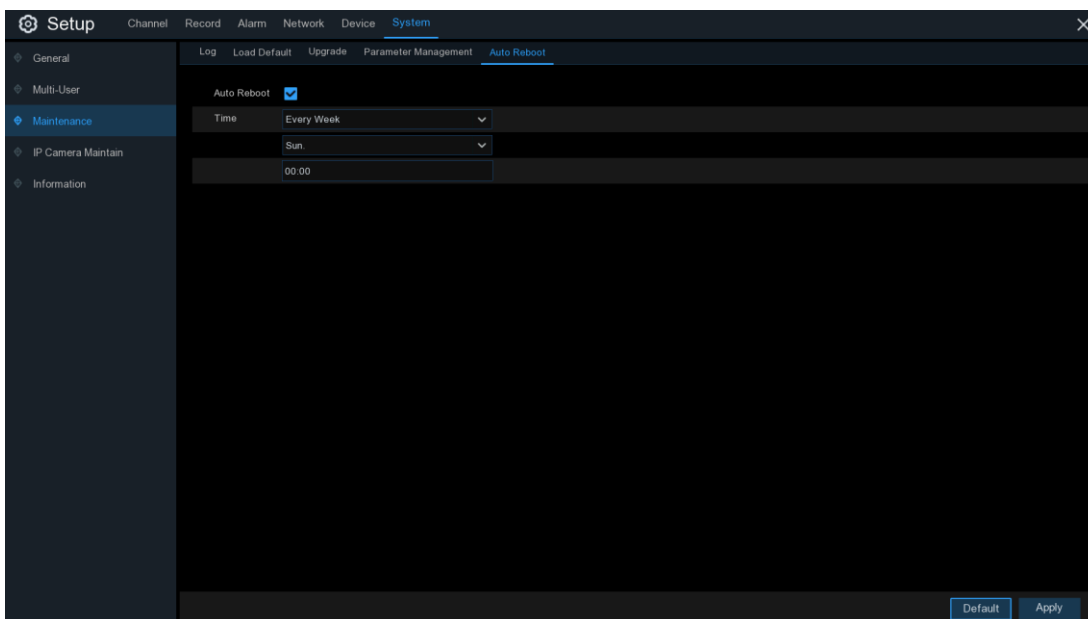

- **Auto Reboot:** Check to enable.
- **Time:** You can set the DVR to reboot by day, week or month.

5.6.3.6 Developer Mode

This menu can save the serial port log to the USB flash disk.

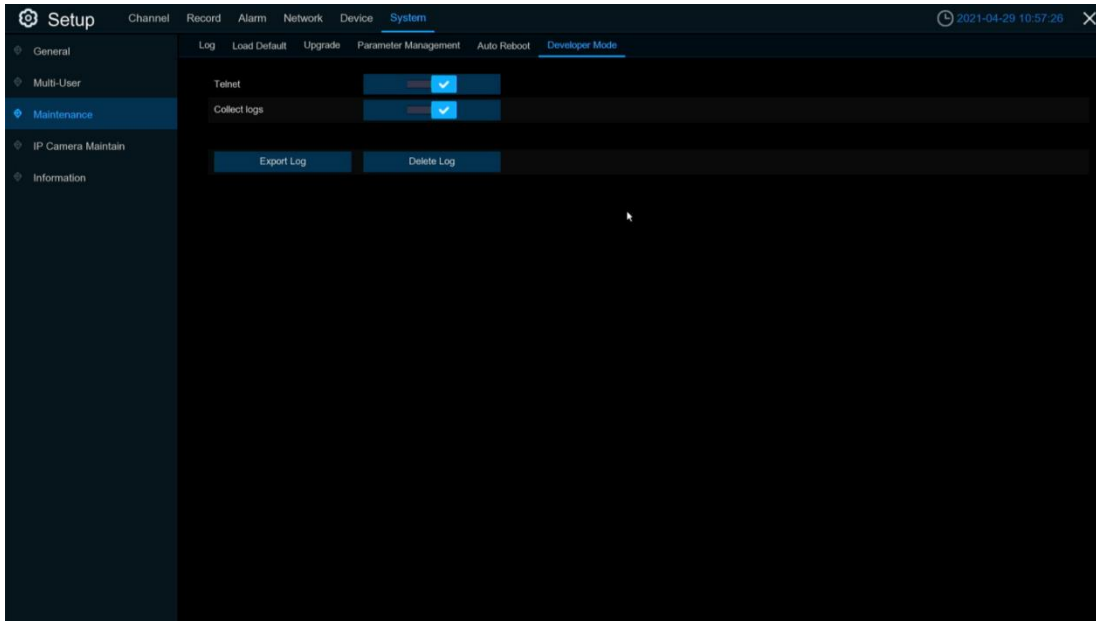

- **Telnet:** Enable it to use Telnet to login device.
- **Collect logs:** Enable it to collect logs.
- **Export Log:** Export logs to the USB flash drive.
- **Delete Log:** Delete all collected logs.

5.6.4 IP Camera Maintain

This menu allows you to upgrade the IP camera's firmware and restore default settings.

5.6.4.1 Upgrade

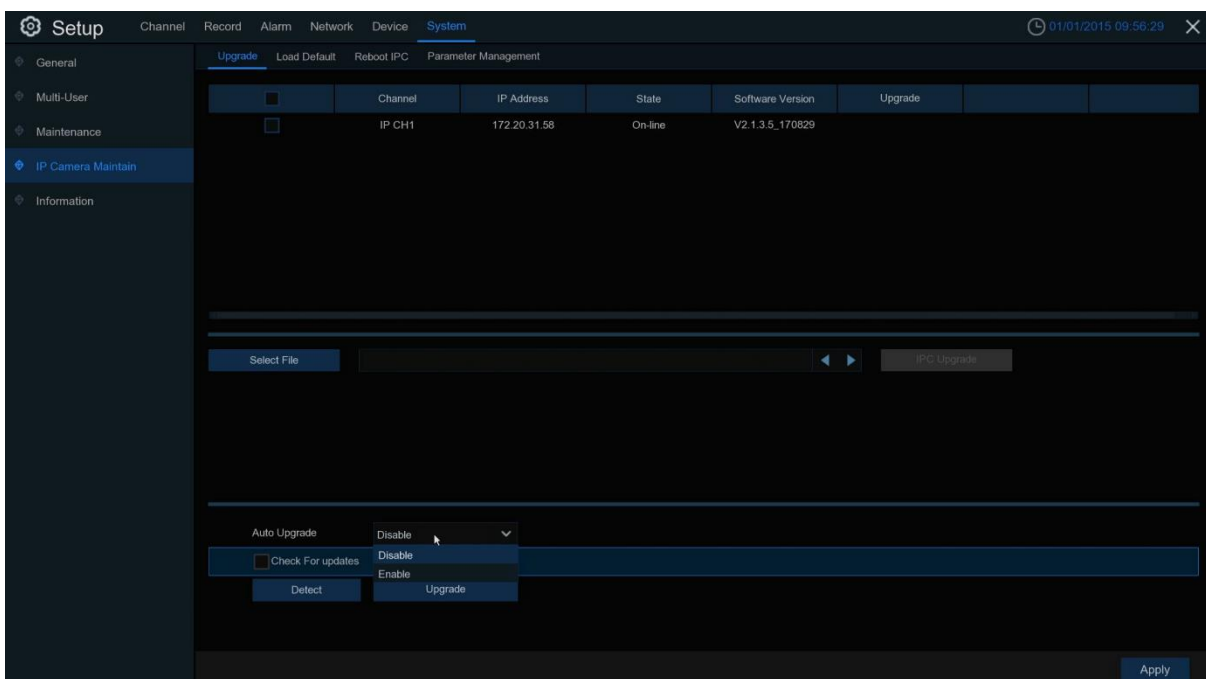

1. Choose one of the IP camera you want to upgrade firmware.
2. Click **Select File** to select the update file from your USB flash drive, then click **OK**.
3. Click **IPC Upgrade** button to start upgrading. You will be required to input the Admin password to authenticate. Please do NOT power off the DVR and IP camera or remove the USB during the upgrading.
 - **Auto Upgrade:** Some IPC supports upgrading using the upgrade package in FTP. You only need to open FTP in the IE menu of IPC. Then upload the upgrade package to upgrade IPC FTP on DVR. Select **Enable / Disable** to enable or disable the feature.
 - **Check For update:** Enable this function to Automatically detect upgrades. Check whether there is the latest upgrade package in the FTP server at regular intervals and when starting up. If yes, you will be prompted whether to upgrade.
 - **Detect:** Manually check for the latest upgrade package.
 - **Upgrade:** If the latest upgrade package is detected, click to upgrade.

5.6.4.2 Load Default

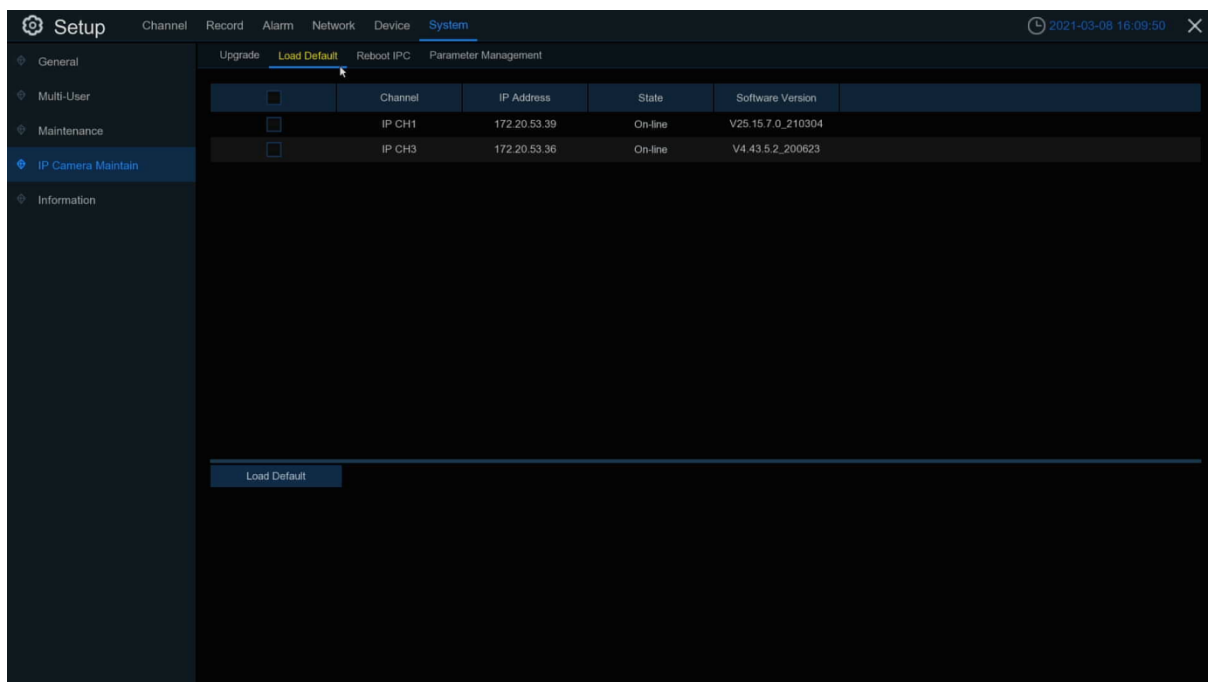

1. Choose the IP cameras you want to restore.
2. Click **Load Default** to restore settings. You will be required to input the Admin password to authenticate.

5.6.4.3 Reboot IPC

You can restart IPC in this menu. Check IPC and click **Reboot IPC**.

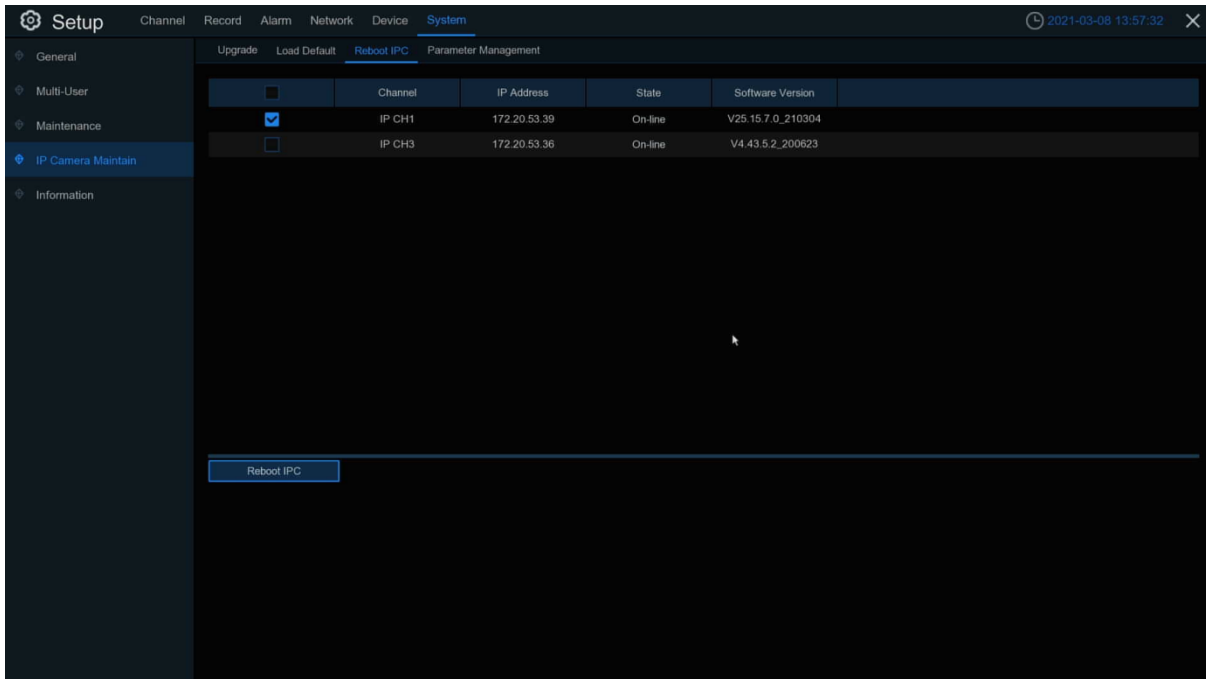

5.6.4.4 Parameter Management

This menu allows you to import / export IPC parameters.

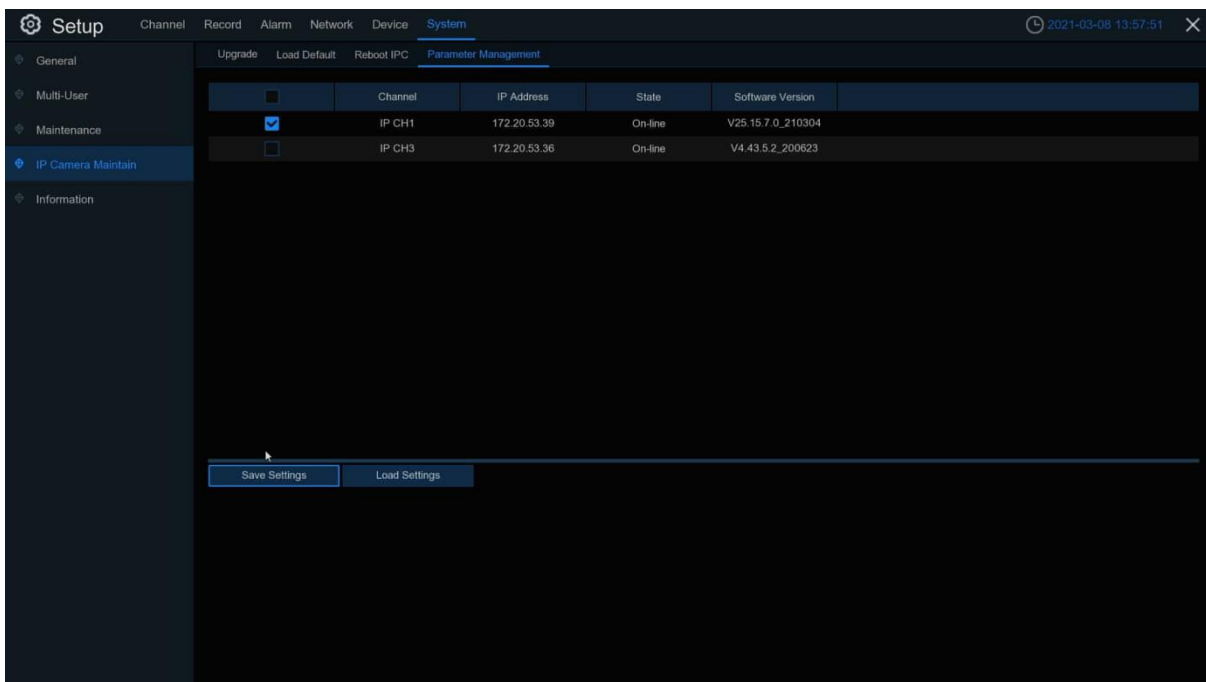

1. To export parameters, check **IPC**, click **Save Settings**, and the USB flash disk path will pop up.
2. After selecting the path, click **OK** to export IPC to USB flash disk.
3. Optionally check **IPC** and click **Load Settings** to import parameter files from USB flash disk into the IPC.

5.6.5 Information

This menu allows you to view the system information, channel information, record information, network status, and other relevant information.

5.6.5.1 Information

View system information such as device ID, device name, IP address, MAC address, firmware version and more.

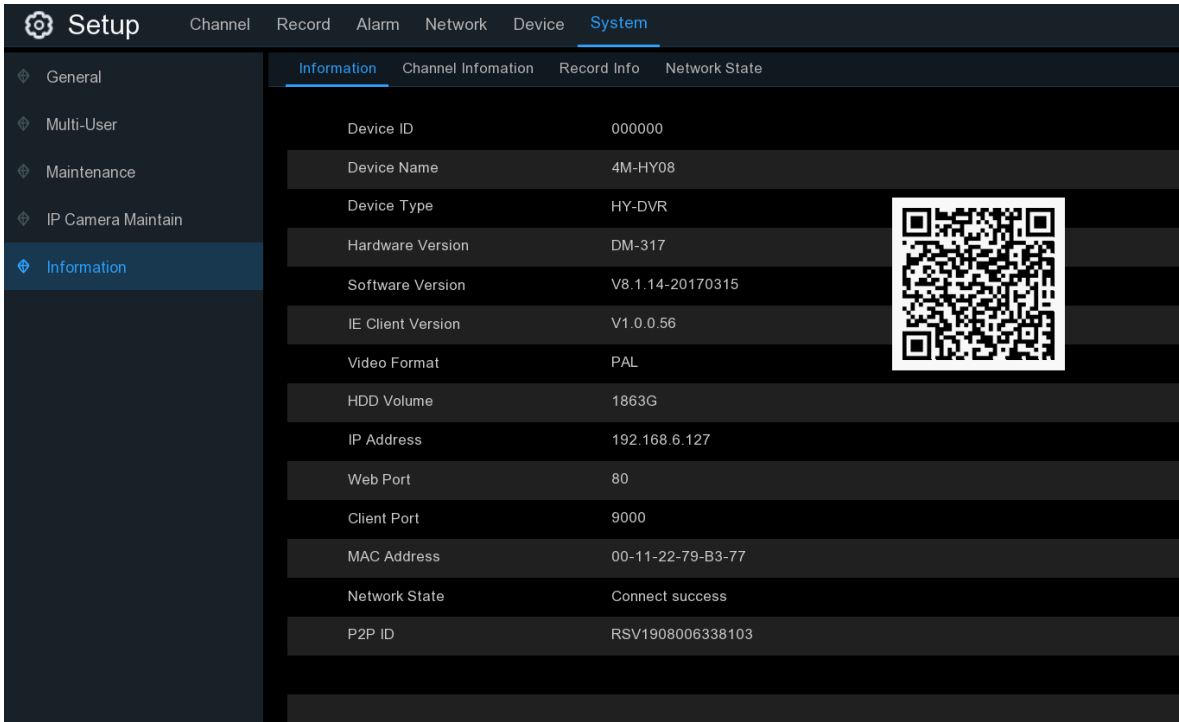

The screenshot shows the 'Setup' menu with 'System' selected. Under 'System', the 'Information' tab is active, displaying the following system information:

Parameter	Value
Device ID	000000
Device Name	4M-HY08
Device Type	HY-DVR
Hardware Version	DM-317
Software Version	V8.1.14-20170315
IE Client Version	V1.0.0.56
Video Format	PAL
HDD Volume	1863G
IP Address	192.168.6.127
Web Port	80
Client Port	9000
MAC Address	00-11-22-79-B3-77
Network State	Connect success
P2P ID	RSV1908006338103

A QR code is displayed on the right side of the information page, which can be scanned to remotely view the DVR.

If your DVR supports P2P function, you will find the P2P ID and QR code on the information page. You can scan this QR cord with mobile app to remotely view the DVR.

5.6.5.2 Channel Information

Information <u>Channel Information</u> Record Info Network State							
Channel	Alias	State	Mainstream	Substream	Motion Detection	Privacy Zone	
CH17	CH17	On-line	704x 480, 30Fps, 32Kbps	704x 480, 0Fps, 8Kbps	Support	Support	
CH18	CH18	On-line	704x 480, 30Fps, 32Kbps	704x 480, 0Fps, 8Kbps	Support	Support	
CH19	CH19	On-line	704x 480, 30Fps, 32Kbps	704x 480, 0Fps, 8Kbps	Support	Support	
CH20	CH20	On-line	704x 480, 30Fps, 32Kbps	704x 480, 0Fps, 8Kbps	Support	Support	
CH21	CH21	On-line	704x 480, 30Fps, 32Kbps	704x 480, 0Fps, 8Kbps	Support	Support	
CH22	CH22	On-line	704x 480, 30Fps, 32Kbps	704x 480, 0Fps, 8Kbps	Support	Support	

View channel information for each connected camera such as alias, mainstream and sub-stream recording specifications, motion detection status, and privacy zone.

5.6.5.3 Record Information

Information Channel Information <u>Record Info</u> Network State							
Channel	Record State	Record Switch	Stream Type	Resolution	FPS	Bitrate	
CH17	OFF	Enable					
CH18	OFF	Enable					
CH19	OFF	Enable					

View recording information for each connected camera such as bitrate, stream type, recording resolution, and frame rate (FPS).

5.6.5.4 Network State

Information		Channel Information	Record Info	Network State
Attribute	Value			
WLAN				
IP Address	192.168.1.100			
Subnet Mask	255.255.255.0			
Gateway	192.168.1.1			
MAC Address	88-72-29-86-A3-23			
DHCP	Enable			
Internal Interface	Connected			
IP Address	10.10.25.100			
Subnet Mask	255.255.0.0			
DNS1	192.168.1.1			
DNS2	8.8.8.8			
PPPoE	Disable			
Port				
Web Port	80			
Client Port	9000			
RTSP Port	554			
UPNP	Disable			
Total Band Width:	320Mbps			
Used Band Width:	5.013Mbps			

- **Total Band Width:** It shows the DVR's total input band width for IP cameras.
- **Used Band Width:** It shows the used band width of IP cameras.

5.6.5.5 Privacy Policy

This tab displays the information on the company's privacy policy and general personal data protection policy.

5.6.5.6 About

This tab displays the information on the company's legal notices and open software licenses.

Chapter 6 Search, Playback, and Backup

The **Search** function allows you to search for and play previously recorded videos as well as snapshots that are stored on your DVR's hard drive. You have the choice of playing video that matches your recording schedule, manual recordings or motion events only. The Backup function allows you to save important events (both video and snapshots) to a USB flash drive.

6.1 Using Search Function

Click Search button in the **Start Menu** to enter search section.



1. **Search Options:** The system provides various search and playback methods: General, Events, Sub-periods, Smart, Tag, External File, Picture, and Slice.
2. **Search Date:** Search by a date to play back.
3. **Search Type:** The system provides different search types to narrow your search.
4. **Channel Selection:** To choose the channels you want to search and play.
5. **Video Playback Controls:** To control the video playback.



Enlarge the video playback to full screen

Rewind, x2, x4, x8 and x16

Slow Play, 1/2, 1/4 and 1/8, 1/16 speed

 Play

 Pause

 Play frame by frame. Click once to play a frame of the video

 Stop



 Fast Forward, x2, x4, x8 and x16

 Digital Zoom: Click to zoom in then click-and-drag on a camera image during playback to zoom in on the selected area. Right-click to return to regular playback.

 Video Clip. Quickly save a section of video to a USB flash drive. Refer to *6.1.1.1 Video Clip Backup* for details.

 Save Video Clip.

 Volume Control: scroll the slider bar to increase or decrease volume.

 Snapshots: to capture a snapshot image to your USB flash drive. If the video playback is in split-screen view, move the mouse cursor to the channel you want to capture, and then click the  icon to save the snapshot.

 Add default bookmark

 Add custom bookmarks

6. **Timeline:** Continuous recordings are shown with colored bars to represent different types of recording (legend shown in the bottom-right corner of the display). Use the timeframe options

() to view a smaller or larger time period.

Different types of recording shown in different colors:



Continuous Recording in **Green**;

Motion Recording in **Yellow**;

I/O Recording in **Red**;

PIR Recording in **Purple**;

Intelligent Recording in **Blue**;

Motion & I/O Recording in **Orange** color;





Manual Recording in **Green**.

7. **Playback Status:** Display the video play status.

6.1.1 Search and Play Video in General

This menu allows you to search and play recording for a selected date.





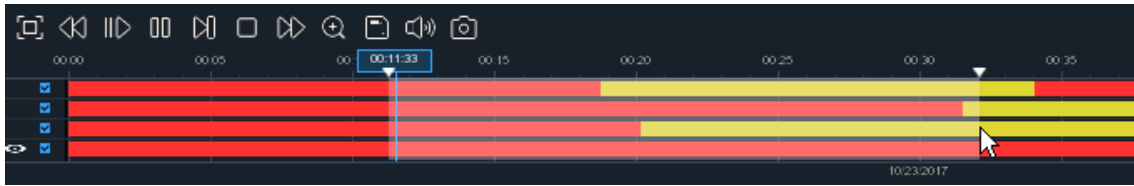

1. Select a date to search for video recording from the calendar.
2. Choose a search type.
3. Check channels you would like to search, or check **Channel** to search all connected channels.
4. The search result will be displayed on the timeline from 00:00 to 24:00.
5. Click  button to start playback.
6. Control the playback with buttons on **Video Playback Controls**.
7. Use the timeframe options (   ) to view a smaller or larger time period.
8. If you want to quickly save a section of video during playing back to a USB flash drive, use the

 **Video Clip** backup function.

6.1.1.1 Video Clip Backup



1. Insert your USB flash drive to the DVR.
2. Start a video recording playback.
3. Click  icon.
4. Check the channel(s) you want to make a video clip backup.
5. Move the mouse cursor to the timeline where you want to start the video clip.
6. Press and hold the left button of your mouse, and drag the cursor to the timeline where you want to end the video clip.
7. The  icon has been changed to  icon, click  to save the video clip. Select a file type for your backup files, click **Save** button to save the video clips. Please make sure your USB driver has enough space to save the video clips.

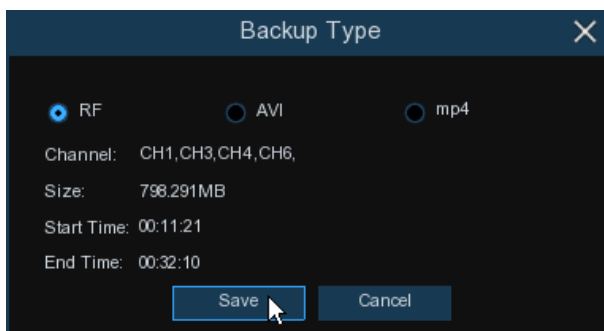

Note: The **RF** format is for internal use only. Select **AVI** or **mp4** format when saving the video clips.

8. The backup drive menu appears. Navigate to the folder you want the backup files to be saved in.
9. Click **OK** to begin. The progress bar at the bottom of the window shows you the progress of the backup.

6.1.2 Event Search, Playback, and Backup

Event search allows you to view a list of video recordings with the channel, start and end time, and recording type conveniently summarized. You can also quickly back up events to a USB flash drive.



To search, play, and back up for events:

1. Choose the date and time you want to search.
2. Check the recording types you want to search, or check **Search Type** to choose all.
3. Choose the channels you want to search, or check **Channel** to choose all channels.
4. Click icon to start search.
5. Events fitting your search criteria are displayed in list form. You can double click the left button of your mouse upon one of the events to play the video immediately.
6. Click icons in the bottom-right corner of the menu to browse between pages of events, or input the page you want to browse.
7. You can switch the view of list form by clicking the icons shown at the lower right bottom corner of the screen:

Thumbnails. You can view the snapshots of the events.

List. The events will be displayed in list.

Detailed. You can view the details of the events.

In the **Detailed** view mode, you can lock the video events to keep events from being overwritten in the hard drive. Click the icon to lock or to unlock the events.

8. When you click the left button of your mouse upon one of the events, the system will show the event information at the left bottom corner of the screen.
9. Check the box next to the number of the events to select files, or check the box next to **Select** to select all events on the page.
10. The number of files selected and the total size will be displayed at the bottom right corner of the screen.
11. After selecting files, you can click icon to save the video to USB flash drive. Or click icon to enter event playback control window to play the video.

6.1.2.1 Event Playback Control

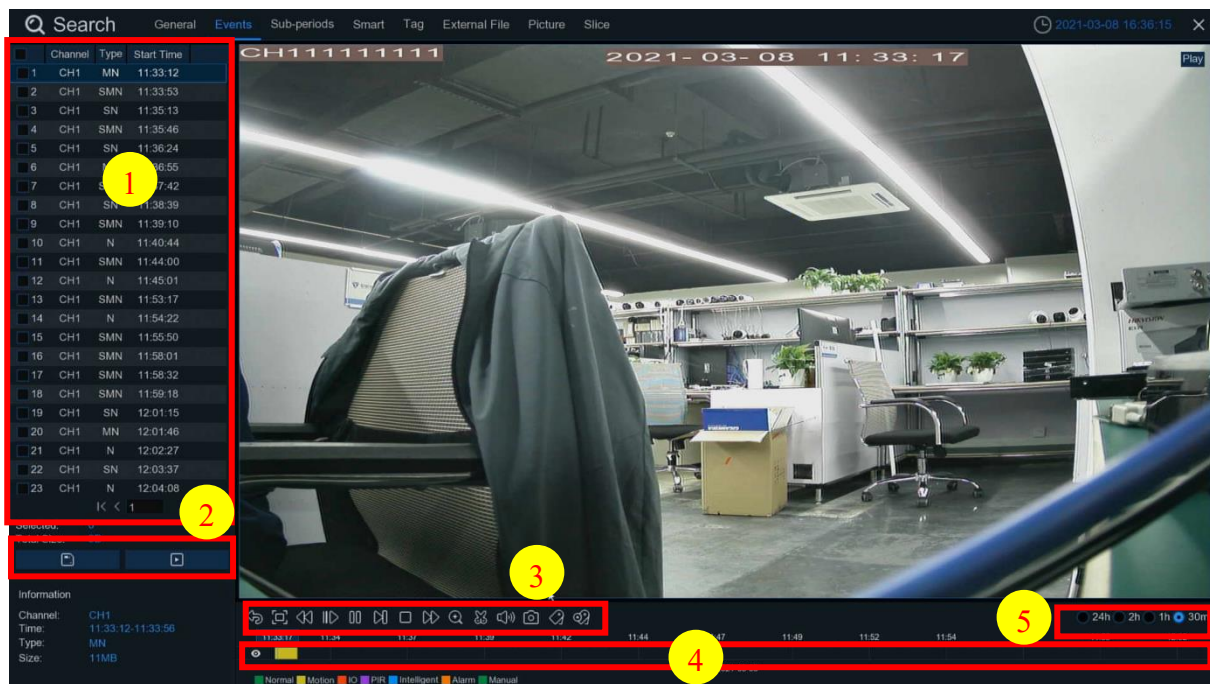

1. On the event list, you can select the events here.
2. Click icon to save your selected event videos to USB flash drive. Click icon to play video.
3. Control the playback with buttons on **Video Playback Controls**. You can click icon or click right button of your mouse to exit the playback and return to event search window.
4. The event you are playing now will be displayed on the timeline.
5. Use the timeframe options () to view a smaller or larger time period.

6.1.3 Sub-periods Playback

Sub-periods playback allows you to play multiple normal recordings and motion events simultaneously from a single channel. With normal and event recordings, the video is divided evenly depending on the split-screen mode that has been selected. For example, if the video is one-hour long and you have selected 4 under **Split-screens**, each split-screen will play for 15 minutes.

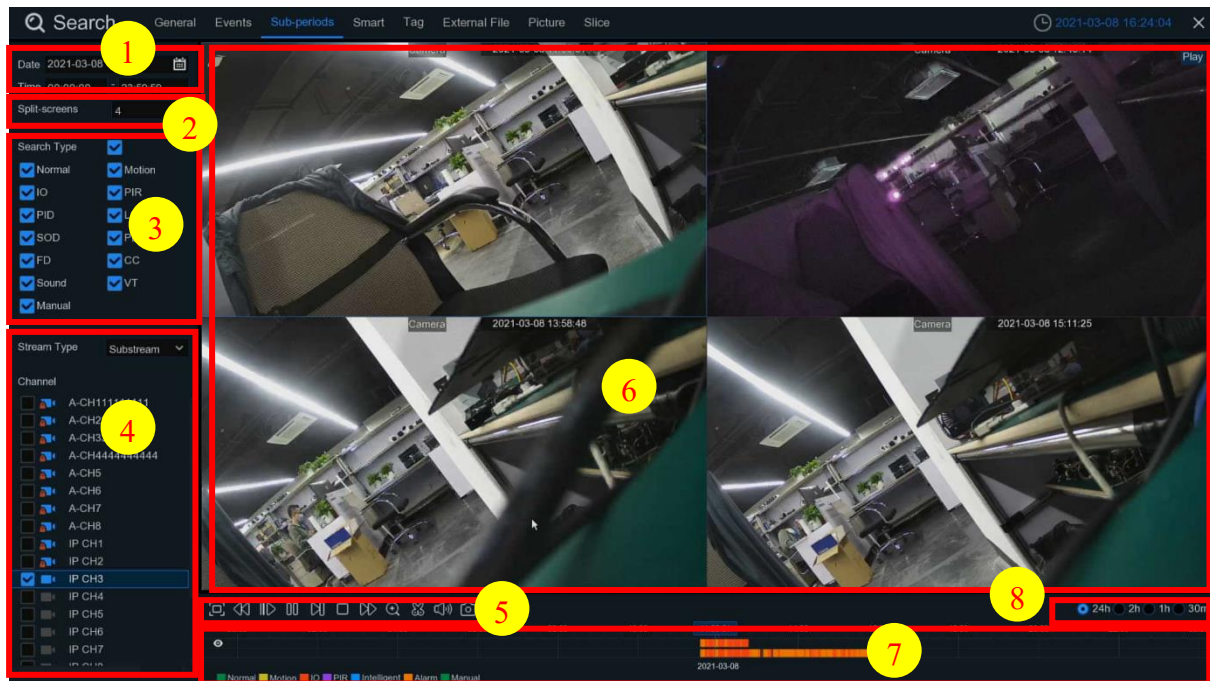

To search and play videos in sub-periods:

1. Choose the date and time you want to search.
2. Choose the split-screens you want the videos to be played in.
3. Check the recording types you want to search, or check **Search Type** to choose all.
4. Choose the channels you want to search. Please note that this function only supports to search and play one channel at a time.
5. Click the play button to start playing. Control the playback with buttons on **Video Playback Controls**.
6. Videos are being played in split-screens.
7. Click the left button of your mouse upon a particular split-screen, the time period of the video split-screen will be displayed on the timeline. The color bar on the top of the timeline indicates the time span of the video split-screen you have clicked. The color bar on the bottom of the timeline indicates the time span for the whole videos you have searched.



- Use the timeframe options (24h 2h 1h 30m) to view a smaller or larger time period.

6.1.4 Smart Search and Playback

Smart mode allows you to easily search and play the motion events in one or more specific areas of the channel.

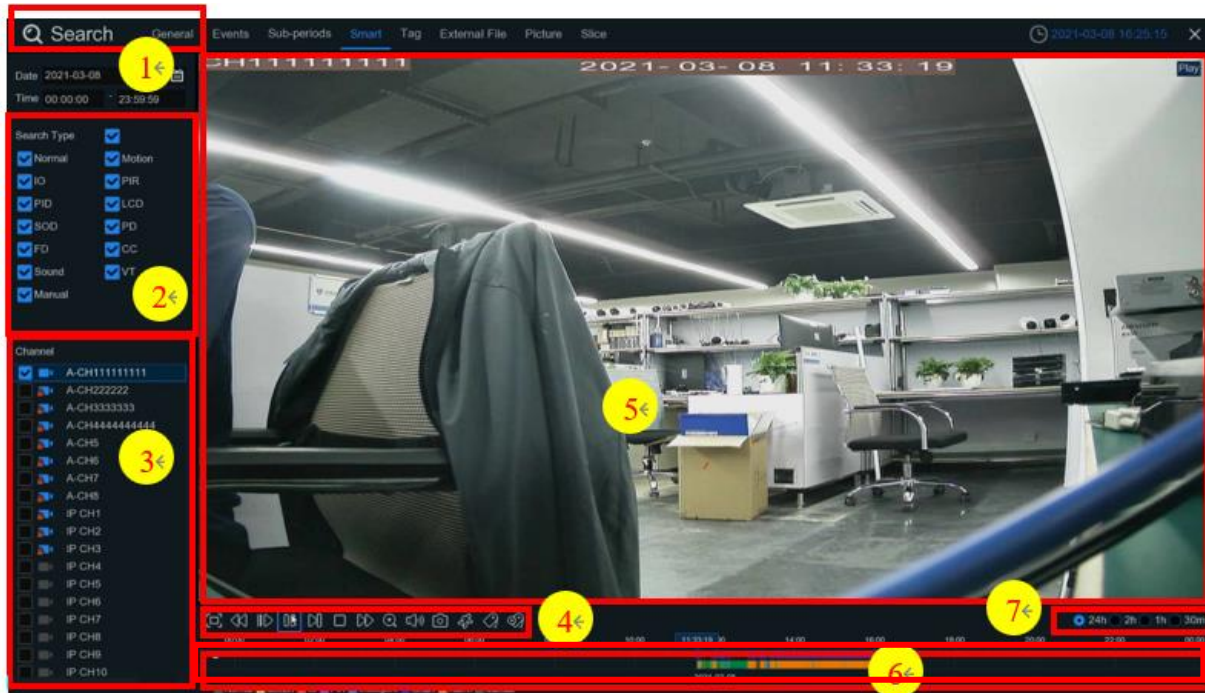

To start a smart search and playback:

- Choose the date and time you want to search.
- Check the recording types you want to search, or check **Search Type** to choose all.
- Choose the channel you want to search, the motion recording in the selected channel will be searched automatically. Please note that this function only supports to search and play one channel at a time.
- Click the play button on the to start playing. Control the playback with buttons on **Video Playback Controls**.
- Videos are being played on the screen.
- The color bar on the top of the timeline indicates the time span of the motion recordings you have searched. The color bar on the bottom of the timeline indicates the complete time span for the whole recordings you have specified.

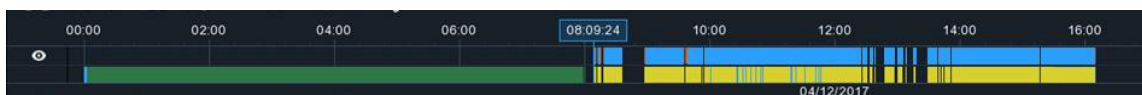

7. Use the timeframe options (24h 2h 1h 30m) to view a smaller or larger time period.

6.1.4.1 Smart Search Area

The smart search function searches the motion recordings in the whole area of the channel by default. You can specify one or more particular areas to narrow your search.





Click this icon  on **Video Playback Controls**, the camera will be shown in full screen and the **Smart Controls Bar** will appear.



You can click and hold the edge of the controls bar to reposition it.

Smart Controls Bar



-  Click this to define a full screen detection area.
-  Click this to delete all areas created.
-  Click this to search and play videos based on the areas defined.
-  Click this to return to the playback interface.

To define one or more specific areas, please do the following:

1. Click and drag to select the area that you want to define. Multiple areas can be defined. You can also use the same action to remove sections of the defined area or to delete it entirely.

When finished, click the search button to play video based on the areas defined.

2. You'll be returned back to the playback interface. Segments matching your search criteria will be shown on the timeline in blue color.

6.1.5 Tag Playback

In tag playback, you can find all added tags and perform playback, editing and deletion operations. Click **Edit** to modify the label name, and click **Delete** to delete the label.

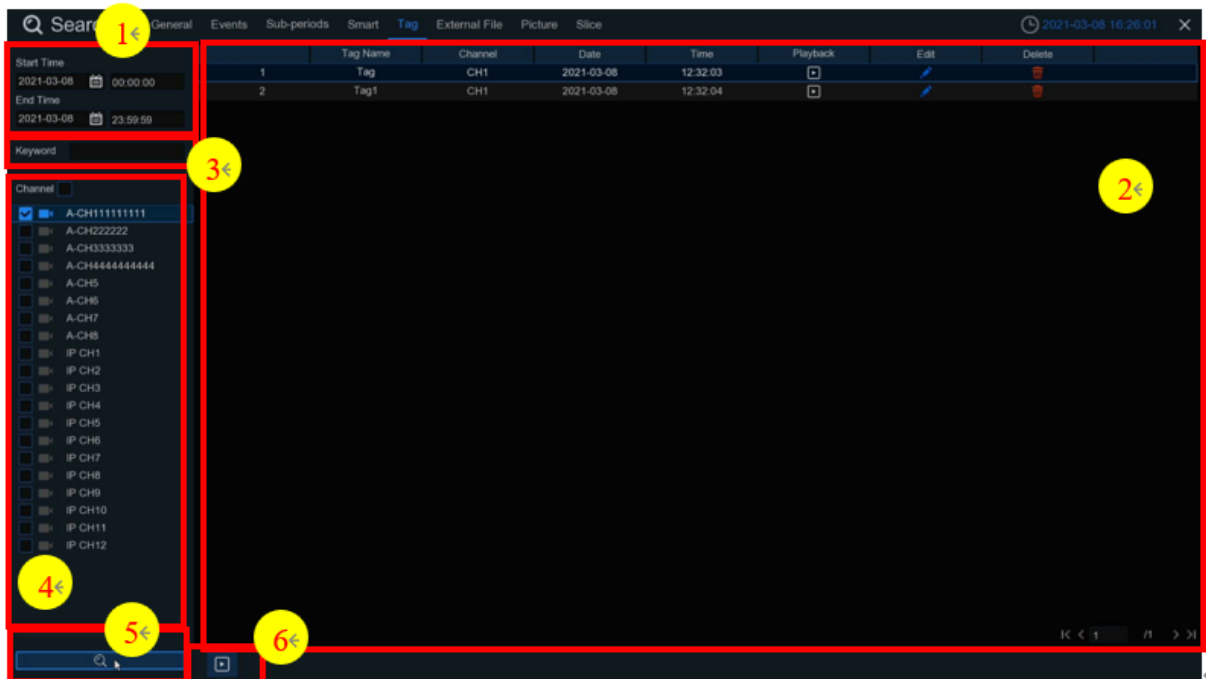

1. Select the start and end time of the search.
2. The results of qualified search elements will be displayed in the form of list.
3. Keyword filtering: You can filter the search results by keyword.
4. Select specific channels or click **Channel** to select all channels.
5. Click to search.
6. Select a bookmark and click **Play** for full screen playback.



1. Playlist, where you can select videos.
2. Play window.
3. Select this node as the center, and the video length will increase forward or backward.
4. Use the buttons on **Video Playback Controls** to control playback. Click the icon or right-click to exit playback and return to the tag playback window.
5. The played event is displayed on the timeline. Use the time range option 24h 2h 1h 30m) to view smaller or larger time periods.

6.1.6 External File Playback



1. Select USB flash drive under **Device Name** and **File Type**.
2. Play window.
3. Select the file path to play.
4. Click **Refresh**.
5. Use the buttons on **Video Playback Controls** to control playback.

6.1.7 Picture Search and View

This function can be used to search, play, and copy snapshots to a USB flash drive.



To search, play, and back up pictures:

1. Choose the date and time you want to search.
2. Check the picture capture types you want to search, or check **Search Type** to choose all.
3. Choose the channels you want to search, or check **Channel** to choose all channels.
4. Click button to start search.
5. Pictures fitting your search criteria are displayed in list form. You can double click one of the pictures to get a larger view.
6. Click icons at the bottom-right corner of the menu to browse between pages of pictures, or input the page you want to browse.
7. You can switch the view of list form in by clicking below icons which is show at the right bottom corner of the screen:



Thumbnails. You can view the snapshots of the events.



List. The events will be displayed on the list.

1	CH1	00:00:00	2	CH1	00:00:45	3	CH1	00:18:30	4	CH1	00:44:03	5	CH1	01:10:48	6	CH1	01:19:22	7	CH1	01:35:37
9	CH1	02:01:12	10	CH1	02:25:38	11	CH1	02:43:17	12	CH1	03:02:08	13	CH1	03:08:37	14	CH1	03:10:01	15	CH1	03:14:54
17	CH1	04:07:23	18	CH1	04:19:35	19	CH1	04:36:40	20	CH1	05:00:20	21	CH1	05:24:12	22	CH1	05:45:55	23	CH1	06:04:07
25	CH1	06:41:12	26	CH1	06:44:25	27	CH1	07:01:42	28	CH1	07:20:43	29	CH1	07:31:23	30	CH1	07:48:04	31	CH1	08:17:33
33	CH1	08:50:34	34	CH1	09:07:05	35	CH1	09:25:12	36	CH1	09:44:07	37	CH1	09:46:08	38	CH1	10:00:52	39	CH1	10:14:18
41	CH1	10:45:57	42	CH1	11:12:48	43	CH1	11:20:27	44	CH1	11:48:18	45	CH1	12:07:25	46	CH1	12:30:12	47	CH1	12:44:43
49	CH1	13:06:48	50	CH1	13:30:46	51	CH1	13:37:51	52	CH1	13:57:01	53	CH1	14:10:24	54	CH1	14:11:16	55	CH1	14:18:12
57	CH1	14:40:31	58	CH1	14:44:42	59	CH1	14:48:38	60	CH1	15:15:44	61	CH1	15:39:06	62	CH1	16:01:07	63	CH1	16:16:00



Detailed. You can view the details of the events.

	Channel	Type	Date	Time	Size	Playback
<input type="checkbox"/> 1	CH1	MIN	10/24/2017	00:00:00	160KB	
<input type="checkbox"/> 2	CH1	MIN	10/24/2017	00:12:01	201KB	
<input type="checkbox"/> 3	CH1	MIN	10/24/2017	00:21:20	401KB	
<input type="checkbox"/> 4	CH1	MIN	10/24/2017	00:24:38	111KB	
<input type="checkbox"/> 5	CH1	MIN	10/24/2017	00:37:25	167KB	
<input type="checkbox"/> 6	CH1	MIN	10/24/2017	00:55:58	210KB	

- When you click the left-click upon one of the pictures, the system will show the picture information at the bottom left corner of the screen.
- Check the box next the number of the event to select files, or check the box next **Select** to select all pictures in the page.
- The number of files selected and total size will be displayed at the bottom right corner of the screen.
- After selecting the files, you can click button to save the pictures to USB flash drive. Or, click button to go into picture preview control window.

6.1.7.1 Picture Preview Control



- On the picture list, you can select the pictures here.
- Click button to save your selected pictures to a USB flash drive. Click button to view the pictures in slideshow.
- Press button to exit preview control window and go back to picture search window. Press button to pause, press to resume slideshow. Press button to display previous snapshot or group of snapshots, press to display the next snapshot or group of snapshots.

Click button to view a single snapshot at a time, click button to view four snapshots at a time, press buttons to view nine snapshots at a time.

6.1.8 Split Playback (Slice)

Video playback allows you to see 60 minutes of video clips within an hour on a certain day, a certain month, a certain year, with 1 minute for each clip.

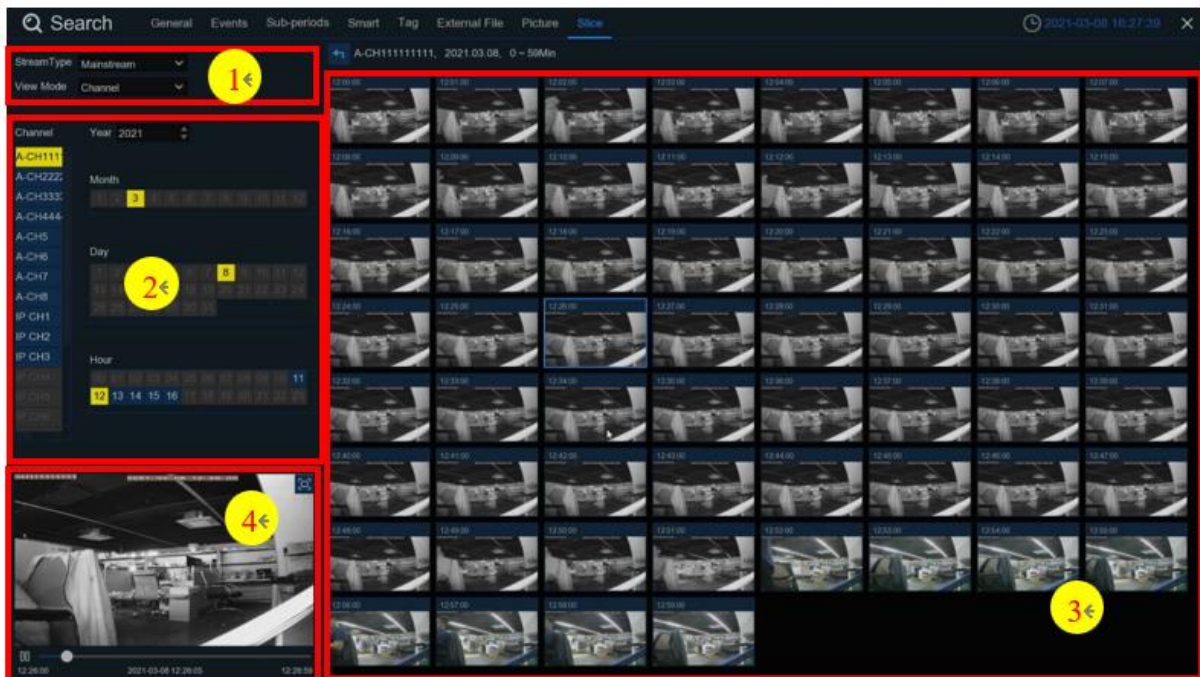

1. Select stream type and view mode.
2. Select the channel and date to play.
3. The results that meet the search criteria are displayed in the form of a list. You can left-click on one of the events to play the video in a small window.
4. Small window play preview. Click the enlarge button at the upper right corner of the small window to enter full screen play mode.



1. On the play list, where you can select video.
2. Play window.
3. Select the node as the center to increase the video length forward or backward.
4. Use the buttons on **Video Playback Controls** to control playback. Click the icon or right-click to exit playback and return to the split playback window.
5. The events displayed on the timeline. Use the time range option
 24h 2h 1h 30m) to view smaller or larger time periods.

Chapter 7 Remote Access via Web Client

Use the **Web Client** to remotely access your DVR at any time via a PC. Before you access **Web Client**, you need to ensure that the internet settings of the DVR are configured properly.

7.1 Basic System Environment Requirements

The minimum requirements for hardware and OS required to run **Web Client** are given as below.

Item	Minimum	Recommended
CPU	Intel® Core™ i5 CPU	Intel® Core™ i5 CPU or higher
RAM	4G or more	8G or more
Hard Drive	500G or more	1000G or more
Display RAM	2G or more	4G or more
Display Resolution	1280*1024	1920*1080
OS	Windows 7 or above Mac OS X® 10.9 or above	
DirectX	DirectX 11	
Direct3D	Acceleration Function	
Ethernet Adapter	10/100/1000M Ethernet Adapter	
IE	10/11	
Mozilla Firefox	V.52 or later	
Google Chrome	V.57 or later	
Mac Safari	V12.1 or later	
Edge	V.79 or later	

Note: Currently only IE supports audio playback.

7.2 Web Plugin Download and Installation

To access **Web Client**, do the following:

By default, when the DVR is connected LAN with DHCP server, it is automatically assigned with a dynamic IP address. Follow the steps below to look up its IP address.

1. Download and install the **UVS Device Utility** program [here](#).
2. On the UVS Device Utility window, click **Search** to search for the devices connected in the same LAN.
3. Find the device with its Mac Address and click on its IP address.

No.	IP	Web Port	Channel	Device Name	Device Type	Device Version	Net Mask	Gateway	MAC	Network Mode	P2P ID	Status
1	192.168.0.209	80	1	UA-R560F2	UA-R560F2	V1.00_2022_01_06	255.255.248.0	192.168.0.1	00-13-E2-30-00-1A	DHCP	PFAX-HLHGK2...	
2	192.168.4.106	80	8	UA-XVRB10	UA-XVRB10	V1.00_2021_12_23	255.255.248.0	192.168.0.1	00-13-E2-30-00-41	DHCP	0A3P7UW5ZS...	
3	192.168.4.157	80	8	UA-XVL810	UA-XVL810	V1.00_2021_12_29	255.255.248.0	192.168.0.1	00-13-E2-30-00-51	DHCP	0B8FF4T5E1P...	
4	192.168.5.19	80	16	UA-XVL1619	UA-XVL1619	V1.00_2021_12_23	255.255.248.0	192.168.0.1	00-13-E2-F7-5E-83	DHCP	NRZSJB2EM61...	
5	192.168.5.126	80	8	UA-XVRB10	UA-XVRB10	V100_2021_11_10	255.255.248.0	192.168.0.1	00-13-E2-30-00-3C	DHCP	0NHD46JES2S...	
6	192.168.5.21	80	16	UA-SNVR1620-P	UA-SNVR1620-P	V1.00_2021_12_20	255.255.248.0	192.168.0.1	00-13-E2-FA-32-75	DHCP	0YD11MNS6KY...	

4. The login web page appears.

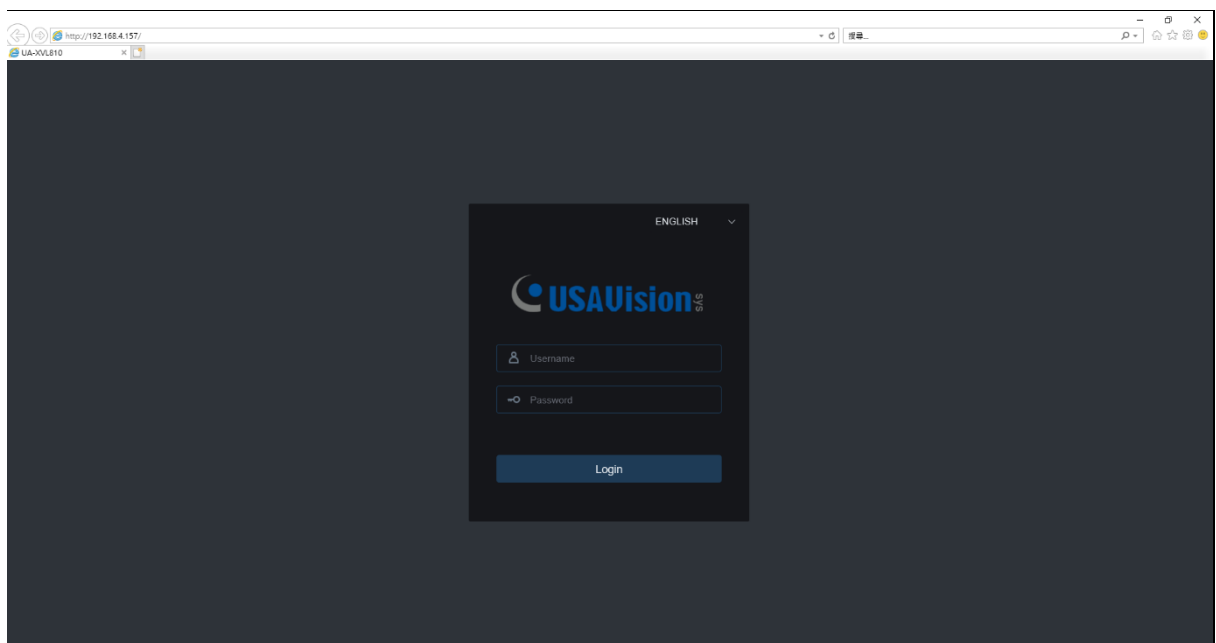

7.3 Web Client Manager

The **Web Client** supports a fully control of the DVR with the administrator account. Please make sure to protect your user name and password to prevent illegal login.

7.3.1 Live Interface



This is the first screen that opens after you have logged in to the **Web Client**. Here you can open or close live preview, record video to local computer manually, take snapshots of the screens, PTZ control, color adjustment, etc.





1. **Channel List:** Open the channel list for quick camera function.



Click  button to display the **Channel List**.

Click  button to hide the **Channel List**.

  **Play.** Turn the Live video stream on / off. The button is in blue color if the live video streaming is on.

  **Record.** Click to start manually recording live streaming video. Click again to stop recording. Manual recordings are saved to your computer. While in recording, the button is in blue color.

 **Capture.** Click to save a snapshot of the current live display to your computer.

  **Bitrate.** Set camera to use mainstream, sub-stream, or mobile stream video settings.
Mobile stream is available for IP channels only.

2. **Live Video Stream Options:**

Mainstream: View all live videos using high-quality mainstream video settings.

SubStream: View all live videos using middle-quality sub-stream video settings.

MobileStream: View all live video using lower-quality mobile stream video settings to conserve bandwidth. Available for IP channels only.

3. **Main Menus:**

Live: View live video from cameras.

Playback: View recorded video which is saved in the DVR's HDD.

Remote Setting: Access functions of the DVR setting menus.

Local Settings: Set download locations for recordings and snapshots taken using **Web Client**, and choose file type for video files.

4. **Information:** Hover over to see system details.

5. **Exit.**

6. **Color.** Click to display or hide the color controls.



7. **PTZ Setting:** Click to display or hide the PTZ controls for using PTZ cameras.

PTZ Setting

Directional Arrows: Click to move the PTZ camera

Automatic line scan

PTZ

Speed

PTZ Speed

ZOOM

ZOOM: Click - / + to zoom in or out.

FOCUS

FOCUS: Click - / + to adjust focus.

IRIS

IRIS: Click - / + to adjust iris.

Model

Preset Cruise

Cruise: Start / stop PTZ cruise

Add Preset

No.	Time	CON.
1	3	🗑️ →

Preset Point: Adjust time, remove, or go to preset point

8. **Live View Control Buttons:**





- Open the images on Live window.
- Close all the Live channels
- Original Proportions: Shows live video at the original proportions.
- Stretch: Stretch live video to fit the full area for each channel on screen.
- To enlarge the web client to full screen.

 **Manual Recording:** Click to start manually recording for all displayed channels. Click again to stop recording. Manual recordings are saved to your computer.

 **Snapshot:** Click to save snapshots of all current displayed channels to your computer.

 **Digital Zoom:** Click upon on a live image, then click-and-drag over an area of the live image to enlarge. Right-click to return to the normal display.

 **Volume Control.**  Volume is mute.

 **White light control,** which can manually turn on the white light warning (supported by some models).

 **Alarm bell control,** can be manually activated alarm bell warning (some models support).

 **Click add custom label.** The label can be found in the playback. Refer to *6.1.5 Tag Playback* for details.

9. Navigation: Shows current page number for the channels shown on screen. Use the arrow keys to switch between pages.

10 Page View: Click to select the number of channels appear on screen at a time.

11. Manual Alarm: The external alarm of each channel can be triggered manually.

7.3.2 Playback

You can search and play recording videos stored in the HDD inside the DVR and download the videos to your computer.

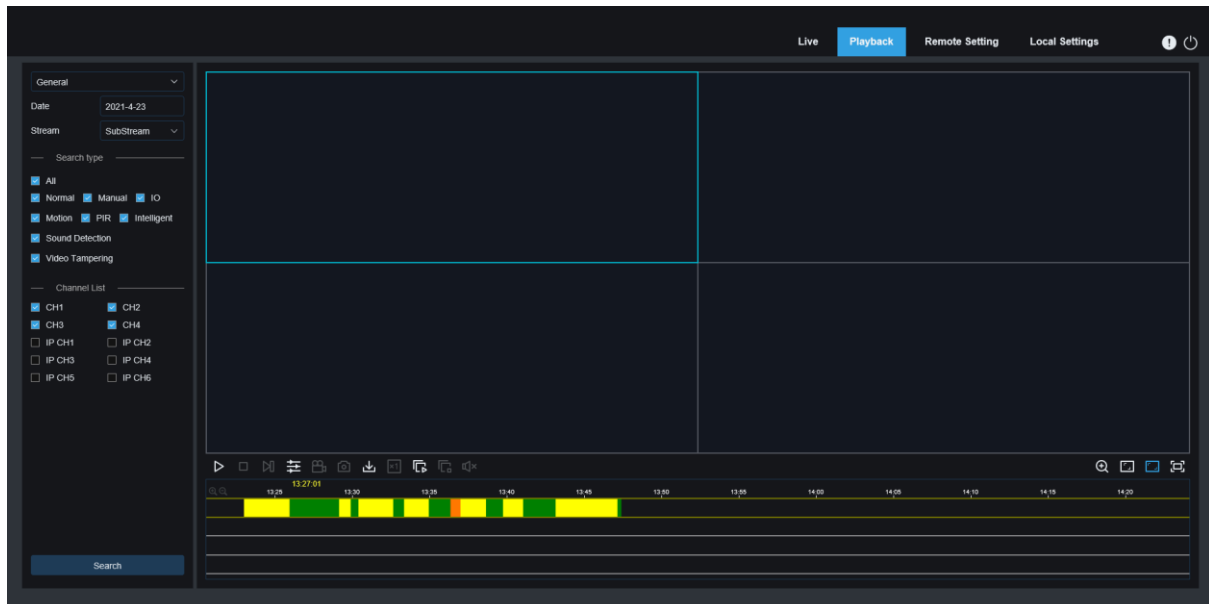

To search recordings:

1. Click **Playback** at the top-right corner of the window.
2. Select a day on the calendar to search for recordings from. Days with recordings appear with a red underline.
3. Select the recording type to search for from the dropdown next to **Type**, or select **All** to search for all recordings.
4. To choose the video stream you want to search and play. If you want to play sub-stream recordings, please make sure you have set the DVR to record with dual-stream resolution. Refer to *5.2.2.1 Record* for details.
5. Check the channels you would like to search for recordings from.
6. Click **Search**.
7. Recordings that fit your search criteria will be displayed on the timeline. Click a section of video where you would like to begin playback and click the ► play button.

7.3.2.1 Playback Control Buttons





► **Play the recordings**

 **Pause**

 **Stop**

 **Go Forward One Frame:** Move frame-by-frame through playback.

 Click upon one of the channels which is being played and then click record button to record current video to your computer. Click again to stop recording.

 Click upon one of the channels which is being played and then click capture button to take a snapshot and save to your computer.

 Opens the **Download** menu, which allows you to download several video recordings at once.

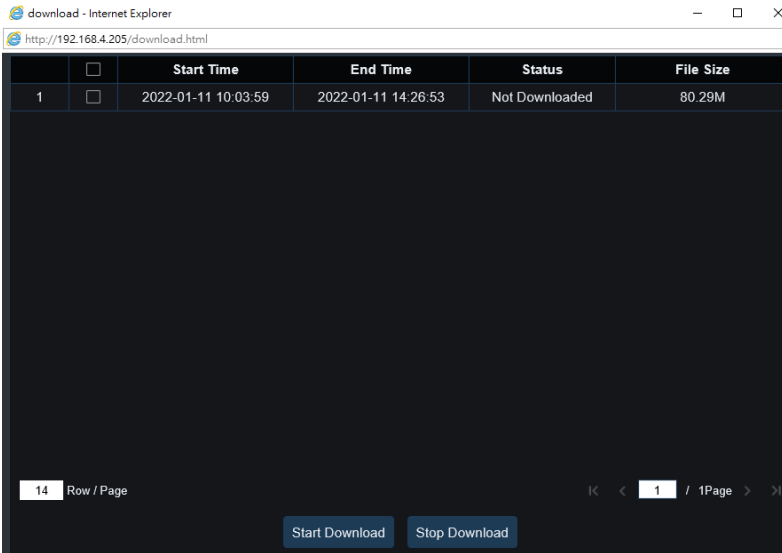



		Start Time	End Time	Status	File Size
1	<input type="checkbox"/>	2022-01-11 10:03:59	2022-01-11 14:26:53	Not Downloaded	80.29M

14 Row / Page < 1 / 1Page >

Start Download Stop Download

Choose the files you want to download, press **Start Download** to begin. You will see the download status. Press **Stop Download** to stop.

 **Playback Speed.** Click to choose the playing speed.

 **Play All Channels:** Click to play all channels you have chosen to searched.

 **Stop All Channels:** Click to stop playing all channels.

 **Digital Zoom:** Click upon on a playing video, then click-and-drag over an area of the video to enlarge. Right-click to return to the normal display.

 **Original Proportions:** Shows the playing video at the original proportions

 **Stretch:** Stretch the playing video to fit the full area for each channel on screen.

Full Screen: To enlarge the web client to full screen.

7.3.2.2 Picture Playback

After setting the capture in [5.2.3 Capture](#), you can search the captured image here.

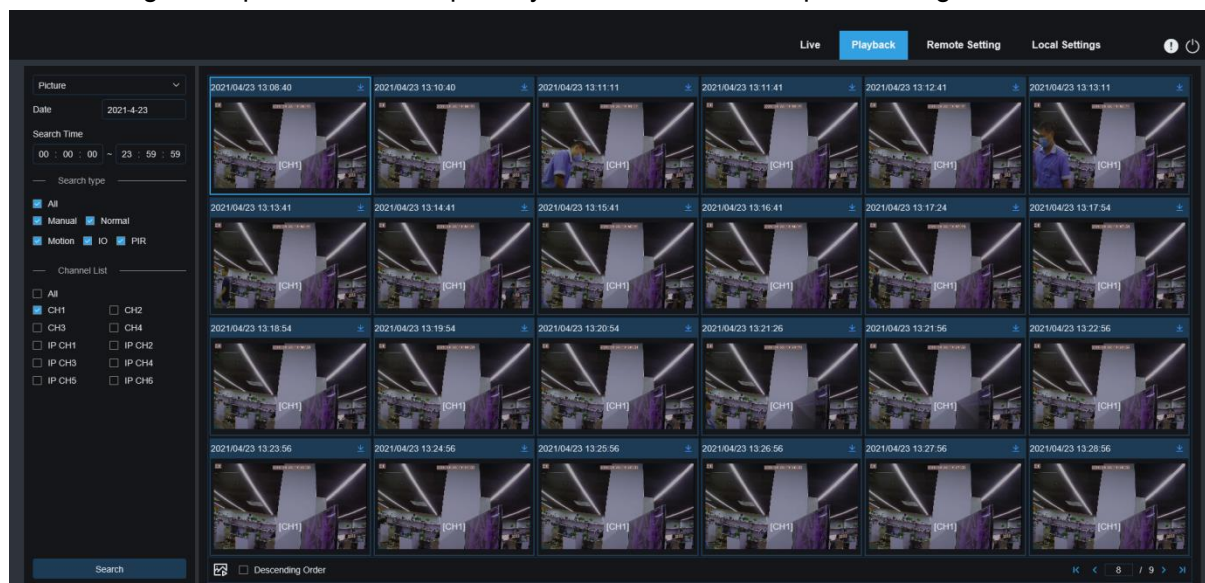

Search snapshot:

1. Click **Playback** at the upper right corner of the window.
2. Select picture from the drop-down list at the upper left corner.
3. Select a day to search on the calendar. The date with the snapshot is underlined in red.
4. Select the image type to search from the list in the search type menu, or select **All** to search all types.
5. Check the channel to search for videos.

Click **Search**.

- Pictures that match your search criteria will be displayed on the right. You can double-click any picture to enter the small clip playback interface.

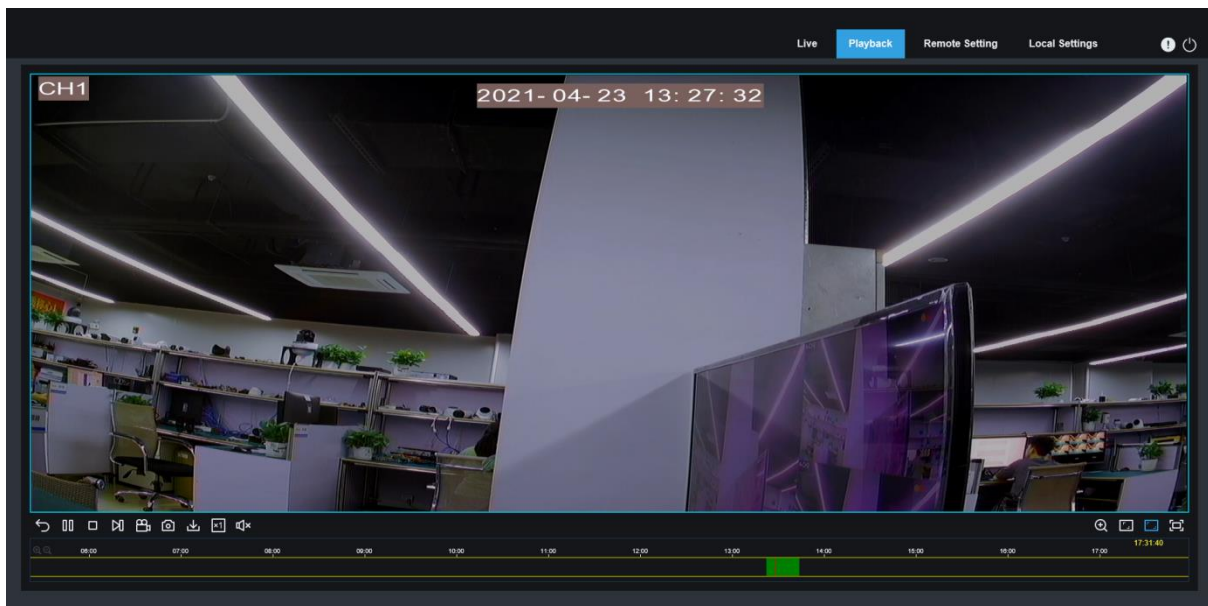

7.3.2.3 Tag Playback

In this menu, you can view all the tags that have been added.

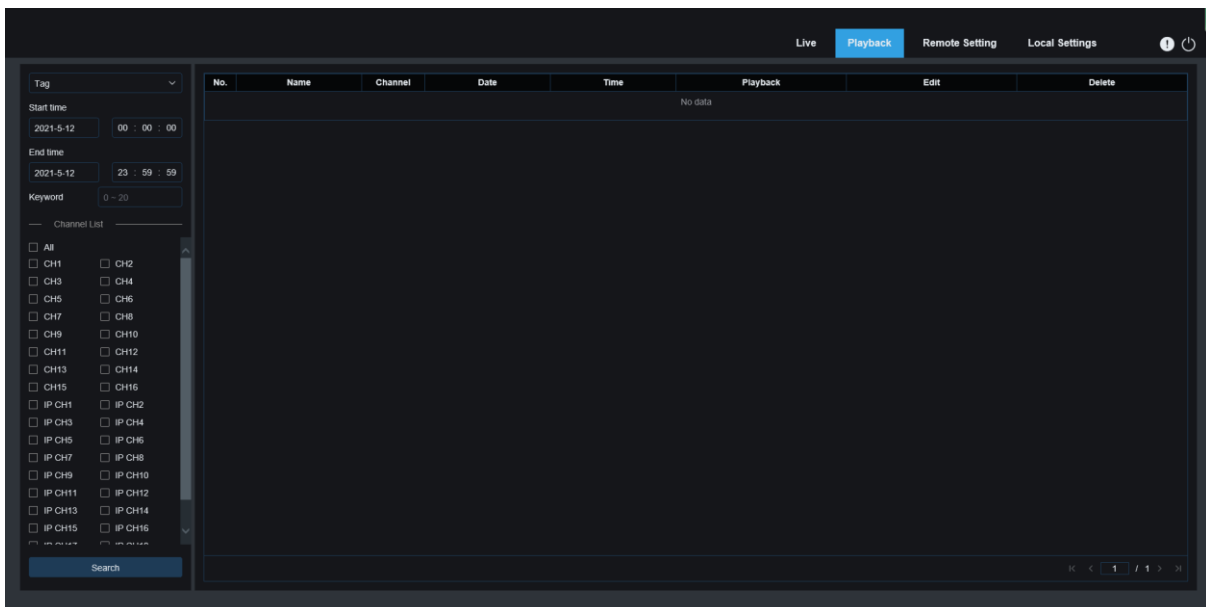

Refer to 6.1.5 Tag Playback for details.

7.3.3 Remote Setting

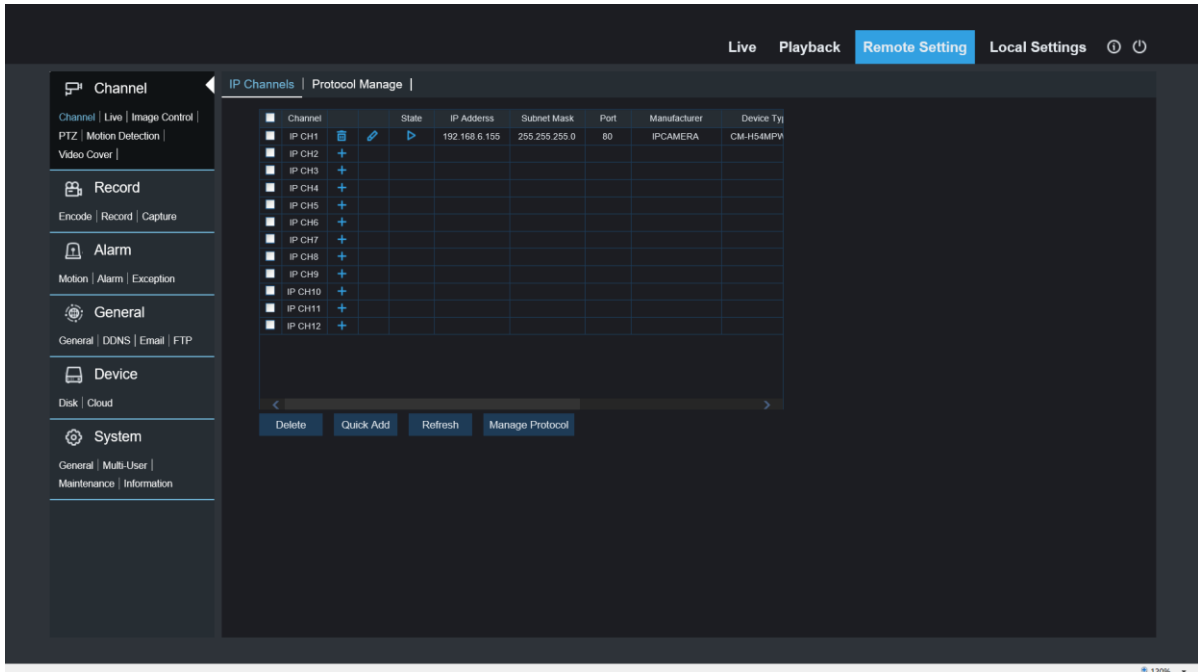

Here you can remotely configure the settings of the DVR. Please see [Chapter 5 DVR System Setup](#) for details on the DVR settings

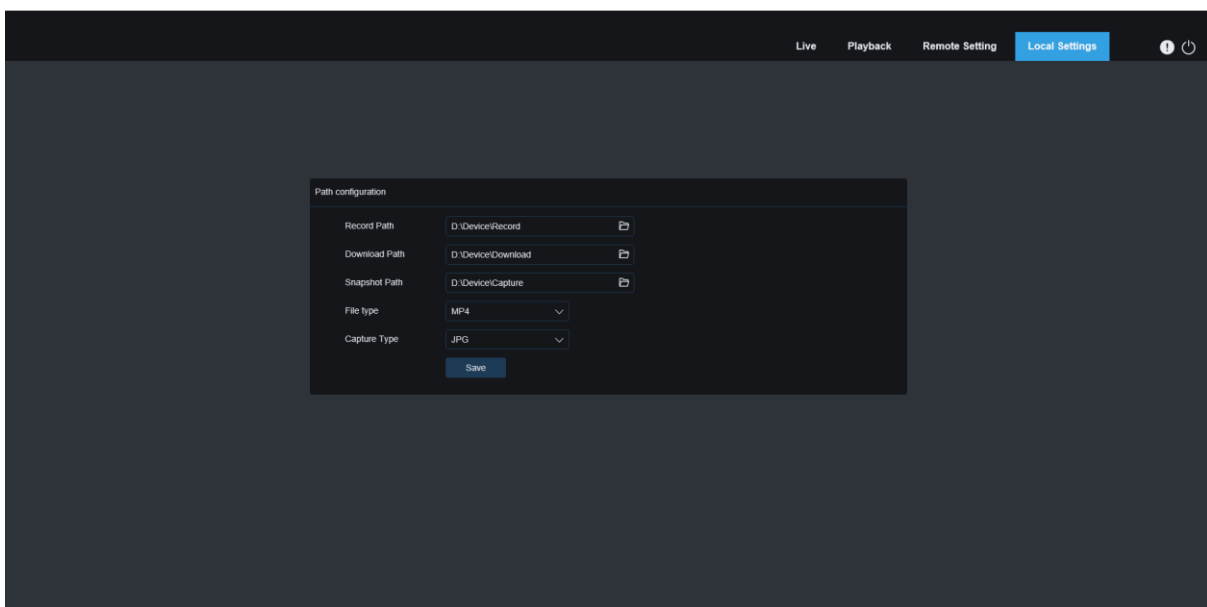

7.3.4 Local Setting

Set download locations for recordings and snapshots taken using **Web Client** and choose file type for video files.



- **Record Path:** Click  to browse and select the folder where you would like the manual video recordings to be saved on your computer.
- **Download Path:** Click  to browse for and select the folder where you would like to save the download video recordings to your computer.
- **Snapshot Path:** Click  to browse for and select the folder where you would like the manual capture snapshots to be saved on your computer.
- **File Type:** Choose your preferred file type for manual recordings.
- **Capture Type:** Choose your preferred file type for manual capture.
- **Save:** Click to save the modifications.

Chapter 8 Remote Access via Mobile Devices

The DVR supports to remotely access via mobile devices based on Android and iOS operating system. Refer to [GV-Eye Installation Guide](#) for details on operating instructions.

Note: This function is only applicable to GV-Eye V2.9 or later.

Appendix

A. Troubleshooting

1. Q: What can I do if the system does not detect the HDD?

A: Check if the power supply system is properly connected and data cord and power cables are securely connected, and if there's something wrong with the HDD interface. Or you may check if your HDD is supported by referring to the specifications or descriptions.

2. Q: I have changed the password but forget the new password, how can I access the system?

A: If you forget system password, consult with our technical personnel. We strongly suggest user to set password easy to be remembered and relatively safe. If you have safety requirement, do not set very simply password, such as 000000.

3. Q: We see abnormal video signal or even no video signal by connecting the DVR and camera together. Power supply for both devices is OK. What is wrong?

A: Check network cable at DVR side to see if the cable is firmly connected and if it is worn out and needs to be replaced, or to check if NTSC or PAL is selected consistently.

4. Q: How to prevent DVR from being influenced by heat?

A: The DVR needs to dissipate heat while it is running. Place the DVR in a place with good air circulation and away from heat sources to ensure stability and life of the DVR.

6. Q: I want to take out HDD from my PC and install it in DVR. Can it work?

A: All HDDs supported by the system can be used. But remember, once the DVR runs, the data on your HDD will be lost.

7. Q: Can I play back while recording?

A: Yes. The system supports the function of playing while recording.

8. Q: Can I clear some records on the HDD of the DVR?

A: In consideration of the file security, you may not clear part of records. If you want to remove all the records, you can format HDD.

9. Q: Why can't I log in DVR client?

A: Check if the network connection settings are correct and RJ-45 port is with good contact. And check if your account and password are correctly input.

10. Q: Why can't I find any records during playback?

A: Check if the data line connection for HDD is OK and system time is properly adjusted. Try a few times and restart. If it still doesn't work, check if the HDD is broken.

11. **Q: Why DVR cannot control PTZ?**

A: Check if:

- a) PTZ in the front side is malfunctional.
- b) Setting, connection and installation of PTZ decoder are not correct.
- c) PTZ setting of DVR is not correct.
- d) Protocol of PTZ decoder does not match that of DVR.
- e) Address of PTZ decoder does not match that of DVR.
- f) If many decoders are connected, the farthest side of AB line of PTZ decoder should be added 120Ω resistance to realize reflection suppression and impedance matching. Otherwise, PTZ control will be unstable.

12. **Q: Why doesn't dynamic detection work?**

A: Check if the motion detection time and motion detection regional setting are correct and if the sensitivity is set too low.

13. **Q: Why doesn't alarm work?**

A: Check if the alarm setting, alarm connection and alarm input signals are correct.

14. **Q: Why does buzzer keep alarming?**

A: Check the alarm setting, check if motion detection function is enabled and object motion is detected all the time and if I/O alarm is set as Always Off. Besides, refer to corresponding HDD alarm setting.

15. **Q: Why can't I stop recording by pressing "STOP" button or click "Stop Recording" in context menu?**

A: Pressing Stop or Stop Recording can only stop manual record. If you want to stop Scheduled recording in certain time quantum, change the setting to No Record. To stop Startup recording, change record mode to scheduled recording or manual recording. Then you may stop recording by the prescribed methods. And another way of stopping recording is to set channel as off status in record setting.

B. Usage Maintenance

1. To shut down DVR, please firstly shut down the system and then turn off the power. Do not turn off the power directly or HDD data will be lost or damaged.
2. Please keep DVR away from heat sources or places.
3. Clean the internal dust regularly. Make sure the good ventilation of DVR so as to ensure the good heat dissipation.
4. Please do not hot plugging audio and video cables, or cables connected to ports like RS-232 or RS-485. Otherwise, the ports will be damaged.
5. Please check the HDD cable and data cable regularly to see if they are ageing.
6. Please prevent the audio and video signals of DVR from being intervened by other electronic devices, and prevent the HDD from being damaged by static electricity and induced voltage. If the network cable is frequently plugged, it is suggested to replace connecting line regularly, or the input signal may be unstable.
7. This is a class of product. It may bring wireless interference in life. Under this situation, it need user to make measures.