

VP6970 USB-C Triple 4K Monitor Docking Station

User Guide



- 16 Ports with AC Adapter
- 4K HDMI 2.0b Ports (2)
- DP1.4 DisplayPort™
- USB-C Ports (3)
 - PD to Host (1)
 - Data/Power (2)
- USB-A Ports (5)
- Gigabit Ethernet
- SD/TF Card Readers (2)
- Duo-Mode Audio



2024-A

Interface Overview

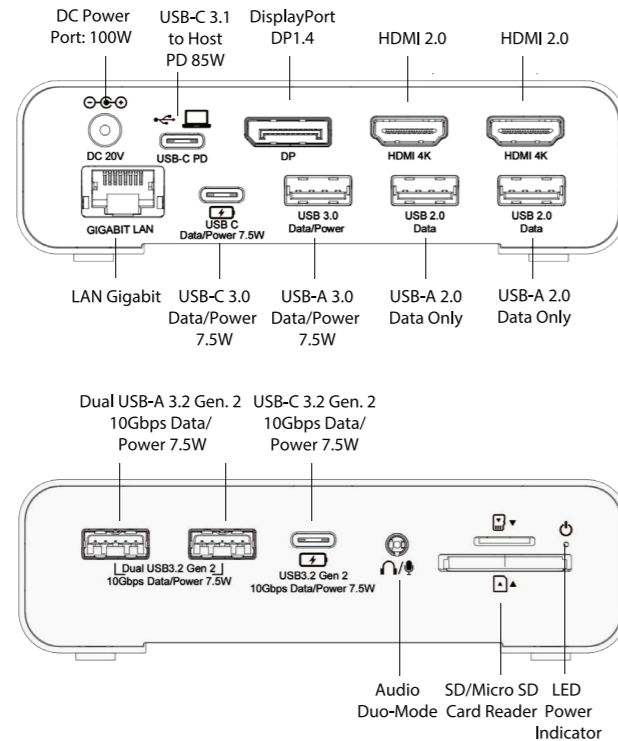

2.

Operating Instructions

1. Connect the docking station to the host computer via the provided USB-C to USB-C cable.
2. Connect the AC adapter to the docking station, then plug in to the wall power.

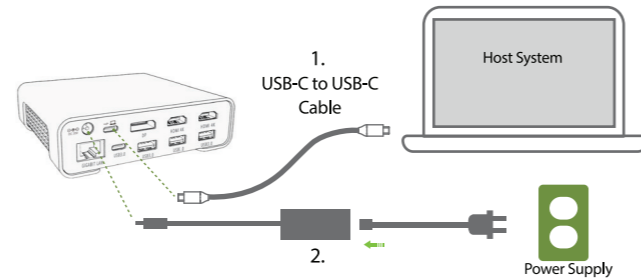

- **System Requirements:**
 - Hardware: available USB-C port supporting DP Alt Mode (or Thunderbolt 3) and Power Delivery (PD)
 - Operating Systems: Windows 8, 10 and later; macOS X, 10.X and later
- **Package Contents:**
 - USB-C Docking Station
 - AC Adapter with Attached Charging Cable
 - USB-C (male) to USB-C (male) Cable: connect the docking station to the host computer
 - User Guide

3.

Display Setup in Windows

Clone Mode

1. Intel Graphics Card

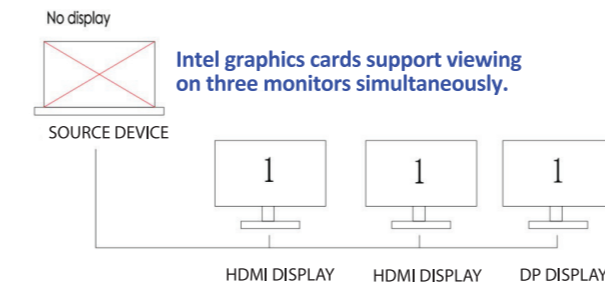

2. Other graphics card (e.g. AMD)

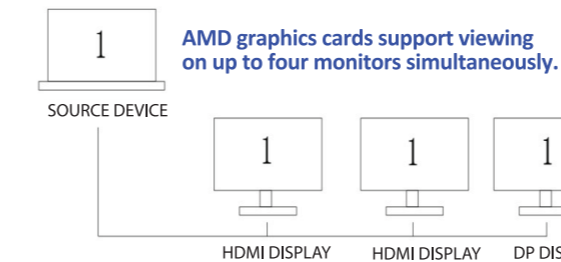

4.

Display Setup In Windows

Extended Mode

1. Intel Graphics Card

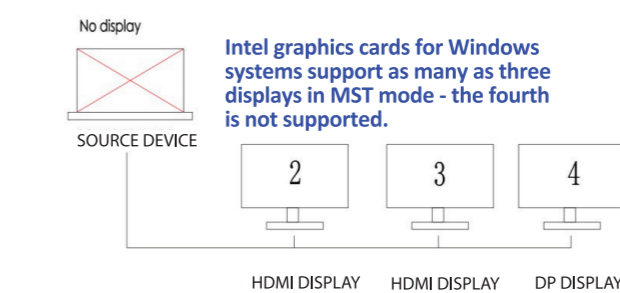

2. Other graphics card (e.g. AMD)

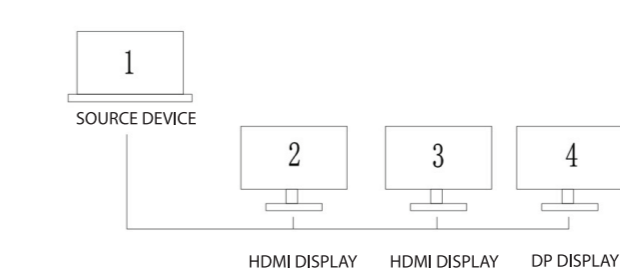

5.

Display Setup in macOS

Mirror Display

1. Apple Intel Systems

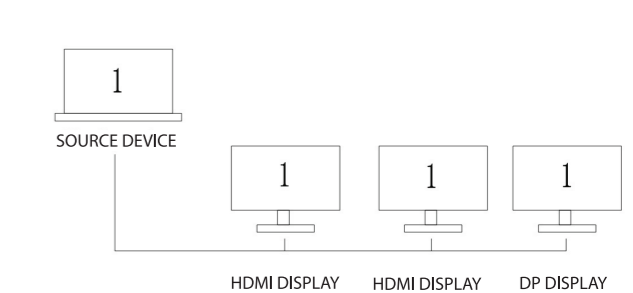

2. Apple M1 Family Systems

Monitor	Apple M1	Apple M1 Pro	Apple M1 Max
Notebook	1	1	1
Monitor #1	1	1	1
Monitor #2		1	1
Monitor #3			1

Note: Apple M1 Family does not support MST.

6.

Display Setup in macOS

Extended Display

1. Apple Intel Systems

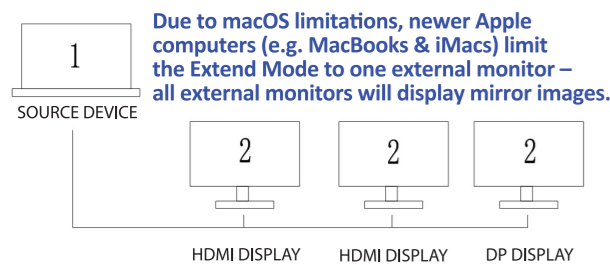

2. Apple M1 Family Systems

Monitor	Apple M1	Apple M1 Pro	Apple M1 Max
Notebook	1	1	1
Monitor #1	2	2	2
Monitor #2		2	2
Monitor #3			2

Note: Apple M1 Family does not support MST.

7.

Maximum Display Resolutions

Optimal resolution. Actual resolution depends on monitor and graphic card performance. 4k@60Hz requires VESA timing display & DP1.4 video source with bit depth 8bpc. CES timing not supported.

Windows OS

USB-C DP Alt Mode (DP1.4) MST				
Video Out	HDMI 1	HDMI 2	DP	
Single Display	3840x2160/60Hz	3840x2160/60Hz	3840x2160/60Hz	
Dual Displays	3840x2160/30Hz	3840x2160/30Hz	3840x2160/30Hz	
Triple Displays	3840x2160/30Hz	3840x2160/30Hz	3840x2160/30Hz	
USB-C DP Alt Mode (DP1.2) MST				
Video Out	HDMI 1	HDMI 2	DP	
Single Display	3840x2160/30Hz	3840x2160/30Hz	3840x2160/30Hz	
Dual Displays	1920x1080/60Hz	1920x1080/60Hz	1920x1080/60Hz	
Triple Displays	1920x1080/60Hz	800x600/60Hz	800x600/60Hz	

macOS

USB-C DP Alt Mode (DP1.4)				
Video Out	HDMI 1	HDMI 2	DP	
Single Display	3840x2160/60Hz	3840x2160/60Hz	3840x2160/60Hz	
Dual Displays	3840x2160/30Hz	3840x2160/30Hz	3840x2160/30Hz	
Triple Displays	3840x2160/30Hz	3840x2160/30Hz	3840x2160/30Hz	
USB-C DP Alt Mode (DP1.2)				
Video Out	HDMI 1	HDMI 2	DP	
Single Display	3840x2160/30Hz	3840x2160/30Hz	3840x2160/30Hz	
Dual Displays	3840x2160/30Hz	3840x2160/30Hz	3840x2160/30Hz	
Triple Displays	3840x2160/30Hz	3840x2160/30Hz	3840x2160/30Hz	

8.

Interface Specifications

Front Panel

- 2 * USB-A 3.2 Gen2 (Data/Power) supports 10Gbps data & 7.5W (max 9W) power
- 1 * USB-C 3.2 Gen2 (Data/Power) supports 10Gbps data & 7.5W (max 9W) power
- 1 * 3.5mm stereo combo jack supports microphone input & audio output
- 2 * SD/TF Micro SD USB2.0 card reader slots support SDXC cards up to 2TB @ 25Mbps data transfer rate; only 1 card at a time.

Back Panel

- 1 * DC-IN for AC adapter @ 20V/3.25A=100W
- 1 * USB-C 3.0 Gen1 (Data/Power) supports 5Gbps data & 7.5W (max 9W) power
- 1 * USB-C (to host) with PD = 85W
- 2 * HDMI 2.0b = 4k @ 60Hzs
- 1 * DisplayPort @ DP1.4 = 4k @ 60Hz
- 1 * USB-A 3.0 (Data/Power) supports 5Gbps data & 7.5W power
- 2 * USB-A 2.0 (Data/Power) supports 480Mbps data & 5V/500mA power
- 1 * RJ45 LAN port supports 10/100/1000Mbps

9.

Trouble Shooting

1. **Apple MacBooks** – Your Apple MacBook may start self-protection mode. You will be prompted with an icon that your USB power has been disabled. Simply disconnect the Docking Station, click the disabled icon and re-connect the Docking Station, giving priority to the Power Delivery Port.
2. **Power Delivery** – When plugging and unplugging the AC adapter and/or the USB-C charging cable to the docking station, your device may briefly disconnect, then reconnect. Avoid disconnecting the power supply when transmitting data.
3. **Ethernet Port** is plug-and-play on Windows systems. With MacBooks, however, simply use Network System Preference to create a new service, choosing USB 10/100/1000 LAN. Select this to connect to your local area network.

Do not use extension cables, cable adapters or port converters.

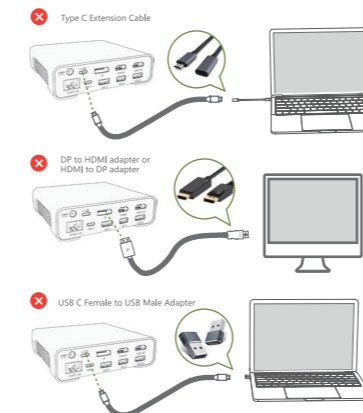

10.

FCC Statement

This equipment has been tested and found to comply with the limits for a class B digital device, pursuant to part 15 of the FCC Rules. These limits are designed to provide reasonable protection against harmful interference in a residential installation. This equipment generates, uses and can radiate radio frequency energy and if not installed and used in accordance with the instructions, may cause harmful interference to radio communications. However, there is no guarantee that interference will not occur in a particular installation. If this equipment does cause harmful interference to radio or television reception, which can be determined by turning the equipment off and on, the user is encouraged to try to correct the interference by one or more of the following measures:

- Re-orient or relocate the receiving antenna.
- Increase the separation between the equipment and receiver.
- Connect the equipment into an outlet on a circuit different from that to which the receiver is connected.
- Consult the dealer or an experienced radio/TV technician for help.

This equipment has been verified to comply with the limits for a class B computing device, pursuant to FCC Rules. In order to maintain compliance with FCC regulations, shielded cables must be used with this equipment. Operation with non-approved equipment or unshielded cables is likely to result in interference to radio and TV reception. The user is cautioned that changes and modifications made to the equipment without the approval of manufacturer could void the user's authority to operate this equipment.

11.

Thank You



Thank you for choosing the VP6970 USB-C Triple 4k Monitor Docking Station, an essential home and office connectivity tool supporting up to 3 external displays. Provided AC adapter means no need to remove the power supply when taking the notebook computer with you.

- **Registration & Warranty**
Registration: www.smklink.com/register
Warranty: www.smklink.com/warranty
Support: www.smklink.com/support

- **Product Support**
SMK Electronics Corporation U.S.A.
1055 Tierra Del Rey, Chula Vista CA, 91910, USA
Phone: (888) 696-3500
Email: pcsupport@smkusa.com

Copyright 2022, SMK Electronics Corporation USA. SMK and the SMK-Link logo are registered trademarks of SMK Electronics Corporation, USA. Apple, the Apple logo, macOS and Macbook are registered trademarks of Apple, Inc. Windows and the Windows logo are registered trademarks of Microsoft Corporation. All other registrations are properties of their respective owners.



12.