

Lenovo 100w Gen 3/300w Gen 3/500w Gen 3 User Guide



Read this first

Before using this documentation and the product it supports, ensure that you read and understand the following:

- *Safety and Warranty Guide*
- *Setup Guide*
- [Generic Safety and Compliance Notices](#)

First Edition (May 2021)

© Copyright Lenovo 2021.

LIMITED AND RESTRICTED RIGHTS NOTICE: If data or software is delivered pursuant to a General Services Administration "GSA" contract, use, reproduction, or disclosure is subject to restrictions set forth in Contract No. GS-35F-05925.

Contents

Discover your Lenovo notebook.iii

Chapter 1. Meet your computer. 1

Front	1
Base	2
Left	3
Right	4
Bottom	5
Rear	6
Specifications	6
USB specifications	7

Chapter 2. Get started with your computer. 9

Access networks	9
Connect to Wi-Fi networks.	9
Connect to a cellular network (for selected models of 300w Gen 3 only)	9
Interact with your computer	10
Use Hotkeys	10
Use the touch screen (for 300w Gen 3 and 500w Gen 3 only)	10
Connect to an external display	12
Get to know operating modes (for 300w Gen 3 and 500w Gen 3 only).	13
Use Lenovo Integrated Pen (for selected models of 300w Gen 3 and 500w Gen 3 only)	14

Chapter 3. Explore your computer 15

Lock the computer	15
Use the Vantage app.	15
Manage power	16
Check the battery status	16
Charge the battery	16
Change the power settings	16
Transfer data	17
Set up a Bluetooth connection	17
Use a microSD card	17

Chapter 4. Configure advanced settings. 19

UEFI BIOS setup utility	19
Enter the UEFI BIOS setup utility	19
Change the startup sequence	19
Change the hotkey mode	19
Enable or disable the Always On USB function	19
Use passwords	19

Password types	19
Set an administrator password	20
Change or remove the administrator password	20
Set a user password	20
Change or remove the user password	21
Enable the power on password	21
Set a hard disk password	21
Change or remove the hard disk password	22
Recovery information	22
Restore system files and settings to an earlier point	22
Restore your files from a backup	22
Reset your computer	22
Use advanced options	22
Windows automatic recovery.	23
Create and use a recovery USB device	23
Install a Windows operating system and drivers	23
Use firewalls and antivirus programs.	24

Chapter 5. CRU replacement 25

CRU list	25
Disable Fast Startup and the built-in battery.	25
Replace a CRU	26
Pen dummy (for selected models of 300w Gen 3 and 500w Gen 3)	26
Base cover assembly	26
Wireless WAN card (for selected models of 300w Gen 3 only)	27
M.2 solid-state drive (for selected models of 300w Gen 3 and 500w Gen 3)	28
Coin-cell battery.	30

Chapter 6. Help and support 33

Frequently asked questions	33
Self-help resources	34
Windows label	35
Call Lenovo	35
Before you contact Lenovo	35
Lenovo Customer Support Center.	36

Appendix A. Accessibility and ergonomic information 39

Appendix B. Compliance information. 41

Appendix C. Notices and trademarks. 45

Discover your Lenovo notebook

Thank you for choosing a Lenovo® notebook! We are dedicated to delivering the best solution to you.

Before starting your tour, please read the following information:

- Illustrations in this documentation might look different from your product.
- Depending on the model, some optional accessories, features, software programs, and user interface instructions might not be applicable to your computer.
- Documentation content is subject to change without notice. To get the latest documentation, go to <https://pcsupport.lenovo.com>.

Chapter 1. Meet your computer

Front



	Camera		Webcam privacy shutter
	Microphone		Touch screen (for 300w Gen 3 and 500w Gen 3 only)



Webcam privacy shutter



Slide the webcam privacy shutter to cover or uncover the camera lens. It is designed to protect your privacy.

Related topics

- “Use the touch screen (for 300w Gen 3 and 500w Gen 3 only)” on page 10





Base



 <p>World-facing camera (for selected models of 300w Gen 3 and 500w Gen 3)</p>	 <p>Microphone (for selected models of 300w Gen 3 and 500w Gen 3)</p>
 <p>Trackpad</p>	

Left







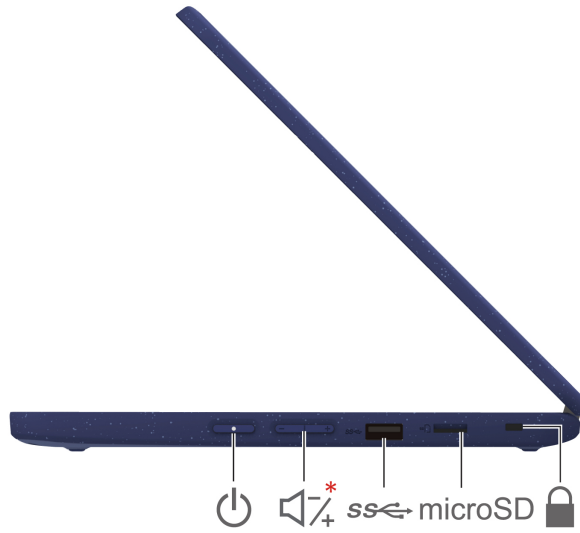

	Power connector / USB-C® 3.2 connector Gen 1		Always On USB 3.2 connector Gen 1
HDMI	HDMI™ connector		Audio connector
	Lenovo Integrated Pen (for selected models of 300w Gen 3 and 500w Gen 3)		

Related topics

- “Charge the battery” on page 16
- “USB specifications” on page 7
- “Use Lenovo Integrated Pen (for selected models of 300w Gen 3 and 500w Gen 3 only)” on page 14

Right



	Power button		Volume button (for 300w Gen 3 and 500w Gen 3 only)
	USB 3.2 connector Gen 1		microSD card slot
	Kensington Nano security slot		

Related topics

- “USB specifications” on page 7
- “Use a microSD card” on page 17
- “Lock the computer” on page 15

Bottom



Keyboard drainage hole



Speakers



Keyboard drainage hole

Drain out liquid from your computer if you accidentally spill liquid on the keyboard.

CAUTION:

When the computer is operating, it should be placed on a hard and flat surface with its bottom area not in contact with user's bare skin. Under normal operating conditions, the temperature of the bottom surface will remain within an acceptable range as defined in IEC 62368-1, but such temperatures can still be high enough to cause discomfort or harm to the user if directly touched for over one minute at a time. As such, it is recommended that users avoid prolonged direct contact with the bottom of the computer.

Note: Some Lenovo computers include a display that can be rotated 360 degrees. When those products are used as a tablet computer, the temperatures of all the accessible parts are within an acceptable range as defined in IEC 62368-1.

Rear

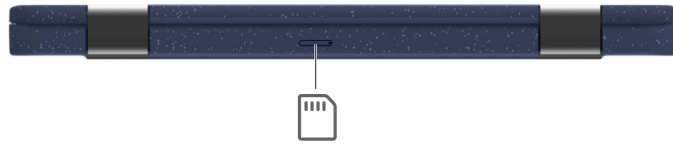

Nano-SIM-card tray (for selected models of 300w Gen 3 only)

Related topics



- “Connect to a cellular network (for selected models of 300w Gen 3 only)” on page 9

Specifications

For detailed specifications of your computer, go to <https://psref.lenovo.com> and search by product.

Microprocessor	To view the microprocessor information of your computer, right-click the Start button and then click System .
Memory	<ul style="list-style-type: none">• 100w Gen 3: Lower Power Double data rate 4 (LPDDR4), soldered on board, up to 4 GB• 300w Gen 3: LPDDR4, soldered on board, up to 8 GB• 500w Gen 3: LPDDR4X, soldered on board, up to 8 GB
Storage device	<ul style="list-style-type: none">• 100w Gen 3: Embedded Multi Media Card (eMMC), up to 128 GB• 300w Gen 3 and 500w Gen 3:<ul style="list-style-type: none">– eMMC (for selected models), up to 128 GB– 2242 M.2 solid-state drive (for selected models), up to 256 GB
Display	<ul style="list-style-type: none">• Color display with In-Plane Switching (IPS) or Twisted Nematic (TN) technology• Display ratio: 16:9• Display resolution: 1366 x 768 pixels• Multi-touch technology (for 300w Gen 3 and 500w Gen 3 only)
Security features	<ul style="list-style-type: none">• Trusted Platform Module (TPM) (for selected models)
Wireless features	<ul style="list-style-type: none">• Bluetooth• GPS (for selected models of 300w Gen 3)• Wireless LAN• Wireless WAN (4G) (for selected models of 300w Gen 3) <p>Note: The 4G cellular service is provided by authorized mobile service carriers in some countries or regions. You must have a cellular plan from a service carrier to connect to the cellular network. The cellular data plan might vary by location.</p>

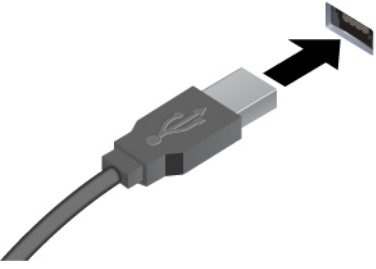
USB specifications

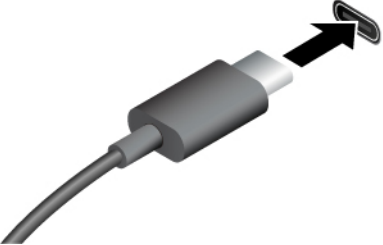
Connector name	Description
 <ul style="list-style-type: none">•  USB 3.2 connector Gen 1	<p>Connect USB-compatible devices, such as a USB keyboard, USB mouse, USB storage device, or USB printer.</p>
 <ul style="list-style-type: none">• USB-C (3.2 Gen 1) connector	<ul style="list-style-type: none">• Charges your computer.• Charge USB-C compatible devices with the output voltage and current of 5 V and 3 A.• Connect to an external display:<ul style="list-style-type: none">– USB-C to VGA: up to 1900 x 1200 pixels, 30 Hz– USB-C to DP: up to 3840 x 2160 pixels, 30 Hz• Connect to USB-C accessories to help expand your computer functionality. To purchase USB-C accessories, go to https://www.lenovo.com/accessories.

Statement on USB transfer rate

Depending on many factors such as the processing capability of the host and peripheral devices, file attributes, and other factors related to system configuration and operating environments, the actual transfer rate using the various USB connectors on this device will vary and will be slower than the data rate listed below for each corresponding device.

USB device	Data rate (Gbit/s)
3.2 Gen 1 / 3.1 Gen 1	5
3.2 Gen 2 / 3.1 Gen 2	10
3.2 Gen 2 × 2	20
Thunderbolt 3 connector (USB-C)	40
Thunderbolt 4 connector (USB-C)	40

Chapter 2. Get started with your computer

Access networks

This section helps you connect to a wireless or wired network.

Connect to Wi-Fi networks

Click the network icon in the Windows® notification area, and then select a network for connection. Provide required information, if needed.

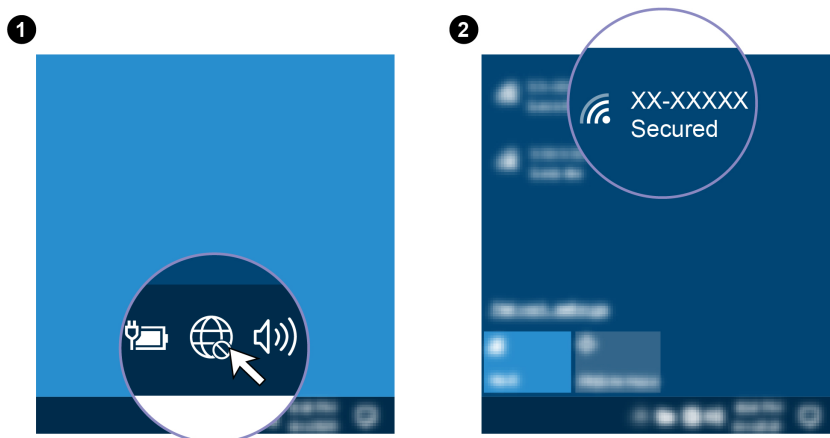

Connect to a cellular network (for selected models of 300w Gen 3 only)

If your computer has a wireless wide area network (WAN) card and a nano-SIM card installed, you can connect to a cellular data network and get online everywhere.

Note: The cellular service is provided by authorized mobile service carriers in some countries or regions. You must have a cellular plan from a service carrier to connect to the cellular network.

To establish a cellular connection:

1. Turn off the computer.
2. Locate the nano-SIM card slot and insert the nano-SIM card as shown. Note the orientation of the card and ensure that it is seated correctly.

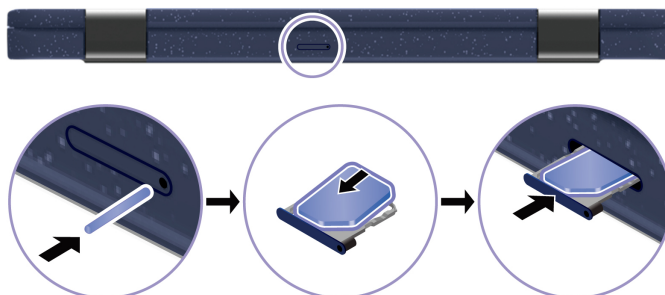

3. Turn on the computer.











- Click the network icon, and then select the cellular network icon  from the list. Provide required information, if needed.

Interact with your computer

Your computer provides you various ways to navigate the screen.

Use Hotkeys

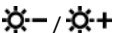
Some keys on the keyboard are printed with icons. These keys are called hotkeys and can be pressed alone or in combination with the Fn key to access certain functions or settings quickly. The functions of hotkeys are symbolized by the icons printed on them.

Hotkey	Function
	Mute / unmute the speakers. If you mute the speakers and turn off your computer, the speakers remain muted when you turn on your computer.
	Decrease / increase the volume.
	Mute / unmute the microphones.
	Refresh the current window.
	Enable / disable the touchpad.
	Turn on / turn off the airplane mode.
	Enable / disable the camera.
	Lock the current user account.
	Manage external displays.
	Decrease / increase display brightness.
Fn + 	Equal the Home key.

Use the hotkey mode

Some hotkeys share keys with functions keys (F1 to F12). The hotkey mode is a UEFI BIOS setting that changes how hotkeys (or function keys) are used.

- When the hotkey mode is enabled, press Fn together with the hotkey to use the hotkey.
- When the hotkey mode is disabled, press the hotkey directly.

Use the touch screen (for 300w Gen 3 and 500w Gen 3 only)

If your computer display supports the multi-touch function, you can navigate the screen with simple touch gestures.

Note: Some gestures might not be available depending on the app you use.



Tap once to single click



Tap twice quickly to double-click



Tap and hold to right-click

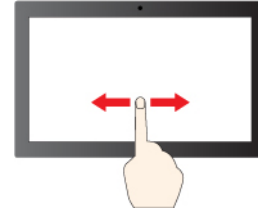

Slide to scroll through items

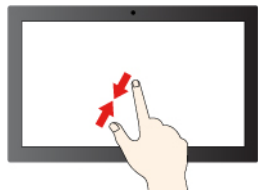

Zoom out

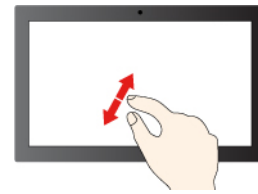

Zoom in

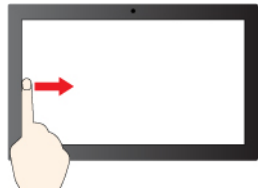

Swipe from the left: view all open windows



Swipe from the right: open action center

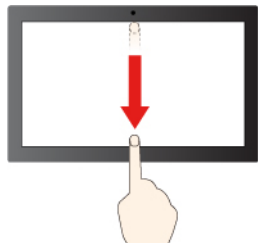

Swipe downwards shortly: show title bar

Swipe downwards: close the current app

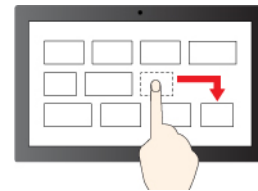

Drag

Maintenance tips:

- Turn off the computer before cleaning the multi-touch screen.
- Use a dry, soft, and lint-free cloth or a piece of absorbent cotton to remove fingerprints or dust from the multi-touch screen. Do not apply solvents to the cloth.
- The multi-touch screen is a glass panel covered with a plastic film. Do not apply pressure or place any metallic object on the screen, which might damage the touch panel or cause it to malfunction.
- Do not use fingernails, gloved fingers, or inanimate objects for input on the screen.
- Regularly calibrate the accuracy of the finger input to avoid a discrepancy.

Connect to an external display

Connect your computer to a projector or a monitor to give presentations or expand your workspace.

Connect to a wired display

If your computer cannot detect the external display, right-click a blank area on the desktop, and then click **Display settings** → **Detect**.

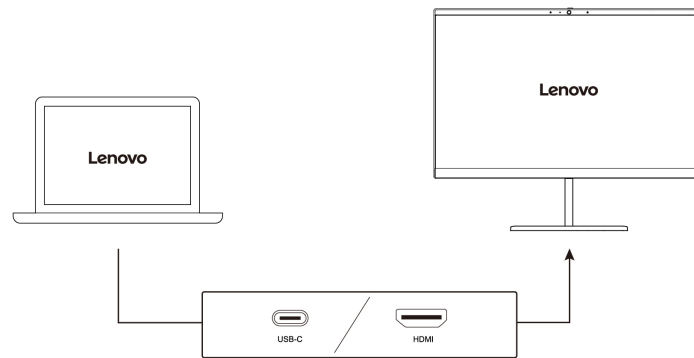



Supported resolution

The following table lists the supported maximum resolution of the external display.

Connect the external display to	Supported resolution
USB-C connector	Up to 3840 x 2160 pixels / 60 Hz
HDMI connector	Up to 3840 x 2160 pixels / 30 Hz

Connect to a wireless display

To use a wireless display, ensure that both your computer and the external display support the Miracast® feature.

Press  +  and then select a wireless display to connect with.

Set the display mode

Press F10 or Fn + F10 and then select a display mode of your preference.

Change display settings

1. Right-click a blank area on the desktop and select **Display settings**.
2. Select the display that you want to configure.
3. Change display settings of your preference.

You can change the settings for both the computer display and the external display. For example, you can define which one is the main display and which one is the secondary display. You also can change the resolution and orientation.

Get to know operating modes (for 300w Gen 3 and 500w Gen 3 only)

Rotate the display to switch among different YOGA modes according to your preference. The keyboard and the pointing devices are automatically disabled in the stand mode, tent mode, and tablet mode. Use the touch screen to control your computer instead.

Attention: Do not rotate the computer display with too much force, or apply too much force to the upper-right or upper-left corner of the computer display. Otherwise the display or hinges might get damaged.



Notebook mode



Stand mode



Tent mode



Tablet mode

Use Lenovo Integrated Pen (for selected models of 300w Gen 3 and 500w Gen 3 only)

The garaged rechargeable electronic Lenovo Integrated Pen enables a more precise and easier way of writing and sketching.

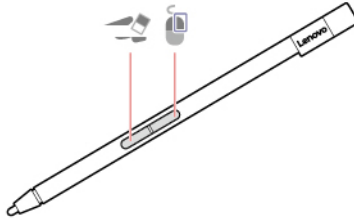

	Eraser button		Right-click button
---	---------------	---	--------------------

Notes:

- Lenovo Integrated Pen is not waterproof. Keep the pen away from water and excessive moisture.
- To purchase Lenovo Integrated Pen, go to <https://www.lenovo.com/accessories>.
- Selected models support pencil with a conductive tip. The tip diameter should be more than 2 mm. Also, the diameter of the contact area between the tip and screen should be more than 1.5 mm.

Charge Lenovo Integrated Pen

1. Ensure that your computer is on or in sleep mode.
2. Insert the pen back into the pen slot. The pen is 80% charged in about 15 seconds and 100% charged in about five minutes.

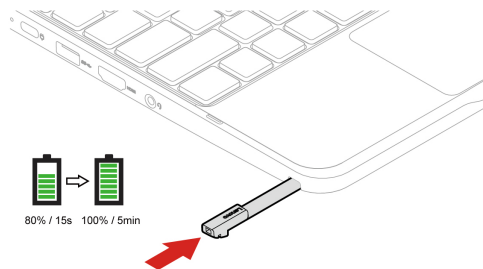

Chapter 3. Explore your computer

Lock the computer

Lock your computer to a desk, table, or other fixtures through a compatible security cable lock.

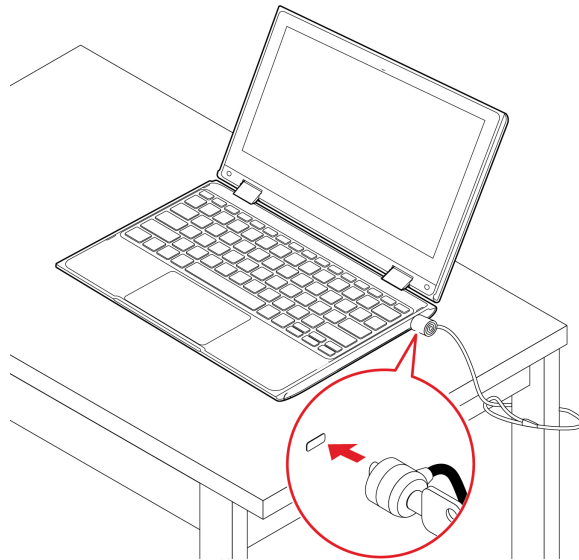

Note: The slot supports cable locks that conform to the Kensington NanoSaver® lock standards using Cleat™ locking technology. You are responsible for evaluating, selecting, and implementing the locking device and security feature. Lenovo is not responsible for the locking device and security feature. You can purchase the cable locks at <https://smartfind.lenovo.com>.

Use the Vantage app

The preinstalled Vantage app is a customized one-stop solution to help you maintain your computer with automated updates and fixes, configure hardware settings, and get personalized support.

To access the Vantage app, type Vantage in the Windows search box.

Key features

The Vantage app enables you to:

- Know the device status easily and customize device settings.
- Download and install UEFI BIOS, firmware, and driver updates to keep your computer up-to-date.
- Monitor your computer health, and secure your computer against outside threats.
- Scan your computer hardware and diagnose hardware problems.
- Look up warranty status (online).
- Access *User Guide* and helpful articles.

Notes:

- The available features vary depending on the computer model.

- The Vantage app makes periodic updates of the features to keep improving your experience with your computer. The description of features might be different from that on your actual user interface.

Manage power

Use the information in this section to achieve the best balance between performance and power efficiency.

Check the battery status

Click the battery icon in the Windows notification area to check the battery status, view the current power plan, change the power mode, and access battery settings quickly. For more details about your battery, refer to the Vantage app.

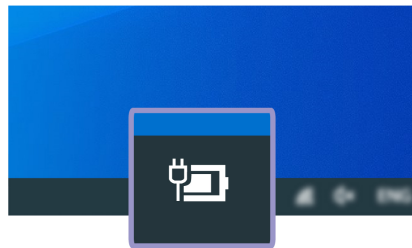

Charge the battery

Power source of the ac power adapter:

- Power: 45 W or 65 W (depending on the model)
- Sine-wave input at 50 Hz to 60 Hz
- Input rating of the ac power adapter: 100 V to 240 V ac, 50 Hz to 60 Hz

When the battery power is low, charge your battery by connecting your computer to ac power. The 65 W ac power adapter supports the rapid charge function, the battery is 80% charged in about one hour when the computer is turned off. The actual charging time depends on the battery size, the physical environment, and whether you are using the computer.

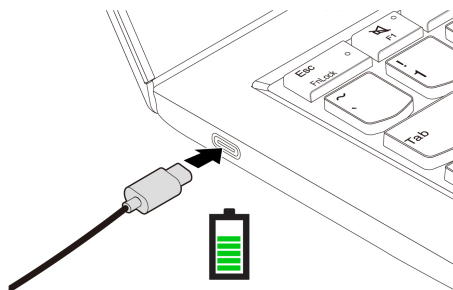

Note: To maximize the life of the battery, use the battery until the charge is depleted and recharge the battery completely before using it. Once the battery is fully charged, it must discharge to 94% or lower before it will be allowed to recharge again.

Change the power settings

For ENERGY STAR® compliant computers, the following power plan takes effect when your computer has been idle for a specified duration:

- Turn off the display: After 10 minutes
- Put the computer to sleep: After 30 minutes

To reset the power plan:

1. Right-click the battery status icon and select **Power Options**.
2. Choose or customize a power plan of your preference.

To reset the power button function:

1. Right-click the battery status icon and select **Power Options** → **Change what the power buttons do**.
2. Change the settings as you prefer.

Transfer data

Quickly share your files using the built-in Bluetooth technology among devices with the same features. You also can insert a microSD card to transfer data.

Set up a Bluetooth connection

You can connect all types of Bluetooth-enabled devices to your computer, such as a keyboard, a mouse, a smartphone, or speakers. To ensure successful connection, place the devices at most 10 meters (33 feet) from the computer.

1. Type Bluetooth in the Windows search box and then press Enter.
2. Turn on Bluetooth, if it is off.
3. Select a Bluetooth device, and then follow the on-screen instructions.

Use a microSD card

You can insert a microSD card to transfer data.

Install or remove a card

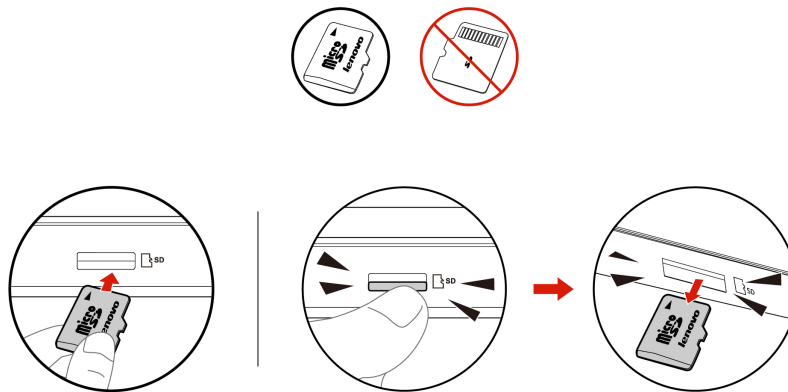

Attention: Before removing the card:

1. Click the triangular icon in the Windows notification area to show hidden icons. Right-click the icon prompting you to safely remove hardware and eject media.
2. Select the corresponding item to eject the card from the Windows operating system.
3. Press the card and remove it from your computer. Store the card safely for future use.

Chapter 4. Configure advanced settings

This chapter provides information about the UEFI (Unified Extensible Firmware Interface) BIOS (Basic Input/Output System) setup utility and system recovery information.

UEFI BIOS setup utility

UEFI BIOS setup utility is the first program that the computer runs. When the computer turns on, UEFI BIOS setup utility performs a self test to make sure that various devices in the computer are functioning.

Enter the UEFI BIOS setup utility

Restart the computer. When the logo screen is displayed, press F2 or Fn + F2 to enter the UEFI BIOS setup utility.

Change the startup sequence

You might need to change the startup sequence to allow the computer to start from another device or a network location.

1. Enter the setup utility.
2. Navigate to the **Boot** menu.
3. Follow the on-screen instructions to change the order of devices under **Boot Priority Order**.

Note: You can also change the startup sequence temporarily without opening the setup utility. To do so, start the computer. When the logo screen is displayed, press Fn + F12.

Change the hotkey mode

1. Open the setup utility.
2. Select **Configuration** → **Hotkey Mode** and press Enter.
3. Change the setting to **Disabled** or **Enabled**.
4. Select **Exit** → **Exit Saving Changes**.

Enable or disable the Always On USB function

For computer models with the Always On USB connector, the always-on function can be enabled or disabled in the setup utility.

1. Open the setup utility.
 2. Select **Configuration** → **Always On USB** and press Enter.
 3. Change the setting to **Disabled** or **Enabled**.
 4. Select **Exit** → **Exit Saving Changes**.
-

Use passwords

This section introduces the types of passwords that you can set in the setup utility.

Password types

You can set various types of passwords in the UEFI BIOS setup utility.

Notes:

- All passwords set in the setup utility consist of alphanumeric characters only.
- If you start the setup utility using the user password, you can only change a few settings.

Password type	Pre-requisite	Usage
Administrator password	No	Use the administrator password to enter the setup utility.
User password	The administrator password must be set.	Use the user password to enter the setup utility.
Master hard disk password	No	Use master hard disk password to enter the setup utility or operating system.
User hard disk password	The master hard disk password must be set.	Use the user hard disk password to enter the setup utility or operating system.

Set an administrator password

You can set the administrator password to prevent unauthorized access to the setup utility.

Attention: If you forget the administrator password, a Lenovo authorized service personnel cannot reset your password. You must take your computer to a Lenovo authorized service personnel to have the system board replaced. Proof of purchase is required and a fee will be charged for parts and service.

1. Enter the setup utility.
2. Select **Security** → **Set Administrator Password** and press Enter.
3. Enter a password string that contains only letters and numbers and then press Enter.
4. Enter the password again and press Enter.
5. Select **Exit** → **Exit Saving Changes**.

Next time you turn on the computer, you should enter the administrator password to enter the setup utility.

Change or remove the administrator password

Only the administrator can change or remove the administrator password.

1. Enter the setup utility.
2. Select **Security** → **Set Administrator Password** and press Enter.
3. Enter the current password.
4. In the **Enter New Password** field, enter the new password.
5. In the **Confirm New Password** field, enter the new password again.

Note: If you want to remove the password, leave both fields blank, and press Enter twice.

6. Select **Exit** → **Exit Saving Changes**.

If you remove the administrator password, the user password is also removed.

Set a user password

You must set the administrator password before you can set the user password. The system administrator might need to set a user password so that other users can access the computer.

1. Enter the setup utility.
2. Select **Security → Set User Password** and press Enter.
3. Enter a password string that contains only letters and numbers and then press Enter.

Note: The user password should be different from the administrator password.

4. Enter the password again and press Enter.
5. Select **Exit → Exit Saving Changes**.

Change or remove the user password

1. Enter the setup utility.
2. Select **Security → Set User Password** and press Enter.
3. Enter the current password.
4. In the **Enter New Password** field, enter the new password.
5. In the **Confirm New Password** field, enter the new password again.

Note: If you want to remove the password, leave both fields blank, and press Enter twice.

6. Select **Exit → Exit Saving Changes**.

Enable the power on password

If the administrator password has been set, you can enable the power on password to enforce stronger security.

1. Enter the setup utility.
2. Select **Security → Power on Password** and press Enter.

Note: The administrator password must be set in advance.

3. Change the setting to **Enabled**.
4. Select **Exit → Exit Saving Changes**.

If the power on password is enabled, you must enter the administrator password or user password every time you enter the setup utility.

Set a hard disk password

You can set a hard disk password in the setup utility to prevent unauthorized access to your data.

Attention: Be extremely careful when setting a hard disk password. If you forget the master hard disk password, a Lenovo authorized service personnel cannot reset your password or recover data from the hard disk. You must take your computer to a Lenovo authorized service personnel to have the hard disk drive replaced. Proof of purchase is required and a fee will be charged for parts and service.

Notes:

- If you start the setup utility using the user password, you cannot set the hard disk password.
- The master hard disk password and user hard disk password must be set at the same time.
 1. Enter the setup utility.
 2. Select **Security → Set Hard Disk Password** and press Enter.
 3. Follow the on-screen instructions to set both the master hard disk password and user hard disk password.
 4. Select **Exit → Exit Saving Changes**.

If the hard disk password is set, you must enter the password to enter the setup utility or the operating system.

Change or remove the hard disk password

1. Enter the setup utility.
2. Select **Security**.
3. To change or remove the hard disk password, do one of the following:
 - To change or remove the master hard disk password, select **Change Master Password** and press Enter.

Notes:

- If you remove the master hard disk password, the user hard disk password is also removed.
 - The user hard disk password cannot be removed separately.
 - To change the user hard disk password, select **Change User Password** and press Enter.
4. Select **Exit** → **Exit Saving Changes**.

Recovery information

This section introduces the recovery information of the Windows 10 operating system. Ensure that you read and follow the on-screen recovery instructions. The data on your computer might be deleted during the recovery process. To avoid data loss, make a backup copy of all the data that you want to keep.

Restore system files and settings to an earlier point

1. Go to **Control Panel** and view by Large icons or Small icons.
2. Click **Recovery** → **Open System Restore**. Then, follow the on-screen instructions.

Restore your files from a backup

Note: If you use the File History tool to restore your files from a backup, ensure that you backed up your data earlier with the tool.

1. Go to **Control Panel** and view by Large icons or Small icons.
2. Click **File History** → **Restore personal files**. Then, follow the on-screen instructions.

Reset your computer

In the resetting process, you can choose to keep your files or remove them when you reinstall the operating system.

Note: The items in the graphical user interface (GUI) might change without notice.

1. Open the **Start** menu, and then click **Settings** → **Update & Security** → **Recovery**.
2. In the **Reset this PC** section, click **Get started**.
3. Follow the on-screen instructions to reset your computer.

Use advanced options

Note: The items in the graphical user interface (GUI) might change without notice.

1. Open the **Start** menu, and then click **Settings** → **Update & security** → **Recovery**.
2. In the **Advanced startup** section, click **Restart now** → **Troubleshoot** → **Advanced options**.
3. Select a preferred option, and then follow the on-screen instructions.

Windows automatic recovery

Note: Ensure that your computer is connected to ac power during the recovery process.

The Windows recovery environment on your computer operates independently from the Windows 10 operating system. It enables you to recover or repair the operating system even if the Windows 10 operating system fails to start.

After two consecutive failed boot attempts, the Windows recovery environment starts automatically. Then you can choose repair and recovery options by following the on-screen instructions.

Create and use a recovery USB device

It is recommended that you create a recovery USB drive as early as possible as a backup for the Windows recovery programs. With the recovery USB drive, you can troubleshoot and fix the problems even if the preinstalled Windows recovery programs are damaged. If you did not create a recovery USB drive as a precautionary measure, you can contact Lenovo Customer Support Center and purchase one from Lenovo. For a list of the Lenovo Support phone numbers for your country or region, go to:

<https://pcsupport.lenovo.com/supportphonenumberlist>

Create a recovery USB drive

Attention: The creation process deletes anything stored on the USB drive. To avoid data loss, make a backup copy of all the data that you want to keep.

1. Ensure that your computer is connected to ac power.
2. Prepare a USB drive with at least 16 GB of storage capacity. The actual USB capacity required depends on the size of the recovery image.
3. Connect the prepared USB drive to the computer.
4. Type *recovery* in the search box. Then, click **Create a recovery drive**.
5. Click **Yes** in the User Account Control window to allow the Recovery Media Creator program to start.
6. In the Recovery Drive window, follow the on-screen instructions to create a recovery USB drive.

Use the recovery USB drive

1. Ensure that your computer is connected to ac power.
2. Connect the recovery USB drive to the computer.
3. Turn on or restart the computer. When the logo screen is displayed, press F12. The Boot Menu window opens.
4. Select the recovery USB drive as the boot device. Then, follow the on-screen instructions to complete the process.

Install a Windows operating system and drivers

This section provides instructions on installing a Windows operating system and device drivers.

Install a Windows operating system

Microsoft constantly makes updates to the Windows operating system. Before installing a particular Windows version, check the compatibility list for the Windows version. For details, go to <https://support.lenovo.com/us/en/solutions/windows-support>.

Attention:

- It is recommended that you update your operating system through official channels. Any unofficial update might cause security risks.
 - The process of installing a new operating system deletes all the data on your internal storage drive, including the data stored in a hidden folder.
1. If you are using the Windows BitLocker® Drive Encryption feature and your computer has a Trusted Platform Module, ensure that you have disabled the feature.
 2. Ensure that the security chip is set to **Enabled**.
 - a. Restart the computer. When the logo screen is displayed, press F2 or Fn + F2 to enter the setup utility.
 - b. Select **Security** and ensure security chip is set to **Enabled**.
 - c. Press Fn+F10 to save the settings and exit.
 3. Connect the drive that contains the operating system installation program to the computer.
 4. Restart the computer. When the logo screen is displayed, press F2 or Fn + F2 to enter the setup utility.
 5. Select **Boot → Edit Boot Order** to display the **Boot Priority Order** submenu.
 6. Select the drive that contains the operating system installation program, for example, **USB HDD**. Press Fn+F6 to move the drive to the first order. Then, press Fn+F10 to save the setting and exit.

Attention: After you change the startup sequence, ensure that you select the correct device during a copy, a save, or a format operation. If you select the wrong device, the data on that device might be erased or overwritten.
 7. The system restarts. Follow the on-screen instructions to install the device drivers and necessary programs.
 8. After installing the device drivers, apply Windows Update to get the latest updates, for example the security patches.

Install device drivers

You should download the latest driver for a component when you notice poor performance from that component or when you added a component. This action might eliminate the driver as the potential cause of a problem. Download and install the latest driver by one of the following methods:

- Open the Vantage app to check the available update packages. Select the update packages you want, and then follow the on-screen instructions to download and install the packages.
- Go to <https://pcsupport.lenovo.com> and select the entry for your computer. Then, follow the on-screen instructions to download and install necessary drivers and software.

Use firewalls and antivirus programs

Your computer might be preinstalled with a firewall program. The firewall protects against computer Internet security threats, unauthorized access, intrusions, and Internet attacks. It also protects your privacy.

A full version of the antivirus program is provided with a free 30-day subscription. After 30 days, you must renew the license to continue receiving the antivirus program updates.

For more information, see the help system of the program.

Chapter 5. CRU replacement

Customer Replaceable Units (CRUs) are parts that can be upgraded or replaced by the customer. The computers contain the following types of CRUs:

- **Self-service CRUs:** Refer to parts that can be installed or replaced easily by customer themselves or by trained service technicians at an additional cost.
- **Optional-service CRUs:** Refer to parts that can be installed or replaced by customers with a greater skill level. Trained service technicians can also provide service to install or replace the parts under the type of warranty designated for the customer's machine.

If you intend on installing a CRU, Lenovo will ship the CRU to you. CRU information and replacement instructions are shipped with your product and are available from Lenovo at any time upon request. You might be required to return the defective part that is replaced by the CRU. When return is required: (1) return instructions, a prepaid shipping label, and a container will be included with the replacement CRU; and (2) you might be charged for the replacement CRU if Lenovo does not receive the defective CRU within thirty (30) days of your receipt of the replacement CRU. For full details, see the Lenovo Limited Warranty documentation at https://www.lenovo.com/warranty/llw_02.

CRU list

The following is a list of CRUs of your computer.

Self-service CRUs

- ac power adapter
- Pen dummy (for selected models of 300w Gen 3 and 500w Gen 3)
- Lenovo Integrated Pen (for selected models of 300w Gen 3 and 500w Gen 3)
- Nano-SIM-card tray (for selected models of 300w Gen 3)
- Power cord

Optional-service CRUs

- Base cover assembly
- Coin-cell battery
- M.2 Solid-state drive (for selected models of 300w Gen 3 and 500w Gen 3)
- Wireless WAN card (for selected models of 300w Gen 3)

Note: Replacement of any parts not listed above, including the built-in rechargeable battery, must be done by a Lenovo-authorized repair facility or technician. Go to <https://support.lenovo.com/partnerlocation> for more information.

Disable Fast Startup and the built-in battery

Before replacing any CRU, ensure that you disable Fast Startup first and then disable the built-in battery.

To disable Fast Startup:

1. Go to **Control Panel** and view by Large icons or Small icons.
2. Click **Power Options**, and then click **Choose what the power buttons do** on the left pane.
3. Click **Change settings that are currently unavailable** at the top.

4. If prompted by User Account Control (UAC), click **Yes**.
5. Clear the **Turn on fast startup** check box, and then click **Save changes**.

To disable the built-in battery:

1. Enter the setup utility.
2. Select **Configuration** → **Disable Built-in Battery** and press Enter.
3. Select **Yes** in the Setup Confirmation window. The built-in battery is disabled and the computer turns off automatically. Wait three to five minutes to let the computer cool.

Replace a CRU

Follow the replacement procedure to replace a CRU.

Pen dummy (for selected models of 300w Gen 3 and 500w Gen 3)

For computer models come with a pen dummy, you can purchase a Lenovo Integrated Pen to use. To purchase the pen, go to <https://www.lenovo.com/accessories>. To use the pen, see “Use Lenovo Integrated Pen (for selected models of 300w Gen 3 and 500w Gen 3 only)” on page 14.

Prerequisite

Before you start, read [Generic Safety and Compliance Notices](#) and print the following instructions.

For access, do the following:

1. Ensure that your computer is off or in sleep mode. Disconnect the computer from ac power and all connected cables.
2. Close the computer display and turn the computer over.

Removal procedure

Use a tool as shown to release the pen dummy, then remove it.

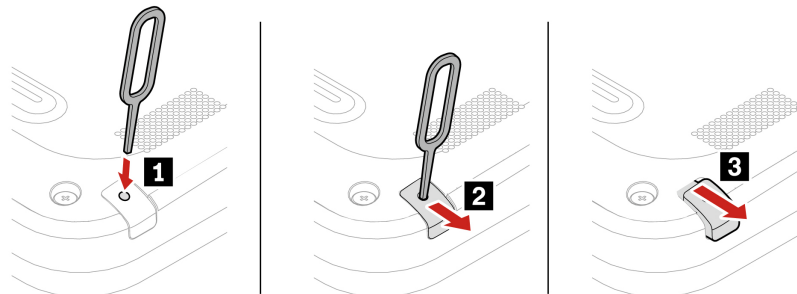

Base cover assembly

Prerequisite

Before you start, read [Generic Safety and Compliance Notices](#) and print the following instructions.

Note: Do not remove the base cover assembly when your computer is connected to ac power. Otherwise, there might be a risk of short circuits.

For access, do the following:

1. Disable the built-in battery. See “Disable Fast Startup and the built-in battery” on page 25.
2. Turn off the computer and disconnect the computer from ac power and all connected cables.
3. Close the computer display and turn over the computer.

Removal procedure

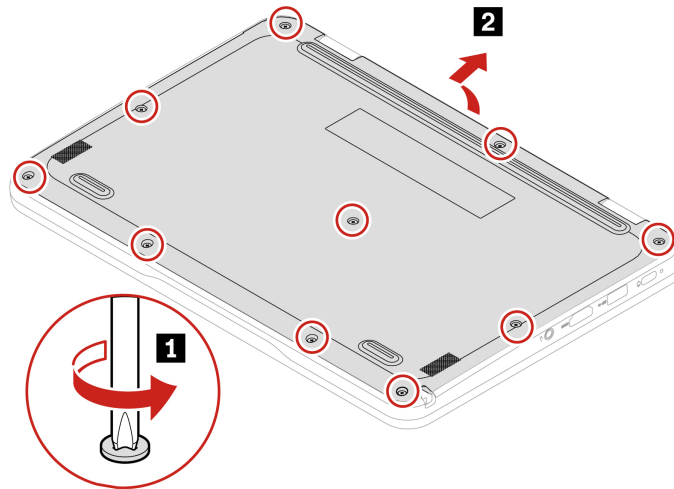

Installation procedure

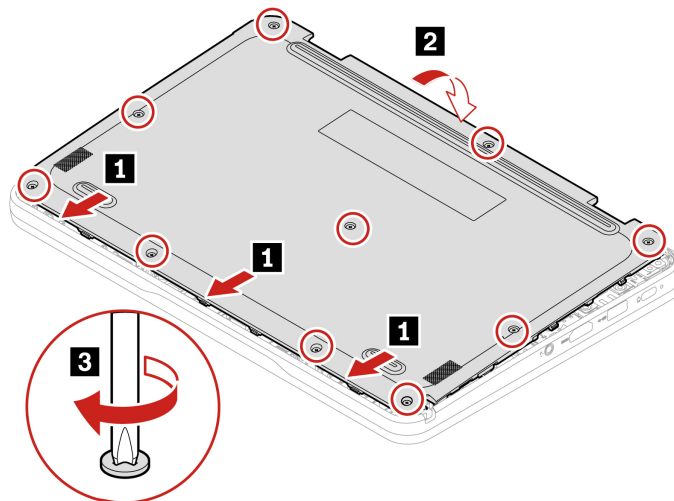

Troubleshooting

If the computer does not start up after you reinstall the base cover assembly, disconnect the ac power adapter and then reconnect it to the computer.

Wireless WAN card (for selected models of 300w Gen 3 only)

The following information is only for the computer with user-installable modules. Ensure that you use only a Lenovo-authorized wireless module specifically tested for this computer model. Otherwise, the computer will generate an error-code beep sequence when you turn on the computer.

Prerequisite

Before you start, read [Generic Safety and Compliance Notices](#) and print the following instructions.

Attention: Do not touch the contact edge of the wireless WAN card. Otherwise, the wireless WAN card might get damaged.

For access, do the following:

1. Disable the built-in battery. See “Disable Fast Startup and the built-in battery” on page 25.
2. Turn off the computer and disconnect the computer from ac power and all connected cables.
3. Close the computer display and turn the computer over.
4. Remove the base cover assembly. See “Base cover assembly” on page 26.

Removal procedure

Note: A Mylar film might cover the wireless WAN card. To access the wireless WAN card, peel off the film first.

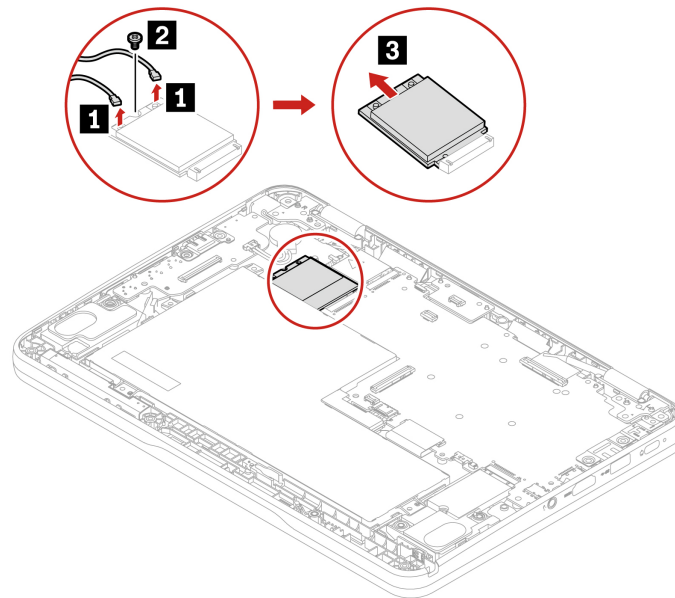

M.2 solid-state drive (for selected models of 300w Gen 3 and 500w Gen 3)

Prerequisite

Before you start, read [Generic Safety and Compliance Notices](#) and print the following instructions.

Attention: If you replace a M.2 solid-state drive, you might need to install a new operating system. For details on how to install a new operating system, see “Install a Windows operating system and drivers” on page 23.

The M.2 solid-state drive is sensitive. Inappropriate handling might cause damage and permanent loss of data.

When handling the M.2 solid-state drive, observe the following guidelines:

- Replace the M.2 solid-state drive only for upgrade or repair. The M.2 solid-state drive is not designed for frequent changes or replacement.
- Before replacing the M.2 solid-state drive, make a backup copy of all the data that you want to keep.
- Do not apply pressure to the M.2 solid-state drive.

- Do not touch the contact edge or circuit board of the M.2 solid-state drive. Otherwise, the M.2 solid-state drive might get damaged.
- Do not make the M.2 solid-state drive subject to physical shocks or vibration. Put the M.2 solid-state drive on a soft material, such as cloth, to absorb physical shocks.

For access, do the following:

1. Disable the built-in battery. See “Disable Fast Startup and the built-in battery” on page 25.
2. Turn off the computer and disconnect the computer from ac power and all connected cables.
3. Close the computer display and turn the computer over.
4. Remove the base cover assembly. See “Base cover assembly” on page 26.

Note: If your M.2 solid-state drive comes with a thermal pad, peel off it from the M.2 solid-state drive and attach it to the new M.2 solid-state drive.

Removal procedure

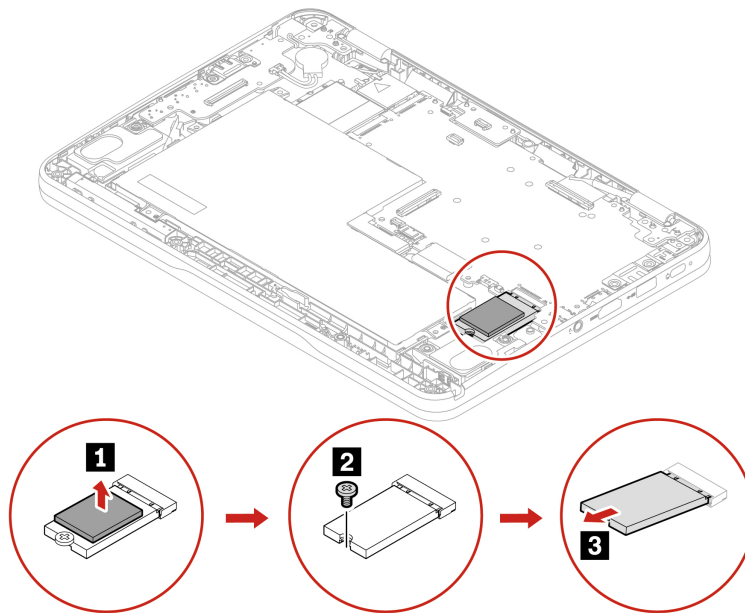

Installation procedure

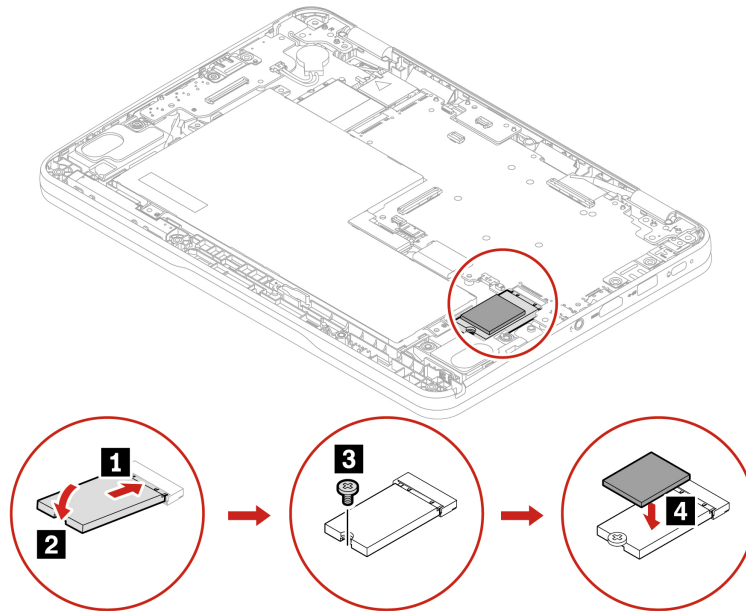

Coin-cell battery

Prerequisite

Before you start, read [Generic Safety and Compliance Notices](#) and print the following instructions.

For access, do the following:

1. Disable the built-in battery. See “Disable Fast Startup and the built-in battery” on page 25.
2. Turn off the computer and disconnect the computer from ac power and all connected cables.
3. Close the computer display and turn the computer over.
4. Remove the base cover assembly. See “Base cover assembly” on page 26.

Removal procedure

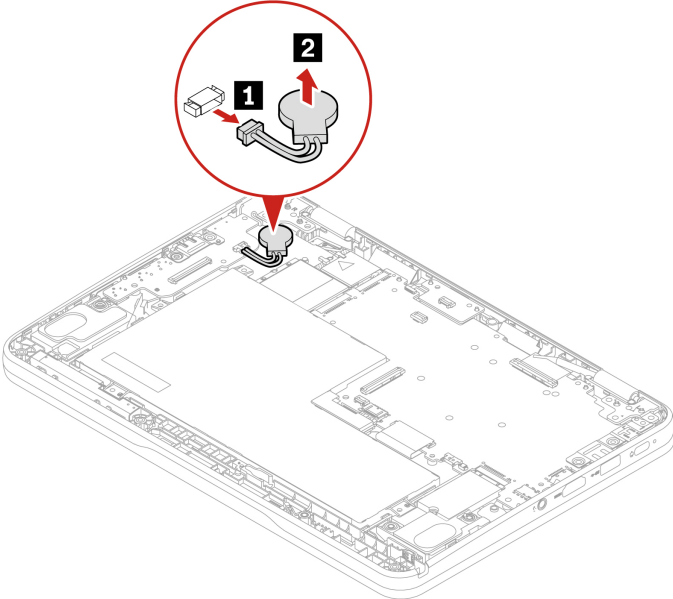

Chapter 6. Help and support

Frequently asked questions

How do I open the Control Panel?	Type Control Panel in the Windows search box and then press Enter.
How should I turn off my computer?	Open the Start menu and select Power → Shut down .
How do I partition my storage drive?	Refer to https://support.lenovo.com/solutions/ht503851 .
What should I do if my computer stops responding?	Press and hold the power button until the computer turns off. Then restart the computer.
What should I do if I spill liquid on the computer?	<ol style="list-style-type: none">1. Carefully unplug the ac power adapter and turn off the computer immediately. The more quickly you stop the current from passing through the computer the more likely you will reduce damage from short circuits. Attention: Although you might lose some data or work by turning off the computer immediately, leaving the computer on might make your computer unusable.2. Wait until you are certain that all the liquid is dry before turning on your computer. CAUTION: Do not try to drain out the liquid by turning over the computer. If your computer has keyboard drainage holes on the bottom, the liquid will be drained out through the holes.
Where can I get the latest device drivers and UEFI BIOS?	<ul style="list-style-type: none">• The Vantage app• Lenovo Support Web site at https://support.lenovo.com
How do I disinfect my computer?	<ol style="list-style-type: none">1. Squeeze out excess liquid from wipe or disinfecting cloth before using. Recommended wipes are hydrogen peroxide wipes and alcohol based wipes. Do not use wipes containing sodium hypochlorite (bleach).2. Gently wipe the computer thoroughly, being careful to ensure no liquid drips into the computer. Do not wipe on connector pins.3. After disinfecting, follow the cleaning procedure from the wipe supplier to minimize chemical buildup of disinfectant residue.4. Always allow the computer to completely dry prior to any use.

Self-help resources

Use the following self-help resources to learn more about the computer and troubleshoot problems.

Resources	How to access?
Troubleshooting and FAQ	<ul style="list-style-type: none">• https://www.lenovo.com/tips• https://forums.lenovo.com
Accessibility information	https://www.lenovo.com/accessibility
Reset or restore Windows	<ul style="list-style-type: none">• Use Lenovo recovery options.<ol style="list-style-type: none">1. Go to https://support.lenovo.com/HowToCreateLenovoRecovery.2. Follow the on-screen instructions.• Use Windows recovery options.<ol style="list-style-type: none">1. Go to https://pcsupport.lenovo.com.2. Detect your computer or manually select your computer model.3. Click Diagnostics → Operating System Diagnostics and then follow the on-screen instructions.
Use the Vantage app to:	
<ul style="list-style-type: none">• Configure device settings.• Download and install UEFI BIOS, drivers, and firmware updates.• Secure your computer from outside threats.• Diagnose hardware problems.• Check the computer warranty status.• Access <i>User Guide</i> and helpful articles.	Type Vantage in the Windows search box and then press Enter.
Product documentation:	
<ul style="list-style-type: none">• <i>Safety and Warranty Guide</i>• <i>Generic Safety and Compliance Notices</i>• <i>Setup Guide</i>• <i>This User Guide</i>• <i>Regulatory Notice</i>	Go to https://pcsupport.lenovo.com . Then, follow the on-screen instructions to filter out the documentation you want.

Resources	How to access?
<p>Lenovo Support Web site with the latest support information of the following:</p> <ul style="list-style-type: none"> • Drivers and software • Diagnostic solutions • Product and service warranty • Product and parts details • Knowledge base and frequently asked questions 	<p>https://pcsupport.lenovo.com</p>
<p>Windows help information</p>	<ul style="list-style-type: none"> • Open the Start menu and click Get Help or Tips. • Use Windows Search or the Cortana® personal assistant. • Microsoft support Web site: https://support.microsoft.com

Windows label

Your computer might have a Windows Genuine Microsoft label affixed to its cover depending on the following factors:

- Your geographic location
- Edition of Windows that is preinstalled

Go to <https://www.microsoft.com/en-us/howtotell/Hardware.aspx> for illustrations of the various types of Genuine Microsoft labels.

- In the People's Republic of China, the Genuine Microsoft label is required on all computer models preinstalled with any version of Windows operating system.
- In other countries and regions, the Genuine Microsoft label is required only on computer models licensed for Windows 10 Pro.

The absence of a Genuine Microsoft label does not indicate that the preinstalled Windows version is not genuine. For details on how to tell whether your preinstalled Windows product is genuine, refer to the information provided by Microsoft at <https://www.microsoft.com/en-us/howtotell/default.aspx>.

There are no external, visual indicators of the Product ID or Windows version for which the computer is licensed. Instead, the Product ID is recorded in the computer firmware. Whenever a Windows product is installed, the installation program checks the computer firmware for a valid, matching Product ID to complete the activation.

In some cases, an earlier Windows version might be preinstalled under the terms of the Windows 10 Pro license downgrade rights.

Call Lenovo

If you have tried to correct the problem yourself and still need help, you can call Lenovo Customer Support Center.

Before you contact Lenovo

Prepare the following before you contact Lenovo:

1. Record the problem symptoms and details:

- What is the problem? Is it continuous or intermittent?
- Any error message or error code?
- What operating system are you using? Which version?
- Which software applications were running at the time of the problem?
- Can the problem be reproduced? If so, how?

2. Record the system information:

- Product name
- Machine type and serial number

The following illustration shows where to find the machine type and serial number of your computer.



Lenovo Customer Support Center

During the warranty period, you can call Lenovo Customer Support Center for help.

Telephone numbers

For a list of the Lenovo Support phone numbers for your country or region, go to <https://pcsupport.lenovo.com/supportphonenumber> for the latest phone numbers.

Note: Phone numbers are subject to change without notice. If the number for your country or region is not provided, contact your Lenovo reseller or Lenovo marketing representative.

Services available during the warranty period

- Problem determination - Trained personnel are available to assist you with determining if you have a hardware problem and deciding what action is necessary to fix the problem.
- Lenovo hardware repair - If the problem is determined to be caused by Lenovo hardware under warranty, trained service personnel are available to provide the applicable level of service.
- Engineering change management - Occasionally, there might be changes that are required after a product has been sold. Lenovo or your reseller, if authorized by Lenovo, will make selected Engineering Changes (ECs) that apply to your hardware available.

Services not covered

- Replacement or use of parts not manufactured for or by Lenovo or nonwarranted parts
- Identification of software problem sources
- Configuration of UEFI BIOS as part of an installation or upgrade
- Changes, modifications, or upgrades to device drivers
- Installation and maintenance of network operating systems (NOS)
- Installation and maintenance of programs

For the terms and conditions of the Lenovo Limited Warranty that apply to your Lenovo hardware product, go to:

- https://www.lenovo.com/warranty/llw_02
- <https://pcsupport.lenovo.com/warrantylookup>

Appendix A. Accessibility and ergonomic information

This chapter provides information about accessibility and ergonomics.

Accessibility information

Lenovo is committed to providing users who have hearing, vision, and mobility limitations with greater access to information and technology. You can get the most up-to-date accessibility information from <https://www.lenovo.com/accessibility>.

If you need additional support with the accessibility features, go to <https://pcsupport.lenovo.com/supportphonenumber> to find the support phone numbers for your country or region.

Ergonomic information

Good ergonomic practice is important to get the most from your personal computer and to avoid discomfort. Arrange your workplace and the equipment you use to suit your individual needs and the kind of work that you perform. In addition, use healthy work habits to maximize your performance and comfort when using your computer.

Working in the virtual office might mean adapting to frequent changes in your environment. Adapting to the surrounding light sources, active seating, and the placement of your computer hardware, can help you improve your performance and achieve greater comfort.

This example shows someone in a conventional setting. Even when not in such a setting, you can follow many of these tips. Develop good habits, and they will serve you well.



General posture: Make minor modifications in your working posture to deter the onset of discomfort caused by long periods of working in the same position. Frequent short breaks from your work also help to prevent minor discomfort associated with your working posture.

Display: Position the display to maintain a comfortable viewing distance of 510 mm to 760 mm (20 inches to 30 inches). Avoid glare or reflections on the display from overhead lighting or outside sources of light. Keep the display screen clean and set the brightness to levels that enable you to see the screen clearly. Press the brightness control keys to adjust display brightness.

Head position: Keep your head and neck in a comfortable and neutral (vertical, or upright) position.

Chair: Use a chair that gives you good back support and seat height adjustment. Use chair adjustments to best suit your comfort posture.

Arm and hand position: If available, use chair arm rests or an area on your working surface to provide weight support for your arms. Keep your forearms, wrists, and hands in a relaxed and neutral (horizontal) position. Type with a soft touch without pounding the keys.

Leg position: Keep your thighs parallel to the floor and your feet flat on the floor or on a footrest.

What if you are traveling?

It might not be possible to observe the best ergonomic practices when you are using your computer while on the move or in a casual setting. Regardless of the setting, try to observe as many of the tips as possible. Sitting properly and using adequate lighting, for example, helps you maintain desirable levels of comfort and performance. If your work area is not in an office setting, ensure to take special note of employing active sitting and taking work breaks. Many product solutions are available to help you modify and expand your computer to best suit your needs. You can find some of these options at <https://www.lenovo.com/accessories>. Explore your options for docking solutions and external products that provide the adjustability and features that you want.

Questions about vision?

The visual display screens of notebook computers are designed to meet the highest standards. These visual display screens provide you with clear, crisp images and large, bright displays that are easy to see, yet easy on the eyes. Any concentrated and sustained visual activity can be tiring. If you have questions on eye fatigue or visual discomfort, consult a vision-care specialist for advice.

Appendix B. Compliance information

For compliance information, refer to *Regulatory Notice* at <https://pcsupport.lenovo.com> and *Generic Safety and Compliance Notices* at https://pcsupport.lenovo.com/docs/generic_notices.

Locate the wireless antennas

Your computer has a wireless antenna system. You can enable wireless communication wherever you are.

The following illustrations show the antenna locations on your computer:

100w Gen 3, 500w Gen 3, and wireless LAN model of 300w Gen 3:



- a** Wireless LAN antenna (auxiliary)
- b** Wireless LAN antenna (main)

Wireless WAN model of 300w Gen 3:



- a** Wireless WAN antenna (auxiliary)
- b** Wireless LAN antenna (auxiliary)
- c** Wireless WAN antenna (main)
- d** Wireless LAN antenna (main)

Federal Communications Commission (FCC) Supplier’s Declaration of Conformity

The following information refers to Lenovo 100w Gen 3, Lenovo 300w Gen 3, and Lenovo 500w Gen 3.

Product name	Machine types
Lenovo 100w Gen 3	82HY and 82J0
Lenovo 300w Gen 3	82J1 and 82J2
Lenovo 500w Gen 3	82J3 and 82J4

This equipment has been tested and found to comply with the limits for a Class B digital device, pursuant to Part 15 of the FCC Rules. These limits are designed to provide reasonable protection against harmful

interference in a residential installation. This equipment generates, uses, and can radiate radio frequency energy and, if not installed and used in accordance with the instructions, may cause harmful interference to radio communications. However, there is no guarantee that interference will not occur in a particular installation. If this equipment does cause harmful interference to radio or television reception, which can be determined by turning the equipment off and on, the user is encouraged to try to correct the interference by one or more of the following measures:

- Reorient or relocate the receiving antenna.
- Increase the separation between the equipment and receiver.
- Connect the equipment into an outlet on a circuit different from that to which the receiver is connected.
- Consult an authorized dealer or service representative for help.

Lenovo is not responsible for any radio or television interference caused by using other than recommended cables and connectors or by unauthorized changes or modifications to this equipment. Unauthorized changes or modifications could void the user's authority to operate the equipment.

This device complies with Part 15 of the FCC Rules. Operation is subject to the following two conditions: (1) this device may not cause harmful interference, and (2) this device must accept any interference received, including interference that may cause undesired operation.

Responsible Party:
Lenovo (United States) Incorporated
7001 Development Drive
Morrisville, NC 27560
Email: FCC@lenovo.com



Korea radio frequency compliance statement

무선설비 전파 혼신 (사용주파수 2400 ~ 2483.5 , 5725 ~ 5825 무선제품해당)

해당 무선설비가 전파혼신 가능성이 있으므로 인명안전과 관련된 서비스는 할 수 없음

SAR 정보

본 장치는 전파 노출에 대한 가이드라인을 충족합니다.

본 장치는 무선 송수신기입니다. 본 장치는 국제 가이드라인으로 권장되는 전파 노출에 대한 제한을 초과하지 않도록 설계되었습니다. 장치 액세서리 및 최신 부품을 사용할 경우 SAR 값이 달라질 수 있습니다. SAR 값은 국가 보고 및 테스트 요구 사항과 네트워크 대역에 따라 다를 수 있습니다. 본 장치는 사람의 신체에서 20mm 이상의 거리에서 사용할 수 있습니다.

Operating environment

Maximum altitude (without pressurization)

3048 m (10 000 ft)

Temperature

- Operating: 5°C to 35°C (41°F to 95°F)
- Storage: 5°C to 43°C (41°F to 109°F)

Note: When you charge the battery, its temperature must be no lower than 10°C (50°F).

Relative humidity

- Operating: 8% to 95% at wet-bulb temperature 23°C (73°F)
- Storage: 5% to 95% at wet-bulb temperature 27°C (81°F)

Appendix C. Notices and trademarks

Notices

Lenovo may not offer the products, services, or features discussed in this document in all countries. Consult your local Lenovo representative for information on the products and services currently available in your area. Any reference to a Lenovo product, program, or service is not intended to state or imply that only that Lenovo product, program, or service may be used. Any functionally equivalent product, program, or service that does not infringe any Lenovo intellectual property right may be used instead. However, it is the user's responsibility to evaluate and verify the operation of any other product, program, or service.

Lenovo may have patents or pending patent programs covering subject matter described in this document. The furnishing of this document does not give you any license to these patents. You can send license inquiries, in writing, to:

*Lenovo (United States), Inc.
8001 Development Drive
Morrisville, NC 27560
U.S.A.
Attention: Lenovo Director of Licensing*

LENOVO PROVIDES THIS PUBLICATION "AS IS" WITHOUT WARRANTY OF ANY KIND, EITHER EXPRESS OR IMPLIED, INCLUDING, BUT NOT LIMITED TO, THE IMPLIED WARRANTIES OF NON-INFRINGEMENT, MERCHANTABILITY OR FITNESS FOR A PARTICULAR PURPOSE. Some jurisdictions do not allow disclaimer of express or implied warranties in certain transactions, therefore, this statement may not apply to you.

Changes are made periodically to the information herein; these changes will be incorporated in new editions of the publication. To provide better service, Lenovo reserves the right to improve and/or modify the products and software programs described in the manuals included with your computer, and the content of the manual, at any time without additional notice.

The software interface and function and hardware configuration described in the manuals included with your computer might not match exactly the actual configuration of the computer that you purchase. For the configuration of the product, refer to the related contract (if any) or product packing list, or consult the distributor for the product sales. Lenovo may use or distribute any of the information you supply in any way it believes appropriate without incurring any obligation to you.

The products described in this document are not intended for use in implantation or other life support applications where malfunction may result in injury or death to persons. The information contained in this document does not affect or change Lenovo product specifications or warranties. Nothing in this document shall operate as an express or implied license or indemnity under the intellectual property rights of Lenovo or third parties. All information contained in this document was obtained in specific environments and is presented as an illustration. The result obtained in other operating environments may vary.

Lenovo may use or distribute any of the information you supply in any way it believes appropriate without incurring any obligation to you.

Any references in this publication to non-Lenovo Web sites are provided for convenience only and do not in any manner serve as an endorsement of those Web sites. The materials at those Web sites are not part of the materials for this Lenovo product, and use of those Web sites is at your own risk.

Any performance data contained herein was determined in a controlled environment. Therefore, the result obtained in other operating environments may vary significantly. Some measurements may have been made on development-level systems and there is no guarantee that these measurements will be the same on generally available systems. Furthermore, some measurements may have been estimated through extrapolation. Actual results may vary. Users of this document should verify the applicable data for their specific environment.

This document is copyrighted by Lenovo and is not covered by any open source license, including any Linux agreement(s) which may accompany software included with this product. Lenovo may update this document at any time without notice.

For the latest information or any questions or comments, contact or visit the Lenovo Web site:

<https://pcsupport.lenovo.com>

Trademarks

LENOVO and LENOVO logo are trademarks of Lenovo. ENERGY STAR and the ENERGY STAR mark are registered trademarks owned by the U.S. Environmental Protection Agency, Inc. Intel and Thunderbolt are trademarks of Intel Corporation or its subsidiaries in the U.S. and/or other countries. NanoSaver and Cleat are trademarks or registered trademarks of ACCO Brands. Microsoft, Windows, BitLocker, and Cortana are trademarks of the Microsoft group of companies. The terms HDMI and HDMI High-Definition Multimedia Interface are trademarks or registered trademarks of HDMI Licensing LLC in the United States and other countries. Wi-Fi and Miracast are registered trademarks of Wi-Fi Alliance. USB-C® is a registered trademark of USB Implementers Forum. All other trademarks are the property of their respective owners. © 2021 Lenovo.

Lenovo