



Simply Better Connections

ATEN VanCryst™

RBS Panel & Configurator

ATEN Room Booking System

User Manual

Compliance Statements

FEDERAL COMMUNICATIONS COMMISSION INTERFERENCE STATEMENT

This equipment has been tested and found to comply with the limits for a Class A digital device, pursuant to Part 15 of the FCC Rules. These limits are designed to provide reasonable protection against harmful interference when the equipment is operated in a commercial environment. This equipment generates, uses, and can radiate radio frequency energy and, if not installed and used in accordance with the instruction manual, may cause harmful interference to radio communications. Operation of this equipment in a residential area is likely to cause harmful interference in which case the user will be required to correct the interference at his own expense.

The device complies with Part 15 of the FCC Rules. Operation is subject to the following two conditions: (1) this device may not cause harmful interference, and (2) this device must accept any interference received, including interference that may cause undesired operation.

FCC Caution

Any changes or modifications not expressly approved by the party responsible for compliance could void the user's authority to operate this equipment.

Warning

Operation of this equipment in a residential environment could cause radio interference.

Achtung

Der Gebrauch dieses Geräts in Wohnumgebung kann Funkstörungen verursachen.



KCC Statement

유선 제품용 / A 급 기기 (업무용 방송 통신 기기)
이 기기는 업무용 (A 급) 전자파적합기기로서 판매자 또는 사용자는 이
점을 주의하시기 바라며, 가정 외의 지역에서 사용하는 것을 목적으로
합니다.

Industry Canada Statement

This Class A digital apparatus complies with Canadian ICES-003.

CAN ICES-003 (A) / NMB-003 (A)

RoHS

This product is RoHS compliant.

User Information

Online Registration

Be sure to register your product at our online support center:

International	http://eservice.aten.com
---------------	---

Telephone Support

For telephone support, call this number:

International	886-2-8692-699
China	86-400-810-0-810
Japan	81-3-61-811
Korea	82-2-467-6789
North America	1-888-999-ATEN ext 4988 1-949-428-1111

User Notice

All information, documentation, and specifications contained in this manual are subject to change without prior notification by the manufacturer. The manufacturer makes no representations or warranties, either expressed or implied, with respect to the contents hereof and specifically disclaims any warranties as to merchantability or fitness for any particular purpose. Any of the manufacturer's software described in this manual is sold or licensed *as is*. Should the programs prove defective following their purchase, the buyer (and not the manufacturer, its distributor, or its dealer), assumes the entire cost of all necessary servicing, repair and any incidental or consequential damages resulting from any defect in the software.

The manufacturer of this system is not responsible for any radio and/or TV interference caused by unauthorized modifications to this device. It is the responsibility of the user to correct such interference.

The manufacturer is not responsible for any damage incurred in the operation of this system if the correct operational voltage setting was not selected prior to operation. PLEASE VERIFY THAT THE VOLTAGE SETTING IS CORRECT BEFORE USE.

Product Information

For information about all ATEN products and how they can help you connect without limits, visit ATEN on the Web or contact an ATEN Authorized Reseller. Visit ATEN on the Web for a list of locations and telephone numbers:

International	http://www.aten.com
North America	http://www.aten-usa.com

Package Contents

Check to make sure that all components are in working order. If you encounter any problem, please contact your dealer.

VK430

- ◆ 1 VK430 10.1" RBS Panel with wall mount
- ◆ 2 LED bars
- ◆ 4 LED bar screws
- ◆ 4 hard wall mount screws + screw anchors
- ◆ 2 3M glass mount tape
- ◆ 1 user instructions*

Contents

Compliance Statements	ii
User Information	iii
Online Registration	iii
Telephone Support	iii
User Notice	iv
Product Information	iv
Package Contents	v
VK430	v
Contents	vi
About this Manual	ix
Conventions	x

1. Introduction

Overview	1
Features	2
VK430 10.1" RBS Panel	2
RBS Configurator	2
ATEN RBS App	2
Requirements	3
Getting Started	3
Accessories	4
Components	5
VK430 RBS Panel	5

2. Hardware Setup

10.1" RBS Panel	8
Installation	8
Setting Static IP	9

3. Configurator Installation

Installation	11
The Interface	12
Getting Started Tasks	14

4. Panel Profile

Editing Profile Names, Duplicating and Deleting Profiles	15
Adding New Profiles	15

Defining Profiles	16
GUI Design	17
Booking Settings	17

5. Calendar Server

Microsoft Office 365	19
Microsoft 365 admin center	20
Adding User Accounts	20
Adding Room (Resource) Accounts	21
Setting Administrator Account to Record Room Usage Details	22
Azure Active Directory	24
Registering Application	24
Adding API Permissions	26
ATEN RBS Configurator	29
Panel Message	30
Disconnection Message	30
Support Contact	31

6. Panel Management

RBS Panel Search	33
Panel Management Options	34
Uploading Profiles and Setting Changes to ATEN RBS Panels	35
Batch Configure	36
Upgrading Firmware / APP	38

7. Panel Password

Defining Passwords Directly on the Panels	41
Changing the Passwords of Multiple RBS Panels via RBS Configurator	42

8. Panel Operation

Panel Main Page	45
Viewing Meeting Schedule	47
Today's Scheduled Meetings	47
Meetings Scheduled on Other Dates / for Other Rooms	47
Suggesting a Room	48
Booking a Room	49
Settings	49

Appendix

Safety Instructions	51
General	51
Rack Mount	53
Specifications	54
VK430	54
Technical Support	55
International	55
North America	55
Limited Warranty	56

About this Manual

This user manual is provided to help you get the most out of your ATEN Room Booking System. It covers all aspects of the system, including RBS Panel and RBS Configurator installation, configuration, and operation:

Devices and software covered in this manual include:

Models	Product Names
VK430	10.1" Room Booking System (RBS) Panel
RBS Configurator	Room Booking System (RBS) Configurator

An overview of the information found in the manual is provided below.

Chapter 1, Introduction

Introduces you to the ATEN Room Booking System, its purpose, features, and components.

Chapter 2, Hardware Setup

Provides the necessary steps to set up the ATEN Room Booking System, along with some basic operations.

Chapter 3, Configurator Installation

Provides the basic information and installation instructions of the ATEN RBS Configurator.

Chapter 4, Panel Profile

Guides you through how to configure and customize layout design profiles to be applied to the ATEN RBS Panels managed.

Chapter 5, Calendar Server

Guides you through the implementation of your ATEN Room Booking System to calendar servers, such as Microsoft Office 365 Calendar, for convenient scheduling management of all conference rooms in the system.

Chapter 6, Panel Management

Covers how to upload setting profiles to and configure the ATEN RBS Panels managed.

Chapter 7, Panel Password

Guides you through how to define and change the passwords of your ATEN RBS Panels.

Chapter 8, Panel Operation

Guides you through the operations that can be done on ATEN RBS Panels, including booking or checking into rooms.

Appendix

Provides specifications and other technical information regarding the ATEN Room Booking System.

Note:

- ◆ Read this manual thoroughly and follow the installation and operation procedures carefully to prevent any damage to the unit or connected devices.
 - ◆ ATEN regularly updates its product documentation for new features and fixes. For an up-to-date ATEN RBS documentation, visit <http://www.aten.com/global/en/>
-

Conventions

This manual uses the following conventions:

- | | |
|---|--|
| Monospaced | Indicates text that you should key in. |
| [] | Indicates keys you should press. For example, [Enter] means to press the Enter key. If keys need to be chorded, they appear together in the same bracket with a plus sign between them: [Ctrl+Alt]. |
| 1. | Numbered lists represent procedures with sequential steps. |
| ◆ | Bullet lists provide information, but do not involve sequential steps. |
| > | Indicates consecutive selecting options (such as on a menu or dialog box). For example, Start > Run means to open the <i>Start</i> menu, and then select <i>Run</i> . |
|  | Indicates critical information. |

Chapter 1

Introduction

Overview

The ATEN Room Booking System is an Ethernet-based room management system that works in conjunction with a calendar server, such as Microsoft Office 365 Calendar, to provide convenient scheduling, availability allocation, reservation, and status indication for all of the rooms managed in your organization.

ATEN Room Booking System consists of VK430 RBS Panels, 1 for each room managed, and an RBS Configurator used to configure the RBS Panels and calendar server.

Through ATEN Room Booking System, users can check for the availability of every room, book the desired rooms while scheduling meetings, as well as cancel or extend their room booking.

On each VK430 RBS Panel, you can check the time slots the corresponding room is available for and reserve immediately or for a desired time with a few simple taps.

Using RBS Configurator, the administrator can adjust the theme style and setting profiles of each VK430 RBS Panel.

The ATEN Room Booking System is the perfect solution for any meeting and conference room, boardroom, classroom, and any other room booking management through streamlined Ethernet-based management system in conjunction with a calendar server for optimum efficiency and performance.

Features

VK430 10.1” RBS Panel

- ◆ 10.1” capacitive touch-screen panel
- ◆ Natively installed with the ATEN RBS app for integration with calendar servers
- ◆ Supports Power over Ethernet (PoE) — can receive both power and communication over a single Ethernet cable
- ◆ LED light bars illuminating user-defined colors to indicate the room’s availability at a glance
- ◆ Preinstalled with a wall mount kit and provided with 3M VHB™ Tape for easy mounting onto a hard or glass wall
- ◆ 75*75 mm VESA-compliant for flexible mounting across various installation scenarios

RBS Configurator

- ◆ Easy RBS panel configuration via intuitive GUI
 - ◆ Profile setup (logo, background, calendar layout, etc.)
 - ◆ System setting (language, sleep mode brightness, volume, etc.)
 - ◆ Panel management (firmware updates and profile upload)
- ◆ Simulator to simulate and preview the customized GUI before uploading
- ◆ Supports mainstream calendar servers, such as Microsoft 365 Calendar, Google Calendar, and Microsoft Exchange Server

Note: Support for Google Calendar and Microsoft Exchange Server will be coming soon.

Requirements

Prepare the following equipment and make sure your equipment meets the minimum requirements specified below.

- ◆ **Rooms to be managed by your ATEN Room Booking System, with the following equipment**
 - ◆ 1 VK430 ATEN 10.1” RBS Panel per room
 - ◆ 1 available PoE+ port per room, from a PoE switch / injector or 1 power adapter (available for purchase, see *Accessories*, page 4)
- ◆ **A computer (for running ATEN RBS Configurator), with the following spec**
 - ◆ OS: Windows 7 / 8 / 10 (32/64-bit)
 - ◆ Processor: 1 GHz
 - ◆ Memory: 1 GB RAM
 - ◆ Storage: 500 MB available hard disk space

Getting Started

Complete the following tasks to start setting up your ATEN Room Booking System and managing your room resources.

1. Install an ATEN RBS Panel, using the preinstalled wall mount (and 3M mount tape), for each of the room to be managed by your ATEN Room Booking System.
2. Configure all RBS Panels and the required calendar server settings via ATEN RBS Configurator.
3. Upload settings and profiles to the ATEN RBS Panels.

Accessories

Optionally purchase any compatible power adapter and/or power cord if needed, as listed below. Contact your ATEN dealer for details.

Model	Description	Region
0AD8-8012-33MG	power adapter	all
LIN2-418K-D12G	power cord	A
LIN2-418K-E12G	power cord	E
LIN2-418K-D16G	power cord	J
LIN2-418K-F11G	power cord	U
LIN2-418K-N12G	power cord	I
LIN2-418K-G11G	power cord	G
LIN2-418K-Z11G	power cord	Z
LIN2-418K-K11G	power cord	K

Components

VK430 RBS Panel

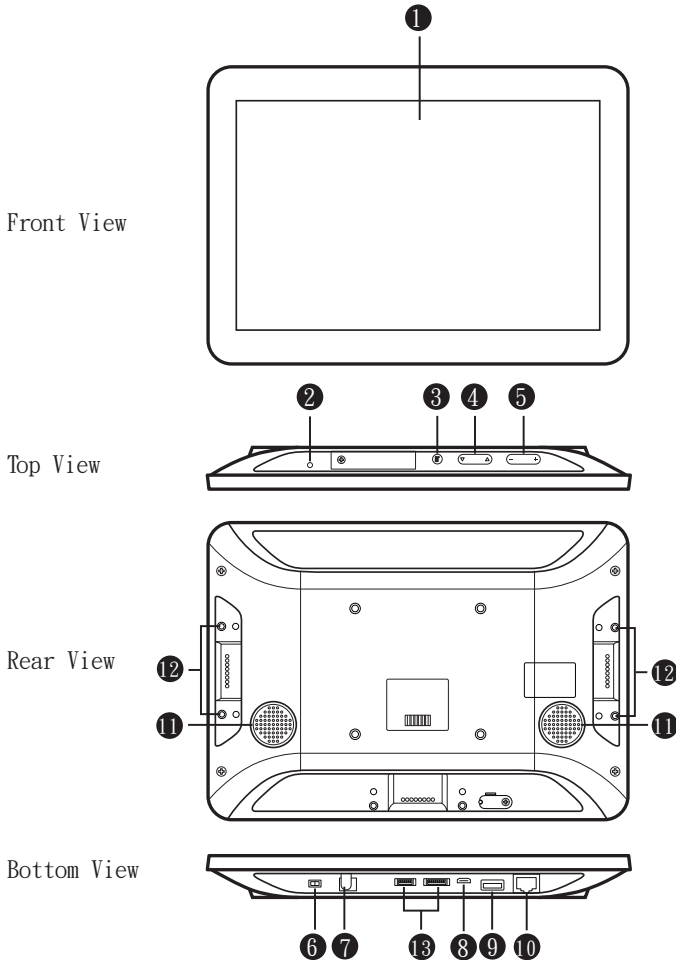

No.	Component	Description
1	touch screen	Tap to configure or reserve the corresponding room.
2	status LED	Lights on when the touch panel is powered on.

No.	Component	Description
3	function button	Press to access the <i>Settings</i> page.
4	brightness + / -	Press to adjust the display brightness.
5	volume + / -	Press to adjust the volume of the touch panel.
6	power switch	Turns the touch panel on or off.
7	power jack	Connects to power.
8	USB Micro-B port	Reserved for debugging.
9	USB type-A port	Used to update the ATEN RBS app and/or firmware.
10	LAN port with PoE	Connects to the network, while receiving power via PoE.
11	speakers	Plays beep sounds to indicate operation actions.
12	LED screw holes	Used for attaching LED bars.
13	reserved for debugging purposes	These ports are reserved for debugging.

Chapter 2

Hardware Setup



Important safety information regarding the placement of this device is provided on *Safety Instructions*, page 51. Please review it before proceeding.

This chapter guides you through the hardware setup of ATEN RBS device as well as cover some of its basic configurations.

The RBS device covered includes:

Model	Product Name	Page
VK430	10.1" RBS Panel	p.8

For the installation and configuration of ATEN RBS Configurator, please refer to *Configurator Installation*, page 11, and *Panel Management*, page 33.

10.1" RBS Panel

Installation

The ATEN VK430 RBS Panel comes preinstalled with a wall mount. It is also compatible with any VESA-compliant (75 x 75 mm) mounting accessory. Follow the steps below to install and mount the VK430 onto a wall.

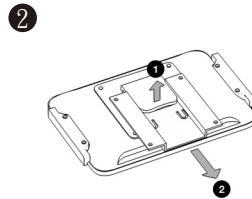
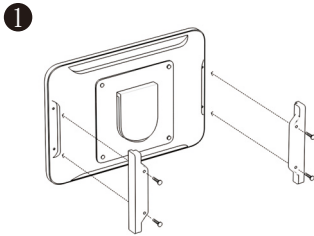

Hard Wall

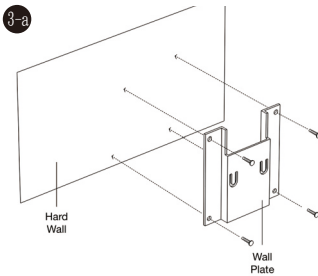

Glass Wall

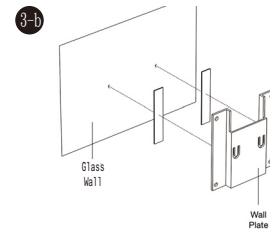

Warning: Wait for 24+ hours for an adhesive bond strength of 90% at room temperature

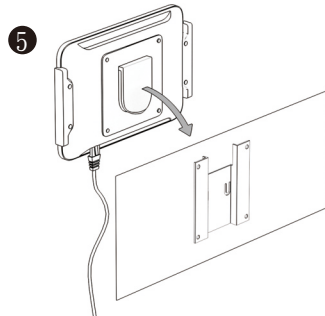
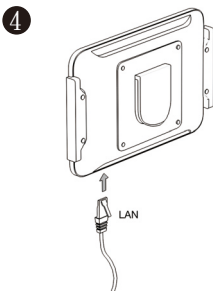

1. Secure the 2 LED bars onto the sides of the VK430 using the 4 LED bar screws provided.

2. Slightly bend the mounting plate outward to detach it from the VK430.
3. Secure the mounting plate onto a (a) hard or (b) glass wall, respectively using one of the following methods.
 - (a) *Hard Wall*: Secure the mounting plate onto the hard wall using the 4 screws included (also use the 4 screw anchors if necessary).
 - (b) *Glass Wall*: Secure the mounting plate onto the glass wall using the 2 strips of 3M glass mount tape provided.

IMPORTANT: For optimal adhesive results, make sure to firmly press the taped mounting plate against the wall for 3 ~ 5 seconds and wait for it to dry for at least 24 hours.

5. Place the VK430 onto the wall by sliding and attaching it to the mounting plate.
6. Turn on the unit by switching its power switch to ON. The status LED shall light green.

Upon first-time startup, the VK430 shall be offline and not connected to any calendar server.

To set up the VK430, you shall use the ATEN RBS Configurator software to create the necessary setting profiles to be uploaded to it. See *Configurator Installation*, page 11.

Setting Static IP

By default, your VK430 is DHCP-enabled. To assign a static IP address, follow the steps below.

1. Press the function button at the top of the unit, as illustrated below. The *Settings* page appears.

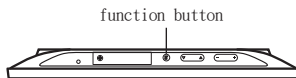

2. Tap **Network & Internet > Ethernet > Ethernet IP Mode** to set it to static IP mode and define the related network settings.

This Page Intentionally Left Blank

Chapter 3

Configurator Installation

The ATEN RBS Configurator is a GUI-based management software that helps you configure mass RBS panels for convenient management of your conference room resources against a calendar server, such as Microsoft Office 365 Calendar.

Installation

To install the RBS Configurator software, do the following:

1. Download RBS Configurator.
 - a) Visit the ATEN download page.
<http://www.aten.com/global/en/support-and-downloads/downloads/>
 - b) Search for “RBS Configurator.” A list of downloads for RBS Configurator appear.
 - c) Download **aten_rbs_configurator_setup_vx.x.xxx.exe**.
2. Execute the setup file. Then follow the on-screen instructions to install the RBS Configurator.

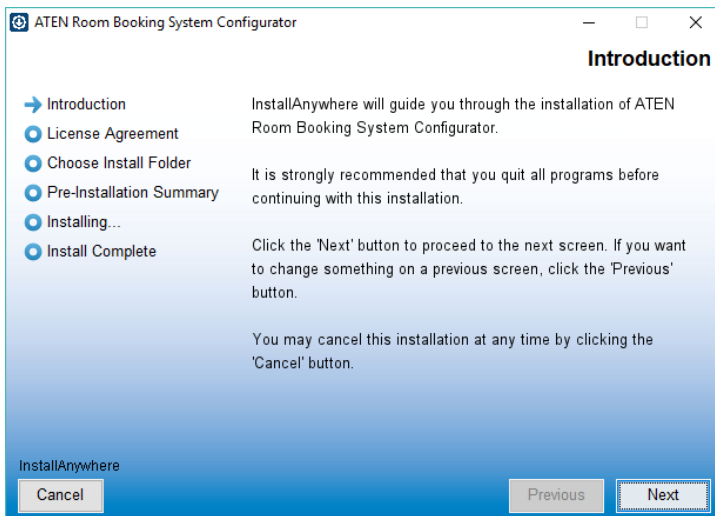

Note: On the *License Agreement* page, thoroughly read through and accept the terms of the license agreement before proceeding.

3. Once the installation is completed, click **Done** to finish.

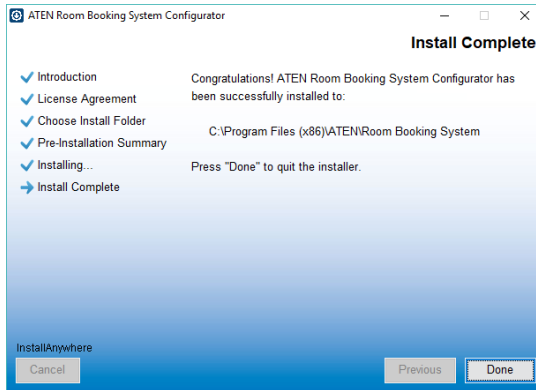

The Interface

Launch the software to start configuring your ATEN Room Booking System. Below is the general interface of RBS Configurator and its components.

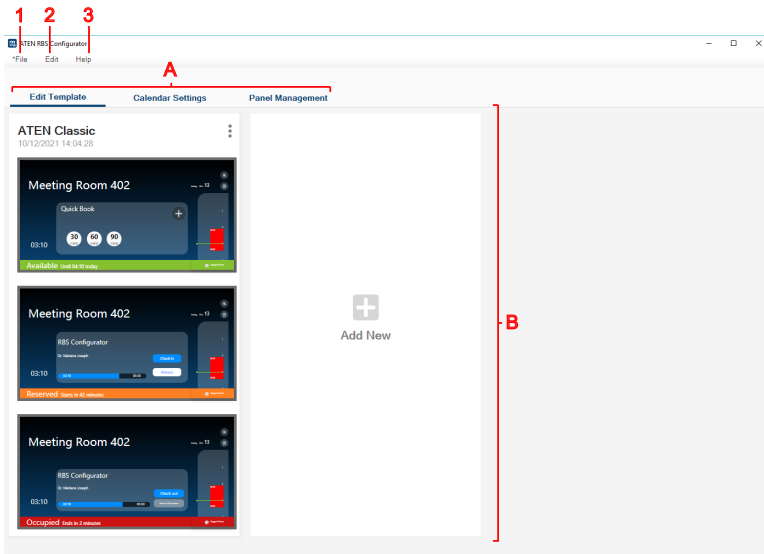

No.	Item	Description
A	Tab Menu	<p>The main selection menu for switching views between the following:</p> <ul style="list-style-type: none"> ◆ Edit Template: Defines layout designs to be applied to the RBS panels managed. ◆ Calendar Settings: Contains the required calendar server settings for integration with ATEN Room Booking System. ◆ Panel Management: Upload and/or edit setting profiles to ATEN RBS Panels via network.
B	Interactive Display	<p>This section is your main work area, which reflects the tab menu item selected.</p>
1	File	<ul style="list-style-type: none"> ◆ New Project: Clears the current project and start a new one. ◆ Open Project: Opens a previously-saved project file. ◆ Save: Saves the current project. ◆ Save as: Saves the current project as a new project file. ◆ Exit: Exits and closes RBS Configurator.
2	Edit	<ul style="list-style-type: none"> ◆ Language: Changes the <i>language</i> of the RBS Configurator.
3	Help	<ul style="list-style-type: none"> ◆ About: Displays the information of the RBS Configurator.

Configuration Steps

After launching the ATEN RBS Configurator, it is recommended to set up your ATEN Room Booking System in the following order:

1. In the **Edit Template** tab, define a desired layout and theme style to be uploaded to the ATEN RBS Panels you will be managing.
2. In the **Calendar Settings** tab, configure the required calendar server settings for integration with your ATEN Room Booking System.
3. In the **Panel Management** tab, search for and upload setting profiles to ATEN RBS Panels within the network.
4. Save your *RBS Project* by clicking **File > Save**.

Chapter 4

Panel Profile

The *Edit Profile* tab, in ATEN RBS Configurator, allows you to customize layout design profiles and define booking settings to be applied to any ATEN RBS Panels managed.

Editing Profile Names, Duplicating and Deleting Profiles

On a panel profile, you can click the  button for the following options:

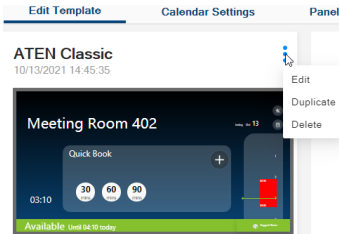

Item	Description
Edit	Edits the name of the profile.
Duplicate	Creates a duplicate of the profile.
Delete	Deletes the profile.

Adding New Profiles

To add a new profile, simply click **Add New**, as illustrated below.

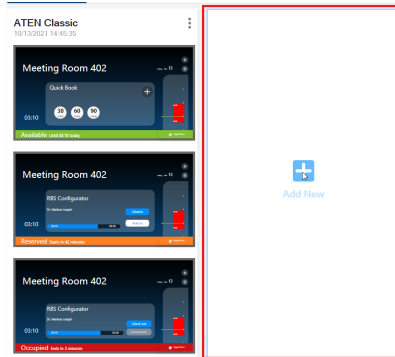

Defining Profiles

Click on a desired profile to start. The following dialog box appears.

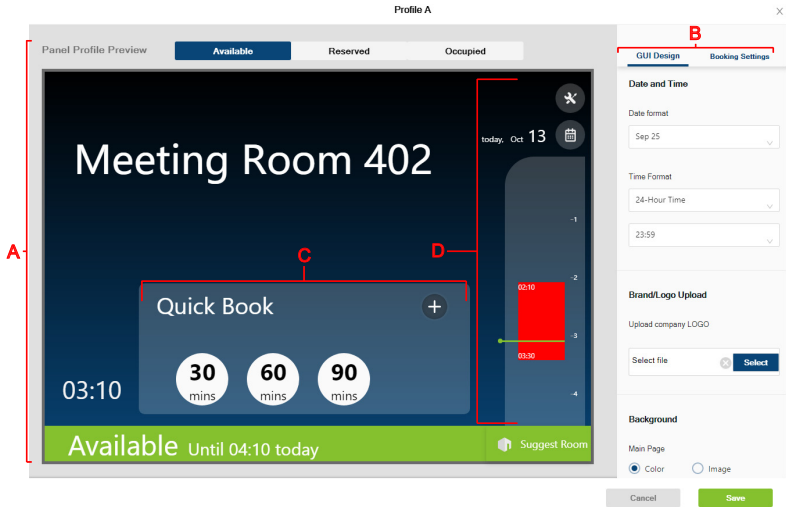

No.	Item	Description
A	Panel Profile Preview	Displays an example of how the panel layout would look like once the profile is applied.
B	Interactive Display	Contains the following: <ul style="list-style-type: none"> ◆ GUI Design: Defines the profile's layout design related settings. ◆ Booking Settings: Sets the profile's booking-related settings
C	Check-in Panel	Used for checking-in to a meeting room and quick booking.
D	Daily Schedule Area	Displays the room's reservation schedule for the day.

GUI Design

Item	Sub-Item	Description
Date and Time	Date Format	Sets the format in which date is displayed on the RBS Panel.
	Time Format	Sets the format in which time is displayed on the RBS Panel.
Brand/Logo Upload	Upload Company Logo	Uploads a brand logo image (.jpg, .jpeg, .png, or .bmp), up to 140*140 pixels, to be displayed on the upper-left of the RBS Panel.
Background	Main Page	Defines the background of the RBS Panel's main page, either by selecting a color or uploading an image (.jpg, .jpeg, .png, or .bmp), up to 1280*732 pixels.
	Sub Page	Sets the display style of the RBS Panel's sub page.
Time Color		Sets the color in which time is displayed on the RBS Panel
Check-in Panel Color		Sets the color of the RBS Panel's check-in panel.
Daily Schedule Area	Icon Color	Sets the color of icons on the RBS Panel's daily schedule area.
	Display Style	Sets the display style and color of the RBS Panel's daily schedule area.

Booking Settings

Item	Sub-Item	Description
Quick Booking		Enable to allow quick booking options to be available on the RBS Panel's check-in panel.
Extend Meeting		Enable to allow extending of an ongoing meeting.
Check-in Setting	Auto Release	Enable to automatically release the room, to be available for booking if not checked in within the time set.
	Can Check in before	Enable to allow users to check into the room within the time set prior to the start of a meeting.
	Hold for	Enable to hold the room for the time set before auto release.
Display Host Name		Enable to display the name of the host who's scheduled the meeting.
Sleep Schedule	Brightness	Sets the brightness of the RBS Panel during off-duty hours.

Item	Sub-Item	Description
Status Color	Available	Sets the color of the LED bars of the RBS Panel, and its status color, when it is available for use.
	Reserved	Sets the color of the LED bars of the RBS Panel, and its status color, when it is reserved for a meeting.
	Occupied	Sets the color of the LED bars of the RBS Panel, and its status color, when it is occupied.

Click **Save** for changes to take effect.

Chapter 5

Calendar Server

This chapter guides you through the implementation of your ATEN Room Booking System to calendar servers supported, such as Microsoft Office 365 Calendar, for convenient scheduling management of all conference rooms in the system.

Microsoft Office 365

To set up a Microsoft Office 365 Calendar for managing your ATEN Room Booking System, follow the steps below.

1. Using the Microsoft Office 365's administrator account, do the following:
 - ◆ Add a user account for every person who is allowed to book room resources through the Office 365 calendar server.
 - ◆ Add a resource account, while setting a password, for every conference room to be managed by the Room Booking System.
 - ◆ Configure the administrator account to retrieve detailed information of the rooms managed from the calendar server.
 - ◆ Through Office 365's Azure Active Directory, register for an APP ID and add the required API permission for the Room Booking System.

Note: For detailed procedures, see *Microsoft 365 admin center*, page 20 and *Azure Active Directory*, page 24.

2. On your ATEN RBS Configurator, go to the *Calendar Settings* tab, select **Office 365** and enter the following:
 - ◆ **Admin Account:** Microsoft Office 365's administrator account.
 - ◆ **Admin Password:** Microsoft Office 365's administrator password.
 - ◆ **Application ID:** The Application ID as registered via Microsoft Office 365's Azure Active Directory.

Note: See *ATEN RBS Configurator*, page 29, for details.

Microsoft 365 admin center

To start, log into <https://login.microsoftonline.com> using the Microsoft Office 365's administrator account and click **Admin**.

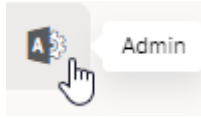

Adding User Accounts

Add a user account for every person who is allowed to book room resources through the Office 365 calendar server, by doing the following:

1. Go to **Navigation Menu > Users > Active Users** and click **Add a user**.

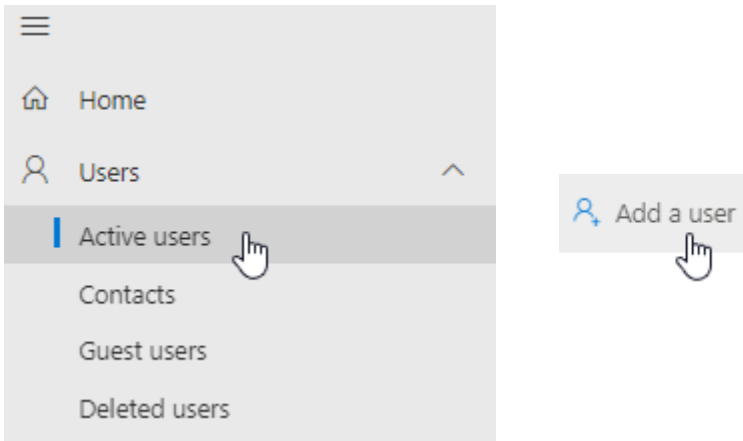

2. Follow the on-screen instructions to create the user account.

Adding Room (Resource) Accounts

Add a room account, and set a required password, for every conference room to be managed by ATEN RBS, by doing the following:

1. Go to **Navigation Menu > Resources > Rooms & equipment** and click **Add resource**

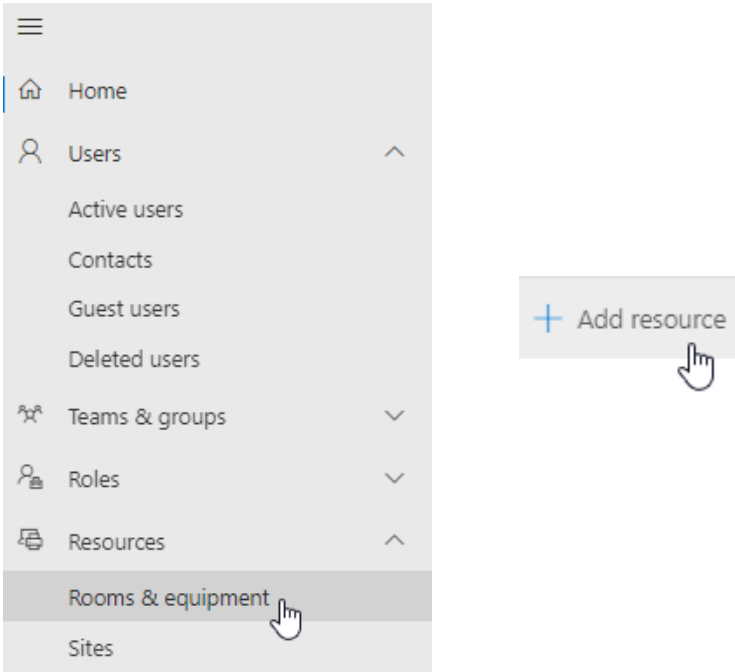

2. Select **Room** from the *Resource type* dropdown list and then follow the on-screen instructions to create the room account.

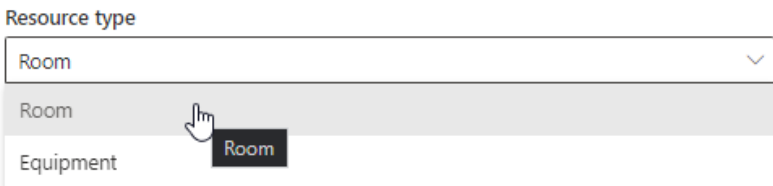

3. Go to **Navigation Menu > Users > Active Users**, click **Reset a password** next to the room account created from step 2 and follow the on-screen instructions to define its password.

Note: Make sure a password has been set for every room account created.

Setting Administrator Account to Record Room Usage Details

Configure the administrator account to record the necessary conference room usage details, by doing the following:

1. Go to **Navigation Menu > Resources > Rooms & equipment** and select and click any of the room accounts you want their usage details to be recorded for

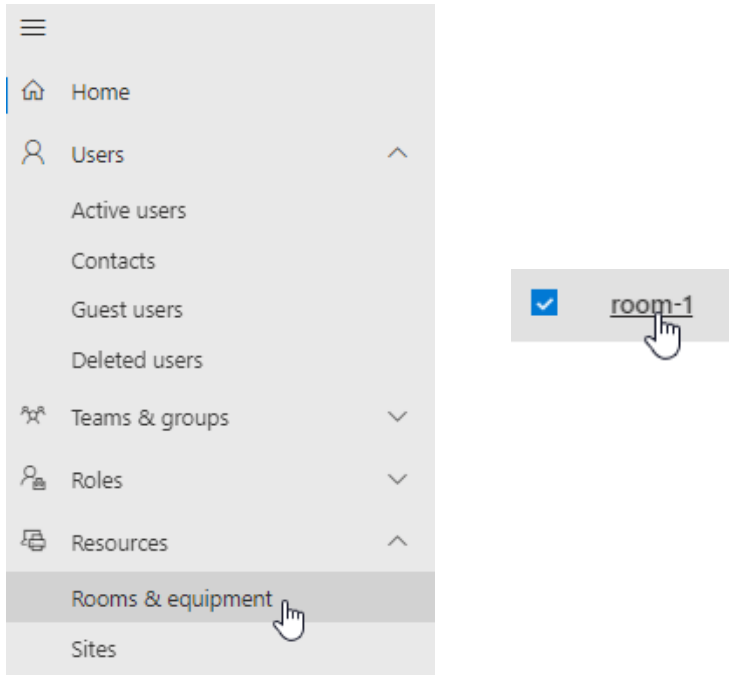

2. On the room account info dialog box that appears, click **Edit** under *Delegates*.

Delegates (0)

[Edit](#)

3. In the *Manage delegates* dropdown list, type, search for, and select the administrator account used to manage the conference rooms, and their room accounts, and then click **Save changes**.

Delegates

Manage delegates

Results



Save changes

4. Repeat steps 1 ~ 3 for every room account.

Azure Active Directory

From *Microsoft 365 admin center*, go to **Navigation Menu > Admin centers** and select **Azure Active Directory**.

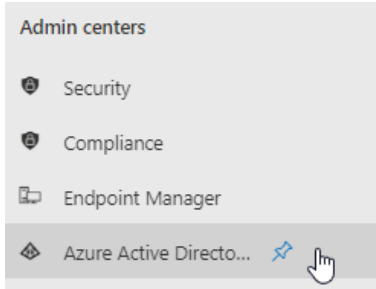

Registering Application

Register to obtain an Application ID for the ATEN Room Booking System, by doing the following:

1. Go to **Azure Active Directory > App registrations** and click **New Registration**.

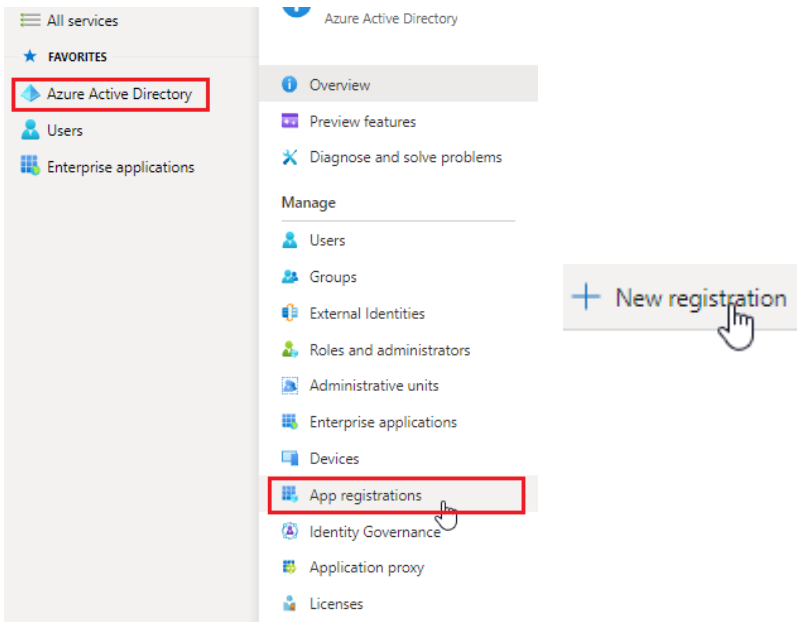

2. Enter a desired name, select **Accounts in this organizational directory only** under *Supported account types*, and click **Register**.

Register an application ...

* Name

The user-facing display name for this application (this can be changed later).

ATEN_RBS ✓

Supported account types

Who can use this application or access this API?

- Accounts in this organizational directory only (test only - Single tenant)
- Accounts in any organizational directory (Any Azure AD directory - Multitenant)
- Accounts in any organizational directory (Any Azure AD directory - Multitenant) and personal Microsoft accounts (e.g. Skype, Xbox)
- Personal Microsoft accounts only

[Help me choose...](#)

Redirect URI (optional)

We'll return the authentication response to this URI after successfully authenticating the user. Providing this now is optional and it can be changed later, but a value is required for most authentication scenarios.

Web e.g. https://example.com/auth

3. Once registered successfully, the **Application ID** is displayed, which shall later be entered on your ATEN RBS Configurator.

^ Essentials

Display name : ATEN_RBS

Application (client) ID : 00000000-0000-0000-0000-000000000000

Object ID : 00000000-0000-0000-0000-000000000000

Directory (tenant) ID : 00000000-0000-0000-0000-000000000000

Supported account types : My organization only

- After registering, go to **Authentication**, enable *Allow public client flows* by selecting **Yes**. Then click **Save** for the changes to take effect.

Search (Ctrl+/) Save Discard Got feedback?

Overview Quickstart Integration assistant

Manage

- Branding
- Authentication**
- Certificates & secrets
- Token configuration
- API permissions
- Expose an API
- App roles
- Owners
- Roles and administrators | Preview
- Manifest

Support + Troubleshooting

- Troubleshooting
- New support request

Platform configurations

Depending on the platform or device this application is targeting, additional configuration may be required such as redirect URIs, specific authentication settings, or fields specific to the platform.

+ Add a platform

Supported account types

Who can use this application or access this API?

- Accounts in this organizational directory (test only - Single tenant)
- Accounts in any organizational directory (Any Azure AD directory - Multitenant)

Help me decide...

Advanced settings

Allow public client flows

Enable the following mobile and desktop flows: **Yes** No

- App collects plaintext password (Resource Owner Password Credential Flow) [Learn more](#)
- No keyboard (Device Code Flow) [Learn more](#)
- SSO for domain-joined Windows (Windows Integrated Auth Flow) [Learn more](#)

Adding API Permissions

After registering the application, also make sure the required API permissions have been applied to it, by doing the following:

- Click **API permissions** > **Add a permission**, and select **Microsoft Graph** > **Delegated permissions**

Search (Ctrl+/) Refresh Got feedback?

Overview Quickstart Integration assistant

Manage

- Branding
- Authentication
- Certificates & secrets
- Token configuration
- API permissions**
- Expose an API
- App roles
- Owners

The "Admin consent required" column shows the default value for an organization. However...

Configured permissions

Applications are authorized to call APIs when they are granted permissions by users/admins all the permissions the application needs. [Learn more about permissions and consent](#)

+ Add a permission Grant admin consent for atenrd4test

API / Permissions name	Type	Description
Microsoft Graph (1)		
User.Read	Delegated	Sign in and read user profile

To view and manage permissions and user consent, try [Enterprise applications](#).



Select an API

Microsoft APIs APIs my organization uses My APIs

Commonly used Microsoft APIs



Microsoft Graph
Take advantage of the tremendous amount of data in Office 365, Enterprise Mobility + Security, and Windows 10. Access Azure AD, Excel, Intune, Outlook/Exchange, OneDrive, OneNote, SharePoint, Planner, and more through a single endpoint.

 Microsoft Graph
<https://graph.microsoft.com/> [Docs](#) 

What type of permissions does your application require?

Delegated permissions

Your application needs to access the API as the signed-in user.



2. Select and enable the following permissions:

- ◆ 4 Calendar permissions

∨ Calendars (4)

<input checked="" type="checkbox"/>	Calendars.Read ⓘ Read user calendars	No
<input checked="" type="checkbox"/>	Calendars.Read.Shared ⓘ Read user and shared calendars	No
<input checked="" type="checkbox"/>	Calendars.ReadWrite ⓘ Have full access to user calendars	No
<input checked="" type="checkbox"/>	Calendars.ReadWrite.Shared ⓘ Read and write user and shared calendars	No

◆ 1 Place permission

▼ Place (1)

<input type="checkbox"/>	Place.Read ⓘ Read user places	No
<input checked="" type="checkbox"/>	Place.Read.All ⓘ Read all company places	Yes
<input type="checkbox"/>	Place.Read.Shared ⓘ Read user places for delegates	No
<input type="checkbox"/>	Place.ReadWrite ⓘ Read and write user places	No
<input type="checkbox"/>	Place.ReadWrite.All ⓘ Read and write organization places	Yes

◆ 2 User permissions



▼ User (2)

<input type="checkbox"/>	User.Export.All ⓘ Export user's data	Yes
<input type="checkbox"/>	User.Invite.All ⓘ Invite guest users to the organization	Yes
<input type="checkbox"/>	User.ManageIdentities.All ⓘ Manage user identities	Yes
<input checked="" type="checkbox"/>	User.Read ⓘ Sign in and read user profile	No
<input checked="" type="checkbox"/>	User.Read.All ⓘ Read all users' full profiles	Yes
<input type="checkbox"/>	User.ReadBasic.All ⓘ Read all users' basic profiles	No
<input type="checkbox"/>	User.ReadWrite ⓘ Read and write access to user profile	No
<input type="checkbox"/>	User.ReadWrite.All ⓘ Read and write all users' full profiles	Yes

3. Click **Add permissions**.

4. Click **Grant admin consent for your account**, as illustrated below, and then click **Yes** to finish.

+ Add a permission ✔ Grant admin consent for 

API / Permissions na...	Type	Description	Admin consent req...	Status
▼ Microsoft Graph (7)				
Calendars.Read	Delegated	Read user calendars	No	✔ Granted for 
Calendars.Read.Sha	Delegated	Read user and shared calendars	No	✔ Granted for 

Grant admin consent confirmation.

Do you want to grant consent for the requested permissions for all accounts in aten3562? This will update any existing admin consent records this below.

Note: If you encounter MFA (multi-factor authentication) issues, please refer to <https://docs.microsoft.com/en-us/microsoft-365/admin/security-and-compliance/set-up-multi-factor-authentication?view=o365-worldwide#turn-security-defaults-on-or-off> to disable.

ATEN RBS Configurator

On your RBS Configurator, go to **Calendar Settings > Office 365** and enter the Microsoft Office 365 Calendar related settings, as below.

The screenshot shows the 'Calendar Settings' tab for 'office 365'. On the left, there is a sidebar with 'office 365' selected and a 'Panel Message' section. The main content area is titled 'office 365' and contains three input fields: 'Admin Account' with the value 'test@aten.onmicrosoft.com', 'Admin Password' with masked characters '.....', and 'Application Id' with a long alphanumeric string.

Item	Description
Admin Account	Enter the Microsoft Office 365 Calendar's administrator account.
Admin Password	Enter the Microsoft Office 365 Calendar's administrator password.
Application ID	Enter the Application ID of the ATEN RBS as registered on the Microsoft Office 365 Calendar.

Panel Message

The *Panel Message* settings allow users to define the disconnection message to be displayed on the RBS Panels managed when they are not connected to the calendar server, as well as the contact info to be displayed on the RBS Panels' settings page.

To access the Panel Message settings, select **Calendar Settings > Panel Message** on your RBS Configurator.

Disconnection Message

Define the title and content of the disconnection message, as exemplified below.

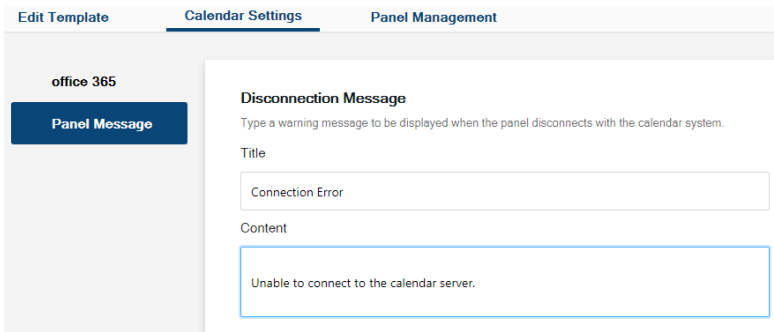

Once applied, the message will be displayed on the RBS Panels when they are not connected to the calendar server.

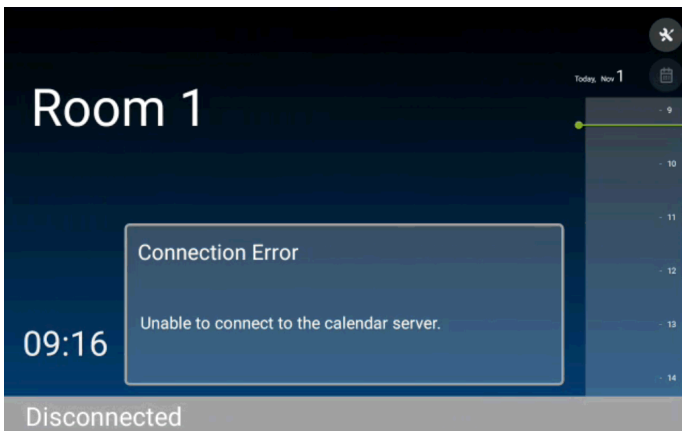

Support Contact

Define the contact info, for support or assistance, to be displayed on the RBS Panels' settings page, as exemplified below.

Support Contact

Add a support contact for the system administrator to be shown on the support center page.

Content

Please contact the administrator (#8888)

Once applied, the contact info is displayed on the RBS Panels' settings page.

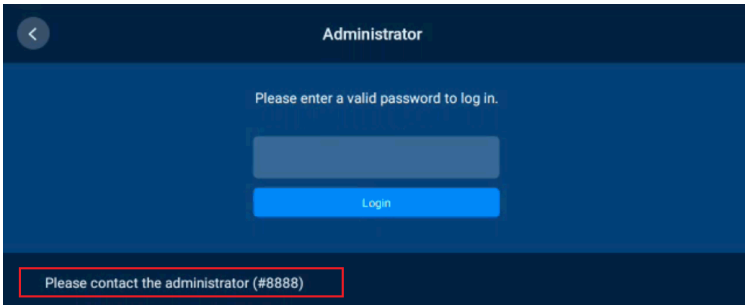

This Page Intentionally Left Blank

Panel Management

The *Panel Management* tab, in ATEN RBS Configurator, allows you to upload setting profiles to and configure the ATEN RBS Panels managed.

RBS Panel Search

To start, you can search for the RBS Panels you want to manage by 1 of the 2 following methods:

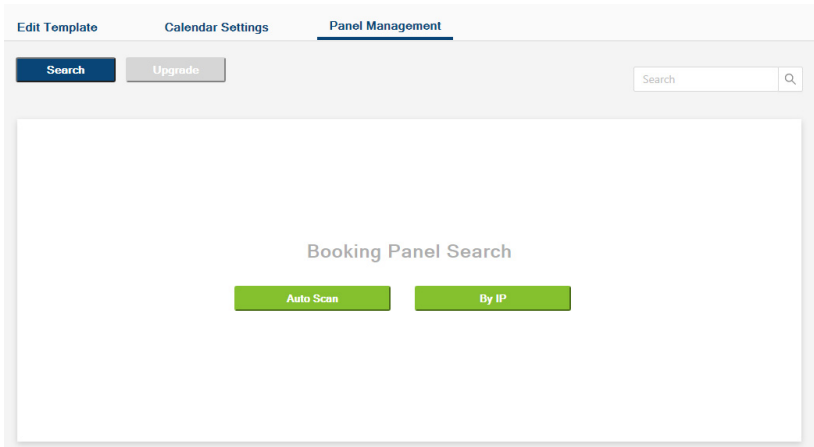



- ◆ **Auto Scan:** Automatically searches for all RBS Panels within the same subnet.
- ◆ **By IP:** Searches for RBS Panels within the LAN by entering an IP range or a specific IP address.

Panel Management Options

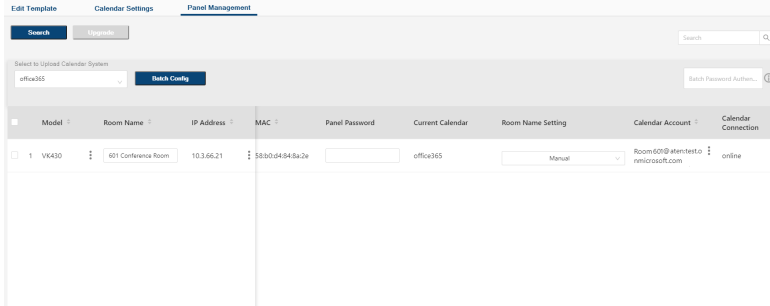
After at least 1 RBS Panel has been found by the RBS Configurator, its related information and configuration options are displayed, as exemplified below.



Item	Description
Model	Displays the model of the RBS Panel. ◆ Click  to optionally reset the RBS Panel to factory default settings.
Room Name	Displays and defines the name of the meeting room managed.
IP Address	Displays the IP address of the RBS Panel. ◆ Click  to optionally adjust the network settings of the RBS Panel.
MAC	Displays the MAC address of the RBS Panel.
Panel Password	Type the password of the RBS Panel for the required authentication prior to uploading setting changes to the RBS Panel. (default password: <i>password</i>)
Current Calendar	Displays the calendar server currently used to manage the RBS Panel.
Room Name Setting	Selects how the RBS Panel is named, either manually or synchronized from the calendar server.
Calendar Account	Displays or assigns the calendar server resource account used to manage the RBS Panel.
Profile	Displays or uploads the setting profile used by or to the RBS Panel.
Volume	Displays or adjusts the volume setting of the RBS Panel.
Brightness	Displays or adjusts the brightness of the RBS Panel.
Language	Displays or adjusts the language setting of the RBS Panel.
Time Zone	Displays or adjusts the time zone of the RBS Panel.

Item	Description
FW / APP Version	Respectively displays the firmware and app version of the RBS Panel.
Change Password	Changes the password of the RBS Panel.
Last Update	Displays the time at which the RBS Panel was last updated.

Uploading Profiles and Setting Changes to ATEN RBS Panels

Users can upload profiles and/or setting changes to any RBS Panel managed by doing the following:

1. First, check the RBS Panels to which you want to upload profiles and/or setting changes.

<input type="checkbox"/>	Model	Room Name	IP Address
<input checked="" type="checkbox"/>	1 VK430	601 Conference Room	10.3.66.21
<input type="checkbox"/>	2 VK430	602 Conference Room	10.3.66.20
<input checked="" type="checkbox"/>	3 VK430	605 Conference Room	10.3.66.18

2. To upload profiles, select the desired profile(s) from the dropdown list in the **Profile** column, as illustrated below.

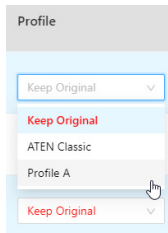

Note: Select **Keep Original** only when you don't want to replace the RBS Panel's current profile with another.

3. Make all of the setting changes you want to apply to the RBS Panels selected.

4. Type the login passwords of the RBS Panels selected in the **Panel Password** column, as illustrated below.

Note: If the RBS Panels to which you want to upload profiles and/or setting changes share the same panel password, you can simply type that common password in the **Batch Password Authentication** field instead of having to type the same password repeatedly.

5. Click **Upload**.

Batch Configure

The *Batch Config* function allows you to upload the same profile or same setting changes to multiple RBS Panels all at once, instead of having to make the same setting changes individually and repeatedly.

1. First, check the RBS Panels to which you want to batch configure.

<input checked="" type="checkbox"/>	Model	Room Name	IP Address
<input checked="" type="checkbox"/>	1 VK430	601 Conference Room	10.3.66.21
<input type="checkbox"/>	2 VK430	602 Conference Room	10.3.66.20
<input checked="" type="checkbox"/>	3 VK430	605 Conference Room	10.3.66.18

2. Type the login passwords of the RBS Panels selected in the **Panel Password** column, as illustrated below.

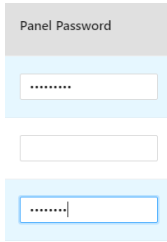

The image shows a form with a header 'Panel Password' in a grey box. Below it is a text input field containing several dots, representing a password. Below that is an empty text input field. At the bottom is another text input field containing several dots and a cursor, also representing a password.

Note: If the RBS Panels to which you want to upload profiles and/or setting changes share the same panel password, you can simply type that common password in the **Batch Password Authentication** field instead of having to type the same password repeatedly.

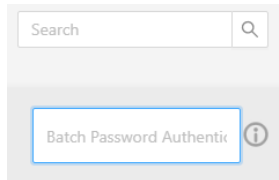

The image shows a search bar with the text 'Search' and a magnifying glass icon. Below it is a text input field with the text 'Batch Password Authentik' and an information icon (i) to its right.

3. Select the same setting changes and/or profile you want to apply to the RBS Panels selected in **Batch Config**.

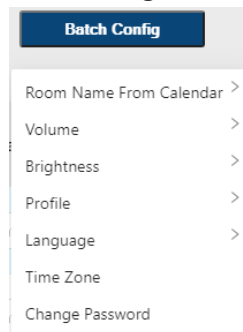

The image shows a menu titled 'Batch Config' in a dark blue box. Below the title is a list of settings with right-pointing chevrons: Room Name From Calendar, Volume, Brightness, Profile, Language, Time Zone, and Change Password.

4. After all of the desired setting changes have been made, click **Upload** for them to be applied to the RBS Panels selected.

Upgrading Firmware / APP

To upgrade the firmware and/or APP of the RBS Panels, follow the steps below.

1. Download and unzip the firmware / APP upgrade file from the product webpage.
2. Check the RBS Panels for which you want to upgrade firmware and/or APP

<input type="checkbox"/>	Model	Room Name	IP Address
<input checked="" type="checkbox"/>	1 VK430	601 Conference Room	10.3.66.21
<input type="checkbox"/>	2 VK430	602 Conference Room	10.3.66.20
<input checked="" type="checkbox"/>	3 VK430	605 Conference Room	10.3.66.18

3. Type the login passwords of the RBS Panels selected in the **Panel Password** column, as illustrated below.

Panel Password

.....

.....|

Note: If the RBS Panels to which you want to upload profiles and/or setting changes share the same panel password, you can simply type that common password in the **Batch Password Authentication** field instead of having to type the same password repeatedly.

Search Q

Batch Password Authentic i

4. Click **Upgrade**, select **FW Upgrade** or **APP Upgrade** and browse for the firmware or APP upgrade file.

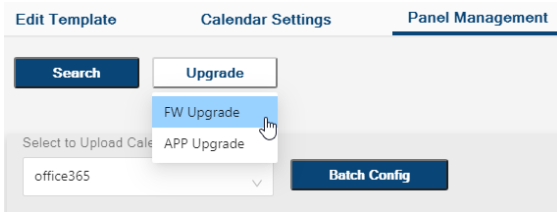

5. Click **Upgrade** to finish.

This Page Intentionally Left Blank

Chapter 7

Panel Password

This chapter guides you through how to define and change the passwords of your ATEN RBS Panels.

You can define your RBS Panels' passwords using one of the following methods:

- ◆ Defining the passwords directly on the RBS Panels, see page 41.
- ◆ Changing the passwords of multiple RBS Panels simultaneously, see page 42.

Defining Passwords Directly on the Panels

To start, make sure the RBS Panel is connected to the network and turned on.

1. From its main page, tap . The login page appears.

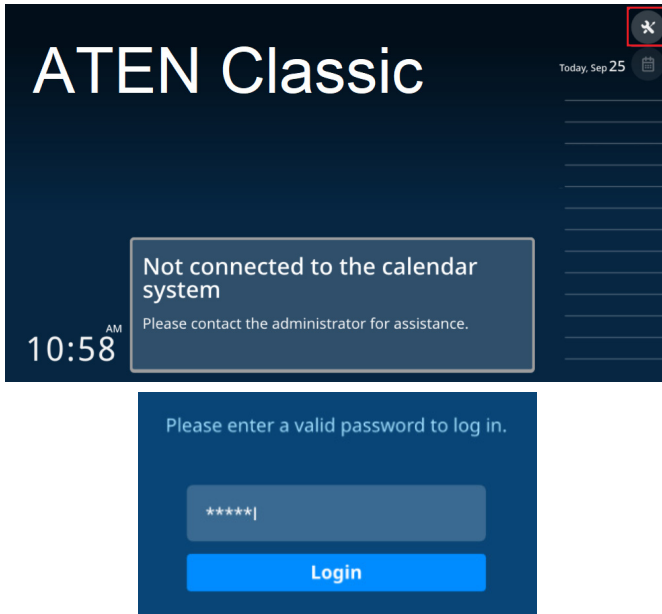

2. Log into the RBS Panel by entering its password and tapping **Login**.

Note: For first-time login, use the default password *password* to login, and you're required to change the password.

3. Once logged in, you can change the panel's password by tapping **Change Password** and following the on-screen instructions.
4. Tap **Save** to finish.

Changing the Passwords of Multiple RBS Panels via RBS Configurator

To start, make sure all of the RBS Panels to be configured are connected within the same network as your ATEN RBS Configurator and turned on.

1. On your RBS Configurator, go to the *Panel Management* tab and search for the RBS Panels you want to change passwords for by 1 of the 2 following methods.
 - ◆ **Auto Scan:** Automatically searches for all RBS Panels within the same subnet.
 - ◆ **By IP:** Searches for RBS Panels within the LAN by entering an IP range or a specific IP address.
2. Check the RBS Panels for which you want to change passwords.

<input type="checkbox"/>	Model		Room Name	IP Address
<input checked="" type="checkbox"/>	1 VK430	⋮	<input type="text" value="601 Conference Room"/>	10.3.66.21
<input type="checkbox"/>	2 VK430	⋮	<input type="text" value="602 Conference Room"/>	10.3.66.20
<input checked="" type="checkbox"/>	3 VK430	⋮	<input type="text" value="605 Conference Room"/>	10.3.66.18

3. Type the login passwords of the RBS Panels selected in the **Panel Password** column, as illustrated below.

Panel Password

.....

.....

Note: If the RBS Panels to which you want to upload profiles and/or setting changes share the same panel password, you can simply type that common password in the **Batch Password Authentication** field instead of having to type the same password repeatedly.

Search

Batch Password Authent ⓘ

4. Click **Batch Config > Change Password**, set a password, and click **Fill in**

Batch Config

- Room Name From Calendar >
- Volume >
- Brightness >
- Profile >
- Language >
- Time Zone >
- Change Password**

Change Password

Valid characters include uppercase and lowercase letters, numbers, space, and special symbols (*#_:@).

Note: the password change must be uploaded for it to take effect.

New Password

.....

Confirm New Password

.....

Cancel **Fill In**

5. Click **Upload** to apply the password change to the RBS Panels selected.

This Page Intentionally Left Blank

Chapter 8

Panel Operation

This chapter guides you through the operations that can be done on ATEN RBS Panels, including booking or checking into rooms.

Note: Before operating any of your RBS Panels, make sure the necessary configurations and profiles have been uploaded and applied to them.

Panel Main Page

The components of the RBS Panel's main page are described below:

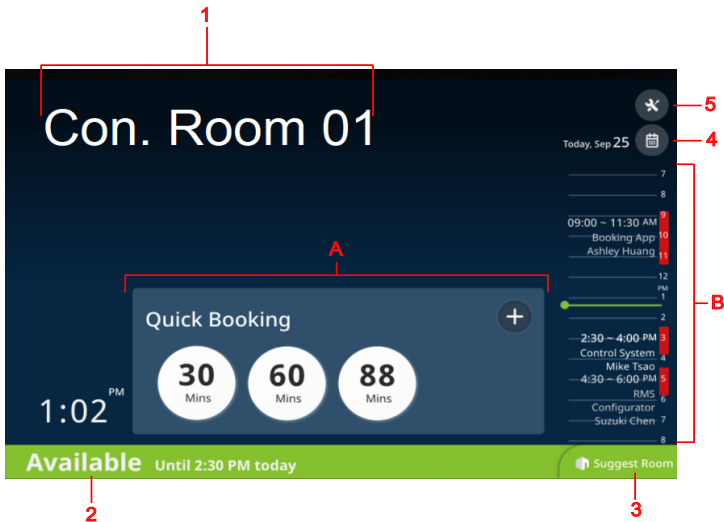

Note: To customize the display style of your RBS Panels, or add a brand / logo or background image via RBS Configurator, see *GUI Design*, page 17.

No.	Item	Description
A	Quick Booking / Check-in	Provides varying functions based on the current status of the conference room: <i>Available</i> , <i>Reserved</i> , or <i>Occupied</i> .
	Available	<ul style="list-style-type: none"> ◆ Quick Booking: Lets users start or schedule a meeting using the conference room through one of the following options: <ul style="list-style-type: none"> ◆ 30 / 60 / 90 / X: Immediately starts a meeting for 30 / 60 / 90 / X minutes, where X is the number of minutes the room is available for until the next scheduled meeting or off-duty hours. ◆  : Tap to schedule a meeting. See <i>Booking a Room</i>, page 49, for details.
	Reserved	<ul style="list-style-type: none"> ◆ Check In: During a meeting's scheduled time, lets users to check in to the room and start the meeting. ◆ Release: During a meeting's scheduled time, lets users to cancel it and release the room for others to use.
Occupied	<ul style="list-style-type: none"> ◆ Check Out: During an ongoing meeting, lets users to check out of the room and end the meeting. ◆ Extend: During an ongoing meeting, lets users to extend the meeting time if the conference room is available for further use. 	
B	Today's Scheduled Meetings	Displays all meetings the conference room has scheduled during the day.
1	Room Display Name	Displays the name of the conference room.
2	Room Status	<p>Displays the status of the conference room.</p> <ul style="list-style-type: none"> ◆ Available: Indicates the room is available for use. ◆ Reserved: Indicates the room is reserved for a meeting, but not yet checked into. ◆ Occupied: Indicates the room is currently hosting an ongoing meeting.
3	Suggest Room	Suggests conference rooms currently available for hosting a meeting. See <i>Suggesting a Room</i> , page 48, for details.
4	Other Dates	Displays all meetings scheduled within the Room Booking System, see <i>Viewing Meeting Schedule</i> , page 47.
5	Settings	Accesses administrator settings, see <i>Settings</i> , page 49.

Viewing Meeting Schedule

Today's Scheduled Meetings

To view meetings scheduled throughout the day, simply tap and drag on the ATEN RBS Panel's *Daily Schedule Area*.

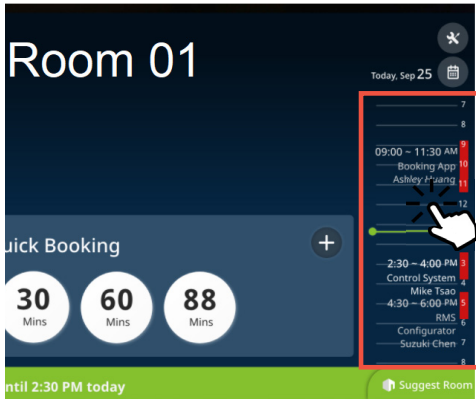

Meetings Scheduled on Other Dates / for Other Rooms

To view meeting schedules for other dates or for other conference rooms, tap the calendar icon . The following page appears.

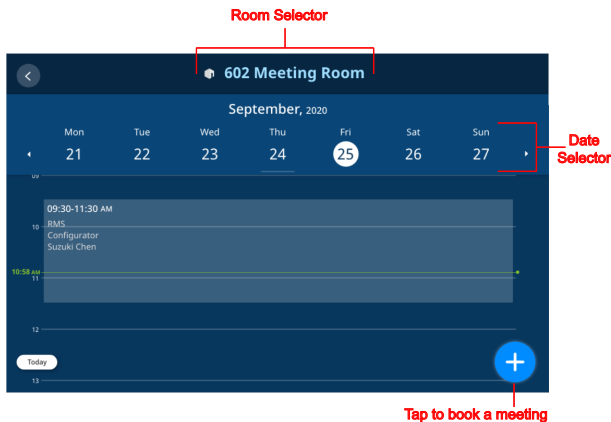

Select the desired conference room and date to view the corresponding meeting schedule.

To book a room and schedule a meeting, tap  and see *Booking a Room*, page 49 for details.

Suggesting a Room

The *Suggest Room* function suggests conference rooms, currently available for use within the Room Booking System, to users for convenient meeting hosting.

1. From the main page of a RBS Panel, tap **Suggest Room**.

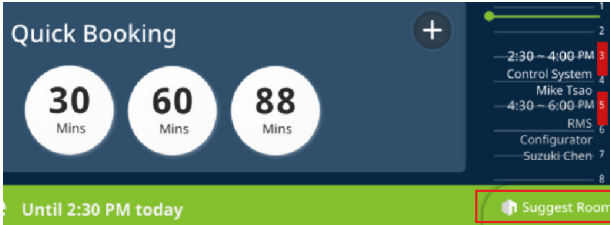

2. Select the desired meeting time.

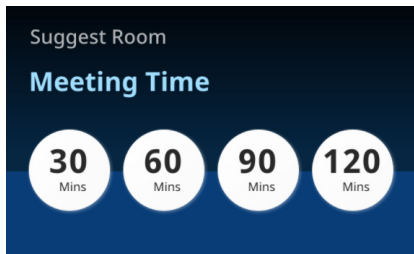

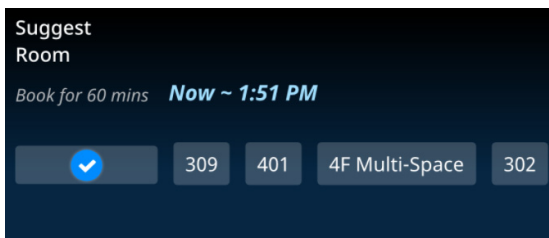

3. Based on your meeting time, the Room Booking System displays the conference rooms that are currently available for use, as exemplified below.



4. Select the desired room to finish.

The conference room selected is now hosting a meeting for the time specified. You can now go to that conference and check in to start your meeting.

Booking a Room

To book a room and schedule a meeting, users can either tap  or  from a RBS Panel's main page or schedule page. The following page appears.

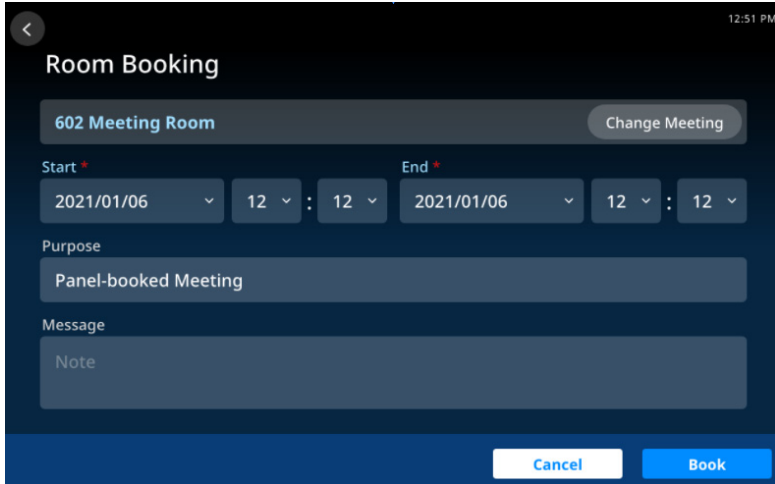

The screenshot shows a mobile application interface for booking a room. At the top left is a back arrow, and at the top right is the time 12:51 PM. The title is "Room Booking". Below the title is a text input field containing "602 Meeting Room" and a "Change Meeting" button. Underneath are two time pickers: "Start" and "End". Both are set to "2021/01/06" and "12" respectively. Below the time pickers is a "Purpose" field with the text "Panel-booked Meeting". Below that is a "Message" field with the text "Note". At the bottom are two buttons: "Cancel" and "Book".

1. Select the desired conference room.
2. Specify the meeting's start and end times.
3. Fill in other desired fields.
4. Tap **Book** to finish.

Settings

The *Settings* page of RBS Panels contains its network and password settings. To access, tap  from the RBS Panel's main page and enter the required password.

Note: For setting the password of ATEN RBS Panels, see *Panel Password*, page 41.

This Page Intentionally Left Blank

Appendix

Safety Instructions

General

- ◆ Read all of these instructions. Save them for future reference.
- ◆ Follow all warnings and instructions marked on the device.
- ◆ This product is for indoor use only.
- ◆ Do not place the device on any unstable surface (cart, stand, table, etc.). If the device falls, serious damage will result.
- ◆ Caution: Risk of explosion if the battery is replaced by an incorrect type. Always dispose of used batteries according to the proper instructions.
- ◆ Do not use the device near water.
- ◆ Do not place the device near, or over, radiators or heat registers.
- ◆ The device cabinet is provided with slots and openings to allow for adequate ventilation. To ensure reliable operation, and to protect against overheating, these openings must never be blocked or covered.
- ◆ The device should never be placed on a soft surface (bed, sofa, rug, etc.) as this will block its ventilation openings. Likewise, the device should not be placed in a built in enclosure unless adequate ventilation has been provided.
- ◆ Never spill liquid of any kind on the device.
- ◆ Unplug the device from the wall outlet before cleaning. Do not use liquid or aerosol cleaners. Use a damp cloth for cleaning.
- ◆ The device should be operated from the type of power source indicated on the marking label. If you are not sure of the type of power available, consult your dealer or local power company.
- ◆ To prevent damage to your installation it is important that all devices are properly grounded.
- ◆ Do not allow anything to rest on the power cord or cables. Route the power cord and cables so that they cannot be stepped on or tripped over.
- ◆ Position system cables and power cables carefully; Be sure that nothing rests on any cables.
- ◆ Never push objects of any kind into or through cabinet slots. They may touch dangerous voltage points or short out parts resulting in a risk of fire or electrical shock.

- ◆ Do not attempt to service the device yourself. Refer all servicing to qualified service personnel.
- ◆ If the following conditions occur, unplug the device from the wall outlet and bring it to qualified service personnel for repair.
 - ◆ The power cord or plug has become damaged or frayed.
 - ◆ Liquid has been spilled into the device.
 - ◆ The device has been exposed to rain or water.
 - ◆ The device has been dropped, or the cabinet has been damaged.
 - ◆ The device exhibits a distinct change in performance, indicating a need for service.
 - ◆ The device does not operate normally when the operating instructions are followed.
- ◆ Only adjust those controls that are covered in the operating instructions. Improper adjustment of other controls may result in damage that will require extensive work by a qualified technician to repair.
- ◆ Avoid circuit overloads. Before connecting equipment to a circuit, know the power supply's limit and never exceed it. Always review the electrical specifications of a circuit to ensure that you are not creating a dangerous condition or that one doesn't already exist. Circuit overloads can cause a fire and destroy equipment.

Specifications

VK430

Panel Specifications	
Display Type	TFT-LCD
Size	10.1"
Touch Screen	Capacitive
Resolution	1280 x 800
Aspect Ratio	16:10
Color Depth	8 bit
Contrast Ratio	800:1
Backlight	LED
Viewing Angle	±85° (H), ±85° (V)
Interfaces	
Ethernet	1 x RJ-45 Female, 10/100/1000 BaseT
USB	1 x USB Type-A
Power	
Power over Ethernet (PoE)	802.3 at PoE+
Power Consumption	DC 48 V : 20 W : 68.24 BTU
Environmental	
Operating Temperature	0 – 40 °C
Storage Temperature	-10 – 55 °C
Humidity	10–80% RH, Non-condensing
Physical Properties	
Housing	Plastic
Weight	0.90 kg (1.98 lb)
Dimensions (L x W x H)	26.32 x 17.78 x 3.72 cm (10.35 x 7.00 x 1.46 in.)

Technical Support

International

- ◆ For online technical support – including troubleshooting, documentation, and software updates: **<http://eservice.aten.com>**
- ◆ For telephone support, see *Telephone Support*, page iii:

North America

Email Support		support@aten-usa.com
Online Technical Support	Troubleshooting Documentation Software Updates	https://eservice.aten.com
Telephone Support		1-888-999-ATEN ext 4988

When you contact us, please have the following information ready beforehand:

- ◆ Product model number, serial number, and date of purchase.
- ◆ Your computer configuration, including operating system, revision level, expansion cards, and software.
- ◆ Any error messages displayed at the time the error occurred.
- ◆ The sequence of operations that led up to the error.
- ◆ Any other information you feel may be of help.

Limited Warranty

ATEN warrants its hardware in the country of purchase against flaws in materials and workmanship for a Warranty Period of two [2] years (warranty period may vary in certain regions/countries) commencing on the date of original purchase. This warranty period includes the [LCD panel of ATEN LCD KVM switches](#). Select products are warranted for an additional year (see [A+ Warranty](#) for further details). Cables and accessories are not covered by the Standard Warranty.

What is covered by the Limited Hardware Warranty

ATEN will provide a repair service, without charge, during the Warranty Period. If a product is defective, ATEN will, at its discretion, have the option to (1) repair said product with new or repaired components, or (2) replace the entire product with an identical product or with a similar product which fulfills the same function as the defective product. Replaced products assume the warranty of the original product for the remaining period or a period of 90 days, whichever is longer. When the products or components are replaced, the replacing articles shall become customer property and the replaced articles shall become the property of ATEN.

To learn more about our warranty policies, please visit our website:
<http://www.aten.com/global/en/legal/policies/warranty-policy/>

© Copyright 2021 ATEN® International Co., Ltd.
Released: 2021-12-22

ATEN and the ATEN logo are registered trademarks of ATEN International Co., Ltd. All rights reserved. All other brand names and trademarks are the registered property of their respective owners.