



Hardware Installation Guide for the Cisco 1000 Series Integrated Services Router

Last Modified: 2019-06-07

Last Modified: 2020-02-11

Americas Headquarters

Cisco Systems, Inc.
170 West Tasman Drive
San Jose, CA 95134-1706
USA
<http://www.cisco.com>
Tel: 408 526-4000
800 553-NETS (6387)
Fax: 408 527-0883

THE SPECIFICATIONS AND INFORMATION REGARDING THE PRODUCTS IN THIS MANUAL ARE SUBJECT TO CHANGE WITHOUT NOTICE. ALL STATEMENTS, INFORMATION, AND RECOMMENDATIONS IN THIS MANUAL ARE BELIEVED TO BE ACCURATE BUT ARE PRESENTED WITHOUT WARRANTY OF ANY KIND, EXPRESS OR IMPLIED. USERS MUST TAKE FULL RESPONSIBILITY FOR THEIR APPLICATION OF ANY PRODUCTS.

THE SOFTWARE LICENSE AND LIMITED WARRANTY FOR THE ACCOMPANYING PRODUCT ARE SET FORTH IN THE INFORMATION PACKET THAT SHIPPED WITH THE PRODUCT AND ARE INCORPORATED HEREIN BY THIS REFERENCE. IF YOU ARE UNABLE TO LOCATE THE SOFTWARE LICENSE OR LIMITED WARRANTY, CONTACT YOUR CISCO REPRESENTATIVE FOR A COPY.

The following information is for FCC compliance of Class A devices: This equipment has been tested and found to comply with the limits for a Class A digital device, pursuant to part 15 of the FCC rules. These limits are designed to provide reasonable protection against harmful interference when the equipment is operated in a commercial environment. This equipment generates, uses, and can radiate radio-frequency energy and, if not installed and used in accordance with the instruction manual, may cause harmful interference to radio communications. Operation of this equipment in a residential area is likely to cause harmful interference, in which case users will be required to correct the interference at their own expense.

The following information is for FCC compliance of Class B devices: This equipment has been tested and found to comply with the limits for a Class B digital device, pursuant to part 15 of the FCC rules. These limits are designed to provide reasonable protection against harmful interference in a residential installation. This equipment generates, uses and can radiate radio frequency energy and, if not installed and used in accordance with the instructions, may cause harmful interference to radio communications. However, there is no guarantee that interference will not occur in a particular installation. If the equipment causes interference to radio or television reception, which can be determined by turning the equipment off and on, users are encouraged to try to correct the interference by using one or more of the following measures:

- Reorient or relocate the receiving antenna.
- Increase the separation between the equipment and receiver.
- Connect the equipment into an outlet on a circuit different from that to which the receiver is connected.
- Consult the dealer or an experienced radio/TV technician for help.

Modifications to this product not authorized by Cisco could void the FCC approval and negate your authority to operate the product.

The Cisco implementation of TCP header compression is an adaptation of a program developed by the University of California, Berkeley (UCB) as part of UCB's public domain version of the UNIX operating system. All rights reserved. Copyright © 1981, Regents of the University of California.

NOTWITHSTANDING ANY OTHER WARRANTY HEREIN, ALL DOCUMENT FILES AND SOFTWARE OF THESE SUPPLIERS ARE PROVIDED "AS IS" WITH ALL FAULTS. CISCO AND THE ABOVE-NAMED SUPPLIERS DISCLAIM ALL WARRANTIES, EXPRESSED OR IMPLIED, INCLUDING, WITHOUT LIMITATION, THOSE OF MERCHANTABILITY, FITNESS FOR A PARTICULAR PURPOSE AND NON-INFRINGEMENT OR ARISING FROM A COURSE OF DEALING, USAGE, OR TRADE PRACTICE.

IN NO EVENT SHALL CISCO OR ITS SUPPLIERS BE LIABLE FOR ANY INDIRECT, SPECIAL, CONSEQUENTIAL, OR INCIDENTAL DAMAGES, INCLUDING, WITHOUT LIMITATION, LOST PROFITS OR LOSS OR DAMAGE TO DATA ARISING OUT OF THE USE OR INABILITY TO USE THIS MANUAL, EVEN IF CISCO OR ITS SUPPLIERS HAVE BEEN ADVISED OF THE POSSIBILITY OF SUCH DAMAGES.

Any Internet Protocol (IP) addresses and phone numbers used in this document are not intended to be actual addresses and phone numbers. Any examples, command display output, network topology diagrams, and other figures included in the document are shown for illustrative purposes only. Any use of actual IP addresses or phone numbers in illustrative content is unintentional and coincidental.

All printed copies and duplicate soft copies of this document are considered uncontrolled. See the current online version for the latest version.

Cisco has more than 200 offices worldwide. Addresses and phone numbers are listed on the Cisco website at www.cisco.com/go/offices.

Cisco and the Cisco logo are trademarks or registered trademarks of Cisco and/or its affiliates in the U.S. and other countries. To view a list of Cisco trademarks, go to this URL: [www.cisco.com go trademarks](http://www.cisco.com/go/trademarks). Third-party trademarks mentioned are the property of their respective owners. The use of the word partner does not imply a partnership relationship between Cisco and any other company. (1721R)

© 2017–2019 Cisco Systems, Inc. All rights reserved.



CONTENTS

CHAPTER 1

Overview of Cisco 1000 Series Integrated Services Routers 1

- About Cisco 1000 Series Integrated Service Routers 1
- Chassis Views 4
- LED Indicators 13
- Reset Button 20
- Power Supply 20
- Slots and Interfaces 21
 - About Slots, Subslots, and Port Numbering 21
 - Specifications of Cisco 1100 Series Integrated Services Routers 21
- Periodic Inspection and Cleaning 21

CHAPTER 2

Prepare for Router Installation 23

- Safety Recommendations 23
 - Safety With Electricity 24
 - Prevent Electrostatic Discharge Damage 24
- General Site Requirements 24
 - Site Selection Guidelines 25
- Rack Requirements 25
- Router Environmental Requirements 26
- Power Guidelines and Requirements 27
- Network Cabling Specifications 27
 - Console Port Connections 27
 - EIA/TIA-232 28
 - USB Serial Console 28
 - Console Port Considerations 29
 - Preparing for Network Connections 29

Ethernet Connections	29
Required Tools and Equipment for Installation and Maintenance	30

CHAPTER 3**Install and Connect the Router 31**

Unpack the Router	31
Set up Router on Desktop, Rack, or Wall	31
Rack Mount	32
Attach the Brackets for C111x	32
Attach the Rack Mounting Brackets for C112x	33
Mount the Router	34
Mount the Router under a Desk or a Shelf	35
Mount Router using DIN Rail Brackets	36
Attach Din-Rail Brackets on C112x	37
Wall Mount the Router	38
Wall Mount Using Key-hole Slots	38
Wall Mount using DIN Rail Brackets	45
Chassis Grounding	47
Connect Power Cable	49
Connect the Router to a Console	51
Connect to the Serial Port with Microsoft Windows	53
Connect to the Console Port with Mac OS X	54
Connect to the Console Port with Linux	54
Connect WAN and LAN Interfaces	55
Ports and Cabling	55
Connection Procedures and Precautions	56
Configure the Router at Startup	56

CHAPTER 4**Install and Upgrade Internal Modules and Field Replaceable Units 57**

Access Internal Modules	57
Replace the Chassis Cover	58
Remove the Cover	58
Replace the Cover	59
Locate Internal and External Slots for Modules	59
Install an LTE Pluggable Module	59

Install a Micro-SIM Card onto a USB LTE Dongle	59
Install an LTE Pluggable Module on a C1101-4P	62
Install and Remove Small Form Pluggable Modules	66
Install Small Form Pluggable Module	66
Remove Small Factor Pluggable Module	66

CHAPTER 5	ROM Monitor Overview	69
	ROM Monitor Overview	69

CHAPTER 6	Supplier Declaration of Conformity	71
------------------	---	-----------



CHAPTER 1

Overview of Cisco 1000 Series Integrated Services Routers

Cisco 1000 Series Integrated Services Routers (ISRs) with Cisco IOS XE Software are high-performance devices that are easy to deploy and manage. The routers combine Internet access, comprehensive security, and wireless services (LTE Advanced 3.0, Wireless WAN and Wireless LAN).

- [About Cisco 1000 Series Integrated Service Routers, on page 1](#)
- [Periodic Inspection and Cleaning, on page 21](#)

About Cisco 1000 Series Integrated Service Routers

The Cisco 1000 series Integrated Services Routers are the next generation, IOS XE based, multi core, branch routers. They are available in both fixed and modular form factors. The Cisco 1000 series is best suited for small and midsize businesses, enterprise branches and as customer premises equipment in managed services environments.

Table 1: Base Models of the Cisco 1000 Series ISR

Base Models	Front Panel Switch Ports	WAN Ports	Console Port	(Optional) POE	(Optional) WLAN	(Optional) LTE	(Optional) DSL
C111x-8P	8	2 (1 Combo RJ-45/SFP + 1 RJ-45)	Serial RJ-45, Micro USB	4PoE/2PoE+	None	4G LTE-Advanced (CAT6) with carrier aggregation	G.FAST, VDSL2 and ADSL2/2+
C1111X-8P	8	2 (1 Combo RJ-45/SFP + 1 RJ-45)	Serial RJ-45, Micro USB	4PoE/2PoE+	None	None	None

Base Models	Front Panel Switch Ports	WAN Ports	Console Port	(Optional) POE	(Optional) WLAN	(Optional) LTE	(Optional) DSL
C111x-4P	4	2 (1 Combo RJ-45/SFP + 1 RJ-45)	Serial RJ-45, Micro USB	2 POE/1 POE+	802.11ac WAVE 2	4G LTE-Advanced (CAT6) with carrier aggregation	VDSL2 and ADSL2/2+
C1104-4P1PWX	4	1 RJ-45	Micro USB	None	802.11ac WAVE 2 (C1104-4P1PWX)	4G pluggable LTE (CAT 4) and pluggable LTE Advanced (CAT 6) with carrier aggregation	None
C1101-4P	4	1 RJ-45	Micro USB	None	None	None	None
C1109-2PLTE	2	1 RJ-45	Micro USB	None	None	4G LTE (CAT 4)	None
C1109-4PLTE2P	4	1 RJ45	Micro USB	None	802.11ac WAVE 2 (C1109-4PLTE2P)	Dual pluggable modems - 4G pluggable LTE (CAT 4) and pluggable LTE Advanced (CAT 6) with carrier aggregation	None
P-LTE-JN	None	None	None	None	None	WP7605-G LTE CAT4: B1, B3, B8, B11, B18, B19, B21 3G UMTS HSPA+	None

Base Models	Front Panel Switch Ports	WAN Ports	Console Port	(Optional) POE	(Optional) WLAN	(Optional) LTE	(Optional) DSL
P-LTE-IN	None	None	None	None	None	WP7608-G LTE CAT4: B1, B3, B5, B8, B40, B41* 3G UMTS DC-HSPA+ * B41 supported frequency range: (2535–2655 MHz)	None
P-LTE-MNA	None	None	None	None	None	WP7610-G LTE CAT4: B2, B4, B5, B12, B13, B14, B17, B66 3G UMTS DC-HSPA+, HSPA+, HSPA, WCDMA	None
C1121-4P	4	2(1 Combo RJ45/SFP+1 RJ45	Micro USB	2 POE/1 POE+	None	None	None
C1121-4PLTEP	4	2(1 Combo RJ45/SFP+1 RJ45	Micro USB	2 POE/1 POE+	None	4G Pluggable LTE (CAT 4) and pluggable LTE Advanced (CAT 6) with carrier aggregation	None
C11x1(X)-8P *	8	2(1 Combo RJ45/SFP+1 RJ45	Micro USB	4 POE/2 POE+	None	None	None

Base Models	Front Panel Switch Ports	WAN Ports	Console Port	(Optional) POE	(Optional) WLAN	(Optional) LTE	(Optional) DSL
C11x1(X)-8PLTEP *	8	2(1 Combo RJ45/SFP+1 RJ45)	Micro USB	4 POE/2 POE+	None	4G Pluggable LTE (CAT 4) and pluggable LTE Advanced (CAT 6) with carrier aggregation	VDSL2, ADSL2/2+, G.SHDSL
C11x1(X)-8PLTEP *	8	2(1 Combo RJ45/SFP+1 RJ45)	Micro USB	4 POE/2 POE+	802.11 AC WAVE 2	4G Pluggable LTE (CAT 4) and pluggable LTE Advanced (CAT 6) with carrier aggregation	None



Note Base Models with an 'X' has 8GB of DRAM and Flash memory. Example: C1111X-8P

Base Models without an 'X' have 4GB of DRAM and Flash Memory. Example: C1111-8P

For base model-C11x1X-8PLTEP, 'x' represents the CPU performance level.

For more information on the features and specifications of Cisco 1100 Series Integrated Services Routers (ISRs), refer to the [Cisco 1000 Series Integrated Services Routers Solution Overview](#) document and [Cisco 1000 Series Integrated Services Routers](#) datasheet.

Chassis Views

This section contains front and back panel views of the C1100 Series ISR-showing locations of the power and signal interfaces, interface slots, status indicators, and chassis identification labels.

Figure 1: C111x Series - Bezel View

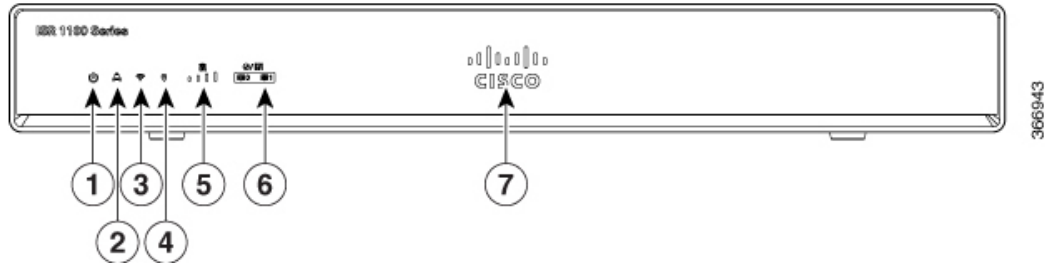

1	Status	2	VPN
3	WiFi	4	GPS
5	LTE Signal Intensity	6	LTE Data/SIM
7	Illuminated Cisco Logo		

Figure 2: C111x-8P - I/O View

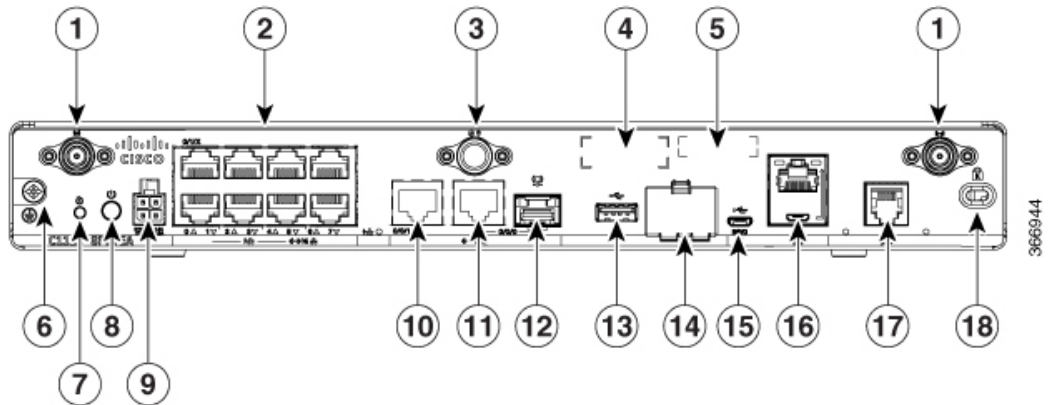

1	LTE Antennas – Main and Diversity	2	Ethernet Switch
3	GPS Connection	4	CLEI Label
5	Serial Number	6	Grounding
7	Reset Button	8	Power Switch
9	4-pin Power Connector	10	GE 0/0/1
11	GE 0/0/0 - RJ45	12	GE 0/0/0 - SFP
13	USB3.0	14	Lower slot0 Upper slot1
15	LTE Provisioning Port	16	RJ45 / Micro USB Console
17	DSL	18	Kensington Lock Slot

19	Product Identification Number (PID)
----	-------------------------------------



Note For more information on the Reset Button, refer to the Reset Overview section in the [ISR 1000 Series Integrated Services Routers](#).

Figure 3: C1101-4P ISR - Front View

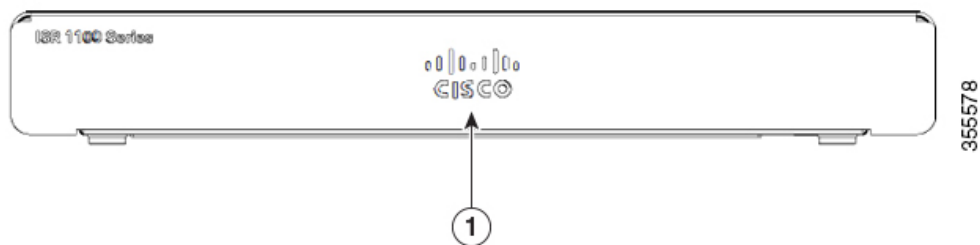

1	Non-illuminated Cisco Logo
---	----------------------------

Figure 4: C1101-4P ISR - I/O View

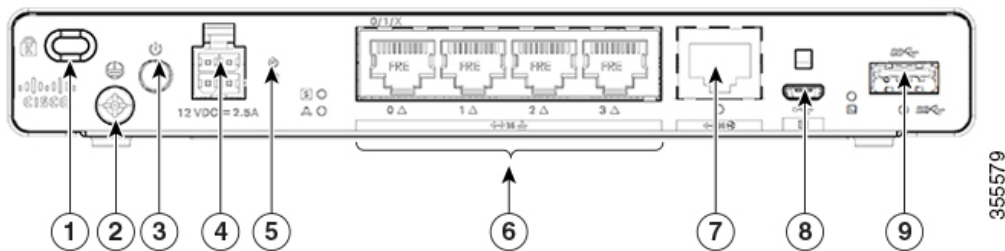

1	Kensington Lock Slot	2	Grounding
3	Power Switch	4	4-pin Power Connector
5	Reset Button	6	LAN: 0-4
7	GE WAN	8	Micro USB Console
9	USB3.0		

Figure 5: C1101-4PLTEP-Bezel View

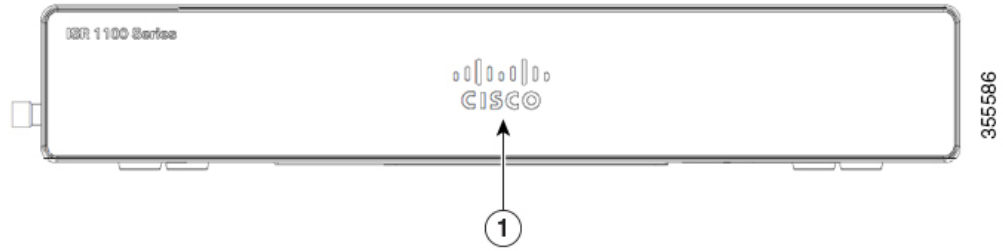

1	Non-illuminated Cisco logo
---	----------------------------

Figure 6: C1101-4PLTEP - I/O View

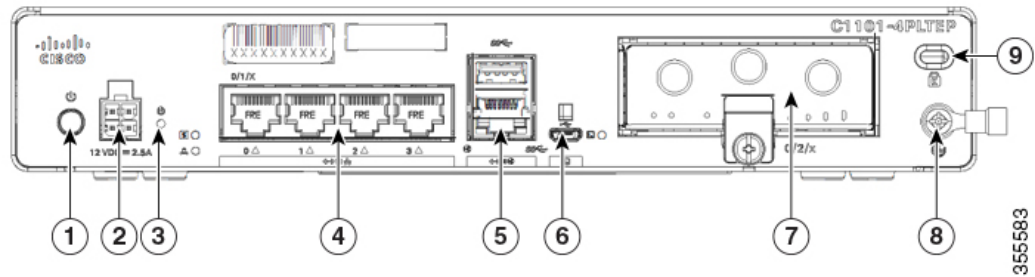

1	Power Switch	2	4-pin Power Connector
3	Reset Button	4	LAN:0-4
5	GE WAN	6	Micro-USB console Port
7	Pluggable	8	Grounding
9	Kensington Lock Slot		

Figure 7: C1109-4PLTE2P - Bezel View

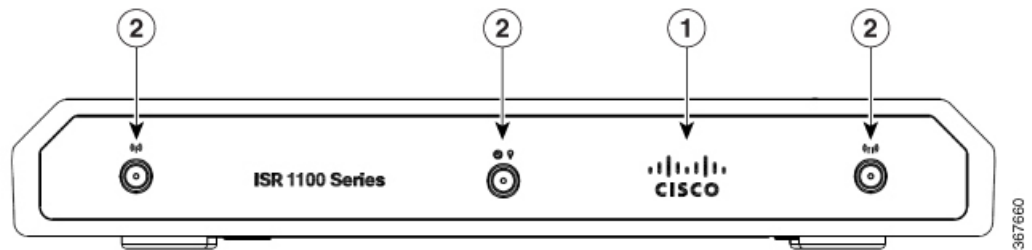

1	Non-illuminated Cisco logo
2	Main and Diversity Antenna

Figure 8: C1109-2PLTE - I/O View

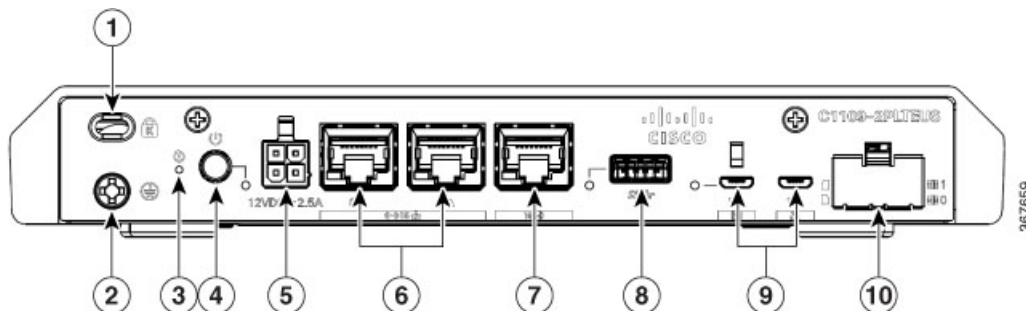

1	Kensington Lock Slot	2	Grounding
3	Reset Button	4	Power Switch
5	4-pin Power Connector	6	LAN: 0 & 1
7	GE WAN	8	Micro-USB console Port
9	USB 3.0	10	Micro-SIM slots 0 and 1

Figure 9: C1109-4PLTE2PWX - I/O View

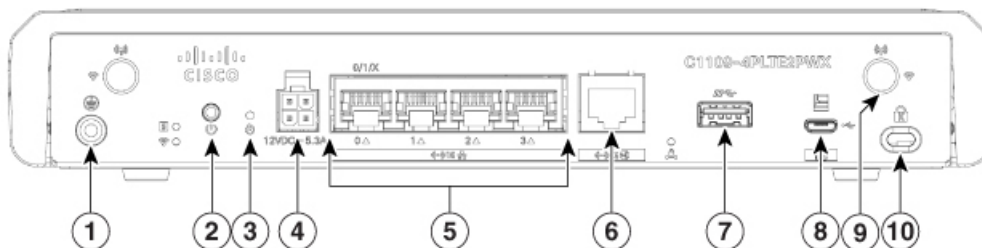

1	Grounding	2	Power Switch
3	Reset Button	4	4-pin Power Connector
5	LAN:0-4	6	GE WAN
7	USB 3.0	8	Micro-USB console Port
9	Wifi Antenna	10	Kensington Lock Slot

Figure 10: C1121-4Px - Bezel View

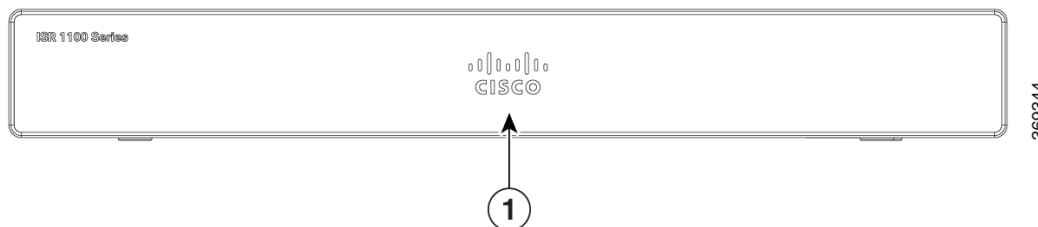

1	Non-illuminated Cisco logo	
---	----------------------------	--

Figure 11: C1121-4P I/O View

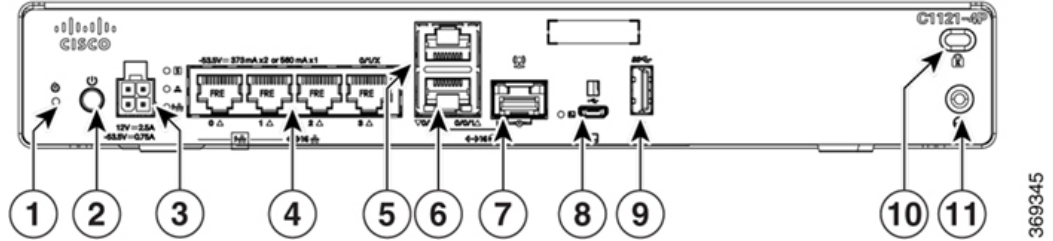

1	Reset Button	2	Power Switch
3	4-pin Power Connector	4	Ethernet Switch
5	RJ-45 Stacked Connector	6	GE WAN 0/0/0 -RJ45
7	GE WAN 0/0/0 -SFP	8	Micro-USB console
9	USB 3.0	10	Kensington Lock Slot
11	Grounding		

Figure 12: C1121-4PLTEP I/O View

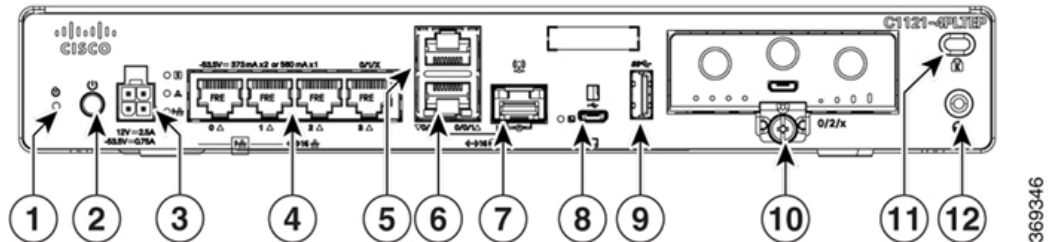

1	Reset Button	2	Power Switch
3	4-pin Power Connector	4	Ethernet Switch
5	GE 0/0/1	6	GE WAN 0/0/0 -RJ45
7	GE WAN 0/0/0 -SFP	8	Micro-USB console
9	USB 3.0	10	Pluggable
11	Kensington Lock Slot	12	Grounding

Figure 13: C1121(X)-8P - Bezel View

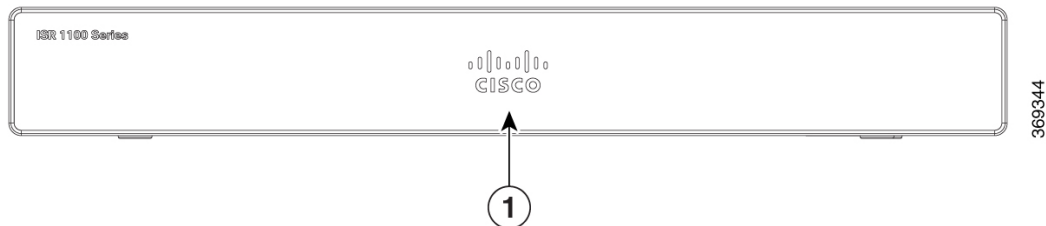

1	Non-illuminated Cisco logo
---	----------------------------

Figure 14: C1121(X)-8P I/O View

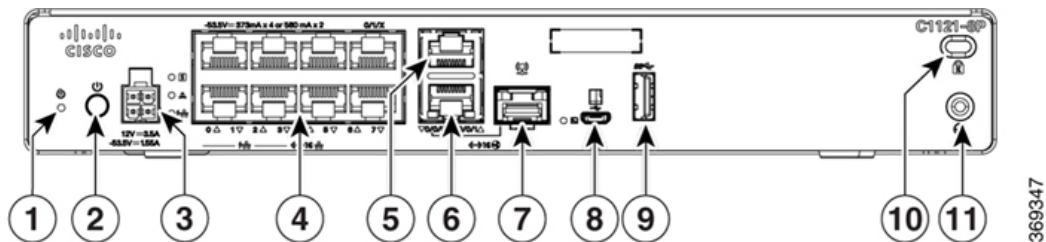

1	Reset Button	2	Power Switch
3	4-pin Power Connector	4	Ethernet Switch
5	RJ-45	6	GE WAN 0/0/0 -RJ45
7	GE WAN 0/0/0 -SFP	8	Micro-USB console
9	USB 3.0	10	Kensington Lock Slot
11	Grounding		

Figure 15: C1121-8PLTEP I/O View

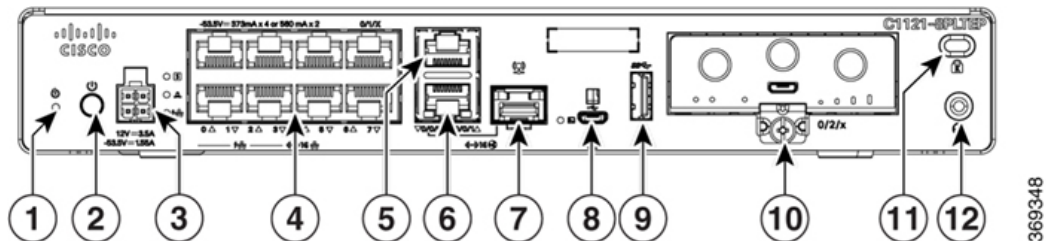

1	Reset Button	2	Power Switch
3	4-pin Power Connector	4	Ethernet Switch
5	GE 0/0/1	6	GE WAN 0/0/0 -RJ45
7	GE WAN 0/0/0 -SFP	8	Micro-USB console
9	USB 3.0	10	Pluggable

11	Kensington Lock Slot	12	Grounding
----	----------------------	----	-----------

Figure 16: C1121-8PLTEPWx Bezel View

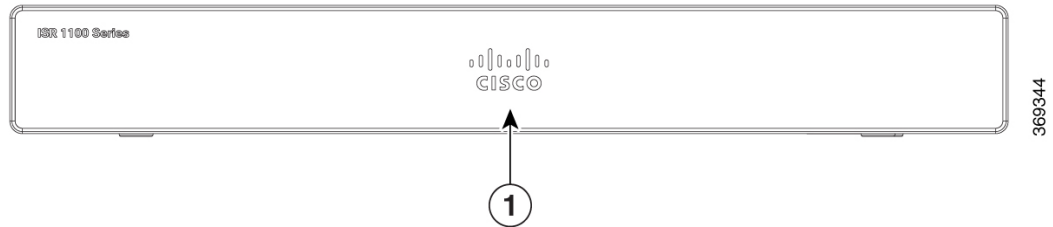

1	Non-illuminated Cisco logo	
---	----------------------------	--

Figure 17: C1121(X)-8PLTEPW I/O View

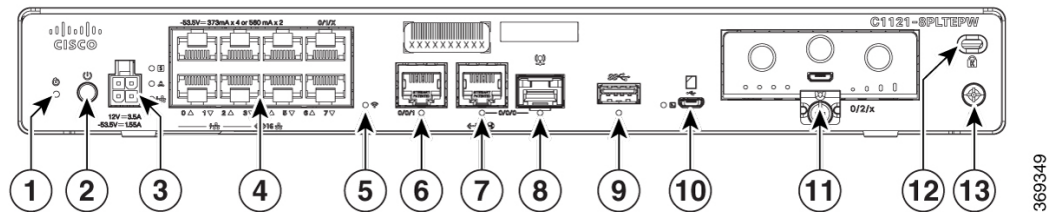

1	Reset Button	2	Power Switch
3	4-pin Power Connector	4	Ethernet Switch
5	Wi-Fi Status	6	GE 0/0/1
7	GE WAN 0/0/0 -RJ45	8	GE WAN 0/0/0 -SFP
9	Micro-USB console	10	USB 3.0
11	Pluggable	12	Kensington Lock Slot
13	Grounding		

Figure 18: C1127X-8PLTEP Bezel View

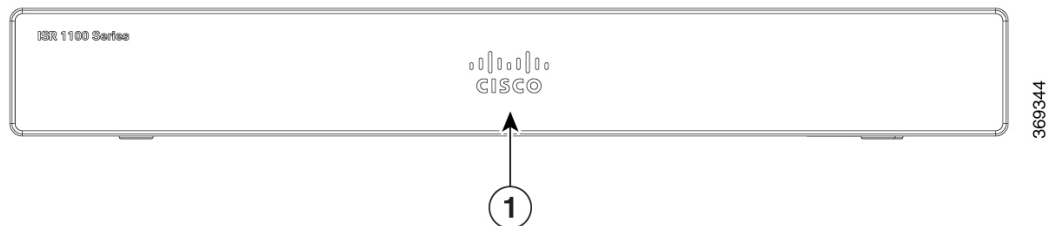

1	Non-illuminated Cisco logo	
---	----------------------------	--

Figure 19: C1127X-8PLTEP IO Panel View

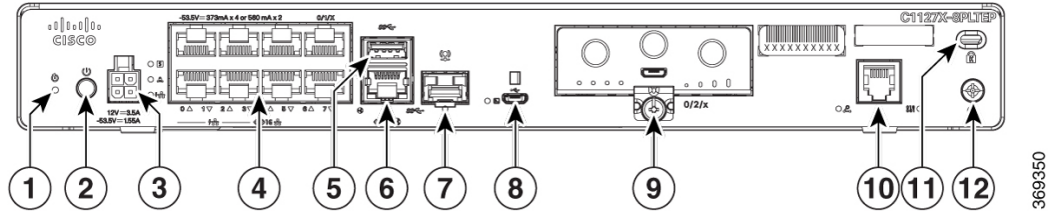

1	Reset Button	2	Power Switch
3	4-pin Power Connector	4	Ethernet Switch
5	RJ-45	6	GE WAN 0/0/0 -RJ45
7	GE WAN 0/0/0 -SFP	8	Micro-USB console
9	Pluggable	10	DSL
11	Kensington Lock Slot	12	Grounding

Figure 20: C1128-8PLTEP Bezel View

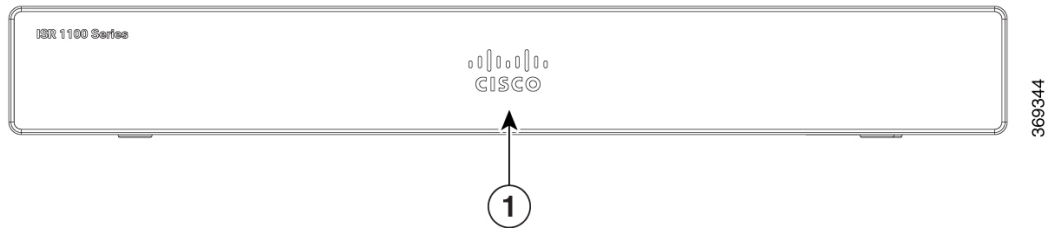

1	Non-illuminated Cisco logo
---	----------------------------

Figure 21: C1128-8PLTEP I/O Panel View

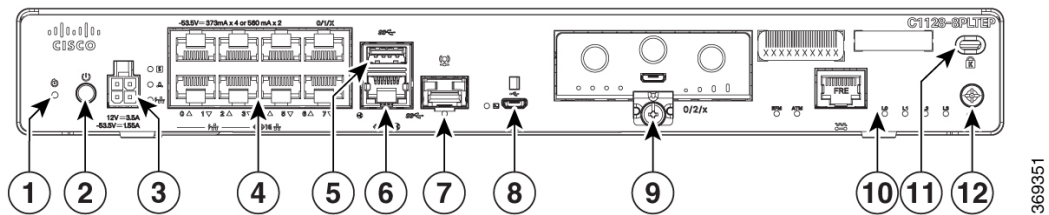

1	Reset Button	2	Power Switch
3	4-pin Power Connector	4	Ethernet Switch
5	USB 3.0	6	GE WAN 0/0/0 -RJ45
7	GE WAN 0/0/0 -SFP	8	Micro-USB console
9	Pluggable	10	SHDSL
11	Kensington Lock Slot	12	Grounding

LED Indicators

The following figures and table summarizes the LED indicators that are located in the bezel or chassis of the C111x series.

Figure 22: LED Indicators - Bezel Side

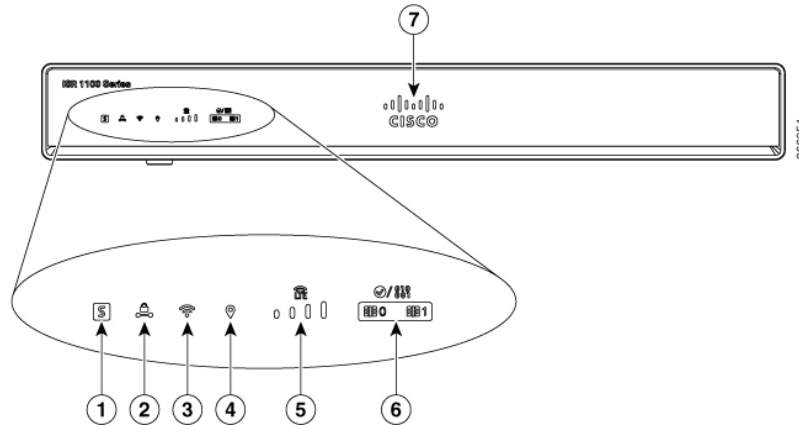

1	Status	2	VPN
3	WLAN	4	GPS
5	LTE RSSI/Mode	6	LTE DATA/SIM
7	Cisco Logo		

Figure 23: LED Indicators - I/O Side

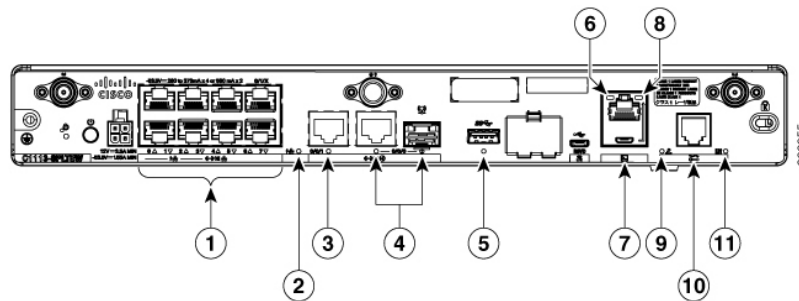

1	GE WAN Ports: 0-7 (0,2,4,6 at the top and 1,3,5,7 at the bottom)	2	PoE LED
3	GE1 LED	4	GE0 LED
5	USB LED	6	RJ-45 Console LED
7	USB Console	8	Micro USB Console LED
9	CD LED	10	DATA LED

Figure 24: Cisco 1121-4Px LED Indicators

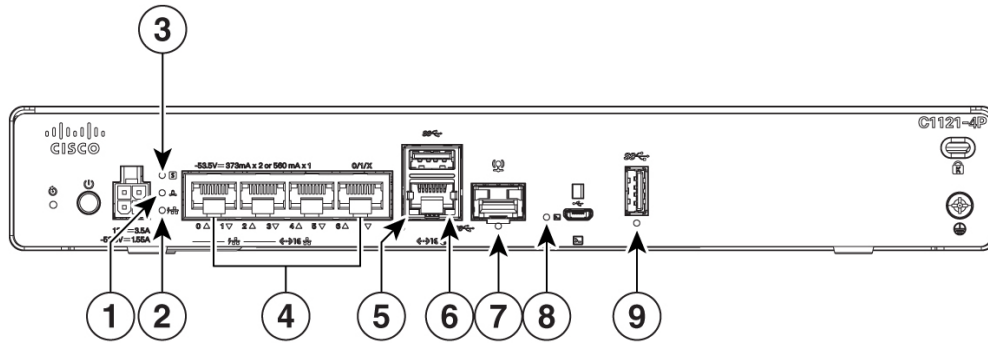

369352

1	VPN	2	PoE LED
3	Status	4	Ethernet Switch Ports 0-3
5	GE 0/0/0 RJ45 LED	6	GE 0/0/1 LED
7	GE 0/0/0 RJ45 LED	8	Micro USB Console LED
9	USB LED		

Figure 25: Cisco 1121-4PLTEP LED Indicators

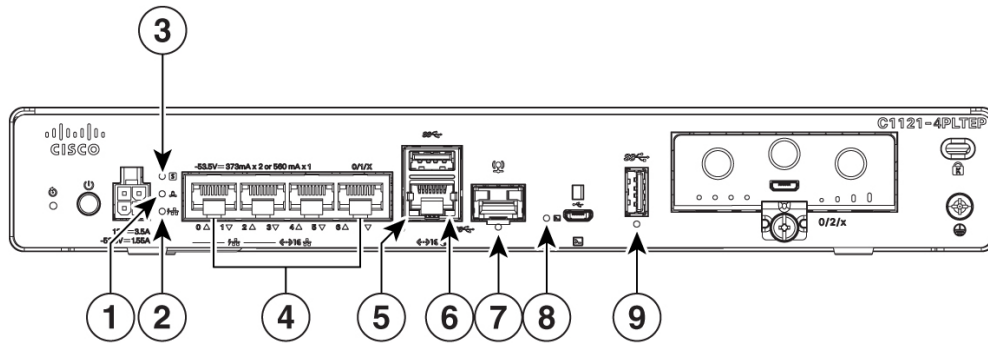

369353

1	VPN	2	PoE LED
3	Status	4	Ethernet Switch Ports 0-3
5	GE 0/0/0 RJ45 LED	6	GE 0/0/1 LED
7	GE 0/0/0 RJ45 LED	8	Micro USB Console LED
9	USB LED		

Figure 26: Cisco 11x1(X)-8P/ C11x1(X)-8PLTEP LED Indicators

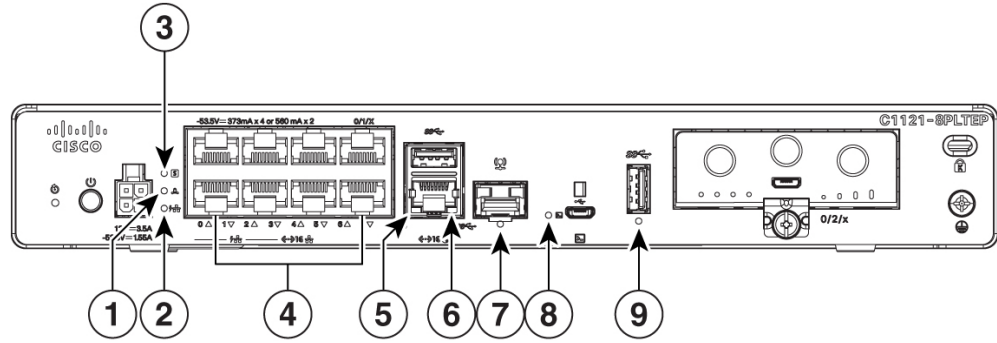

369354

1	VPN	2	PoE LED
3	Status	4	Ethernet Switch Ports 0-7 (0,2,4,6 at the top and 1,3,5,7 at the bottom)
5	GE 0/0/0 RJ45 LED	6	GE 0/0/1 LED
7	GE 0/0/0 RJ45 LED	8	Micro USB Console LED
9	USB LED		

Figure 27: Cisco 11x1(X)-8PLTEPWx LED Indicators

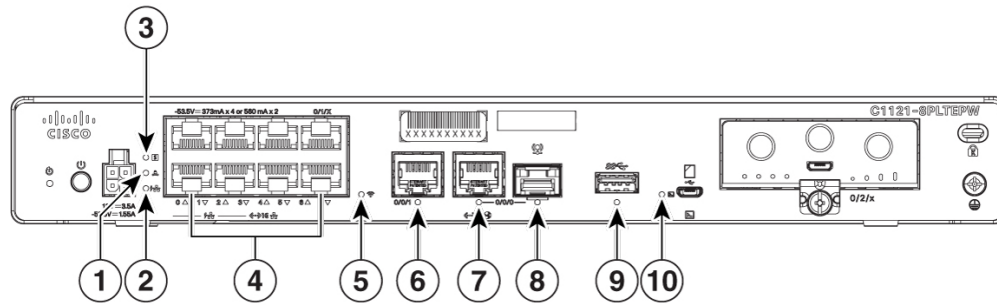

369355

1	VPN	2	PoE LED
3	Status	4	Ethernet Switch Ports 0-7 (0,2,4,6 at the top and 1,3,5,7 at the bottom)
5	Wi-Fi	6	GE 0/0/0 RJ45 LED
7	GE 0/0/1 LED	8	GE 0/0/0 SFP LED
9	USB LED	10	Micro USB Console LED

Figure 28: Cisco 1126(X)-8PLTEP/ C1127(X)-8PxLTEP LED Indicators

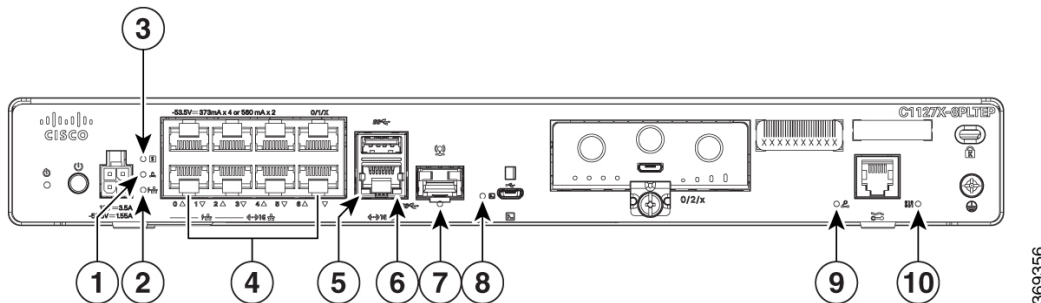

1	VPN	2	PoE LED
3	Status	4	Ethernet Switch Ports 0-7 (0,2,4,6 at the top and 1,3,5,7 at the bottom)
5	GE 0/0/0 RJ45 LED	6	USB5 LED
7	GE 0/0/0 SFP LED	8	Micro USB Console LED
9	CD LED		

The following table summarizes the LED indicators that are located in the bezel or chassis of the C111x series.

Table 2: LED Indicators for C111x

Port	LED Color	Description	Control Source
Cisco Logo	Blue	Illuminated Cisco logo. Indicates router power is good.	Bezel side
STATUS (System Status)	Green and Amber	Steady Green - System operates normally. Off—System is not out of reset or BIOS image is not loadable. Blinking Amber — BIOS/Rommon is booting. Steady Amber — BIOS/Rommon has completed booting, and the system is at the Rommon prompt or booting the platform software.	Bezel side. All models.

Port	LED Color	Description	Control Source
VPN OK	Green	Off—No tunnel.	Bezel side
		Steady On— At least one tunnel is up.	
LTE RSSI/Mode	Green and Amber	No LEDs On—No Service	Bezel Side
		1 LED On— RSSI is under -100dBm.	
		2 LEDs On— Low RSSI, -99dbm \diamond -90dBm.	
		3 LEDs On— Medium RSSI -89dBm \diamond -70dBm.	
		4 LEDs On— High RSSI, > -69dBm.	
		Green— LTE	
		Amber— 3G	
GPS	Green	Off: GPS not configured	Bezel Side
		On: GPS configured	
		Blink: GPS Acquiring	
WLAN	Green, Red, and Amber	Green— Normal operating condition with at least one wireless client association.	Bezel side
		Red—Ethernet link is not operational or Ethernet failure.	
		Amber—Software upgrade is in progress.	
Ethernet Switch GE LAN Ports, Non-PoE	Green	Off— No link	I/O side
		Steady On— link	
		Blink— TXD/RXD data	

Port	LED Color	Description	Control Source
Ethernet Switch GE LAN Ports, with PoE	Green and Amber	Off— No link, no device powered, PD denied power, power delivery fault PoE administratively disabled. Green Steady On— link; if PoE device, power is enabled. Green Blink— TXD/RXD data Amber - PoE Fault	I/O side
PoE OK	Green	Green Steady On— -53.5V PoE power supply connected and all powered port operating normally.	I/O side
		Off — No -53.5V PoE power supply connected to router.	
GE WAN Ports	Green	Off— No link	I/O side
		Steady On— link	
		Blink— TXD/RXD data	
DSL CD	Green	Off— Shut	I/O Side
		Green Blink— Training, or no shut and cable disconnected.	
		Green Steady On— Trained	
DSL Data	Green	Off— No Data Activity	I/O Side
		Green Blink— TX/RX Data	
Console	Green	Green On— Console enabled.	I/O side
USB Console	Green	Off— No USB device discovered.	I/O side
		On— USB device discovered.	

Port	LED Color	Description	Control Source
USB	Green	Off: No USB device discovered.	I/O Side
		On: USB device discovered.	

Table 3: LED Indicators for C1101 and C1109

LED	Color	Description	Control Source
Power	Green+Amber	System Power Status Off: No Power Green Steady On: Normal operation Green Blink: Boot up phase or in ROM Monitor mode Amber Steady on Or Blink: Some issues with the system.	I/O
VPN OK	Green	VPN Status Off: No tunnel Steady on: At least one tunnel is up	I/O
Ethernet Switch GE LAN Ports	Green	Link Activity Off: No link Steady on: Link Blink: TXD/RXD Data	I/O
GE WAN Ports	Green	Link Activity Off: No link Steady on: Link Blink: TXD/RXD Data	I/O

LED	Color	Description	Control Source
LTE DATA/SIM (C1101-4PLTEPWz C1101-4PLTEPC1101-4PLTEPWx)	Green and Amber	Single LTE Modem (one modem with SIM switch-over capability) Off: Modem not up or modem up and no SIM Amber Steady On: Modem up, SIM installed but not active. Green Blink: LTE data activity.	Bezel Side
WLAN (C1101-4PLTEPWx)	3-color LED: Green, Red & Amber;	WLAN Functions	I/O
USB Console	Green	USB Console Status OFF: USB console not active ON: USB console active	I/O
USB 3.0	Green	USB 3.0 Status OFF: No USB device discovered ON: USB device discovered USB activity	I/O

Reset Button

The actuation of the Reset button is only recognized during ROMMON boot, that is, as the router comes to the ROMMON prompt.

The Reset button does not require much force to be actuated. The Reset button should be actuated only with a small implement such as the tip of a pen or a paper clip. When the Reset button is pressed at startup, the system LED turns green.

For more information, see the "Reset Overview" section of the [Cisco 1100 Software Configuration Guide](#).

Power Supply

C111x Series ISRs support PoE and PoE+ power to endpoints. The product power specifications are as follows:

- AC input voltage: Universal 100 to 240 VAC
- Frequency: 50 to 60 Hz
- Maximum output power: Up to 66W for non-PoE supply and upto 150W for PoE supply

- Optional PoE and PoE+
- Output voltage: +12VDC for system power and -53.5VDC for PoE power

Slots and Interfaces

About Slots, Subslots, and Port Numbering

The Cisco 1100 series designates its interfaces using a 3-tuple notation that lists the slot, sub slot and port in the format slot/sub-slot/port. The slot number is reserved for the mother board, which is "0". Each interface type is allocated a sub slot and the port number is a unique port on the interface.

Table 4: Slot, Bay, and Port Numbering

Subslot	Interface Type
0	Ethernet LAN
1	Ethernet WAN
2	LTE
3	DSL
4	WIFI

Specifications of Cisco 1100 Series Integrated Services Routers

For specifications on the Cisco 1100 Series ISRs, refer to the [Cisco 1100 Series ISR Specifications](#) document.

Periodic Inspection and Cleaning

We recommend that you periodically inspect and clean the external surface of the router is recommended to minimize the negative impact of environmental dust or debris. The frequency of inspection and cleaning is dependent upon the severity of the environmental conditions, but we recommend a minimum once every six months. Cleaning involves vacuuming router air intake and exhaust vents.



Note Sites with ambient temperatures consistently above 25°C or 77°F and with potentially high levels of dust or debris might require periodic preventative maintenance cleaning.



CHAPTER 2

Prepare for Router Installation

Before you install the Cisco 1100 Series Integrated Services Routers, you must prepare your site for the installation. This chapter provides pre-installation information, such as recommendations and requirements that should be considered before installing your router.

See the following sections to prepare for installation:

- [Safety Recommendations, on page 23](#)
- [General Site Requirements, on page 24](#)
- [Rack Requirements, on page 25](#)
- [Router Environmental Requirements, on page 26](#)
- [Power Guidelines and Requirements, on page 27](#)
- [Network Cabling Specifications, on page 27](#)
- [Required Tools and Equipment for Installation and Maintenance, on page 30](#)

Safety Recommendations



Warning IMPORTANT SAFETY INSTRUCTIONS

This warning symbol means danger. You are in a situation that could cause bodily injury. Before you work on any equipment, be aware of the hazards involved with electrical circuitry and be familiar with standard practices for preventing accidents. Use the statement number provided at the end of each warning to locate its translation in the translated safety warnings that accompanied this device. Statement 1071

SAVE THESE INSTRUCTIONS



Warning Ultimate disposal of this product should be handled according to all national laws and regulations. Statement 1040.

Safety With Electricity



Warning Only trained and qualified personnel should be allowed to install or replace this equipment Statement 1030



Warning Do not locate the antenna near overhead power lines or other electric light or power circuits, or where it can come into contact with such circuits. When installing the antenna, take extreme care not to come into contact with such circuits, as they may cause serious injury or death. For proper installation and grounding of the antenna, please refer to national and local codes (for example, U.S.:NFPA 70, National Electrical Code, Article 810, Canada:Canadian Electrical Code, Section 54). Statement 1052

Prevent Electrostatic Discharge Damage

Electrostatic discharge (ESD) can damage equipment and impair electrical circuitry. It can occur if electronic printed circuit cards are improperly handled and can cause complete or intermittent failures. Always follow ESD prevention procedures when removing and replacing modules:

- Ensure that the router chassis is electrically connected to ground.
- Wear an ESD-preventive wrist strap, ensuring that it makes good skin contact. Connect the clip to an unpainted surface of the chassis frame to channel unwanted ESD voltages safely to ground. To guard against ESD damage and shocks, the wrist strap and cord must operate effectively.
- If no wrist strap is available, ground yourself by touching a metal part of the chassis.



Caution For the safety of your equipment, periodically check the resistance value of the anti-static strap. It should be between 1 and 10 megohms (Mohm).

General Site Requirements

This section describes the requirements your site must meet for the safe installation and operation of your router. Ensure that the site is properly prepared before beginning installation. If you are experiencing shutdowns or unusually high errors with your existing equipment, the guidelines provided in this section can also help you isolate the cause of failures and prevent future problems.



Warning Installation of the equipment must comply with local and national electrical codes. Statement 1074



Warning Connect the Chassis to Earth Ground—To reduce the risk of electric shock, the chassis of this equipment needs to be connected to permanent earth ground during normal use. Statement 445



Warning This product relies on the building's installation for short-circuit (overcurrent) protection. Ensure that the protective device is rated not greater than: 20A. Statement 1005



Warning To prevent bodily injury when mounting or servicing this unit in a rack, you must take special precautions to ensure that the system remains stable. The following guidelines are provided to ensure your safety:

- This unit should be mounted at the bottom of the rack if it is the only unit in the rack.
 - When mounting this unit in a partially filled rack, load the rack from the bottom to the top with the heaviest component at the bottom of the rack.
 - If the rack is provided with stabilizing devices, install the stabilizers before mounting or servicing the unit in the rack. Statement 1006.
-



Warning To prevent the system from overheating, do not operate the devices in an area that exceeds the maximum recommended ambient temperature:

Statement 1047



Warning For connections outside the building where the equipment is installed, the following ports must be connected through an approved network termination unit with integral circuit protection, LAN, PoE. Statement 1044.



Warning To prevent airflow restriction, allow clearance around the ventilation openings to be at least: 1.75 in. (4.4 cm). Statement 1076.

Site Selection Guidelines

The Cisco 1100 Series ISRs require specific environmental operating conditions. Temperature, humidity, altitude, and vibration can affect the performance and reliability of the router. The following sections provide specific information to help you plan for the proper operating environment.

The Cisco 1100 Series ISRs are designed to meet the industry EMC, safety, and environmental standards described in the Regulatory Compliance and Safety Information for the Cisco 1100 Series ISR document.

Rack Requirements

For the Cisco <platform name>, use brackets with a 19-inch rack.



Note Rack requirements is applicable only for <platform name> routers.

The following information can help you plan your equipment rack configuration:

- Allow clearance around the rack for maintenance.
- Allow at least one rack unit of vertical space between routers; more clearance is required when stacking multiple Cisco <platform name>. Provide adequate heat removal mechanism to keep the surrounding air temperature well within the specified operating temperature condition.



Note More spacing may be required depending on the installation environment.

- Enclosed racks must have adequate ventilation. Ensure that the rack is not congested, because each router generates heat. An enclosed rack should have louvered sides and a fan to provide cooling air. Heat generated by equipment near the bottom of the rack can be drawn upward into the intake ports of the equipment above it.
- When mounting a chassis in an open rack, ensure that the rack frame does not block the intake or exhaust ports. If the chassis is installed on slides, check the position of the chassis when it is seated in the rack.

Router Environmental Requirements

Cisco 1100 Series ISRs can be placed on a desktop, installed in a rack, or mounted on a wall. The location of your router and the layout of your equipment rack or wiring room are extremely important considerations for proper operation. Equipment placed too close together, inadequate ventilation, and inaccessible panels can cause malfunctions and shutdowns, and can make maintenance difficult. Plan for access to both front and rear panels of the router.



Note Only C111x Series support rack installation and DIN Rail mounting.

When planning your site layout and equipment locations, refer to the General Site Requirements , section. If you are currently experiencing shutdowns or an unusually high number of errors with your existing equipment, these precautions and recommendations may help you isolate the cause of failure and prevent future problems.

- Ensure that the room where your router operates has adequate air circulation. Electrical equipment generates heat. Without adequate air circulation, ambient air temperature may not cool equipment to acceptable operating temperatures.
- Always follow ESD-prevention procedures described in the Preventing Electrostatic Discharge Damage to avoid damage to equipment. Damage from static discharge can cause immediate or intermittent equipment failure.
- Baffles can help to isolate exhaust air from intake air, which also helps to draw cooling air through the chassis. The best placement of the baffles depends on the airflow patterns in the rack, which can be found by experimenting with different configurations.

- When equipment installed in a rack (particularly in an enclosed rack) fails, try operating the equipment by itself, if possible. Power off other equipment in the rack (and in adjacent racks) to allow the router under test a maximum of cooling air and clean power.

Power Guidelines and Requirements

Check the power at your site to ensure that you are receiving power that is free of spikes and noise. Install a power conditioner if necessary.

Power Guidelines and Requirements lists power requirements for the Cisco <platform name>.

Table 5: Power Requirements for <platform name>

Power Source	Input Rated	Output Rated
66W AC Power Adapter (PWR-66W-AC-V2)	100-240V, 2A	12 VDC, 5.5A
115W AC Power Adapter (PWR-115W-AC)	100-240VAC, 2A, 50-60 Hz	12V, 4.6A, -53.5V 1.12A
30W AC Power Adapter (PWR-30W-AC)	100-240 VAC, 1A	12V , 2.5A
150W AC Power Adapter (PWR-150W-AC)	100-240 VAC, 2A	12V 5.5A, -53.5 1.5A
66W DC Power Adapter (PWR-66W-I-DC)	24 V DC Nominal (19.7V DC to 30 V DC input range)	12 VDC, 5.5A

Network Cabling Specifications

The following sections describe the cables and their specifications required to install Cisco 1100 Series ISRs:

Console Port Connections



Warning

Invisible laser radiation may be emitted from the end of the unterminated fiber cable or connector. Do not view directly with optical instruments. Viewing the laser output with certain optical instruments (for example, eye loupes, magnifiers, and microscopes) within a distance of 100 mm may pose an eye hazard.

Fiber type and Core diameter (μm)	Wavelength (nm)	Max. Power (mW)	Beam divergence (rad)
SM 11	1200 - 1400	39 - 50	0.1 - 0.11
MM 62.5	1200 - 1400	150	0.18 NA
MM 50	1200 - 1400	135	0.17 NA
SM 11	1400 - 1600	112 - 145	0.11 - 0.13

The C111x has both EIA/TIA-232 asynchronous (RJ-45) and USB 5-pin micro Type B, 2.0 compliant serial console ports. The console ports do not have any hardware flow control. Shielded USB cables with properly terminated shields are recommended.

EIA/TIA-232

Depending on the cable and the adapter used, this port appears as a DTE or DCE device at the end of the cable. Only one port can be used at the same time.

The default parameters for the console port are 9600 baud, 8 data bits, 1 stop bit, and no parity. The console port does not support hardware flow control. For detailed information about installing a console terminal, see the Connecting to a Console Terminal or Modem section.

For cable and port pinouts, see the Cisco Modular Access Router Cable Specifications document located on Cisco.com.

USB Serial Console

The USB serial console port connects directly to the USB connector of a PC using a USB Type A to 5-pin micro USB Type-B cable. The USB Console supports full speed (12Mb/s) operation. The console port does not support hardware flow control.



Note Always use shielded USB cables with a properly terminated shield.

The default parameters for the console port are 9600 baud, 8 data bits, no parity, and 1 stop bit. For detailed information about installing a console terminal, see the Connecting to a Console Terminal or Modem section on page 3-19.

For operation with a Microsoft Windows OS version older than Windows 7, the Cisco Windows USB Console Driver must be installed on any PC connected to the console port. If the driver is not installed, prompts guide you through a simple installation process.

The Cisco Windows USB Console Driver allows plugging and unplugging the USB cable from the console port without affecting Windows HyperTerminal operations. No special drivers are needed for Mac OS X or Linux.

Only one console port can be active at a time. When a cable is plugged into the USB console port, the RJ-45 port becomes inactive. Conversely, when the USB cable is removed from the USB port, the RJ-45 port becomes active.

Baud rates for the USB console port are 1200, 2400, 4800, 9600, 19200, 38400, 57600, and 115200 bps.



Note 4-pin micro USB Type-B connectors are easily confused with 5-pin micro USB Type-B connectors. Only the 5-pin micro USB Type-B is supported.

USB Console OS Compatibility

- Windows 10, Windows 8, Windows 7, Windows 2000, Windows XP 32 bit, Windows Vista 32 bit
- Mac OS X version 10.5.4
- Redhat / Fedora Core 10 with kernel 2.6.27.5-117
- Ubuntu 8.10 with kernel 2.6.27-11
- Debian 5.0 with kernel 2.6
- Suse 11.1 with kernel 2.6.27.7-9

Console Port Considerations

The router includes an asynchronous serial console port. The console ports provide access to the router using a console terminal connected to the console port. This section discusses important cabling information to consider before connecting the router to a console terminal or modem.

Console terminals send data at speeds slower than modems do; therefore, the console port is ideally suited for use with console terminals.

Preparing for Network Connections

When setting up your router, consider distance limitations and potential electromagnetic interference (EMI) as defined by the applicable local and international regulations.

Network connection considerations are provided for:

See the following online document for more information about network connections and interfaces:

- Cisco Modular Access Router Cable Specifications

Ethernet Connections

The IEEE has established Ethernet as standard IEEE 802.3. The routers support the following Ethernet implementations:

- 1000BASE-T—1000 Mb/s full-duplex transmission over a Category 5 or better unshielded twisted-pair (UTP) cable. Supports the Ethernet maximum length of 328 feet (100 meters).
- 100BASE-T—100 Mb/s full-duplex transmission over a Category 5 or better unshielded twisted-pair (UTP) cable. Supports the Ethernet maximum length of 328 feet (100 meters).
- 10BASE-T—10 Mb/s full-duplex transmission over a Category 5 or better unshielded twisted-pair (UTP) cable. Supports the Ethernet maximum length of 328 feet (100 meters).

See the Cisco Modular Access Router Cable Specifications document at Cisco.com for information about Ethernet cables, connectors, and pinouts.

Required Tools and Equipment for Installation and Maintenance

You need the following tools and equipment to install and upgrade the router and its components:

- ESD-preventive cord and wrist strap
- Number 2 Phillips screwdriver
- Phillips screwdrivers: small, 3/16-in. (4 to 5 mm) and medium, 1/4-in. (6 to 7 mm)
 - To install or remove modules
 - To remove the cover, if you are upgrading memory or other components
- Screws that fit your rack
- Wire crimper
- Wire for connecting the chassis to an earth ground:
 - AWG 14 (2 mm²) or larger wire.
- An appropriate user-supplied UL or CSA certified ring terminal with an inner diameter of 1/4 in. (5 to 7 mm)



CHAPTER 3

Install and Connect the Router

This chapter describes how to install and connect Cisco 1000 Series Integrated Services Router (ISR) to LAN and WAN networks.



Warning

Read the installation instructions before using, installing or connecting the system to the power source. Statement 1004

Installing the Cisco 1000 Series Integrated Services Routers involve these tasks:

- [Unpack the Router, on page 31](#)
- [Set up Router on Desktop, Rack, or Wall, on page 31](#)
- [Connect Power Cable, on page 49](#)
- [Connect the Router to a Console, on page 51](#)
- [Connect WAN and LAN Interfaces, on page 55](#)
- [Configure the Router at Startup, on page 56](#)

Unpack the Router

Unpack the router only when you are ready to install it. If the installation site is not ready, to prevent accidental damage, keep the chassis in its shipping container until you are ready to install.

The router, accessory kit, publications, and any optional equipment you order may be shipped in more than one container. When you unpack the containers, check the packing list to ensure that you have received all listed items.

Set up Router on Desktop, Rack, or Wall

After unpacking, based on your requirements, you can set up a Cisco 1100 Series Integrated Services Routers (ISRs) on a desktop, a rack, or the wall.



Note You can install external modules before or after mounting a router. However, if you choose to install the external modules after mounting the router on the rack or wall, ensure that you have optimal access to the back/front panel of the router.

For information on modules and Field Replaceable Units (FRUs), see the [Install and Upgrade Modules and FRUs](#) section.

Depending on the model, the available options for mounting a Cisco 1100 ISR are:

Table 6: Models and Mounting Options

Model	Mounting Options
C111x and C1111X	Desktop , Rack Mount , Wall Mount using Key-hole Slots , Wall Mount using-Din-Rail
C1101-4P	Desktop , Wall Mount using Key-hole Slots
C1101-4PLTEPwX	Desktop , Wall Mount using Key-Hole Slots
C1109-2PLTExx	Desktop , Wall Mount using Key-Hole Slots ,
C1121-4Px	Desktop , Rack Mounting using Din-Rail Brackets , Under Desk
C1126(X)-8PLTEP	Desktop , Rack Mounting using Din-Rail Brackets , Under Desk
C1128(X)-8PLTEP	Desktop , Rack Mounting using Din-Rail Brackets , Under Desk

If you choose to setup the router on a desktop, you can place the router on a desktop, bench top or on a shelf.

Rack Mount

The router is shipped with rack mounting brackets that are to be secured on the sides of the chassis. You must first secure rack mounting brackets on the chassis before you set up the chassis on the rack.



Caution Do not stack multiple Cisco 1000 ISRs when mounting the routers on a table top.



Note When mounting Cisco 1000 ISRs on a rack, ensure that there is ample surrounding space. This ensures more heat removal, which in turn will enable the surrounding air temperature to stay within the specified operating conditions.

Attach the Brackets for C111x

This procedure describes how to attach the brackets on the router chassis:

Step 1 Secure the brackets to the router chassis (on the left) as shown in figure below:

Example:

Figure 29: Bracket Installation for Left-Side Mounting - C111x

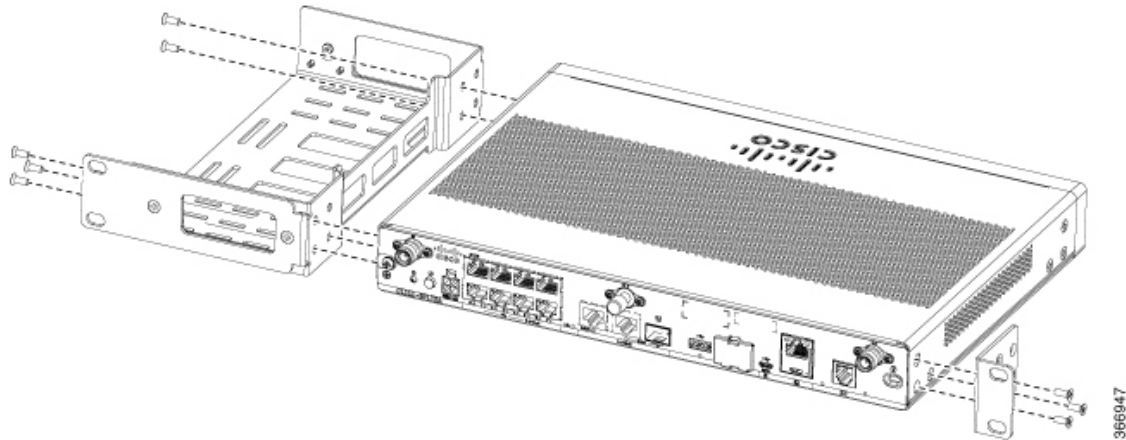

Step 2 Similarly, secure the brackets on the right-side of the chassis for mounting the router.

Attach the Rack Mounting Brackets for C112x

This procedure describes how to attach the brackets on the router chassis:

Step 1 Remove the 6 screws from the bottom of the chassis.

Step 2 Place the platform into the bottom tray.

Step 3 Secure the original screws from the bottom side of the tray.

Example:

Figure 30: Bracket Installation for C1121-4Px, C1126-8PLTEP and C1128-8PLTEP

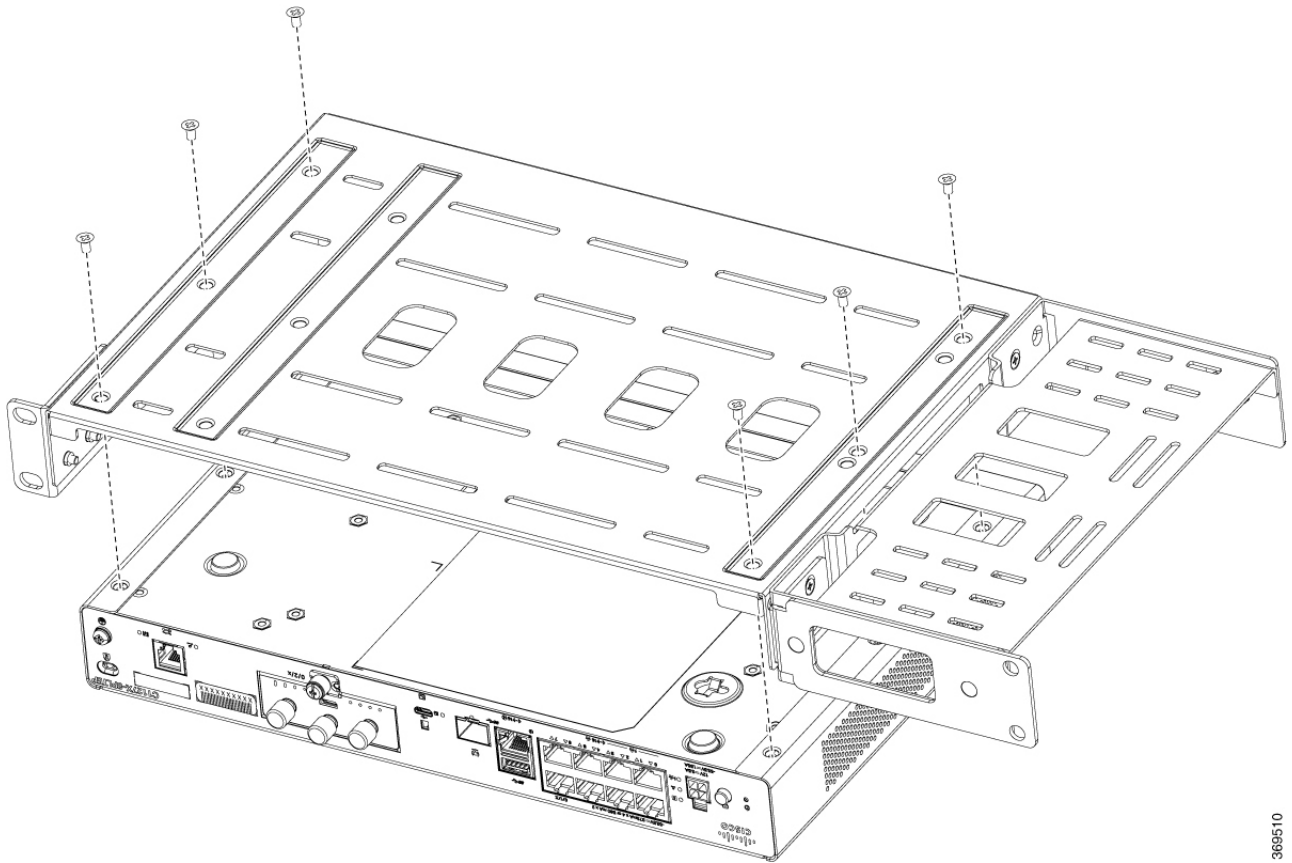

369510

Mount the Router

Before mounting the router on to the rack, refer to the following safety warning statements:



Warning

To prevent airflow restriction, allow clearance around the ventilation openings to be at least: 1.75 in. (4.4 cm). Statement 1076.



Warning

- To prevent bodily injury when mounting or servicing this unit in a rack, you must take special precautions to ensure that the system remains stable. The following guidelines are provided to ensure your safety:
- This unit should be mounted at the bottom of the rack if it is the only unit in the rack.
- When mounting this unit in a partially filled rack, load the rack from the bottom to the top with the heaviest component at the bottom of the rack.
- If the rack is provided with stabilizing devices, install the stabilizers before mounting or servicing the unit in the rack. Statement 1006.

Procedure

	Command or Action	Purpose
Step 1	To install the router, use the screws provided with the accessory kit to secure the router when you mount it on the rack.	

Mount the Router under a Desk or a Shelf

Installing the router under a desk requires an optional bracket kit that is not included with the router. The kit contains the rack-mount brackets and screws to secure the brackets to the router and the underside of the desk. You can order these kits from your Cisco representative. This procedure describes how to mount router under a desk or a shelf .

Step 1 Attach a bracket to one side of the router using the flat-head screws. Follow the same steps to attach the second bracket to the opposite side.

Figure 31: Attaching Brackets to the Router

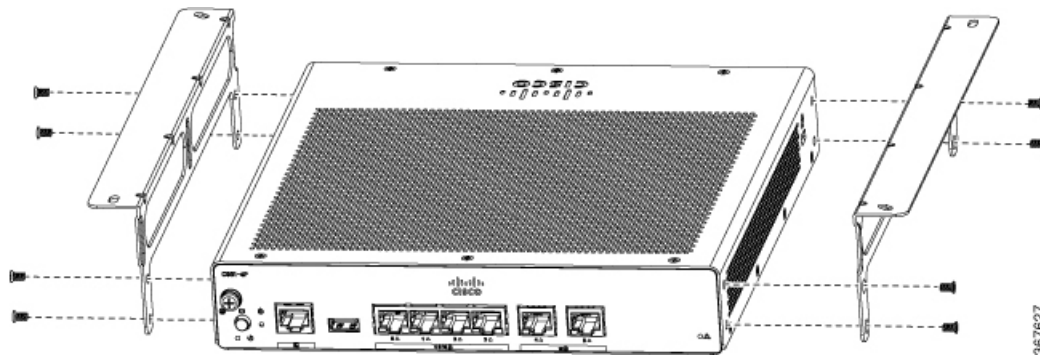

Figure 32: Flat-head Machine Screws

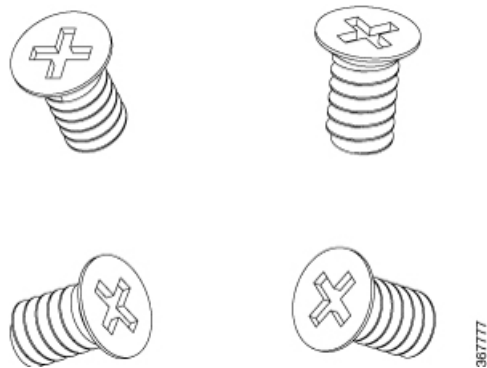
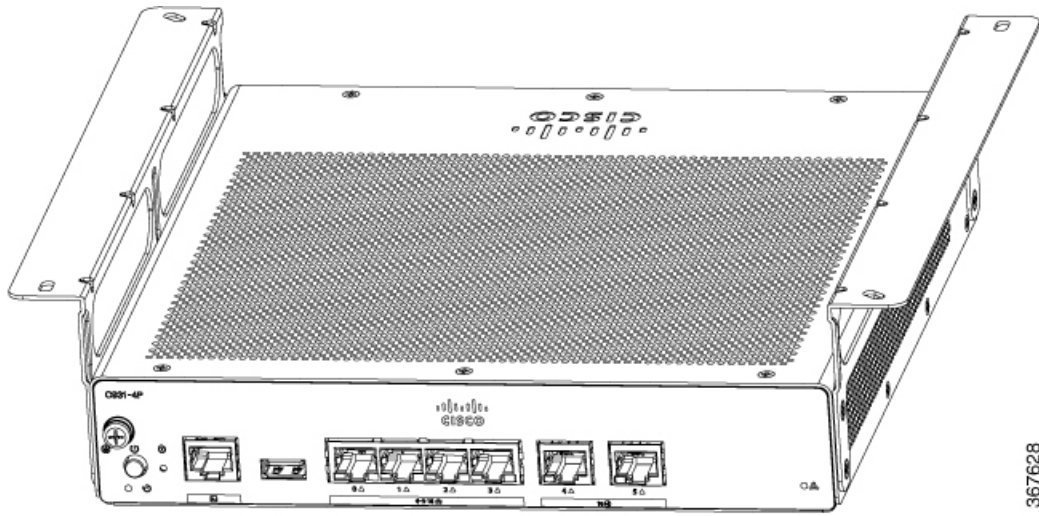

Figure 33: Router with Brackets Attached

**Step 2**

After the brackets are attached, drill a 2 mm hole under the desk and insert the wooden screws provided. Mount the router under the desk or shelf using the pan-head wood screws).

Figure 34: Mounting the Router under a Desk or Shelf

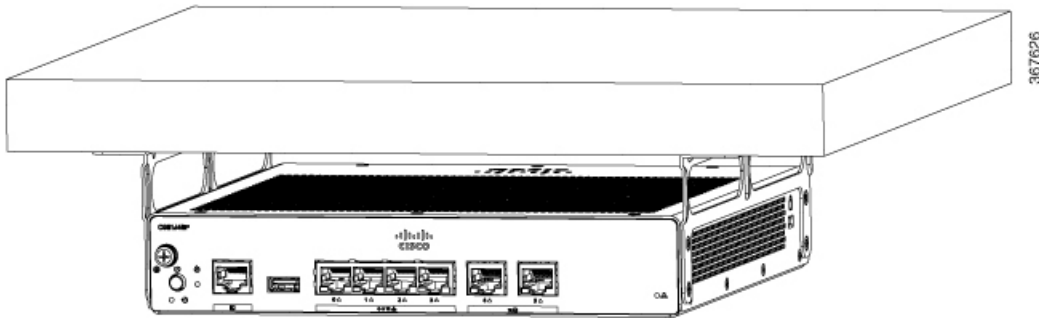

Figure 35: Pan-head Wood Screws



Mount Router using DIN Rail Brackets

The router is shipped with DIN Rail brackets that are to be secured on the bottom side of the chassis. Your chassis installation must allow unrestricted airflow for chassis cooling.

To attach the DIN Rail brackets to the router chassis, use the PHMS screws and the plastic spacers provided for each bracket.

Attach Din-Rail Brackets on C112x

This procedure describes how to attach the brackets on the router chassis:

- Step 1** Remove the 3 bottom screws from the chassis.
- Step 2** Place the din-rail tray assy on the bottom side of the chassis.
- Step 3** Secure the original screw from bottom side of tray, leverage the existing chassis screws to secure the din rail mounting bracket from the bottom of the chassis.
- Step 4** Take the other two screws to secure the din-rail tray assy

Example:

Figure 36: Attaching Din Rail Brackets for C1121-4Px, C1126-8PLTEP and C1128-8PLTEP

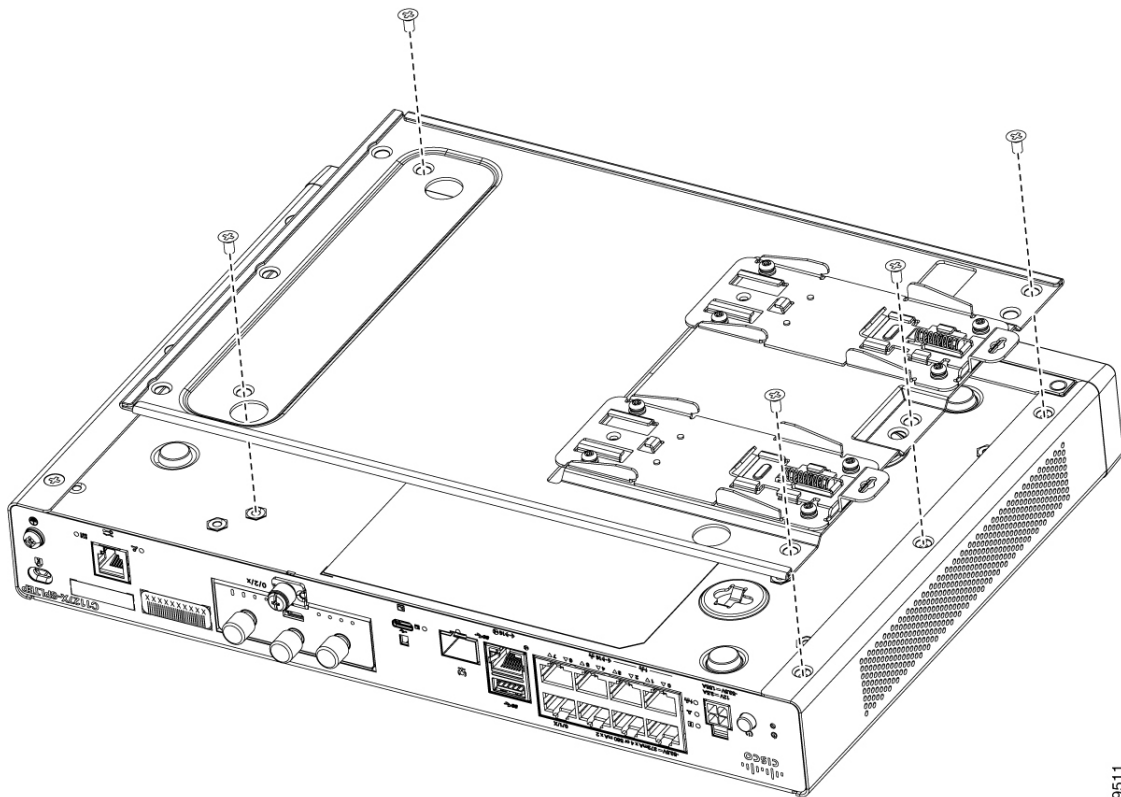

369511

Wall Mount the Router

Depending on the models of the Cisco 1100 Series Integrated Services Routers (ISRs), the tasks for mounting the router chassis on the wall may vary.



Warning

Read the wall-mounting instructions carefully before beginning installation. Failure to use the correct hardware or to follow the correct procedures could result in a hazardous situation to people and damage to the system. Statement 378.



Note

The recommended clearance when a router is horizontally mounted is 1.5 inches on both sides for clearance and 1.75 inches on top. I/O side clearance is needed as it is required to access the cable connections. Clearance is not required on the backside (opposite side from I/O face) unless mounting on a DIN Rail. Clearance is required to attach and mount the DIN rail bracket.

There are two ways to mount a router on the wall, using Key-hole Slots and DIN Rail Brackets.

Wall Mount Using Key-hole Slots

The Cisco 1100 Series Integrated Services Routers (ISRs) have key-hole slots at the bottom of the chassis for mounting on a wall or any vertical surface.



Note

Do not mount the router with the output ports facing downwards. For the C111x series, ensure that the cables are placed on the sides.



Note

When choosing a location for wall mounting the router, consider cable limitations and wall structure.



Note

To attach a router to the wall stud, each bracket should have one number10 wood screw (pan-head) with number10 washers, or two number10 washer-head screws. The screws must be long enough to penetrate at least 1.5 inches (38.1 mm) into the supporting wood or metal wall stud.



Note

For hollow-wall mounting, each bracket requires two wall anchors with washers. Wall anchors and washers must be size number 6 (pan-head). Route the cables so that they do not put a strain on the connectors or mounting hardware.

Figure 37: Wall Mount Using Key-hole Slots - C111x

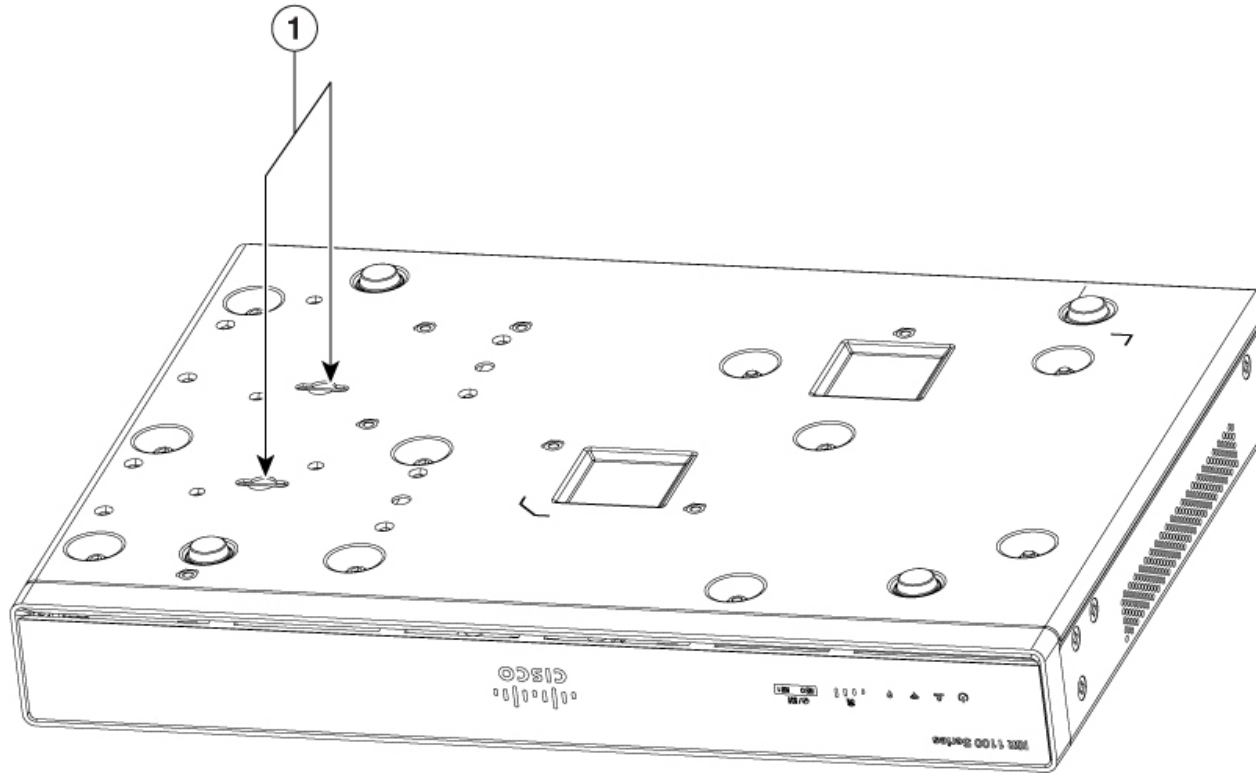

1	Key-hole slots
---	----------------

Figure 38: Wall Mount Orientation-C111x

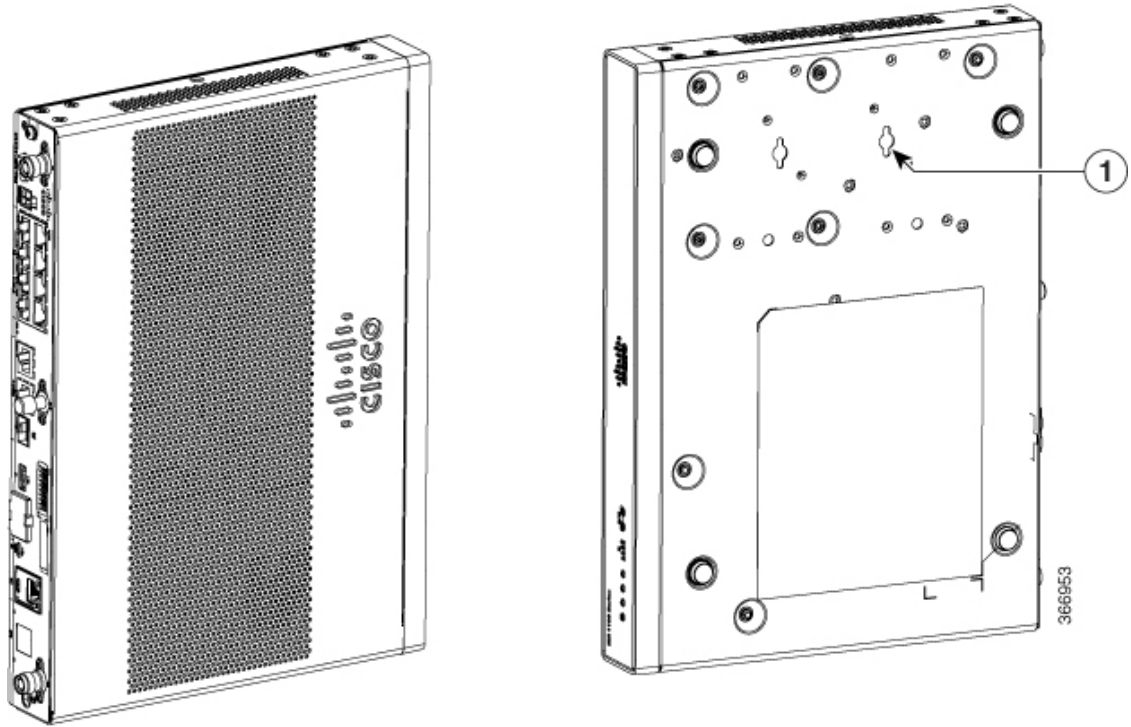

1	Key-hole slots
---	----------------

Figure 39: Wall mount using key-hole slots - C1101-4P

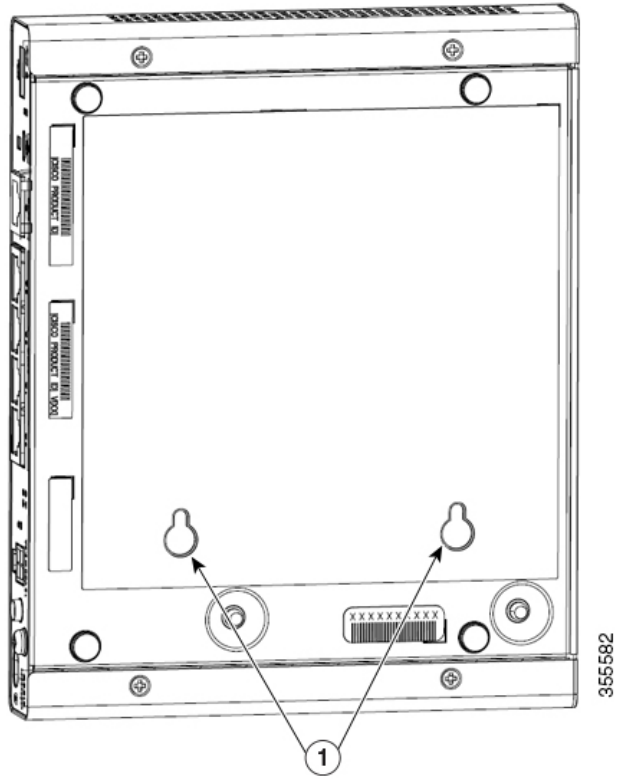

1	Key-hole slots Key-hole slots-spacing: 3.024in (76.81mm)
---	---

Figure 40: Wall mount using key-hole slots - C1101-4PLTEP

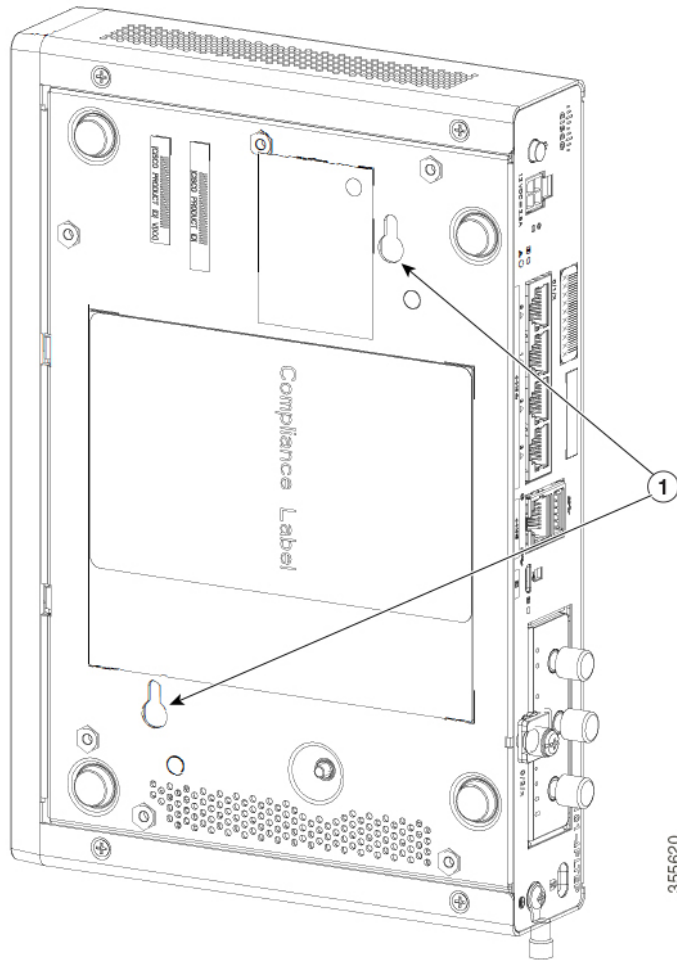

1	<p>Key-hole slots</p> <p>Horizontal spacing: 3.100in (78.74mm)</p> <p>Vertical spacing: 5.758in (146.25mm)</p>
---	--

Figure 41: Wall mount using key-hole slots - C1109-2P

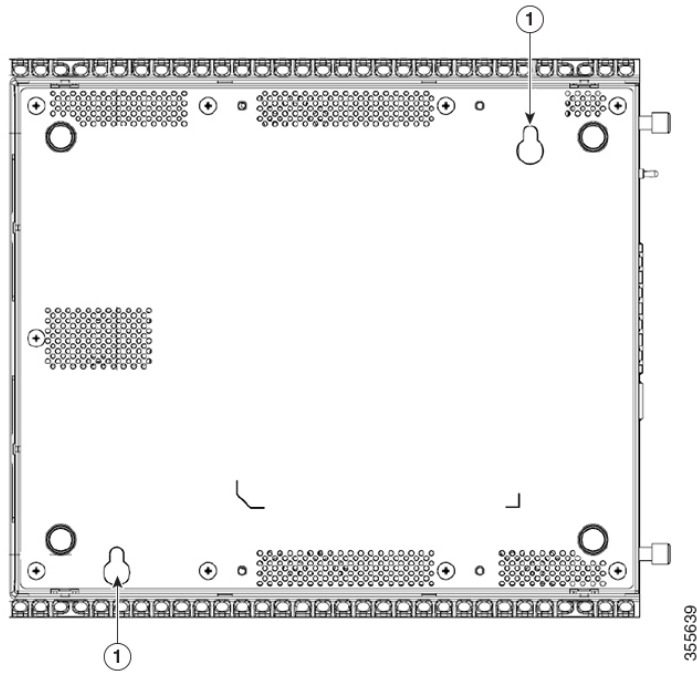

<p>1 Key-hole slots</p>	<p>Horizontal spacing: 7.302in (185.47mm) Vertical spacing: 7.430in (188.72mm)</p>
-----------------------------	--

Figure 42: Wall mount using key-hole slots - C1109-4PLTEP

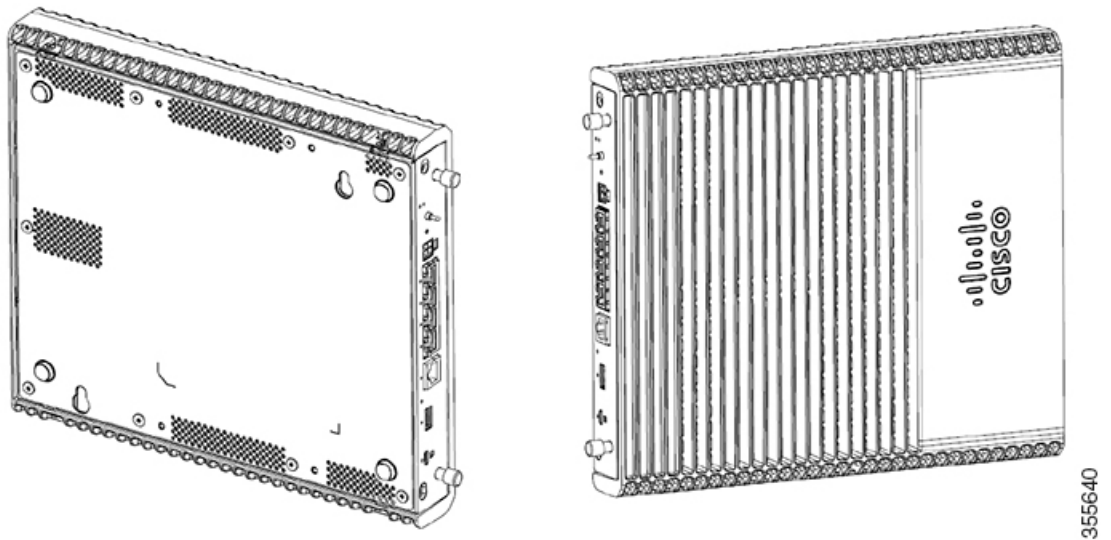

1	<p>Key-hole slots</p> <p>Horizontal spacing: 3.100in (78.74mm)</p> <p>Vertical spacing: 5.758in (146.25mm)</p>
---	--

Figure 43: Wall mount using key-hole slots - C1126-8PLTEP

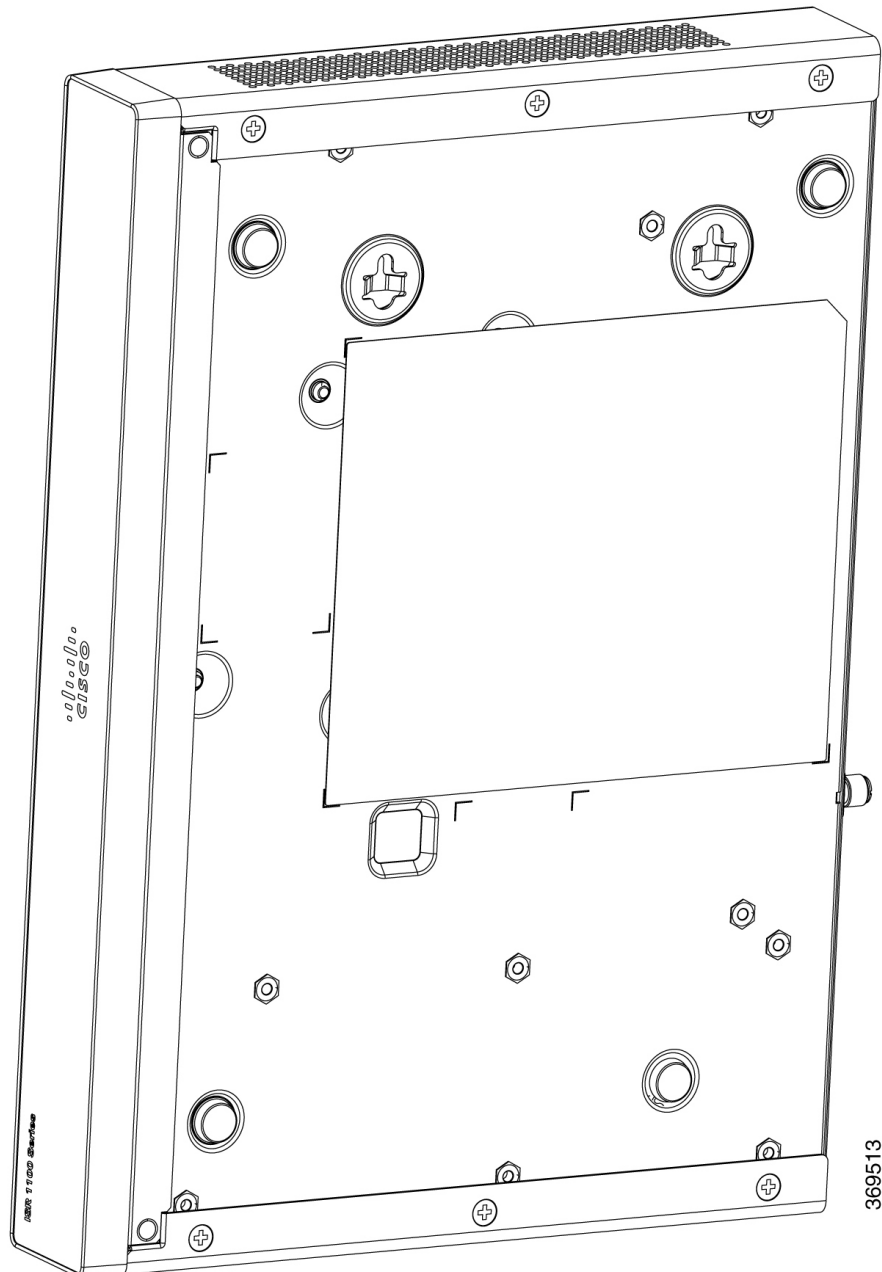

1	Key-hole slots Horizontal spacing: < > Vertical spacing: < >
---	--

Wall Mount using DIN Rail Brackets

The router is shipped with DIN Rail brackets that are to be secured on the bottom side of the chassis. Your chassis installation must allow unrestricted airflow for chassis cooling.



Note Wall mount using DIN Rail brackets is applicable only for C111x.

To attach the DIN Rail brackets to the router chassis, use the PHMS screws and the plastic spacers provided for each bracket.

Figure 44: DIN Rail Bracket Installation - C111x and C111X

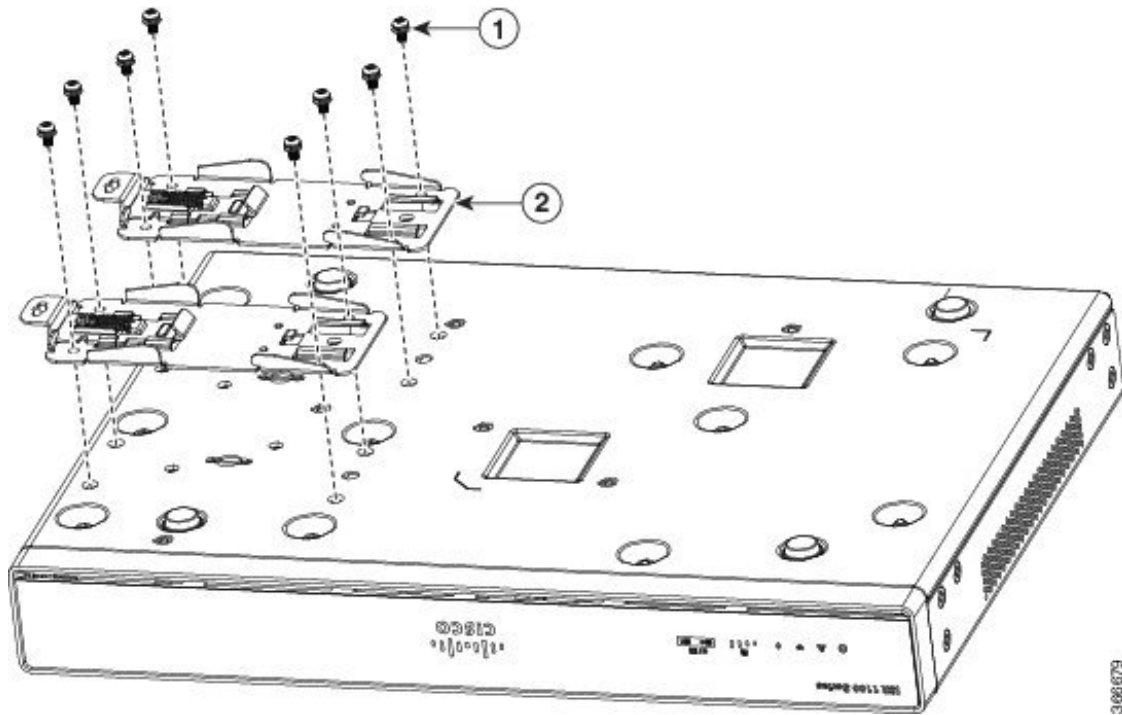

1	Screws
2	DIN Rail Brackets

Figure 45: Orientation of DIN Rail Brackets

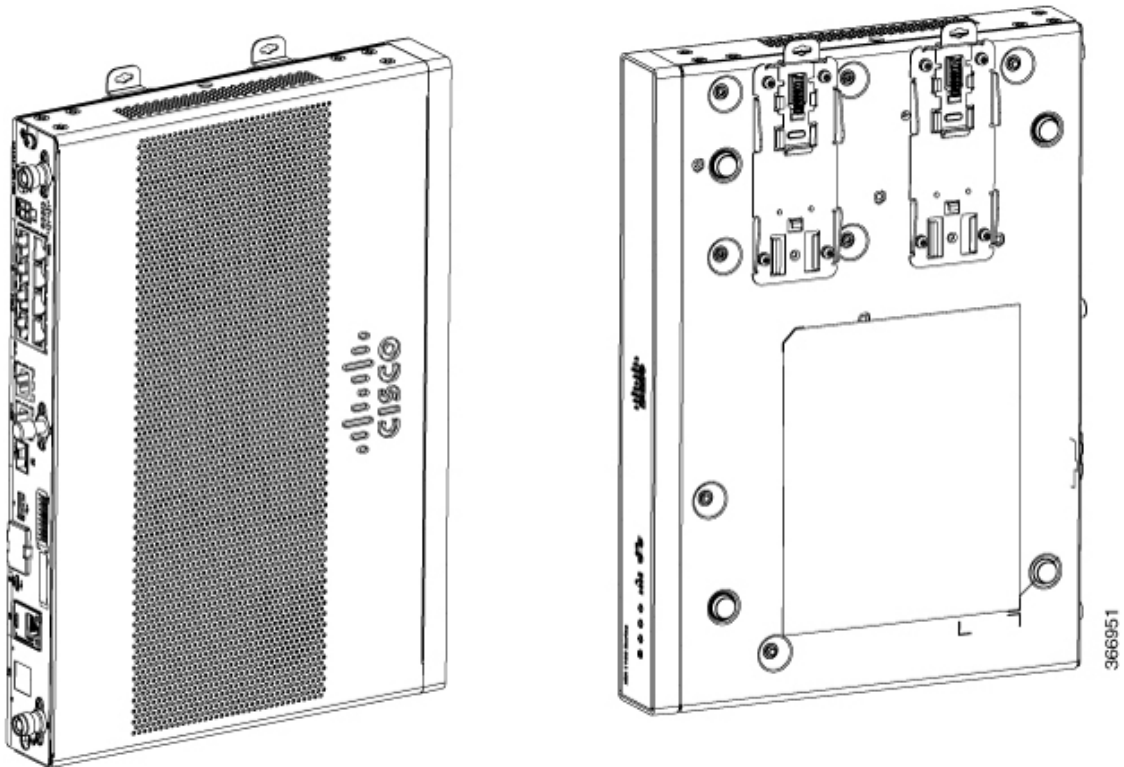
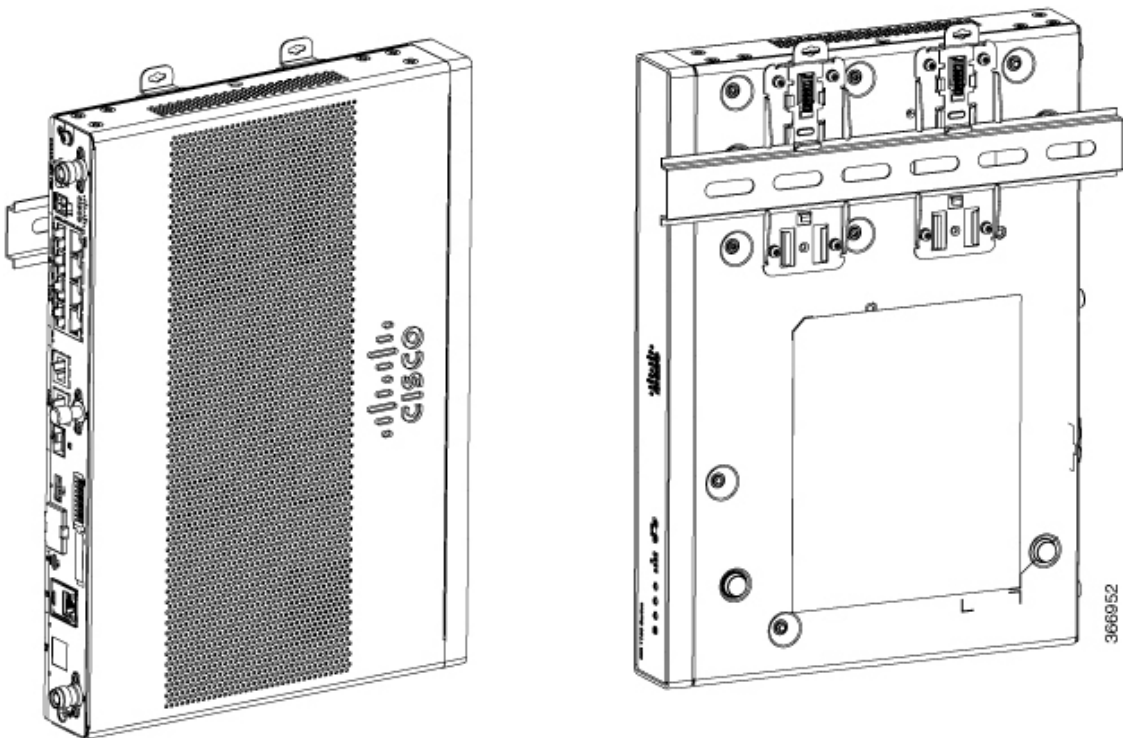

Figure 46: DIN Rail Brackets and Mount



Note Do not over-torque the screws. The recommended torque is 8 to 10 inch-lbf (0.9 to 1.1 N-m).

Chassis Grounding



Warning

Connect the Chassis to Earth Ground—To reduce the risk of electric shock, the chassis of this equipment needs to be connected to permanent earth ground during normal use. Statement 445



Warning

Only trained and qualified personnel should be allowed to install or replace this equipment Statement 1030

After you set up the router, connect the chassis to a reliable earth ground; the ground wire must be installed in accordance with local electrical safety standards. For safety information on grounding the chassis, refer to the chassis ground connection procedures.

1. For grounding the chassis, use a copper wire of size of 14 AWG (2 mm²) and the ground lug. These are not a part of the accessory kit.
2. Use the UNC 6-32 screws, which have a length of about 0.25 inches.

To install the ground connection for your router, perform these steps:

1. Strip one end of the ground wire to the length required for the ground lug or terminal.
 - For the ground lug—approximately 0.75 inch (20 mm)
 - For user-provided ring terminal—as required
2. Crimp the ground wire to the ground lug or ring terminal, using a crimp tool of the appropriate size.
3. Attach the ground lug or ring terminal to the chassis as shown in the below figures. The screw for the ground lug is provided. Tighten the screw; the recommended torque is 8 to 10 inch-lbf (0.9 to 1.1 N-m).

Figure 47: Chassis Ground Connection-Cisco 111x

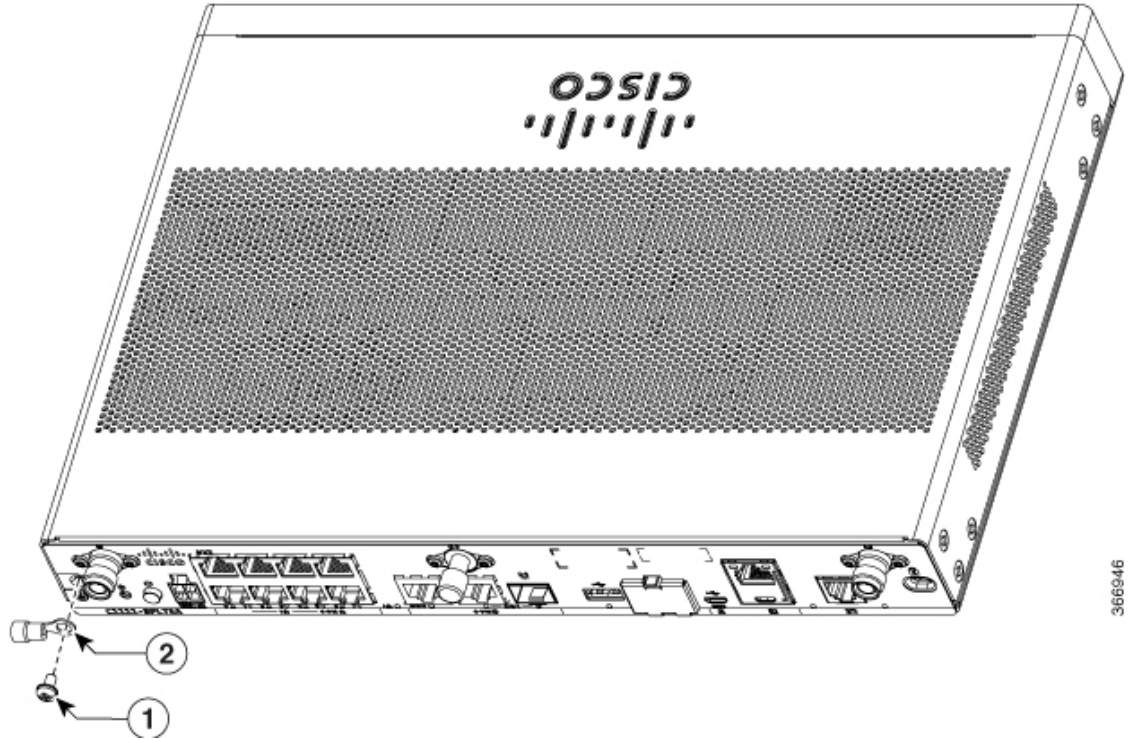

1	Screw (UNC 6-32)
2	Ground Lug

Figure 48: Chassis Ground Connection-Cisco 1101-4PLTEP

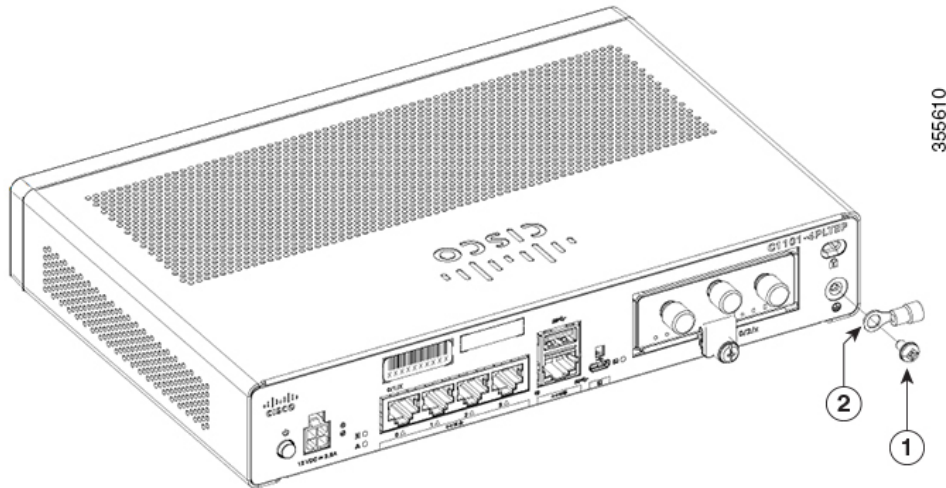

1	Screw (UNC 6-32)
---	------------------

2	Ground Lug
---	------------

Figure 49: Chassis Ground Connection-Cisco 1121X-8PLTEP

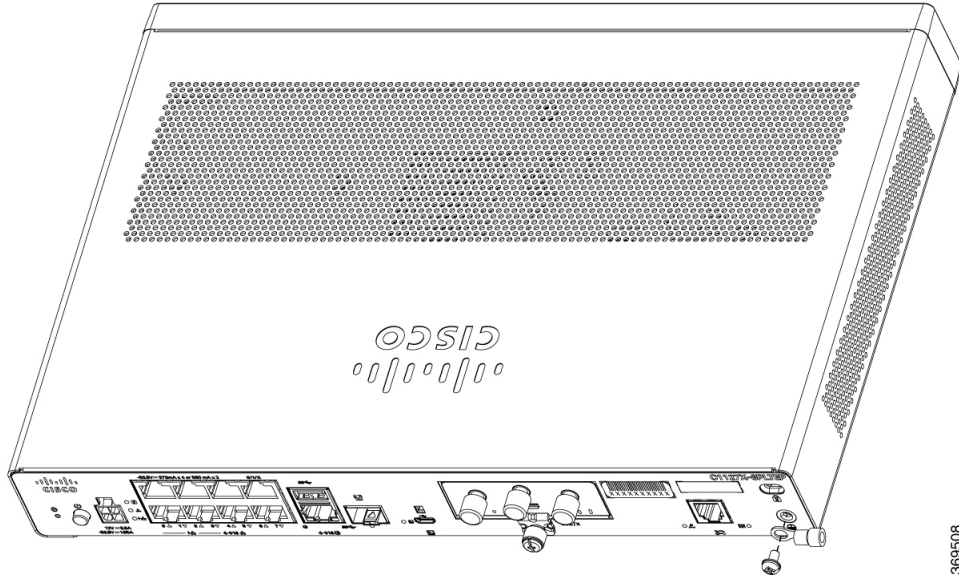

1	Screw (UNC 6-32)
2	Ground Lug

Connect Power Cable

Power supply of the Cisco 1000 Series ISRs is an external AC to DC power adapter. The external DC power connector plugs into the router's 4 points power connector.

Figure 50: Power Cable for C111x

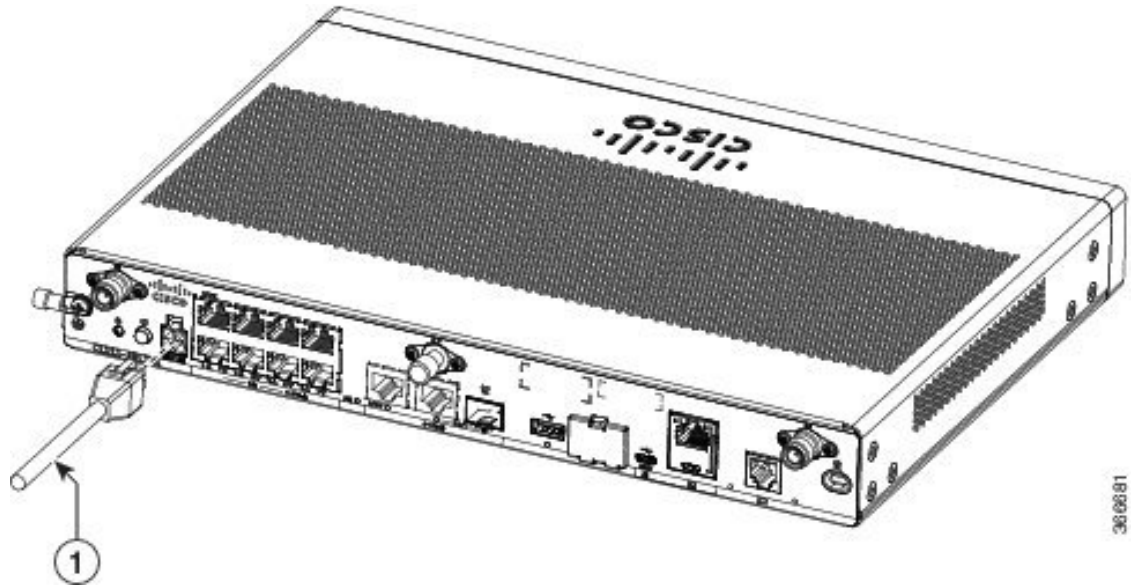

1.

Power Cable

Figure 51: Power Cable for C1127-8PLTEP

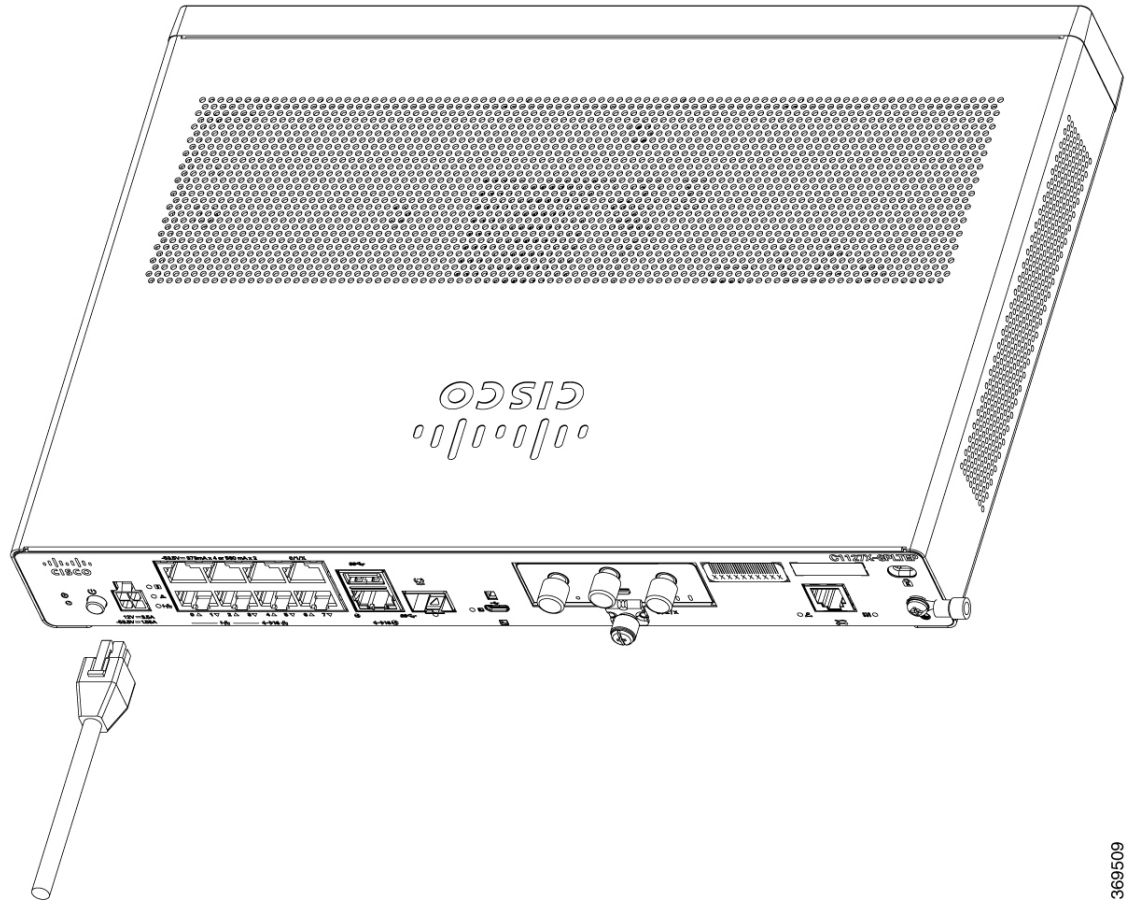

369509

1.	Power Cable
----	-------------

Connect the Router to a Console

The C111x Series ISR has an asynchronous serial port. This port provides administrative access to the router through a console terminal or a PC.

Figure 52: Console Adapter for C1101-4PLTEP

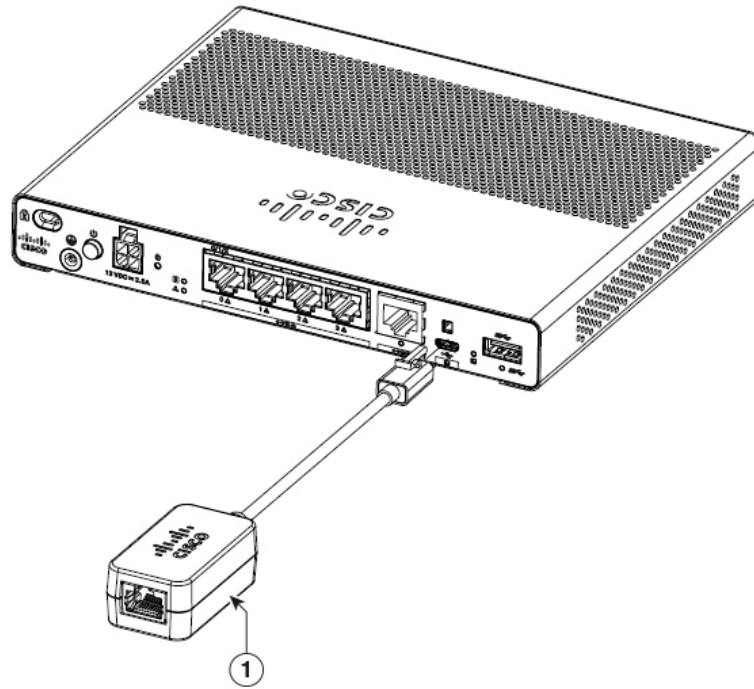

355619

1.	Micro USB to RJ45 console adapter
----	-----------------------------------

Figure 53: Console Adapter for C1127X-8PLTEP

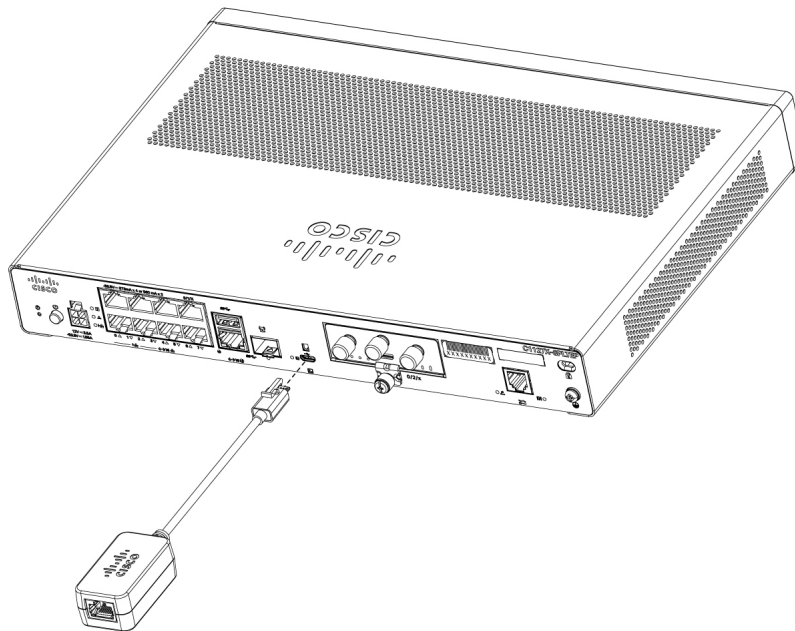

366507

1.	Micro USB to RJ45 console adapter
----	-----------------------------------

Use the USB or RJ-45 console port on the router to access the Cisco Internet Operating System (IOS-XE) command line interface (CLI) on the router and perform configuration tasks. A terminal emulation program is required to establish communication between the router and a PC.

To configure the router through the Cisco IOS CLI, you must establish a connection between the router console port and either a PC or a terminal.

Use the following cables and adapters to establish a local or remote connection.

Table 7: Local and Remote Connections

Port Type	Cable	Action
Serial (RJ-45)	C111x,C1111X: RJ-45 Serial console cable CAB-CON-USB (Serial USB to RJ-45 serial cable)	Connecting to the Serial Port with Microsoft Windows
Serial (USB)	C110x: CAB-CON-USB RJ45	

Connect to the Serial Port with Microsoft Windows

To establish a physical connectivity between the router and a PC, you need to install a Microsoft Windows USB.

Use the USB Console cable plugged into the USB serial port to establish this connection.

1. Connect the end of the console cable with the RJ-45 connector to the light blue console port on the router.
2. OR

Connect a USB 5-pin micro USB Type-B to the USB console port. If you are using the USB serial port for the first time on a Windows-based PC, install the USB driver.



Note You cannot use the USB port and the EIA port concurrently. When the USB port is used it takes priority over the RJ-45 EIA port.

3. Connect the end of the cable with the DB-9 connector (or USB Type-A) to the terminal or PC. If your terminal or PC has a console port that does not accommodate a DB-9 connector, you must provide an appropriate adapter for that port.
4. Start a terminal emulator application to communicate with the router. Configure the software with the following parameters:
 - 9600 baud
 - 8 data bits
 - no parity
 - 1 stop bit
 - no flow control

Connect to the Console Port with Mac OS X

This procedure describes how to connect a Mac OS X system USB port to the console using the built in OS X Terminal utility.

-
- Step 1** Use the Finder to go to Applications > Utilities > Terminal.
 - Step 2** Connect the OS X USB port to the router.
 - Step 3** Enter the following commands to find the OS X USB port number

Example:

```
macbook:user$ cd /dev
macbook:user$ ls -ltr /dev/*usb*
crw-rw-rw-  1 root   wheel      9,  66 Apr  1 16:46 tty.usbmodem1a21 DT-macbook:dev user$
```

- Step 4** Connect to the USB port with the following command followed by the router USB port speed

Example:

```
macbook:user$ screen /dev/tty.usbmodem1a21 9600
```

To disconnect the OS X USB console from the Terminal window

Enter Ctrl-a followed by Ctrl-\

Connect to the Console Port with Linux

This procedure shows how to connect a Linux system USB port to the console using the built in Linux Terminal utility.

-
- Step 1** Open the Linux Terminal window.
 - Step 2** Connect the Linux USB port to the router.
 - Step 3** Enter the following commands to find the Linux USB port number

Example:

```
root@usb-suse# cd /dev
root@usb-suse /dev# ls -ltr *ACM*
crw-r--r--  1 root   root      188,  0 Jan 14 18:02 ttyACM0
root@usb-suse /dev#
```

- Step 4** Connect to the USB port with the following command followed by the router USB port speed

Example:

```
root@usb-suse /dev# screen /dev/ttyACM0 9600
```

To disconnect the Linux USB console from the Terminal window

Enter Ctrl-a followed by : then quit

Connect WAN and LAN Interfaces

This section describes how to connect WAN and LAN interface cables. Before you connect the interface cables, refer to the following warning statements:



Warning Never install telephone jacks in wet locations unless the jack is specifically designed for wet locations. Statement 1036.



Warning Never touch uninsulated telephone wires or terminals unless the telephone line has been disconnected at the network interface. Statement 1037.



Warning For connections outside the building where the equipment is installed, the following ports must be connected through an approved network termination unit with integral circuit protection, LAN, PoE. Statement 1044.



Warning Avoid using or servicing any equipment that has outdoor connections during an electrical storm. There may be a risk of electric shock from lightning. Statement 1088.

Ports and Cabling

This section summarizes typical WAN and LAN connections for Cisco 1100 Series ISRs. The connections summarized here are described in detail in the Cisco Modular Access Router Cable Specifications document on cisco.com.

Table 8: WAN and LAN Connections

Port or Connection	Port Type, Color ¹	Connection	Cable
Ethernet	RJ-45, yellow	Ethernet hub or Ethernet switch	Category 5 or higher Ethernet
Gigabit Ethernet SFP, optical	LC, color according to optical wavelength	1000BASE-SX, -LX, -LH, -ZX, -CWDM	Optical fiber as specified on applicable data sheet
Gigabit Ethernet SFP, copper	RJ-45	1000BASE-T	Category 5, 5e, 6 UTP
xDSL (VDSL2 / ADSL2/2+)	RJ-11	POTS or ISDN line	RJ-11 telephone cable

¹ Cable color codes are specific to Cisco cables.

Connection Procedures and Precautions

After you have installed the router chassis, perform these steps to connect the WAN and LAN interfaces:

- Connect each WAN and LAN to the appropriate connector on the chassis.
- Position the cables carefully so that you do not strain the connectors.
- Organize cables in bundles so that cables do not intertwine.
- Inspect the cables to make sure that the routing and bend radius is satisfactory. If necessary, reposition the cables.
- Install cable ties in accordance with site requirements.

Configure the Router at Startup

After installing the router and connecting the cables, you can configure the router with basic configurations. For more information on how to configure the router, see the [Cisco 1100 Series Software Configuration Guide](#).



CHAPTER 4

Install and Upgrade Internal Modules and Field Replaceable Units

The Cisco 1100 Series Integrated Services Routers have internal modules and field-replaceable units (FRUs) that can be quickly and easily removed and replaced without having to send the entire router for repair.

This section describes how to install and upgrade the internal modules and FRUs in the Cisco 1100 Series ISRs. The information is contained in the following sections:

- [Access Internal Modules, on page 57](#)
- [Locate Internal and External Slots for Modules, on page 59](#)
- [Install an LTE Pluggable Module, on page 59](#)
- [Install and Remove Small Form Pluggable Modules, on page 66](#)

Access Internal Modules

To access the internal modules on the router, you must first disconnect the power source and then remove the chassis cover. See the **Replacing the Chassis Cover** section for instructions on how to remove and later replace the chassis cover on the routers.



Warning

Only trained and qualified personnel should be allowed to install, replace or service this equipment. Statement 1030.



Warning

Before opening the unit, disconnect the telephone-network cables to avoid contact with telephone-network voltages. Statement 1041.



Warning

Power off the unit before you begin. Statement 237.

Replace the Chassis Cover

The Cisco 1100 Series ISRs have a removable cover. Do not attempt to run the router without the cover. This can cause the router to overheat very quickly. To remove the chassis cover, use a number-2 Phillips screwdriver and perform the following tasks:

Remove the Cover

To remove the cover, perform the following steps:

-
- Step 1** Disconnect the power supply before you perform any module replacement.
 - Step 2** Confirm the router is turned off and disconnected from the power supply.
 - Step 3** Disconnect all port cables so that no one works on the unit with attached cable in the event of lightning or surges.
 - Step 4** Place the chassis on a flat surface. Remove the fourteen cover screws on the two sides of the router cover.
 - Step 5** Slide the cover from bezel side to I/O side until it stops. Remove all screws on both sides of the router; there are seven screws on each side.
 - Step 6** Pull the cover to disengage the slots along the front (bezel) edge of the chassis, as shown in this figure.

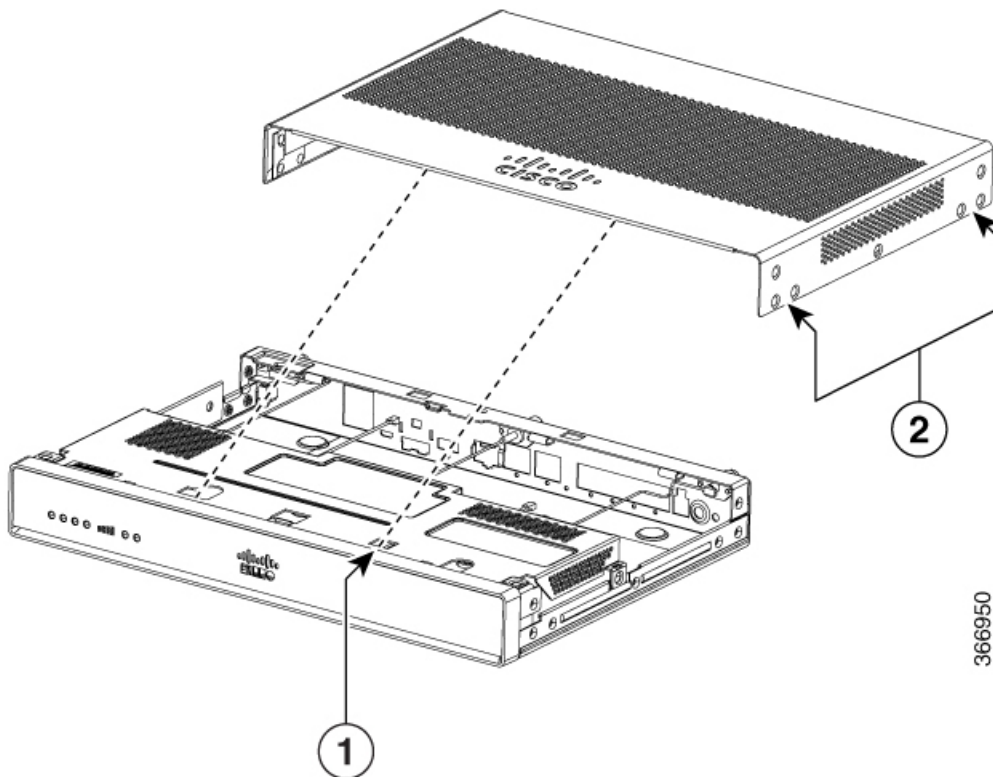

366950

1	Slots
2	Screw holes (7 numbers on each side)

Replace the Cover



Warning The covers are an integral part of the safety design of the product. Do not operate the unit without the covers installed. Statement 1077

To replace the cover, perform the these steps:

- Step 1** Disconnect the power supply before you begin replacing the chassis cover.
 - Step 2** Confirm that the router is turned off and disconnected from the power supply (or power supplies) if there is redundant power supply.
 - Step 3** Disconnect all port cables to ensure that no one works on the unit with attached cable in the event of lightning or surges.
 - Step 4** Place the chassis on a flat surface.
 - Step 5** Locate the cover hooks on the mating slots and slide the cover towards the bezel side.
 - Step 6** Secure seven screws on each side.
-

Locate Internal and External Slots for Modules

This section describes the locations of internal modules on the router motherboard.

Install an LTE Pluggable Module



Warning To reduce the risk of electric shock, the chassis of this equipment needs to be connected to permanent earth ground during normal use Statement 445



Warning Blank faceplates and cover panels serve three important functions: they prevent exposure to hazardous voltages and currents inside the chassis; they contain electromagnetic interference (EMI) that might disrupt other equipment; and they direct the flow of cooling air through the chassis. Do not operate the system unless all cards, faceplates, front covers, and rear covers are in place. Statement 1029.



Warning Only trained and qualified personnel should be allowed to install, replace, or service this equipment. Statement 1030

Install a Micro-SIM Card onto a USB LTE Dongle

This section describes how to insert a micro-SIM card into a USB LTE dongle in a C1101-4P router.

Figure 54: Micro-SIM Card Slot with Dust Cover

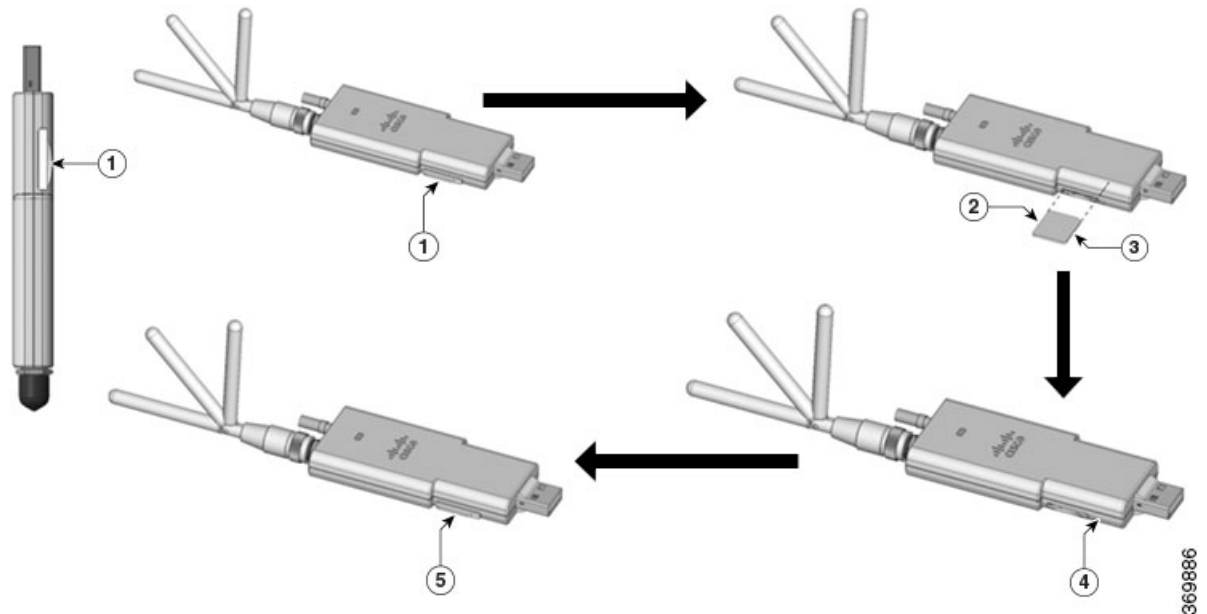

-
- Step 1** To insert a micro-SIM card into a USB LTE dongle, do these steps:
- a. Tap open the micro-SIM protective cap on the USB dongle, gently insert the micro-SIM card with its edge oriented as shown in the figure until the SIM is seated in the socket.
 - b. Tap close the micro-SIM protective cap on the USB to close the slot.
- Step 2** To remove a micro-SIM card into a USB LTE dongle, do these steps:
- a. Tap open the dust cover, and then gently push the micro-SIM card to eject the card from the SIM slot.
 - b. Tap close the micro-SIM protective cap on the USB to close the slot.
-



Note The antenna orientation may need to be adjusted for optimal performance.

Perform the following steps to insert the USB LTE dongle with the SIM card into a horizontal slot on the rear panel of a C110x series router:

1. Ensure the micro-SIM is installed in the LTE USB dongle.
2. Plug the LTE USB dongle into the magnet holder.
3. Attach the magnet holder into the USB port on the metal front panel of C1101-4P.

Figure 55: LTE USB 2.0 Dongle for C1101-4P

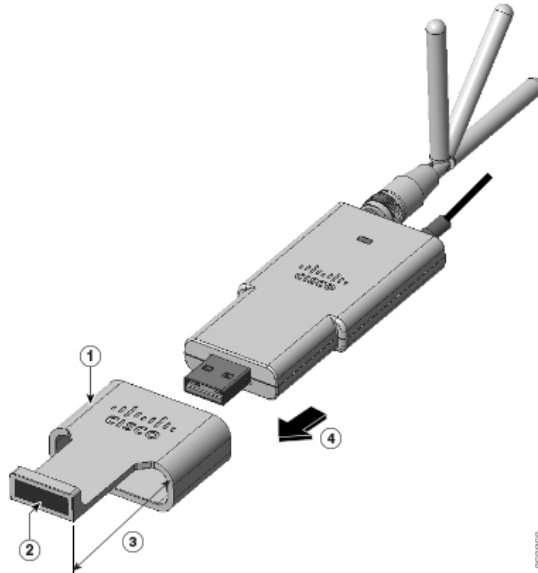

Number	Description
1	Supporting ring
2	Magnet
3	Extend outward 30mm
4	Plug-in direction

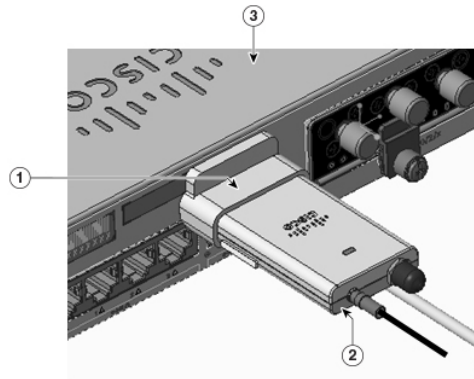

Number	Description
1	Supporting ring
2	Dongle holder with magnet
3	Router-C1101-4PLTEPW

Follow the same procedure to install the USB LTE dongle onto routers with a vertical USB slot.

Install an LTE Pluggable Module on a C1101-4P

To insert the LTE pluggable module into the router, do these steps:

-
- Step 1** Insert and then gently push the LTE pluggable into the pluggable slot of C1101-4P until firmly fixed.
- Step 2** Tighten the screw, the recommended torque is 10-12 in-lb.
-

Figure 56: LTE Pluggable - C1101-4P

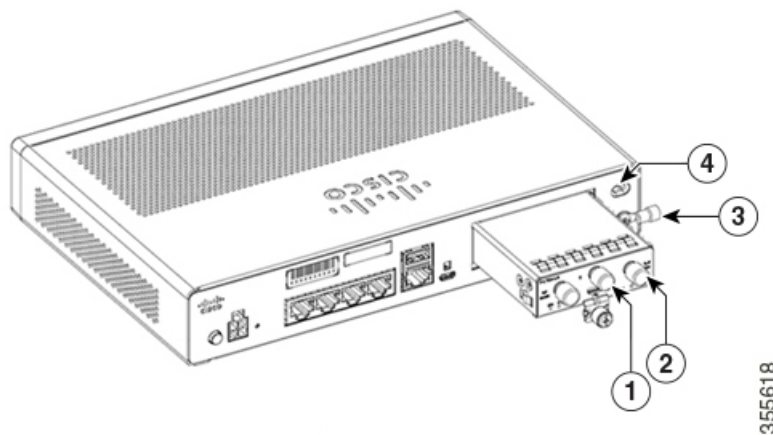

Item	Description
1	GPS Antenna
2	LTE Antenna
3	Ground Lug
4	Kensington Lock Slot

Figure 57: LTE Pluggable - C1127X-8PLTEP

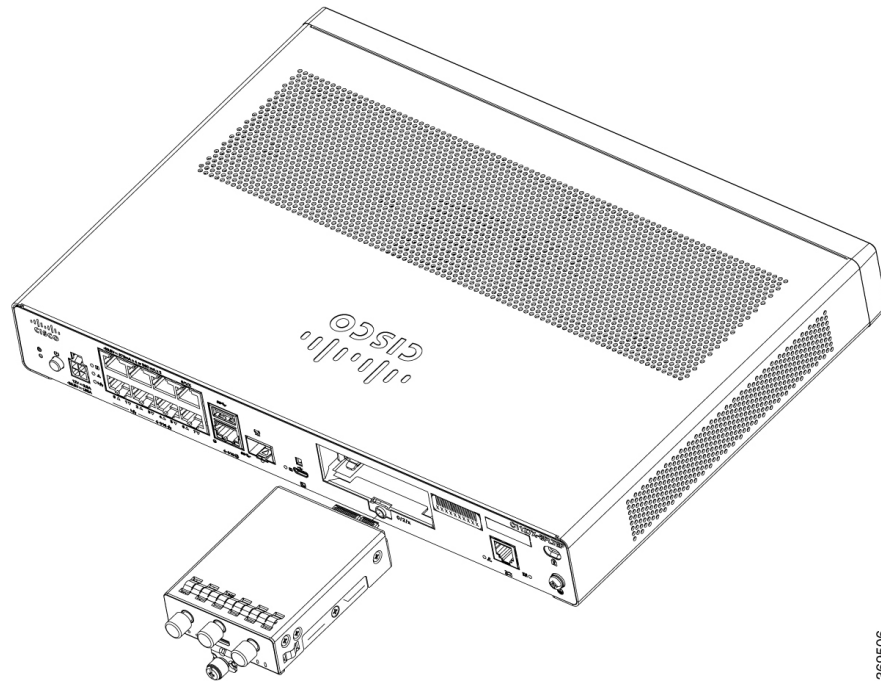

Item	Description
1	GPS Antenna
2	LTE Antenna
3	Ground Lug
4	Kensington Lock Slot

Figure 58: LTE Pluggable - C1118-8PLTEP

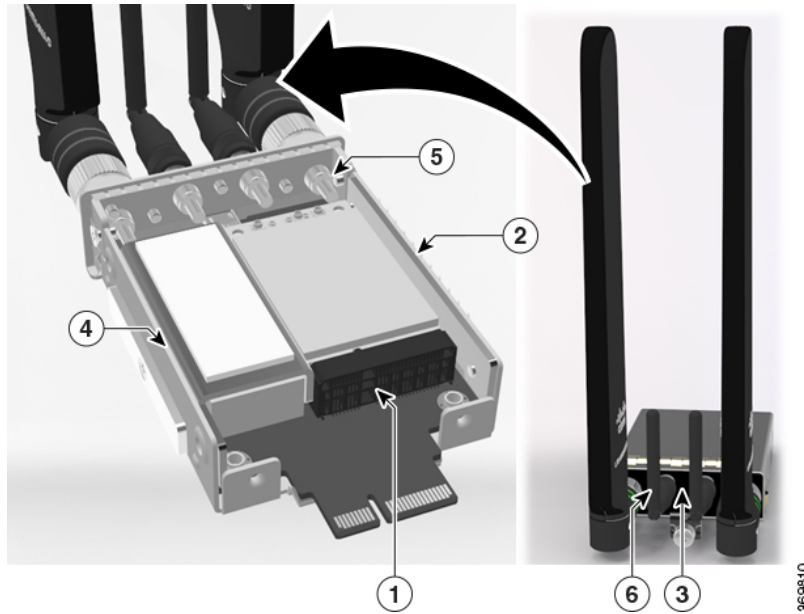

Item	Description
1	Mini-PCIE
2	Common heat spreader + thermal interface
3	I/O
4	Enclosure base to support 4-antenna
5	4-1 SMA-MHF4 cable assembly
6	SMA Diversity Antenna for usability and Micro-USB port access

Figure 59: LTE Pluggable - C1118-8PLTEP Back Panel

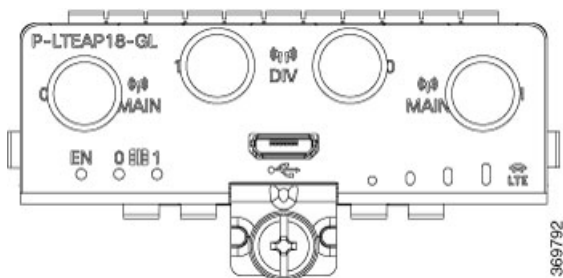
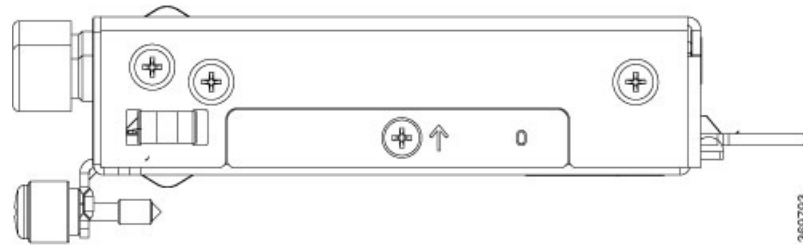

Figure 60: C1118-8PLTEP with Micro SIM Slots

This section describes how to insert a Micro-SIM card into an LTE pluggable module.

To insert the Micro-SIM cards into an LTE Pluggable module:

1. Place the router on its bottom side, remove the screws and then the Micro-SIM cover from the pluggable module.

**Caution**

Do not touch any part of the exposed PCB circuit area when the Micro-SIM cover is removed.

2. Push in each Micro-SIM card into the slot until it clicks.
3. Secure the Micro-SIM cover with a screw. The recommended torque is 2.8 - 3.8 inch LBF.
4. You have now successfully inserted the Micro-SIM cards into the LTE pluggable module.

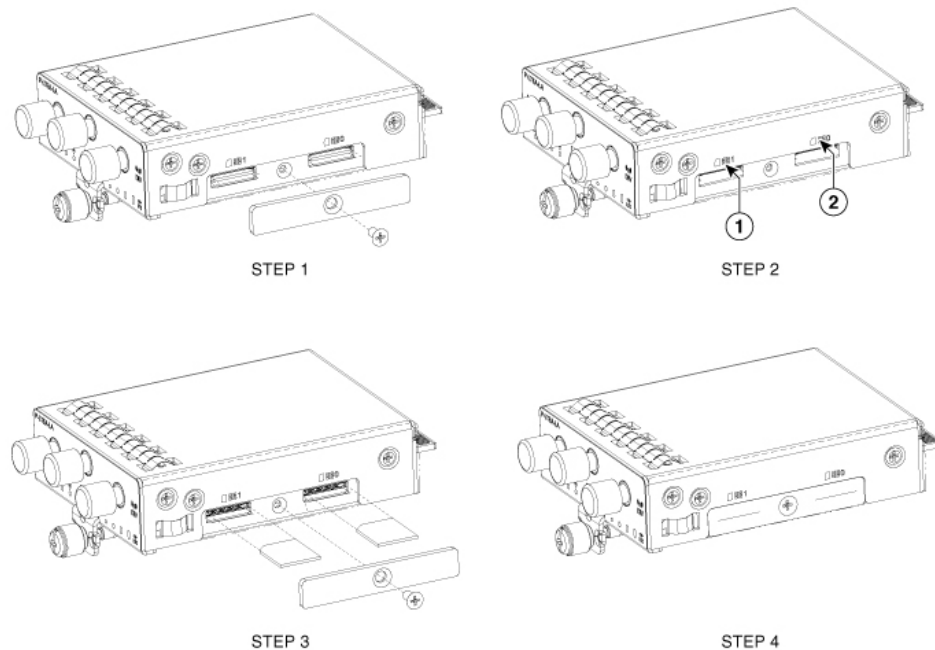
Figure 61: Insert the Micro-SIM cards

Item	Description
1	Micro-SIM 1 (Towards the device)
2	Micro-SIM 0 (Away from the device)

Install and Remove Small Form Pluggable Modules

This section describes how to install and remove Small Form Pluggable (SFP) modules in the Cisco 1100 Series ISRs. The information is contained in the following sections:

Install Small Form Pluggable Module

This section describes how to install optional small-form-factor pluggable (SFP) modules in the Cisco ISR1000 series Integrated Services routers to provide optical Gigabit Ethernet connectivity.

Only SFP modules certified by Cisco and complies with IEC 60825-1:2014 are supported on these routers. For more information, refer to [SFPs Supported on Cisco 1100 ISRs](#).

Note

The SFP module-GLC-GE-100FX V01 is not supported on the Cisco111x Series.

Warning

Class 1 laser product. Statement 1008.

Remove Small Factor Pluggable Module

To remove a small factor pluggable (SFP) module from the router:

Warning

Invisible laser radiation may be emitted from the end of the unterminated fiber cable or connector. Do not view directly with optical instruments. Viewing the laser output with certain optical instruments (for example, eye loupes, magnifiers, and microscopes) within a distance of 100 mm may pose an eye hazard.

Fiber type and Core diameter (μm)	Wavelength (nm)	Max. Power (mW)	Beam divergence (rad)
SM 11	1200 - 1400	39 - 50	0.1 - 0.11
MM 62.5	1200 - 1400	150	0.18 NA
MM 50	1200 - 1400	135	0.17 NA
SM 11	1400 - 1600	112 - 145	0.11 - 0.13

3-49377

Step 1 Disconnect the power supply before you remove any module.

Step 2 Disconnect all cables from the SFP.

Step 3 Disconnect the SFP latch.

Note SFP modules use various latch designs to secure the module in the SFP port. For information on the SFP technology type and model, see the label on the side of the SFP module.

Tip Use a pen, screwdriver, or other small straight tool to gently release a bale-clasp handle if you cannot reach it with your fingers.

Step 4 Grasp the SFP on both sides and remove it from the router.



CHAPTER 5

ROM Monitor Overview

The ROMMON is the bootloader that initializes the hardware when the platform is powered on or reset. From the ROMMON prompt, a Cisco IOS XE image can be manually booted. There is also an autoboot option to boot a specified IOS XE image for every power-on or reset. When new features or significant defects are resolved, a newer ROMMON release is available on CCO. To determine the current ROMMON version and the location of the latest ROMMON release, these details are available in the following sections:

- [ROM Monitor Overview, on page 69](#)

ROM Monitor Overview

The *ROM Monitor software* is also known as *ROMMON*, *boot software*, *boot image*, or *boot helper*. Although it is distributed with routers that use the Cisco IOS XE software, the ROMMON is a separate program from the Cisco IOS XE software. During normal startup, ROMMON initializes the router, and then, the control passes to the Cisco IOS XE software.

When you connect a terminal to the router that is in ROMMON mode, the ROMMON command-line interface (CLI) prompt is displayed.

Access the ROMMON mode to perform these tasks:

- Specify config-register value to use for the next boot up
- Boot a valid IOS XE image
- Bypass NVRAM settings and config-register value for password recovery



Note After the Cisco IOS XE software boots up, ROMMON is no longer in use.

Environmental Variables and the Configuration Register

Two primary connections exist between ROMMON and the Cisco IOS XE software: the ROMMON environment variables and the configuration register.

The ROMMON environment variables define the location of the Cisco IOS XE software and describe how to load it. After ROMMON has initialized the router, it uses the environment variables to locate and load the Cisco IOS XE software.

The *configuration register* is a software setting that controls how a router starts up. One of the primary uses of the configuration register setting is to control whether the router starts in ROMMON mode or Administration EXEC mode. The configuration register is set in either ROMMON mode or Administration EXEC mode as needed. You can set the configuration register using the Cisco IOS XE software prompt when you need to use ROMMON mode. When maintenance in ROMMON mode is complete, change the configuration register back so that the router reboots with the Cisco IOS XE software.

Access ROMMON Mode with a Terminal Connection

When the router is in ROMMON mode, you can access the ROMMON software only from a terminal connected directly to the console port of the card. Because the Cisco IOS XE software (EXEC mode) is in operation, the nonmanagement interfaces are not accessible. Therefore, all Cisco IOS XE software resources are unavailable.

Network Management Access and ROMMON Mode

ROMMON mode is a router mode, not a mode within the Cisco IOS XE software. The ROMMON software and the Cisco IOS XE software are two separate programs that run on the same router. At any given time, the router is running one of these programs, but it never runs both at the same time.

One area that can be confusing when using ROMMON and the Cisco IOS XE software is the area that defines the IP configuration for the Management Ethernet interface. Most users are comfortable with configuring the Management Ethernet interface in the Cisco IOS XE software. When the router is in ROMMON mode, however, the router is not running the Cisco IOS XE software, therefore, Management Ethernet interface configuration is not available.

When you want to access other devices, such as a TFTP server, while in ROMMON mode on the router, you must configure the ROMMON variables with IP access information.

For more information on ROMMON and Basic Procedures, refer to the [Upgrading Field-Programmable Hardware Devices for Cisco 1000 Series ISRs](#)



CHAPTER 6

Supplier Declaration of Conformity

This equipment has been tested and found to comply with the limits for a Class A digital device, pursuant to Part 15 of the FCC Rules. These limits are designed to provide reasonable protection against any harmful interference when the equipment is operated in a commercial environment. This equipment generates, uses, and can radiate radio frequency energy, and if it is not installed and used in accordance with the instruction manual, it may cause harmful interference to radio communications.

- This device may not cause harmful interference.
- This device must accept any interference received, including interference that may cause an undesired operation.

The operation of this equipment in a residential area is likely to cause harmful interference, in which case, users are required to correct the interference at their own expense.

Radio Compliance

This system uses both licensed and licensed exempt radio frequencies. The radios are evaluated to the following regulations:

The Wi-Fi Radio is evaluated to 47 Code of Federal Regulations Part 15.247 and Part 15.407.

Part 15 Radio Systems operating outdoors in the 5150-5250 MHz band must comply with the antenna installation requirements as set forth in the FCC Part 15.407 rules.

The LTE radio is evaluated to 47 Code of Federal Regulation Part 24 and 27.

The LTE radio operates on licensed frequency bands and requires a radio license to operate. It must be operated under the control of a Licensed Service Provider or Wireless Carrier.

Modifications by User or Installer

Modifying the equipment without Cisco's authorization may result in the equipment being no longer compliant with FCC requirements for Class A digital devices. In that event, your right to use the equipment may be limited by FCC regulations, and you may be required to correct any interference to radio or television communications at your own expense.

Changes or modifications not expressly approved by the party responsible for compliance could void the user's authority to operate the equipment.

FCC RF Exposure Compliance

This product has been found to be compliant to the requirements set forth in CFR 47 Section 1.1307 addressing RF Exposure from radio frequency devices, as defined in Evaluating Compliance with FCC Guidelines for Human Exposure to Radio Frequency Electromagnetic Fields.

To maintain compliance, the minimum separation distance from the antenna to general bystander is 20 cm (8,7 inches) or more.

CANADA

This Class [*] digital apparatus complies with Canadian ICES-003.

Cet appareil numérique de la classe [*] est conforme à la norme NMB-003 du Canada

Radio (Wi Fi)

This product complies with RSS-247 of the Industry Canada Rules. Its operation is subject to the following two conditions:

- This device may not cause harmful interference.
- This device must accept any interference received, including interference that may cause an undesired operation.

Ce dispositif est conforme à la norme RSS-247 d'Industrie Canada applicable aux appareils radio exempts de licence. Son fonctionnement est sujet aux deux conditions suivantes:

- le dispositif ne doit pas produire de brouillage préjudiciable
- ce dispositif doit accepter tout brouillage reçu, y compris un brouillage susceptible de provoquer un fonctionnement indésirable

The device for operation in the band 5150-5250 MHz is only for indoor use to reduce the potential for harmful interference to co-channel mobile satellite system.

For devices with detachable antenna(s), the maximum antenna gain permitted for devices in the bands 5250-5350 MHz and 5470-5725 MHz must be such that the equipment still complies with the e.i.r.p. limit.

For devices with detachable antenna(s), the maximum antenna gain permitted for devices in the band 5725-5850 MHz must be such that the equipment still complies with the e.i.r.p. limits as appropriate.

For systems that are capable of operating outdoors or with antennas mounted outdoors (where applicable antenna type(s), antenna models(s), and worst-case tilt angle(s)) are necessary to remain compliant with the e.i.r.p., therefore, the elevation mask requirement set forth in section 6.2.2.3 should be clearly indicated.

Radio (Wi Fi)

This product complies with the RSS of the Industry Canada rules.

Radiation Exposure Statement

This equipment complies with IC radiation exposure limits set forth for an uncontrolled environment. This equipment should be installed and operated with a minimum distance of 20 cm (7.87 in.) between the radiator and yourself.



Note C1109-4PLTE2P = 27 cm

Déclaration D'exposition Aux Radiations

Cet équipement est conforme aux limites d'exposition aux rayonnements IC établies pour un environnement non contrôlé. Cet équipement doit être installé et utilisé avec un minimum de 20 cm (7.87 in.) de distance entre la source de rayonnement et votre corps.



Note C1109-4PLTE2P = 27 cm

THAILAND

เครื่องโทรคมนาคมและอุปกรณ์นี้มีความสอดคล้องตามมาตรฐานหรือข้อกำหนดทางเทคนิค ของ กสทช

This telecommunication equipment conforms to NTC/NBTC technical requirement (optional)

Radiocommunication equipment has electromagnetic field strength in compliance with the Safety Standard for the Use of Radiocommunication Equipment on Human Health announced by the National Telecommunication Commission.

