



User Manual

ACM7000 Remote Site Gateway
ACM7000-L Resilience Gateway
IM7200 Infrastructure Manager
CM7100 Console Servers

Safety

Follow the safety precautions below when installing and operating the console server:

- Do not remove the metal covers. There are no operator serviceable components inside. Opening or removing the cover may expose you to dangerous voltage which may cause fire or electric shock. Refer all service to Opendgear qualified personnel.
- To avoid electric shock the power cord protective grounding conductor must be connected through to ground.
- Always pull on the plug, not the cable, when disconnecting the power cord from the socket.

Do not connect or disconnect the console server during an electrical storm. Also use a surge suppressor or UPS to protect the equipment from transients.

FCC Warning Statement

This device complies with Part 15 of the FCC rules. Operation of this device is subject to the following conditions: (1) This device may not cause harmful interference, and (2) this device must accept any interference that may cause undesired operation.

Proper back-up systems and necessary safety devices should be utilized to protect against injury, death or property damage due to system failure. Such protection is the responsibility of the user.



This console server device is not approved for use as a life-support or medical system.

Any changes or modifications made to this console server device without the explicit approval or consent of Opendgear will void Opendgear of any liability or responsibility of injury or loss caused by any malfunction.

This equipment is for indoor use and all the communication wirings are limited to inside of the building.

Copyright

©Opengear Inc. 2019. All Rights Reserved.

Information in this document is subject to change without notice and does not represent a commitment on the part of Opengear. Opengear provides this document "as is," without warranty of any kind, expressed or implied, including, but not limited to, the implied warranties of fitness or merchantability for a particular purpose.

Opengear may make improvements and/or changes in this manual or in the product(s) and/or the program(s) described in this manual at any time. This product could include technical inaccuracies or typographical errors. Changes are periodically made to the information herein; these changes may be incorporated in new editions of the publication.

TABLE OF CONTENTS

1	THIS MANUAL	6
1.1	TYPES OF USERS	6
1.2	MANAGEMENT CONSOLE	6
1.3	MORE INFORMATION	7
2	SYSTEM CONFIGURATION	8
2.1	MANAGEMENT CONSOLE CONNECTION	8
2.2	ADMINISTRATOR SET UP	10
2.3	NETWORK CONFIGURATION	11
2.4	SERVICE ACCESS AND BRUTE FORCE PROTECTION	15
2.5	COMMUNICATIONS SOFTWARE	18
2.6	MANAGEMENT NETWORK CONFIGURATION	19
3	SERIAL PORT, HOST, DEVICE & USER CONFIGURATION	28
3.1	CONFIGURE SERIAL PORTS	28
3.2	ADD AND EDIT USERS	38
3.3	AUTHENTICATION	42
3.4	NETWORK HOSTS	42
3.5	TRUSTED NETWORKS	43
3.6	SERIAL PORT CASCADING	45
3.7	SERIAL PORT REDIRECTION (PORTSHARE)	49
3.8	MANAGED DEVICES	50
3.9	IPSEC VPN	52
3.10	OPENVPN	55
3.11	PPTP VPN	63
3.12	CALL HOME	68
3.13	IP PASSTHROUGH	71
3.14	CONFIGURATION OVER DHCP (ZTP)	73
3.15	ENROLLMENT INTO LIGHTHOUSE	75
4	FIREWALL, FAILOVER & OOB ACCESS	76
4.1	DIALUP MODEM CONNECTION	76
4.2	OOB DIAL-IN ACCESS	76
4.3	DIAL-OUT ACCESS	79
4.4	OOB BROADBAND ETHERNET ACCESS	83
4.5	BROADBAND ETHERNET FAILOVER	83
4.6	CELLULAR MODEM CONNECTION	84
4.7	CELLULAR OPERATION	93
4.8	FIREWALL & FORWARDING	96
5	SSH TUNNELS & SDT CONNECTOR	105
5.1	CONFIGURING FOR SSH TUNNELING TO HOSTS	106
5.2	SDT CONNECTOR CLIENT CONFIGURATION	106
5.3	SDT CONNECTOR TO MANAGEMENT CONSOLE	115
5.4	SDT CONNECTOR: TELNET OR SSH CONNECT TO SERIALLY ATTACHED DEVICES	115
5.5	USING SDT CONNECTOR FOR OUT-OF-BAND CONNECTION TO THE GATEWAY	117
5.6	IMPORTING (AND EXPORTING) PREFERENCES	118
5.7	SDT CONNECTOR PUBLIC KEY AUTHENTICATION	119
5.8	SETTING UP SDT FOR REMOTE DESKTOP ACCESS	120
5.9	SDT SSH TUNNEL FOR VNC	121
5.10	USING SDT TO IP CONNECT TO HOSTS THAT ARE SERIALLY ATTACHED TO THE GATEWAY	123
5.11	SSH TUNNELING USING OTHER SSH CLIENTS (E.G. PUTTY)	127

User Manual

6	ALERTS, AUTO-RESPONSE & LOGGING.....	129
6.1	CONFIGURE AUTO-RESPONSE.....	129
6.2	CHECK CONDITIONS.....	131
6.3	TRIGGER ACTIONS.....	142
6.4	RESOLVE ACTIONS.....	145
6.5	CONFIGURE SMTP, SMS, SNMP AND/OR NAGIOS SERVICE FOR ALERT NOTIFICATIONS	145
6.6	LOGGING.....	150
7	POWER, ENVIRONMENT & DIGITAL I/O	153
7.1	REMOTE POWER CONTROL (RPC).....	153
7.2	UNINTERRUPTIBLE POWER SUPPLY(UPS) CONTROL	158
7.3	ENVIRONMENTAL MONITORING	167
7.4	DIGITAL I/O PORTS	172
8	AUTHENTICATION	175
8.1	AUTHENTICATION CONFIGURATION	175
8.2	PAM (PLUGGABLE AUTHENTICATION MODULES)	188
8.3	SSL CERTIFICATE.....	189
8.4	ADDING OPENGear CUSTOM ATTRIBUTES.....	192
9	NAGIOS INTEGRATION	193
9.1	NAGIOS OVERVIEW	193
9.2	CONFIGURING NAGIOS DISTRIBUTED MONITORING	194
9.3	ADVANCED DISTRIBUTED MONITORING CONFIGURATION	199
10	SYSTEM MANAGEMENT	207
10.1	SYSTEM ADMINISTRATION AND RESET	207
10.2	UPGRADE FIRMWARE	207
10.3	CONFIGURE DATE AND TIME	208
10.4	CONFIGURATION BACKUP.....	210
10.5	DELAYED CONFIGURATION COMMIT	212
10.6	FIPS MODE.....	213
11	STATUS REPORTS.....	214
11.1	PORT ACCESS AND ACTIVE USERS.....	214
11.2	STATISTICS.....	215
11.3	SUPPORT REPORTS.....	215
11.4	SYSLOG.....	216
11.5	DASHBOARD	218
12	MANAGEMENT.....	221
12.1	DEVICE MANAGEMENT	221
12.2	PORT AND HOST LOGS	222
12.3	TERMINAL CONNECTION.....	222
12.4	POWER MANAGEMENT	224
	APPENDIX A: HARDWARE SPECIFICATION.....	225
	APPENDIX B: SAFETY & CERTIFICATIONS.....	227
	APPENDIX C: CONNECTIVITY, TCP PORTS & SERIAL I/O	228
13	APPENDIX E: TERMINOLOGY	234
	END USER LICENSE AGREEMENTS	239
14	APPENDIX G: SERVICE & STANDARD WARRANTY.....	245

1 THIS MANUAL

This User Manual explains installing, operating, and managing Opengear console servers. This manual assumes you are familiar with the Internet and IP networks, HTTP, FTP, basic security operations, and your organization's internal network.

1.1 Types of users

The console server supports two classes of users:

- Administrators who have unlimited configuration and management privileges over the console server and connected devices as well as all services and ports to control all the serial connected devices and network connected devices (hosts). Administrators are set up as members of the **admin** user group. An administrator can access and control the console server using the config utility, the Linux command line or the browser-based Management Console.
- Users who have been set up by an administrator with limits of their access and control authority. Users have a limited view of the Management Console and can only access authorized configured devices and review port logs. These users are set up as members of one or more of the pre-configured user groups such as PPTPD, dialin, FTP, pmshell, users, or user groups the administrator may have created. They are only authorized to perform specified controls on specific connected devices. Users, when authorized, can access and control serial or network connected devices using specified services (e.g. Telnet, HTTPS, RDP, IPMI, Serial over LAN, Power Control).

Remote users are users who are not on the same LAN segment as the console server. A remote user may be on the road connecting to managed devices over the public Internet, an administrator in another office connecting to the console server over the enterprise VPN, or in the same room or the same office but connected on a separate VLAN to the console server.

1.2 Management Console

The Opengear Management Console allows you to configure and monitor the features of your Opengear console server. The Management Console runs in a browser and provides a view of the console server and all connected devices.

Administrators can use the Management Console to configure and manage the console server, users, ports, hosts, power devices, and associated logs and alerts. Non-admin users can use the Management Console with limited menu access to control select devices, review their logs, and access them using the built-in Web terminal.

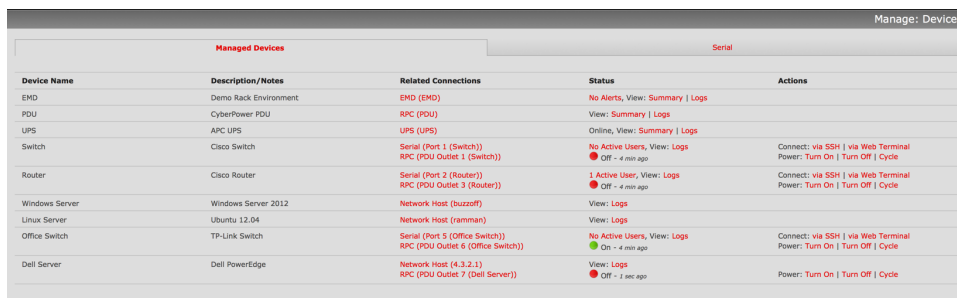

Device Name	Description/Notes	Related Connections	Status	Actions
EMD	Demo Rack Environment	EMD (EMD)	No Alerts, View: Summary Logs	
PDU	CyberPower PDU	RPC (PDU)	View: Summary Logs	
UPS	APC UPS	UPS (UPS)	Online, View: Summary Logs	
Switch	Cisco Switch	Serial (Port 1 (Switch)) RPC (PDU Outlet 1 (Switch))	No Active Users, View: Logs ● Off - 4 min ago	Connect: via SSH via Web Terminal Power: Turn On Turn Off Cycle
Router	Cisco Router	Serial (Port 2 (Router)) RPC (PDU Outlet 3 (Router))	1 Active User, View: Logs ● Off - 4 min ago	Connect: via SSH via Web Terminal Power: Turn On Turn Off Cycle
Windows Server	Windows Server 2012	Network Host (buzzoff)	View: Logs	
Linux Server	Ubuntu 12.04	Network Host (ramman)	View: Logs	
Office Switch	TP-Link Switch	Serial (Port 5 (Office Switch)) RPC (PDU Outlet 6 (Office Switch))	No Active Users, View: Logs ● On - 4 min ago	Connect: via SSH via Web Terminal Power: Turn On Turn Off Cycle
Dell Server	Dell PowerEdge	Network Host (4.3.2.1) RPC (PDU Outlet 7 (Dell Server))	View: Logs ● Off - 1 sec ago	Power: Turn On Turn Off Cycle

The console server runs an embedded Linux operating system, and can be configured at the command line. You can get command line access by cellular / dial-in, directly connecting to the console server's serial console/modem port, or by using SSH or Telnet to connect to the console server over the LAN (or connecting with PPTP, IPsec or OpenVPN).

For command line interface (CLI) commands and advanced instructions, download the **Opengear CLI and Scripting Reference.pdf** from <http://ftp.opengear.com/download/manual/current/>.

1.3 More information

For more information, consult:

- Opengear Products Web Site: See <https://opengear.com/products>. To get the most up-to-date information on what's included with your console server, visit the **What's included** section for your particular product.
- Quick Start Guide: This guide that shipped with your console server takes you through initial basic Opengear configuration.
- Opengear Knowledge Base: Visit <https://opengear.zendesk.com> to access technical how-to articles, tech tips, FAQs, and important notifications.
- Opengear CLI and Scripting Reference: [http://ftp.opengear.com/download/manual/current/Opengear CLI and Scripting Reference.pdf](http://ftp.opengear.com/download/manual/current/Opengear%20CLI%20and%20Scripting%20Reference.pdf).

2 SYSTEM CONFIGURATION

This chapter provides step-by-step instructions for the initial configuration of your console server and connecting it to the Management or Operational LAN. The steps are:

- Activate the Management Console.
- Change the administrator password.
- Set the IP address console server's principal LAN port.
- Select the services to be enabled and access privileges.

This chapter also discusses the communications software tools that an administrator may use to access the console server, and the configuration of the additional LAN ports.

2.1 Management Console Connection

Your console server comes configured with a default IP Address *192.168.0.1* and subnet mask *255.255.255.0*.

For initial configuration, we recommend that you connect a computer directly to the console. If you do choose to connect your LAN before completing the initial setup steps, make sure that:

- There are no other devices on the LAN with an address of *192.168.0.1*.
- The console server and the computer are on the same LAN segment, with no interposed router appliances.

2.1.1 Connected computer set up

To configure the console server with a browser, the connected computer should have an IP address in the same range as the console server (for example, *192.168.0.100*):

- To configure the IP Address of your Linux or Unix computer, run *ifconfig*.
- For Windows PCs:
 1. Click **Start > Settings > Control Panel** and double click **Network Connections**.
 2. Right click on **Local Area Connection** and select **Properties**.
 3. Select **Internet Protocol (TCP/IP)** and click **Properties**.
 4. Select **Use the following IP address** and enter the following details:
 - IP address: *192.168.0.100*
 - Subnet mask: *255.255.255.0*
 5. If you want to retain your existing IP settings for this network connection, click **Advanced** and **Add** the above as a secondary IP connection.

2.1.2 Browser connection

Open a browser on the connected PC / workstation and enter **https://192.168.0.1**.

Log in with:

Username> **root**
Password> **default**

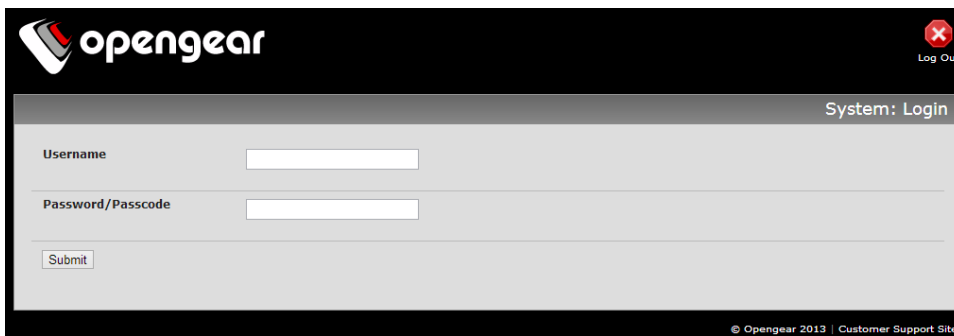

The **Welcome** screen appears.

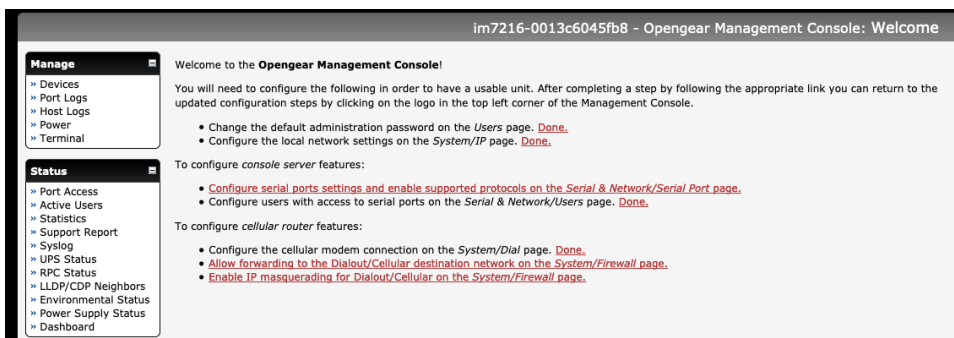

The Welcome screen lists initial installation configuration steps. These steps are:

Change default administration password (**Users** page. See Chapter 2.2)

Configure the local network settings (**System > IP** page. See Chapter 2.3)

Configure console server features:

- Configure serial ports settings (**Serial & Network > Serial Port** page. See Chapter 3)
- Configure user port access (**Serial & Network > Users** page. See Chapter 3)

If your system has a cellular modem you will be given the steps to configure the cellular router features:

- Configure the cellular modem connection (**System > Dial** page. See Chapter 4)
- Allow forwarding to the cellular destination network (**System > Firewall** page. See Chapter 4)
- Enable IP masquerading for cellular connection (**System > Firewall** page. See Chapter 4)

After completing each of the above steps, you can return to the configuration list by clicking the Opengear logo in the top left corner of the screen.

NOTE If you are not able to connect to the Management Console at 192.168.0.1 or if the default Username / Password are not accepted, reset your console server (See Chapter 10).

2.2 Administrator Set Up

2.2.1 Change default root System Password

Change the default password before granting the console server any access to your computers and network appliances.

1. Click **Serial & Network > Users & Groups** or, on the **Welcome** screen, click **Change default administration password**.
2. Scroll down and locate the **root** user entry under **Users** and click **Edit**.
3. Enter the new password in the **Password** and **Confirm** fields.

The screenshot shows the 'Serial & Network: Users & Groups' configuration page. The 'Edit an Existing User' form is displayed for the 'root' user. The 'Username' field is 'root'. The 'Description' field is 'Root User'. The 'Password' and 'Confirm' fields are masked with asterisks. The 'SSH Authorized Keys' section shows a list of keys, including the default root key.

NOTE Checking **Save Password across firmware erases** saves the password so it does not get erased when the firmware is reset. If this password is lost, the device will need to be firmware recovered.

4. Click **Apply**. Log in with the new password

2.2.2 Set up a new administrator

Create a new user with administrative privileges and log in as this user for administration functions, rather than using **root**.

1. Click **Serial & Network > Users & Groups** and click **Add User**.
2. Enter a **Username**.
3. In the **Groups** section, check the **admin** box.
4. Enter a password in the **Password** and **Confirm** fields.
5. Click **Apply**.

2.2.3 Add System Name, System Description, and MOTD

1. Select **System > Administration**
2. Enter a **System Name** and **System Description** for the console server to give it a unique ID and make it easier to identify. **System Name** can contain from 1 to 64 alphanumeric characters and the special characters underscore (`_`), minus (`-`), and period (`.`). **System Description** can contain up to 254 characters.

3. The **MOTD Banner** can be used to display a message of the day text to users. It appears on the upper left of the screen below the Opengear logo.
4. Click **Apply**.

2.3 Network Configuration

Enter an IP address for the principal Ethernet (*LAN/Network/Network1*) port on the console server or enable its DHCP client to automatically obtain an IP address from a DHCP server. By default, the console server has its DHCP client enabled and automatically accepts any network IP address assigned by a DHCP server on your network. In this initial state, the console server will respond to both its default Static address `192.168.0.1` and its DHCP address.

1. Click **System > IP** and click the **Network Interface** tab.
2. Choose either **DHCP** or **Static** for the **Configuration Method**.

If you choose **Static**, enter the **IP Address**, **Subnet Mask**, **Gateway** and **DNS** server details. This selection disables the DHCP client.

3. The console server LAN port automatically detects the Ethernet connection speed. Use the **Media** drop-down list to lock the Ethernet to 10 Mb/s or 100Mb/s and to Full Duplex or Half Duplex.

If you encounter packet loss or poor network performance with the **Auto** setting, change the Ethernet Media settings on the console server and the device it is connected to. In most cases, change both to *100baseTx-FD* (100 megabits, full duplex).

4. If you select **DHCP**, the console server will look for configuration details from a DHCP server. This selection disables any static address. The console server MAC address can be found on a label on the base plate.
5. You may enter a secondary address or comma-separated list of addresses in CIDR notation, e.g. *192.168.1.1/24* as an **IP Alias**.
6. Click **Apply**
7. Reconnect the browser on the computer that is connected to the console server by entering **http://your new IP address**.

If you change the console server IP address, you need to reconfigure your computer to have an IP address in the same network range as the new console server address.

You can set the MTU on Ethernet interfaces. This is an advanced option to be used if your deployment scenario doesn't work with the default MTU of 1500 bytes.

To set the MTU, click **System > IP** and click the **Network Interface** tab. Scroll down to the **MTU** field and enter the desired value. Valid values are from 1280 to 1500 for 100-megabit interfaces, and 1280 to 9100 for gigabit interfaces

If bridging or bonding is configured, the MTU set on the Network Interface page will be set on the interfaces that are part of the bridge or the bond.

User Manual

NOTE In some cases, the user specified MTU may not take effect. Some NIC drivers may round oversized MTUs to the maximum allowed value and others will return an error code.

You can also use a CLI command to manage MTU Size:

configure

```
# config -s config.interfaces.wan.mtu=1380
```

check

```
# config -g config.interfaces.wan
config.interfaces.wan.address 192.168.2.24
config.interfaces.wan.ddns.provider none
config.interfaces.wan.gateway 192.168.2.1
config.interfaces.wan.ipv6.mode stateless
config.interfaces.wan.media Auto
config.interfaces.wan.mode static
config.interfaces.wan.mtu 1380
config.interfaces.wan.netmask 255.255.255.0
```

2.3.1 IPv6 configuration

NOTE IPv6 passthrough is not supported with this release but will be in the near future.

The console server Ethernet interfaces support IPv4 by default. They can be configured for IPv6 operation:

1. Click **System > IP**. Click the **General Settings** tab and check **Enable IPv6**. If desired, click the **Disable IPv6 for Cellular** checkbox.

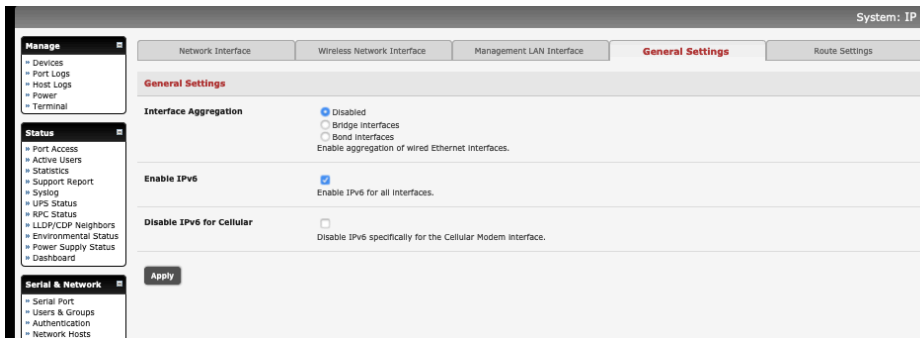

2. Configure the IPv6 parameters on each interface page.

IPv6 can be configured for either **Automatic** mode, which will use SLAAC or DHCPv6 to configure addresses, routes, and DNS, or **Static** mode, which allows the address information to be manually entered.

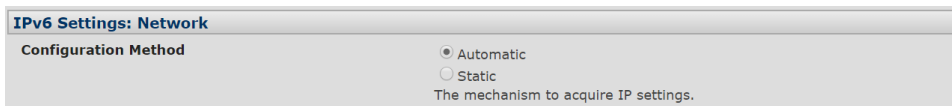

IPv6 Settings: Network	
Configuration Method	<input type="radio"/> Automatic <input checked="" type="radio"/> Static The mechanism to acquire IP settings.
IPv6 Address	<input type="text"/> A statically assigned IPv6 address.
IPv6 Prefix Length	<input type="text"/> A statically assigned IPv6 prefix length.
IPv6 Gateway	<input type="text"/> A statically assigned IPv6 gateway address.

2.3.2 Dynamic DNS (DDNS) configuration

With Dynamic DNS (DDNS), a console server whose IP address is dynamically assigned can be located using a fixed host or domain name.

Create an account with the supported DDNS service provider of your choice. When you set up your DDNS account, you choose a username, password, and hostname that you will use as the DNS name. DDNS service providers let you choose a hostname URL and set an initial IP address to correspond to that hostname URL.

To enable and configure DDNS on any of the Ethernet or cellular network connections on the console server:

1. Click **System > IP** and scroll down the **Dynamic DNS** section. Select your DDNS service provider from the drop-down **Dynamic DNS** list. You can also set the DDNS information under the Cellular Modem tab under **System > Dial**.
2. In **DDNS Hostname**, enter the fully qualified DNS hostname for your console server e.g. *your-hostname.dyndns.org*.
3. Enter the **DDNS Username** and **DDNS Password** for the DDNS service provider account.
4. Specify the **Maximum interval between updates** in *days*. A DDNS update will be sent even if the address has not changed.
5. Specify the **Minimum interval between checks** for changed addresses in *seconds*. Updates will be sent if the address has changed.
6. Specify the **Maximum attempts per update** which is the number of times to attempt an update before giving up. This is 3 by default.

7. Click **Apply**.

2.4 Service Access and Brute Force Protection

The administrator can access the console server and connected serial ports and managed devices using a range of access protocols/services. For each access:

- The service must first be configured and enabled to run on the console server.
- Access through the firewall must be enabled for each network connection.

To enable and configure a service:

1. Click **System > Services** and click the **Service Settings** tab.

The screenshot shows the 'Service Settings' configuration page. The left sidebar contains navigation menus for 'Manage', 'Status', 'Serial & Network', and 'Alerts & Logging'. The main content area has tabs for 'Service Settings', 'Service Access', 'Web Management Settings', and 'Brute Force Protection'. The 'Service Settings' tab is active, displaying the following configuration options:

- Alternate HTTP Port:** 80. Note: Alternate HTTP port to listen on. NB: The service will still be internally listening on TCP port 80 (for CMS and sdt-connector) but will be inaccessible through the firewall.
- Enable HTTPS Web Management:** . Completely enable or disable the HTTPS web management service.
- HTTPS Port:** 443. Port to listen for the HTTPS web management service.
- Enable Telnet command shell:** . Completely enable or disable the telnet service.
- Alternate Telnet Port:** 23. Note: Alternate Telnet port to listen on. NB: The service will still be internally listening on TCP port 23 (for CMS and sdt-connector) but will be inaccessible through the firewall.
- Enable SSH command shell:** . Completely enable or disable the SSH service.
- SSH Port:** 22. Port to listen for the SSH command shell.
- Enable SSH DNS:** . Allow SSH to resolve FQDNs. Warning: this can affect connection performance on networks where DNS is not fully configured.

2. Enable and configure basic services:

HTTP By default, HTTP service is running and cannot be fully disabled. By default, HTTP access is disabled on all interfaces. We recommend this access remain disabled if the console server is accessed remotely over the Internet.

Alternate HTTP lets you to configure an alternate HTTP port to listen on. The HTTP service will continue listening on TCP port 80 for CMS and SDT Connector communications but will be inaccessible through the firewall.

HTTPS By default, HTTPS service is running and enabled on all network interfaces. It is recommended that only HTTPS access be used if the console server is to be managed over any public network. This ensures administrators have secure browser access to all the menus on the console server. It also allows appropriately configured users secure browser access to selected **Manage** menus.

The HTTPS service can be disabled or reenabled by checking **HTTPS Web Management** and an alternate port specified (default port is 443).

Telnet By default the Telnet service is running but disabled on all network interfaces.

Telnet can be used to give an administrator access to the system command line shell. This service may be useful for local administrator and the user access to selected serial consoles. We recommended that you disable this service if the console server is remotely administered.

The **Enable Telnet command shell** checkbox will enable or disable the Telnet service. An alternate Telnet port to listen on can be specified in **Alternate Telnet Port** (default port is 23).

SSH This service provides secure SSH access to the console server and attached devices – and by default the SSH service is running and enabled on all interfaces. It is recommended you choose SSH as the protocol where an administrator connects to the console server over the Internet or any other public network. This will provide authenticated communications between the SSH client program on the remote computer and the SSH sever in the console server. For more information on SSH configuration See Chapter 8 - Authentication.

The **Enable SSH command shell** checkbox will enable or disable this service. An alternate SSH port to listen on can be specified in **SSH command shell port** (default port is 22).

3. Enable and configure other services:

TFTP/FTP If a USB flash card or internal flash is detected on an console server, checking **Enable TFTP (FTP) service** enables this service and set up default *tftp* and *ftp* server on the USB flash. These servers are used to store config files, maintain access and transaction logs etc. Files transferred using tftp and ftp will be stored under */var/mnt/storage.usb/tftpboot/* (or */var/mnt/storage.nvlog/tftpboot/* on ACM7000-series devices). Unchecking **Enable TFTP (FTP) service** will disable the TFTP (FTP) service.

DNS Relay Checking **Enable DNS Server/Relay** enables the DNS relay feature so clients can be configured with the console server's IP for their DNS server setting, and the console server will forward the DNS queries to the real DNS server.

Web Terminal Checking **Enable Web Terminal** allows web browser access to the system command line shell via **Manage > Terminal**.

4. Specify alternate port numbers for Raw TCP, direct Telnet/SSH and unauthenticated Telnet/SSH services. The console server uses specific ranges for the TCP/IP ports for the various access services that users can use to access devices attached to serial ports (as covered in *Chapter 3 – Configure Serial Ports*). The administrator can set alternate ranges for these services and these secondary ports will be used in addition to the defaults.

The default TCP/IP **base** port address for *Telnet* access is 2000, and the range for *Telnet* is IP Address: Port (2000 + serial port #) *i.e.* 2001 – 2048. If an administrator were to set 8000 as a secondary base for Telnet, serial port #2 on the console server can be Telnet accessed at IP Address:2002 and at IP Address:8002. The default base for SSH is 3000; for Raw TCP is 4000; and for RFC2217 it is 5000

5. Other services can be enabled and configured from this menu by selecting *Click here to configure*:

Nagios Access to the Nagios NRPE monitoring daemons

NUT Access to the NUT UPS monitoring daemon

SNMP Enables *netsnmp* in the console server. SNMP is disabled by default

NTP

6. Click **Apply**. A confirmation message appears: **Message Changes to configuration succeeded**

The Services Access settings can be set to allow or block access. This specifies which enabled services administrators can use over each network interface to connect to the console server and through the console server to attached serial and network connected devices.

1. Select the **Service Access** tab on the **System > Services** page.

Service Settings		Service Access				Web Management Settings		Brute Force Protection	
Services	Service Enabled	Network Interface	Wireless Network	Management LAN	Dialout/Cellular	Dial-in	VPN		
HTTP Web Management	Enabled	<input type="checkbox"/>	<input type="checkbox"/>	<input type="checkbox"/>	<input type="checkbox"/>	<input type="checkbox"/>	<input type="checkbox"/>		<input type="checkbox"/>
HTTPS Web Management	Enabled	<input checked="" type="checkbox"/>	<input checked="" type="checkbox"/>	<input checked="" type="checkbox"/>	<input checked="" type="checkbox"/>	<input checked="" type="checkbox"/>	<input checked="" type="checkbox"/>		<input checked="" type="checkbox"/>
Telnet command shell	Enabled	<input type="checkbox"/>	<input type="checkbox"/>	<input type="checkbox"/>	<input type="checkbox"/>	<input type="checkbox"/>	<input type="checkbox"/>		<input type="checkbox"/>
SSH command shell	Enabled	<input checked="" type="checkbox"/>	<input checked="" type="checkbox"/>	<input checked="" type="checkbox"/>	<input checked="" type="checkbox"/>	<input checked="" type="checkbox"/>	<input checked="" type="checkbox"/>		<input checked="" type="checkbox"/>
Telnet direct to serial ports	N/A	<input checked="" type="checkbox"/>	<input checked="" type="checkbox"/>	<input checked="" type="checkbox"/>	<input type="checkbox"/>	<input checked="" type="checkbox"/>	<input checked="" type="checkbox"/>		<input checked="" type="checkbox"/>
SSH direct to serial ports	N/A	<input checked="" type="checkbox"/>	<input checked="" type="checkbox"/>	<input checked="" type="checkbox"/>	<input checked="" type="checkbox"/>	<input checked="" type="checkbox"/>	<input checked="" type="checkbox"/>		<input checked="" type="checkbox"/>
RAW TCP access to serial ports	N/A	<input checked="" type="checkbox"/>	<input checked="" type="checkbox"/>	<input checked="" type="checkbox"/>	<input type="checkbox"/>	<input checked="" type="checkbox"/>	<input checked="" type="checkbox"/>		<input checked="" type="checkbox"/>
RFC-2217 access to serial ports	N/A	<input checked="" type="checkbox"/>	<input checked="" type="checkbox"/>	<input checked="" type="checkbox"/>	<input type="checkbox"/>	<input checked="" type="checkbox"/>	<input checked="" type="checkbox"/>		<input checked="" type="checkbox"/>
Unauthenticated telnet access to serial ports	N/A	<input checked="" type="checkbox"/>	<input checked="" type="checkbox"/>	<input checked="" type="checkbox"/>	<input type="checkbox"/>	<input checked="" type="checkbox"/>	<input checked="" type="checkbox"/>		<input checked="" type="checkbox"/>
Unauthenticated SSH access to serial ports	N/A	<input checked="" type="checkbox"/>	<input checked="" type="checkbox"/>	<input checked="" type="checkbox"/>	<input type="checkbox"/>	<input checked="" type="checkbox"/>	<input checked="" type="checkbox"/>		<input checked="" type="checkbox"/>
Nagios NRPE daemon	Disabled	<input checked="" type="checkbox"/>	<input checked="" type="checkbox"/>	<input checked="" type="checkbox"/>	<input type="checkbox"/>	<input checked="" type="checkbox"/>	<input checked="" type="checkbox"/>		<input checked="" type="checkbox"/>
NUT UPS monitoring daemon	Disabled	<input checked="" type="checkbox"/>	<input checked="" type="checkbox"/>	<input checked="" type="checkbox"/>	<input type="checkbox"/>	<input checked="" type="checkbox"/>	<input checked="" type="checkbox"/>		<input checked="" type="checkbox"/>

2. This displays the enabled services for the console server's network interfaces. Depending on the particular console server model the interfaces displayed may include:
 - Network interface (for the principal Ethernet connection)
 - Management LAN / OOB Failover (second Ethernet connections)
 - Dialout/Cellular (V90 and 3G modem)
 - Dial-in (internal or external V90 modem)
 - Wi-Fi (802.11 wireless)
 - VPN (IPsec or Open VPN connection over any network interface)
3. Check/uncheck for each network which service access is to be enabled /disabled

The **Respond to ICMP echoes** (i.e. *ping*) service access options that can be configured at this stage. This allows the console server to respond to incoming ICMP echo requests. Ping is enabled by default. For increased security, you should disable this service when you complete initial configuration

You can allow serial port devices to be accessed from nominated network interfaces using Raw TCP, direct Telnet/SSH, unauthenticated Telnet/SSH services, etc.

4. Click **Apply**

Web Management Settings

The **Enable HSTS** checkbox enables strict HTTP strict transport security. HSTS mode means that a Strict-Transport-Security header should be sent over HTTPS transport. A compliant web browser remembers this header, and when asked to contact the same host over HTTP (plain) it will automatically switch to HTTPS before attempting HTTP, as long as the browser has accessed the secure site once and seen the S-T-S header.

Brute Force Protection

Brute force protection (Micro Fail2ban) temporarily blocks source IPs that show malicious signs, such as too many password failures. This may help when the device's network services are exposed to an untrusted network such as the public WAN and scripted attacks or software worms are attempting to guess (brute force) user credentials and gain unauthorized access.

Brute Force Protection may be enabled for the listed services. By default, once protection is enabled 3 or more failed connection attempts within 60 seconds from a specific source IP trigger it to be banned from connecting for a configurable time period. **Attempt limit** and **Ban timeout** may be customized. Active Bans are also listed and may be refreshed by reloading the page.

NOTE When running on an untrusted network, consider using a variety of strategies are used to lock down remote access. This includes SSH public key authentication, VPN, and Firewall Rules to whitelist remote access from trusted source networks only. See the Opengear Knowledge Base for details.

2.5 Communications Software

You have configured access protocols for the administrator client to use when connecting to the console server. User clients also use these protocols when accessing console server serial attached devices and network attached hosts. You need communications software tools set up on the administrator and user client's computer. Opengear provides the *SDT Connector* as the recommended client software tool. You may use other tools such as *PuTTY* and *SSHTerm*.

SDT Connector is a lightweight tool that enables users to securely access the Console server and various computers, network devices, and appliances that are serially or network connected to the console server.

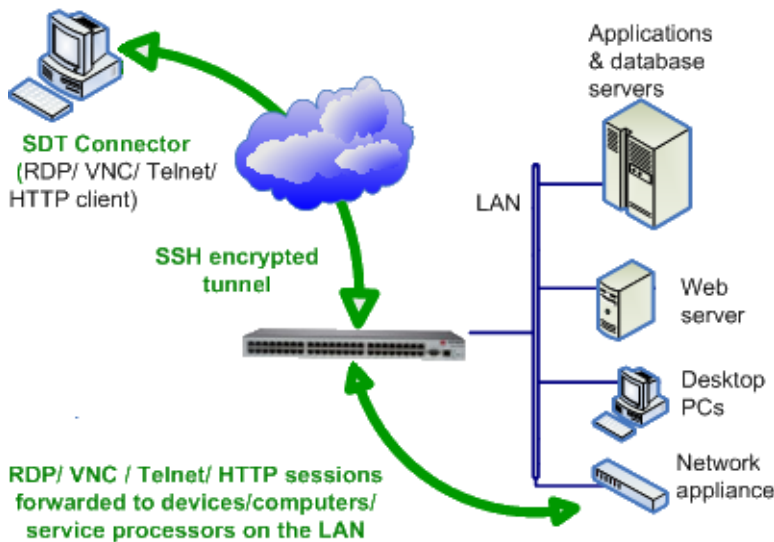

SDT Connector is a Java client program that couples the trusted SSH tunneling protocol with popular access tools such as Telnet, SSH, HTTP, HTTPS, VNC, RDP to provide point-and-click secure remote management access to all the systems and devices being managed.

Information on using *SDT Connector* for browser access to the console server's Management Console, Telnet/SSH access to the console server command line, and TCP/UDP connecting to hosts that are network connected to the console server can be found in *Chapter 5*.

SDT Connector can be installed on Windows PCs, Mac OS X and on most Linux, UNIX and Solaris systems.

2.6 Management Network Configuration

Console servers have additional network ports that can be configured to provide management LAN access and/or failover or out-of-band access.

2.6.1 Enable the Management LAN

Console servers can be configured so the second Ethernet port provides a management LAN gateway. The gateway has firewall, router and DHCP server features. You need to connect an external LAN switch to Network/LAN 2 to attach hosts to this management LAN:

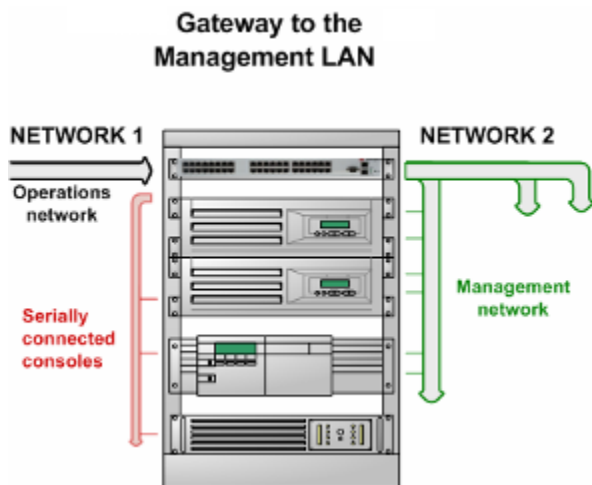

NOTE The second Ethernet port can be configured as either a Management LAN gateway port or as an OOB/Failover port. Ensure you did not allocate **NET2** as the **Failover Interface** when you configured the principal **Network** connection on the **System > IP** menu.

To configure the Management LAN gateway:

1. Select the **Management LAN Interface** tab on the **System > IP** menu and uncheck **Disable**.
2. Configure the **IP Address** and **Subnet Mask** for the Management LAN. Leave the **DNS** fields blank.
3. Click **Apply**.

Network Interface	Wireless Network Interface	Management LAN Interface	General Settings	Route Settings
<p>Disable <input checked="" type="checkbox"/> Deactivate this network interface.</p>				
<p>IP Settings: Management LAN - Currently Disabled</p>				
<p>Configuration Method <input type="radio"/> DHCP <input type="radio"/> Static The mechanism to acquire IP settings.</p>				
<p>IP Address <input type="text"/> A statically assigned IP address.</p>				
<p>Subnet Mask <input type="text"/> A statically assigned network mask.</p>				
<p>Gateway <input type="text"/> Default gateway for the unit.</p>				
<p>DNS Search Domain <input type="text"/> A comma separated list of suffixes used for completing a given query name to a fully qualified domain name when no domain suffix is supplied.</p>				
<p>Primary DNS <input type="text"/> A statically assigned primary name server.</p>				
<p>Secondary DNS <input type="text"/> A statically assigned secondary name server.</p>				
<p>Media <input type="button" value="Auto"/> <input checked="" type="checkbox"/> The Ethernet media type.</p>				
<p>MTU <input type="text"/> The Ethernet Maximum Transmit Unit.</p>				
<p>DHCP Server Disabled Configure a DHCP server for this interface.</p>				
<p>IP Alias <input type="text"/> Secondary address or comma-separated list of addresses in CIDR notation, e.g. 192.168.1.1/24.</p>				

The management gateway function is enabled with default firewall and router rules configured so the Management LAN is only accessible by SSH port forwarding. This ensures the remote and local connections to Managed devices on the Management LAN are secure. The LAN ports can also be configured in bridged or bonded mode or manually configured from the command line.

2.6.2 Configure the DHCP server

The DHCP server enables the automatic distribution of IP addresses to devices on the Management LAN that are running DHCP clients. To enable the DHCP server:

1. Click **System > DHCP Server**.
2. On the **Network Interface** tab, Check **Enable DHCP Server**.

User Manual

Network Interface	Management LAN Interface	Wireless Network Interface
Network DHCP Server Settings (Subnet 10.250.241.0 / 255.255.255.0)		
DHCP Server	<input checked="" type="checkbox"/> Enable DHCP Server	
Gateway	<input type="text"/> The Default Gateway to assign.	
Use interface address as gateway	<input type="checkbox"/> Use this Interface as the DHCP Gateway.	
Primary DNS	<input type="text"/> The primary DNS to assign.	
Secondary DNS	<input type="text"/> The secondary DNS to assign.	
Use this interface address as the DNS server	<input type="checkbox"/> Use the built-in DNS relay for DNS lookups. <small>The DNS service must be enabled on the Services page</small>	
Domain Name	<input type="text"/> The Domain Name to assign.	
Default Lease	<input type="text"/> The Default Lease Time in Seconds.	
Maximum Lease	<input type="text"/> The Maximum Lease Time in Seconds.	
<input type="button" value="Apply"/>		

3. Enter the **Gateway** address to be issued to the DHCP clients. If this field is left blank, the console server's IP address is used.
4. Enter the **Primary DNS** and **Secondary DNS** address to issue the DHCP clients. If this field is left blank, console server's IP address is used.
5. Optionally enter a **Domain Name** suffix to issue DHCP clients.
6. Enter the **Default Lease** time and **Maximum Lease** time in seconds. This is the amount of time that a dynamically assigned IP address is valid before the client must request it again.
7. Click **Apply**

The DHCP server issues IP addresses from specified address pools:

1. Click **Add** in the **Dynamic Address Allocation Pools** field.
2. Enter the **DHCP Pool Start Address** and **End Address**.
3. Click **Apply**.

Dynamic Address Allocation Pools		
Pool Start	Pool End	
No address pools currently allocated.		
<input type="button" value="Add"/>		
Reserved Addresses		
IP Address	Host Name	HW Address
No addresses currently reserved.		
<input type="button" value="Add"/>		

The DHCP server also supports pre-assigning IP addresses to be allocated to specific MAC addresses and reserving IP addresses to be used by connected hosts with fixed IP addresses. To reserve an IP address for a particular host:

1. Click **Add** in the **Reserved Addresses** field

2. Enter the **Hostname**, the **Hardware Address** (MAC) and the **Statically Reserved IP** address for the DHCP client and click **Apply**

The screenshot shows the 'Network Interface' configuration page. At the top, there are tabs for 'Management LAN Interface' and 'Wireless Network Interface'. Below these is the 'Statically Reserved Address' section, which contains three input fields: 'Host Name' (with a tooltip 'The name to identify this host by.'), 'Statically Reserved IP' (with a tooltip 'IP Address reserved for specific host.'), and 'Hardware Address' (with a tooltip 'MAC Address to reserve IP for.'). An 'Apply' button is located at the bottom left of the form.

When DHCP has allocated hosts addresses, it is recommended to copy these into the pre-assigned list so the same IP address is reallocated in the event of a reboot.

2.6.3 Select Failover or broadband OOB

Console servers provide a failover option so in the event of a problem using the main LAN connection for accessing the console server an alternate access path is used.

To enable failover:

1. Select the **Network Interface** page on the **System > IP** menu
2. Select the **Failover Interface** to be used in the event of an outage on the main network.

The screenshot shows the 'Failover' configuration page. The 'Failover Interface' dropdown menu is open, showing options: 'None' (selected), 'Management LAN (lan) DISABLED' (with a tooltip 'must be configured and enabled for failover to work.'), 'Serial Console (sercon) DISABLED', 'Internal Modem (modem01) DISABLED', and 'Internal Cellular Modem (cellmodem01)'. Below the dropdown are fields for 'Dormant Failover Interface', 'Primary Probe Address' (with a tooltip 'The address of the first peer to probe for connectivity detection.'), and 'Secondary Probe Address' (with a tooltip 'The address of the second peer to probe for connectivity detection.').

3. Click **Apply**. Failover becomes active after you specify the external sites to be probed to trigger failover and set up the failover ports.

2.6.4 Aggregating the network ports

By default, the console server's Management LAN network ports can be accessed using SSH tunneling /port forwarding or by establishing an IPsec VPN tunnel to the console server.

All the wired network ports on the console servers can be aggregated by being bridged or bonded.

The screenshot shows the 'General Settings' tab for a Network Interface. It includes the following options:

- Interface Aggregation:** Radio buttons for Disabled (selected), Bridge interfaces, and Bond interfaces. A note below reads: 'Enable aggregation of wired Ethernet interfaces.'
- Enable IPv6:** A checked checkbox with the note: 'Enable IPv6 for all interfaces.'
- Disable IPv6 for Cellular:** An unchecked checkbox with the note: 'Disable IPv6 specifically for the Cellular Modem Interface.'

An 'Apply' button is located at the bottom left of the settings area.

- By default, **Interface Aggregation** is disabled on the **System > IP > General Settings** menu
 - Select **Bridge Interfaces** or **Bond Interfaces**
 - When bridging is enabled, network traffic is forwarded across all Ethernet ports with no firewall restrictions. All the Ethernet ports are all transparently connected at the data link layer (layer 2) so they retain their unique MAC addresses
 - With bonding, the network traffic is carried between the ports but present with one MAC address
- Both modes remove all the **Management LAN Interface** and **Out-of-Band/Failover Interface** functions and disable the **DHCP Server**
- In aggregation mode all Ethernet ports are collectively configured using the **Network Interface** menu

The screenshot shows the 'IP Settings: Network' page. It includes the following configuration options:

- Configuration Method:** Radio buttons for DHCP and Static (selected). A note below reads: 'The mechanism to acquire IP settings.'
- IP Address:** A text input field with the note: 'A statically assigned IP address.'
- Subnet Mask:** A text input field with the note: 'A statically assigned network mask.'
- Gateway:** A text input field with the note: 'Default gateway for the unit.'
- DNS Search Domain:** A text input field with the note: 'A comma separated list of suffixes used for completing a given query name to a fully qualified domain name when no domain suffix is supplied.'
- Primary DNS:** A text input field with the note: 'A statically assigned primary name server.'
- Secondary DNS:** A text input field with the note: 'A statically assigned secondary name server.'
- Media:** A dropdown menu set to 'Auto' with a note: 'The Ethernet media type.'
- MTU:** A text input field with the note: 'The Ethernet Maximum Transmit Unit.'
- DHCP Server:** A red 'Disabled' label with the note: 'Configure a DHCP server for this interface.'
- IP Alias:** A text input field with the note: 'Secondary address or comma-separated list of addresses in CIDR notation, e.g. 192.168.1.1/24.'

2.6.5 Wi-Fi Wireless LAN

To activate and configure the Wireless Access Point functionality, navigate to the **System > IP** page. Click the **Wireless Network Interface** tab. Uncheck the **Disable** box.

Network Interface	Wireless Network Interface	Management LAN Interface	General Settings	Route Settings
Disable <input type="checkbox"/> Deactivate this network interface.				
IP Settings: Wireless Network - Currently Disabled				
Configuration Method <input type="radio"/> DHCP <input type="radio"/> Static The mechanism to acquire IP settings.				
IP Address <input type="text"/> A statically assigned IP address.				
Subnet Mask <input type="text"/> A statically assigned network mask.				
Gateway <input type="text"/> Default gateway for the unit.				
DNS Search Domain <input type="text"/> A comma separated list of suffixes used for completing a given query name to a fully qualified domain name when no domain suffix is supplied.				
Primary DNS <input type="text"/> A statically assigned primary name server.				
Secondary DNS <input type="text"/> A statically assigned secondary name server.				
DHCP Server Disabled Configure a DHCP server for this interface.				
IP Alias <input type="text"/> Secondary address or comma-separated list of addresses in CIDR notation, e.g. 192.168.1.1/24.				
Serial Port Aliases None				

WAP configuration

1. Configure the **IP Settings** for the Wireless Network. If the device is being used as a Wireless AP, a static address is set here in the IP Settings. In this example, 192.168.10.1 is used. Set the IP address, and the netmask, but do not fill in the Gateway, Primary DNS, and Secondary DNS. These settings are used if the interface is to be the primary network link to the outside world, or if it will be used for failover.

2. Select **Wireless AP**. The **Wireless AP Settings** section appears with these fields:

Select a country from the **Country** list, or if it isn't there, select the World Regulatory Domain

Select a unique **SSID** for the network

Broadcast SSID: Tick this to broadcast the SSID.

Network Channel: Select the network channel. 6 is most common so it is best to do a site survey and pick another channel if the unit is being deployed in an office environment

Hardware Mode: The unit supports 802.11b,g and single band 802.11n. In most cases, selection 802.11b/g/n provides the best interoperability with other hardware.

Supported Authentication Methods: Select the authentication method for the AP. If the client equipment supports it, it is best to select WPA/WPA2 and AES encryption. WEP and WPA with TKIP have been proven vulnerable to cryptanalysis.

If WEP is selected:

- **WEP Mode:** Select Open System or Shared System. Open System is more secure than Shared, due to the way encryption keys are used.
- **WEP Key Length:** Select the WEP key length. 128-bit keys offer more security but are not supported on all devices. WEP Keys must be entered in Hexidecimal.
- **WEP Key 1-4:** Up to 4 WEP keys can be used on a single network.
- **Default Transmit Key:** This selects the default transmit key for the network

If WPA/WPA2 is selected:

- **WPA/WPA2 Encryption Methods:** Select one or both of TKIP or AES for encrypting WPA/WPA2 connections. AES is more secure and required for the AP to advertise itself as 802.11n if that hardware mode is selected
- **WPA Password:** The password that clients use to connect to the AP.

3. Once the Wireless AP Settings have been filled out, click **Apply**. Wait for the page to refresh.

The next step is to set up a DHCP server for the wireless clients. Click the link next to **DHCP Server** in the IP settings section, or go to **System > DHCP Server** page. More information on configuring DHCP can be found in Chapter 2.6.

The Wireless screen on the **Status > Statistics** page shows the list of clients that are connected to the WAP

The screenshot shows the 'Status: Statistics' page with the 'Wireless' tab selected. The main content area displays statistics for the 'wlan0' interface. At the top, it shows 'IEEE 802.11bgn Mode: Master Frequency: 2.442 GHz Tx-Power=20 dBm', 'Retry long limit: 7 RTS thr: off Fragment thr: off', and 'Power Management: off'. Below this, two stations are listed with their MAC addresses and various statistics:

Station	MAC Address	Interface	Inactive Time	Rx Bytes	Rx Packets	Tx Bytes	Tx Packets	Signal	Tx Bitrate
Station b4:07:f9:89:9a:d8	b4:07:f9:89:9a:d8	wlan0	188 ms	7747	99	77200	76	-61 dBm	43.3 MBit/s MCS 4 short GI
Station d0:23:db:60:db:d1	d0:23:db:60:db:d1	wlan0	334 ms	27974	356				

Wireless Client configuration

1. Select **Wireless Client** in the **Wireless Settings** section - which makes the **Wireless Client Settings** section visible. Select **DHCP** or **Static** for the **Configuration Method**
 - For **Static**, enter the new **IP Address**, **Subnet Mask**, **Gateway** and **DNS** server details. This selection disables the DHCP client

- For **DHCP**, the device looks for configuration details from a DHCP server on your management LAN. This selection disables any static address. The device MAC address can be found on a label on the base plate
2. The wireless LAN when enabled in client mode operates as the main network connection to the device so failover is available. Use **Failover Interface** to select the device to failover to in case of wireless outage and specify **Probe Addresses** of the peers to be probed for connectivity detection
 3. Configure the Wireless Client to select the local wireless network which serves as the main network connection to the console server.
 - Select the **Country** the device is to operate in
 - Enter the appropriate **SSID** (Set Service Identifier) of the wireless access point to connect to
 - Select the **Wireless Network Type** where **Infrastructure** is used to connect to an access point and **Ad-hoc** to connect to a computer
 - Select the **Wireless Security** mode of the wireless network (WEP, WPA etc.) and enter the required Key / Authentication / Encryption settings

Network Interface	Wireless Network Interface	Management LAN Interface	General Settings	Route Settings
Disable <input type="checkbox"/> Deactivate this network interface.				
IP Settings: Wireless Network - Currently Disabled				
Configuration Method <input type="radio"/> DHCP <input type="radio"/> Static <small>The mechanism to acquire IP settings.</small>				
IP Address <input type="text"/> <small>A statically assigned IP address.</small>				
Subnet Mask <input type="text"/> <small>A statically assigned network mask.</small>				
Gateway <input type="text"/> <small>Default gateway for the unit.</small>				
DNS Search Domain <input type="text"/> <small>A comma separated list of suffixes used for completing a given query name to a fully qualified domain name when no domain suffix is supplied.</small>				
Primary DNS <input type="text"/> <small>A statically assigned primary name server.</small>				
Secondary DNS <input type="text"/> <small>A statically assigned secondary name server.</small>				
DHCP Server Disabled <small>Configure a DHCP server for this interface.</small>				
IP Alias <input type="text"/> <small>Secondary address or comma-separated list of addresses in CIDR notation, e.g. 192.168.1.1/24.</small>				
Serial Port Aliases None				

NOTE The **Wireless Network Interface** screen in **Status > Statistics** displays all locally accessible wireless LANs (with SSID and Encryption/Authentication settings). You can also use this screen to confirm you have connected to the selected access point.

2.6.6 Static routes

Static routes provide a very quick way to route data from one subnet to different subnet. You can hard code a path that tells the console server/router to get to a certain subnet using a certain path. This may be useful for accessing various subnets at a remote site when using the cellular OOB connection.

User Manual

Network Interface	Wireless Network Interface	Management LAN Interface	General Settings	Route Settings
Route Settings				
Route Name	<input type="text" value="New Route"/> Meaningful name for the Route			
Destination Network/Host	<input type="text"/> The destination network/host that the route provides access to.			
Destination netmask	<input type="text" value="24"/> The netmask of the destination network. A number in the range 0-32			
Route Gateway	<input type="text"/> The IP address of a router that will route packets to the destination network			
Interface	None <input type="button" value="v"/> An interface to associate with the route. Can be left as None. <i>Interface must be enabled.</i>			
Metric	<input type="text" value="0"/> The route metric, which represents the cost of routing packets via this route. Lower metric routes will be used in preference to higher metric routes			
<input type="button" value="Apply"/>				

To add to the static route to the route table of the System:

1. Select the **Route Settings** tab on the **System > IP General Settings** menu.
2. Click **New Route**
3. Enter a **Route Name** for the route.
4. In the **Destination Network/Host** field, enter the IP address of the destination network/host that the route provides access to.
5. Enter a value in the **Destination netmask** field that identifies the destination network or host. Any number between 0 and 32. A subnet mask of 32 identifies a host route.
6. Enter **Route Gateway** with the IP address of a router that will routes packets to the destination network. This may be left blank.
7. Select the **Interface** to use to reach the destination, may be left as **None**.
8. Enter a value in the **Metric** field that represents the metric of this connection. Use any number equal to or greater than 0. This only has to be set if two or more routes conflict or have overlapping targets.
9. Click **Apply**.

NOTE The route details page provides a list of network interfaces and modems to which a route can be bound. In the case of a modem, the route will be attached to any dialup session established via that device. A route can be specified with a gateway, an interface or both. If the specified interface is not active, routes configured for that interface will not be active.

3 SERIAL PORT, HOST, DEVICE & USER CONFIGURATION

The console server enables access and control of serially-attached devices and network-attached devices (hosts). The administrator must configure access privileges for each of these devices and specify the services that can be used to control the devices. The administrator can also set up new users and specify each user's individual access and control privileges.

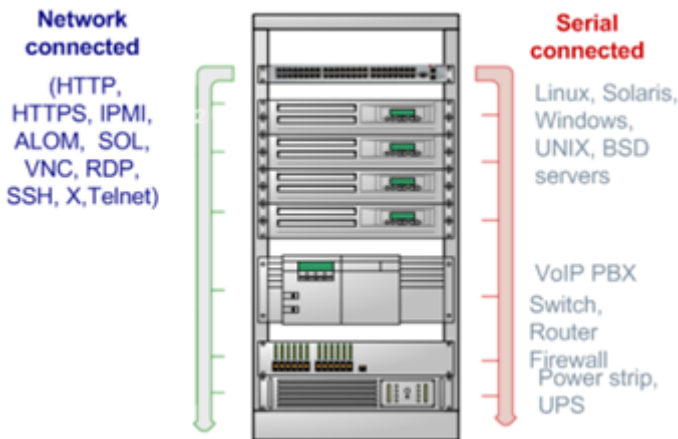

This chapter covers each of the steps in configuring network connected and serially attached devices:

- Serial Ports – setting up protocols used serially connected devices
- Users & Groups – setting up users and defining the access permissions for each of these users
- Authentication – this is covered in more detail in Chapter 8
- Network Hosts – configuring access to local network connected computers or appliances (hosts)
- Configuring Trusted Networks - nominate IP addresses that trusted users access from
- Cascading and Redirection of Serial Console Ports
- Connecting to power (UPS, PDU, and IPMI) and environmental monitoring (EMD) devices
- Serial Port Redirection – using the PortShare windows and Linux clients
- Managed Devices - presents a consolidated view of all the connections
- IPSec – enabling VPN connection
- OpenVPN
- PPTP

3.1 Configure Serial Ports

The first step in configuring a serial port is to set the **Common Settings** such as the protocols and the RS232 parameters that are to be used for the data connection to that port (e.g. baud rate).

Select what mode the port is to operate in. Each port can be set to support one of these operating modes:

- Disabled mode is the default, the serial port is inactive
- Console server mode enables general access to serial console port on the serially attached devices

User Manual

- Device mode sets the serial port up to communicate with an intelligent serial controlled PDU, UPS or Environmental Monitor Devices (EMD)
- SDT mode enables graphical console access (with RDP, VNC, HTTPS etc.) to hosts that are serially connected
- Terminal Server mode sets the serial port to await an incoming terminal login session
- Serial Bridge mode enables the transparent interconnection of two serial port devices over a network

Port #	Label	Connector	Mode	Logging Level	Parameters	Flow Control	Port Pinout
1	Port 1	RJ45	Disabled Mode	0	9600-8-N-1	None	X2 Edit
2	Port 2	RJ45	Disabled Mode	0	9600-8-N-1	None	X2 Edit
3	Port 3	RJ45	Disabled Mode	0	9600-8-N-1	None	X2 Edit
4	Port 4	RJ45	Disabled Mode	0	9600-8-N-1	None	X2 Edit
5	Port 5	RJ45	Disabled Mode	0	9600-8-N-1	None	X2 Edit
6	Port 6	RJ45	Disabled Mode	0	9600-8-N-1	None	X2 Edit
7	Port 7	RJ45	Disabled Mode	0	9600-8-N-1	None	X2 Edit
8	Port 8	RJ45	Disabled Mode	0	9600-8-N-1	None	X2 Edit
9	Port 9	RJ45	Disabled Mode	0	9600-8-N-1	None	X2 Edit
10	Port 10	RJ45	Disabled Mode	0	9600-8-N-1	None	X2 Edit
11	Port 11	RJ45	Disabled Mode	0	9600-8-N-1	None	X2 Edit
12	Port 12	RJ45	Disabled Mode	0	9600-8-N-1	None	X2 Edit
13	Port 13	RJ45	Disabled Mode	0	9600-8-N-1	None	X2 Edit
14	Port 14	RJ45	Disabled Mode	0	9600-8-N-1	None	X2 Edit
15	Port 15	RJ45	Disabled Mode	0	9600-8-N-1	None	X2 Edit

1. Select **Serial & Network > Serial Port** to display serial port details
2. By default, each serial port is set in Console server mode. Click **Edit** next to the port to be reconfigured. Or click **Edit Multiple Ports** and select which ports you wish to configure as a group.
3. When you have reconfigured the common settings and the mode for each port, set up any remote syslog (see the following sections for specific information). Click **Apply**
4. If the console server has been configured with distributed Nagios monitoring enabled, use **Nagios Settings** options to enable nominated services on the Host to be monitored

3.1.1 Common Settings

There are a number of common settings that can be set for each serial port. These are independent of the mode in which the port is being used. These serial port parameters must be set so they match the serial port parameters on the device you attach to that port:

Common Settings for Port 1	
Label	<input type="text" value="Console Access"/> The serial ports unique identifier.
Disabled Mode	<input type="radio"/> Disable this serial port.
Local Console Mode	<input checked="" type="radio"/> Use this serial port for console or dial-in access. Warning: This will override all other port settings
Baud Rate	<input type="text" value="115200"/> The serial ports speed.
Data Bits	<input type="text" value="8"/> The number of data bits to use.
Parity	<input type="text" value="None"/> The serial ports parity.
Stop Bits	<input type="text" value="1"/> The number of stop bits to use.
Flow Control	<input type="text" value="None"/> The flow control method.
DTR Mode	<input type="text" value="Always On"/> The logic used to determine when DTR should be asserted. <i>If a flow control method that leaves the control signals unpowered is chosen, then this logic does not apply</i>

- Type in a label for the port
- Select the appropriate **Baud Rate**, **Parity**, **Data Bits**, **Stop Bits** and **Flow Control** for each port
- Set the **Port Pinout**. This menu item appears for IM7200 ports where pin-out for each RJ45 serial port can be set as either X2 (Cisco Straight) or X1 (Cisco Rolled)
- Set the **DTR mode**. This allows you to choose if DTR is always asserted or only asserted when there is an active user session
- Before proceeding with further serial port configuration, you should connect the ports to the serial devices they will be controlling and ensure they have matching settings

3.1.2 Console Server Mode

Select Console server **Mode** to enable remote management access to the serial console that is attached to this serial port:

Console Server Settings	
Console Server Mode	<input checked="" type="radio"/> Enable remote network access to the console at this serial port.
Logging Level	<input type="text" value="level 0 - Disabled"/> Specify the detail of data to log. In this context: - output is the data transmitted from the console server to the connected device. - input is the data received by the console server from the connected device.
Telnet	<input checked="" type="checkbox"/> Enable Telnet access.
SSH	<input checked="" type="checkbox"/> Enable SSH access.
Raw TCP	<input type="checkbox"/> Enable raw TCP access.
RFC 2217	<input type="checkbox"/> Enable RFC 2217 access.
Unauthenticated Telnet	<input type="checkbox"/> Enable Telnet access without requiring the user to provide credentials.
Web Terminal	<input type="checkbox"/> Enable web browser access via <i>Manage -> Devices -> Serial</i> .
Network Interface IP Alias	<input type="text" value="1.2.3.4/24"/> Comma-separated list of IP addresses on which only this port is available, in CIDR notation, e.g. 192.168.1.1/24.
Management LAN IP Alias	<input type="text"/> Comma-separated list of IP addresses on which only this port is available, in CIDR notation, e.g. 192.168.1.1/24.
Out-of-Band/Failover IP Alias	<input type="text"/> Comma-separated list of IP addresses on which only this port is available, in CIDR notation, e.g. 192.168.1.1/24.

Logging Level This specifies the level of information to be logged and monitored.

User Manual

Level 0: Disable logging (default)

Level 1: Log LOGIN, LOGOUT and SIGNAL events

Level 2: Log LOGIN, LOGOUT, SIGNAL, TXDATA and RXDATA events

Level 3: Log LOGIN, LOGOUT, SIGNAL and RXDATA events

Level 4: Log LOGIN, LOGOUT, SIGNAL and TXDATA events

Input/RXDATA is data received by the Opegear device from the connected serial device, and output/TXDATA is data sent by the Opegear device (e.g. typed by the user) to the connected serial device.

Device consoles typically echo back characters as they are typed so TXDATA typed by a user is subsequently received as RXDATA, displayed on their terminal.

NOTE: After prompting for a password, the connected device sends * characters to prevent the password from being displayed.

Telnet When the Telnet service is enabled on the console server, a Telnet client on a user's computer can connect to a serial device attached to this serial port on the console server. Because Telnet communications are unencrypted, this protocol is only recommended for local or VPN tunneled connections.

If the remote communications are being tunneled with SDT Connector, Telnet can be used for securely accessing these attached devices.

NOTE In console server mode, users can use SDT Connector to set up secure Telnet connections that are SSH tunneled from their client computers to the serial port on the console server. SDT Connector can be installed on Windows PCs and most Linux platforms and it enables secure Telnet connections to be selected with point-and-click.

To use SDT Connector to access consoles on the console server serial ports, configure SDT Connector with the console server as a gateway, and as a host, and enable Telnet service on Port (2000 + serial port #) i.e. 2001–2048.

You can also use standard communications packages like PuTTY to set a direct Telnet or SSH connection to the serial ports.

NOTE In Console server mode, when you connect to a serial port you connect via pmsHELL. To generate a BREAK on the serial port, type the character sequence ~b. If you're doing this over OpenSSH type ~~b.

SSH It is recommended that you use SSH as the protocol when users connect to the console server (or connect through the console server to the attached serial consoles) over the Internet or any other public network.

For SSH access to the consoles on devices attached to the console server serial ports, you can use SDT Connector. Configure SDT Connector with the console server as a gateway, and as a host, and enable SSH service on Port (3000 + serial port #) i.e. 3001-3048.

You can also use common communications packages, like PuTTY or SSHTerm to SSH connect to port address IP Address _ Port (3000 + serial port #) i.e. 3001–3048

SSH connections can be configured using the standard SSH port 22. The serial port being accessed is identified by appending a descriptor to the username. This syntax supports:

<username>:<portXX>

<username>:<port label>

<username>:<ttySX>

<username>:<serial>

For a user named *chris* to access serial port 2, when setting up the SSHTerm or the PuTTY SSH client, instead of typing *username = chris* and *ssh port = 3002*, the alternate is to type *username = chris:port02* (or *username = chris:ttyS1*) and *ssh port = 22*.

Or by typing *username=chris:serial* and *ssh port = 22*, the user is presented with a port selection option:

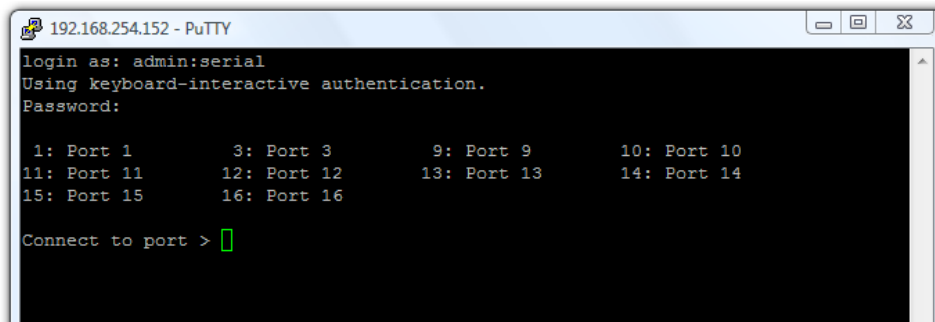

This syntax enables users to set up SSH tunnels to all serial ports with a single IP port 22 having to be opened in their firewall/gateway

NOTE In console server mode, you connect to a serial port via pmshell. To generate a BREAK on the serial port, type the character sequence ~b. If you're doing this over OpenSSH, type ~~b.

TCP RAW TCP allows connections to a TCP socket. While communications programs like *PuTTY* also support RAW TCP, this protocol is usually used by a custom application

For RAW TCP, the default port address is IP Address _ Port (4000 + serial port #) i.e. 4001 – 4048

RAW TCP also enables the serial port to be tunneled to a remote console server, so two serial port devices can transparently interconnect over a network (see *Chapter 3.1.6 – Serial Bridging*)

RFC2217 Selecting RFC2217 enables serial port redirection on that port. For RFC2217, the default port address is IP Address _ Port (5000 + serial port #) i.e. 5001 – 5048

Special client software is available for Windows UNIX and Linux that supports RFC2217 virtual com ports, so a remote host can monitor and manage remote serially attached devices as though they are connected to the local serial port (see *Chapter 3.6 – Serial Port Redirection* for details)

RFC2217 also enables the serial port to be tunneled to a remote console server, so two serial port devices can transparently interconnect over a network (see *Chapter 3.1.6 – Serial Bridging*)

Unauthenticated Telnet This enables Telnet access to the serial port without authentication credentials. When a user accesses the console server to Telnet to a serial port, they are given a login prompt. With unauthenticated Telnet, they connect directly through to the port without any console server login challenge. If a Telnet client does prompt for authentication, any entered data allows connection.

Logging into a device connected to the console server may require authentication.

For Unauthenticated Telnet the default port address is IP Address _ Port (6000 + serial port #)
i.e. 6001 – 6048

Unauthenticated SSH This enables SSH access to the serial port without authentication credentials. When a user accesses the console server to Telnet to a serial port, they are given a login prompt. With unauthenticated SSH they connect directly through to the port without any console server login challenge.

This mode is used when you have another system managing user authentication and access privileges at the serial device level but wish to encrypt the session across the network.

Logging into a device connected to the console server may require authentication.

For Unauthenticated Telnet the default port address is IP Address _ Port (7000 + serial port #)
i.e. 7001 – 7048

The <username>: method of port access (as described in the above **SSH** section) always requires authentication.

Web Terminal This enables web browser access to the serial port via **Manage > Devices: Serial** using the Management Console's built in AJAX terminal. Web Terminal connects as the currently authenticated Management Console user and does not re-authenticate. See section 12.3 for more details.

IP Alias Enable access to the serial port using a specific IP address, specified in CIDR format. Each serial port can be assigned one or more IP aliases, configured on a per-network-interface basis. A serial port can, for example, be made accessible at both 192.168.0.148 (as part of the internal network) and 10.10.10.148 (as part of the Management LAN). It is also possible to make a serial port available on two IP addresses on the same network (for example, 192.168.0.148 and 192.168.0.248).

These IP addresses can only be used to access the specific serial port, accessible using the standard protocol TCP port numbers of the console server services. For example, SSH on serial port 3 would be accessible on port 22 of a serial port IP alias (whereas on the console server's primary address it is available on port 2003).

This feature can also be configured via the multiple port edit page. In this case the IP addresses are applied sequentially, with the first selected port getting the IP entered and subsequent ones getting incremented, with numbers being skipped for any unselected ports. For example, if ports 2, 3 and 5 are selected and the IP alias 10.0.0.1/24 is entered for the Network Interface, the following addresses are assigned:

Port 2: 10.0.0.1/24

Port 3: 10.0.0.2/24

Port 5: 10.0.0.4/24

IP Aliases also support IPv6 alias addresses. The only difference is that addresses are hexadecimal numbers, so port 10 may correspond to an address ending in A, and 11 to one ending in B, rather than 10 or 11 as per IPv4.

Encrypt Traffic	<input type="checkbox"/> Enable PortShare Encryption. Warning: This will override standard RFC 2217 and raw TCP behaviour
Authenticate	<input type="checkbox"/> Enable PortShare Authentication. Warning: This will override standard RFC 2217 and raw TCP behaviour
Authentication Password	<input type="password"/> Enter password for PortShare authentication
Confirm Password	<input type="password"/> Re-type the password for confirmation.
Accumulation Period	<input type="text"/> Collect serial data for a period of time (in milliseconds), then transmit any data received during that time over the network at once.
Escape Character	<input type="text" value="(Currently empty)"/> Customize the character used for sending out-of-band shell commands. <i>The default is: ~</i>
Replace Backspace	<input type="checkbox"/> Substitutes backspace value CTRL+? (127) with CTRL+h (8).
Power Menu	<input type="checkbox"/> Enable shell power command menu. <i>Connect this port to a Managed Device then use ~p to run power commands.</i>
Single Connection	<input type="checkbox"/> Limit the port to a single concurrent connection.

Encrypt Traffic / Authenticate Enable trivial encryption and authentication of RFC2217 serial communications using Portshare (for strong encryption use VPN).

Accumulation Period Once a connection has been established for a particular serial port (such as a RFC2217 redirection or Telnet connection to a remote computer), any incoming characters on that port are forwarded over the network on a character by character basis. The accumulation period specifies a period of time that incoming characters are collected before being sent as a packet over the network

Escape Character Change the character used for sending escape characters. The default is ~.

Replace Backspace Substitute the default backspace value of CTRL+? (127) with CTRL+h (8).

Power Menu The command to bring up the power menu is ~p and enables the shell power command so a user can control the power connection to a managed device from command line when they are Telnet or SSH connected to the device. The managed device must be set up with both its Serial port connection and Power connection configured.

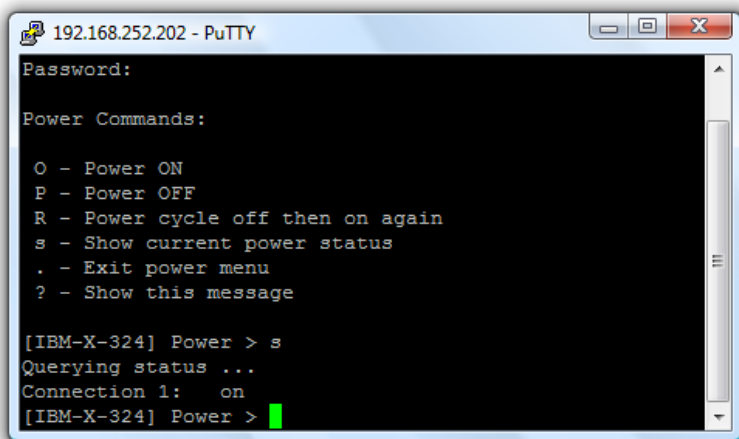

```
192.168.252.202 - PuTTY
Password:
Power Commands:
O - Power ON
P - Power OFF
R - Power cycle off then on again
s - Show current power status
. - Exit power menu
? - Show this message

[IBM-X-324] Power > s
Querying status ...
Connection 1: on
[IBM-X-324] Power >
```

Single Connection This limits the port to a single connection so if multiple users have access privileges for a particular port only one user at a time can access that port (i.e. port snooping is not permitted).

3.1.3 SDT Mode

This setting allows port forwarding of RDP, VNC, HTTP, HTTPS, SSH, Telnet, and other LAN protocols to computers that are locally connected to the console server by their serial COM port. Such port forwarding requires a PPP link to be set up over this serial port.

SDT Settings

SDT Mode	<input type="radio"/>	Enable access over SSH to a host connected to this serial port.
Username	<input type="text"/>	The login name for PPP. <i>The default is 'port08'</i>
User Password	<input type="text"/>	The login secret for PPP. <i>The default is 'port08'</i>
Confirm Password	<input type="text"/>	Re-type the password for confirmation.

For configuration details See Chapter 5.

3.1.4 Device (RPC, UPS, Environmental) Mode

This mode configures the selected serial port to communicate with a serial controlled Uninterruptable Power Supply (UPS), Remote Power Controller / Power Distribution Units (RPC) or Environmental Monitoring Device (Environmental)

Device Settings

Device Type	<input type="text" value="RPC"/>	Specify the device type.
Apply this setting, then use the RPC Connections page to configure the attached power controller.		

1. Select the desired **Device Type** (UPS, RPC, or Environmental)
2. Proceed to the appropriate device configuration page (**Serial & Network > UPS Connections, RPC Connection** or **Environmental**) as detailed in Chapter 7.

3.1.5 Terminal Server Mode

- Select **Terminal Server Mode** and the **Terminal Type** (vt220, vt102, vt100, Linux or ANSI) to enable a getty on the selected serial port

Terminal Server Settings

Terminal Server Mode	<input type="radio"/>	Enable a TTY login for a local terminal attached to this serial port.
Terminal Type	<input type="text" value="vt220"/>	The terminal standard to use on this serial port.

The getty configures the port and wait for a connection to be made. An active connection on a serial device is indicated by the raised Data Carrier Detect (DCD) pin on the serial device. When a connection is detected, the getty program issues a login: prompt, and invokes the login program to handle the system login.

NOTE Selecting Terminal Server mode disables Port Manager for that serial port, so data is no longer logged for alerts etc.

3.1.6 Serial Bridging Mode

With serial bridging, the serial data on a nominated serial port on one console server is encapsulated into network packets and transported over a network to a second console server where it is represented as serial data. The two console servers act as a virtual serial cable over an IP network.

One console server is configured to be the Server. The Server serial port to be bridged is set in Console server mode with either RFC2217 or RAW enabled.

For the Client console server, the serial port to be bridged must be set in Bridging Mode:

Serial Bridge Settings	
Serial Bridging Mode	<input type="radio"/> Create a network connection to a remote serial port via RFC-2217.
Server Address	<input type="text"/> The network address of an RFC-2217 server to connect to.
Server TCP Port	<input type="text"/> The TCP port the RFC-2217 server is serving on.
RFC 2217	<input type="checkbox"/> Enable RFC 2217 access.
SSH Tunnel	<input type="checkbox"/> Redirect the serial bridge over an SSH tunnel to the server

- Select **Serial Bridging Mode** and specify the IP address of the Server console server and the TCP port address of the remote serial port (for RFC2217 bridging this will be 5001-5048)
- By default, the bridging client uses RAW TCP. Select RFC2217 if this is the console server mode you have specified on the server console server

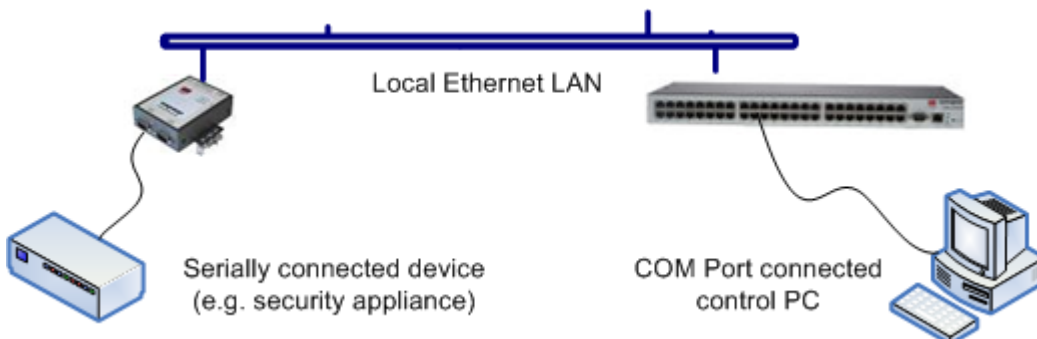

- You can secure the communications over the local Ethernet by enabling SSH. Generate and upload keys.

3.1.7 Syslog

In addition to inbuilt logging and monitoring which can be applied to serial-attached and network-attached management accesses, as covered in Chapter 6, the console server can also be configured to support the remote syslog protocol on a per serial port basis:

- Select the **Syslog Facility/Priority** fields to enable logging of traffic on the selected serial port to a syslog server; and to sort and act on those logged messages (i.e. redirect them / send alert email.)

User Manual

Syslog Settings

Syslog Facility	Default	Syslog facility to use on logging messages
Syslog Priority	Default	Syslog priority level to use on logging messages

For example, if the computer attached to serial port 3 should never send anything out on its serial console port, the administrator can set the **Facility** for that port to local0 (local0 .. local7 are meant for site local values), and the **Priority** to critical. At this priority, if the console server syslog server does receive a message, it raises an alert. See Chapter 6.

3.1.8 NMEA Streaming

The ACM7000-L can provide GPS NMEA data streaming from the internal GPS /cellular modem. This data stream presents as a serial data stream on port 5 on the ACM models.

Serial & Network: Serial Port

Port #	Label	Mode	Logging Level	Parameters	Flow Control	
1	Port 1	Local Console Mode	0	115200-8-N-1	None	Edit
2	Port 2	Console (Unconfigured)	0	9600-8-N-1	None	Edit
3	Port 3	Console (Unconfigured)	0	9600-8-N-1	None	Edit
4	Port 4	Console (Unconfigured)	0	9600-8-N-1	None	Edit
5	Port 5	Cellular GPS NMEA Stream (USB)	0	9600-8-N-1	None	Edit

The Common Settings (baud rate etc.) are ignored when configuring the NMEA serial port. You can specify the **Fix Frequency** (i.e. this GPS fix rate determines how often GPS fixes are obtained). You can also apply all the Console Server Mode, Syslog and Serial Bridging settings to this port.

NMEA Streaming

NMEA Streaming
Enable GPS NMEA data streaming

Fix Frequency
The GPS fix rate, from 1-255 seconds
If changed, this field will not be applied until the device restarts, or NMEA streaming is disabled and re-enabled

You can use pmsheel, webshell, SSH, RFC2217 or RawTCP to get at the stream:

Manage: Devices

Type	Device	Actions
	Port 1	
	Port 2	
	Port 3	
	Port 4	
	Port 5	

For example, using the Web Terminal:

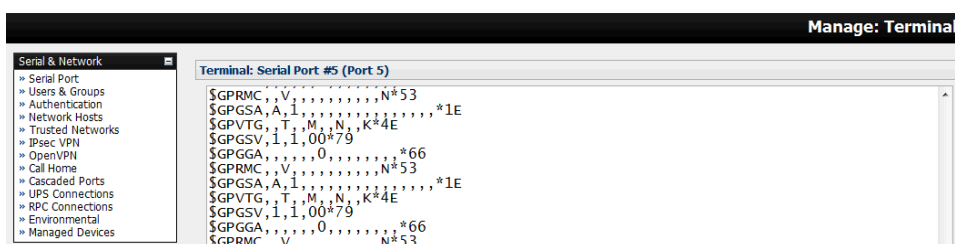

3.1.9 USB Consoles

Console servers with USB ports support USB console connections to devices from a wide range of vendors, including Cisco, HP, Dell and Brocade. These USB ports can also function as plain RS-232 serial ports when a USB-to-serial adapter is connected.

These USB ports are available as regular portmanager ports and are presented numerically in the web UI after all RJ45 serial ports.

The ACM7008-2 has eight RJ45 serial ports on the rear of the console server and four USB ports on the front. In **Serial & Network > Serial Port** these are listed as

Port #	Connector
1	RJ45
2	RJ45
3	RJ45
4	RJ45
5	RJ45
6	RJ45
7	RJ45
8	RJ45
9	USB
10	USB
11	USB
12	USB

If the particular ACM7008-2 is a cellular model, port #13 – for the GPS – will also be listed.

The 7216-24U has 16 RJ45 serial ports and 24 USB ports on its rear-face as well as two front-facing USB ports and (in the cellular model) a GPS.

The RJ45 serial ports are presented in **Serial & Network > Serial Port** as port numbers 1–16. The 24 rear-facing USB ports take port numbers 17–40, and the front-facing USB ports are listed at port numbers 41 and 42 respectively. And, as with the ACM7008-2, if the particular 7216-24U is a cellular model, the GPS is presented at port number 43.

The common settings (baud rate, etc.) are used when configuring the ports, but some operations may not work depending on the implementation of the underlying USB serial chip.

3.2 Add and Edit Users

The administrator uses this menu selection to create, edit and delete users and to define the access permissions for each of these users.

User Manual

Serial & Network: Users & Groups

Serial & Network

- Serial Port
- Users & Groups
- Authentication
- Network Hosts
- Trusted Networks
- IPsec VPN
- OpenVPN
- PPTP VPN
- Call Home
- Cascaded Ports
- UPS Connections
- RPC Connections
- Environmental
- Managed Devices

Alerts & Logging

System

Status

Manage

Groups

Name	Description
admin	Provides users with unlimited configuration and management privileges
pptpd	Group to allow access to the PPTP VPN server - Users in this group will have their password stored in clear text.
dialin	Group to allow dialin access via modems - Users in this group will have their password stored in clear text.
ftp	Group to allow ftp access and file access to storage devices
pmshell	Group to set default shell to pmshell
users	Provides users with basic management privileges

Users

Username	Group	Description			
root	<i>The root user has no editable groups</i>	Root User	Edit		Disable
ftpbrah	ftp		Edit	Delete	Disable

Users can be authorized to access specified services, serial ports, power devices and specified network-attached hosts. These users can also be given full administrator status (with full configuration and management and access privileges).

Users can be added to groups. Six groups are set up by default:

admin	Provides unlimited configuration and management privileges.
pptpd	Allows access to the PPTP VPN server. Users in this group have their password stored in clear text.
dialin	Allows dialin access via modems. Users in this group have their password stored in clear text.
ftp	Allows ftp access and file access to storage devices.
pmshell	Sets default shell to pmshell.
users	Provides users with basic management privileges.

The **admin** group provides members full administrator privileges. The admin user can access the console server using any of the services which have been enabled in **System > Services** They can also access any of the connected Hosts or serial port devices using any of the services that have been enabled for these connections. Only trusted users should have administrator access

The **user** group provides members with limited access to the console server and connected hosts and serial devices. These users can only access the Management section of the Management Console menu and they have no command line access to the console server. They can only access those Hosts and serial devices that have been checked for them, using services that have been enabled

Users in the **pptd**, **dialin**, **ftp** or **pmshell** groups have restricted user shell access to the nominated managed devices but they will not have any direct access to the console server. To add this the users must also be a member of the **users** or **admin** groups

The administrator can set up additional groups with specific power device, serial port and host access permissions. Users in these additional groups don't have any access to the Management Console menu nor do they have any command line access to the console server.

The administrator can set up users with specific power device, serial port and host access permissions who are not a member of any groups. These users don't have any access to the Management Console menu nor command line access to the console server.

For convenience, the SDT Connector **Retrieve Hosts** function retrieves and auto-configures checked serial ports and checked hosts only, even for **admin** group users.

3.2.1 Set up new group

To set up new groups and new users, and to classify users as members of particular groups:

1. Select **Serial & Network > Users & Groups** to display all groups and users
2. Click **Add Group** to add a new group

The screenshot shows the 'Serial & Network: Users & Groups' configuration page. The page is divided into several sections. On the left, there is a sidebar with navigation options: 'Manage', 'Status', 'Serial & Network', 'Alerts & Logging', and 'System'. The main content area is titled 'Serial & Network: Users & Groups' and contains a form for adding a new group. The form includes a 'Groups' field, a 'Description' field, and a 'Roles' section with several checkboxes for permissions. Below the roles section, there are sections for 'Accessible Host(s)', 'Accessible Port(s)', and 'Accessible RPC Outlet(s)'. The 'Accessible Host(s)' section has a checkbox for 'TrippLite (10.5.0.91)'. The 'Accessible Port(s)' section has checkboxes for 'Port 1 (Console Access)', 'Port 2 (catalystswitch)', 'Port 3 (test123)', 'Port 4', 'Rear USB A (Tripp Lite PDU)', 'Rear USB B', 'Rear USB C', and 'Rear USB D'. The 'Accessible RPC Outlet(s)' section has a message 'No RPCs currently configured.' and an 'Apply' button at the bottom.

3. Add a **Group** name and **Description** for each new group, and nominate the **Accessible Hosts**, **Accessible Ports** and **Accessible RPC Outlets** that users in this new group will be able to access
4. Click **Apply**
5. The administrator can **Edit** or **Delete** any added group

3.2.2 Set up new users

To set up new users, and to classify users as members of particular groups:

1. Select **Serial & Network > Users & Groups** to display all groups and users
2. Click **Add User**

The screenshot shows a web-based configuration interface for 'Serial & Network: Users & Groups'. The main window is titled 'Add a New user'. On the left, there is a navigation menu with categories: 'Manage', 'Status', 'Serial & Network', 'Alerts & Logging', and 'System'. The 'Serial & Network' menu is expanded, showing sub-items like 'Serial Port', 'Users & Groups', 'Authentication', 'Network Hosts', 'Trusted Hosts', 'IPsec VPN', 'OpenVPN', 'PPTP VPN', 'Call Home', 'Lighthouse', 'Cascaded Ports', 'UPS Connections', 'RPC Connections', 'Environmental', 'Managed Devices', and 'IP Passthrough'. The main form contains the following fields and options:

- Username:** A text input field with a placeholder 'A unique name for the user.'
- Description:** A text input field with a placeholder 'A brief description of the user's role.'
- Groups:** A list of checkboxes for selecting user groups:
 - admin (Provides users with unlimited configuration and management privileges)
 - pptpd (Group to allow access to the PPTP VPN server - Users in this group will have their password stored in clear text.)
 - dialin (Group to allow dialin access via modems - Users in this group will have their password stored in clear text.)
 - ftp (Group to allow ftp access and file access to storage devices)
 - pmshell (Group to set default shell to pmshell)
 - users (Provides users with basic management privileges)
 - pmpoperator (Group to allow access to all serial ports and managed devices, including portmanager shell access. Please note that portmanager shell access overrides UNIX shell access)
 - UtahAdmins (Admins for Utah Nodes)
 - pmadmin (Group to allow basic web access and administration of serial ports)
- Password:** A text input field with a placeholder 'The users authentication secret. Note: A password may not be required if remote authentication is being used.'
- Confirm:** A text input field with a placeholder 'Re-enter the users password for confirmation.'
- SSH Authorized Keys:** A section with a 'New SSH Key' button and a text area for pasting keys.
- Disable Password Authentication:** A checkbox with the label 'Check to only allow public key authentication for this user when using SSH'.
- Dial-in Options:** A section with:
 - Enable Dial-Back:** A checkbox with the label 'Allow an out-going connection to be triggered by logging into this port.'
 - Dial-Back Phone Number:** A text input field with a placeholder 'The phone number to call-back when user logs in.'
- Accessible Host(s):** A text input field at the bottom.

3. Add a **Username** for each new user. You may also include information related to the user (e.g. contact details) in the **Description** field. The user Name can contain from 1 to 127 alphanumeric characters and the characters "-", "_", and ".".
4. Specify which **Groups** you wish the user to be a member of
5. Add a confirmed **Password** for each new user. All characters are allowed.
6. SSH pass-key authentication can be used. Paste the public keys of authorized public/private keypairs for this user in the **Authorized SSH Keys** field
7. Check **Disable Password Authentication** to only allow public key authentication for this user when using SSH
8. Check **Enable Dial-Back** in the **Dial-in Options** menu to allow an out-going dial-back connection to be triggered by logging into this port. Enter the **Dial-Back Phone Number** with the phone number to call-back when user logs in
9. Check **Accessible Hosts** and/or **Accessible Ports** to nominate the serial ports and network connected hosts you wish the user to have access privileges to
10. If there are configured RPCs, check **Accessible RPC Outlets** to specify which outlets the user is able to control (i.e. Power On/Off)
11. Click **Apply**.

The new user will be able to access the accessible Network Devices, Ports and RPC Outlets. If the user is a group member, they can also access any other device/port/outlet accessible to the group

There are no limits on the number of users you can set up or the number of users per serial port or host. Multiple users can control/monitor the one port or host. There are no limits on the number of groups and each user can be a member of a number of groups. A user does not have to be a member of any groups, but if the user is a member of the default user group, they will not be able to use the Management Console to manage ports.

While there are no limits, the time to re-configure increases as the number and complexity increases. We recommend the aggregate number of users and groups be kept under 250.

The administrator can also edit the access settings for any existing users:

- Select **Serial & Network > Users & Groups** and click **Edit** to modify the user access privileges
- Click **Delete** to remove the user
- Click **Disable** to temporarily block access privileges

3.3 Authentication

See Chapter 8 for authentication configuration details.

3.4 Network Hosts

To monitor and remotely access a locally networked computer or device (referred to as a Host) you must identify the Host and specify the TCP or UDP ports/services used to control that Host:

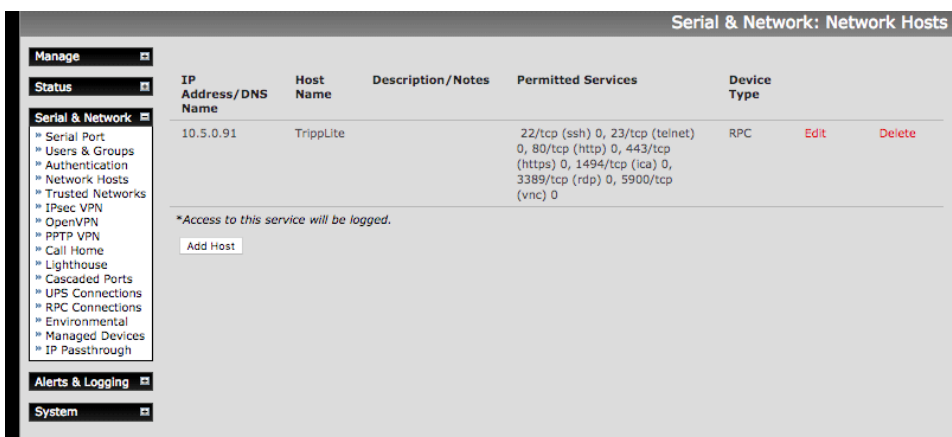

1. Selecting **Serial & Network > Network Hosts** presents all the network connected Hosts that have been enabled for access, and the related access TCP ports/services
2. Click **Add Host** to enable access to a new Host (or select **Edit** to update the settings for existing Host)

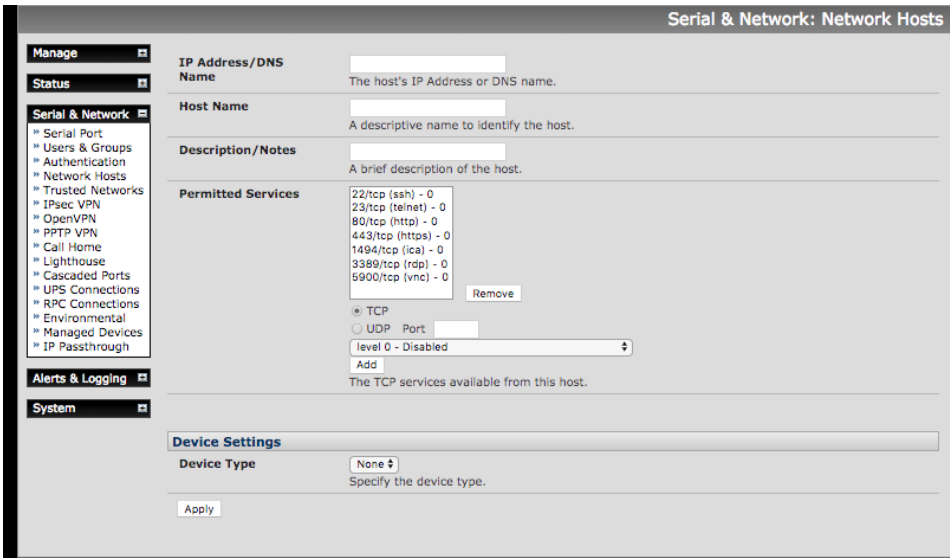

3. Enter the **IP Address** or **DNS Name** and a **Host Name** for the new network connected Host and optionally enter a **Description**.
4. Add or edit the **Permitted Services** (or TCP/UDP port numbers) that are authorized to be used in controlling this host. Only these permitted services are forwarded through by SDT to the Host. All other services (TCP/UDP ports) are blocked.
5. The **Logging Level** specifies the level of information to be logged and monitored for each Host access (See Chapter 6)
6. If the Host is a PDU or UPS power device or a server with IPMI power control, specify **RPC** (for IPMI and PDU) or **UPS** and the **Device Type**. The administrator can configure these devices and enable which users have permission to remotely cycle power, etc. See Chapter 7. Otherwise leave the Device Type set to None

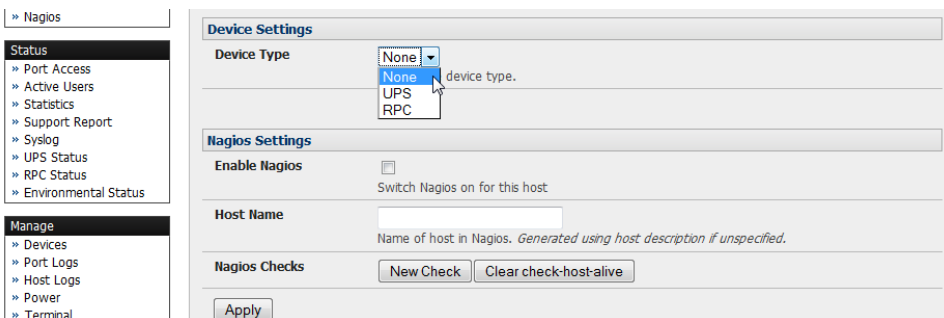

7. If the console server has been configured with distributed Nagios monitoring enabled, you will also see **Nagios Settings** options to enable nominated services on the Host to be monitored.
8. Click **Apply**. This creates the new Host and also create a new managed device with the same name.

3.5 Trusted Networks

The **Trusted Networks** facility gives you an option to nominate IP addresses that users must be located at, to have access to console server serial ports:



1. Select **Serial & Network > Trusted Networks**
2. To add a new trusted network, select **Add Rule**. In the absence of Rules, there are no access limitations as to the IP address at which users can be located.

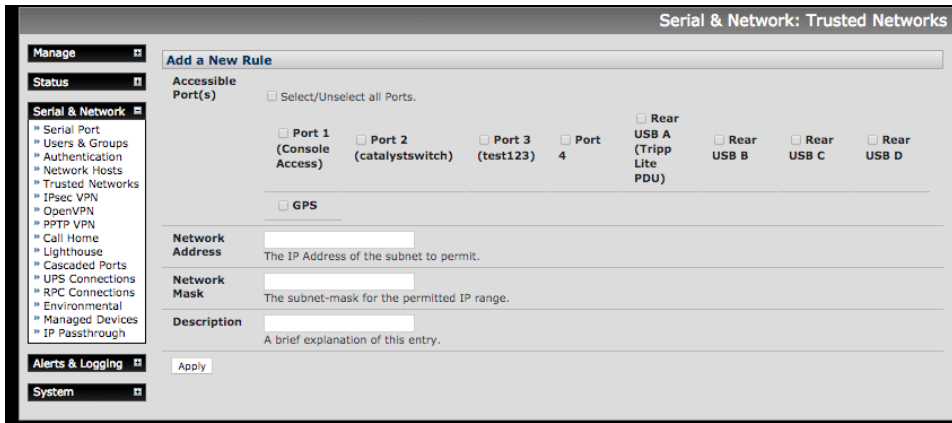

3. Select the **Accessible Ports** that the new rule is to be applied to
4. Enter the **Network Address** of the subnet to be permitted access
5. Specify the range of addresses that are to be permitted by entering a **Network Mask** for that permitted IP range e.g.

- To permit all the users located with a particular Class C network connection to the nominated port, add the following Trusted Network New Rule:

Network IP Address	204.15.5.0
Subnet Mask	255.255.255.0

- To permit only one user located at a specific IP address to connect:

Network IP Address	204.15.5.13
Subnet Mask	255.255.255.255

- To allow all the users operating from within a specific range of IP addresses (say any of the thirty addresses from 204.15.5.129 to 204.15.5.158) to be permitted connection to the nominated port:

Host /Subnet Address	204.15.5.128
Subnet Mask	255.255.255.224

6. Click **Apply**

3.6 Serial Port Cascading

Cascaded Ports enables you to cluster distributed console servers so a large number of serial ports (up to 1000) can be configured and accessed through one IP address and managed through the one Management Console. One console server, the Master, controls other console servers as Slave units and all the serial ports on the Slave units appear as if they are part of the Master.

Opengear's clustering connects each Slave to the Master with an SSH connection. This is done using public key authentication, so the Master can access each Slave using the SSH key pair (rather than using passwords). This ensures secure authenticated communications between Master and Slaves enabling the Slave console server units to be distributed locally on a LAN or remotely around the world.

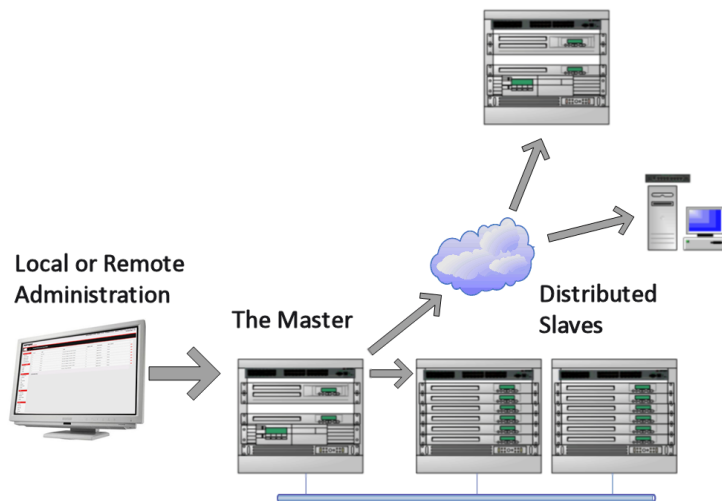

3.6.1 Automatically generate and upload SSH keys

To set up public key authentication you must first generate an RSA or DSA key pair and upload them into the Master and Slave console servers. This can be done automatically from the Master:

System Name	<input type="text" value="img4004-5"/> <small>An ID for this device.</small>
System Description	<input type="text"/> <small>The physical location of this device.</small>
System Password	<input type="password" value="••••••"/> <small>The secret used to gain administration access to this device.</small>
Confirm System Password	<input type="password" value="••••••"/> <small>Re-enter the above password for confirmation.</small>
<input type="button" value="Apply"/>	
SSH RSA Public Key	<input type="text"/> <input type="button" value="Browse..."/> <small>Upload a replacement RSA public key file.</small>
SSH RSA Private Key	<input type="text"/> <input type="button" value="Browse..."/> <small>Upload a replacement RSA private key file.</small>
SSH DSA Public Key	<input type="text"/> <input type="button" value="Browse..."/> <small>Upload a replacement DSA public key file.</small>
SSH DSA Private Key	<input type="text"/> <input type="button" value="Browse..."/> <small>Upload a replacement DSA private key file.</small>
SSH Authorized Keys	<input type="text"/> <input type="button" value="Browse..."/> <small>Upload a replacement authorized keys file.</small>
Generate SSH keys automatically	<input checked="" type="checkbox"/> <small>Generate SSH keys locally.</small>
<input type="button" value="Apply"/>	

1. Select **System > Administration** on Master's Management Console
2. Check **Generate SSH keys automatically**.
3. Click **Apply**

System: SSH Keys

Manage	Generating each set of keys will require approximately two minutes. Any old keys of that type will be destroyed. Functions relying on SSH keys (e.g. Cascading) may stop functioning until they are updated with the new set of keys. If unsure, select only RSA.						
Status	To generate keys, select one or more of the following key types:						
Serial & Network	<table style="width: 100%; border-collapse: collapse;"> <tr> <td style="width: 30%;">RSA Keys</td> <td><input checked="" type="checkbox"/> Generate RSA Keys</td> </tr> <tr> <td>ECDSA Keys</td> <td><input checked="" type="checkbox"/> Generate ECDSA Keys</td> </tr> <tr> <td>ED25519 Keys</td> <td><input checked="" type="checkbox"/> Generate ED25519 Keys</td> </tr> </table>	RSA Keys	<input checked="" type="checkbox"/> Generate RSA Keys	ECDSA Keys	<input checked="" type="checkbox"/> Generate ECDSA Keys	ED25519 Keys	<input checked="" type="checkbox"/> Generate ED25519 Keys
RSA Keys	<input checked="" type="checkbox"/> Generate RSA Keys						
ECDSA Keys	<input checked="" type="checkbox"/> Generate ECDSA Keys						
ED25519 Keys	<input checked="" type="checkbox"/> Generate ED25519 Keys						
Alerts & Logging							
System	<input type="button" value="Apply"/>						

Next you must select whether to generate keys using RSA and/or DSA (if unsure, select only RSA). Generating each set of keys require two minutes and the new keys destroy old keys of that type. While the new generation is underway, functions relying on SSH keys (e.g. cascading) may stop functioning until they are updated with the new set of keys. To generate keys:

1. Check boxes for the keys you wish to generate.
2. Click **Apply**

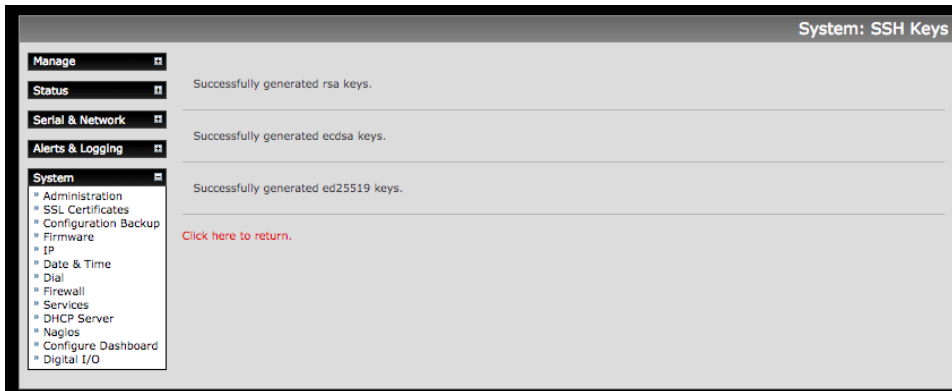

3. Once the new keys have been generated, click the link **Click here to return**. The keys are uploaded to the Master and connected Slaves.

3.6.2 Manually generate and upload SSH keys

Alternately if you have an RSA or DSA key pair you can upload them to the Master and Slave console servers.

To upload the key public and private key pair to the Master console server:

1. Select **System > Administration** on the Master's Management Console
2. Browse to the location you have stored RSA (or DSA) Public Key and upload it to **SSH RSA (DSA) Public Key**
3. Browse to the stored RSA (or DSA) Private Key and upload it to **SSH RSA (DSA) Private Key**
4. Click **Apply**

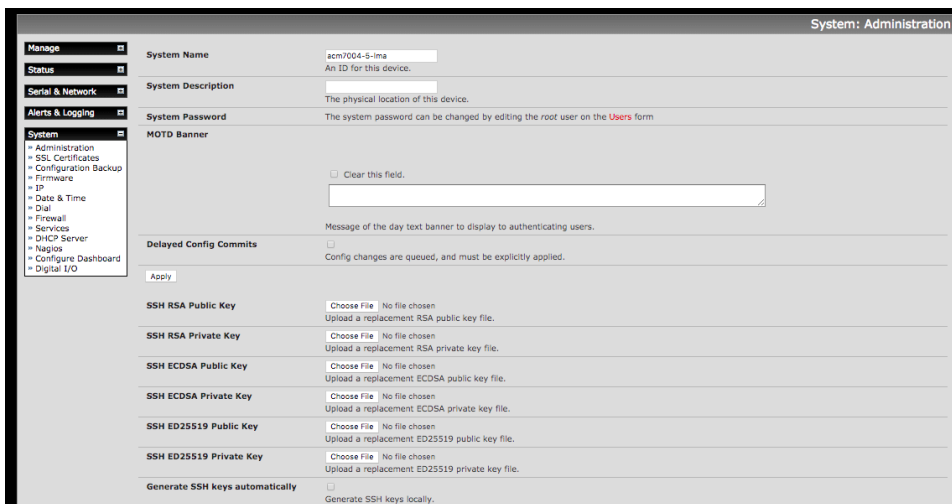

Next, you must register the Public Key as an Authorized Key on the Slave. In the case of one Master with multiple Slaves, you upload one RSA or DSA public key for each Slave.

1. Select **System > Administration** on the Slave's Management Console
2. Browse to the stored RSA (or DSA) Public Key and upload it to Slave's **SSH Authorized Key**

3. Click **Apply**

The next step is to Fingerprint each new Slave-Master connection. This step validates that you are establishing an SSH session to who you think you are. On the first connection the Slave receives a fingerprint from the Master used on all future connections:

To establish the fingerprint first log in the Master server as root and establish an SSH connection to the Slave remote host:

```
# ssh remhost
```

Once the SSH connection has been established, you are asked to accept the key. Answer **yes** and the fingerprint is added to the list of known hosts.

If you are asked to supply a password, there was problem uploading keys.

3.6.3 Configure the slaves and their serial ports

Begin setting up the Slaves and configuring Slave serial ports from the Master console server:

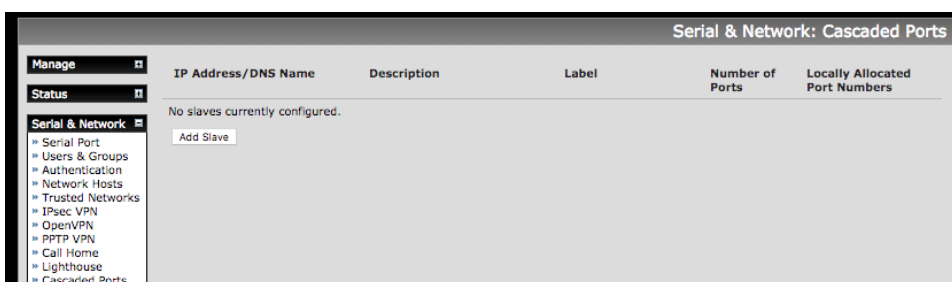

1. Select **Serial & Network > Cascaded Ports** on the Master's Management Console:
2. To add clustering support, select **Add Slave**

You can't add Slaves until you have generated SSH keys. To define and configure a Slave:

1. Enter the remote **IP Address** or DNS Name for the Slave console server
2. Enter a brief **Description** and a short **Label** for the Slave
3. Enter the full number of serial ports on the Slave unit in **Number of Ports**
4. Click **Apply**. This establishes the SSH tunnel between the Master and the new Slave

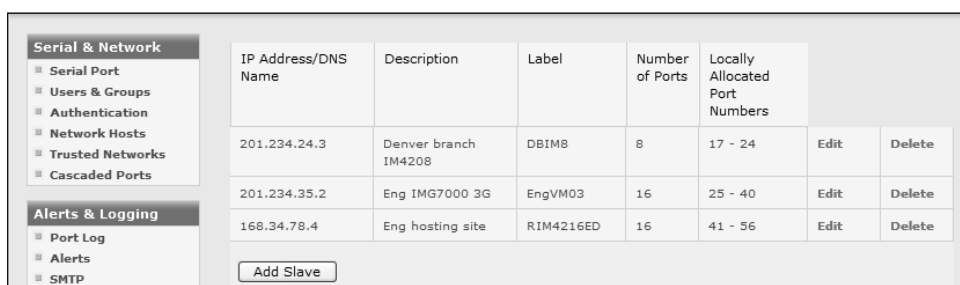

The **Serial & Network > Cascaded Ports** menu displays all the Slaves and the port numbers that have been allocated on the Master. If the Master console server has 16 ports of its own, ports 1-16 are pre-allocated to the Master, so the first Slave added is assigned port number 17 onwards.

Once you have added all the Slave console servers, the Slave serial ports and the connected devices are configurable and accessible from the Master's Management Console menu and accessible through the Master's IP address.

1. Select the appropriate **Serial & Network > Serial Port** and **Edit** to configure the serial ports on the Slave
2. Select the appropriate **Serial & Network > Users & Groups** to add new users with access privileges to the Slave serial ports (or to extend existing users access privileges)
3. Select the appropriate **Serial & Network > Trusted Networks** to specify network addresses that can access nominated Slave serial ports
4. Select the appropriate **Alerts & Logging > Alerts** to configure Slave port Connection, State Change or Pattern Match alerts
5. The configuration changes made on the Master are propagated out to all the Slaves when you click **Apply**.

3.6.4 Managing slaves

The Master is in control of the Slave serial ports. For example, if change a user access privileges or edit any serial port setting on the Master, the updated configuration files are sent out to each Slave in parallel. Each Slave makes changes to their local configurations (and only makes changes that relate to its particular serial ports).

You can use the local Slave Management Console to change the settings on any Slave serial port (such as alter the baud rates). These changes are overwritten next time the Master sends out a configuration file update.

While the Master is in control of all Slave serial port related functions, it is not master over the Slave network host connections or over the Slave console server system.

Slave functions such as IP, SMTP & SNMP Settings, Date & Time, DHCP server must be managed by accessing each Slave directly and these functions are not over written when configuration changes are propagated from the Master. The Slaves Network Host and IPMI settings have to be configured at each Slave.

The Master's Management Console provides a consolidated view of the settings for its own and the entire Slave's serial ports. The Master does not provide a fully consolidated view. For example, if you want to find out who is logged in to cascaded serial ports from the master, you'll see that **Status > Active Users** only displays those users active on the Master's ports, so you may need to write custom scripts to provide this view.

3.7 Serial Port Redirection (PortShare)

Opengear's Port Share software delivers the virtual serial port technology your Windows and Linux applications need to open remote serial ports and read the data from serial devices that are connected to your console server.

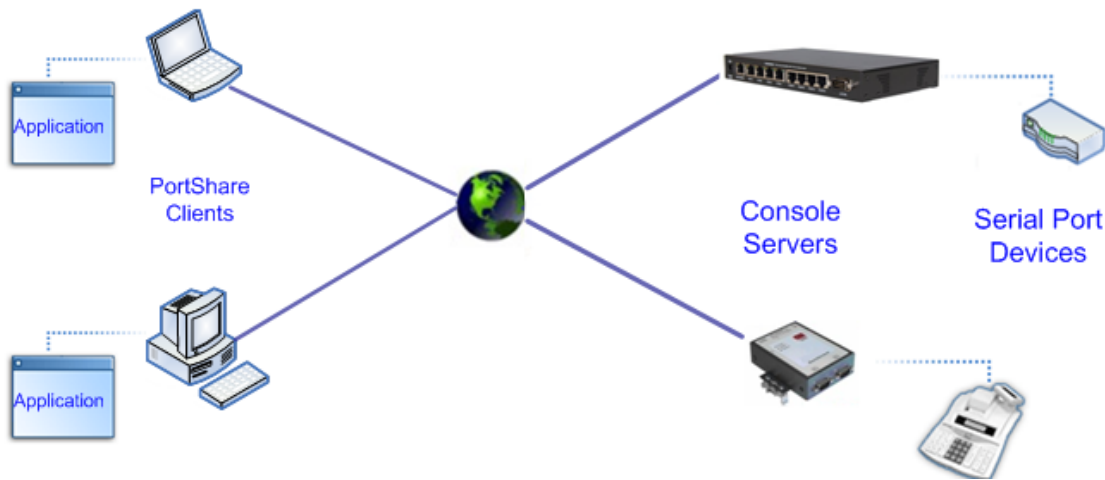

PortShare is supplied free with each console server and you are licensed to install *PortShare* on one or more computers for accessing any serial device connected to a console server port.

PortShare for Windows

The *portshare_setup.exe* can be downloaded from the ftp site. See the *PortShare User Manual* and *Quick Start* for details on installation and operation.

PortShare for Linux

The *PortShare* driver for Linux maps the console server serial port to a host *tty* port. OpenGear has released the *portshare-serial-client* as an open source utility for Linux, AIX, HPUX, SCO, Solaris and UnixWare. This utility can be downloaded from the ftp site.

This *PortShare* serial port redirector allows you to use a serial device connected to the remote console server as if it were connected to your local serial port. The *portshare-serial-client* creates a pseudo *tty* port, connects the serial application to the pseudo *tty* port, receives data from the pseudo *tty* port, transmits it to the console server through network and receives data from the console server through network and transmits it to the pseudo-*tty* port.

The *.tar* file can be downloaded from the ftp site. See the *PortShare User Manual* and *Quick Start* for details on installation and operation.

3.8 Managed Devices

The **Managed Devices** page presents a consolidated view of all the connections to a device that can be accessed and monitored through the console server. To view the connections to the devices, select **Serial & Network > Managed Devices**

User Manual

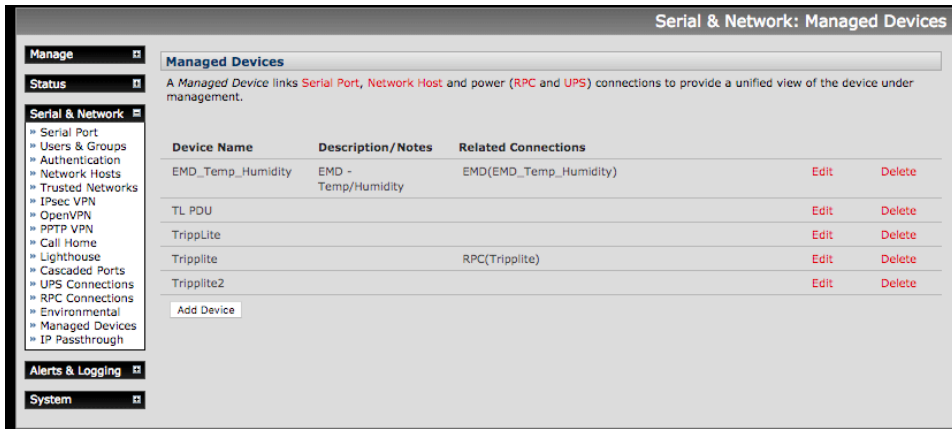

This screen displays all the managed devices with their Description/Notes and lists of all the configured Connections:

- Serial Port # (if serially connected) or
- USB (if USB connected)
- IP Address (if network connected)
- Power PDU/outlet details (if applicable) and any UPS connections

Devices such as servers may have more than one power connection (e.g. dual power supplied) and more than one network connection (e.g. for BMC/service processor).

All users can view these managed device connections by selecting **Manage > Devices**. Administrators can also edit and add/delete these managed devices and their connections.

To edit an existing device and add a new connection:

1. Select **Edit** on the **Serial & Network > Managed Devices** and click **Add Connection**
2. Select the connection type for the new connection (Serial, Network Host, UPS or RPC) and select the connection from the presented list of configured unallocated hosts/ports/outlets

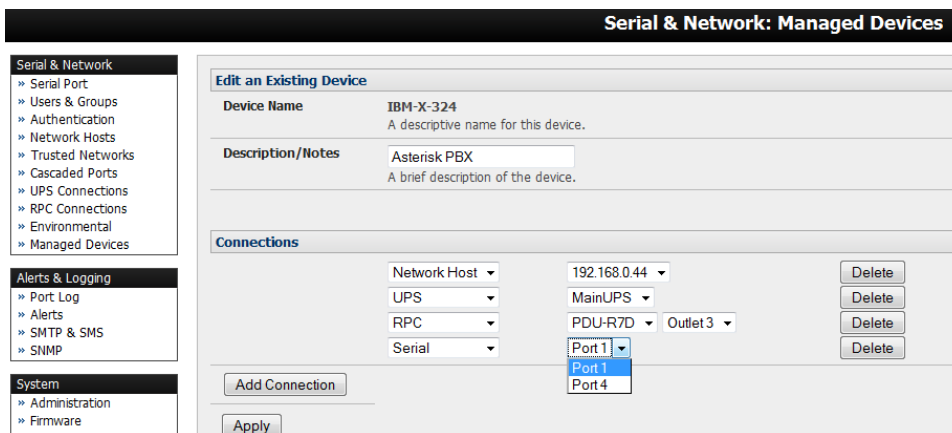

To add a new network connected managed device:

1. The Administrator adds a new network connected managed device using **Add Host** on the **Serial & Network > Network Host** menu. This automatically creates a corresponding new managed device.

2. When adding a new network connected RPC or UPS power device, you set up a Network Host, designate it as RPC or UPS. Go to **RPC Connections** or **UPS Connections** to configure the relevant connection. Corresponding new managed device with the same Name /Description as the RPC/UPS Host is not created until this connection step is completed.

NOTE The outlet names on the newly created PDU are *Outlet 1* and *Outlet 2*. When you connect a particular managed device that draws power from the outlet, the outlet takes the name of the powered managed device.

To add a new serially connected managed device:

1. Configure the serial port using the **Serial & Network > Serial Port** menu (See *Section 3.1 - Configure Serial Port*)
2. Select **Serial & Network > Managed Devices** and click **Add Device**
3. Enter a **Device Name** and **Description** for the managed device

The screenshot shows the 'Serial & Network: Managed Devices' configuration page. The left sidebar contains a navigation menu with 'Serial & Network' expanded, showing options like 'Serial Port', 'Users & Groups', 'Authentication', 'Network Hosts', 'Trusted Networks', 'Cascaded Ports', 'UPS Connections', 'RPC Connections', 'Environmental', and 'Managed Devices'. Below that is 'Alerts & Logging' with options like 'Port Log', 'Alerts', 'SMTP & SMS', and 'SNMP'. The main content area is titled 'Add a New Device'. It has a 'Device Name' field with 'Router' and a 'Description/Notes' field with 'Cisco 3640 serial console'. Below is a 'Connections' section with a dropdown menu set to 'Serial', a 'Port2' dropdown, and a 'Delete' button. There are 'Add Connection' and 'Apply' buttons at the bottom left of the form.

4. Click **Add Connection** and select **Serial** and the **Port** that connects to the managed device
5. To add a UPS/RPC power connection or network connection or another serial connection click **Add Connection**
6. Click **Apply**

NOTE To set up a serially connected RPC UPS or EMD device, configure the serial port, designate it as a Device, and enter a Name and Description for that device in the **Serial & Network > RPC Connections** (or **UPS Connections** or **Environmental**). This creates a corresponding new managed device with the same Name /Description as the RPC/UPS Host. The outlet names on this newly created PDU are *Outlet 1* and *Outlet 2*. When you connect a managed device that draws power from the outlet, the outlet takes the name of the powered managed Device.

3.9 IPsec VPN

The ACM7000, CM7100, and IM7200 include Openswan, a Linux implementation of the IPsec (IP Security) protocols, which can be used to configure a Virtual Private Network (VPN). The VPN allows multiple sites or remote administrators to access the console server and managed devices securely over the Internet.

The administrator can establish encrypted authenticated VPN connections between console servers distributed at remote sites and a VPN gateway (such as Cisco router running IOS IPsec) on their central office network:

User Manual

- Users at the central office can securely access the remote console servers and connected serial console devices and machines on the Management LAN subnet at the remote location as though they were local
- All these remote console servers can be monitored with a CMS6000 on the central network
- With serial bridging, serial data from controller at the central office machine can be securely connected to the serially controlled devices at the remote sites

The road warrior administrator can use a VPN IPsec software client to remotely access the console server and every machine on the Management LAN subnet at the remote location

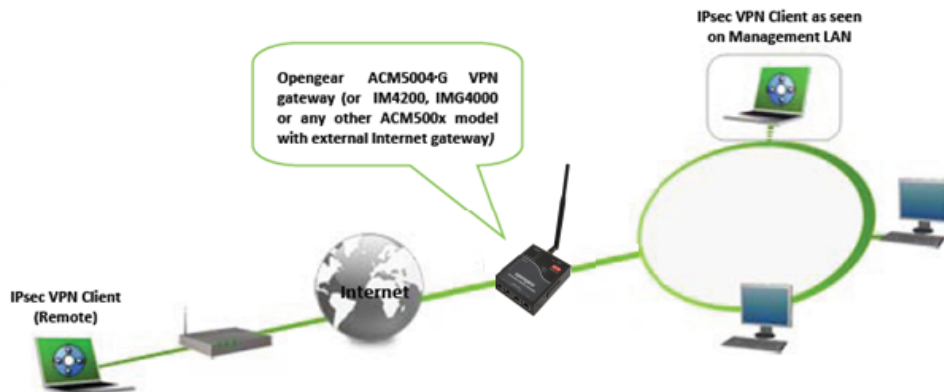

Configuration of IPsec is quite complex so Opengear provides a GUI interface for basic set up as described below.

To enable the VPN gateway:

1. Select **IPsec VPN** on the **Serial & Networks** menu



2. Click **Add** and complete the **Add IPsec Tunnel** screen
3. Enter any descriptive name you wish to identify the IPsec Tunnel you are adding such as WestStOutlet-VPN

Add IPsec Tunnel

Tunnel Name
A descriptive name for the IPsec tunnel

Initiate Tunnel
Initiate the tunnel connection from this end

Security

Authentication Method
 RSA digital signatures
 Shared secret (PSK)
Authenticate using RSA digital signatures or a shared secret (PSK)

Shared Secret (PSK) (Currently empty)

A passphrase, must match the passphrase configured at the other end of the tunnel

Authentication Protocol
 ESP
 AH
Authenticate as part of ESP encryption or separately using the AH protocol

Aggressive Mode
Use IKE aggressive mode to establish the tunnel, leave unchecked to use IKE main mode

IKE Proposal (Phase 1)
Algorithm to establish the tunnel, must be specified when using aggressive mode, in the format cipher-hash-pfsgroup

Perfect Forward Secrecy
Require perfect forward secrecy of keys

Left ID
The identifier for this end of the tunnel, should include a fully qualified domain name preceded by @, e.g. left@example.com

Right ID
The identifier for the other end of the tunnel, should include a fully qualified domain name preceded by @, e.g. right@example.com

Left Address
The public IP or DNS address of this end of the tunnel, leave blank to use the interface of the default route

4. Select the **Authentication Method** to be used, either RSA digital signatures or a Shared secret (PSK)
 - If you select RSA you are asked to **click here to generate keys**. This generates an RSA public key for the console server (the Left Public Key). Locate the key to be used on the remote gateway, cut and paste it into the Right Public Key

Serial & Network: IPsec VPN

Serial & Network

- » Serial Port
- » Users & Groups
- » Authentication
- » Network Hosts
- » Trusted Networks
- » IPsec VPN
- » Cascaded Ports
- » UPS Connections
- » RPC Connections
- » Environmental
- » Managed Devices

Alerts & Logging

- » Port Log
- » Alerts
- » SMTP & SMS

Add IPsec Tunnel

Tunnel Name
A descriptive name for the IPsec tunnel

Authentication Method
 RSA digital signatures
 Shared secret (PSK)
Authenticate using RSA digital signatures or a shared secret (PSK)

Left Public Key
Generated RSA public key of this end of the tunnel

Right Public Key
RSA public key of the other end of the tunnel

- If you select Shared secret, enter a Pre-shared secret (PSK). The PSK must match the PSK configured at the other end of the tunnel

5. In **Authentication Protocol** select the authentication protocol to be used. Either authenticate as part of **ESP** (Encapsulating Security Payload) encryption or separately using the **AH** (Authentication Header) protocol.

6. Enter a **Left ID** and **Right ID**. This is the identifier that the Local host/gateway and remote host/gateway use for IPsec negotiation and authentication. Each ID must include an @ and can include a fully qualified domain name (e.g. left@example.com)
7. Enter the public IP or DNS address of this Opengear VPN gateway as the **Left Address**. You can leave this blank to use the interface of the default route
8. In **Right Address** enter the public IP or DNS address of the remote end of the tunnel (only if the remote end has a static or dyndns address). Otherwise leave this blank
9. If the Opengear VPN gateway is serving as a VPN gateway to a local subnet (e.g. the console server has a Management LAN configured) enter the private subnet details in **Left Subnet**. Use the CIDR notation (where the IP address number is followed by a slash and the number of 'one' bits in the binary notation of the netmask). For example, 192.168.0.0/24 indicates an IP address where the first 24 bits are used as the network address. This is the same as 255.255.255.0. If the VPN access is only to the console server and to its attached serial console devices, leave **Left Subnet** blank
10. If there is a VPN gateway at the remote end, enter the private subnet details in **Right Subnet**. Use the CIDR notation and leave blank if there is only a remote host
11. Select **Initiate Tunnel** if the tunnel connection is to be initiated from the Left console server end. This can only be initiated from the VPN gateway (Left) if the remote end is configured with a static (or dyndns) IP address
12. Click **Apply** to save changes

NOTE Configuration details set up on the console server (referred to as the Left or Local host) must match the set up entered when configuring the Remote (Right) host/gateway or software client. See <http://www.opengear.com/faq.html> for details on configuring these remote ends

3.10 OpenVPN

The ACM7000, CM7100, and IM7200 with firmware V3.2 and later include OpenVPN. OpenVPN uses the OpenSSL library for encryption, authentication, and certification, which means it uses SSL/TSL (Secure Socket Layer/Transport Layer Security) for key exchange and can encrypt both data and control channels. Using OpenVPN allows for the building of cross-platform, point-to-point VPNs using either X.509 PKI (Public Key Infrastructure) or custom configuration files.

OpenVPN allows secure tunneling of data through a single TCP/UDP port over an unsecured network, thus providing secure access to multiple sites and secure remote administration to a console server over the Internet.

OpenVPN also allows the use of Dynamic IP addresses by both the server and client thus providing client mobility. For example, an OpenVPN tunnel may be established between a roaming windows client and an Opengear console server within a data center.

Configuration of OpenVPN can be complex so Opengear provides a GUI interface for basic set up as described below. More detailed information is available at <http://www.openvpn.net>

3.10.1 Enable the OpenVPN

1. Select **OpenVPN** on the **Serial & Networks** menu

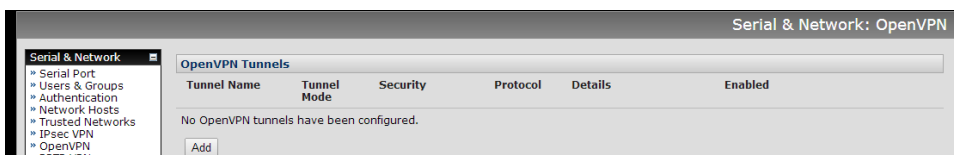

2. Click **Add** and complete the **Add OpenVPN Tunnel** screen
3. Enter any descriptive name you wish to identify the OpenVPN Tunnel you are adding, for example NorthStOutlet-VPN

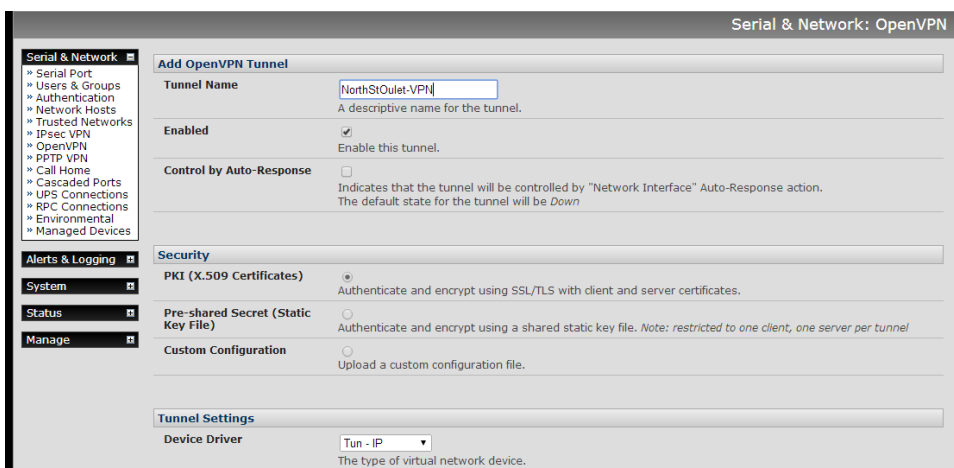

4. Select the authentication method to be used. To authenticate using certificates select **PKI (X.509 Certificates)** or select **Custom Configuration** to upload custom configuration files. Custom configurations must be stored in /etc/config.

NOTE If you select PKI, establish:

- Separate certificate (also known as a public key). This Certificate File is a *.crt file type
- Private Key for the server and each client. This Private Key File is a *.key file type
- Master Certificate Authority (CA) certificate and key which is used to sign each of the server and client certificates. This Root CA Certificate is a *.crt file type

For a server, you may also need dh1024.pem (Diffie Hellman parameters). See <http://openvpn.net/easyrsa.html> for a guide to basic RSA key management. For alternative authentication methods see <http://openvpn.net/index.php/documentation/howto.html#auth>.

5. Select the **Device Driver** to be used, either **Tun-IP** or **Tap-Ethernet**. The TUN (network tunnel) and TAP (network tap) drivers are virtual network drivers that support IP tunneling and Ethernet tunneling, respectively. TUN and TAP are part of the Linux kernel.
6. Select either **UDP** or **TCP** as the **Protocol**. UDP is the default and preferred protocol for OpenVPN.
7. Check or uncheck the **Compression** button to enable or disable compression.
8. In **Tunnel Mode**, nominate whether this is the **Client** or **Server** end of the tunnel. When running as a server, the console server supports multiple clients connecting to the VPN server over the same port.

3.10.2 Configure as Server or Client

Client Details	
Primary Server Address	<input type="text" value="192.168.250.106"/> The address of the first server.
Primary Server Port	<input type="text"/> The TCP/IP port of the first server. <i>Default is 1194.</i>
Secondary Server Address	<input type="text"/> The address of the second server (Optional).
Secondary Server Port	<input type="text"/>

1. Complete the **Client Details** or **Server Details** depending on the Tunnel Mode selected.
 - If Client has been selected, the Primary Server Address is the address of the OpenVPN Server.
 - If Server has been selected, enter the IP Pool Network address and the IP Pool Network mask for the IP Pool. The network defined by the IP Pool Network address/mask is used to provide the addresses for connecting clients.
2. Click **Apply** to save changes

Add OpenVPN Tunnel	
Tunnel Name	<input type="text" value="SouthStOutlet-VPN"/> A descriptive name for the OpenVPN tunnel
Device Driver	<input type="text" value="Tun - IP"/> <input type="button" value="v"/> Select the tap or tun driver to use.
Protocol	<input type="text" value="UDP"/> <input type="button" value="v"/> Use a UDP or TCP protocol
Tunnel Mode	<input type="text" value="Server"/> <input type="button" value="v"/> Is this the Client or Server end of the tunnel.
Configuration Method	<input type="text" value="PKI (X.509 Certificates)"/> <input type="button" value="v"/> Authenticate using certificates or use a custom configuration
Compression	<input checked="" type="checkbox"/> Enable or disable compression
Server Details	
Local Port	<input type="text"/> The TCP/IP port to listen on. <i>Default is 1194.</i>
IP Pool Network	<input type="text" value="10.100.0.0"/> Network addresses to allocate.
IP Pool Netmask	<input type="text" value="255.255.255.0"/> Network mask for IP Pool.
<input type="button" value="Apply"/>	

- To enter authentication certificates and files, select the **Manage OpenVPN Files** tab. Upload or browse to relevant authentication certificates and files.

Manage OpenVPN Files

Configuration File	<input type="text"/>	<input type="button" value="Browse..."/>	File is not custom	NorthStOutlet-VPN.conf
Root CA Certificate	<input type="text" value="ear\Testing\Certificates\ca.crt"/>	<input type="button" value="Browse..."/>	<input type="button" value="Upload"/>	No file available
Certificate File	<input type="text" value="ing\Certificates\acm-client.crt"/>	<input type="button" value="Browse..."/>	<input type="button" value="Upload"/>	No file available
Private Key File	<input type="text" value="g\Certificates\acm-client.key"/>	<input type="button" value="Browse..."/>	<input type="button" value="Upload"/>	No file available
Diffie-Hellman File	<input type="text"/>	<input type="button" value="Browse..."/>	<input type="button" value="Upload"/>	No file available

- Apply** to save changes. Saved files are displayed in red on the right-hand side of the Upload button.

Manage OpenVPN Files

Configuration File	<input type="text"/>	<input type="button" value="Browse..."/>	File is not custom	NorthStOutlet-VPN.conf
Root CA Certificate	<input type="text"/>	<input type="button" value="Browse..."/>	<input type="button" value="Upload"/>	NorthStOutlet-VPN-ca.crt
Certificate File	<input type="text"/>	<input type="button" value="Browse..."/>	<input type="button" value="Upload"/>	NorthStOutlet-VPN-public.crt
Private Key File	<input type="text"/>	<input type="button" value="Browse..."/>	<input type="button" value="Upload"/>	NorthStOutlet-VPN-private.key
Diffie-Hellman File	<input type="text"/>	<input type="button" value="Browse..."/>	<input type="button" value="Upload"/>	No file available

- To enable OpenVPN, **Edit** the OpenVPN tunnel

OpenVPN Tunnels						
Tunnel Name	Tunnel Mode	Configuration Method	Protocol	Details	Enabled	
NorthStOutlet-VPN	Client	PKI (X.509)	udp	Server(s): 192.168.250.106:1194	N	Edit Delete

User Manual

6. Check the **Enabled** button.
7. **Apply** to save changes

NOTE Make sure that the console server system time is correct when working with OpenVPN to avoid authentication issues.

Edit OpenVPN Tunnel Details

Edit OpenVPN Tunnel Details

Tunnel Name	NorthStOutlet-VPN A descriptive name for the OpenVPN tunnel
Enabled	<input checked="" type="checkbox"/> Enable or disable the tunnel
Device Driver	Tun - IP Select the tap or tun driver to use.
Protocol	UDP Use a UDP or TCP protocol
Tunnel Mode	Client Is this the Client or Server end of the tunnel.
Configuration Method	PKI (X.509 Certificates) Authenticate using certificates or use a custom configuration
Compression	<input checked="" type="checkbox"/> Enable or disable compression

8. Select **Statistics** on the **Status** menu to verify that the tunnel is operational.

Interfaces	Routes	Serial Ports	IP	ICMP	TCP
eth0			Link encap:Ethernet HWaddr 00:10:A1:96:92:05 inet addr:192.168.0.1 Bcast:192.168.0.255 Mask:255.255.255.0 inet6 addr: fe80::210:a1ff:fe96:9205/64 Scope:Link UP BROADCAST RUNNING MULTICAST MTU:1500 Metric:1 RX packets:2616 errors:0 dropped:0 overruns:0 frame:0 TX packets:1565 errors:0 dropped:0 overruns:0 carrier:0 collisions:0 txqueuelen:1000 Interrupt:12 Memory:1fff8000-1fff80ff		
eth0:0			Link encap:Ethernet HWaddr 00:10:A1:96:92:05 inet addr:192.168.250.111 Bcast:192.168.250.255 Mask:255.255.255.0 UP BROADCAST RUNNING MULTICAST MTU:1500 Metric:1 Interrupt:12 Memory:1fff8000-1fff80ff		
lo			Link encap:Local Loopback inet addr:127.0.0.1 Mask:255.0.0.0 inet6 addr: ::1/128 Scope:Host UP LOOPBACK RUNNING MTU:16436 Metric:1 RX packets:975 errors:0 dropped:0 overruns:0 frame:0 TX packets:975 errors:0 dropped:0 overruns:0 carrier:0 collisions:0 txqueuelen:0		
tun0			Link encap:UNSPEC HWaddr 00-00-00-00-00-00-00-00-00-00-00-00-00-00-00-00 inet addr:10.100.0.6 P-t-P:10.100.0.5 Mask:255.255.255.255 UP POINTOPOINT RUNNING NOARP MULTICAST MTU:1500 Metric:1 RX packets:0 errors:0 dropped:0 overruns:0 frame:0 TX packets:0 errors:0 dropped:0 overruns:0 carrier:0 collisions:0 txqueuelen:100		

3.10.3 Windows OpenVPN Client and Server set up

This section outlines the installation and configuration of a Windows OpenVPN client or a Windows OpenVPN server and setting up a VPN connection to a console server.

Console servers generate Windows client config automatically from the GUI – for **Pre-shared Secret (Static Key File)** configurations.

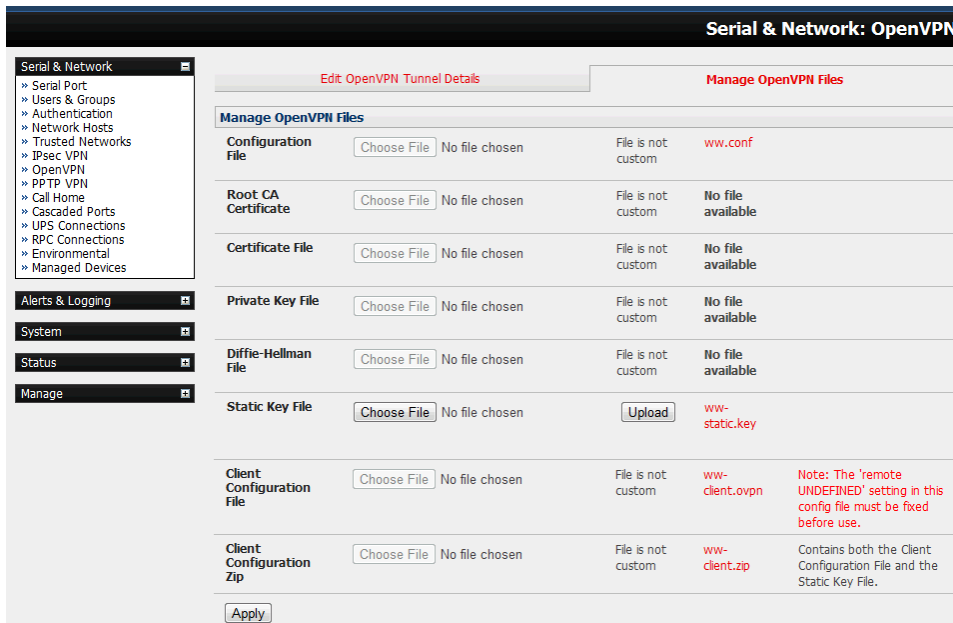

Alternately OpenVPN GUI for Windows software (which includes the standard OpenVPN package plus a Windows GUI) can be downloaded from <http://openvpn.net>.

Once installed on the Windows machine, an OpenVPN icon is added to the Notification Area located in the right side of the taskbar. Right click on this icon to start and stop VPN connections, edit configurations, and view logs.

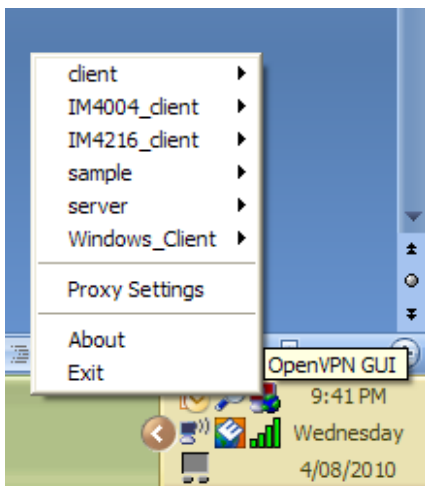

When the OpenVPN software begins running, the C:\Program Files\OpenVPN\config folder is scanned for .opvn files. This folder is rechecked for new configuration files whenever the OpenVPN GUI icon is right-clicked. Once OpenVPN is installed, create a configuration file:

User Manual

Using a text editor, create an xxxx.ovpn file and save in C:\Program Files\OpenVPN\config. For example, C:\Program Files\OpenVPN\config\client.ovpn

An example of an OpenVPN Windows client configuration file is shown below:

```
# description: IM4216_client
client
proto udp
verb 3
dev tun
remote 192.168.250.152
port 1194
ca c:\openvpnkeys\ca.crt
cert c:\openvpnkeys\client.crt
key c:\openvpnkeys\client.key
nobind
persist-key
persist-tun
comp-lzo
```

An example of an OpenVPN Windows Server configuration file is shown below:

```
server 10.100.10.0 255.255.255.0
port 1194
keepalive 10 120
proto udp
mssfix 1400
persist-key
persist-tun
dev tun
ca c:\openvpnkeys\ca.crt
cert c:\openvpnkeys\server.crt
key c:\openvpnkeys\server.key
dh c:\openvpnkeys\dh.pem
comp-lzo
verb 1
syslog IM4216_OpenVPN_Server
```

The Windows client/server configuration file options are:

Options	Description
#description:	This is a comment describing the configuration. Comment lines start with '#' and are ignored by OpenVPN.
Client server	Specify whether this will be a client or server configuration file. In the server configuration file, define the IP address pool and netmask. For example, server 10.100.10.0 255.255.255.0
proto udp proto tcp	Set the protocol to UDP or TCP. The client and server must use the same settings.
mssfix <max. size>	Mssfix sets the maximum size of the packet. This is only useful for UDP if problems occur.
verb <level>	Set log file verbosity level. Log verbosity level can be set from 0 (minimum) to 15 (maximum). For example, 0 = silent except for fatal errors 3 = medium output, good for general usage 5 = helps with debugging connection problems 9 = verbose, excellent for troubleshooting
dev tun dev tap	Select 'dev tun' to create a routed IP tunnel or 'dev tap' to create an Ethernet tunnel. The client and server must use the same settings.

remote <host>	The hostname/IP of OpenVPN server when operating as a client. Enter either the DNS hostname or the static IP address of the server.
Port	The UDP/TCP port of the server.
Keepalive	Keepalive uses ping to keep the OpenVPN session alive. 'Keepalive 10 120' pings every 10 seconds and assumes the remote peer is down if no ping has been received over a 120 second time period.
http-proxy <proxy server> <proxy port #>	If a proxy is required to access the server, enter the proxy server DNS name or IP and port number.
ca <file name>	Enter the CA certificate file name and location. The same CA certificate file can be used by the server and all clients. Note: Ensure each '\' in the directory path is replaced with '\\'. For example, c:\openvpnkeys\ca.crt will become c:\\openvpnkeys\\ca.crt
cert <file name>	Enter the client's or server's certificate file name and location. Each client should have its own certificate and key files. Note: Ensure each '\' in the directory path is replaced with '\\'. For example, c:\openvpnkeys\ca.crt will become c:\\openvpnkeys\\ca.crt
key <file name>	Enter the file name and location of the client's or server's key. Each client should have its own certificate and key files. Note: Ensure each '\' in the directory path is replaced with '\\'. For example, c:\openvpnkeys\ca.crt will become c:\\openvpnkeys\\ca.crt
dh <file name>	This is used by the server only. Enter the path to the key with the Diffie-Hellman parameters.
Nobind	'Nobind' is used when clients do not need to bind to a local address or specific local port number. This is the case in most client configurations.
persist-key	This option prevents the reloading of keys across restarts.
persist-tun	This option prevents the close and reopen of TUN/TAP devices across restarts.
cipher BF-CBC Blowfish (default) cipher AES-128-CBC AES cipher DES-EDE3-CBC Triple-DES	Select a cryptographic cipher. The client and server must use the same settings.
comp-lzo	Enable compression on the OpenVPN link. This must be enabled on both the client and the server.
syslog	By default, logs are located in syslog or, if running as a service on Window, in \\Program Files\\OpenVPN\\log directory.

To initiate the OpenVPN tunnel following the creation of the client/server configuration files:

1. Right click on the OpenVPN icon in the Notification Area
2. Select the newly created client or server configuration.
3. Click **Connect**

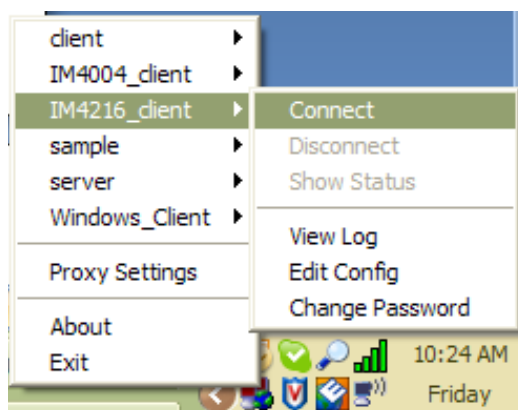

4. The log file is displayed as the connection is established

User Manual

```
IM4216_client - Notepad
File Edit Format View Help
Fri Aug 06 11:29:57 2010 OpenVPN 2.0.9 win32-mingw [SSL] [LZO] built on Oct 1 2006
Fri Aug 06 11:29:57 2010 WARNING: No server certificate verification method has been enabled. See http://openvpn.net/
Fri Aug 06 11:29:57 2010 LZO compression initialized
Fri Aug 06 11:29:57 2010 Control Channel MTU parms [ L:1542 D:138 EF:38 EB:0 ET:0 EL:0 ]
Fri Aug 06 11:29:57 2010 Data channel MTU parms [ L:1542 D:1450 EF:42 EB:135 ET:0 EL:0 AF:3/1 ]
Fri Aug 06 11:29:57 2010 Local Options hash (VER=V4): '41690919'
Fri Aug 06 11:29:57 2010 Expected Remote Options hash (VER=V4): '530fdded'
Fri Aug 06 11:29:57 2010 UDPv4 link local: [undef]
Fri Aug 06 11:29:57 2010 UDPv4 link remote: 192.168.250.152:1194
Fri Aug 06 11:29:57 2010 TLS: Initial packet from 192.168.250.152:1194, sid=dd3359de 265f251d
Fri Aug 06 11:30:01 2010 VERIFY OK: depth=1, /C=US/ST=CA/L=SanFrancisco/O=Fort-Funston/CN=OpenVPN-CA/emailAddress=me@er
Fri Aug 06 11:30:01 2010 Data Channel Encrypt: Cipher 'BF-CBC' initialized with 128 bit key
Fri Aug 06 11:30:02 2010 Data Channel Encrypt: Using 160 bit message hash 'SHA1' for HMAC authentication
Fri Aug 06 11:30:02 2010 Data Channel Decrypt: Cipher 'BF-CBC' initialized with 128 bit key
Fri Aug 06 11:30:02 2010 Data Channel Decrypt: Using 160 bit message hash 'SHA1' for HMAC authentication
Fri Aug 06 11:30:02 2010 Control Channel: TLSv1, cipher TLSv1/SSLv3 DHE-RSA-AES256-SHA, 1024 bit RSA
Fri Aug 06 11:30:02 2010 [server] Peer Connection initiated with 192.168.250.152:1194
Fri Aug 06 11:30:04 2010 SENT CONTROL [server]: 'PUSH_REQUEST' (status=1)
Fri Aug 06 11:30:04 2010 PUSH: Received control message: 'PUSH_REPLY,route 10.100.10.1,topology net30,ping 10,ping-res
Fri Aug 06 11:30:04 2010 Options error: unrecognized option or missing parameter(s) in [PUSH-OPTIONS]:2: topology (2.0
Fri Aug 06 11:30:04 2010 OPTIONS IMPORT: timers and/or timeouts modified
Fri Aug 06 11:30:04 2010 OPTIONS IMPORT: --ifconfig/up options modified
Fri Aug 06 11:30:04 2010 OPTIONS IMPORT: route options modified
Fri Aug 06 11:30:04 2010 TAP-WIN32 device [Local Area Connection 3] opened: \\.\Global\{12EF532A-3135-4F37-B689-720FE0
Fri Aug 06 11:30:04 2010 TAP-WIN32 Driver Version 8.4
Fri Aug 06 11:30:04 2010 TAP-WIN32 MTU=1500
Fri Aug 06 11:30:04 2010 Notified TAP-win32 driver to set a DHCP IP/netmask of 10.100.10.6/255.255.255.252 on interfac
Fri Aug 06 11:30:04 2010 Successful ARP Flush on interface [5] {12EF532A-3135-4F37-B689-720FE0B1F713}
Fri Aug 06 11:30:04 2010 Route: waiting for TUN/TAP interface to come up...
Fri Aug 06 11:30:05 2010 TEST ROUTES: 0/0 succeeded len=1 ret=0 a=0 u/d=down
Fri Aug 06 11:30:05 2010 Route: waiting for TUN/TAP interface to come up...
Fri Aug 06 11:30:06 2010 TEST ROUTES: 1/1 succeeded len=1 ret=1 a=0 u/d=up
```

- Once established, the OpenVPN icon displays a message indicating a successful connection and assigned IP. This information, as well as the time the connection was established, is available by scrolling over the OpenVPN icon.

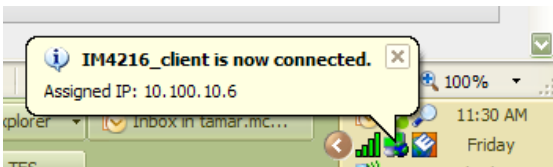

3.11 PPTP VPN

Console servers include a PPTP (Point-to-Point Tunneling Protocol) server. PPTP is used for communications over a physical or virtual serial link. The PPP endpoints define a virtual IP address to themselves. Routes to networks can be defined with these IP addresses as the gateway, which results in traffic being sent across the tunnel. PPTP establishes a tunnel between the physical PPP endpoints and securely transports data across the tunnel.



The strength of PPTP is its ease of configuration and integration into existing Microsoft infrastructure. It is generally used for connecting single remote Windows clients. If you take your portable computer on a business trip, you can dial a local number to connect to your Internet access service provider (ISP) and create a second connection (tunnel) into your office network across the Internet and have the same access to your corporate network as if you were connected directly from your office. Telecommuters can also set up a VPN tunnel over their cable modem or DSL links to their local ISP.

To set up a PPTP connection from a remote Windows client to your Opengear appliance and local network:

1. Enable and configure the PPTP VPN server on your Opengear appliance
2. Set up VPN user accounts on the Opengear appliance and enable the appropriate authentication
3. Configure the VPN clients at the remote sites. The client does not require special software as the PPTP Server supports the standard PPTP client software included with Windows NT and later
4. Connect to the remote VPN

3.11.1 Enable the PPTP VPN server

1. Select **PPTP VPN** on the **Serial & Networks** menu

The screenshot shows the 'PPTP Server' configuration page. It includes several sections with checkboxes and radio buttons for configuration options. At the bottom, there is an 'Apply Settings' button and a section for 'Authenticated PPTP VPN Connections'.

PPTP Server	
Enable	<input type="checkbox"/> Enable the PPTP server.
Minimum Authentication Required	<input type="radio"/> None (least secure) <input type="radio"/> PAP <input type="radio"/> CHAP <input type="radio"/> MSCHAPv2 (most secure) The least secure method to use when checking the PPTP user's credentials.
Required Encryption Level	<input type="radio"/> Only no encryption (also disables compression) <input type="radio"/> 40bit or 128bit encryption <input type="radio"/> Only 40bit encryption <input type="radio"/> Only 128bit encryption <input type="radio"/> Any encryption (including none) The encryption to require for the PPTP connection.
Local Address	<input type="text"/> IP address to assign to the server's end of the VPN connection.
Remote Addresses	<input type="text"/> Pool of IP addresses to assign to the incoming client's VPN connections e.g. 192.168.1.10-20
MTU	<input type="text"/> Maximum transmission unit of the PPTP Interface. Defaults to 1400.
DNS Server	<input type="text"/> Optional IP address of a DNS server to hand to incoming clients
WINS Server	<input type="text"/> Optional IP address of a WINS server to hand to incoming clients
Verbose logging	<input type="checkbox"/> Enable verbose logging to assist in debugging connection problems
Apply Settings	
Authenticated PPTP VPN Connections	
Authentication is required to track PPTP connections.	

2. Select the **Enable** check box to enable the PPTP Server
3. Select the **Minimum Authentication Required**. Access is denied to remote users attempting to connect using an authentication scheme weaker than the selected scheme. The schemes are described below, from strongest to weakest.
 - **Encrypted Authentication (MS-CHAP v2)**: The strongest type of authentication to use; this is the recommended option
 - **Weakly Encrypted Authentication (CHAP)**: This is the weakest type of encrypted password authentication to use. It is not recommended that clients connect using this as it provides very little password protection. Also note that clients connecting using CHAP are unable to encrypt traffic

- **Unencrypted Authentication (PAP):** This is plain text password authentication. When using this type of authentication, the client password is transmitted unencrypted.
 - **None**
4. Select the **Required Encryption Level**. Access is denied to remote users attempting to connect that are not using this encryption level.
 5. In **Local Address** enter IP address to assign to the server's end of the VPN connection
 6. In **Remote Addresses** enter the pool of IP addresses to assign to the incoming client's VPN connections (e.g. 192.168.1.10-20). This must be a free IP address or range of addresses from the network that remote users are assigned while connected to the OpenGear appliance
 7. Enter the desired value of the Maximum Transmission Unit (MTU) for the PPTP interfaces into the **MTU** field (defaults to 1400)
 8. In the **DNS Server** field, enter the IP address of the DNS server that assigns IP addresses to connecting PPTP clients
 9. In the **WINS Server** field, enter the IP address of the WINS server that assigns IP addresses to connecting PPTP client
 10. Enable **Verbose Logging** to assist in debugging connection problems
 11. Click **Apply Settings**
- ### 3.11.2 Add a PPTP user
1. Select **Users & Groups** on the **Serial & Networks** menu and complete the fields as covered in section 3.2.
 2. Ensure the **pptpd** group has been checked, to allow access to the PPTP VPN server. Note - users in this group have their passwords stored in clear text.
 3. Keep note of the username and password for when you need to connect to the VPN connection
 4. Click **Apply**

Add a New user	
Username	<input type="text"/> A unique name for the user.
Description	<input type="text"/> A brief description of the user's role.
Groups	<input type="checkbox"/> admin (Provides users with unlimited configuration and management privileges) <input type="checkbox"/> pptpd (Group to allow access to the PPTP VPN server - Users in this group will have their password stored in clear text.) <input type="checkbox"/> dialin (Group to allow dialin access via modems - Users in this group will have their password stored in clear text.) <input type="checkbox"/> ftp (Group to allow ftp access and file access to storage devices) <input type="checkbox"/> pmshell (Group to set default shell to pmshell) <input type="checkbox"/> pmoperator (Group to allow access to all serial ports and managed devices, including portmanager shell access. Please note that portmanager shell access overrides UNIX shell access) <input type="checkbox"/> users (Provides users with basic management privileges) <input type="checkbox"/> pmadmin (Group to allow basic web access and administration of serial ports) A group with predefined privileges the user will belong to.
Password	<input type="password"/> The users authentication secret. <i>Note: A password may not be required if remote authentication is being used.</i>
Confirm	<input type="password"/> Re-enter the users password for confirmation.
SSH Authorized Keys	SSH Authorized Keys <input type="button" value="New SSH Key"/>
Disable Password Authentication	<input type="checkbox"/> Check to only allow public key authentication for this user when using SSH
Dial-in Options	
Enable Dial-Back	<input type="checkbox"/> Allow an out-going connection to be triggered by logging into this port.

3.11.3 Set up a remote PPTP client

Ensure the remote VPN client PC has Internet connectivity. To create a VPN connection across the Internet, you must set up two networking connections. One connection is for the ISP, and the other connection is for the VPN tunnel to the Opendear appliance.

NOTE This procedure sets up a PPTP client in the Windows 7 Professional operating system. The steps may vary slightly depending on your network access or if you are using an alternate version of Windows. More detailed instructions are available from the Microsoft web site.

1. Login to your Windows client with administrator privileges
2. From the **Network & Sharing Center** on the **Control Panel** select **Network Connections** and create a new connection

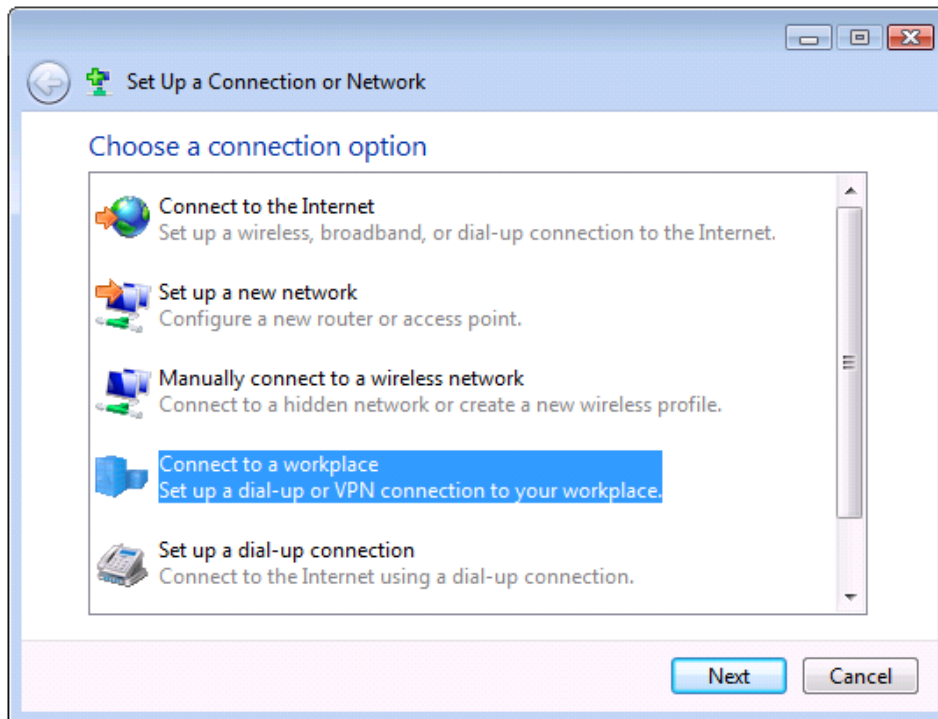

3. Select **Use My Internet Connection (VPN)** and enter the IP Address of the Opengear appliance

To connect remote VPN clients to the local network, you need to know the username and password for the PPTP account you added, as well as the Internet IP address of the Opengear appliance. If your ISP has not allocated you a static IP address, consider using a dynamic DNS service. Otherwise you must modify the PPTP client configuration each time your Internet IP address changes.

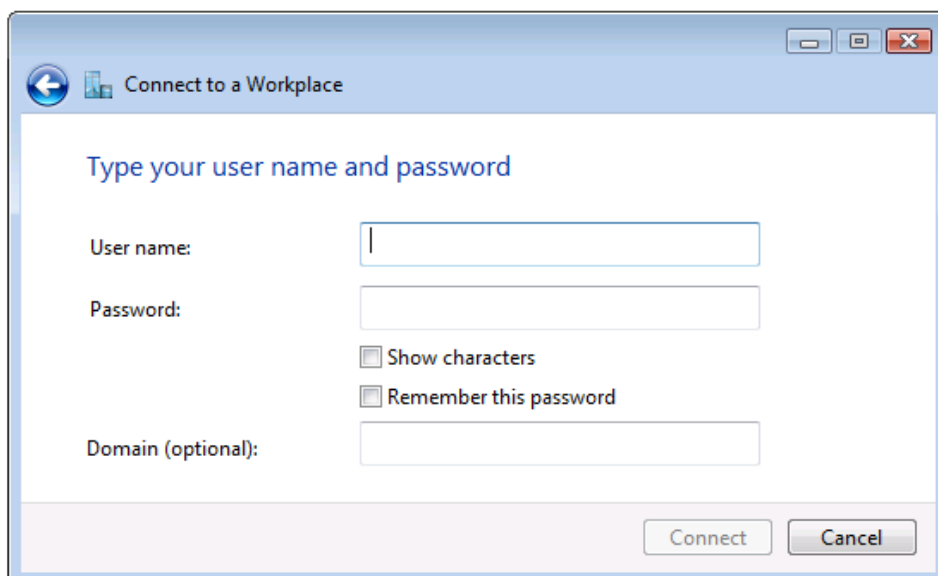

3.12 Call Home

All console servers include the Call Home feature which initiates the setup of a secure SSH tunnel from the console server to a centralized Lighthouse VM, Lighthouse Standard, Lighthouse Enterprise, CMS6100 or VCMS server (referred to as CMS). The console server registers as a **candidate** on the CMS. Once accepted there it becomes a **Managed Console Server**.

The CMS monitors the Managed Console Server and administrators can access the remote Managed Console Server through the CMS. This access is available even when the remote console server is behind a third-party firewall or has a private non-routable IP addresses.

NOTE CMS maintains public key authenticated SSH connections to each of its Managed Console Servers. These connections are used for monitoring, commanding and accessing the Managed Console Servers and the managed devices connected to the Managed Console Server.

To manage Local Console Servers, or console servers that are reachable from the CMS, the SSH connections are initiated by CMS.

To manage Remote Console Servers, or console servers that are firewalled, not routable, or otherwise unreachable from the CMS, the SSH connections are initiated by the Managed Console Server via an initial Call Home connection.

This ensures secure, authenticated communications and enables Managed Console Servers units to be distributed locally on a LAN, or remotely around the world.

3.12.1 Set up Call Home candidate

To set up the console server as a Call Home management candidate on the CMS:

1. Select **Call Home** on the **Serial & Network** menu

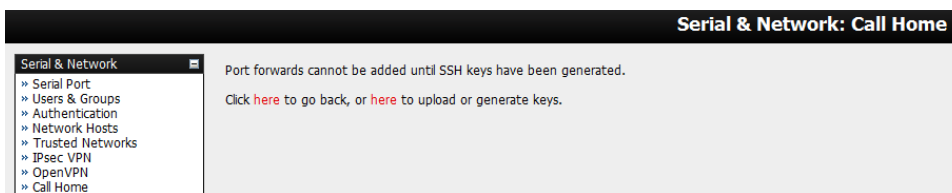

2. If you have not already generated or uploaded an SSH key pair for this console server, do so before proceeding
3. Click **Add**



4. Enter the IP address or DNS name (e.g. the dynamic DNS address) of the CMS
5. Enter the Password that you configured on the CMS as the **Call Home Password**

6. Click **Apply**

These steps initiate the Call Home connection from the console server to the CMS. This creates an SSH listening port on the CMS and sets the console server up as a candidate.



Once the candidate has been accepted on the CMS an SSH tunnel to the console server is redirected back across the Call Home connection. The console server has become a Managed Console Server and the CMS can connect to and monitor it through this tunnel.

3.12.2 Accept Call Home candidate as Managed Console Server on CMS

This section gives an overview on configuring the CMS to monitor console servers that are connected via Call Home. For more details see the Lighthouse CMS User Manual:

1. Enter a new **Call Home Password** on the CMS. This password is used for accepting Call Home connections from candidate console servers
2. The CMS can be contacted by the console server it must either have a static IP address or, if using DHCP, be configured to use a dynamic DNS service

The **Configure > Managed Console Servers** screen on the CMS shows the status of local and remote Managed Console Servers and candidates.

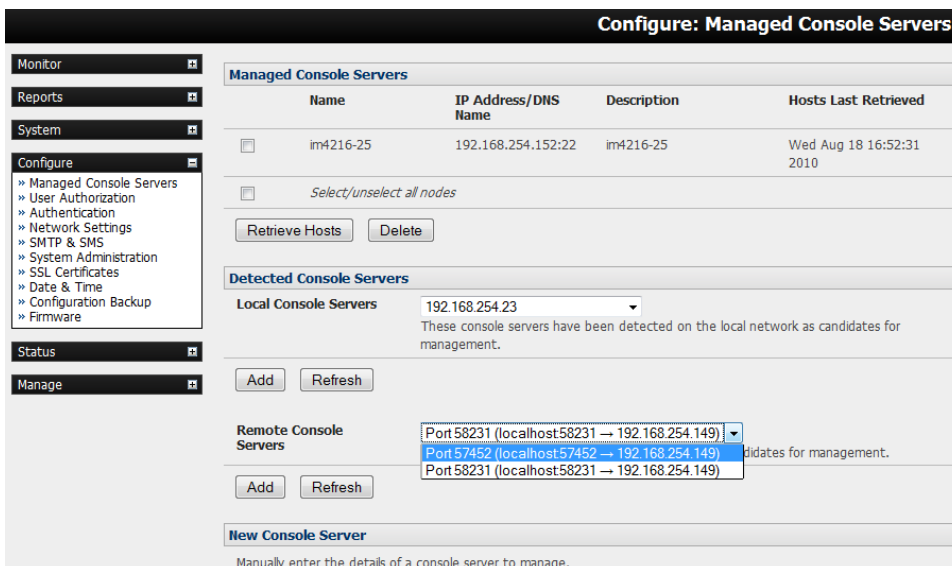

The **Managed Console Servers** section shows the console servers being monitored by the CMS.

The **Detected Console Servers** section contains:

- The **Local Console Servers** drop-down which lists all the console servers which are on the same subnet as the CMS, and are not being monitored

- The **Remote Console Servers** drop-down which lists all the console servers that have established a Call Home connection and are not being monitored (i.e. candidates). You can click **Refresh** to update

To add a console server candidate to the **Managed Console Server** list, select it from the **Remote Console Servers** drop-down list and click **Add**. Enter IP Address and SSH Port (if these fields have not been auto-completed) and enter a **Description** and unique **Name** for the Managed Console server you are adding

Enter the **Remote Root Password** (i.e. System Password that has been set on this Managed Console server). This password is used by the CMS to propagate auto generated SSH keys and is not stored. Click **Apply**. The CMS sets up secure SSH connections to and from the Managed Console Server and retrieves its Managed Devices, user account details and configured alerts

3.12.3 Calling Home to a generic central SSH server

If you are connecting to a generic SSH server (not a Lighthouse CMS) you may configure Advanced settings:

- Enter the **SSH Server Port** and **SSH User**.
- Enter the details for the SSH port forward(s) to create

By selecting Listening Server, you may create a **Remote** port forward from the Server to this unit, or a **Local** port forward from this unit to the Server:

- Specify a Listening Port to forward from, leave this field blank to allocate an unused port
- Enter the Target Server and Target Port that will be the recipient of forwarded connections

3.13 IP Passthrough

IP Passthrough is used to make a modem connection (e.g. the internal cellular modem) appear like a regular Ethernet connection to a third-party downstream router, allowing the downstream router to use the modem connection as a primary or backup WAN interface.

The Opengear device provides the modem IP address and DNS details to the downstream device over DHCP and passes network traffic to and from the modem and router.

While IP Passthrough turns an Opengear into a modem-to-Ethernet half bridge, some layer 4 services (HTTP/HTTPS/SSH) may be terminated at the Opengear (Service Intercepts). Also, services running on the Opengear can initiate outbound cellular connections independent of the downstream router.

This allows the Opengear to continue to be used for out-of-band management and alerting and also be managed via Lighthouse, while in IP Passthrough mode.

3.13.1 Downstream Router Setup

To use failover connectivity on the downstream router (aka Failover to Cellular or F2C), it must have two or more WAN interfaces.

NOTE Failover in IP Passthrough context is performed by the downstream router, and the built-in out-of-band failover logic on the Opengear is not available while in IP Passthrough mode.

Connect an Ethernet WAN interface on the downstream router to the Opengear's Network Interface or Management LAN port with an Ethernet cable.

Configure this interface on the downstream router to receive its network settings via DHCP. If failover is required, configure the downstream router for failover between its primary interface and the Ethernet port connected to the Opengear.

3.13.2 IP Passthrough Pre-Configuration

Prerequisite steps to enable IP Passthrough are:

1. Configure the Network Interface and where applicable Management LAN interfaces with static network settings
 - Click **Serial & Network > IP**
 - For **Network Interface** and where applicable **Management LAN**, select **Static** for the **Configuration Method** and enter the network settings (see the section entitled Network Configuration for detailed instructions)
 - For the interface connected to the downstream router, you may choose any dedicated private network – this network only exists between the Opengear and downstream router and is not normally accessible
 - For the other interface, configure it as you would per normal on the local network
 - For both interfaces, leave **Gateway** blank
2. Configure the modem in Always On Out-of-band mode

- For a cellular connection, click **System > Dial: Internal Cellular Modem**
- Select **Enable Dial-Out** and enter carrier details such as **APN** (see section Cellular Modem Connection for detailed instructions)

3.13.3 IP Passthrough Configuration

To configure IP Passthrough:

- Click **Serial & Network > IP Passthrough** and check **Enable**
- Select the Opendgear **Modem** to use for upstream connectivity
- Optionally, enter the **MAC Address** of downstream router's connected interface. If MAC address is not specified, the Opendgear will passthrough to the first downstream device requesting a DHCP address.
- Select the Opendgear Ethernet **Interface** to use for connectivity to the downstream router
- Click **Apply**

Configuration			
Enable	<input checked="" type="checkbox"/>	Enables IP passthrough: Bridging from Dialout to Ethernet	
Modem	Internal Cellular Modem	Modem to use for connectivity	
MAC Address	52:54:00:a5:c8:a7	Ethernet hardware address of downstream router	
Interface	Management LAN	Ethernet interface used to communicate to downstream router	
Status			
IP Passthrough	Running		
External IP Address	100.117.7.27		
Internal MAC Address	52:54:00:a5:c8:a7		
Modem	Enabled (Internal Cellular Modem) Configure		
DHCP Server	Running		
Service Intercepts			
Service Name	Service Enabled	Intercept Enabled	Intercept Port
HTTP web management	Enabled	<input type="checkbox"/>	80
HTTPS web management	Enabled	<input checked="" type="checkbox"/>	443
Secure Shell	Enabled	<input type="checkbox"/>	22
<input type="button" value="Apply"/>			

3.13.4 Service Intercepts

These allow the Opendgear to continue to provide services, for example, for out-of-band management when in IP Passthrough mode. Connections to the modem address on the specified intercept port(s) are handled by the Opendgear rather than passed through to the downstream router.

- For the required service of **HTTP**, **HTTPS** or **SSH**, check **Enable**
- Optionally modify the **Intercept Port** to an alternate port (e.g. 8443 for HTTPS), this is useful if you want to continue to allow the downstream router to remain accessible via its regular port

3.13.5 IP Passthrough Status

Refresh the page to view the **Status** section. It displays the modem's **External IP Address** being passed through, the **Internal MAC Address** of the downstream router (only populated when the downstream router accepts the DHCP lease), and the overall running status of the **IP Passthrough** service.

You may be alerted to the failover status of the downstream router by configuring a **Routed Data Usage Check** under **Alerts & Logging > Auto-Response**.

3.13.6 Caveats

Some downstream routers may be incompatible with the gateway route. This can happen when IP Passthrough is bridging a 3G cellular network where the gateway address is a point-to-point destination address and no subnet information is available. The Opendgear sends a DHCP netmask of 255.255.255.255. Devices normally construe this as a single host route on the interface, but some older downstream devices may have issues.

Intercepts for local services will not work if the Opengear is using a default route other than the modem. Also, they will not work unless the service is enabled and access to the service is enabled (see **System > Services**, under the **Service Access** tab find **Dialout/Cellular**).

Outbound connections originating from Opengear to remote services are supported (e.g. sending SMTP email alerts, SNMP traps, getting NTP time, IPSec tunnels). There is a small risk of connection failure should both the Opengear and the downstream device try to access the same UDP or TCP port on the same remote host at the same time when they have randomly chosen the same originating local port number.

3.14 Configuration over DHCP (ZTP)

Opengear devices can be provisioned during their initial boot from a DHCPv4 or DHCPv6 server using config-over-DHCP. Provisioning on untrusted networks can be facilitated by providing keys on a USB flash drive.

The ZTP functionality can also be used to perform a firmware upgrade on initial connection to the network, or to enroll into a Lighthouse 5 instance.

Preparation

The typical steps for configuration over a trusted network are:

1. Configure a same-model Opengear device.
2. Save its configuration as an Opengear backup (.opg) file.
3. Select **System > Configuration Backup > Remote Backup**.
4. Click **Save Backup**.

A backup configuration file — *model-name_iso-format-date_config.opg* — is downloaded from the Opengear device to the local system.

You can save the configuration as an xml file:

1. Select **System > Configuration Backup > XML Configuration**. An editable field containing the configuration file in XML format appears.
2. Click into the field to make it active.
3. If you are running any browser on Windows or Linux, right-click and choose **Select All** from the contextual menu or press Control-A. Right-click and choose **Copy** from the contextual menu or press Control-C.
4. If you are using any browser on macOS, choose **Edit > Select All** or press Command-A. Choose **Edit > Copy** or press Command-C.
5. In your preferred text-editor, create a new empty document, paste the copied data into the empty document and save the file. Whatever file-name you choose, it must include the .xml filename suffix.
6. Copy the saved .opg or .xml file to a public-facing directory on a file server serving at least one of the following protocols: HTTPS, HTTP, FTP or TFTP. (Only HTTPS can be used if the connection between the file server and a to-be-configured Opengear device travels over an untrusted network.)
7. Configure your DHCP server to include a 'vendor specific' option for Opengear devices. (This will be done in a DHCP server-specific way.) The vendor specific option should be set to a string containing the URL of the published .opg or .xml file in the step above. The option string must not exceed 250 characters and it must end in either .opg or .xml.

8. Connect a new Opengear device, either factory-reset or Config-Erased, to the network and apply power. It may take up to 5 minutes for the device to reboot itself.

Example ISC DHCP (dhcpd) server configuration

The following is an example DHCP server configuration fragment for serving an .opg configuration image via the ISC DHCP server, dhcpd:

```
option space opengear code width 1 length width 1;
option opengear.config-url code 1 = text;

class "opengear-config-over-dhcp-test" {
  match if option vendor-class-identifier ~~ "^Opengear/";
  vendor-option-space opengear;
  option opengear.config-url "https://example.com/opg/${class}.opg";
}
```

This setup can be modified to upgrade the configuration image using the `opengear.image-url` option, and providing a URI to the firmware image.

Setup when the LAN is untrusted

If the connection between the file server and a to-be-configured Opengear device includes an untrusted network, a two-handed approach can mitigate the issue.

NOTE This approach introduces two physical steps where trust can be difficult, if not impossible, to establish completely. First, the custody chain from the creation of the data-carrying USB flash drive to its deployment. Second, the hands connecting the USB flash drive to the Opengear device.

- Generate an X.509 certificate for the Opengear device.
- Concatenate the certificate and its private key into a single file named `client.pem`.
- Copy `client.pem` onto a USB flash drive.
- Set up an HTTPS server such that access to the .opg or .xml file is restricted to clients that can provide the X.509 client certificate generated above.
- Put a copy of the CA cert that signed the HTTP server's certificate — `ca-bundle.crt` — onto the USB flash drive bearing `client.pem`.
- Insert the USB flash drive into the Opengear device before attaching power or network.
- Continue the procedure from 'Copy the saved .opg or .xml file to a public-facing directory on a file server' above using the HTTPS protocol between the client and server.

Prepare a USB drive and create the X.509 certificate and private key

- Generate the CA certificate so the client and server Certificate Signing Requests (CSRs) can be signed.

```
# cp /etc/ssl/openssl.cnf .
# mkdir -p exampleCA/newcerts
# echo 00 > exampleCA/serial
# echo 00 > exampleCA/crlnumber
# touch exampleCA/index.txt
# openssl genrsa -out ca.key 8192
# openssl req -new -x509 -days 3650 -key ca.key -out demoCA/cacert.pem \
-subj /CN=ExampleCA
# cp demoCA/cacert.pem ca-bundle.crt
```

This procedure generates a certificate called `ExampleCA` but any allowed certificate name can be used. Also, this procedure uses `openssl ca`. If your organization has an enterprise-wide, secure CA generation process, that should be used instead.

User Manual

- Generate the server certificate.

```
# openssl genrsa -out server.key 4096
# openssl req -new -key server.key -out server.csr -subj /CN=demo.example.com
# openssl ca -days 365 -in server.csr -out server.crt \
  -keyfile ca.key -policy policy_anything -batch -notext
```

NOTE The hostname or IP address must be the same string used in the serving URL. In the example above, the hostname is demo.example.com.

- Generate the client certificate.

```
# openssl genrsa -out client.key 4096
# openssl req -new -key client.key -out client.csr -subj /CN=ExampleClient
# openssl ca -days 365 -in client.csr -out client.crt \
  -keyfile ca.key -policy policy_anything -batch -notext
# cat client.key client.crt > client.pem
```

- Format a USB flash drive as a single FAT32 volume.
- Move the client.pem and ca-bundle.crt files onto the flash drive's root directory.

Debugging ZTP issues

Use the ZTP log feature to debug ZTP issues. While the device is attempting to perform ZTP operations, log information is written to /tmp/ztp.log on the device.

The following is an example of the log file from a successful ZTP run.

```
# cat /tmp/ztp.log
Wed Dec 13 22:22:17 UTC 2017 [5127 notice] odhcp6c.eth0: restoring config via
DHCP
Wed Dec 13 22:22:17 UTC 2017 [5127 notice] odhcp6c.eth0: waiting 10s for network
to settle
Wed Dec 13 22:22:27 UTC 2017 [5127 notice] odhcp6c.eth0: NTP skipped: no server
Wed Dec 13 22:22:27 UTC 2017 [5127 info] odhcp6c.eth0: vendorspec.1 =
'http://[fd07:2218:1350:44::1]/tftpboot/config.sh'
Wed Dec 13 22:22:27 UTC 2017 [5127 info] odhcp6c.eth0: vendorspec.2 (n/a)
Wed Dec 13 22:22:27 UTC 2017 [5127 info] odhcp6c.eth0: vendorspec.3 (n/a)
Wed Dec 13 22:22:27 UTC 2017 [5127 info] odhcp6c.eth0: vendorspec.4 (n/a)
Wed Dec 13 22:22:27 UTC 2017 [5127 info] odhcp6c.eth0: vendorspec.5 (n/a)
Wed Dec 13 22:22:28 UTC 2017 [5127 info] odhcp6c.eth0: vendorspec.6 (n/a)
Wed Dec 13 22:22:28 UTC 2017 [5127 info] odhcp6c.eth0: no firmware to download
(vendorspec.2)
backup-url: trying http://[fd07:2218:1350:44::1]/tftpboot/config.sh ...
backup-url: forcing wan config mode to DHCP
backup-url: setting hostname to acm7004-0013c601ce97
backup-url: load succeeded
Wed Dec 13 22:22:36 UTC 2017 [5127 notice] odhcp6c.eth0: successful config load
Wed Dec 13 22:22:36 UTC 2017 [5127 info] odhcp6c.eth0: no lighthouse
configuration (vendorspec.3/4/5/6)
Wed Dec 13 22:22:36 UTC 2017 [5127 notice] odhcp6c.eth0: provisioning completed,
not rebooting
```

Errors are recorded in this log.

3.15 Enrollment into Lighthouse

Use Enrollment into Lighthouse to enroll Opengear devices into a Lighthouse instance, providing centralized access to console ports, and allowing central configuration of the Opengear devices.

See the **Lighthouse User Guide** for instructions for enrolling Opengear devices into Lighthouse.

4 FIREWALL, FAILOVER & OOB ACCESS

The console server has a number of out-of-band access capabilities and transparent fail-over features, to ensure high availability. If there's difficulty in accessing the console server through the main network path, all console server models provide out-of-band (OOB) access and administrators can access it and its Managed Devices from a remote location.

- All console server models support serially attaching an external dial-up modem and configuring dial-in OOB access. Some models with USB ports support attaching an external USB modem. Some models also come standard with an internal modem. These modems can also be configured for dial-in OOB access.
- All console server models with an internal or externally attached modem can be configured for out-dial to be permanently connected.
- The console server models can also be configured for transparent out-dial failover. In the event of a disruption in the principal management network, an external dial-up ppp connection is automatically established.
- These console server models can also be accessed out-of-band using an alternate broadband link and also offer transparent broadband failover.
- Models with an internal cellular modem can be configured for OOB cellular access or for cellular transparent failover or can be configured as a cellular router.

4.1 Dialup Modem Connection

To enable dial-in or dial-out you must first ensure there is a modem attached to the console server.

- Models with an internal modem allow OOB dial-in access. These models display an **Internal Modem Port** tab under **System > Dial** (as well as the **Serial DB9 Port** tab)
- Other models also support external USB modems. The USB modem is autodetected and an **External USB Modem Port** tab will show under **System > Dial** as well as the **Serial Console** tab. All console server models support an external modem (any brand) attached via a serial cable to the console/modem port for OOB dial-in access.
- The serial ports on the ACM7000 are by default all configured as RJ serial console server ports. Port 1 can be configured to be the **Local Console/Modem** port.

4.2 OOB Dial-In Access

Once a modem has been attached to the console server you can configure the console server for dial-in PPP access. The console server waits for an incoming connection from a dial-in at remote site. Next the remote client dial-in software needs to be configured to establish the connection between an administrator's client modem to the dial in modem on the console server.

4.2.1 Configure Dial-In PPP

Enable PPP access on the internal or externally attached modem:

1. Select the **System > Dial** menu option and the **Internal Modem** or **Serial Port** tab
2. Select the **Baud Rate** and **Flow Control** that will communicate with the modem

By default, the modem port is set with software flow control and the baud rate is set at:

- 115200 baud for external modems connected to the local console port on CM7100 and IM7200 console servers

User Manual

- 9600 baud for the internal modem or external USB modem and for external modems connected to the Console serial ports which have been reassigned for dial-in access (on ACM7000)

We recommend Serial Settings of 38400 baud with Hardware Flow Control for OOB dial-in.

The screenshot shows a web-based configuration interface for a Serial Console. It has three tabs: 'Serial Console' (selected), 'Internal Modem', and 'Internal Cellular Modem'. Under 'Serial Console Dial Settings', there are four radio button options: 'Disable' (selected), 'Enable Dial-In', 'Enable Dial-Out', and 'RFC2217 Port'. Below this is the 'Serial Settings' section with a 'Baud Rate' dropdown set to 115200 and a 'Flow Control' dropdown set to None. An 'Apply Modem Dial Settings' button is located at the bottom left of the settings area.

3. Check the **Enable Dial-In** radio button
4. In the **Remote Address** field, enter the IP address to be assigned to the dial-in client. You can select any address for the Remote IP Address. It must be in the same network range as the Local IP Address (e.g. 200.100.1.12 and 200.100.1.67)
5. In the **Local Address** field enter the IP address for the Dial-In PPP Server. This is the IP address used by the remote client to access console server once the modem connection is established. You can select any address for the Local IP Address but it must be in the same network range as the Remote IP Address
6. The **Default Route** option enables the dialed PPP connection to become the default route for the console server
7. The **Custom Modem Initialization** option allows a custom AT string modem initialization string to be entered (e.g. AT&C1&D3&K3)

Dial-In Settings	
Remote Address	<input type="text"/> The IP address to assign a dial-in client.
Local Address	<input type="text"/> The IP address for the dial-in server.
Default Route	<input type="checkbox"/> The dialed connection is to become a default route for the system.
Custom Modem Initialization	(Currently empty) <input type="text"/> An optional AT command sequence to initialize the modem.
Link Echo Disabled	<input type="checkbox"/> Disable Link Echo feature.
Link Echo Interval	<input type="text"/> The time (in seconds) between echo messages to check if the link is still operating (default is 30 seconds).
Link Echo Failures	<input type="text"/> The number of unreplied echo messages before the link is assumed to have failed (default is 2).
Authentication Type	<input checked="" type="radio"/> None (least secure) <input type="radio"/> PAP <input type="radio"/> CHAP <input type="radio"/> MSCHAPv2 (most secure) The method to use when checking the dial-in users credentials.
If CHAP or MSCHAPv2 is selected, the dial-in authentication will be encrypted. However, the traffic itself may not be. Consider using secure protocols (HTTPS/SSH) to access network resources over a dial-in link	

Dynamic DNS	
Dynamic DNS	<input type="text" value="None - DDNS disabled"/> Update a DNS server when IP address is changed.
DDNS server	<input type="text"/> The DDNS server to push updates to. The format is server address:port This is used by gnutip only
DDNS Hostname	<input type="text"/> The fully qualified DNS hostname assigned to this interface.
DDNS Username	<input type="text"/> The username for the account to manage this interface.
DDNS Password	<input type="password"/> The password for the account to manage this interface.
Confirm DDNS Password	<input type="password"/> Re-enter the password for confirmation.
Maximum Interval between updates	<input type="text"/> Maximum interval between updates in days. DDNS update will be sent even if the address has not changed. Defaults to 25.
Minimum Interval between checks	<input type="text"/> Minimum interval between checks for changed addresses, in seconds. Updates will still only be sent if the address has changed. Defaults to 1800.
Maximum attempts per update	<input type="text"/> Number of times to attempt an update before giving up. Defaults to 3.
<input type="button" value="Apply Modem Dial Settings"/>	

12. Select the **Authentication Type** required. Access is denied to remote users attempting to connect using an authentication scheme weaker than the selected scheme. The schemes are described below, from strongest to weakest.

- **Encrypted Authentication (MS-CHAP v2):** The strongest type of authentication to use; this is the recommended option
- **Weakly Encrypted Authentication (CHAP):** This is the weakest type of encrypted password authentication to use. It is not recommended that clients connect using this as it provides very little password protection. Also note that clients connecting using CHAP are unable to encrypt traffic
- **Unencrypted Authentication (PAP):** This is plain text password authentication. When using this type of authentication, the client password is transmitted unencrypted.
- **None**

13. Select the **Required Encryption Level**. Access is denied to remote users attempting to connect not using this encryption level.

NOTE The firmware supports multiple dial-in users, who are setup with dialin group membership. The **username** and **password** to be used for the dial-in PPP link and any dial-back phone numbers are configured when the user is set up.

4.2.2 Using SDT Connector client

Administrators can use their SDT Connector client to set up secure OOB dial-in access to remote console servers. The SDT Connector Java client software provides point-and-click secure remote access. OOB access uses an alternate path for connecting to the console server to that used for regular data traffic.

Starting an OOB connection in SDT Connector may be achieved by initiating a dial up connection or adding an alternate route to the console server. SDT Connector allows for maximum flexibility in this regard, by allowing you to provide your own scripts or commands for starting and stopping the OOB connection.

4.2.3 Set up Windows XP or later client

1. Open **Network Connections** in Control Panel and click the **New Connection Wizard**
2. Select **Connect to the Internet** and click **Next**
3. On the **Getting Ready** screen select **Set up my connection manually** and click **Next**
4. On the **Internet Connection** screen select **Connect using a dial-up modem** and click **Next**
5. Enter a **Connection Name** (any name you choose) and the dial-up **Phone number** that will connect thru to the console server modem
6. Enter the PPP **Username** and **Password** for have set up for the console server

4.2.4 Set up earlier Windows clients

For Windows 2000, the PPP client set up procedure is the same as above, except you get to the **Dial-Up Networking Folder** by clicking the **Start** button and selecting **Settings**. Click **Network and Dial-up Connections** and click **Make New Connection**

For Windows 98, double click **My Computer** on the Desktop, open **Dial-Up Networking** and double click **Make New Connection** and proceed as above

4.2.5 Set up Linux clients

The online tutorial <http://www.yolinux.com/TUTORIALS/LinuxTutorialPPP.html> presents a selection of methods for establishing a dial up PPP connection.

For all PPP clients:

- Set the PPP link up with TCP/IP as the only protocol enabled
- Specify that the Server will assign IP address and do DNS
- Do not set up the console server PPP link as the default for Internet connection

4.3 Dial-Out Access

The internal or externally attached modem on the console server can be set up in Failover mode where a dial-out connection is only established in event of a ping failure, or with the dial-out connection always on, or network control via RFC2217 Port.

The console server attempts to re-establish the connection in the event of a disruption in the dial-out connection.

4.3.1 Always-on dial-out

The console server modem can be configured for out-dial to be always on, with a permanent external dial-up ppp connection.

- Select the **System > Dial** menu option and check **Enable Dial-Out** to allow outgoing modem communications
- Select the **Baud Rate** and **Flow Control** that will communicate with the modem
- In the **Dial-Out Settings - Always On Out-of-Band** field enter the access details for the remote PPP server to be called

Override DNS is available for PPP Devices such as modems. Override DNS allows the use of alternate DNS servers from those provided by your ISP. For example, an alternative DNS may be required for OpenDNS used for content filtering.

To enable **Override DNS**, check the Override returned DNS Servers box. Enter the IP of the DNS servers into the spaces provided.

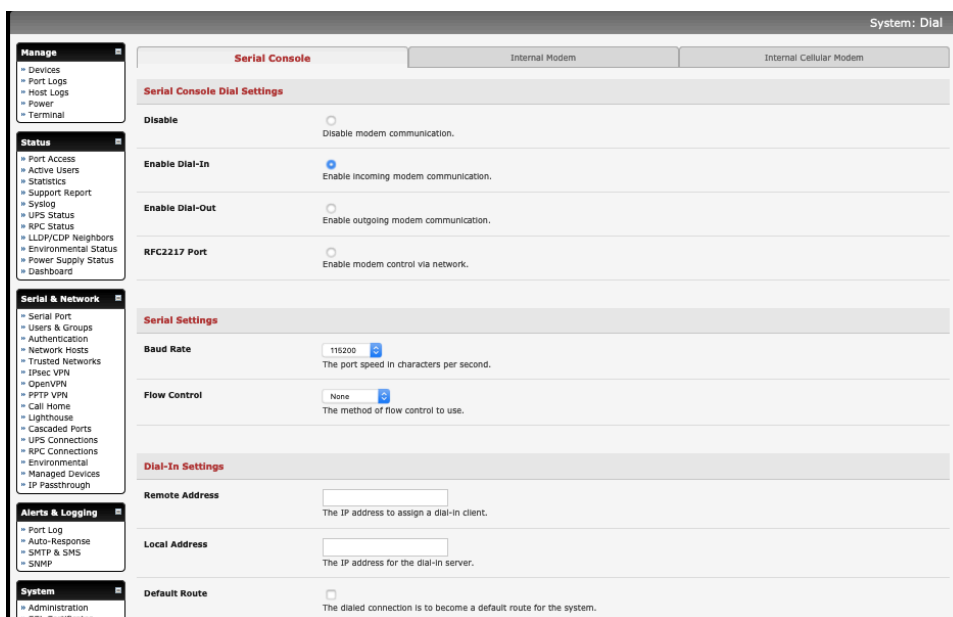

4.3.2 Failover dial-out

The ACM7000, CM7100, and IM7200 can be configured so a dial-out PPP connection is automatically set up in the event of a disruption in the principal management network.

NOTE SSH and HTTPS access is enabled on the failover connection so an administrator can SSH or HTTPS connect to the console server and fix the problem.

1. When configuring the principal network connection in **System > IP** specify the **Failover Interface** used when a fault is detected with Network / Network1 (eth0). This can be either **Internal Modem**

User Manual

or the **Serial Console** if you are using an external modem on the Console port or **USB Modem** if you are using a USB modem on an ACM7000.

The screenshot displays two sections of network configuration: **IP Settings: Network** and **IPv6 Settings: Network**. The IP Settings section includes fields for Configuration Method (DHCP selected), IP Address, Subnet Mask, Gateway, DNS Search Domain, Primary DNS, Secondary DNS, Media (Auto), MTU, DHCP Server (Disabled), IP Alias, and Serial Port Aliases (None). The IPv6 Settings section includes Configuration Method (Automatic selected) and a Failover section with a dropdown menu showing options: None (checked), Management LAN (lan) DISABLED, Serial Console (sercon) DISABLED, Internal Modem (modem01) DISABLED, and Internal Cellular Modem (cellmodem01) DISABLED. The Primary Probe Address field is also visible.

2. Specify the **Probe Addresses** of two sites (the **Primary** and **Secondary**) that the console server is to ping to determine if Network / Network1 is operational
3. Select the **System > Dial** menu option and the port to be configured (**Serial Console** or **Internal Modem Port**)
4. Select the **Baud Rate** and **Flow Control** that will communicate with the modem
5. Check the **Enable Dial-Out Access** box and enter the access details for the remote PPP server to be called

Override DNS is available for PPP Devices such as modems. Override DNS allows the use of alternate DNS servers from those provided by your ISP. For example, an alternative DNS may be required for OpenDNS used for content filtering.

To enable **Override DNS**, check the Override returned DNS Servers box. Enter the IP of the DNS servers into the spaces provided.

Serial Console	Internal Modem	Internal Cellular Modem
<p>Carrier data charges apply while the cellular connection is active. We recommend configuring Auto-Response Cellular Data alerts and where possible monitoring data usage via your carrier's portal. Consider using Failover mode (under IP >> Network Interface >> Failover) to limit cellular activity.</p>		
<h3>Internal Cellular Modem Dial Settings</h3>		
Disable	<input type="radio"/>	Disable modem communication.
Enable Dial-Out	<input checked="" type="radio"/>	Enable outgoing modem communication.
<h3>Dial-Out Settings - Always On Out-of-Band</h3>		
Control via Auto-Response	<input type="checkbox"/>	Indicates that the connection will be controlled by "Network Interface" Auto-Response action. The default state for the connection will be Down
APN	<input type="text" value="1xtra.internet"/>	The access point name.
Phone Number	<input type="text" value="(Currently empty)"/>	The sequence to dial to establish the connection, defaults to *99**33#
Username	<input type="text"/>	Optional user name to authenticate the connection.
Password	<input type="text"/>	Optional secret to use when authenticating the user.
Confirm	<input type="text"/>	Re-enter the user's password for confirmation.
Custom Modem Initialization	<input type="text" value="(Currently empty)"/>	An optional AT command sequence to initialize the modem.
Override returned DNS servers	<input type="checkbox"/>	Use the following DNS servers instead of the PPP provided servers.
DNS Server 1	<input type="text"/>	The primary DNS server.
DNS Server 2	<input type="text"/>	The secondary DNS server.

NOTE By default, the console server supports automatic failure-recovery back to the original state prior to failover. The console server continually pings probe addresses while in original and failover states. The original state is automatically set as a priority and reestablished following three successful pings of the probe addresses during failover. The failover state is removed once the original state has been re-established.

4.3.3 Enable modem control via network

System: Dial

Serial Console	Internal Modem	Internal Cellular Modem
<h3>Internal Modem Dial Settings</h3>		
Disable	<input type="radio"/>	Disable modem communication.
Enable Dial-In	<input type="radio"/>	Enable incoming modem communication.
Enable Dial-Out	<input type="radio"/>	Enable outgoing modem communication.
RFC2217 Port	<input checked="" type="radio"/>	Enable modem control via network.
<h3>Serial Settings</h3>		
Baud Rate	<input type="text" value="38400"/>	The port speed in characters per second.
Flow Control	<input type="text" value="Hardware"/>	The method of flow control to use.
RFC2217 Port	<input type="text"/>	TCP port to accept RFC2217 connections on. Will default to 1500.
<input type="button" value="Apply Modem Dial Settings"/>		

Choose this option to control the internal modem via RFC2217. This option allows control from Lighthouse.

4.4 OOB Broadband Ethernet Access

The ACM7000, CM7100, and IM7200 have a second Ethernet port (NET2 on the CM7100 and ACM7000,) that can be configured for alternate and OOB (out-of-band) broadband access. With two active broadband access paths to these console servers, in the event you are unable to access through the primary management network (LAN1, Network or Network1) you can access it through the alternate broadband path

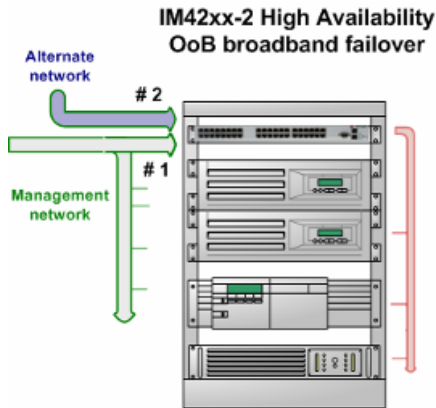

On the **System > IP** menu select **Management LAN Interface** (CM7100, IM7200) and configure the **IP Address, Subnet Mask, Gateway** and **DNS** with the access settings that relate to the alternate link.

Ensure when configuring the principal **Network Interface** connection, the **Failover Interface** is set to **None**.

4.5 Broadband Ethernet Failover

The second Ethernet port can also be configured for failover to ensure transparent high availability.

The screenshot shows the "Failover" configuration page. The "Failover Interface" dropdown menu is open, showing options: "None" (selected), "Management LAN (lan) DISABLED", "Serial Console (sseccon) DISABLED", "Internal Modem (modem01) DISABLED", and "Internal Cellular Modem (cellmodem01)". Below the dropdown, there are fields for "Primary Probe Address" and "Secondary Probe Address". The "Dynamic DNS" section has a dropdown set to "None - DNS disabled" and a "DNS update server" field.

1. When configuring the principal network connection, specify **Management LAN Interface** as the **Failover Interface** to be used when a fault has been detected with **Network Interface**
2. Specify the **Probe Addresses** of two sites (the **Primary** and **Secondary**) that the console server is to ping to determine if **Network Interface** is operational

Then on the **Management LAN Interface** (CM7100 or IM7200) configure the **IP Address, Subnet Mask,** and **Gateway**. The Management LAN Interface address must be unique, although it is permissible for it to be in the same subnet as the **Network Interface**.

Failover

Failover Interface None Management LAN (lan) DISABLED : be configured and enabled for failover to work.

Dormant Failover Interface Management LAN (lan) DISABLED Management LAN (lan) DISABLED : Management LAN (lan) DISABLED, only being routed through in failure situations.

Primary Probe Address The address of the first pair to probe for connectivity detection.

Secondary Probe Address The address of the second pair to probe for connectivity detection.

Dynamic DNS

Dynamic DNS Update a DNS server when IP address is changed.

DNS update server The DNS server to push updates to.
The format is server address:port
This is used by gnuddp only

In this mode, **Management LAN Interface** is available as the transparent back-up port to **Network Interface** for accessing the management network. **Management LAN Interface** takes over the work of **Network Interface** in the event **Network Interface** becomes unavailable.

NOTE SSH and HTTPS access is enabled on the failover connection so an administrator can connect to the console server and fix the problem.

By default, the console server supports automatic failure-recovery back to the original state prior to failover (V3.1.0 firmware and later). The console server continually pings probe addresses whilst in original and failover states. The original state is set as a priority and reestablished following three successful pings of the probe addresses during failover. The failover state is removed once the original state has been re-established.

4.6 Cellular Modem Connection

Some models support internal cellular modems. These modems first need to be installed and set up to validate they can connect to the carrier network. They can be configured for operation in Always-on, cellular router or OOB mode or in Failover mode.

4.6.1 Connecting to a GSM HSUPA/UMTS carrier network

-G models have an internal GSM modem that connects to any major GSM carrier globally.

1. Select **Internal Cellular Modem** panel on the **System > Dial** menu
2. Check **Enable Dial-Out Settings**

User Manual

Serial Console	Internal Modem	Internal Cellular Modem
<p>Carrier data charges apply while the cellular connection is active. We recommend configuring Auto-Response Cellular Data alerts and where possible monitoring data usage via your carrier's portal. Consider using Failover mode (under IP -> Network Interface -> Failover) to limit cellular activity.</p>		
Internal Cellular Modem Dial Settings		
Disable	<input type="radio"/>	Disable modem communication.
Enable Dial-Out	<input checked="" type="radio"/>	Enable outgoing modem communication.
Dial-Out Settings - Always On Out-of-Band		
Control via Auto-Response	<input type="checkbox"/>	Indicates that the connection will be controlled by "Network Interface" Auto-Response action. The default state for the connection will be Down
APN	<input type="text" value="telstra.internet"/>	The access point name.
Phone Number	<input type="text" value="(Currently empty)"/>	The sequence to dial to establish the connection, defaults to *99***1#
Username	<input type="text"/>	Optional user name to authenticate the connection.
Password	<input type="text"/>	Optional secret to use when authenticating the user.
Confirm	<input type="text"/>	Re-enter the user's password for confirmation.
Custom Modem Initialization	<input type="text" value="(Currently empty)"/>	An optional AT command sequence to initialize the modem.
Override returned DNS servers	<input type="checkbox"/>	Use the following DNS servers instead of the PPP provided servers.
DNS Server 1	<input type="text"/>	The primary DNS server.
DNS Server 2	<input type="text"/>	The secondary DNS server.

NOTE Your 3G carrier may have provided you with details for configuring the connection including APN (Access Point Name), Pin Code (optional PIN code which may be required to unlock the SIM card), Phone Number (the sequence to dial to establish the connection, defaults to *99***1#), Username / Password (optional) and Dial string (optional AT commands). In general, you only need to enter your provider's APN and leave the other fields blank

3. Enter the carrier's **APN** e.g. for AT&T (USA) enter i2gold, for T-Mobile (USA) enter epc.tmobile.com, for InterNode (Aust) enter internode and for Telstra (Aust) enter telstra.internet
4. If the SIM Card is configured with a PIN Code, unlock the card by entering the PIN Code. If the PIN Code is entered incorrectly three times, the PUK Code is required to unlock the Card.

You may also need to set Override DNS to use alternate DNS servers from those provided by your carrier.

5. To enable **Override DNS**, check the **Override returned DNS Servers** box. Enter the IP of the DNS servers into the spaces provided.

Override returned DNS servers	<input checked="" type="checkbox"/>	Use the following DNS servers instead of the PPP provided servers.
DNS Server 1	<input type="text"/>	The primary DNS server.
DNS Server 2	<input type="text"/>	The secondary DNS server.
Dynamic DNS		
Dynamic DNS	<input type="text" value="None - DDNS disabled"/>	Update a DNS server when IP address is changed.
DDNS server	<input type="text"/>	The DDNS server to push updates to. The format is server address:port This is used by gnuddp only
DDNS Hostname	<input type="text"/>	The fully qualified DNS hostname assigned to this interface.
DDNS Username	<input type="text"/>	The username for the account to manage this interface.
DDNS Password	<input type="text"/>	The password for the account to manage this interface.
Confirm DDNS Password	<input type="text"/>	Re-enter the password for confirmation.
Maximum interval between updates	<input type="text"/>	Maximum interval between updates in days. DDNS update will be sent even if the address has not changed. Defaults to 25.
Minimum interval between checks	<input type="text"/>	Minimum interval between checks for changed addresses, in seconds. Updates will still only be sent if the address has changed. Defaults to 1800.
Maximum attempts per update	<input type="text"/>	Number of times to attempt an update before giving up. Defaults to 3.

6. Check **Apply** to establish a radio connection with your cellular carrier

4.6.2 Connecting to a CDMA EV-DO carrier network

-GV and -GS models have an internal CDMA modem. Both connect to the Verizon network in North America.

After creating an account with the CDMA carrier some carriers require an additional step to provision the **Internal Cellular Modem**, referred to as Provisioning.

System: Dial

- Serial & Network
 - Serial Port
 - Users & Groups
 - Authentication
 - Network Hosts
 - Trusted Networks
 - IPsec VPN
 - OpenVPN
 - Call Home
 - Cascaded Ports
 - UPS Connections
 - RPC Connections
 - Environmental
 - Managed Devices
- Alerts & Logging
 - Port Log
 - Alerts
 - SMTP & SMS
 - SNMP
- System
 - Administration
 - SSL Certificates
 - Configuration Backup
 - Firmware
 - IP
 - Date & Time
 - Dial
 - Services
 - Nagios
 - Configure Dashboard
 - I/O Ports
- Status
 - Port Access
 - Active Users
 - Statistics
 - Support Report
 - Syslog
 - UPS Status
 - RPC Status
 - Environmental Status
 - Dashboard

Serial Console/Port 1
Internal Cellular Modem

CDMA Modem Activation

The CDMA Modem is not provisioned/activated, please contact your carrier and provide them with the ESN: **1620743259 (0x609A945B)**

Some carriers require a second activation step before you can connect successfully to their service. If your carrier requires OTASP enter the Phone number below and click **Activate**

Activation Phone Number

The phone number to dial for OTASP (Over-the-Air Service Provisioning) activation. e.g. *22899 for Verizon

In the case your carrier does not support OTASP activation enter your MSL, MDN & MSID below to manually activate the modem.

MSL

The MSL for unlocking the NAM profile. Advanced

MDN

The Mobile Directory Number to use. Advanced

MSID

The NAM profile MSID to use. Advanced

Dial-Out Settings - Always On Out-of-Band

Enable

Enable the cellular modem connection.

Phone Number

The sequence to dial to establish the connection, defaults to #777.

Custom Modem Initialization

An optional AT command sequence to initialize the modem.

OTASP Activation:

Before this can be achieved you need both a working account and an activated device in that the Opendgear's ESN (Electronic Serial Number) needs to be registered with an appropriate plan on your Carriers account

1. Select **Internal Cellular Modem** panel on the **System > Dial** menu
2. A particular phone number needs to be dialed to complete OTASP e.g. Verizon uses *22899, Telus uses *22886
3. Click **Activate** to initiate the OTASP call. The process is successful if no errors are displayed and you no longer see the CDMA Modem Activation form. If OTASP is unsuccessful you can consult the System Logs for clues to what went wrong at **Status > Syslog**
4. When **OTASP** has completed, enable the **Internal Cellular Modem** by entering the carriers phone number (which defaults to #777) and clicking **Apply**
5. The **Cellular** statistics page on **Status > Statistics** displays the current state of the modem

The screenshot shows the 'Status: Statistics' page with the 'Cellular' tab selected. The left sidebar contains a navigation menu with categories like Serial & Network, Alerts & Logging, System, and Status. The main content area displays the following information:

Internal Cellular Modem	
Service Availability	Service available
Roaming Support	Supported
Current Roaming Status	Not roaming
Supported System Mode	Auto-select
Current System Mode	WCDMA mode
Network Acquisition Order	WCDMA then GSM
Radio Access Technology	UMTS 3G Preferred
Supported Service Domain	Circuit and packet-switched
Current Service Domain	Circuit and packet-switched service
SIM Status	SIM available
Received Signal Strength Indication (RSSI in dBm)	-83
Bit Error Rate	Unknown
Operational Status	Current Time: 3457 Temperature: 30 Bootup Time: 100 Mode: ONLINE System mode: WCDMA PS state: Attached WCDMA band: WCDMA800 GSM band: Unknown WCDMA channel: 4412 GSM channel: 65535

6. **OTASP** success results in a valid phone number placed in the **NAM Profile Account MDN** field

Manual Activation:

Some carriers may not support **OTASP** in which case it may be necessary to manually provision the modem.

1. Select **Internal Cellular Modem** panel on the **System > Dial** menu

Serial Console/Port 1 Internal Cellular Modem

CDMA Modem Activation

The CDMA Modem is not provisioned/activated, please contact your carrier and provide them with the ESN: **1620743259 (0x609A945B)**

Some carriers require a second activation step before you can connect successfully to their service. If your carrier requires OTASP enter the Phone number below and click **Activate**

Activation Phone Number
The phone number to dial for OTASP (Over-the-Air Service Provisioning) activation. e.g. *22899 for Verizon

In the case your carrier does not support OTASP activation enter your MSL, MDN & MSID below to manually activate the modem.

MSL
The MSL for unlocking the NAM profile. *Advanced*

MDN
The Mobile Directory Number to use. *Advanced*

MSID
The NAM profile MSID to use. *Advanced*

Activate

2. Enter the **MSL**, **MDN** and **MSID** values. These are specific to your carrier and for manual activation, find out which values your carrier uses in each field. For example, **Verizon** has used an **MSL** of **000000** and the phone number assigned to the Opengear device as both the **MDN** and **MSID** with no spaces or hyphens, e.g. **5551231234** for **555-123-1234**
3. Click **Activate**. If no errors occur, the new values appear in the **NAM Profile** at the **Cellular** page on **Status > Statistics**

NAM Profile Account	MDN: 0000003259
	MEI: 0000003259
	SID: 0
	NED: 0

4. Navigate to the **Internal Cellular Modem** tab on **System > Dial**. To connect to your carrier's 3G network, enter the appropriate phone number (usually **#777**) and a **Username** and **Password** if directed to by your account/plan documentation
5. Select **Enable**.
6. Click **Apply** to initiate the **Always On Out-of-Band** connection

4.6.3 Connecting to a 4G LTE carrier network

-LV, -LA and -LR models have an internal modem that connect to any major 4G LTE carrier globally.

1. Before powering on, you must install the SIM card provided by your cellular carrier, and attach the external aerial
2. Select **Internal Cellular Modem** panel on the **System > Dial** menu
3. Check **Enable Dial-Out Settings**

User Manual

Carrier data charges apply while the cellular connection is active. We recommend configuring [Auto-Response](#) Cellular Data alerts and where possible monitoring data usage via your carrier's portal. Consider using Failover mode (under [IP -> Network Interface -> Failover](#)) to limit cellular activity.

Internal Cellular Modem Dial Settings

Disable Disable modem communication.

Enable Dial-Out Enable outgoing modem communication.

Dial-Out Settings - Always On Out-of-Band

Control via Auto-Response Indicates that the connection will be controlled by "Network Interface" Auto-Response action. The default state for the connection will be Down

APN The access point name.

4. Enter the carrier's **APN**

5. If the SIM Card is configured with a PIN Code, unlock the Card by entering the PIN Code.

You may also need to set Override DNS to use alternate DNS servers from those provided by your carrier.

6. To enable **Override DNS**, check the Override returned DNS Servers box. Enter the IP of the DNS servers into the spaces provided.

Carrier data charges apply while the cellular connection is active. We recommend configuring [Auto-Response](#) Cellular Data alerts and where possible monitoring data usage via your carrier's portal. Consider using Failover mode (under [IP -> Network Interface -> Failover](#)) to limit cellular activity.

Internal Cellular Modem Dial Settings

Disable Disable modem communication.

Enable Dial-Out Enable outgoing modem communication.

Dial-Out Settings - Always On Out-of-Band

Control via Auto-Response Indicates that the connection will be controlled by "Network Interface" Auto-Response action. The default state for the connection will be Down

APN The access point name.

7. Check **Apply**. A radio connection is established with your cellular carrier

4.6.4 Verifying the cellular connection

Out-of-band access is enabled by default so the cellular modem connection should be on.

- Verify the connection status from the **Status > Statistics**
 - Select the **Cellular** tab and under **Service Availability** verify **Mode** is set to **Online**
 - Select **Failover& Out-of-Band** and the Connection Status reads Connected

- You can check your allocated IP address

Interfaces	Routes/DNS	Serial Ports	IP	ICMP	TCP	UDP	Wireless	Failover & Out-of-Band	Cellular
Failover									
Failover is not configured.									
Always on Out-of-Band - Internal Cellular Modem (cellmodem)									
Connection Status		Connected							
IP Address		10.92.151.51 <small>Warning: This is a private IP address, VPN is required to enable incoming connections.</small>							

- Measure the received signal strength from the **Cellular Statistics** page on the **Status > Statistics** screen. This displays the current state of the cellular modem including the Received Signal Strength Indicator (**RSSI**). The best throughput comes from placing the device in an area with the highest RSSI.

- 100 dbm or less = Unacceptable coverage
- 99 dbm to -90 dbm = Weak Coverage
- 89 dbm to -70 dbm = Medium to High Coverage
- 69 dbm or greater = Strong Coverage

You can also see the connection status from the LEDs on top of unit

4.6.5 Cellular modem watchdog

Select **Enable Dial-Out** on the **System > Dial** menu under **Internal Cellular Modem** to configure a cellular modem watchdog service. This service periodically pings a configurable IP address. If a threshold number of consecutive attempts fail, the service reboots the unit to force a clean restart of the modem and its services to work around any carrier issues.

Modem Watchdog - Advanced

This feature configures a service which will periodically ping a configurable IP address. If a threshold number of attempts fail, the service will cause the unit to reboot. This can be used to force a clean restart of the modem and its services to work around any carrier issues.
Note that this will not function if cellmodem is held down by non-dormant failover or Auto-Response, and the period of (Period x Threshold) must be longer than 15 minutes to avoid premature reboot

Enable watchdog	<input type="checkbox"/> Configure a service to reboot the unit if a configurable number of ping attempts fail
Address	<input type="text"/> <small>IP address to periodically ping</small>
Threshold	<input type="text"/> <small>Number of failed ping attempts required before rebooting</small>
Ping count	<input type="text"/> <small>Number of pings per attempt. Defaults to 5</small>
Period	<input type="text"/> <small>Number of seconds to wait between attempts. Defaults to 30</small>

4.6.6 Dual SIM failover

Some console server models allow you to insert two SIM cards so you can connect to two carrier networks. The dual SIM failover feature allows the cell modem to selectively failover to the secondary SIM when communications over the primary SIM fails.

User Manual

To configure dual SIM failover, you need to:

1. Choose which of the SIMs is to be the Primary. The other SIM will be the secondary/failover. It is recommended that an explicit slot is chosen, rather than leaving it on **Automatic**. Select **Internal Cellular Modem** panel on the **System > Dial** menu nominate which slot (**Top** or **Bottom**) contains the Primary
2. Check **Enable SIM Failover**

The screenshot shows the 'Internal Cellular Modem' configuration page. It features several sections: 'Internal Cellular Modem Dial Settings' with radio buttons for 'Disable Dial', 'Enable Dial-In', and 'Enable Dial-Out'; 'SIM Not Ready' with an error message; 'Dial-Out Settings - Always On Out-of-Band'; 'SIM Configuration' with a dropdown for 'Primary SIM' set to 'Bottom Slot'; and 'Enable SIM Failover' with a checked checkbox. A 'SIM Failover Settings' section is partially visible at the bottom.

3. Specify how the device will Failback from the failover SIM to the Primary SIM. There are two options
 - **On Disconnect** failbacks to the Primary SIM only after the connection on the failover SIM has failed its ping test
 - **On Timeout** failbacks to the Primary SIM after the connection on the failover SIM has been up for the timeout period. The timeout period is either the default value of 600 seconds or the number of seconds you have specified in the **Failback Timeout** field
4. Configure each SIM connection with as much information to make a successful connection given sufficient signal strength from the cell service provider
5. Enter a **Failback Test IP** address for each SIM. This IP address is used to ping test the status of the cell modem connection and to determine if SIM failover or failback is to take place.

Configuring DDNS and the Modem Watchdog are optional. DDNS, when configured, is applied to the cell modem dial out connection regardless of which SIM is in use. Dual SIM failover is for dial out connections only

4.6.7 Automatic SIM Slot Detection

If a single SIM card is used in a Dual SIM slot product, the console server selects that slot. If both slots are populated, the bottom SIM slot is used.

4.6.8 Multi-carrier cellular support

Some cellular carriers require the console server's cellular modem to be programmed with carrier-specific firmware to operate on their network. Some console server models are equipped with a reprogrammable cellular modem, allowing them to operate on more than one cellular network.

Changes to the cellular modem firmware are unaffected by Opengear firmware upgrades or factory erase/configuration reset operations.

To switch carriers using the UI:

1. For devices with multi-carrier capability, the **System > Dial > Internal Cellular Modem** tab provides control over which carrier's firmware is installed on the modem.
2. Select the desired carrier and click the **Change Carrier** button to program the modem's flash with the carrier-specific firmware image(s).

Internal Cellular Modem Carrier Settings

This feature allows the modem to switch to a different carrier. Dial-Out must be disabled, and as part of this procedure, the SIM configuration will be reset. The process can take several minutes, and the modem will be unresponsive during this time.

Carrier

DoCoMo
 Generic
 KDDI
 SoftBank
 Telstra

Switch to a different cellular carrier.

Change Carrier

3. The flashing process takes several minutes during which the cellular modem is unavailable. During this time, the page refreshes with status information. Upon successful completion, the page displays the message **Cellular Firmware carrier change completed**.

Multi-carrier capable models ship with cellular modem firmware for each supported carrier pre-loaded onto internal non-volatile or USB storage. Periodically, new cellular modem firmware becomes available and is published on the Opengear download site.

To download and apply new cellular firmware using the UI:

1. For devices with multi-carrier capability, the **System > Firmware** page shows a second section with local cellular firmware image status and a button to start the firmware update process.
2. The **Cellular Firmware Status** indicates the date of the last firmware download, and a cryptographic fingerprint that can be used to verify the local files' integrity against the fingerprint published in the Opengear Knowledge Base site.
3. Click the **Check for Update** button to step through the upgrade process. This process contacts the remote server (ftp.opengear.com) and displays an update summary.
4. The update summary indicates the local and remote fingerprints for comparison, without altering any of the local files. The **Advanced** section, when expanded, shows a full list of files to be downloaded or deleted, along with their SHA1 hashes. Temporary files downloaded during the initial **Check for Updates** check may be listed as files to copy into place, as they do not have to be re-downloaded.

Cellular Modem Firmware

Modem Firmware Status Updated firmware available.

Local repository fingerprint: `abca48a325bedbfe50dbc686477f1685b0fc636b`
Updated repository fingerprint: `abca48a325bedbfe50dbc686477f1685b0fc636b`

Before upgrading, ensure the updated fingerprint matches that of the remote repository. Repository fingerprints are published on the Knowledge Base site. Downloading firmware may use a significant amount of data (>100MB).

Advanced

Local storage repository will be synced from the remote repository:

Action	SHA1 Checksum	Filename
keep	19c05fa670cd4558623315c70c81da2e5d6b5d37	SWI9X30C_02.24.05.06_cwe
keep	4a3a8524483e52b1db8b1a6d6ae764a3eda328ab	SWI9X30C_02.24.05.06_DOCOMO_001.007_000.nvu
keep	d34b457c69f728185ffad153116d1d228efacc63	SWI9X30C_02.24.05.06_KDDI_001.005_000.nvu
keep	cdf845545b5188cdcae31f1b1da3fd793f11d74	SWI9X30C_02.24.05.06_Softbank_001.006_000.nvu
keep	054ce66e0c7ad78a77a2a1eda74adb536d157148	SWI9X30C_02.24.05.06_TELSTRA_002.026_000.nvu
keep	91aa6e6c48f3abb85b57876bd6cfc74e525a5ba9	SWI9X30C_02.27.01.00_cwe
keep	2cc1a0b96e080b5725476c6f6c6614ac29d89058	SWI9X30C_02.27.01.00_GENERIC_002.029_000.nvu
keep	b24c64eb07c3ec7b9e54ce29b5831813b30cf0f6	carrier-canon.txt
keep	ae06ab61ef944012907913686c951b44a5a800b2	carriers.txt
keep	fcd3ea88b67b18ea30e48c7fe192b9d72949a1a8	cell-firmware.txt
keep	-	localfiles.txt
copy	-	localdb.txt
keep	-	SHA1SUMS

Download and Upgrade

Cancel

5. Click **Download and Apply** to start the update. The modem is only flashed if new firmware is available for the selected carrier. You can click **Cancel** to reject the update.
6. During the download/apply, an interstitial screen is displayed, showing upgrading cellular modem firmware. When completed, the **System > Firmware** page displays the status of the firmware update.
7. To automate this operation, enable the **Automatic Cellular Modem Firmware Check and Upgrade** option. This allows the user to schedule these checks on a daily, weekly, or monthly schedule, and specify the time of day the check runs. If new firmware is found, the device downloads and applies it.

Automated Cellular Modem Firmware Check and Upgrade

Check Enabled

Check Frequency
The Weekly and Monthly checks will occur on the first day of the week (Sunday) and the first day of the month.

Check Time

Apply Automated Check and Upgrade

4.7 Cellular Operation

When set up as a console server the 3G cellular modem can be set up to connect to the carrier in either:

- Cellular router mode. In this case the dial-out connection to the carrier cellular network is always on, and IP traffic is routed between the cellular connected network and the console server's local network ports.
- OOB mode. As above in this mode the dial-out connection to the carrier cellular network is always on - awaiting any incoming access (from a remote site wanting to access to the console server or attached serial consoles/network hosts)
- Failover mode. In this case a dial-out cellular connection is only established in event of a ping failure
- Circuit Switched Data (CSD) mode. In this dial-in mode the cellular modem can receive incoming calls from remote modems who dial a special Data Terminating number. This is a 3G mode only.

4.7.1 OOB access set up

In this mode the dial-out connection to the carrier cellular network is always on, awaiting any incoming traffic. By default, the only traffic enabled are incoming SSH access to the console server and its serial ports and incoming HTTPS access to the console server. There is a low level of keep alive and management traffic going over the cellular network. Generally, the status reports and alerts from the site can be carried over the main network.

This mode is used for out of band access to remote sites. This OOB mode is the default for IM7200 appliances with internal cellular modems. Out-of-Band access is enabled by default and the cellular modem connection is always on.

To be accessed, the console server needs to have a Public IP address and it must not have SSH access firewalled.

Almost all carriers offer corporate mobile data service/plans with a Public IP address. These plans often have a service fee attached.

- If you have a static Public IP address plan you can also try accessing the console server using the Public IP Address provided by the carrier. By default, only HTTPS and SSH access is enabled on the OOB connection. You can browse to the console server, but you cannot ping it
- If you have a dynamic Public IP address plan, a DDNS service needs to be configured to enable the remote administrator to initiate incoming access. Once this is done you can try accessing the console server using the allocated domain name

Most providers offer a consumer grade service which provides dynamic Private IP address assignments to 3G devices. This IP address is not visible across the Internet, but it is adequate for home and general business use.

- With this service, the **Failover & Out-of-Band** tab on the **Status > Statistics** shows that your carrier has allocated you a Private IP Address (i.e. in the range 10.0.0.0 – 10.255.255.255, 172.16.0.0 – 172.31.255.255 or 192.168.0.0 – 192.168.255.255)

The screenshot shows a configuration page titled "Automated Cellular Modem Firmware Check and Upgrade". It contains three main sections: "Check Enabled" with an unchecked checkbox, "Check Frequency" with a dropdown menu set to "Weekly" and a note stating "The Weekly and Monthly checks will occur on the first day of the week (Sunday) and the first day of the month.", and "Check Time" with a dropdown menu set to "8 PM". At the bottom, there is a button labeled "Apply Automated Check and Upgrade".

User Manual

- For inbound OOB connection with this service, use Call Home with a Lighthouse/VCMS/CMS6110 or set up a VPN

In out of band access mode the internal cellular modem stays connected. The alternative is to set up Failover mode on the console server as detailed in the next section.

4.7.2 Cellular failover setup

In this mode, the appliance continually pings nominated probe addresses over the main network connection. In the event of ping failure, it dials out and sets up a dial-out PPP over the cellular modem and access is switched to this network connection. When the main network connection is restored, access is switched back.

This dial-out cellular connection is established in event of disruption to the main network. The cellular connection remains idle and is only activated in event of a ping failure. This standby mode can suit remote sites with expensive power or cellular traffic costs.

Once you have set up a carrier connection, the cellular modem can be configured for failover.

This tells the cellular connection to remain idle in a low power state. If the primary and secondary probe addresses are not available, it brings up the cellular connection and connects back to the cellular carrier.

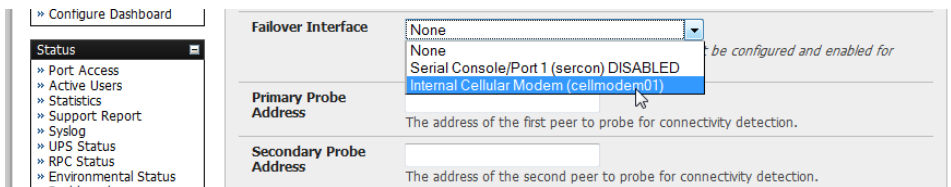

1. Navigate back to the **Network Interface** on the **System > IP** menu specify **Internal Cellular modem (cell modem 01)** as the **Failover Interface** to be used when a fault has been detected
2. Specify the **Probe Addresses** of two sites (the **Primary** and **Secondary**) that the console server is to ping to determine if the principal network is operational
3. In event of a failure of the principal network the 3G network connection is activated as the access path to the console server and managed devices. Only HTTPS and SSH access is enabled on the failover connection (which should enable an administrator to connect and fix the problem)

NOTE By default, the console server supports automatic failure-recovery back to the original state prior to failover. The console server continually pings probe addresses while in original and failover states. The original state is reestablished after three successful pings of the probe addresses during failover. The failover state is removed once the original state has been re-established.

You can check the connection status by selecting the Cellular panel on the **Status > Statistics** menu

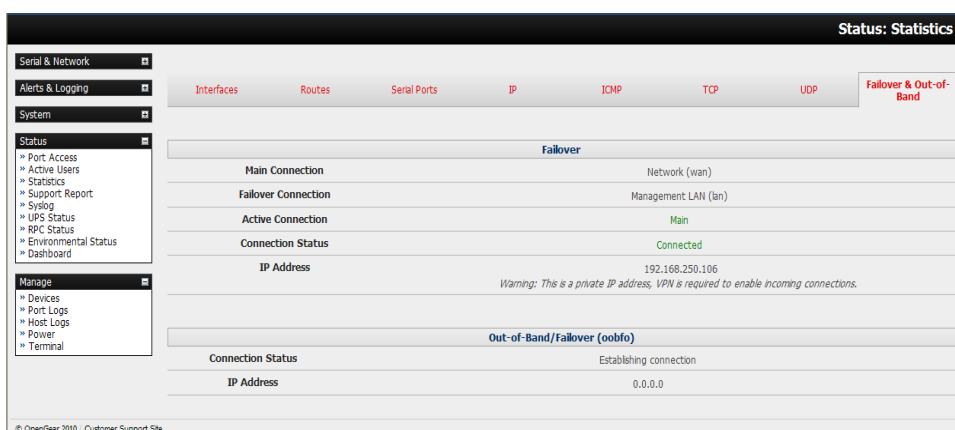

The Operational Status changes as the cellular modem finds a channel and connects to the network

The **Failover & Out-of-Band** screen displays information relating to a configured Failover/OOB interface and the status of that connection. The IP Address of the Failover / OOB interface is presented in the **Failover & Out-of-Band** screen when the Failover/OOB interface is triggered

4.7.3 Cellular routing

Once you have configured carrier connection, the cellular modem can be configured to route traffic through the console server. This requires setting up forwarding and masquerading as detailed in Chapter 4.8.

4.7.4 Cellular CSD dial-in setup

Once you have configured carrier connection, the cellular modem can be configured to receive Circuit Switched Data (CSD) calls, a legacy form of data transmission developed for the TDMA based mobile phone systems like GSM.

NOTE CSD is provided selectively by carriers and it is important you receive a Data Terminating number as part of the mobile service your carrier provides. This is the number which external modems call to access the console server

1. Select the **Cellular Modem** panel on the **System > Dial** menu
2. Check **Enable Dial-In** and configure the **Dial-In Settings**

4.8 Firewall & Forwarding

OpenGear console servers have basic routing, NAT (Network Address Translation), packet filtering and port forwarding support on all network interfaces.

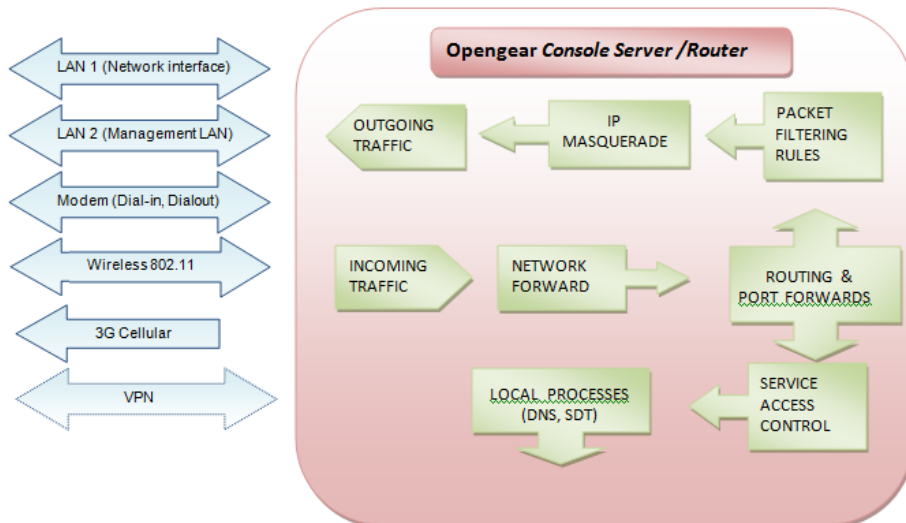

This enables the console server to function as an Internet or external network gateway, via cellular connections or via other Ethernet networks on two Ethernet port models:

- **Network Forwarding** allows the network packets on one network interface (i.e. LAN1 / eth0) to be forwarded to another network interface (i.e. LAN2/eth1 or dial-out/cellular). Locally networked devices can IP connect through the console server to devices on remote networks
- **IP Masquerading** is used to allow all the devices on your local private network to hide behind and share the one public IP address when connecting to a public network. This type of translation is only used for connections originating within the private network destined for the outside public network, and each outbound connection is maintained by using a different source IP port number
- When using IP Masquerading, devices on the external network cannot initiate connections to devices on the internal network. **Port Forwards** allows external users to connect to a specific port on the external interface of the console server and be redirected to a specified internal address for a device on the internal network
- With **Firewall Rules**, packet filtering inspects each packet passing through the firewall and accepts or rejects it based on user-defined rules
- Then **Service Access Rules** can be set for connecting to the console server/router

4.8.1 Configuring network forwarding and IP masquerading

To use a console server as an Internet or external network gateway requires establishing an external network connection and setting up forwarding and masquerading.

NOTE Network forwarding allows the network packets on one network interface (i.e. LAN1 / eth0) to be forwarded to another network interface (i.e. LAN2/eth1 or dial-out/cellular). Locally networked devices can IP connect through the console server to devices on a remote network. IP masquerading is used to allow all the devices on your local private network to hide behind and share the one public IP address when connecting to a public network. This type of translation is only used for connections originating within the private network destined for the outside public network, and each outbound connection is maintained by using a different source IP port number.

Console servers are configured so that they will not route traffic between networks. To use the console server as an Internet or external network gateway, forwarding must be enabled so that traffic can be routed from the internal network to the Internet/external network:

1. Navigate to the **System > Firewall** page, and click on the **Forwarding & Masquerading** tab

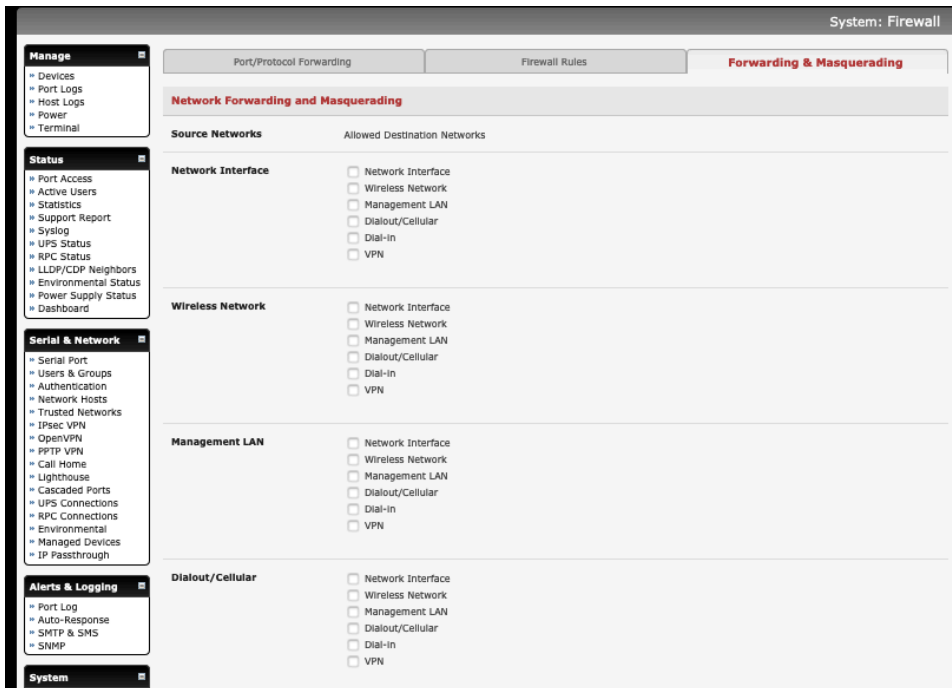

2. Find the **Source Network** to be routed, and tick the relevant **Destination Network** to enable Forwarding

IP Masquerading is required if the console server is routing to the Internet or if the external network being routed to does not have routing information about the internal network behind the console server.

IP Masquerading performs Source Network Address Translation (SNAT) on outgoing packets, to make them appear like they've come from the console server (rather than devices on the internal network). When response packets come back devices on the external network, the console server translates the packet address back to the internal IP, so that it is routed correctly. This allows the console server to provide full outgoing connectivity for internal devices using a single IP Address on the external network.

By default, IP Masquerading is disabled for all networks. To enable masquerading:

1. Select **Forwarding & Masquerading** panel on the **System > Firewall** menu.
2. Check **Enable IP Masquerading (SNAT)** on the network interfaces where masquerading is enabled.

This masquerading would be applied to any interface that is connecting with a public network such as the Internet.

Enable IP Masquerading (SNAT)

Network Interface
 Wireless Network
 Management LAN
 Dialout/Cellular
 Dial-In
 VPN

IP Masquerading is used to translate private network traffic onto public networks such as the Internet. This is generally required when using the interface as an Internet gateway.

4.8.2 Configuring client devices

Client devices on the local network must be configured with Gateway and DNS settings. This can be done statically on each device or using DHCP (on IM and ACM models).

Manual Configuration:

Manually set a static gateway address (being the address of the console server) and set the DNS server address to be the same as used on the external network i.e. if the console server is acting as an internet gateway or a cellular router. Use the ISP provided DNS server address.

DHCP Configuration (IM/ACM families only):

1. Navigate to the **System > IP** page
2. Click the tab of the interface connected to the internal network. To use DHCP, a static address must be set. Check that the static IP and subnet mask fields are set.

The screenshot shows the 'System: IP' configuration page. On the left is a navigation menu with sections: Manage (Devices, Port Logs, Host Logs, Power, Terminal), Status (Port Access, Active Users, Statistics, Support Report, Syslog, UPS Status, RPC Status, LLDP/CDP Neighbors, Environmental Status, Power Supply Status, Dashboard), Serial & Network (Serial Port, Users & Groups, Authentication, Network Hosts, Trusted Networks, IPsec VPN, OpenVPN, PPTP VPN, Call Home, Lighthouse, Cascaded Ports, UPS Connections, RPC Connections, Environmental, Managed Devices, IP Passthrough), Alerts & Logging (Port Log, Auto-Response, SMTP & SMS, SNMP), and System. The main content area is titled 'Network Interface' and has tabs for 'Wireless Network Interface', 'Management LAN Interface', 'General Settings', and 'Route Settings'. Under 'IP Settings: Network', the 'Configuration Method' is set to 'Static'. The 'IP Address' is 192.168.254.35, 'Subnet Mask' is 255.255.255.0, and 'Gateway' is 192.168.254.254. 'DNS Search Domain', 'Primary DNS', and 'Secondary DNS' are empty. 'Media' is set to 'Auto' and 'MTU' is empty. The 'DHCP Server' is currently 'Disabled'.

3. Click on the **Disabled** link next to **DHCP Server** which brings up the **System > DHCP Server** page

Network Interface	Management LAN Interface	Wireless Network Interface
Network DHCP Server Settings (Subnet 10.250.241.0 / 255.255.255.0)		
DHCP Server	<input type="checkbox"/> Enable DHCP Server	
Gateway	<input type="text"/> <small>The Default Gateway to assign.</small>	
Use interface address as gateway	<input type="checkbox"/> Use this interface as the DHCP Gateway.	
Primary DNS	<input type="text"/> <small>The primary DNS to assign.</small>	
Secondary DNS	<input type="text"/> <small>The secondary DNS to assign.</small>	
Use this interface address as the DNS server	<input type="checkbox"/> Use the built-in DNS relay for DNS lookups. <small>The DNS service must be enabled on the Services page</small>	
Domain Name	<input type="text"/> <small>The Domain Name to assign.</small>	
Default Lease	<input type="text"/> <small>The Default Lease Time In Seconds.</small>	
Maximum Lease	<input type="text"/> <small>The Maximum Lease Time In Seconds.</small>	
<input type="button" value="Apply"/>		

4. Check **Enable DHCP Server**
5. To configure the DHCP server, tick the **Use interface address as gateway check box**
6. Set the DNS server address to be the same as used on the external network, i.e. if the console server is acting as an internet gateway or a cellular router. Use the ISP provided DNS server address
7. Enter the **Default Lease** time and **Maximum Lease** time in seconds. The lease time is the time that a dynamically assigned IP address is valid before the client must request it again
8. Click **Apply**

The DHCP server sequentially issues IP addresses from a specified address pool(s):

1. Click **Add** in the **Dynamic Address Allocation Pools** field
2. Enter the **DHCP Pool Start Address** and **End Address**.
3. Click **Apply**

Network Interface	Management LAN Interface	Wireless Network Interface
Dynamically Allocated Pool		
DHCP Pool Start Address	<input type="text"/> <small>The first address in the pool to use for DHCP.</small>	
DHCP Pool End Address	<input type="text"/> <small>The last address in the pool to use for DHCP.</small>	
<input type="button" value="Apply"/>		

User Manual

The DHCP server also supports pre-assigning IP addresses to be allocated only to specific MAC addresses and reserving IP addresses to be used by connected hosts with fixed IP addresses. To reserve an IP addresses for a particular host.

Once applied, devices on the internal network can access resources on the external network.

4.8.3 Port / Protocol forwarding

When using IP Masquerading, devices on the external network cannot initiate connections to devices on the internal network.

To work around this, Port Forwards can be set up to allow external users to connect to a specific port, or range of ports on the external interface of the console server/cellular router and have the console server/cellular router redirect the data to a specified internal address and port range.

Port/Protocol Forwarding Firewall Rules Forwarding & Masquerading

Create/Modify Port/Protocol Forward

Name
Name for the rule

Interface
The interface that the rule applies to

Source Address/Address Range
The source IP address or IP address range of the data. This may be left blank. IP address ranges use the format ip/netmask (where netmask is in bits 1-32)

Destination Address/Address Range
The destination IP address/address range to match. This may be left blank. IP address ranges use the format ip/netmask (where netmask is in bits 1-32)

Input Port Range
A port or range of ports. Ranges use the format start-finish. Only valid for TCP and UDP protocols

Protocol
The protocol of the data

Output Address
The IP address that the data should be redirected to

Output Port Range
A port or range of ports. Ranges use the format start-finish. Only valid for TCP and UDP protocols

To setup a port/protocol forward:

1. Navigate to the **System > Firewall** page, and click on the **Port Forwarding** tab
2. Click **Add New Port Forward**
3. Fill in the following fields:

Name: Name for the port forward. This should describe the target and the service that the port forward is used to access

Input Interface: This allows the user to only forward the port from a specific interface. In most cases, this should be left as **Any**

Source Address/Address: Range Restrict access to a port forward to a specific source IP address or IP address range of the data. This may be left blank. IP address ranges use the format ip/netmask (where netmask is in bits 1-32)

Destination Address/Address Range: The destination IP address/address range to match. This may be left blank IP address ranges use the format ip/netmask (where netmask is in bits 1-32)

Input Port Range: The range of ports to forward to the destination IP. These will be the port(s) specified when accessing the port forward. These ports need not be the same as the output port range.

Protocol: The protocol of the data being forwarded. The options are **TCP, UDP, TCP and UDP, ICMP, ESP, GRE, or Any.**

Output Address: The target of the port forward. This is an address on the internal network where packets sent to the Input Interface on the input port range are sent.

Output Port Range: The port or range of ports that the packets will be redirected to on the Output Address. Ranges use the format start-finish. Only valid for TCP and UDP protocols

For example, to forward port 8443 to an internal HTTPS server on 192.168.10.2, the following settings would be used:

Input Interface: Any

Input Port Range: 8443

Protocol: TCP

Output Address: 192.168.10.2

Output Port Range: 443

4.8.4 Firewall rules

Firewall rules can be used to block or allow traffic through an interface based on port number, the source and/or destination IP address (range), the direction (ingress or egress) and the protocol. This can be used to allow custom on-box services, or block traffic based on policy.

To setup a firewall rule:

1. Navigate to the **System > Firewall** page, and click on the **Firewall Rules** tab

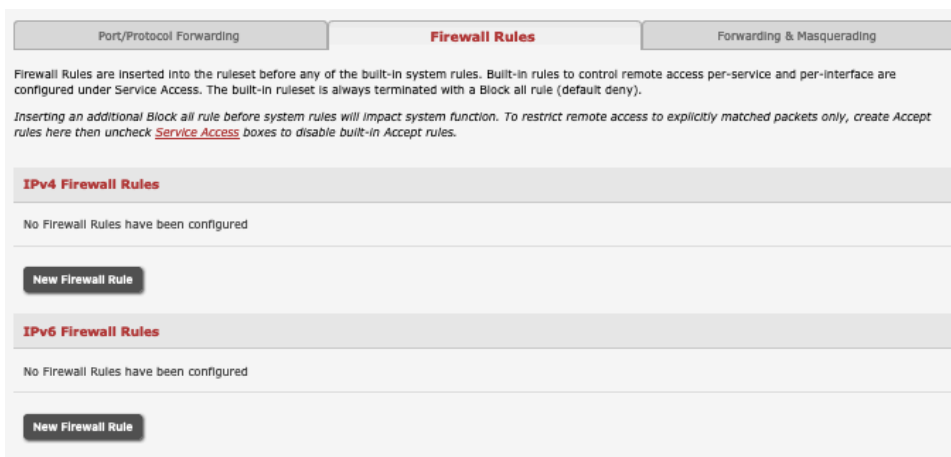

2. Click **New Firewall Rule**

Port/Protocol Forwarding **Firewall Rules** Forwarding & Masquerading

Create/Modify Firewall Rule - IPv4

Name
Name for the rule

Interface
The interface that the rule applies to

Destination Port/Port Range
A port or range of ports.
Ranges use the format start-finish.
Only valid for TCP and UDP protocols

Source MAC address
The source MAC address to match. This may be left blank
MAC addresses use the following format XX:XX:XX:XX:XX:XX (where XX are hex digits)

Source Address/Address Range
The source IP address/address range to match. This may be left blank
IP address ranges use the format ip/netmask (where netmask is in bits 1-32)

Destination Address/Address Range
The destination IP address/address range to match. This may be left blank
IP address ranges use the format ip/netmask (where netmask is in bits 1-32)

Protocol
The protocol of the data

Direction
The direction of the data that the rule applies to

Connection State
Connection tracking state for the packet

Action
The action to undertake

3. Fill in the following fields:

- Name:** Name the rule. This name should describe the policy the firewall rule is being used to implement (e.g. block ftp, Allow Tony)
- Interface:** The interface that the firewall rule applies to (i.e. Any, Dialout/Cellular, VPN, Network Interface, Dial-in etc)
- Port Range:** Specifies the Port or range of Ports (e.g. 1000 – 1500) that the rule applies to. This may be left blank for Any
- Source MAC address:** Specifies the source MAC address to be matched. This may be left blank for any. MAC addresses use the format XX:XX:XX:XX:XX:XX, where XX are hex digits
- Source Address Range:** Specifies the source IP address (or address range) to match. IP address ranges use the format ip/netmask (where netmask is in bits 1-32). This may be left blank for Any
- Destination Range:** Specifies the destination IP address/address range to match. IP address ranges use the format ip/netmask (where netmask is in bits 1-32). This may be left blank.
- Protocol:** Select if the firewall rule applies to **TCP, UDP, TCP and UDP, ICMP, ESP, GRE, or Any**
- Direction:** The traffic direction that the firewall rule applies to (Ingress = incoming or Egress)

- Connection State:** The state of connections that the firewall rule applies to (Any, Related/Established, or New). This can be used to only allow established connections out an interface.
- Action:** The action (**Accept** or **Block**) that applies to the packets detected that match the Interface+ Port Range+ Source/destination Address Range+ Protocol+ Direction

For example, to block all SSH traffic from leaving Dialout Interface, the following settings can be used:

Interface: Dialout/Cellular
 Port Range: 22
 Protocol: TCP
 Direction: Egress
 Action: Block

The firewall rules are processed in a set order from top to bottom. For example, with the following rules, all traffic coming in over the Network Interface is blocked except when it comes from two nominated IP addresses (SysAdmin and Tony):

	To allow all incoming traffic on all interfaces from the SysAdmin:	To allow all incoming traffic from Tony:	To block all incoming traffic from the Network Interface:
Interface	Any	Any	Network Interface
Port Range	Any	Any	Any
Source MAC	Any	Any	Any
Source IP	IP address of SysAdmin	IP address of Tony	Any
Destination IP	Any	Any	Any
Protocol	TCP	TCP	TCP
Direction	Ingress	Ingress	Ingress
Action	Accept	Accept	Block

Firewall Rules											
Name	Interface	Protocol	Destination Port/Port Range	Source Address/Address Range	Destination Address/Address Range	Direction	Action	Rule Order	Modify	Delete	
Allow Sys Admin	any	tcp	Any	192.168.0.0/16	Any	ingress	accept	↓			
Allow Tony	any	tcp	Any	10.0.0.0/8	Any	ingress	accept	↑↓			
Block Everyone Else	wan	tcp	Any	Any	Any	ingress	block	↑			

[New Firewall Rule](#)

If the **Rule Order** above is changed so the **Block Everyone Else** rule is second on the list, the traffic coming in over the Network Interface from Tony would be blocked.

5 SSH TUNNELS & SDT CONNECTOR

Each Opengear console server has an embedded SSH server and uses SSH tunneling so remote users can securely connect through the console server to managed devices - using text-based console tools (such as SSH, Telnet, SoL) or graphical tools (like VNC, RDP, HTTPS, HTTP, X11, VMware, DRAC, iLO).

The managed devices being accessed can be located on the same local network as the console server or they can be attached to the console server via a serial port. The remote user connects to the console server thru an SSH tunnel via dial-up, wireless or ISDN modem; a broadband Internet connection; the enterprise VPN network or the local network:

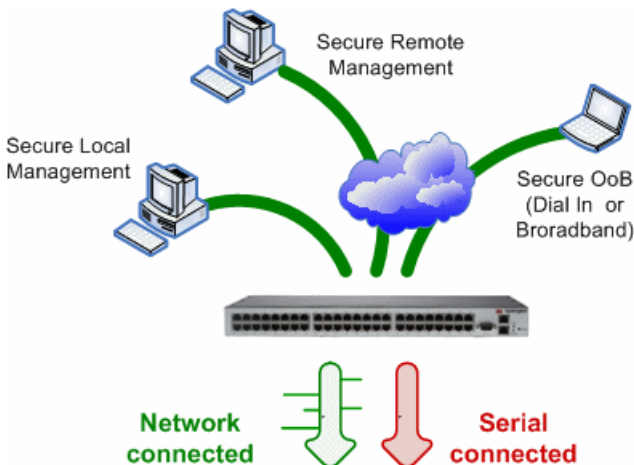

To set up the secure SSH tunnel from the Client PC to the console server, you must install and launch SSH client software on the user's PC. Opengear recommends you use the SDT Connector client software that is supplied with the console server for this. SDT Connector is easy to install and auto-configure and it provides all your users with point-and-click access to all the systems and devices in the secure network.

SDT Connector sets up a secure SSH tunnel from the client to the selected console server, establishes a port forward connection to the target network connected host or serial connected device, and executes the client application that is used in communicating with the host.

Topics in this chapter:

- Configuring the console server for SSH tunneled access to network attached hosts and setting up permitted Services and user access
- Setting up the SDT Connector client with gateway, host, service and client application details and making connections between the Client PC and hosts connected to the console server
- Using SDT Connector to browser access the Management Console
- Using SDT Connector to Telnet or SSH connect to devices that are serially attached to the console server
- Using SDT Connector for out of band access
- Automatic importing and exporting of configurations
- Configuring Public Key Authentication
- Setting up an SDT Secure Tunnel for Remote Desktop
- Setting up an SDT Secure Tunnel for VNC
- Using SDT to IP connect to hosts that are serially attached to the console server

5.1 Configuring for SSH Tunneling to Hosts

To set up the console server for SSH tunneled access a network attached host, add the new host and the permitted services using the **Serial & Network > Network Hosts** menu as detailed in *Network Hosts*. Only these permitted services are forwarded through by SSH to the host. All other services (TCP/UDP ports) are blocked.

Some of the TCP Ports used by SDT in the console server:

- 22 SSH (All SDT Tunneled connections)
- 23 Telnet on local LAN (forwarded inside tunnel)
- 80 HTTP on local LAN (forwarded inside tunnel)
- 3389 RDP on local LAN (forwarded inside tunnel)
- 5900 VNC on local LAN (forwarded inside tunnel)
- 73XX RDP over serial from local LAN – where XX is the serial port number (i.e. 7301 to 7348 on a 48 port console server)
- 79XX VNC over serial from local LAN – where XX is the serial port number



Add new users using **Serial & Network > Users & Groups** menu as detailed in *Network Hosts*. Users can be authorized to access the console server ports and specified network-attached hosts. To simplify configuration, an administrator can first set up groups with group access permissions, users can be classified as members of particular groups.

5.2 SDT Connector Client Configuration

The SDT Connector client works with all Opengear console servers. Each of these remote console servers have an embedded OpenSSH based server which can be configured to port forward connections from the SDT Connector client to hosts on their local network as detailed in the previous chapter. The SDT Connector can also be pre-configured with the access tools and applications that are available to run when access to a particular host has been established.

SDT Connector can connect to the console server using an alternate OOB access. It can also access the console server and access devices connected to serial ports on the console server.

To operate SDT Connector, add new gateways to the client software by entering the access details for each console server and let the client auto-configure with all host and serial port connections from each console server. Point-and-click to connect to the Hosts and serial devices.

Or you can add network connected hosts and configure new services to be used in accessing the console server and the hosts and configure clients to run on the PC that uses the service to connect to the hosts

User Manual

and serial port devices. SDT Connector can also be set up to make an out-of-band connection to the console server.

5.2.1 Configuring a new gateway in the SDT Connector client

To create a secure SSH tunnel to a new console server:

1. Click the New Gateway  icon or select **File > New Gateway**

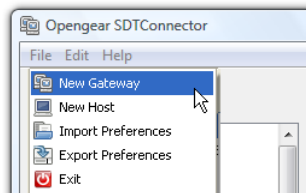

2. Enter the IP or DNS **Address** of the console server and the SSH port

NOTE If SDT Connector is connecting to a remote console server through the public Internet or routed network:

- Determine the public IP address of the console server (or of the router / firewall that connects the console server to the Internet) as assigned by the ISP. One way to find the public IP address is to access / or / from a computer on the same network as the console server and note the reported IP address
- Set port forwarding for TCP port 22 through any firewall/NAT/router that is located between SDT Connector and the console server so it points to the console server.
<http://www.portforward.com> has port forwarding instructions for a range of routers. Also you can use the Open Port Check tool from <http://www.canyouseeme.org> to check if port forwarding through local firewall/NAT/router devices has been properly configured

3. Enter the **Username** and **Password** of a user on the gateway that has been enabled to connect via SSH and/or create SSH port redirections

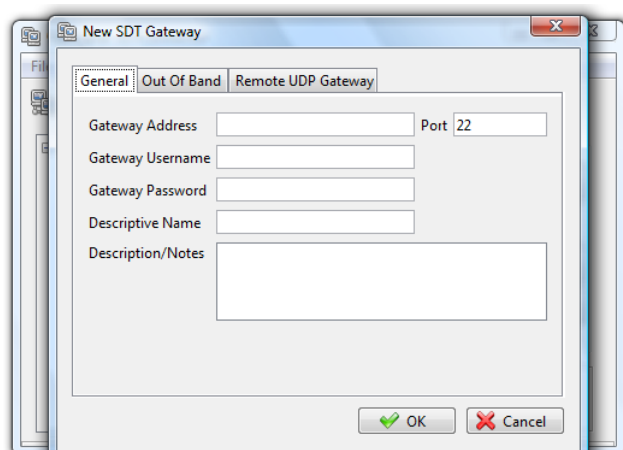

4. Optionally, enter a **Descriptive Name** to display instead of the IP or DNS address, and **NOTES** or a **Description** of this gateway (such as its site location or anything special about its network configuration).
5. Click **OK**. An icon for the new gateway appears in the SDT Connector home page

NOTE For an SDT Connector user to access a console server and access specific hosts or serial devices connected to that console server, that user must first be setup on the console server, and must be authorized to access the specific ports / hosts. Only these permitted services are forwarded through by SSH to the Host. All other services (TCP/UDP ports) are blocked.

5.2.2 Auto-configure SDT Connector client with the user's access privileges

Each user on the console server has an access profile which has been configured with those specific connected hosts and serial port devices the user has authority to access, and a specific set of the enabled services for each of these. This configuration can be auto-uploaded into the SDT Connector client:

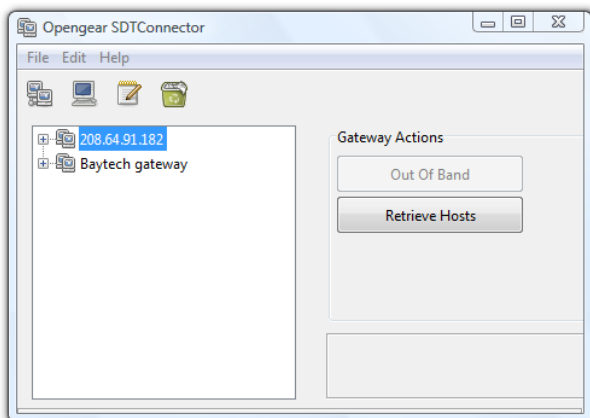

Click on the new gateway icon and select **Retrieve Hosts**. This will:

- configure access to network connected Hosts that the user is authorized to access and set up (for each of these Hosts) the services (e.g. HTTPS, IPMI2.0) and the related IP ports being redirected
- configure access to the console server (this is shown as a Local Services host)
- configure access with the enabled services for the serial port devices connected to the console server

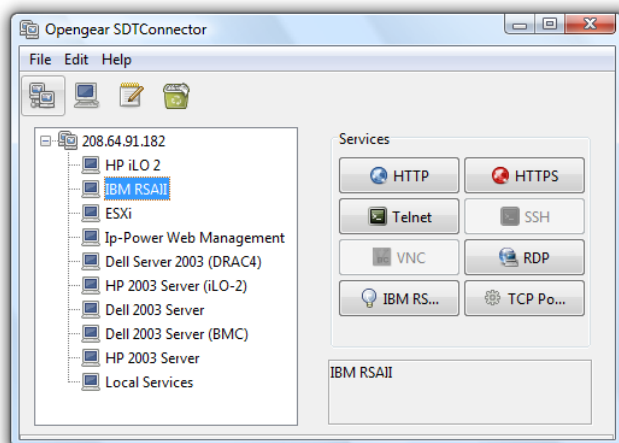

NOTE The Retrieve Hosts function auto-configures all classes of user (i.e. they can be members of user or admin or some other group or no group). SDT Connector will not auto-configure the root

5.2.3 Make an SDT connection through the gateway to a host

Point at the host to be accessed and click on the service to be used in accessing that host. The SSH tunnel to the gateway is established, the appropriate ports redirected through to the host, and the appropriate local client application is launched pointing at the local endpoint of the redirection:

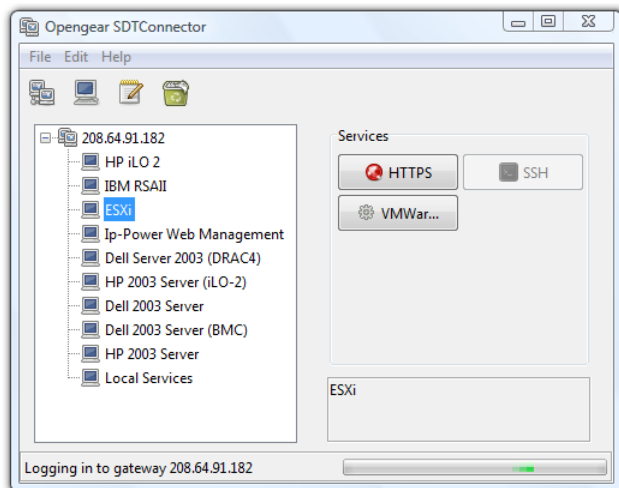

NOTE The SDT Connector client can be configured with unlimited number of Gateways. Each Gateway can be configured to port forward to an unlimited number of locally networked Hosts. There is no limit on the number of SDT Connector clients who can be configured to access the one Gateway. Nor are there limits on the number of Host connections that an SDT Connector client can concurrently have open through the one Gateway tunnel.

5.2.4 Manually adding hosts to the SDT Connector gateway

For each gateway, you can specify the network connected hosts to be accessed through that console server; and for each host, specify the services used in communicating with the host

1. Select the newly added gateway and click the Host icon  to create a host to be accessible via this gateway. Or select **File > New Host**.

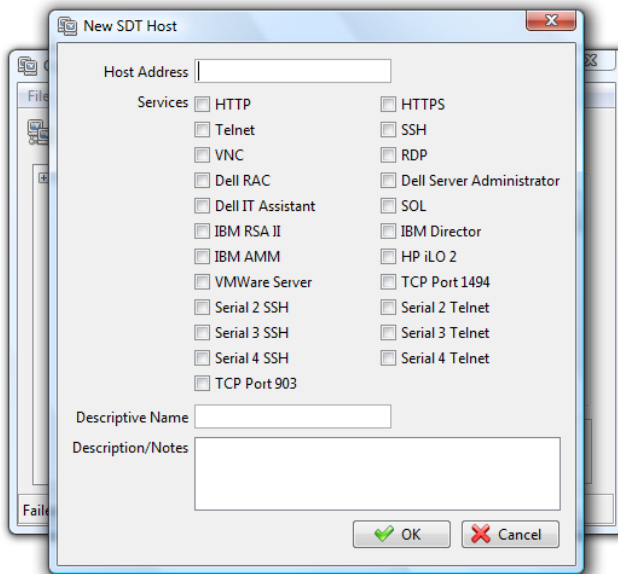

2. Enter the IP or DNS **Host Address** of the host. If this is a DNS address, it must be resolvable by the gateway.
3. Select which **Services** are to be used in accessing the new host. A range of service options are pre-configured in the default SDT Connector client (RDP, VNC, HTTP, HTTPS, Dell RAC, VMware etc).
If you wish to add new services, proceed to the next section (**Adding a new service**) and return here.
4. Optionally, enter a **Descriptive Name** for the host, to display instead of the IP or DNS address, and **Notes** or a **Description** of this host.
5. Click **OK**

5.2.5 Manually adding new services to the new hosts

To extend the range of services that can be used when accessing hosts with SDT Connector:

1. Select **Edit > Preferences** and click the **Services** tab. Click **Add**
2. Enter a **Service Name** and click **Add**
3. Under the **General** tab, enter the TCP Port that this service runs on (e.g. 80 for HTTP). Optionally, select the client to use to access the local endpoint of the redirection

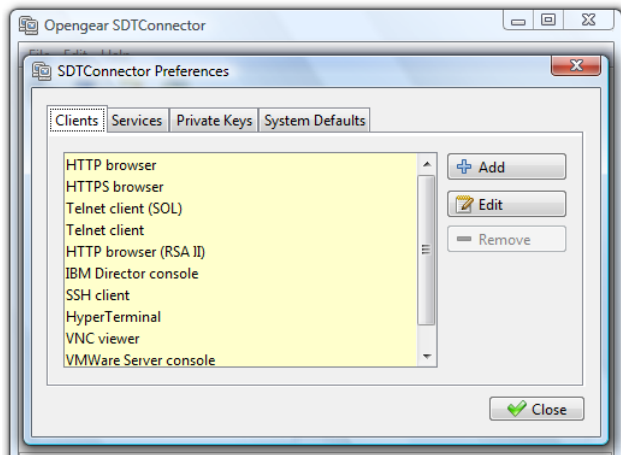

4. Select which **Client** application is associated with the new service. A range of client application options are pre-configured in the default SDT Connector (RDP client, VNC client, HTTP browser, HTTPS browser, Telnet client etc). If you wish to add new client applications to this range, proceed to the next section (**Adding a new client**) and return here.

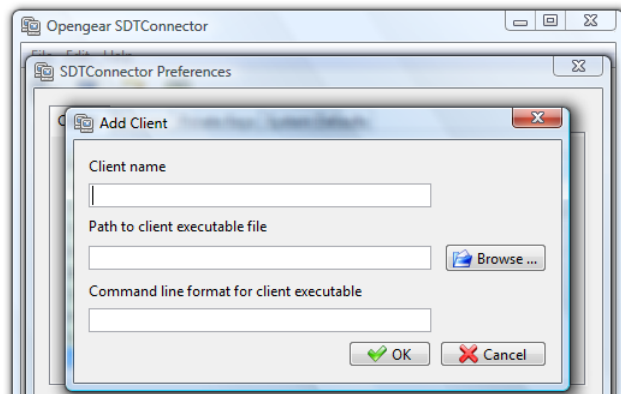

5. Click **OK**, and **Close**

A service consists of a single SSH port redirection and a local client to access it. It may consist of several redirections, some or all of with clients associated with them.

An example is the Dell RAC service. The first redirection is for the HTTPS connection to the RAC server - it has a client associated with it (web browser) that is launched upon clicking the button for this service.

The second redirection is for the VNC service that the user may choose to later launch from the RAC web console. It loads in a Java client served through the web browser, so it does not need a local client associated with it.

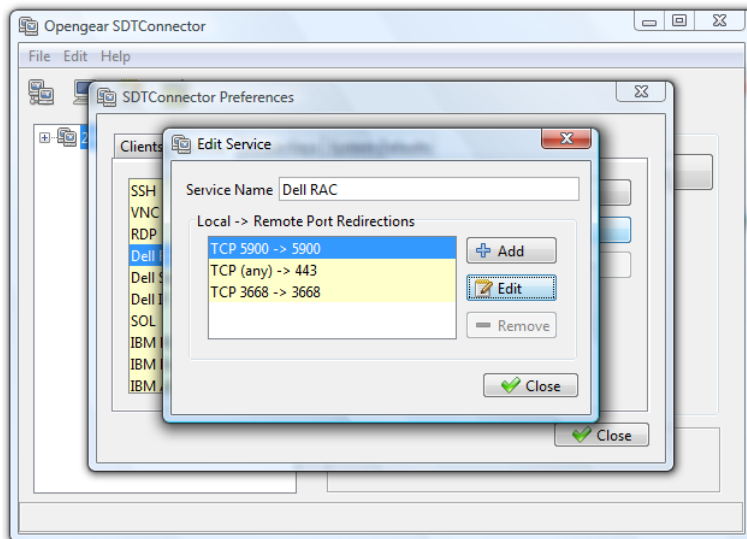

6. On the Add Service screen you can click **Add** as many times as needed to add multiple new port redirections and associated clients

You may also specify **Advanced** port redirection options:

7. Enter the local address to bind to when creating the local endpoint of the redirection. It is not usually necessary to change this from **localhost**.
8. Enter a local TCP port to bind to when creating the local endpoint of the redirection. If this is left blank, a random port is selected.

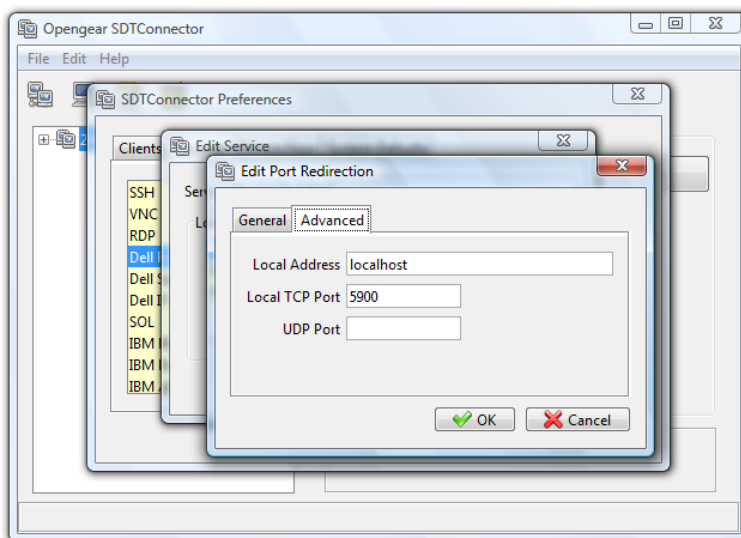

NOTE SDT Connector can also tunnel UDP services. SDT Connector tunnels the UDP traffic through the TCP SSH redirection, so in effect it is a tunnel within a tunnel.

Enter the UDP port on which the service is running on the host. This is also the local UDP port that SDT Connector binds as the local endpoint of the tunnel.

For UDP services, you need to specify a TCP port under General. This is an arbitrary TCP port that is not in use on the gateway. An example of this is the SOL Proxy service. It redirects local UDP port 623 to remote UDP port 623 over the arbitrary TCP port 6667

5.2.6 Adding a client program to be started for the new service

Clients are local applications that may be launched when a related service is clicked. To add to the pool of client programs:

1. Select **Edit > Preferences** and click the **Client** tab. Click **Add**

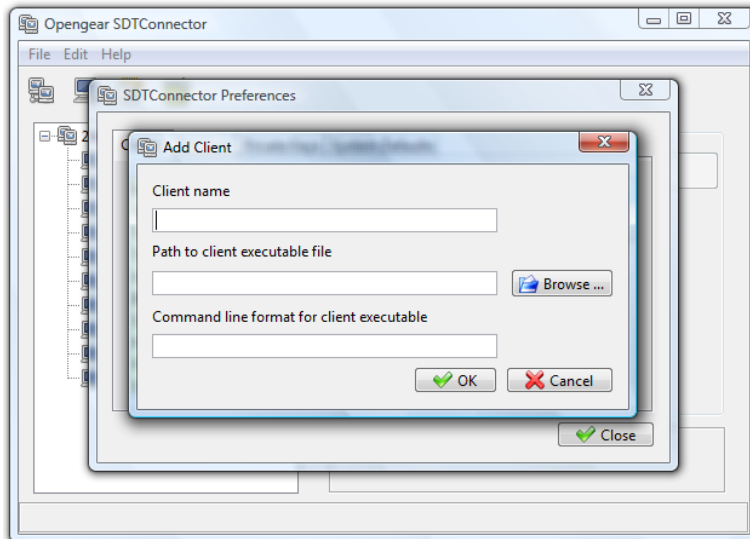

2. Enter a **Name** for the client. Enter the **Path** to the executable file for the client (or click **Browse** to locate the executable)
3. Enter a **Command Line** associated with launching the client application. SDT Connector launches a client using command line arguments to point it at the local endpoint of the redirection. There are three special keywords for specifying the command line format. When launching the client, SDT Connector substitutes these keywords with the appropriate values:

%path% is path to the executable file, i.e. the previous field.

%host% is the local address to which the local endpoint of the redirection is bound, i.e. the Local Address field for the Service redirection Advanced options.

%port% is the local port to which the local endpoint of the redirection is bound, i.e. the Local TCP Port field for the Service redirection Advanced options. If this port is unspecified (i.e. **Any**), the appropriate randomly selected port is substituted.

For example, SDT Connector is preconfigured for Windows installations with a HTTP service client that connects with whichever local browser the local Windows user has configured as the default. Otherwise the default browser used is Firefox:

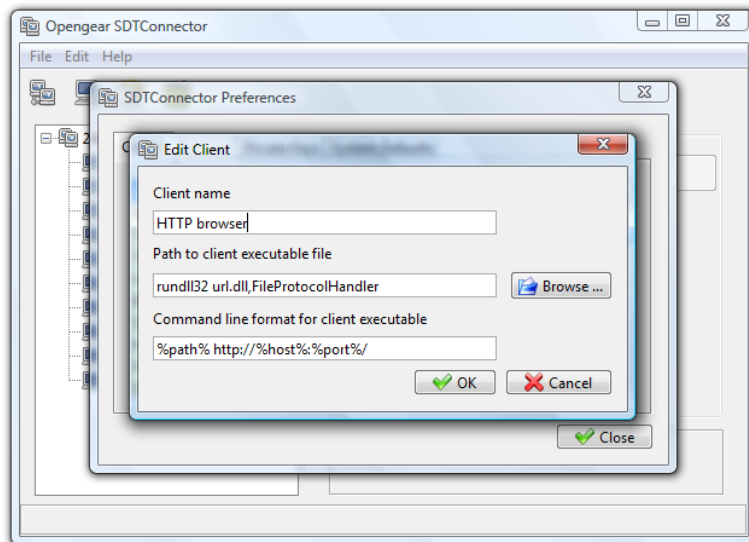

Some clients are launched in a command line or terminal window. The Telnet client is an example of this so the **Path to client executable file** is telnet and the **Command line format for client executable** is `cmd /c start %path% %host% %port%` :

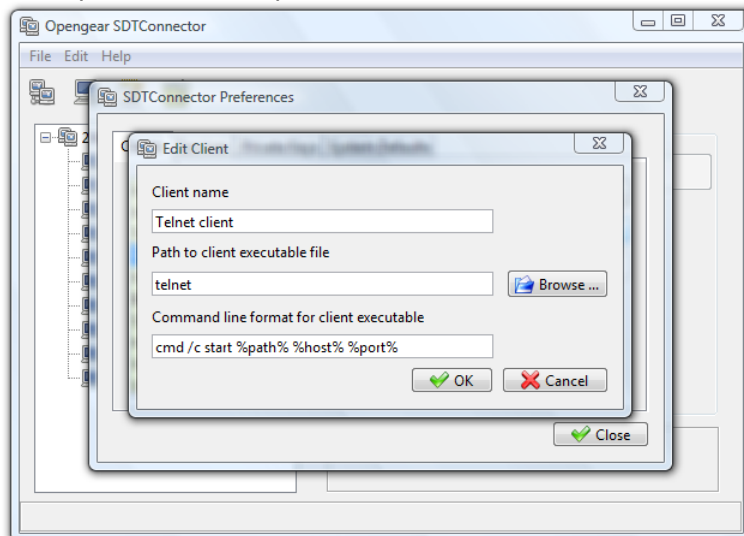

4. Click **OK**

5.2.7 Dial-in configuration

If the client PC is dialing into Local/Console port on the console server, here is how to set up a dial-in PPP link:

1. Configure the console server for dial-in access following the steps in the Configuring for Dial-In PPP Access section in Chapter 4.
2. Set up the PPP client software at the remote user PC following the Set up the remote Client section in Chapter 4.

Once you have a dial-in PPP connection established, you can set up the secure SSH tunnel from the remote Client PC to the console server.

5.3 SDT Connector to Management Console

SDT Connector can also be configured for browser access the gateway's Management Console – and for Telnet or SSH access to the gateway command line. For these connections to the gateway, you must configure SDT Connector to access the gateway by setting the Console server up as a host, and configuring the appropriate services:

1. Launch SDT Connector on your PC. Assuming you have already set up the console server as a Gateway in your SDT Connector client (with username / password etc) select this Gateway and click the Host icon to create a host, or select **File > New Host**
2. Enter 127.0.0.1 as the **Host Address** and give some details in **Descriptive Name/Notes**. Click OK

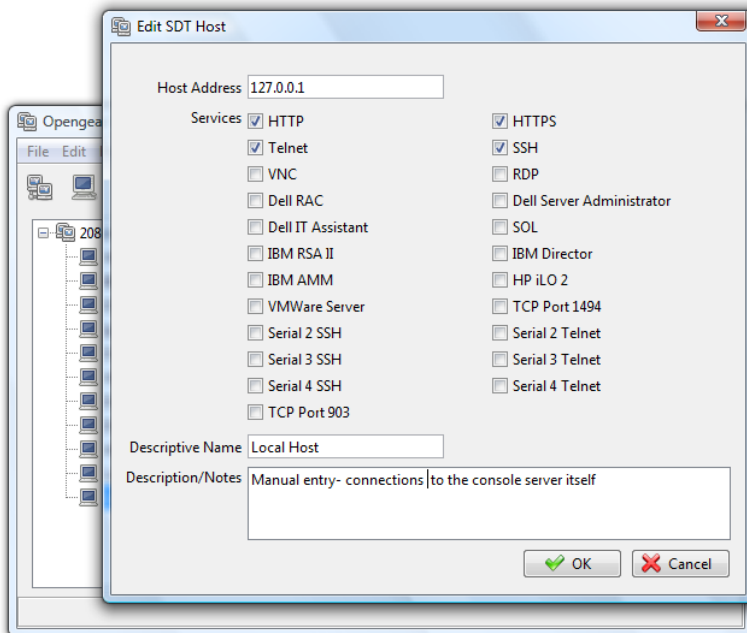

3. Click the **HTTP** or **HTTPS** Services icon to access the gateway's Management Console, and/or click **SSH** or **Telnet** to access the gateway command line console

NOTE To enable SDT access to the gateway console, you must configure the console server to allow port forwarded network access to itself.

Browse to the console server and select the **Service Access** tab on the **System > Firewall** menu. Ensure **SSH Command Shell** is enabled on the Network interface and any out of band interfaces.

For users to access the gateway Management Console, select **Users & Groups** from **Serial & Network**. Click **Add User**. Enter a **Username**, **Description** and **Password/Confirm**. Select 127.0.0.1 from **Accessible Host(s)** and click **Apply**

5.4 SDT Connector: Telnet or SSH connect to serially attached devices

SDT Connector can also be used to access text consoles on devices that are attached to the console server serial ports. For these connections, you must configure the SDT Connector client software with a Service that accesses the target gateway serial port, and sets the gateway up as a host:

1. Launch SDT Connector on your PC. Select **Edit > Preferences** and click the **Services** tab. Click **Add**

2. Enter *Serial Port 2* in **Service Name** and click **Add**
3. Select **Telnet** client as the Client. Enter 2002 in **TCP Port**. Click **OK**, click **Close**, and click **Close** again

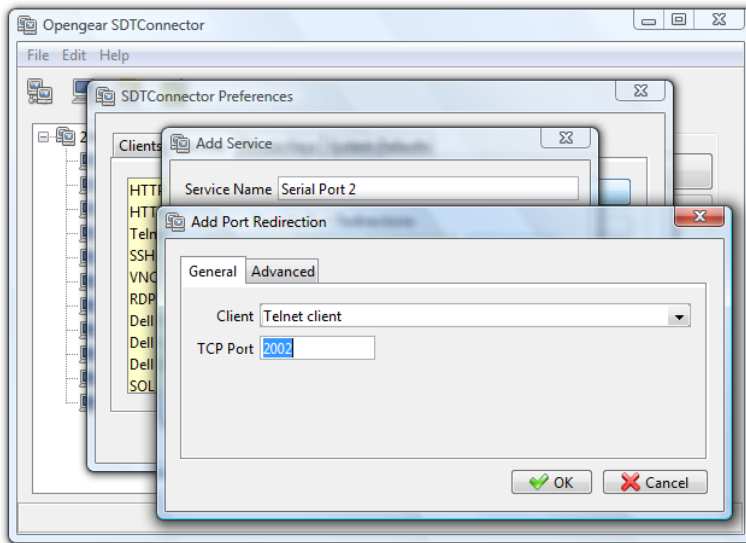

1. Assuming you have already set up the target console server as a gateway in your SDT Connector client (with username / password etc), select this gateway and click the **Host** icon to create a host or select **File > New Host**.
2. Enter 127.0.0.1 as the **Host Address** and select **Serial Port 2** for Service. In **Descriptive Name**, enter something along the lines of Loopback ports, or Local serial ports. Click **OK**.
3. Click Serial Port 2 icon for Telnet access to the serial console on the device attached to serial port #2 on the gateway

To enable SDT Connector to access to devices connected to the gateway's serial ports, you must also configure the console server to allow port forwarded network access to itself, and enable access to the nominated serial port:

1. Browse to the Console server and select **Serial Port** from **Serial & Network**
2. Click **Edit** next to selected Port # (e.g. Port 2 if the target device is attached to the second serial port). Ensure the port's serial configuration is appropriate for the attached device
3. Scroll down to **Console Server Setting** and select **Console Server Mode**. Check **Telnet** (or **SSH**)
4. Scroll to the bottom and click **Apply**
5. Select **Network Hosts** from **Serial & Network** and click **Add Host**
6. In the **IP Address/DNS Name** field enter 127.0.0.1 (this is the Opengear's network loopback address) and enter Loopback in **Description**
7. Remove all entries under **Permitted Services** and select **TCP** and enter 200n in **Port**. (This configures the Telnet port enabled in the previous step, so for Port 2 you would enter 2002)
8. Click **Add** and scroll to the bottom
9. Click **Apply**

By default, administrators have gateway and serial port access privileges. For users to access the gateway and the serial port, select **Users & Groups** from **Serial & Network**. Click **Add User**. Enter a **Username**, **Description** and **Password/Confirm**. Select 127.0.0.1 from **Accessible Host(s)** and select Port 2 from **Accessible Port(s)**. Click **Apply**.

5.5 Using SDT Connector for out-of-band connection to the gateway

SDT Connector can also be set up to connect to the console server (gateway) out-of-band (OOB). OOB access uses an alternate path for connecting to the gateway to that used for regular data traffic. OOB access is useful for when the primary link into the gateway is unavailable or unreliable.

A gateway's primary link is a broadband Internet connection or Internet connection via a LAN or VPN, and the secondary out-of-band connectivity is provided by a dial-up or wireless modem attached to the gateway. Out-of-band access enables you to access the hosts and serial devices on the network, diagnose any connectivity issues, and restore the gateway's primary link.

In SDT Connector, OOB access is configured by providing the secondary IP address of the gateway and telling SDT Connector how to start and stop the OOB connection. Starting an OOB connection may be achieved by initiating a dial up connection or adding an alternate route to the gateway. SDT Connector allows for maximum flexibility in this regard, by allowing you to provide your own scripts or commands for starting and stopping the OOB connection.

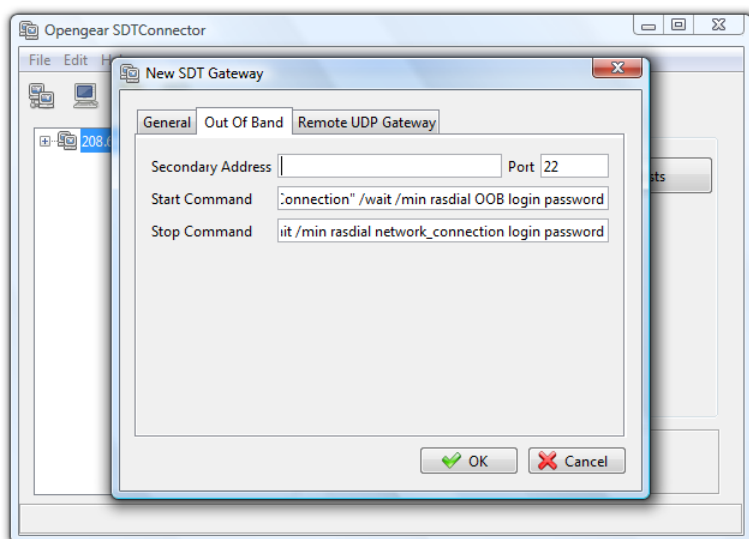

To configure SDT Connector for OOB access:

1. When adding a new gateway or editing an existing gateway select the **Out Of Band** tab
2. Enter the secondary, OOB IP address of the gateway (e.g. the IP address it is accessible using when dialed in directly). You also may modify the gateway's SSH port if it's not using the default of 22
3. Enter the command or path to a script to start the OOB connection in **Start Command**

- To initiate a pre-configured dial-up connection under Windows, use the following Start Command:

```
cmd /c start "Starting Out of Band Connection" /wait /min rasdial network_connection login password
```

where network_connection is the name of the network connection as displayed in Control Panel > Network Connections, login is the dial-in username, and password is the dial-in password for the connection.

- To initiate a pre-configured dial-up connection under Linux, use the following Start Command:
`pon network_connection`
where `network_connection` is the name of the connection.
4. Enter the command or path to a script to stop the OOB connection in **Stop Command**
- To stop a pre-configured dial-up connection under Windows, use the following Stop Command:
`cmd /c start "Stopping Out of Band Connection" /wait /min rasdial network_connection /disconnect`
where `network connection` is the name of the network connection as displayed in Control Panel > Network Connections.
 - To stop a pre-configured dial-up connection under Linux, use the following Stop Command:
`poff network_connection`

To make the OOB connection using SDT Connector, select the gateway and click Out Of Band. The status bar changes color to indicate this gateway is being access using the OOB link rather than the primary link

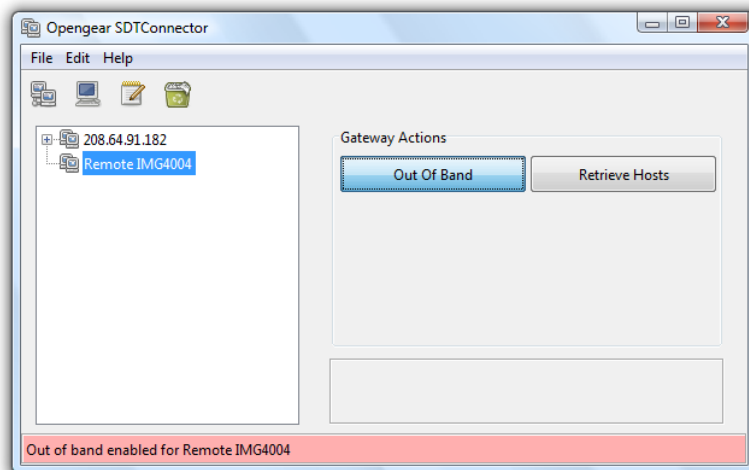

When you connect to a service on a host behind the gateway, or to the console server gateway, SDT Connector initiates the OOB connection using the provided Start Command. The OOB connection isn't stopped (using the Stop Command) until Out-of-Band under Gateway Actions is clicked off, at which point the status bar returns to its normal color.

5.6 Importing (and exporting) preferences

To enable the distribution of pre-configured client config files, SDT Connector has an Export/Import facility:

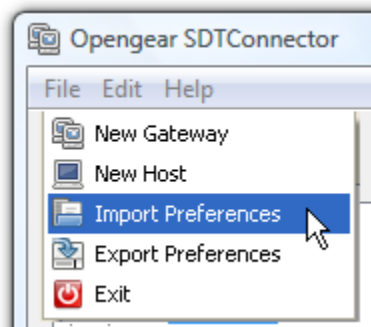

To save a configuration .xml file (for backup or for importing into other SDT Connector clients) select **File > Export Preferences** and select the location to save the configuration file

To import a configuration select **File > Import Preferences** and select the .xml configuration file to be installed

5.7 SDT Connector Public Key Authentication

SDT Connector can authenticate against an SSH gateway using your SSH key pair rather than requiring you to enter your password. This is known as public key authentication.

To use public key authentication with SDT Connector, first you must add the public part of your SSH key pair to your SSH gateway:

1. Ensure the SSH gateway allows public key authentication, this is the default behavior
2. If you do not already have a public/private key pair for your client PC (the one running SDT Connector on) generate them using ssh-keygen, PuTTYgen or a similar tool. You may use RSA or DSA, but it is important that you leave the passphrase field blank:
 - PuTTYgen: <http://www.chiark.greenend.org.uk/~sgtatham/putty/download.html>
 - OpenSSH: <http://www.openssh.org/>
 - OpenSSH (Windows): <http://sshwindows.sourceforge.net/download/>
3. Upload the public part of your SSH key pair (this file is named id_rsa.pub or id_dsa.pub) to the SSH gateway, or otherwise add to .ssh/authorized keys in your home directory on the SSH gateway
4. Next, add the private part of your SSH key pair (this file is named id_rsa or id_dsa) to SDT Connector. Click **Edit > Preferences > Private Keys > Add**, locate the private key file and click **OK**

You do not have to add the public part of your SSH key pair, it is calculated using the private key.

SDT Connector uses public key authentication when connecting through the SSH gateway (console server). You may have to restart SDT Connector to shut down any existing tunnels that were established using password authentication.

If you have a host behind the console server that you connect to by clicking the SSH button in SDT Connector you may also wish to configure access to it for public key authentication as well. This configuration is independent of SDT Connector and the SSH gateway. You must configure the SSH client that SDT Connector launches (e.g. Putty, OpenSSH) and the host's SSH server for public key authentication. You are using SSH over SSH, and the two SSH connections are separate.

5.8 Setting up SDT for Remote Desktop access

Microsoft's Remote Desktop Protocol (RDP) enables the system manager to securely access and manages remote Windows computers – to reconfigure applications and user profiles, upgrade the server's operating system, reboot the machine etc. Opengear's Secure Tunneling uses SSH tunneling, so this RDP traffic is securely transferred through an authenticated and encrypted tunnel.

SDT with RDP also allows remote users to connect to Windows XP and later computers and to Windows 2000 Terminal Servers; and to have access to all of the applications, files, and network resources (with full graphical interface as though they were in front of the computer screen at work). To set up a secure Remote Desktop connection you must enable Remote Desktop on the target Windows computer that is to be accessed and configure the RPD client software on the client PC.

5.8.1 Enable Remote Desktop on the target Windows computer to be accessed

To enable **Remote Desktop** on the Windows computer being accessed:

1. Open **System** in the Control Panel and click the **Remote** tab

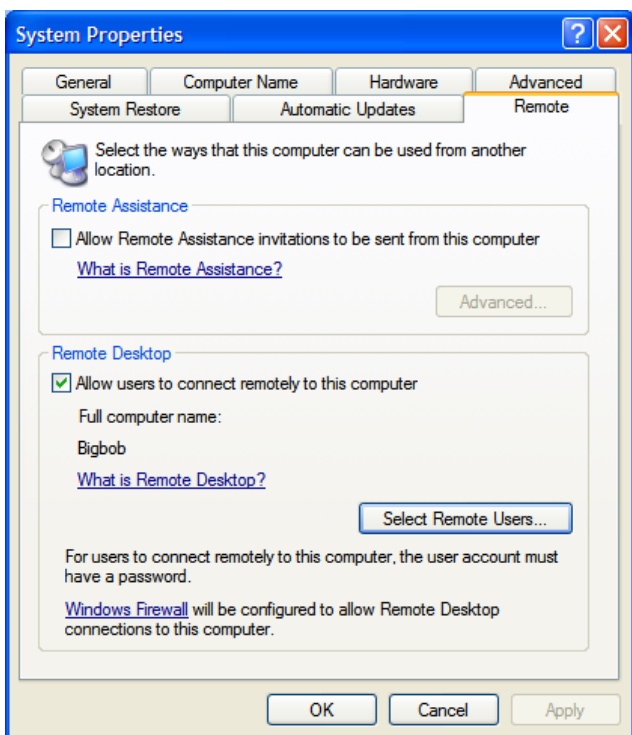

2. Check **Allow users to connect remotely to this computer**
3. Click **Select Remote Users**

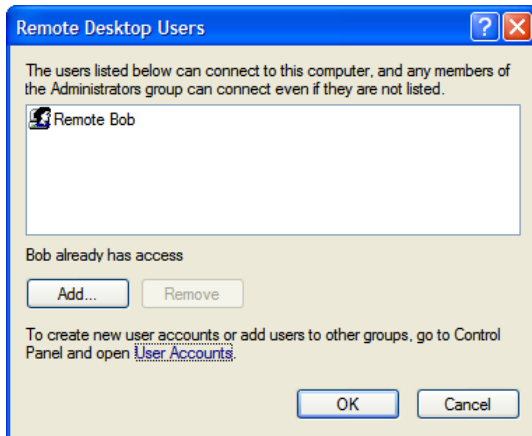

To set the user(s) who can remotely access the system with RDP click **Add** on the **Remote Desktop Users** dialog box

NOTE If you need to set up new users for Remote Desktop access, open **User Accounts** in the Control Panel and proceed through the steps to nominate the new user's name, password and account type (Administrator or Limited). When the remote user connects to the accessed computer on the console session, Remote Desktop locks that computer so no other user can access the applications and files. Unlock it by typing CTRL+ALT+DEL.

5.8.2 Configure the Remote Desktop Connection client

The Client PC is securely connected to the console server either locally, or remotely - thru the enterprise VPN, or a secure SSH internet tunnel or a dial-in SSH tunnel. To establish the Remote Desktop connection from the Client, enable the **Remote Desktop Connection** on the remote client PC and point it to the SDT Secure Tunnel port in the console server.

5.9 SDT SSH Tunnel for VNC

Users can securely access and control Windows, Linux, Macintosh, Solaris and UNIX computers with SDT and Virtual Network Computing (VNC). There's a range of popular VNC software available. To set up a secure VNC connection you must install and configure the VNC Server software on the computer to be accessed, and install and configure the VNC Viewer software on the Viewer PC.

5.9.1 Install, configure and connect the VNC Viewer

VNC Viewer on any operating system can connect to a VNC Server on any other operating system.

Install the VNC Viewer software and set it up for the appropriate speed connection

NOTE To make VNC faster, when you set up the Viewer:

- Set encoding to ZRLE if you have a fast CPU
- Decrease color level (e.g. 64 bit)
- Disable the background transmission on the Server or use a plain wallpaper

(See <http://doc.uvnc.com> for detailed configuration instructions)

To establish the VNC connection, first configure the VNC Viewer, entering the VNC Server IP address

- When the Viewer PC is connected to the console server thru an SSH tunnel (over the public Internet, or a dial-in connection, or private network connection), enter localhost (or 127.0.0.1) as the IP VNC Server IP address; and the source port you entered when setting SSH tunneling /port forwarding, e.g. :1234.

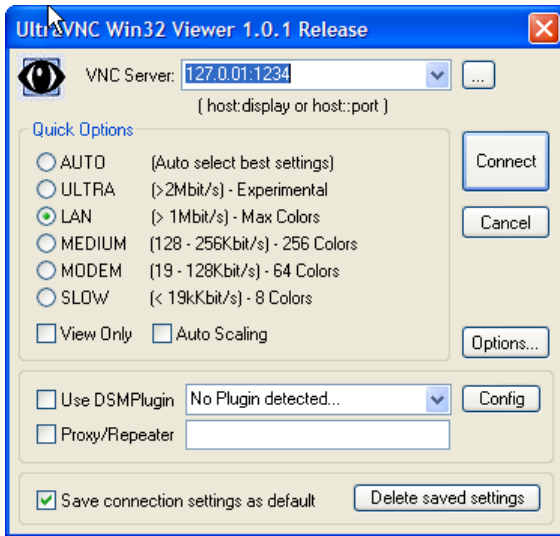

- When the Viewer PC is connected to the console server (i.e. locally or remotely through a VPN or dial-in connection); and the VNC Host computer is serially connected to the console server; enter the IP address of the console server unit with the TCP port that the SDT tunnel uses. The TCP port is 7900 plus the physical serial port number (i.e. 7901 to 7948, so all traffic directed to port 79xx on the console server is tunneled thru to port 5900 on the PPP connection on serial Port xx) e.g. for a Windows Viewer PC using UltraVNC connecting to a VNC Server which is attached to Port 1 on a console server located 192.168.0.1

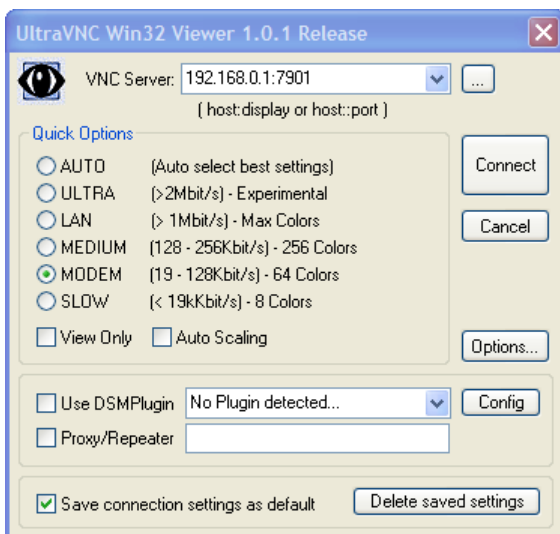

You can establish the VNC connection by activating the VNC Viewer software on the Viewer PC and entering the password



5.10 Using SDT to IP connect to hosts that are serially attached to the gateway

Network (IP) protocols like RDP, VNC and HTTP can also be used for connecting to host devices that are serially connected through their COM port to the console server. To do this you must:

1. Establish a PPP connection between the host and the gateway.
2. Set up Secure Tunneling - Ports on the console server.
3. Configure SDT Connector to use the appropriate network protocol to access IP consoles on the host devices that are attached to the Console server serial ports

5.10.1 Establish a PPP connection between the host COM port and console server

This step is only necessary for serially connected computers.

First, physically connect the COM port on the host computer that is to be accessed to the serial port on the console server. Next:

For non-Windows computers, establish a PPP connection over the serial port. The online tutorial <http://www.yolinux.com/TUTORIALS/LinuxTutorialPPP.html> presents a selection of methods for establishing a PPP connection for Linux

For Windows XP and 2003 computers follow the steps below to set up an advanced network connection between the Windows computer, through its COM port to the console server. Both Windows 2003 and Windows XP Professional allow you to create a dial-in service which can be used for the Remote Desktop/VNC/HTTP/X connection to the console server:

1. Open **Network Connections** in Control Panel and click the **New Connection Wizard**

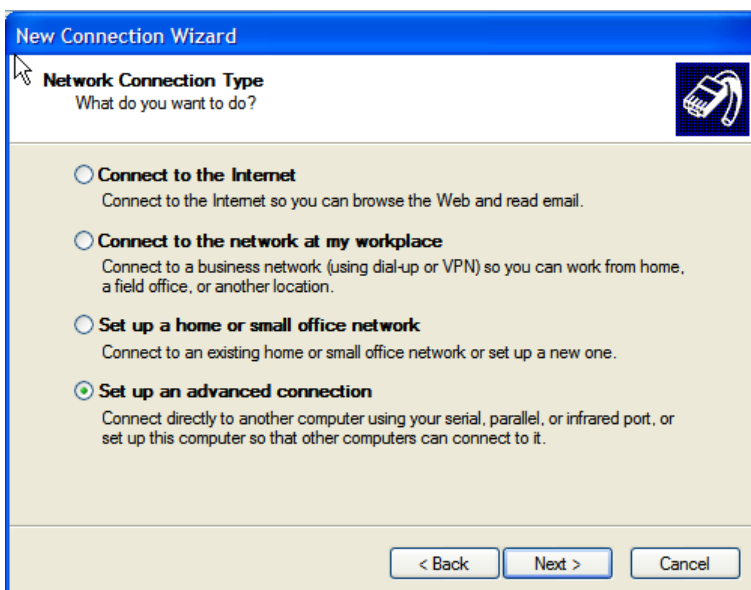

2. Select **Set up an advanced connection** and click **Next**
3. On the **Advanced Connection Options** screen select **Accept Incoming Connections** and click **Next**
4. Select the **Connection Device** (i.e. the serial COM port on the Windows computer that you cabled through to the console server). By default select **COM1**. The COM port on the Windows computer should be configured to its maximum baud rate. Click **Next**
5. On the **Incoming VPN Connection Options** screen select **Do not allow virtual private connections** and click **Next**

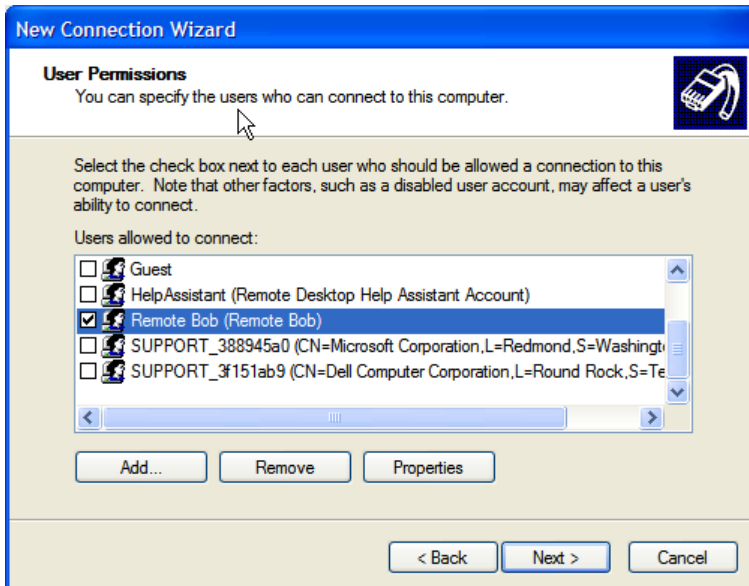

6. Specify which users can access this connection. These are same users who were given Remote Desktop access privileges in the earlier step. Click **Next**
7. On the **Network Connection** screen select **TCP/IP** and click **Properties**

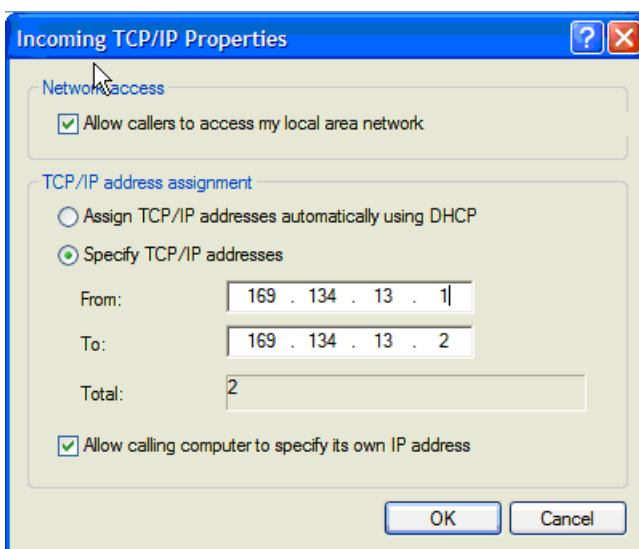

8. Select **Specify TCP/IP addresses** on the **Incoming TCP/IP Properties** screen select **TCP/IP**. Nominate a **From** and **To** TCP/IP address and click **Next**

User Manual

You can choose any TCP/IP addresses used anywhere else on your network. The **From** address is assigned to the Windows computer and the **To** address is used by the console server. For simplicity, use the IP address as shown in the illustration above:

From: 169.134.13.1

To: 169.134.13.2

Alternately you can set the advanced connection and access on the Windows computer to use the console server defaults:

- Specify 10.233.111.254 as the **From** address
- Select Allow calling computer to specify its own address

You could use the console server default username and password when you set up the new Remote Desktop user and gave this user permission to use the advance connection to access the Windows computer:

- The console server default Username is portXX where XX is the serial port number on the console server.
- The default Password is portXX

To use the defaults for an RDP connection to the serial port 2 on the console server, you would have set up a Windows user named port02

When the PPP connection has been set up, a network icon appears in the Windows task bar

The above describes setting up an incoming connection for Windows XP. The steps are similar for later versions, but the setup screens differ:

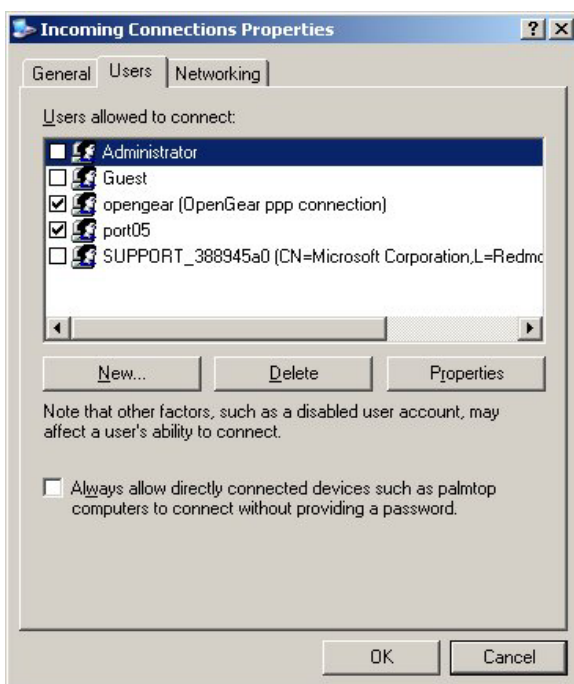

Check the box for **Always allow directly connected devices...**

The option for to **Set up an advanced connection** is not available in Windows 2003 if RRAS is configured. If RRAS has been configured, enable the null modem connection for the dial-in configuration.

- A. For earlier version Windows computers follow the steps in Section B above to get to the **Make New Connection** button:
- For Windows 2000, click **Start** and select **Settings** at the **Dial-Up Networking Folder** click **Network and Dial-up Connections** and click **Make New Connection**. Note you may need to first set up connection over the COM port using **Connect directly to another computer** before proceeding to **Set up an advanced connection**
 - For Windows 98, double click **My Computer** on the Desktop. Open **Dial-Up Networking** and double click

5.10.2 Set up SDT Serial Ports on console server

Enabling SDT on a port overrides all other Configuration protocols on that port.

To set up RDP (and VNC) forwarding on the console server Serial Port that is connected to the Windows computer COM port:

1. Select the **Serial & Network > Serial Port** menu option and click **Edit** (for the particular Serial Port that is connected to the Windows computer COM port)
2. On the SDT Settings menu select **SDT Mode** (which enables port forwarding and SSH tunneling) and enter a **Username** and **User Password**. If you leave the **Username** and **User Password** fields blank, they default to portXX and portXX where XX is the serial port number. For example, the default username and password for Secure RDP over Port 2 is port02

SDT Settings	
SDT Mode	<input type="radio"/> Enable access over SSH to a host connected to this serial port.
Username	<input type="text"/> The login name for PPP. The default is 'port01'
User Password	<input type="text"/> The login secret for PPP. The default is 'port01'
Confirm Password	<input type="text"/> Re-type the password for confirmation.

3. Ensure the console server **Common Settings** (Baud Rate, Flow Control) are the same as were set up on the Windows computer COM port and click **Apply**
4. RDP and VNC forwarding over serial ports are enabled on a Port basis. You can add users who can have access to these ports or reconfigure user profiles by selecting **Serial & Network > User & Groups** menu tag - as described in Chapter 3, Configuring Serial Ports.

5.10.3 Set up SDT Connector to SSH port forward over the console server Serial Port

In the SDT Connector software running on your remote computer specify the gateway IP address of your console server and a username/password for a user you have setup on the console server that has access to the desired port.

Next you need to add a New SDT Host. In the Host address, put portxx where xx = the port you are connecting to. For example, port 3 would have a Host Address of: port03. Click the RDP Service check box.

5.11 SSH Tunneling using other SSH clients (e.g. PuTTY)

We recommend you use the SDT Connector client software that is supplied with the console server. There are also commercial and free SSH client programs that can also provide the secure SSH connections to the console servers and secure tunnels to connected devices.

Here is an example of the establishment of an SSH tunneled connection to a network connected device using the PuTTY client software:

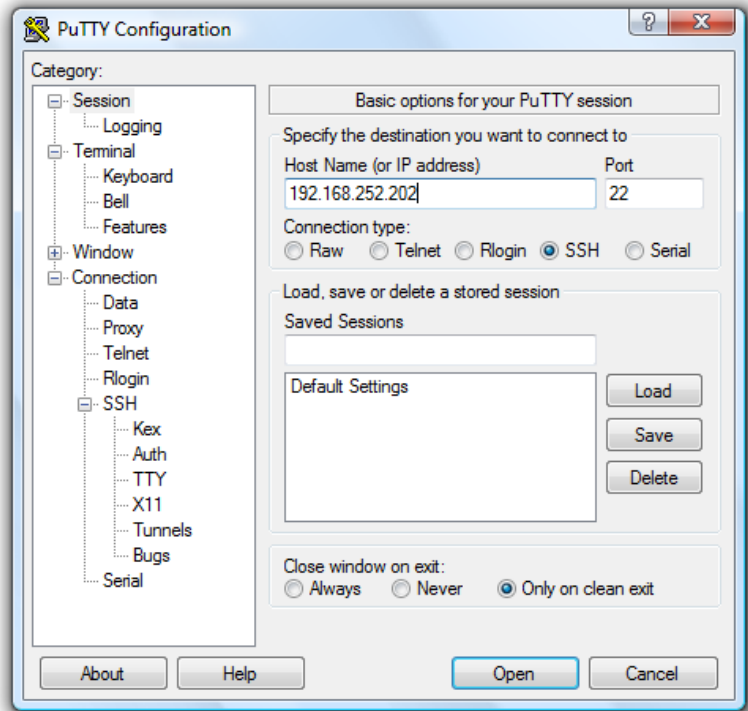

1. In the **Session** menu enter the IP address of the console server in the **Host Name or IP address** field
 - For dial-in connections, this IP address is the **Local** Address that you assigned to the console server when you set it up as the Dial-In PPP Server
 - For Internet (or local/VPN connections) connections this is the public IP address of the console server
2. Select the **SSH Protocol**. The **Port** is set to 22
3. Go to the **SSH > Tunnels** menu and in Add new forwarded port enter any high unused port number for the **Source port** e.g. 54321
4. Set the **Destination**: IP details
 - If your destination device is network connected to the console server and you are connecting using RDP, set the Destination as < managed device IP address/DNS Name>:3389 e.g. if when setting up the managed device as Network Host on the console server you specified its IP address to be 192.168.253.1 (or its DNS Name is accounts.myco.intranet.com), specify the Destination as 192.168.523.1:3389 (or accounts.myco.intranet.com:3389). Only devices which have been configured as networked Hosts can be accessed using SSH tunneling (except by the **root** user who can tunnel to any IP address the console server can route to.

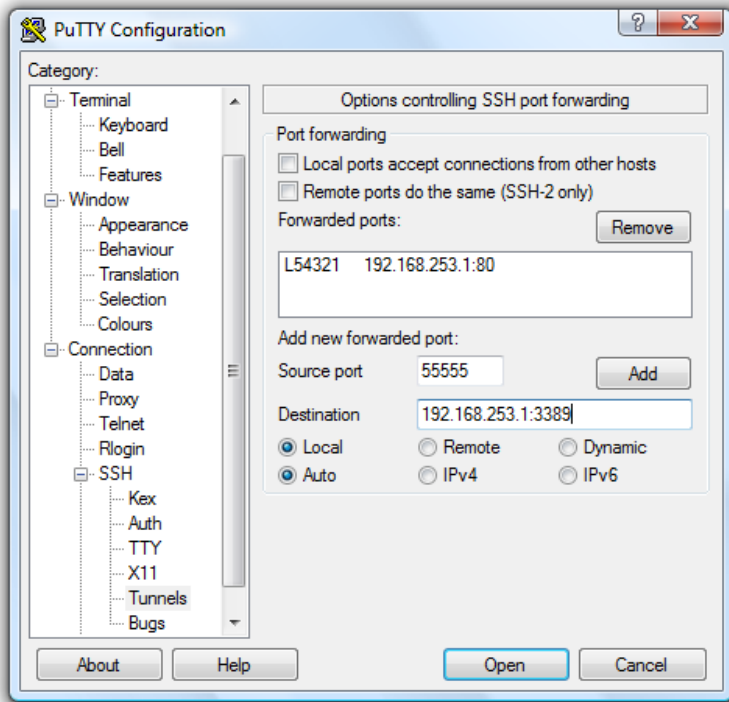

- If your destination computer is serially connected to the console server, set the Destination as <port label>:3389 e.g. if the **Label** you specified on the serial port on the console server is win2k3, specify the remote host as win2k3:3389 . Alternative you can set the Destination as portXX:3389 where XX is the SDT enabled serial port number e.g. if port 4 is on the console server is to carry the RDP traffic, specify port04:3389

5. Select **Local** and click the **Add** button
6. Click **Open** to SSH connect the Client PC to the console server. You are prompted for the Username/Password for the console server user

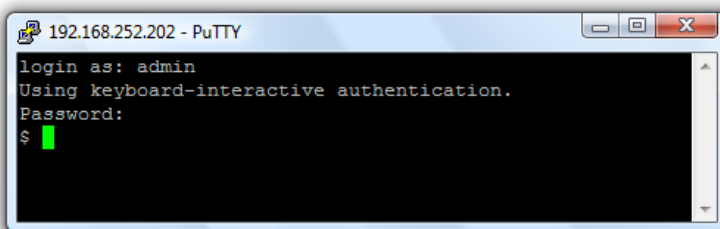

- If you are connecting as a user in the **users** group, you can only SSH tunnel to Hosts and Serial Ports where you have access permissions
- If you are connecting as an administrator, you can connect to any configured Host or Serial Ports (which has SDT enabled)

To set up the secure SSH tunnel for a HTTP browser connection to the managed device specify port 80 (rather than port 3389 as used for RDP) in the Destination IP address.

To set up the secure SSH tunnel from the Client (Viewer) PC to the console server for VNC follow the steps above. When configuring the VNC port redirection, specify port 5900 in the Destination IP address.

6 ALERTS, AUTO-RESPONSE & LOGGING

This chapter describes the automated response, alert generation and logging features of the console server.

With Auto-Response the console server monitors selected serial ports, logins, the power status and environmental monitors and probes for Check Condition triggers. The console server initiates a sequence of actions in response to these triggers. To configure Auto-Response:

1. Set the general parameters
2. Select and configure the Check Conditions, the conditions that trigger the response.
3. Specify the Trigger Actions, the sequence of actions initiated in event of the trigger condition.
4. Specify the Resolve Actions, the actions performed when trigger conditions have been resolved.

Console servers can maintain log records of all access and communications with the console server and with the attached serial devices. A log of all system activity is also maintained as is a history of the status of any attached environmental monitors.

Some models can also log access and communications with network attached hosts and maintain a history of the UPS and PDU power status.

If port logs are to be maintained on a remote server, the access path to this location need to be configured Activate and set the desired levels of logging for each serial and/or network port and/or power and environment UPS.

6.1 Configure Auto-Response

With the Auto-Response facility, a sequence of Trigger Actions is initiated in the event of a specified trigger condition (Check Condition). Subsequent Resolve Actions can also be performed when the trigger condition has been resolved.

To configure, set the general parameters that apply to all Auto-Responses:

- Check **Log Events** on **Alerts & Logging > Auto-Response** to enable logging all Auto-Response activities
- Check **Delay after Boot** to set any general delay to be applied after console server system boot, before processing events

The screenshot displays the configuration interface for Auto-Responses. It is divided into several sections:

- Configured Auto-Responses:** A table with columns for Name, Check Type, Status, Modify, Delete, and Cancel. One entry is visible: 'Local ping test' with 'ICMP Ping' check type and 'Normal' status.
- New Auto-Response:** A button to add a new configuration.
- Global Auto-Response Settings:** Contains two settings:
 - Log Events:** A checkbox that is currently unchecked, with the label 'Log Events and actions related to Auto-Responses'.
 - Delay after boot:** A text input field containing '120', with the label 'Delay after system boot before processing events'.
- Save Settings:** A button to save the current configuration.
- Auto-Response Logs:** A section showing 'No Auto-Response Logs'.

To configure a new Auto-Response:

1. Select **New Auto-Response** in the **Configured Auto-Response** field. The **Auto-Response Settings** menu appears
2. Enter a descriptive **Name** for the new Auto-Response
3. Specify the **Reset Timeout** for the time in seconds after resolution to delay before this Auto-Response can be triggered again
4. Check **Repeat Trigger Actions** to continue to repeat trigger action sequences until the check is resolved
5. Enter any required delay time before repeating trigger actions in **Repeat Trigger Action Delay**. This delay starts after the last action is queued

Auto-Response Settings

Name
Unique Name for this Auto-Response

Reset Timeout
Time in seconds after resolution to delay before this Auto-Response can be triggered again

Repeat Trigger Actions
Repeat Trigger actions until the check is resolved

Repeat Trigger Action Delay
Delay time before repeating trigger actions
The delay starts after the last action is queued

Disable Auto-Response at specific times
Allows Auto-Responses to be periodically disabled based on time and day

Check Conditions *Add a new check by selecting a check type from the left menu*

- Environmental
- Digital I/O Input
- UPS/Power Supply
- UPS Status
- Serial Login/Logout
- Serial Signal
- Serial Pattern
- USB Console Status
- ICMP Ping
- Cellular Data
- Custom Check
- SMS Command
- CLI Session Event
- WebUI Authentication Event
- Network Interface Event
- Routed Data

[Return to Auto-Response List](#)

Check **Disable Auto-Response at specific times** to periodically disable auto-Responses between specified times of day

Disable Auto-Response at specific times Allows Auto-Responses to be periodically disabled based on time and day

Disable Auto-Response between the following times

Sunday	0 : 00	0 : 00
Monday	0 : 00	0 : 00
Tuesday	0 : 00	0 : 00
Wednesday	0 : 00	0 : 00
Thursday	0 : 00	0 : 00
Friday	0 : 00	0 : 00
Saturday	0 : 00	0 : 00

6.2 Check Conditions

To configure the condition that triggers the Auto-Response:

Click on the **Check Condition** type (e.g. Environmental, UPS Status or ICMP ping) to be configured as the trigger for this new Auto-Response in the **Auto-Response Settings** menu

6.2.1 Environmental

Before configuring Environmental Checks as the trigger in Auto-Response, configure the Temp and/or Humidity sensors on your attached EMD.

To configure Humidity or Temperature levels as the trigger event:

1. Click on the **Environmental** as the **Check Condition**

Auto-Response Settings

Name
Unique Name for this Auto-Response

Reset Timeout
Time in seconds after resolution to delay before this Auto-Response can be triggered again

Repeat Trigger Actions
Repeat Trigger actions until the check is resolved

Repeat Trigger Action Delay
Delay time before repeating trigger actions
The delay starts after the last action is queued

Disable Auto-Response at specific times
Allows Auto-Responses to be periodically disabled based on time and day

Check Conditions

Environmental

Digital I/O Input

UPS/Power Supply

UPS Status

Serial Login/Logout

Serial Signal

Serial Pattern

USB Console Status

ICMP Ping

Cellular Data

Custom Check

SMS Command

Environmental Check

Environmental Sensor
Sensor to perform this check on

Trigger value for the check
Value that the measurement must exceed or drop below to trigger the Auto-Response

Comparison type
 Above Trigger Value
 Below Trigger Value
Determines what condition will cause the auto response to trigger

Hysteresis
Hysteresis factor applied to environmental measurements

Save Auto-Response

2. In the **Environmental Check** menu, select the **Environmental Sensor** to be checked for the trigger
3. Specify the **Trigger value** (in °C / °F for Temp and % for Humidity) that the check measurement must exceed or drop below to trigger the AutoResponse
4. Select **Comparison type** as being Above Trigger Value or Below Trigger Value to trigger
5. Specify any **Hysteresis** factor that is to be applied to environmental measurements (e.g. if an Auto-Response is set up with a trigger event of a temp reading above 49°C with a Hysteresis of 4, the trigger condition won't be resolved until the temp reading is below 45°C)
6. Check **Save Auto-Response**

6.2.2 Alarms and Digital Inputs

Before configuring Alarms / Digital Inputs checks in Auto-Response you first must configure the sensor/DIO that is to be attached to your EMD.

To set the status of any attached Smoke or Water sensors or digital inputs as the trigger event:

1. Click on **Alarms / Digital Inputs** as the **Check Condition**
2. In the **Alarms / Digital Inputs Check** menu, select the **Alarm/Digital IO Pin** that triggers the Auto-Response
3. Select **Trigger on Change** to trigger when alarm signal changes, or select to trigger when the alarm signal state changes to either a **Trigger Value** of Open (0) or Closed (1)
4. Check **Save Auto-Response**

6.2.3 UPS/Power Supply

Before configuring UPS checks in Auto-Response you first must configure the attached UPS.

To use the properties of any attached UPS as the trigger event:

1. Click on **UPS / Power Supply** as the **Check Condition**
2. Select **UPS Power Device Property** (Input Voltage, Battery Charge %, Load %, Input Frequency Hz or Temperature in °C) to be checked for the trigger. Some units have multiple power supplies and allow you to specify **Power Supply #1** or **Power Supply #2**.

The screenshot shows the configuration page for a UPS Power Check. On the left is a sidebar with a 'Check Conditions' menu. The main content area is titled 'UPS Power Check' and includes the following sections:

- Power Device Property:** A dropdown menu is open, showing two categories: 'Power Supply #1' and 'Power Supply #2'. Each category lists 'Input Voltage (V)', 'Rail Current (A)', and 'Temperature (C)'. The first option under 'Power Supply #1' is selected.
- Trigger value for the check:** A text input field with a placeholder value of 0.
- Comparison type:** Two radio buttons: 'Above Trigger Value' (selected) and 'Below Trigger Value'. Below them is the text: 'Determines what condition will cause the auto response to trigger'.
- Hysteresis:** A text input field with a value of 0. Below it is the text: 'Hysteresis factor applied to environmental measurements'.
- Save Auto-Response:** A dark button at the bottom of the configuration area.

3. Specify the **Trigger value** that the check measurement must exceed or drop below to trigger the Auto-Response
4. Select **Comparison type** as being **Above Trigger Value** or **Below Trigger Value** to trigger
5. Specify any **Hysteresis** factor that is to be applied to environmental measurements (e.g. if an Auto-Response is set up with a trigger event of a battery charge below 20% with a Hysteresis of 5, the trigger condition will not resolve until the battery charge is above 25%)
6. Check **Save Auto-Response**

6.2.4 UPS Status

Before configuring UPS state checks in Auto-Response you first must configure the attached UPS.

To use the alert state of any attached UPS as the Auto-Response trigger event:

1. Click on **UPS Status** as the **Check Condition**
2. Select the reported **UPS State** to trigger the Auto-Response (either On Battery or Low Battery). The Auto-Response resolves when the UPS state returns to the **Online** state
3. Select which connected **UPS Device** to monitor and check **Save Auto-Response**

6.2.5 Serial Login, Signal or Pattern

Before configuring serial port checks in Auto-Response, configure the serial port in Console server mode. Most serial port checks are not resolvable so resolve actions will not be run.

To monitor serial ports and check for login/logout or pattern matches for Auto-Response triggers events:

1. Click on **Serial Login/Logout** as the **Check Condition**. In the **Serial Login/Logout Check** menu select **Trigger on Login** (to trigger when any user logs into the serial port) or **Trigger on Logout** and specify **Serial Port** to perform check on, and/or

2. Click on **Serial Signal** as the **Check Condition**. In the **Serial Signal Check** menu select the **Signal** (CTS, DCD, DSR) to trigger on, the **Trigger** condition (either on serial signal change, or check level) and specify **Serial Port** to perform check on, and/or
3. Click on **Serial Pattern** as the **Check Condition**. In the **Serial Pattern Check** menu select the **PCRE** pattern to trigger on and the serial line (**TX** or **RX**) and **Serial Port** to pattern check on.

With Serial Pattern, you can check the **Disconnect Immediately** box to disconnect all users from the serial being monitored in event of a successful pattern match.

Auto-Response Settings

Name
Unique Name for this Auto-Response

Reset Timeout
Time in seconds after resolution to delay before this Auto-Response can be triggered again

Repeat Trigger Actions
Repeat Trigger actions until the check is resolved

Repeat Trigger Action Delay
Delay time before repeating trigger actions
The delay starts after the last action is queued

Disable Auto-Response at specific times
Allows Auto-Responses to be periodically disabled based on time and day

Check Conditions

- Environmental
- Digital I/O Input
- UPS/Power Supply
- UPS Status
- Serial Login/Logout
- Serial Signal
- Serial Pattern
- USB Console Status
- ICMP Ping
- Cellular Data
- Custom Check
- SMS Command
- CLI Session Event
- WebUI Authentication

Serial Pattern Check

Pattern
PCRE regular expression to match on

Match on TX
Match on characters transmitted by the Console Server to the connected device

Match on RX
Match on characters received by the Console Server from the connected device

Disconnect Immediately
On a successful pattern match disconnect users connected via this serial port

Serial Port

Select/Unselect all Ports.

Port Port Port Port Port Port Port Port
1 2 3 4 5 6 7 8

NOTE For devices with a cellular modem with GPS enabled, the GPS is displayed as an additional port and can be monitored for trigger events.

4. Check **Save Auto-Response**

6.2.6 USB Console Status

USB port labels in the Web interface match the USB port labels printed on a console server with two exceptions. Some console servers include pairs of USB ports without printed labels. In this case, the Web interface denotes them as either Upper or Lower. The Web interface lists them by their physical relationship to each other.

Some console servers have four USB ports. A few of these have ports labeled 1-4 even though the Web interface denotes them as USB ports A-D.

USB console status checks are not resolvable. Trigger actions run but Resolve actions do not.

To monitor USB ports:

1. Click **USB Console Status** as the **Check Condition**.
2. Check the Trigger on Connect checkbox, the Trigger on Disconnect checkbox, or both checkboxes to set which actions trigger the Auto-Response.
3. Check each USB port to be monitored (or click the Select/Unselect all Ports checkbox to select or deselect all USB ports).
4. Click the **Save Auto-Response** button.
5. Select an option from the **Add Trigger Action** list.
6. Enter a unique Action Name for the trigger action being created.
7. Set an Action Delay Time. By default, this is 0 seconds.
8. Enter the details of the selected action. For example, the Send Email action requires a Recipient Email Address and allows for a Subject and Email Text.
9. Click the **Save New Action** button.

6.2.7 ICMP Ping

To use a ping result as the Auto-Response trigger event:

1. Click on **ICMP Ping** as the **Check Condition**
2. Specify which **Address to Ping** (i.e. IP address or DNS name to send ICMP Ping to) and which **Interface** to send ICMP Ping from (e.g. Management LAN or Wireless network)
3. Set the **Check Frequency** (i.e. the time in seconds between checks) and the **Number** of ICMP Ping packets to send
4. Check **Save Auto-Response**

The screenshot shows a web interface for configuring an ICMP Ping Check. On the left is a sidebar with a list of 'Check Conditions' including Environmental, Digital I/O Input, UPS/Power Supply, UPS Status, Serial Login/Logout, Serial Signal, Serial Pattern, USB Console Status, ICMP Ping (which is selected), Cellular Data, Custom Check, SMS Command, CLI Session Event, and WebUI Authentication Event. The main content area is titled 'ICMP Ping Check' and contains the following fields:

- Address to Ping:** A text input field with a placeholder 'Address to send ICMP Ping to. Can be an IP or a DNS name'.
- Interface:** A dropdown menu with a list of options: Default Route (checked), Ethernet Interfaces, Network Interface, and Modems (Internal Cellular Modem).
- Check Frequency:** A text input field.
- Number of Packets:** A text input field with the value '5' and a placeholder 'Number of ICMP Ping packets to send'.

At the bottom of the form are two buttons: 'Save Auto-Response' and 'Return to Auto-Response List'.

6.2.8 Link Layer Discovery Protocol (LLDP)

The Link Layer Discovery Protocol (LLDP) is a protocol that allows system administrators to glean information about devices physically connected to managed switches. It is available for use on IM7200, CM7100 and ACM7000 devices.

Using LLDP

The LLDP service is enabled through the **System > Services** page. When the service is enabled, the lldpd daemon is loaded and runs. The Service Access tab controls which network interfaces are monitored by

the lldpd daemon. LLDPd is also configured by default to broadcast CDP packets, and monitor both LLDP and CDP neighbours.

When LLDP is granted access to an interface, it uses that interface even if the interface has been disabled via **System > IP**.

LLDP neighbors are visible through the **Status > LLDP Neighbors** page. This page shows neighbors heard, and also indicates the information that the console manager is sending.

NOTE LLDP service can be granted access to non-ethernet interfaces (for example, G3, G4 and PSTN dial-up interfaces), but it currently ignores non-ethernet interfaces.

Customising LLDP

The lldpcli shell client interacts with and configures the running LLDP service.

Persistent custom configuration changes can be added to the system through configuration files placed in /etc/config/lldpd.d/. Custom configuration files – which must have filenames ending with .conf – is read and executed by lldpcli when the LLDP service starts.

NOTE On Opendgear hardware:

- The /etc/ directory is read-only. Most default configuration files otherwise stored in /etc/ are in /etc/config/, which is writeable.
 - The default lldpd configuration file – lldpd.conf – is stored in /etc/config/. It is not a safe location to store custom configuration details. There are circumstances in which this file is regenerated automatically, in which customizations will be lost.
 - The etc/config/lldpd.d/ directory, which is writable and is created on first boot, is safe to write to. Any Custom LLDP configurations must be stored as *.conf files in this directory.
-

Security

When enabled, LLDP frames issued by an Opendgear Console Manager reveals sensitive information such as hostname and firmware version.

LLDP frames are not passed through by 802.3ab compliant switches, and Opendgear Console Managers have the LLDP service disabled by default.

Documentation

Both lldpd and lldpcli have standard man pages but, because of space concerns, these man pages are not shipped with Opendgear hardware.

Both man pages are available on the lldpd project web-site:

man lldpd.

man lldpcli.

6.2.9 Cellular Data

Before configuring cellular data checks in Auto-Response the internal cellular modem must be configured and detected by the console server.

This check monitors the aggregate data traffic inbound and outbound through the cellular modem as an Auto-Response trigger event.

Click on **Cellular Data** as the **Check Condition**

6.2.10 Custom Check

This check allows users to run a nominated custom script with nominated arguments whose return value is used as an Auto-Response trigger event:

1. Click on **Custom Check** as the **Check Condition**
2. Create an executable trigger check script file e.g. /etc/config/test.sh

```
#!/bin/sh
logger "A test script"
logger Argument1 = $1
logger Argument2 = $2
logger Argument3 = $3
logger Argument4 = $4
if [ -f /etc/config/customscript.0 ]; then
    rm /etc/config/customscript.0
    exit 7
fi
touch /etc/config/customscript.0
exit 1
```

See online FAQ for a sample web page html check and other script file templates

3. Enter the **Script Executable** file name (e.g. /etc/config/test.sh)
4. Set the **Check Frequency** (i.e. the time in seconds between re-running the script) and the **Script Timeout** (i.e. the maximum run-time for the script)
5. Specify the **Successful Return Code**. An Auto-Response is triggered if the return code from the script is not this value
6. Enter **Arguments** that are to be passed to the script (e.g. with a web page html check script, these Arguments might specify the web page address/DNS and user logins)
7. Check **Save Auto-Response**

Auto-Response Settings

Name
Unique Name for this Auto-Response

Reset Timeout
Time in seconds after resolution to delay before this Auto-Response can be triggered again

Repeat Trigger Actions
Repeat Trigger actions until the check is resolved

Repeat Trigger Action Delay
Delay time before repeating trigger actions
The delay starts after the last action is queued

Disable Auto-Response at specific times
Allows Auto-Responses to be periodically disabled based on time and day

Check Conditions

- Environmental
- Digital I/O Input
- UPS/Power Supply
- UPS Status
- Serial Login/Logout
- Serial Signal
- Serial Pattern
- USB Console Status
- ICMP Ping
- Cellular Data
- Custom Check
- SMS Command
- CLI Session Event
- WebUI Authentication

Custom Check

Script Executable
Script to execute when this action is triggered

Check Frequency
Time in seconds between checks

Script Timeout
Maximum run-time for this script.
Leave as 0 for unlimited

Successful Return Code
Trigger if the return code is not this value

Argument 1
Argument to pass to the script

6.2.11 SMS Command

The SMS command trigger condition can only be set if there is an internal cellular modem.

An incoming SMS command from a nominated caller can trigger an Auto-Response:

1. Click on **SMS Command** as the **Check Condition**
2. Specify which **Phone Number** (in international format) of the phone sending the SMS message. For multiple trusted SMS sources separate the numbers with a comma
3. Set the **Incoming Message Pattern** (PCRE regular expression) to match to create trigger event

SMS Command Check

Phone number
Phone number, or comma separated list of phone numbers, in international format without the +

Incoming Message Pattern
PCRE Regular expression to match within the incoming message

This check is not resolvable, Resolve actions will not be run

6.2.12 CLI Log In/Out Check

To configure a CLI Login/Out check:

1. Click on the **CLI Session Event** as the **Check Condition**

Check Conditions

- Environmental
- Digital I/O Input
- UPS/Power Supply
- UPS Status
- Serial Login/Logout
- Serial Signal
- Serial Pattern
- USB Console Status
- ICMP Ping
- Cellular Data
- Custom Check
- SMS Command
- CLI Session Event**
- WebUI Authentication Event
- Network Interface Event
- Routed Data

CLI Session Check

Trigger on Login Trigger when a user starts a CLI session

Trigger on Logout Trigger when a user logs out of a CLI session

Trigger on Authentication Error Trigger when a user fails to authenticate to a CLI session

This check is not resolvable, Resolve actions will not be run

[Save Auto-Response](#)

[Return to Auto-Response List](#)

2. Check **Trigger on Login (Logout)** to trigger when a user logs into (or out of) the CLI
3. Check **Trigger on Authentication Error** to trigger when a user fails to authenticate to the CLI. This check is not resolvable so Resolve actions are not run.

6.2.13 Web UI Log In/Out Check

To configure Web Log In/Out as the trigger event:

1. Click on the **Web UI Authentication** as the **Check Condition**

Check Conditions

- Environmental
- Digital I/O Input
- UPS/Power Supply
- UPS Status
- Serial Login/Logout
- Serial Signal
- Serial Pattern
- USB Console Status
- ICMP Ping
- Cellular Data
- Custom Check
- SMS Command
- CLI Session Event
- WebUI Authentication Event**
- Network Interface Event
- Routed Data

Web UI Login/Logout Check

Trigger on Login Trigger when a user logs into the Web UI

Trigger on Logout Trigger when a user logs out of the Web UI

Trigger on Authentication Error Trigger when a user fails to authenticate to the Web UI

This check is not resolvable, Resolve actions will not be run

[Save Auto-Response](#)

[Return to Auto-Response List](#)

2. Check **Trigger on Login (Logout)** to trigger when a user logs into (or out of) the Web UI

3. Check **Trigger on Authentication Error** to trigger when a user fails to authenticate to the Web UI. This check is not resolvable so Resolve actions are not run.

6.2.14 Network Interface Event

You may wish to configure a change in the network status as the trigger event (e.g. to send an alert or restart a VPN tunnel connection):

1. Click on **Network Interface** as the **Check Condition**

The screenshot shows the configuration page for the 'Interface Event Check'. On the left is a sidebar titled 'Check Conditions' with a list of options: Environmental, Digital I/O Input, UPS/Power Supply, UPS Status, Serial Login/Logout, Serial Signal, Serial Pattern, USB Console Status, ICMP Ping, Cellular Data, Custom Check, SMS Command, CLI Session Event, WebUI Authentication Event, Network Interface Event, and Routed Data. The main area is titled 'Interface Event Check' and contains the following elements:

- Interface:** A dropdown menu currently showing 'Network Interface' with a blue arrow icon. Below it, the text reads 'The interface to monitor for events'.
- Events:** A section with four checkboxes: 'Down', 'Starting', 'Up', and 'Stopping'. Below these is the text 'Events to trigger on.'.
- Warning:** A message in red text that reads 'This check is not resolvable, Resolve actions will not be run'.
- Buttons:** Two buttons are located at the bottom: 'Save Auto-Response' and 'Return to Auto-Response List'.

2. Select the **Interface** (Ethernet /Failover OOB Interface or Modem or VPN) to monitor
3. Check what type of network interface **Event** to trigger on (interface Down, Starting, Up or Stopping). This check is not resolvable so Resolve actions are not run.

6.2.15 Routed Data Usage Check

This check monitors the specified input interface for data usage that is being routed through the Opengear and out another interface such as the Internal Cellular Modem.

It is useful in IP Passthrough mode to detect when the downstream router has failed over and is routing via the Opengear's modem as a backup connection.

This check may be configured with these parameters:

Check Conditions

- Environmental
- Digital I/O Input
- UPS/Power Supply
- UPS Status
- Serial Login/Logout
- Serial Signal
- Serial Pattern
- USB Console Status
- ICMP Ping
- Cellular Data
- Custom Check
- SMS Command
- CLI Session Event
- WebUI Authentication Event
- Network Interface Event
- Routed Data

Routed Data Usage Check

Interface 
The output interface to monitor for routed data usage.

Source MAC Address
Monitor routed data originating from this MAC address only.
Optional, leave blank to monitor any/all originating

Source IP Address
Monitor routed data originating from this IP address only.
Optional, leave blank to monitor any/all originating

Data Limit KBytes
The amount of data over the specified time period to trigger on

Time Period Minutes
Trigger when the routed data limit is reached within this time period.

Resolve Time Period Minutes
Resolve when no data is routed within this time period.

[Save Auto-Response](#)

[Return to Auto-Response List](#)

- The Opengear's incoming **Interface** to monitor
- An optional **Source MAC/IP Address**, to monitor traffic from a host
- **Data Limit** threshold, the Auto-Response triggers when this is reached in the specified **Time Period**
- The Auto-Response resolves if no matching data is routed for the **Resolve Period**.

6.3 Trigger Actions

To configure the sequence of actions to take in the event of the trigger condition:

1. For a nominated Auto-Response with a defined Check Condition, click on **Add Trigger Action** to select the action type to take. Configure the selected action as detailed in the following sections.
2. **Action Delay Time** specifies how many seconds after the Auto-Response trigger event to wait before performing the action. You can add follow-on actions to create a sequence of actions taken in the event of the trigger condition
3. To edit or delete an existing action, click the **Modify** (or **Delete**) icon in the **Scheduled Trigger Action** table.

A message text can be sent with Email, SMS and Nagios actions. This configurable message can include selected values:

\$AR_TRIGGER_VAL: the trigger value for the check e.g. for UPS Status, it could be onbatt or battlow

\$AR_VAL: the value returned by the check e.g. for ups status, it could be online/onbatt/battlow

\$AR_CHECK_DEV: the device name of the device being checked e.g. for Alarm, the alarm name

\$TIMESTAMP: the current timestamp

\$HOSTNAME: the hostname of the console server

The default message text is: \$TIMESTAMP: This action was run - Check details: value \$AR_VAL vs trigger value \$AR_TRIGGER_VAL

6.3.1 Send Email

1. Click on **Send Email** as the **Add Trigger Action**. Enter a unique **Action Name** and set the **Action Delay Time**

2. Specify the **Recipient Email Address** to send this email to and the **Subject** of the email. For multiple recipients you can enter comma separated addresses
3. Edit the **Email Text** message to send and click **Save New Action**

An SMS alert can also be sent via an SMTP (email) gateway. Enter the Recipient Email Address in the format specified by the gateway provider (e.g. for T-Mobile it is phonenumber @tmomail.net)

6.3.2 Send SMS

An SMS alert can only be sent if there is an internal cellular modem.

1. Click on **Send SMS** as the **Add Trigger Action**. Enter a unique **Action Name** and set the **Action Delay Time**
2. Specify the **Phone number** that the SMS will be sent to in international format (without the +)
3. Edit the **Message Text** to send and click **Save New Action**

NOTE SMS alerts can also be sent via a SMTP SMS gateway as described above.

6.3.3 Perform RPC Action

1. Click on **Perform RPC Action** as the **Add Trigger Action**. Enter a unique **Action Name** and set the **Action Delay Time**
2. Select a power **Outlet** and specify the **Action** to perform (power on, off, or cycle)
3. Click **Save New Action**

6.3.4 Run Custom Script

1. Click on **Run Custom Script** as the **Add Trigger Action**. Enter a unique **Action Name** and set the **Action Delay Time**
2. Create a script file to execute when this action is triggered and enter the **Script Executable** file name e.g. /etc/config/action.sh
3. Set the **Script Timeout** (i.e. the maximum run-time for the script). Leave as 0 for unlimited.
4. Enter any **Arguments** to pass to the script and click **Save New Action**

6.3.5 Send SNMP Trap

Click on **Send SNMP Trap** as the **Add Trigger Action**. Enter a unique **Action Name** and set the **Action Delay Time**

The SNMP Trap actions are valid for Serial, WebUI & CLI Login, Environmental, UPS and Cellular data triggers

6.3.6 Send Nagios Event

1. Click on **Send Nagios Event** as the **Add Trigger Action**. Enter a unique **Action Name** and set the **Action Delay Time**
2. Edit the **Nagios Event Message** text to display on the Nagios status screen for the service
3. Specify the **Nagios Event State** (OK, Warning, Critical or Unknown) to return to Nagios for this service
4. Click **Save New Action**

NOTE To notify the central Nagios server of Alerts, NSCA must be enabled under **System > Nagios** and Nagios must be enabled for each applicable host or port

6.3.7 Perform Interface Action

1. Click on **Perform Interface Action** as the **Add Trigger Action**. Enter a unique **Action Name** and set the **Action Delay Time**
2. **Select the Interface** (Modem or VPN service) and the **Action** (Start or Stop Interface) to take. You can start an IPsec VPN service in response to an incoming SMS or set up an OpenVPN tunnel whenever your Opendgear device fails over to use the cellular connection.

Trigger Actions

Add Trigger Action

- Send Email
- Send SMS
- Switch DIO Line
- Perform RPC Action
- Run Custom Script
- Send SNMP Trap
- Send Nagios Event
- Perform Interface Action

Network Interface Event Action

Action Name Restart VPN Service
Unique name for this action

Action Delay Time 1
Time after the Auto-Response triggers to perform this action

Interface IPSec VPN Service
The Interface to perform the action on
Note that only dialout modems and VPN interfaces can currently be controlled by Auto-Response, and the "Controlled by Auto-Response" checkbox needs to be ticked in the configuration for these interfaces

Action Start Interface
The action to perform on the selected interface.

Save New Action

Scheduled Trigger Actions

Delay Time	Action Name	Action Type	Modify	Delete
1	Restart VPN Service	conman		

NOTE If any IPsec service or OpenVPN tunnel is to be controlled by the Network Interface Event Action, check the **Control by Auto-Response** box when configuring that service. Once selected, the default state for the VPN tunnel / service is Down

6.4 Resolve Actions

Actions can be scheduled when a trigger condition has been resolved. Resolve Actions are configured in the same way as Trigger Actions.

For a nominated Auto-Response - with a defined trigger Check Condition - click on **Add Resolve Action** (e.g. Send Email or Run Custom Script) to select the action type to take

Resolve Actions

Add Resolve Action

- Send Email
- Send SMS
- Perform RPC Action
- Run Custom Script
- Send SNMP Trap
- Send Nagios Event

SMS Action

Action Name [text box]
Unique name for this action

Phone number [text box]
Phone number in international format, without the +

Message Text
STIMESTAMP: This action was run
- Check details: value \$AR_VAL
vs trigger value \$AR_TRIGGER_VAL
The text of the SMS to send. Longer messages will be split up

Save New Action

Scheduled Resolve Actions

Action Name	Action Type	Modify	Delete
Notify client	email		
Close help desk ticket	nagios		

6.5 Configure SMTP, SMS, SNMP and/or Nagios service for alert notifications

The Auto-Response facility enables sending remote alerts as Trigger and Resolve Actions. Before alert notifications can be sent, you must configure the nominated alert service.

6.5.1 Send Email alerts

The console server uses SMTP (Simple Mail Transfer Protocol) for sending the email alert notifications. To use SMTP, an administrator must configure a valid SMTP server for sending the email:

1. Select **Alerts & Logging > SMTP &SMS**

SMTP Server	
Server	<input type="text"/> The outgoing mail server address.
Secure Connection	<input type="button" value="None"/> If this server uses a secure connection, specify its type.
SMTP port	<input type="text"/> Specify the SMTP port. Default is 25
Sender	<input type="text"/> The 'from' address which will appear on the sent email.
Username	(Currently empty) <input type="text"/> If this server requires authentication, specify the username.
Password	<input type="text"/> If this server requires authentication, specify the password.
Confirm	<input type="text"/> Re-enter the password.
Authentication Method	<input type="button" value="Automatic"/> Allows authentication to be overridden should autodetection fail.
Subject Line	(Currently empty) <input type="text"/> If this server requires a specific subject line, specify it here.
SMS Settings	
SMS Gateway	<input type="radio"/> Use an external SMS gateway
Cellular Modem	<input checked="" type="radio"/> Use an attached or internal Cellular Modem

- In the **SMTP Server** field enter the IP address of the outgoing mail **Server**
- If this mail server uses a **Secure Connection**, specify its type. You may also specify the IP port to use for SMTP. The default **SMTP Port** is 25.
- Enter a **Sender** email address which appears as the **from** address in all email notifications sent from this console server.
- Enter a **Username** and **Password** if the SMTP server requires authentication
- Specify the **Subject Line** for the email
- Click **Apply** to activate SMTP

6.5.2 Send SMS alerts

You can use email-to-SMS services to send SMS alert notifications to mobile devices. Almost all mobile phone carriers provide an SMS gateway service that forwards email to mobile phones on their networks. There's also a wide selection of SMS gateway aggregators who provide email to SMS forwarding to phones on any carriers.

Alternately if your console server has an embedded or externally attached cellular modem, you have the option to send the SMS directly over the carrier connection.

SMS via Email Gateway

To use SMTP SMS, an administrator must configure a valid SMTP server for sending the email:

User Manual

SMS via Email Gateway
Server
The outgoing SMTP SMS server address
Secure Connection
If this server uses a secure connection, specify its type.
SMTP port
Specify the SMTP port. Default is 25
Sender
The 'from' address which will appear on the sent email.
Username
If this server requires authentication, specify the username.
Password
If this server requires authentication, specify the password.
Confirm
Re-enter the password.
Authentication Method
Allows authentication to be overridden should autodetection fail.
Subject Line
If this server requires a specific subject line, specify it here.
Apply Settings

1. In the **SMTP Settings** field in the **Alerts & Logging > SMTP &SMS** menu select **SMS Gateway**. An **SMS via Email Gateway** field appears
2. Enter the IP address of the outgoing mail **Server** SMS gateway
3. Select a **Secure Connection** (if applicable) and specify the **SMTP port** (if other than the default port 25)
4. Enter a **Sender** email address as the **from** address in all email notifications sent from this console server. Some SMS gateway service providers only forward email to SMS when the email has been received from authorized senders.
5. Enter a **Username** and **Password** as some SMS gateway service providers use SMTP servers which require authentication
6. Enter the **Subject Line** for the email. The email subject will contain a truncated version of the alert notification message, contained in full in the body of the email. Some SMS gateway service providers require blank subjects or authentication headers included in the subject line
7. Click **Apply Settings** to activate SMS-SMTP connection.

SMS via Cellular Modem

To use an attached or internal cellular modem for SMS, an administrator must enable SMS:

SMS Settings

SMS Gateway Use an external SMS gateway

Cellular Modem Use an attached or Internal Cellular Modem

SMS via Cellular Modem

SMS Message Centre
This is the phone number of the SMS Message Centre (SMSC)
Only set this if asked to by support

Apply Settings

1. Select **Cellular Modem** in the **SMS Settings** field
2. You may need to enter the phone number of the carrier's **SMS Message Centre** if advised by your carrier or Support
3. Click **Apply Settings** to activate SMS-SMTP connection

6.5.3 Send SNMP Trap alerts

An administrator can configure the Simple Network Management Protocol (SNMP) agent that resides on the console server to send SNMP trap alerts to an NMS management application:

1. Select **Alerts & Logging > SNMP**
2. Select **Primary SNMP Manager** tab. The Primary and Secondary SNMP Manager tabs are used to configure where and how outgoing SNMP alerts and notifications are sent. If you require your console server to send alerts via SNMP, at a minimum, a Primary SNMP Manager must be configured. Optionally, a second SNMP Network Manager with its own SNMP settings can be specified on the **Secondary SNMP Manager** tab

Alerts & Logging: SNMP

SNMP Service Details | **Primary SNMP Manager** | Secondary SNMP Manager

Manager Protocol: UDP
The transport protocol to use to connect to the SNMP Manager.

Manager Address:
The address of the SNMP Manager to receive traps.

Manager Trap Port: 162
The TCP/UDP port number to send SNMP traps to.

Version:
The SNMP protocol to use for traps.

SNMP v1 & v2c

Community:
The SNMP Community to use for traps.

SNMP v3

Engine ID:
The SNMPv3 Engine ID for the trap manager.

Security Level:
 noAuthNoPriv
 authNoPriv
 authPriv
The SNMPv3 Security Level. 'authPriv' is recommended for enforcing both authentication and encryption.

Username:
The SNMPv3 user to send traps as.

Auth. Protocol: SHA
The SNMPv3 authentication protocol.

Auth. Password:
The SNMPv3 users authentication password.

Confirm Password:
Confirm the SNMPv3 users authentication password.

Privacy Protocol: DES
The SNMPv3 encryption protocol.

Privacy Password:
The SNMPv3 encryption password.

Confirm Password:
Confirm the SNMPv3 encryption password.

3. Select the **Manager Protocol**. SNMP is generally a **UDP**-based protocol though infrequently it uses **TCP** instead.
4. Enter the host address of the SNMP Network Manager into the **Manager Address** field.
5. Enter the TCP/IP port number into the **Manager Trap Port** field (default =162).
6. Select the **Version** to use. The console server SNMP agent supports SNMP v1, v2 and v3
7. Enter the **Community** name for SNMP v1 or SNMP v2c. Set a community for either SNMP v1 or v2c traps to work. An SNMP community is the group to which devices and management stations running SNMP belong and defines where information is sent. SNMP default communities are private for Write and public for Read.
8. Configure **SNMP v3** if required. For SNMP v3 messages, the user's details and security level must match what the receiving SNMP Network Manager is expecting. SNMP v3 mandates that the message is rejected unless the SNMPv3 user sending the trap already exists in the user database on the SNMP Manager. The user database in a SNMP v3 application is referenced by a combination of the username and the Engine ID for the given SNMP application you are talking to.
 - o Enter the **Engine ID** for the user sending messages as a hex number e.g. 0x800000001020304.

- Specify the **Security Level**. The level of security has to be compatible with the settings of the remote SNMP Network Manager.

noAuthNoPriv	No authentication or encryption.
authNoPriv	Authentication only. An authentication protocol (SHA or MD5) and password is required.
authPriv	Uses both authentication and encryption. This is the highest level of security and requires an encryption protocol (DES or AES) and password in addition to the authentication protocol and password.

- Complete the **Username**. This is the Security Name of the SNMPv3 user sending the message. This field is mandatory and must be completed when configuring the console server for SNMPv3.
- An **Authentication Protocol (SHA or MD5)** and **Authentication Password** must be given for a Security Level of either **authNoPriv** or **authPriv**. The password must contain at least 8 characters.
- A **Privacy Protocol (DES or AES)** must be specified for the **authPriv** level of security used as the encryption algorithm. AES is recommended for stronger security. A password of at least 8 characters must be provided for encryption to work.

9. Click **Apply**

6.5.4 Send Nagios Event alerts

To notify the central Nagios server of Alerts, NSCA must be enabled under **System > Nagios** and Nagios must be enabled for each applicable host or port under **Serial & Network > Network Hosts** or **Serial & Network > Serial Ports**.

NOTE In Lighthouse, you can check the Nagios alert option. On the trigger condition (for matched patterns, logins, power events and signal changes) an NSCA check warning result is sent to the central Nagios server. This condition is displayed on the Nagios status screen and triggers a notification, which can cause the Nagios central server to send out an email or an SMS, page, etc.

6.6 Logging

The console server can maintain log records of auto-response events and log records of all access and communications events (with the console server and with the attached serial, network and power devices).

A log of all system activity is also maintained by default, as is a history of the status of any attached environmental monitors.

6.6.1 Log storage

Before activating any Event, Serial, Network or UPS logging, you must specify where to save those logs. These records are stored off-server or in the ACM/IM gateway USB flash memory.

Select the **Alerts & Logging > Port Log** menu option and specify the **Server Type** and the details to enable log server access

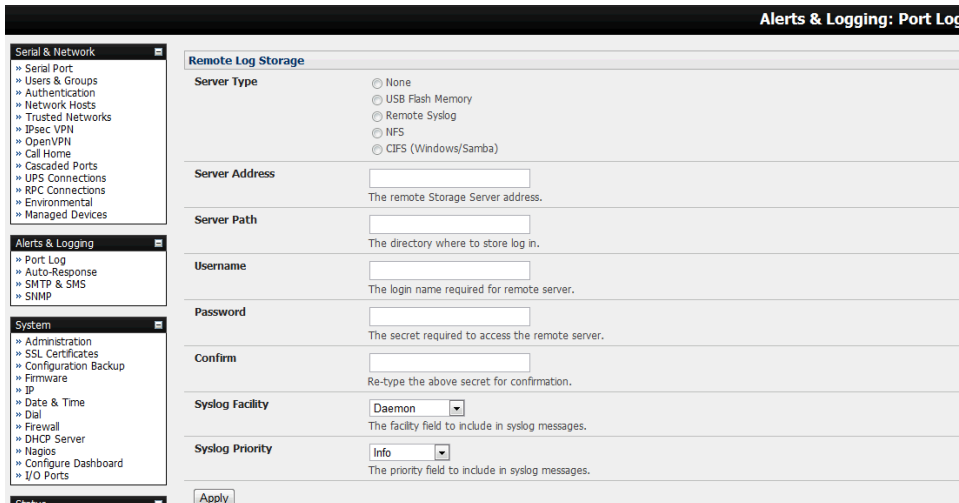

From the **Manage > Devices** menu, administrators can view serial, network and power device logs stored in the console reserve memory (or flash USB). Non-admin users only see logs for managed devices they or their group have access privileges for.

Event logs on the USB can be viewed using the web terminal or by SSH/Telnet connecting to the console server.

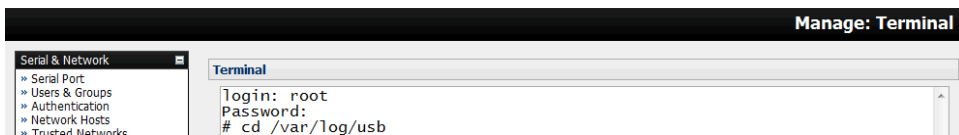

6.6.2 Serial port logging

In Console server mode, activity logs can be maintained of all serial port activity. To specify which serial ports are to have activities recorded and to what level of data to log:

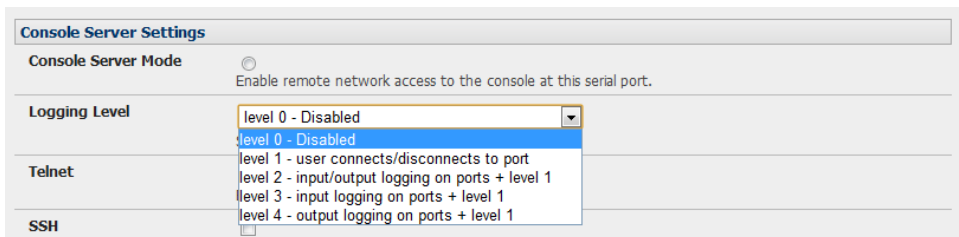

1. Select **Serial & Network > Serial Port** and **Edit** the port to log
2. Specify the **Logging Level** of for each port as:

- Level 0** Turns off logging for the selected port
- Level 1** Logs all user connection events to the port
- Level 2** Logs all data transferred to and from the port and all changes in hardware flow control status and all user connection events
- Level 3** Logs all data transferred from the port and all changes in hardware flow control status and all user connection events
- Level 4** Logs all data transferred to the port and all changes in hardware flow control status and all user connection events

3. Click **Apply**

NOTE A cache of the most recent 8K of logged data per serial port is maintained locally (in addition to the logs which are transmitted for remote/USB flash storage). To view the local cache of logged serial port data select **Manage > Port Logs**

6.6.3 Network TCP and UDP port logging

The console server support optional logging of access to and communications with network attached Hosts.

1. For each Host, when you set up the Permitted Services are authorized, you also must set up the logging level for each service

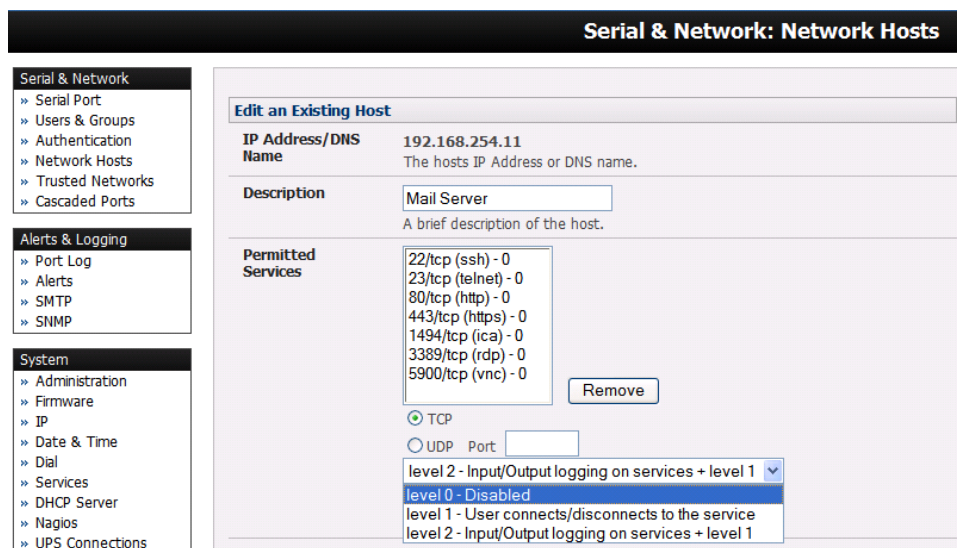

2. Specify the logging level that for that particular TDC/UDP port/service, on that particular Host:

- Level 0** Turns off logging for the selected TDC/UDP port to the selected Host
- Level 1** Logs all connection events to the port
- Level 2** Logs all data transferred to and from the port

3. Click **Add**. Click **Apply**

6.6.4 Auto-Response event logging

Check **Log Events** on **Alerts & Logging > Auto-Response** to enable logging all Auto-Response activities

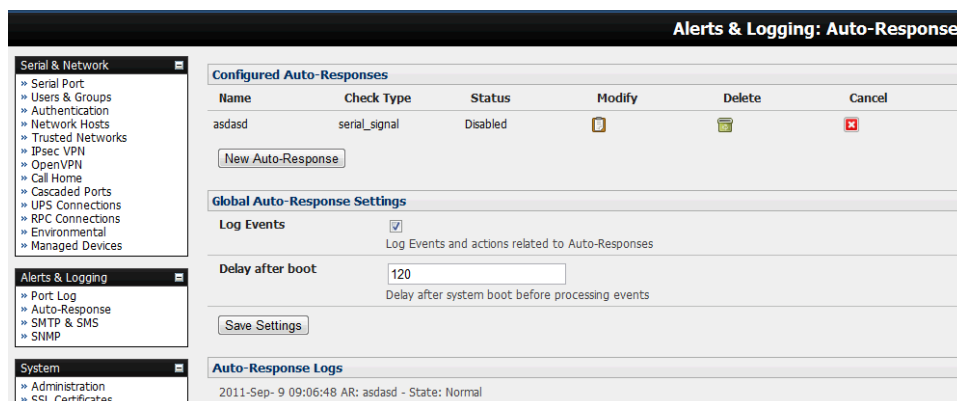

6.6.5 Power device logging

The console server also logs access and communications with network attached hosts and maintain a history of the UPS and PDU power status.

7 POWER, ENVIRONMENT & DIGITAL I/O

Opengear console servers manage Remote Power Control devices (RPCs including PDUs and IPMI devices) and Uninterruptible Power Supplies (UPSes). They also monitor remote operating environments using Environmental Monitoring Devices (EMDs) and sensors and can provide digital I/O control.

7.1 Remote Power Control (RPC)

The console server Management Console monitors and controls Remote Power Control (RPC) devices using the embedded PowerMan and Network UPS Tools open source management tools and Opengear's power management software. RPCs include power distribution units (PDUs) and IPMI power devices.

Serial PDUs can be controlled using their command line console, so you can manage the PDU through the console server using a remote Telnet client or proprietary software tools supplied by the vendor. This generally runs on a remote Windows PC and you could configure the console server serial port to operate with a serial COM port redirector in the PC. Network-attached PDUs can be controlled with a browser (e.g. with SDT) or an SNMP management package or using the vendor supplied control software. Servers and network-attached appliances with embedded IPMI service processors or BMCs are supplied with their own management tools (like SoL) that provide secure management when connected using with SDT Connector.

All of these devices can be controlled through the one window using the Management Console's RPC remote power control tools.

7.1.1 RPC connection

Serial and network connected RPCs must first be connected to, and configured to communicate with the console server:

1. For serial RPCs connect the PDU to the selected serial port on the console server and from the **Serial & Network > Serial Port** menu configure the **Common Settings** of that port with the RS232 properties required by the PDU. Select **RPC** as the **Device Type**
2. For each network connected RPC go to **Serial & Network > Network Hosts** menu and configure the RPC as a connected Host by specifying it as **Device Type > RPC** and clicking **Apply**

Serial & Network: Network Hosts

Serial & Network

- Serial Port
- Users & Groups
- Authentication
- Network Hosts
- Trusted Networks
- Cascaded Ports
- UPS Connections
- RPC Connections
- Environmental
- Managed Devices

Alerts & Logging

- Port Log
- Alerts
- SMTP & SMS
- SNMP

System

- Administration
- Firmware
- IP
- Date & Time
- Dial
- Services

IP Address/DNS Name: 192.168.0.54
The host's IP Address or DNS name.

Host Name: PDU-R3C
A descriptive name for this host.

Description/Notes: Baytech PDU Rack3C
A brief description of the host.

Permitted Services: 80/tcp (http) - 0
Remove

TCP
 UDP Port:
level 2 - Input/Output logging on services + level 1
Add

The TCP services available from this host.

Device Settings

Device Type: RPC

3. Select the **Serial & Network > RPC Connections** menu. This displays the RPC connections that have already been configured

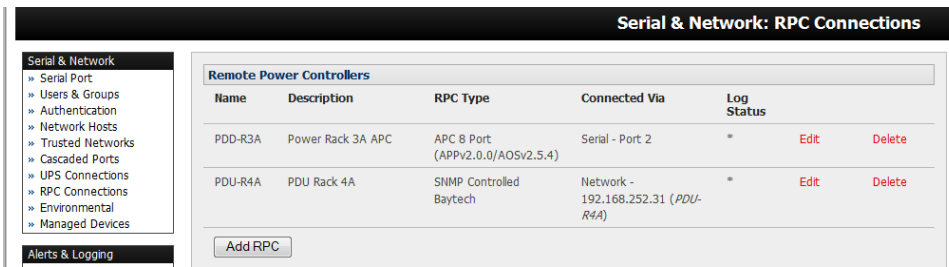

4. Click **Add RPC**

5. **Connected Via** presents a list of serial ports and network Host connections that you have set up with device type RPC (but have yet to connect to a specific RPC device):

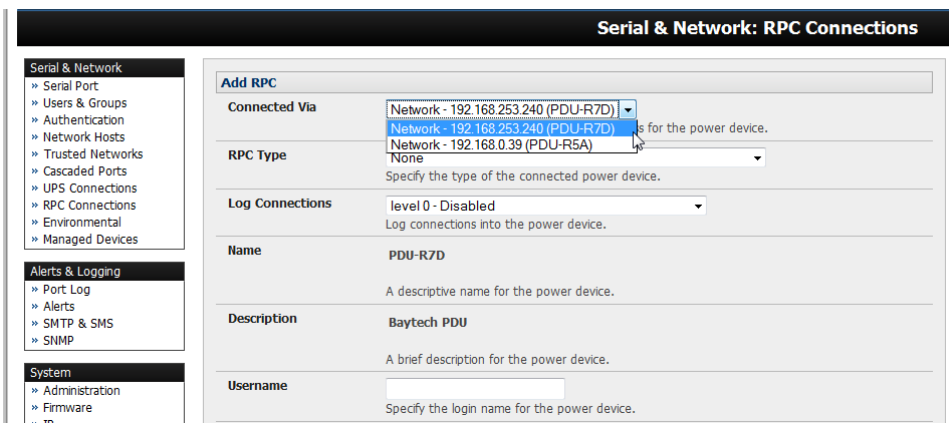

- If you select **Connect Via** for a Network RPC connection, enter the Host Name/Description that you set up for that connection as the **Name** and **Description** for the power device
- If you select **Connect Via** a Serial connection, enter a **Name** and **Description** for the power device

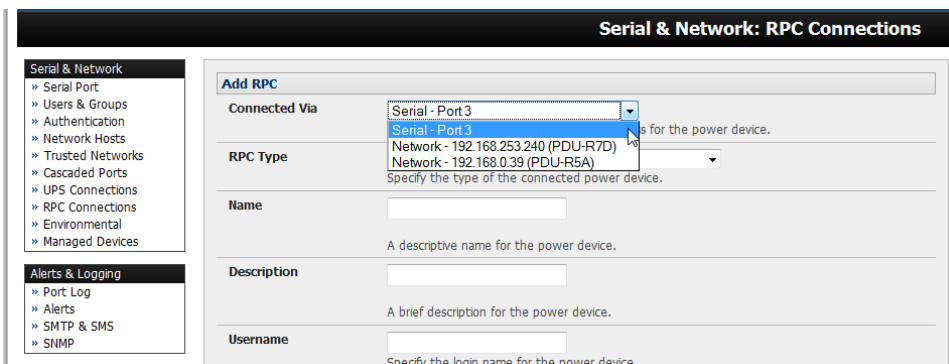

6. Select the appropriate **RPC Type** for the PDU (or IPMI) being connected:

- If you are connecting to the RPC via the network, you will be presented with the IPMI protocol options and the SNMP RPC Types supported by the embedded Network UPS Tools

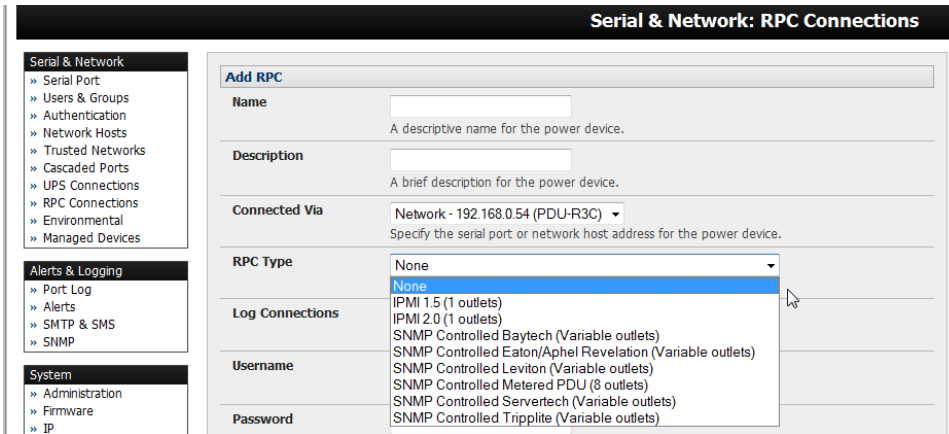

- If you are connecting to the RPC by a serial port, you will be presented with all the serial RPC types supported by the embedded PowerMan and Opengear's power manager:

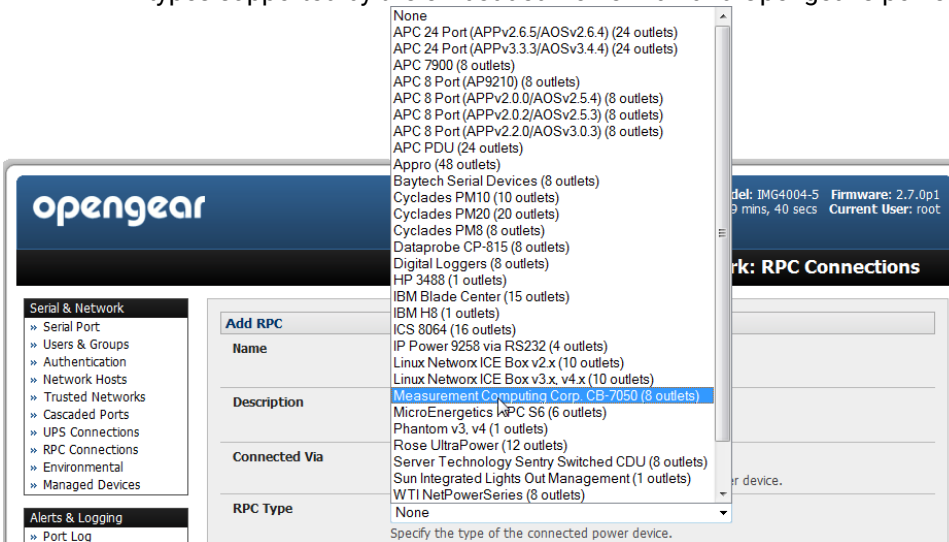

7. Enter the **Username** and **Password** used to login into the RPC. These login credentials are not related the users and access privileges you configured in **Serial & Networks > Users & Groups**.
8. If you selected SNMP protocol, enter the SNMP v1 or v2c Community for Read/Write access. By default, this is *private*.

Edit RPC

Name	PDU-R4A <small>A descriptive name for the power device.</small>
Description	<input type="text" value="PDU Rack 4A"/> <small>A brief description for the power device.</small>
Connected Via	Network - 192.168.252.31 (PDU-R4A) <small>Specify the serial port or network host address for the power device.</small>
RPC Type	SNMP Controlled Baytech <small>Specify the type of the connected power device.</small>
Username	<input type="text"/> <small>Specify the login name for the power device.</small>
Password	<input type="password"/> <small>Specify the login secret for the power device.</small>
Confirm	<input type="password"/> <small>Confirm the login secret for the power device.</small>
SNMP Community	<input type="text" value="private"/> <small>SNMP v1 or v2c Community for Read/Write access.</small>
Log Status	<input checked="" type="checkbox"/> <small>Periodically log RPC status.</small>
Log Rate	<input type="text" value="1"/> <small>Minutes between samples.</small>

9. Check **Log Status** and specify the **Log Rate** if you wish to log the status from this RPC. These logs can be views from the **Status > RPC Status** screen
10. Click **Apply**
11. For SNMP PDUs the console server probes the configured RPC to confirm the RPC Type matches and will report the number of outlets it finds that can be controlled. If unsuccessful it will report **Unable to probe outlets** and you'll need to check the RPC settings or network/serial connection

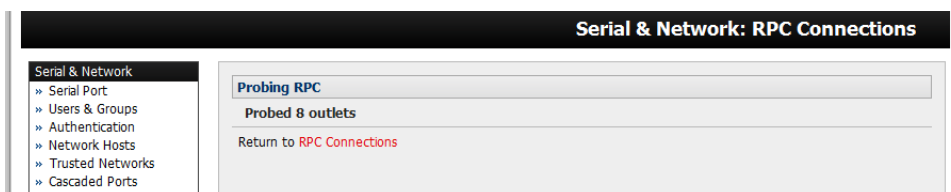

12. For serially connected RPC devices, a new managed device with the same name as given to the RPC will be created. The console server will configure the RPC with the number of outlets specified in the selected RPC Type or will query the RPC for this information

NOTE Opengear's console servers support the majority of the popular network and serial PDUs. If your PDU is not on the default list, support can be added directly or by having the PDU added to either the Network UPS Tools or PowerMan open source projects.

IPMI service processors and BMCs can be configured so all authorized users can use the Management Console to remotely cycle power and reboot computers, even when their operating system is unresponsive. To set up IPMI power control, an administrator enters the IP address/domain name of the BMC or service processor (e.g. a Dell DRAC) in **Serial & Network > Network Hosts**, in **Serial & Network > RPC Connections** specifies the **RPC Type** to be IPMI1.5 or 2.0

User Manual

7.1.2 RPC access privileges and alerts

Set PDU and IPMI alerts using **Alerts & Logging > Alerts**. You can also assign which user can access and control which particular outlet on each RPC using **Serial & Network > Users & Groups**

7.1.3 User power management

The Power Manager enables users to access and control the configured serial and network attached PDU power strips, and servers with embedded IPMI service processors or BMCs:

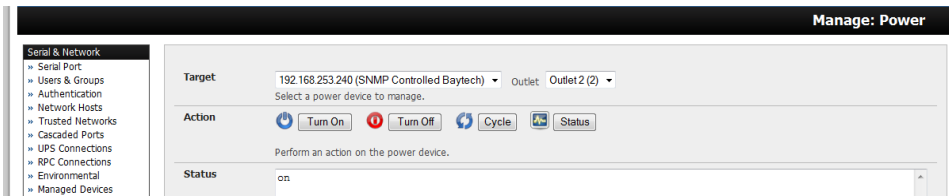

Select the **Manage > Power** and the particular **Target** power device to be controlled (and the Outlet to be controlled if the RPC supports outlet level control)

The outlet status is displayed. Initiate the desired **Action** to be taken by selecting the appropriate icon:



Turn ON



Turn OFF



Cycle



Status

You will be presented with icons for those operations that are supported by the **Target** you have selected.

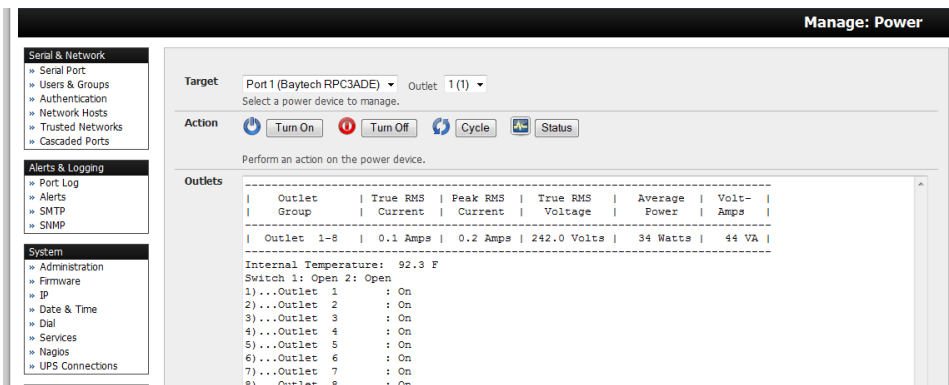

7.1.4 RPC status

You can monitor the current status of your network and serially connected PDUs and IPMI RPCs

1. Select the **Status > RPC Status** menu and a table with the summary status of all connected RPC hardware will be displayed

Name	Description	RPC Type	Connected Via	Outlet Status		
IPPower	IP Power 9825	IP Power 9258 via RS232	Serial - Port 1	N/A *	View Log	Manage
SR#3PDU	Power to rack SR 3	Server Technology Sentry Switched CDU	Network - 192.168.26.2 (SR#3 PDU)	N/A *		Manage
DRAC	VMWare Accounts	IPMI 2.0	Network - 192.168.26.45 (Dell DRAC)	N/A *		Manage

* Status unavailable or not supported by this summary, click *Manage* to query individual outlet status.

2. Click on **View Log** or select the **RPCLogs** menu and you will be presented with a table of the history and detailed graphical information on the selected RPC

Time	Temperature	Alert Status
Wed Mar 25 02:22:11 2009	33	Normal
Wed Mar 25 02:22:22 2009	33	Normal
Wed Mar 25 02:23:00 2009	33	Normal
Wed Mar 25 02:24:01 2009	33	Normal

3. Click **Manage** to query or control the individual power outlet. This will take you to the **Manage > Power** screen

7.2 Uninterruptible Power Supply(UPS) Control

All Opengear console servers can be configured to manage locally and remotely connected UPS hardware using Network UPS Tools.

Network UPS Tools (NUT) is a group of open source programs that provide a common interface for monitoring and administering UPS hardware; and ensuring safe shutdowns of the systems which are connected. NUT is built on a networked model with a layered scheme of drivers, server and clients.

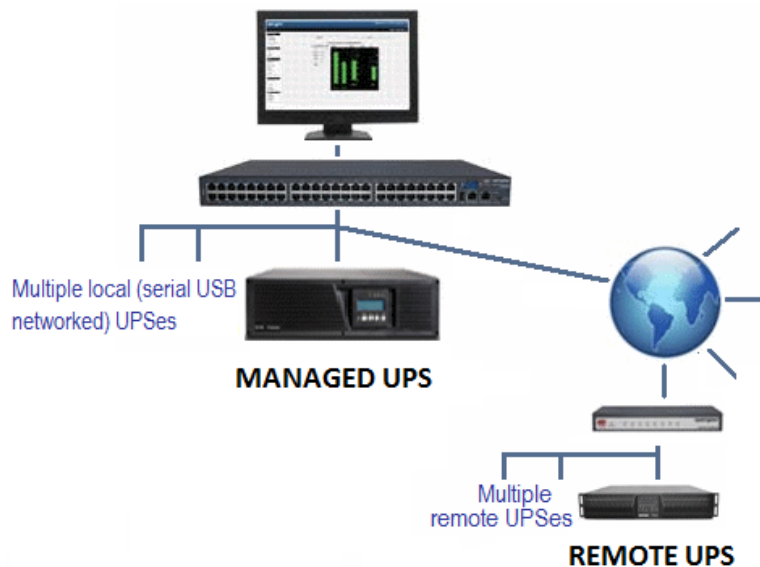

7.2.1 Managed UPS connections

A managed UPS is a UPS that is directly connected as a Managed device to the console server. It can be connected by serial or USB cable or by the network. The console server becomes the master of this UPS and runs a upsd server to allow other computers that are drawing power through the UPS (slaves) to monitor the UPS status and take appropriate action such as shutdown in event of low UPS battery.

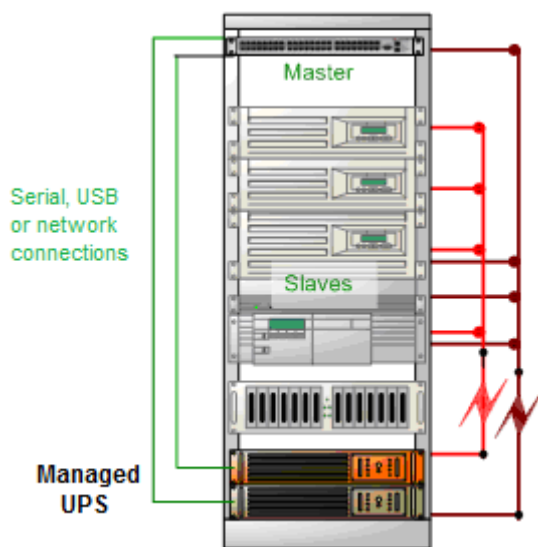

The console server may or may not be drawing power itself through the Managed UPS. When the UPS's battery power reaches critical, the console server signals and waits for slaves to shut down and powers off the UPS.

Serial and network connected UPSes must first be connected to, and configured to communicate with the console server:

1. For serial UPSes attach the UPS to the selected serial port on the console server. From the **Serial & Network > Serial Port** menu, configure the **Common Settings** of that port with the RS232 properties required by the UPS and select **UPS** as the **Device Type**

- For each network connected UPS, go to **Serial & Network > Network Hosts** menu and configure the UPS as a connected Host by specifying it as **Device Type > UPS** and clicking **Apply**

Device Settings

Device Type: UPS
Specify the device type.

Apply this setting, then use the [UPS Connections page](#) to configure the attached UPS.

No such configuration is required for USB connected UPS hardware

Serial & Network: UPS Connections

Serial & Network

- » Serial Port
- » Users & Groups
- » Authentication
- » Network Hosts
- » Trusted Networks
- » IPsec VPN
- » OpenVPN
- » Call Home
- » Cascaded Ports
- » UPS Connections
- » RPC Connections
- » Environmental
- » Managed Devices

Alerts & Logging

- » Port Log

Managed UPSes

UPS Name	Description	Driver	Username	Connected Via		
APC750_East_End	Upstairs Closet	usbhid-ups		USB	Edit	Delete

[Add Managed UPS](#)

Remote UPSes

UPS Name	Description	Address		
APC750_North_End	APCNorth	192.168.1.55	Edit	Delete

[Add Remote UPS](#)

- Select the **Serial & Network > UPS Connections** menu. The **Managed UPSes** section will display all the UPS connections that have already been configured.

- Click **Add Managed UPS**

Serial & Network: UPS Connections

Serial & Network

- » Serial Port
- » Users & Groups
- » Authentication
- » Network Hosts
- » Trusted Networks
- » IPsec VPN
- » OpenVPN
- » Call Home
- » Cascaded Ports
- » UPS Connections
- » RPC Connections
- » Environmental
- » Managed Devices

Alerts & Logging

- » Port Log
- » Alerts
- » SMTP & SMS
- » SNMP

System

- » Administration
- » SSL Certificates
- » Configuration Backup
- » Firmware
- » IP
- » Date & Time
- » Dial
- » Firewall
- » DHCP Server
- » Nagios
- » Configure Dashboard
- » I/O Ports

Status

- » Port Access
- » Active Users
- » Statistics
- » Support Report
- » Syslog
- » UPS Status
- » RPC Status
- » Environmental Status
- » Dashboard

Manage

- » Devices

Edit Managed UPS

Connected Via USB
The UPS may be connected via USB, serial or network (HTTP, HTTPS or SNMP).

UPS Name APC750_East_End
The name of this UPS.

Description Upstairs Closet
An optional description.

Username
Allow slaves to connect using this username.

Password
Allow slaves to connect using this password.

Confirm
Re-enter the password.

On Critical Power
 Shut down this UPS only
 Shut down all Managed UPSes
 Run until failure
The action to take when battery power becomes critical for this UPS.

Shutdown Order
The order in which this UPS is shut down when any Managed UPS is set to *Shutdown all Managed UPSes*. 0s are shut down first, then 1s, 2s, etc. and -1s are never shut down. Defaults to 0.

Driver usbhid-ups
The driver for this UPS model, see the [hardware compatibility list](#) for details.

Driver Options

Option	Argument
New Option	

Log Status
Periodically log UPS status.

Log Rate
Minutes between samples.

[Apply](#)

- Select if the UPS will be **Connected Via** USB or over pre-configured serial port or via SNMP/HTTP/HTTPS over the preconfigured network Host connection

160

User Manual

- When you select a network UPS connection, the corresponding Host Name/Description that you set up for that connection will be entered as the **Name** and **Description** for the power device. Alternately if you selected to **Connect Via** a USB or serial connection, enter a **Name** and **Description** for the power device (and these details will also be used to create a new managed device entry for the serial/USB connected UPS devices)
- Enter the login details. This **Username** and **Password** is used by slaves of this UPS (i.e. other computers that are drawing power through this UPS) to connect to the console server to monitor the UPS status so they can shut themselves down when battery power is low. Monitoring will be performed using the upsmon client running on the slave server.

NOTE These login credentials are not related the users and access privileges you will have configured in **Serial & Networks > Users & Groups**

- Select the action to take when UPS battery power becomes critical i.e. Shut down the UPS (or Shut down all Managed UPSes) or Run until failure

NOTE The shutdown script /etc/scripts/ups-shutdown can be customized so, in the event of a critical power failure (when the UPS battery runs out) you can perform program the console server to perform last gasp actions using before power is lost. See online FAQ for details. It is easier to perform last gasp actions by triggering Auto-Response on the UPS hitting batt or lowbatt.

- If you have more than one UPS and need to shut down in order, specify the **Shutdown Order** for this UPS. This is a whole positive number, or -1. 0s are shut down first, then 1s, 2s, etc. -1s are not shut down at all. Defaults to 0
- Select the **Driver** that will be used to communicate with the UPS

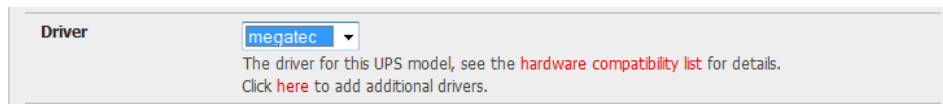

Driver megatec

The driver for this UPS model, see the [hardware compatibility list](#) for details.
Click [here](#) to add additional drivers.

- Click **New Options** in **Driver Options** if you need to set driver-specific options for your selected NUT driver and hardware combination

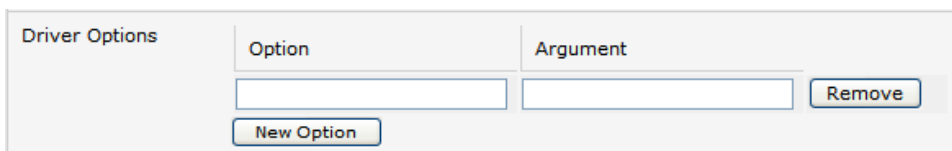

Option	Argument
<input type="text"/>	<input type="text"/>

- Check **Log Status** and specify the **Log Rate** (minutes between samples) if you wish the status from this UPS to be logged. These logs can be viewed from the **Status > UPS Status** screen
- If you have enabled Nagios services, an option for Nagios monitoring appears. Check **Enable Nagios** to enable this UPS to be monitored using Nagios central management

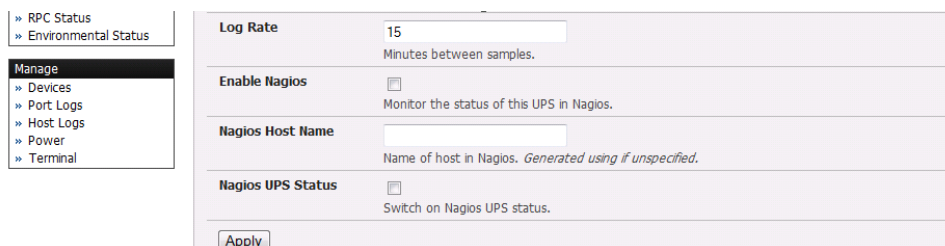

» RPC Status
» Environmental Status

Manage
» Devices
» Port Logs
» Host Logs
» Power
» Terminal

Log Rate
Minutes between samples.

Enable Nagios
Monitor the status of this UPS in Nagios.

Nagios Host Name
Name of host in Nagios. *Generated using if unspecified.*

Nagios UPS Status
Switch on Nagios UPS status.

14. Check **Enable Shutdown Script** if this is the UPS providing power to the console server and in the event of a critical power failure you can perform any last gasp actions on the console server before power is lost. This is achieved by placing a custom script in `/etc/config/scripts/ups-shutdown` (you may use the provided `/etc/scripts/ups-shutdown` as a template). This script is only run when the UPS reaches critical battery status

15. Click **Apply**

NOTE You can also customize the `upsmon`, `upsd` and `upsc` settings for this UPS hardware from the command line

7.2.2 Remote UPS management

A remote UPS is a UPS that is connected as a managed device to some remote console server which is being monitored (but not managed) by your console server.

The `upsc` and `uplog` clients in the Opengear console server can be configured to monitor remote servers that are running Network UPS Tools managing their locally connected UPSes. These remote servers might be other Opengear console servers or generic Linux servers running NUT. Distributed UPSes can be centrally monitored through the one central console server window. To add a Remote UPS:

The screenshot shows the 'Serial & Network: UPS Connections' page. On the left is a navigation menu with categories: Serial & Network, Alerts & Logging, and System. The main content area is divided into two sections: 'Managed UPSes' and 'Remote UPSes'.

UPS Name	Description	Driver	Username	Shutdown Order	Connected Via		
APC	Smart UPS	apcsmart	xx	0	Serial - Port #4 (Port 4)	Edit	Delete

UPS Name	Description	Address		
tripplite	SD4002 - SUINT1000RDXL2U	192.168.254.145	Edit	Delete

1. Select the **Serial & Network > UPS Connections** menu. The **Remote UPSes** section will display all the remote UPS devices being monitored
2. Click **Add Remote UPS**

The screenshot shows the 'Add Remote UPS' form. It includes the following fields and options:

- UPS Name:** Text input field with placeholder 'The name of this UPS.'
- Description:** Text input field with placeholder 'An optional description.'
- Address:** Text input field with placeholder 'The address or DNS name of the host managing this UPS.'
- Log Status:** A checkbox labeled 'Periodically log UPS status.'
- Log Rate:** A text input field with the value '15' and placeholder 'Minutes between samples.'
- Enable Shutdown Script:** A checkbox labeled 'Run the shutdown script when power becomes critical for this UPS.'

An 'Apply' button is located at the bottom of the form.

3. Enter the **Name** of the particular remote UPS to be remotely monitored. This name must be the name that the remote UPS is configured with on the remote console server, as the remote

console server may have multiple UPSes attached that it is managing locally with NUT. Optionally enter a **Description**

4. Enter the IP **Address** or DNS name of the remote console server* that is managing the remote UPS. (*This may be another Opengear console server or it may be a generic Linux server running Network UPS Tools)
5. Check **Log Status** and specify the **Log Rate** (minutes between samples) if you wish the status from this UPS to be logged. These logs can be viewed from the **Status > UPS Status** screen
6. Check **Enable Shutdown Script** if this remote UPS is the UPS providing power to the console server. In the event the UPS reaches critical battery status the custom script in `/etc/config/scripts/ups-shutdown` is run enabling you to perform any last gasp actions
7. Click **Apply**

7.2.3 Controlling UPS powered computers

One of the advantages of having a Managed UPS is that you can configure computers that draw power through that UPS to be shut down gracefully in the event of UPS problems.

For Linux computers this can be done by setting up upsmon on each computer and directing them to monitor the console server that is managing their UPS. This will set the conditions that will be used to initiate a power down of the computer. Non-critical servers may be powered down some second after the UPS starts running on battery, whereas more critical servers may not be shut down until a low battery warning is received.

An example upsmon.conf entry might look like:

```
MONITOR managedups@192.168.0.1 1 username password slave
```

- managedups is the UPS Name of the Managed UPS
- 192.168.0.1 is the IP address of the Opengear console server
- 1 indicates the server has a single power supply attached to this UPS
- username is the Username of the Managed UPS
- password is the Password of the Manager UPS

There are NUT monitoring clients available for Windows computers (WinNUT).

If you have an RPC (PDU) it is also possible to shut down UPS powered computers and other equipment without them having a client running (e.g. communications and surveillance gear). Set up a UPS alert and using this to trigger a script which control a PDU to shut off the power.

7.2.4 UPS alerts

You can set UPS alerts using **Alerts & Logging > Alerts**

7.2.5 UPS status

You can monitor the current status of your network, serially or USB connected Managed UPSes and any configured Remote UPSes

1. Select the **Status > UPS Status** menu and a table with the summary status of all connected UPS hardware will be displayed

2. Click on any particular UPS **System** name in the table. A more detailed graphical information on the select UPS System appears

3. Click on any particular **All Data** for any UPS System in the table for more status and configuration information on the select UPS System

```

Dev UPS
-----
battery.voltage      : 13.5
driver.name          : bcmcp_usb
driver.parameter.pollinterval : 2
driver.parameter.port : auto
driver.parameter.shutdown_delay : 60
driver.version       : 2.2.2
driver.version.internal : 0.14
input.frequency      : 49.9
input.voltage        : 244
output.current       : 0.1
output.frequency     : 49.9
output.phases        : 1
output.voltage       : 244
output.voltage.nominal : 240
ups.firmware         : Cont:00.50 Inve:01.50
ups.load             : 7.7
ups.model            : POWERWARE UPS 500VA
ups.power.nominal    : 500
ups.serial           :
ups.status           : OL
    
```

4. Select **UPS Logs**. The log table of the load, battery charge level, temperature and other status information from all the Managed and Monitored UPS systems appears. This information will be

logged for all UPSes which were configured with **Log Status** checked. The information is also presented graphically

Status: UPS Status

Serial & Network

- » Serial Port
- » Users & Groups
- » Authentication
- » Network Hosts
- » Trusted Networks
- » Cascaded Ports
- » UPS Connections
- » RPC Connections
- » Environmental
- » Managed Devices

Alerts & Logging

- » Port Log
- » Alerts
- » SMTP & SMS
- » SNMP

System

- » Administration
- » Configuration Backup
- » Firmware
- » IP
- » Date & Time

Summary blazer tripplite@sd4002

tripplite (SmartOnline) - Status Graph

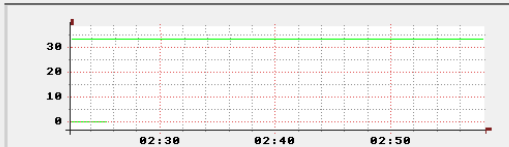

tripplite (SmartOnline) - Log

Date	Time	Battery Charge	Input Voltage	Load	Status	Temperature	Frequency
20090518	212100	100	237.3	0	Off		49.9
20090518	212200	100	237.3	0	Off		49.9
20090518	212300	100	235.8	0	Off		49.9

7.2.6 Overview of Network UPS Tools (NUT)

NUT is built on a networked model with a layered scheme of drivers, server and clients. NUT can be configured using the Management Console as described above, or you can configure the tools and manage the UPSes from the command line. This section provides an overview of NUT. You can find full documentation at <http://www.networkupstools.org/documentation>.

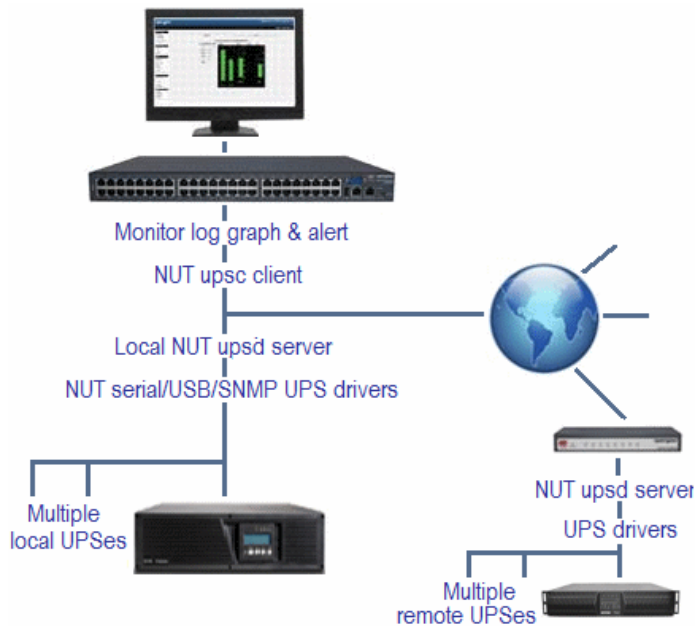

NUT is built on a networked model with a layered scheme of drivers, server and clients:

- The **driver** programs talk to the UPS equipment and run on the same host as the NUT network server (upsd). Drivers are provided for a wide assortment of equipment from most of the popular UPS vendors and understand the language of each UPS. They communicate to serial, USB and SNMP network connected UPS hardware and map the communications back to a compatibility layer. This means both an expensive smart protocol UPS and a power strip model can be handled transparently

- The NUT network **server** program `upsd` is responsible for passing status data from the drivers to the client programs via the network. `upsd` can cache the status from multiple UPSes and serve this status data to many clients. `upsd` also contains access control features to limit the abilities of the clients (e.g. so only authorized hosts may monitor or control the UPS hardware)
- There are a number of NUT **clients** that connect to `upsd` to check on the status of the UPS hardware and do things based on the status. These clients can run on the same host as the NUT server or they can communicate with the NUT server over the network (enabling them to monitor any UPS anywhere):
 - The `upsc` client provides a quick way to poll the status of a UPS server. It can be used inside shell scripts and other programs that need UPS data but don't want to include the full interface
 - The `upsmon` client enables servers that draw power through the UPS to shutdown gracefully when the battery power reaches critical
 - There are also logging clients (`upslog`) and third-party interface clients (Big Sister, Cacti, Nagios, Windows and more)
- The latest release of NUT (2.4) also controls PDU systems. It can do this either natively using SNMP or through a binding to Powerman (open source software from Livermore Labs that also is embedded in Opengear console servers)

These NUT clients and servers all are embedded in each Opengear console server (with a Management Console presentation layer added) ... and they also are run remotely on distributed console servers and other remote NUT monitoring systems. This layered distributed NUT architecture enables:

- Multiple manufacturer support: NUT can monitor UPS models from 79 different manufacturers - and PDUs from a growing number of vendors - with a unified interface
- Multiple architecture support: NUT can manage serial and USB connected UPS models with the same common interface. Network connected USB and PDU equipment can also be monitored using SNMP
- Multiple clients monitoring the one UPS: Multiple systems may monitor a single UPS using only their network connections and there's a wide selection of client programs which support monitoring UPS hardware via NUT (Big Sister, Cacti, Nagios and more)
- Central management of multiple NUT servers: A central NUT client can monitor multiple NUT servers that may be distributed throughout the data center, across a campus or around the world

NUT supports the more complex power architectures found in data centers, communications centers and distributed office environments where many UPSes from many vendors power many systems with many clients - and each of the larger UPSes power multiple devices - and many of these devices are in turn dual powered



7.3 Environmental Monitoring

All Opengear console servers can be configured to monitor their operating environment.

External Environmental Monitor Devices (EMDs) can be connected to any Opengear console server serial port. Each console server can support multiple EMDs.

Each EMD device has an internal temperature and humidity sensor plus one or two general purpose status sensor ports which can be connected to smoke detectors, water detectors, vibration sensors or open-door sensors.

Using the Management Console, administrators can view the ambient temperature (in °C or °F) and humidity (percentage) and configure alerts to monitor the status and sensors to send alarms progressively from warning levels to critical.

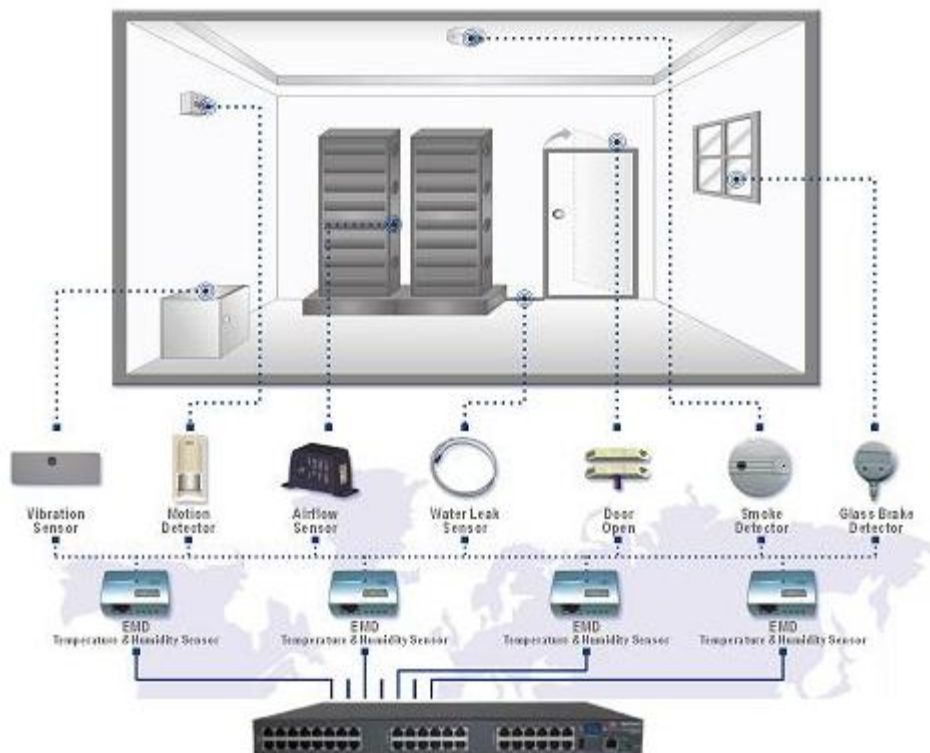

7.3.1 Connecting the EMD and its sensors

The Environmental Monitor Device (EMD) connects to any serial port on the console server via a special EMD Adapter and standard CAT5 cable. The sensors screw into the EMD:



EMD

1. The EMD is powered over the serial port connection and communicates using a custom handshake protocol. It is not an RS232 device and should not be connected without the adapter



EMD Adapter



EMD sensor

2. Plug the male RJ plug on the EMD Adapter into the EMD. Connect the Adapter to the console server serial port using the provided UTP cable. If the 6-foot (2 meter) UTP cable provided with the EMD is not long enough it can be replaced with a standard Cat5 UTP cable up to 33 feet (10 meters) in length
3. Screw the bare wires on any smoke detector, water detector, vibration sensor, open-door sensor or general purpose open/close status sensors into the terminals on the EMD

NOTE You can attach two sensors onto the terminals on EMDs that are connected to console servers with Opegear Classic pinouts. Console servers with -01 and -02 pinouts only support attaching a single sensor to each EMD

The EMD can only be used with an Opegear console server and cannot be connected to standard RS232 serial ports on other appliances.

1. Select **Environmental** as the **Device Type** in the **Serial & Network > Serial Port** menu for the port to which the EMD is to be attached. No particular Common Settings are required.
2. Click **Apply**

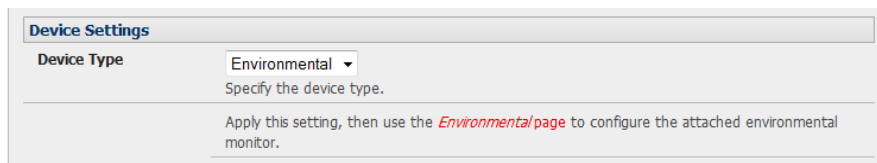
A screenshot of a web interface showing the 'Device Settings' for a serial port. The 'Device Type' dropdown menu is set to 'Environmental'. Below the dropdown, there is a note: 'Apply this setting, then use the [Environmental page](#) to configure the attached environmental monitor.'

7.3.2 Connecting sensors to ACM7000s

ACM7000 models ship with an in-built, black, spring cage I/O connector block for attaching environmental sensors and digital I/O devices.

ACM7000 models have dedicated I/O (DIO1 & DIO2) and output only pins (OUT1 & OUT2), the later having inverting outputs with higher voltage/current transistor.

1. To confirm the direction and state configurations for these ports you can select the **System > I/O Ports** menu and a table with the summary status of the four digital I/O ports will be displayed. I/O Port1 = DIO1 or SENSOR1, I/O Port2 = DIO2 or SENSOR2, I/O Port3 = SENSOR3 and I/O Port4 = SENSOR 4)

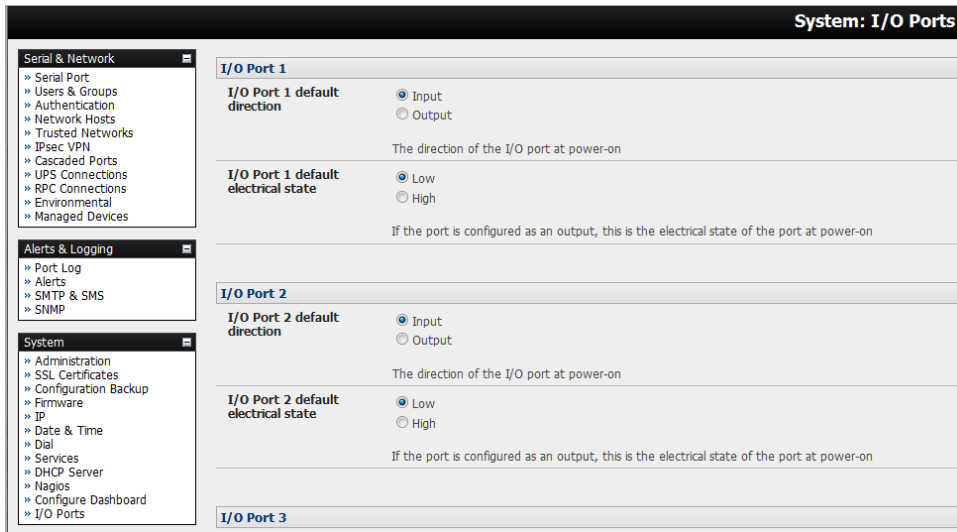

2. Screw the bare wires on any smoke detector, water detector, vibration sensor, open-door sensor or general purpose open/close status sensors into the SENSOR or DIO terminals on the green connector block



3. When configured as Inputs, the SENSOR and DIO ports are notionally attached to the internal EMD. Go to the **Serial & Network > Environmental** page and enable the **Internal EMD**. Configure the attached sensors as alarms as covered in the next section

7.3.3 Adding EMDs and configuring the sensors

1. Select the **Serial & Network > Environmental** menu. This will display any external EMDs or any internal EMD (i.e. sensors that may be attached to an ACM) that have already been configured

2. To add a new EMD click **Add** and configure an external EMD enter a **Name** and optionally a **Description** and select the pre-configured serial port that the EMD will be **Connected Via**

Serial & Network: Environmental

- Serial & Network
 - » Serial Port
 - » Users & Groups
 - » Authentication
 - » Network Hosts
 - » Trusted Networks
 - » Cascaded Ports
 - » UPS Connections
 - » RPC Connections
 - » Environmental
 - » Managed Devices
- Alerts & Logging
 - » Port Log
 - » Alerts
 - » SMTP & SMS
 - » SNMP
- System
 - » Administration
 - » SSL Certificates
 - » Configuration Backup
 - » Firmware
 - » IP
 - » Date & Time
 - » Dial
 - » Services
 - » Nagios
 - » Configure Dashboard
- Status
 - » Port Access
 - » Active Users
 - » Statistics
 - » Support Report
 - » Syslog
 - » UPS Status

Add Environmental Monitor

Name	<input type="text"/> <small>A descriptive name for the environmental monitor.</small>
Connected Via	Serial - Port #1 (Port 1) <input type="text"/> <small>Specify the connection port for the environmental monitor.</small>
Description	<input type="text"/> <small>A brief description for the environmental monitor.</small>
Temperature Offset	<input type="text"/> <small>Fine tuning adjustment for the temperature sensor.</small>
Humidity Offset	<input type="text"/> <small>Fine tuning adjustment for the humidity sensor.</small>
Temperature in Fahrenheit	<input type="checkbox"/> <small>Indicates if the temperature is reported in Fahrenheit rather than Celcius</small>
Alarm #1 Label	<input type="text"/> <small>A label for this alarm sensor, e.g. <i>Door Open</i> or <i>Smoke Alarm</i>.</small>
Alarm #2 Label	<input type="text"/> <small>A label for this alarm sensor, e.g. <i>Door Open</i> or <i>Smoke Alarm</i>.</small>
Log Status	<input type="checkbox"/> <small>Periodically log environmental status.</small>
Log Rate	15 <input type="text"/> <small>Minutes between samples.</small>

3. You may optionally calibrate the EMD with a Temperature Offset (+ or - °C) or Humidity Offset (+ or percent). If you check **Temperature in Fahrenheit**, the temperature will be reported in Fahrenheit. Otherwise it will be reported in degrees Celsius
4. Provide **Labels** for each of the alarm sensors e.g. Door Open or Smoke Alarm.
5. Check **Log Status** and specify the **Log Rate** (minutes between samples) if you wish the status from this EMD to be logged. These logs can be views from the **Status > Environmental Status** screen
6. Click **Apply**. This will also create a new managed device (with the same name)

Serial & Network: Environmental

- Serial & Network
 - » Serial Port
 - » Users & Groups
 - » Authentication
 - » Network Hosts
 - » Trusted Networks
 - » IPsec VPN
 - » Cascaded Ports
 - » UPS Connections
 - » RPC Connections
 - » Environmental
 - » Managed Devices
- Alerts & Logging
 - » Port Log
 - » Alerts
 - » SMTP & SMS
 - » SNMP
- System
 - » Administration
 - » SSL Certificates
 - » Configuration Backup
 - » Firmware
 - » IP
 - » Date & Time
 - » Dial
 - » Services
 - » Nagios
 - » Configure Dashboard

Enabled
Enable or disable this internal sensor

Edit Environmental Monitor

Name	Internal environmental sensor <small>A descriptive name for the environmental monitor</small>
Connected Via	internal <small>Specify the serial port for the environmental monitor</small>
Description	<input type="text"/> <small>A brief description for the environmental monitor</small>
Temperature Offset	0 <small>Fine tuning adjustment for the Temperature Sensor</small>
Alarm #1 Label	alarm1 <small>A label for this environmental monitor alarm, e.g. <i>Door Open</i></small>
Alarm #2 Label	alarm2 <small>A label for this environmental monitor alarm, e.g. <i>Door Open</i></small>
Alarm #3 Label	alarm3 <small>A label for this environmental monitor alarm, e.g. <i>Door Open</i></small>
Alarm #4 Label	alarm4 <small>A label for this environmental monitor alarm, e.g. <i>Door Open</i></small>

7.3.4 Environmental alerts

Set temperature, humidity and probe status alerts using **Alerts & Logging > Alerts**

7.3.5 Environmental status

You can monitor the current status of all any configured external EMDs and their sensors, and any internal or directly attached sensors

1. Select the **Status > Environmental Status** menu and a table with the summary status of all connected EMD hardware will be displayed

2. Click on **View Log** or select the **Environmental Logs** menu. A table and graphical plot of the log history of the select EMD appears.

Time	Temperature	Humidity	Alarm #1	Alarm #2	Alert Status
Fri Jan 16 20:37:05 2009	24	51	Open (0)	Open (0)	Normal
Fri Jan 16 20:38:05 2009	24	47	Open (0)	Open (0)	Normal

7.4 Digital I/O Ports

ACM7000 models ship with an in-built, black, spring cage I/O connector block for attaching environmental sensors and digital I/O devices.



These I/O ports are configured via System > I/O Ports. Each port can be configured with a default direction and state.

Select the **System > I/O Ports** menu

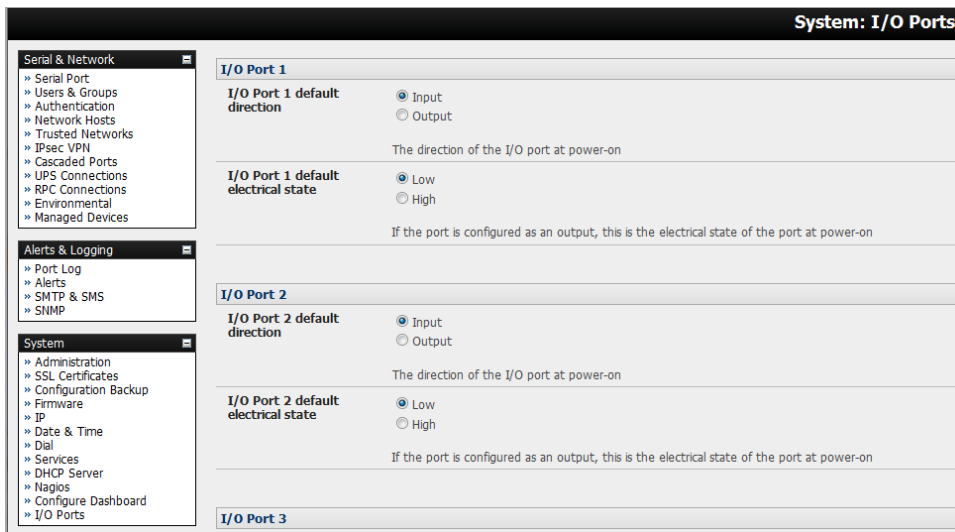

7.4.1 Digital I/O Output Configuration

Each of the two digital I/O ports (DIO1 and DIO2) can be configured as an Input or Output port. To use them as digital outputs first configure the port direction on the **System > I/O Ports** menu page.

The DIO1 and DIO2 pins are current limited by the chip to 20mA and accept 5V levels – so they cannot drive a relay etc.

Alternately you can change the output states using the ioc command line utility. The following text is the usage message from the ioc usage:

ioc: digital io-port controller:

```
-p    pin_num      pin number (1 to 4)
-d    pin_dir     pin direction (0 = output 1 = input)
-v    pin_val     pin electrical value in output mode (0 = low 1 = high)
-r                    reset pins to all inputs and low
-g                    displays the pin directions and current values
-l                    load pin configuration from configlity
```

For example, to set pin 1 to a low output, type:

```
ioc -p 1 -d 0 -v 0
```

To pulse one of these outputs, use a script like the following:

```
ioc -p 1 -d 0 -v 1
```

```
sleep 1
```

```
ioc -p 1 -d 0 -v 0
```

This will set the output high for 1 second, return it to low (assuming the initial state is low)

7.4.2 Digital I/O Input Configuration

When either of the two digital I/O (DIO1 & DIO2) outlets is configured as an Input on the **System > I/O Ports**, it can be used to monitor the current status of any attached sensor.

When configured as inputs (and this is the factory default) these first two ports are notionally attached to an internal EMD. To configure them as alarms, go to the Environmental page and edit and enable the Internal EMD.

The low voltage circuits in DIO1 and DIO2 should not be wired to voltages greater than 5V DC.

These input ports can be monitored using the ioc command line utility (as detailed in the previous section)

7.4.3 High Voltage Outputs

OUT1 and OUT2 (internally DIO3 & DIO4) outlets are wired as high voltage outputs. The way these outputs are expected to be used is to pull a power connected line to ground (i.e. the OUT1 and OUT2 transistors are open collector).

The I/O port header includes a 12v reference line (VIN) which can be used to detect the line state change.

For example, to light a 12v LED using the high voltage outputs, connect the positive leg of the LED to the 12v reference, and the negative leg to output pin 4. Due to the way that the I/O port is connected internally, the output has to be set **high** to pull the output to ground.

The following command will switch on the led:

```
ioc -p 4 -d 0 -v 1
```

OUT1 and OUT2 transistors can operate with a supply of >5V to <= 30V @100mA. This means to drive a relay circuit you must guarantee it doesn't provide more than 100mA when set to 1.

7.4.4 DIO SNMP status

There is a SNMP status table (with V3.9 and later) which reports on the status of the digital IO ports. The table OID is OG-STATUSv2-MIB::ogEmdDioTable. Performing an snmpwalk on this table on a console server with DIO produces something like (will vary depending on device status):

```
$ snmpwalk -v2c -c public -M $MIBSDIR -m ALL t5:161
1.3.6.1.4.1.25049.16.5
OG-STATUS-MIB::ogDioStatusName.1 = STRING: DIO 1
OG-STATUS-MIB::ogDioStatusName.2 = STRING: DIO 2
OG-STATUS-MIB::ogDioStatusName.3 = STRING: DIO 3
OG-STATUS-MIB::ogDioStatusName.4 = STRING: DIO 4
OG-STATUS-MIB::ogDioStatusType.1 = INTEGER: ttlInputOutput(0)
OG-STATUS-MIB::ogDioStatusType.2 = INTEGER: ttlInputOutput(0)
OG-STATUS-MIB::ogDioStatusType.3 = INTEGER: highVoltageOutput(1)
OG-STATUS-MIB::ogDioStatusType.4 = INTEGER: highVoltageOutput(1)
OG-STATUS-MIB::ogDioStatusDirection.1 = INTEGER: input(1)
OG-STATUS-MIB::ogDioStatusDirection.2 = INTEGER: input(1)
OG-STATUS-MIB::ogDioStatusDirection.3 = INTEGER: input(1)
```

```
OG-STATUS-MIB::ogDioStatusDirection.4 = INTEGER: input(1)
OG-STATUS-MIB::ogDioStatusState.1 = INTEGER: low(0)
OG-STATUS-MIB::ogDioStatusState.2 = INTEGER: high(1)
OG-STATUS-MIB::ogDioStatusState.3 = INTEGER: high(1)
OG-STATUS-MIB::ogDioStatusState.4 = INTEGER: high(1)
OG-STATUS-MIB::ogDioStatusCounter.1 = Counter64: 0
OG-STATUS-MIB::ogDioStatusCounter.2 = Counter64: 0
OG-STATUS-MIB::ogDioStatusCounter.3 = Counter64: 0
OG-STATUS-MIB::ogDioStatusCounter.4 = Counter64: 0
OG-STATUS-MIB::ogDioStatusTriggerMode.1 = INTEGER: risingFallingEdge(3)
OG-STATUS-MIB::ogDioStatusTriggerMode.2 = INTEGER: risingFallingEdge(3)
OG-STATUS-MIB::ogDioStatusTriggerMode.3 = INTEGER: risingFallingEdge(3)
OG-STATUS-MIB::ogDioStatusTriggerMode.4 = INTEGER: risingFallingEdge(3)
```

8 AUTHENTICATION

The console server platform is a dedicated Linux computer, and it embodies a myriad of popular and proven Linux software modules for networking, secure access (OpenSSH) and communications (OpenSSL) and sophisticated user authentication (PAM, RADIUS, TACACS+, Kerberos and LDAP).

- This chapter details how an administrator uses the Management Console to establish remote AAA authentication for all connections to the console server and attached serial and network host devices
- This chapter also covers establishing a secure link to the Management Console using HTTPS and using OpenSSL and OpenSSH for establishing secure Administration connection to the console server

More details on RSA SecurID and working with Windows IAS can be found on the online FAQs.

8.1 Authentication Configuration

Authentication can be performed locally, or remotely using an LDAP, Radius, Kerberos or TACACS+ authentication server. The default authentication method for the console server is Local.

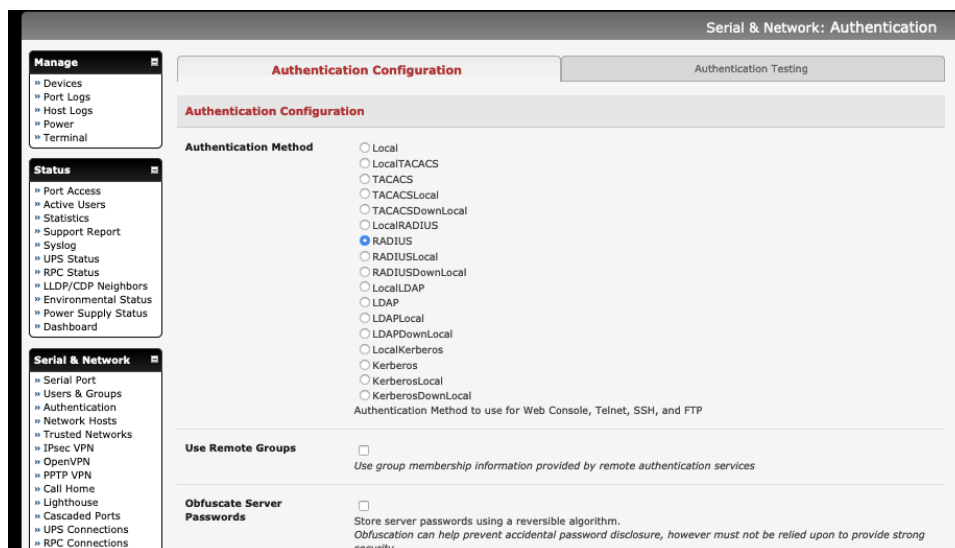

Any authentication method that is configured will be used for authentication of any user who attempts to log in through Telnet, SSH or the Web Manager to the console server and any connected serial port or network host devices.

The console server can be configured to the default (**Local**) or an alternate authentication method (**TACACS**, **RADIUS**, **LDAP** or **Kerberos**) with the option of a selected order in which local and remote authentication is to be used:

Local TACACS /RADIUS/LDAP/Kerberos: Tries local authentication first, falling back to remote if local fails

TACACS /RADIUS/LDAP/Kerberos Local: Tries remote authentication first, falling back to local if remote fails

TACACS /RADIUS/LDAP/Kerberos Down Local: Tries remote authentication first, falling back to local if the remote authentication returns an error condition (e.g. the remote authentication server is down or inaccessible)

8.1.1 Local authentication

1. Select **Serial & Network > Authentication** and check **Local**
2. Click **Apply**

8.1.2 TACACS authentication

Perform the following procedure to configure the TACACS+ authentication method to be used whenever the console server or any of its serial ports or hosts is accessed:

1. Select **Serial & Network > Authentication** and check **TACAS**, **LocalTACACS**, **TACACSLocal** or **TACACSDownLocal**.

TACACS+	
Authentication and Authorization Server Address	test-services.test.bne.opengear.c Comma separated list of remote authentication and authorization servers.
Disable Accounting	<input type="checkbox"/> Do not send session accounting information.
Accounting Server Address	<input type="text"/> Comma separated list of accounting remote accounting servers. If unset, authentication and authorization server addresses will be used.
Server Password The shared secret allowing access to the authentication server
Confirm Password
TACACS Login Method	<input type="radio"/> PAP <input type="radio"/> CHAP <input type="radio"/> Login The method used to authenticate to the server. Defaults to PAP. To use DES encrypted passwords, select Login
TACACS Group Membership Attribute	<input type="text"/> The TACACS attribute that is used to indicate group memberships. Defaults to: groupname#n
TACACS Service	<input type="text"/> The service to authenticate with. This determines which set of attributes are returned by the server. Defaults to <i>raccess</i>
Default Admin Privileges	<input type="checkbox"/> Enable to give all TACACS authenticated users admin privileges. Use Remote Groups must be ticked for the privileges to be granted
Ignore Privilege Level	<input type="checkbox"/> Leave disabled to give TACACS authenticated users with <i>priv-lvl</i> of 12 or greater admin privileges, and <i>priv-lvl</i> of 15 full serial port access.

2. Enter the **Server Address** (IP or host name) of the remote Authentication/Authorization server. Multiple remote servers may be specified in a comma separated list. Each server is tried in succession.

3. Session accounting is on by default. If session accounting information is not wanted, check the **Disable Accounting** checkbox. (One reason for not wanting session accounting: if the authentication server does not respond to accounting requests, said request may introduce a delay when logging in.)
4. In addition to multiple remote servers you can also enter for separate lists of Authentication/Authorization servers and Accounting servers. If no Accounting servers are specified, the Authentication/Authorization servers are used instead.
5. Enter and confirm the **Server Password**. Select the method to be used to authenticate to the server (defaults to **PAP**). To use DES encrypted passwords, select **Login**
6. If required enter the **TACACS Group Membership Attribute** that is to be used to indicate group memberships (defaults to groupname#n)
7. If required, specify **TACACS Service** to authenticate with. This determines which set of attributes are returned by the server (defaults to raccess)
8. If required, check **Default Admin Privileges** to give all TACAS+ authenticated users admin privileges. **Use Remote Groups** must also be ticked for these privileges to be granted
9. The TACACS **Privilege Level** feature only applies to TACACS remote authentication. When **Ignore Privilege Level** is enabled, the priv-lvl setting for all of the users defined on the TACACS AAA server will be ignored

NOTE An Opendgear device interprets a user with a TACACS priv-lvl of 12 or above as an admin user. There is a special case where a user with a priv-lvl of 15 is also given access to all configured serial ports. When the **Ignore Privilege Level** option is enabled (i.e. checked in the UI) there are no escalations of privileges based on the priv-lvl value from the TACACS server.

Also note that if the only thing configured for one or more TACACS users is the priv-lvl (e.g. no specific port access or group memberships set), enabling this feature will revoke access to the console server for those users as they won't be a member of any groups, even if the Retrieve Remote groups option in the Authentication menu is enabled.

10. Click **Apply**. TACAS+ remote authentication is used for all user access to console server and serially or network attached devices

TACACS+ The Terminal Access Controller Access Control System (TACACS+) security protocol is a recent protocol developed by Cisco. It provides detailed accounting information and flexible administrative control over the authentication and authorization processes. TACACS+ allows for a single access control server (the TACACS+ daemon) to provide authentication, authorization, and accounting services independently. Each service can be tied into its own database to take advantage of other services available on that server or on the network, depending on the capabilities of the daemon.

8.1.3 RADIUS authentication

Perform the following procedure to configure the RADIUS authentication method to be used whenever the console server or any of its serial ports or hosts is accessed:

1. Select **Serial & Network > Authentication** and check **RADIUS** or **LocalRADIUS** or **RADIUSLocal** or **RADIUSDownLocal**

RADIUS	
Authentication and Authorization Server Address	<input type="text" value="autotest-services.test.bne.openg"/> Comma separated list of remote authentication and authorization servers. Custom ports can be specified for each address (e.g. 192.168.0.1:5555).
Disable Accounting	<input type="checkbox"/> Do not send session accounting information.
Accounting Server Address	<input type="text"/> Comma separated list of remote accounting servers. If unset, authentication and authorization server addresses will be used. Custom ports can be specified for each address (e.g. 192.168.0.1:5555).
Server Password	<input type="password" value="....."/> The shared secret allowing access to the authentication server
Confirm Password	<input type="password" value="....."/>

- Enter the **Server Address** (IP or host name) of the remote Authentication / Authorization server. Multiple remote servers may be specified in a comma separated list. Each server is tried in succession
- Session accounting is on by default. If session accounting information is not wanted, check the **Disable Accounting** checkbox. (One reason for not wanting session accounting: if the authentication server does not respond to accounting requests, said request may introduce a delay when logging in.)
- In addition to multiple remote servers you can also enter for separate lists of Authentication/Authorization servers and Accounting servers. If no Accounting servers are specified, the Authentication/Authorization servers are used instead
- Enter the **Server Password**
Click **Apply**. RADIUS remote authentication is used for all user access to console server and serially or network attached devices

8.1.4 LDAP authentication

LDAP authentication supports OpenLDAP servers, using the Posix style schema for user and group definitions.

Performing authentication against any LDAP server (AD or OpenLDAP) is straightforward, as they both follow the common LDAP standards and protocols. The harder part is configuring how to get the extra data about the users (the groups they are in, etc).

On an Opegear device, we may be configured to look at group information from an LDAP server for authentication and authorization. This group information is stored in a number of different ways. Active Directory has one method, and OpenLDAP has two other methods:

- Active Directory: Each entry for a user will have multiple 'memberOf' attributes. Each 'memberOf' value is the full DN of the group they belong to. (The entry for the user will be of objectClass "user")
- OpenLDAP / Posix: Each entry for a user must have a 'gidNumber' attribute. This will be an integer value, which is the user's primary group (eg. mapping to the /etc/passwd file, with the group ID field). To determine which group this is, we must search for an entry in the directory that has that group ID, which will give us the group name. (The users are of objectClass "posixAccount", and the groups are of objectClass "posixGroup").
- OpenLDAP / Posix: Each group entry in the group tree (of objectClass 'posixGroup') may have multiple 'memberUid' attributes. These represent secondary groups (eg. mapping to the /etc/groups file). Each attribute would contain a username.

User Manual

To cater to all these possibilities, the pam_ldap module has been modified to do group lookups for each of these three styles. This allows us to have a relatively 'generic' configuration, and not be concerned with how the LDAP directory is set up.

There are two parameters that need to be configured based on what the user wishes to look up: these are the LDAP username and group membership attributes.

To clarify to the user what parameters to use, the descriptions for these fields have been updated to prompt the user for common or likely attributes. For example, the two configuration fields have descriptions as follows:

LDAP Username Attribute: The LDAP attribute that corresponds to the login name of the user (commonly 'sAMAccountName' for Active Directory, and 'uid' for OpenLDAP).

LDAP Group Membership Attribute: The LDAP attribute that indicates group membership in a user record (commonly 'memberOf' for Active Directory, and unused for OpenLDAP).

LDAP	
Server Address	<input type="text" value="openldap"/> <small>Comma separated list of servers</small>
LDAP Base DN	<input type="text" value="dc=opengear,dc=com"/> <input type="checkbox"/> Clear this field. <small>The distinguished name of the search base. For example: dc=my-company,dc=com</small>
LDAP Bind DN	<input type="text" value="cn=admin,dc=opengear,dc=com"/> <input type="checkbox"/> Clear this field. <small>The distinguished name to bind to the server with. The default is to bind anonymously.</small>
Bind DN Password	<input type="password" value="....."/> <small>Password for the Bind DN user</small>
Confirm Password	<input type="password" value="....."/>
LDAP Username Attribute	<input type="text" value="uid"/> <small>The LDAP attribute that corresponds to the login name of the user (commonly 'sAMAccountName' for Active Directory, and 'uid' for OpenLDAP).</small>
LDAP Group Membership Attribute	<input type="text"/> <small>The LDAP attribute that indicates group membership in a user record (commonly 'memberOf' for Active Directory, and unused for OpenLDAP).</small>
LDAP Console Server Group DN	<input type="text" value="cn=MyGroup,ou=Groups,dc=opengear,dc=com"/> <input type="checkbox"/> Clear this field. <small>The distinguished name of a group on the server which, if set, all users must belong to for any access the console server.</small>
LDAP Basic Management Group DN	<small>(Currently empty)</small> <input type="text"/> <small>The distinguished name of a group on the server whose members will be given <i>users</i> group access.</small>
LDAP Administration Group DN	<small>(Currently empty)</small> <input type="text"/> <small>The distinguished name of a group on the server whose members will be given <i>admin</i> group access.</small>

NOTE The libldap library ensures SSL connections are using certificates signed by a trusted CA so it is often not easy to set up a connection to an LDAP server using SSL. See to <https://opengear.zendesk.com/entries/29959515-LDAP-over-SSL>

Perform the following procedure to configure the LDAP authentication method to be used whenever the console server or any of its serial ports or hosts is accessed:

1. Select **Serial & Network > Authentication** and check **LDAP, LocalLDAP, LDAPLocal, or LDAPDownLocal**.

LDAP	
Server Address	<input type="text"/>
	Comma separated list of servers
Server Protocol	<input type="radio"/> LDAP over SSL preferred <input type="radio"/> LDAP over SSL only <input type="radio"/> LDAP (no SSL) only If SSL should be used and/or enforced for communication with the server
Ignore SSL Certificate Errors	<input type="checkbox"/> Enable if SSL certificate errors should be ignored. If this option is disabled, the server certificate must be signed by a valid CA and the CA public certificate copied to /etc/config/ldaps_ca.crt on this appliance, for LDAP over SSL to succeed.
LDAP Base DN	(Currently empty) <input type="text"/>
	The distinguished name of the search base. For example: dc=my-company,dc=com
LDAP Bind DN	(Currently empty) <input type="text"/>
	The distinguished name to bind to the server with. The default is to bind anonymously.
Bind DN Password	<input type="password"/>
	Password for the Bind DN user
Confirm Password	<input type="password"/>
LDAP Username Attribute	<input type="text"/>
	The LDAP attribute that corresponds to the login name of the user (commonly 'sAMAccountName' for Active Directory, and 'uid' for OpenLDAP).
LDAP Group Membership Attribute	<input type="text"/>
	The LDAP attribute that indicates group membership in a user record (commonly 'memberOf' for Active Directory, and unused for OpenLDAP).
LDAP Console Server Group DN	(Currently empty) <input type="text"/>
	The distinguished name of a group on the server which, if set, all users must belong to for any access the console server.
LDAP Basic Management Group DN	(Currently empty) <input type="text"/>
	The distinguished name of a group on the server whose members will be given <i>users</i> group access.
LDAP Administration Group DN	(Currently empty) <input type="text"/>
	The distinguished name of a group on the server whose members will be given <i>admin</i> group

2. Enter the **Server Address** (IP or host name) of the remote Authentication server. Multiple remote servers may be specified in a comma separated list. Each server is tried in succession.
3. Check the **Server Protocol** box to select if SSL is to be used and/or enforced for communications with the LDAP server. Console servers offer three options for LDAPS (LDAP over SSL):
 - **LDAP over SSL preferred** will attempt to use SSL for authentication, but if it fails it will fall back to LDAP without SSL. As an example LDAP over SSL may fail due to certificate errors or the LDAP server not be contactable on the LDAPS port etc
 - **LDAP over SSL only:** this setting configures the Opengear device to only accept LDAP over SSL. If LDAP over SSL fails, only the root account will be able to log in to the console server
 - **LDAP (no SSL) only:** this setting will configure the Opengear device to only accept LDAP without SSL. If LDAP without SSL fails, only the root account will be able to log in to the console server
4. The **Ignore SSL Certificate Error** checkbox enables you to ignore SSL certificate errors - allowing LDAP over SSL to work regardless of these errors. This allows you to use any certificate, self-signed or otherwise, on the LDAP server without having to install any certificates on the console server. If this setting is not checked, you must install the CA (certificate authority) certificate with which the LDAP server's certificate was signed, onto the console server. For example, the LDAP server is serving with a certificate signed using the certificate myCA.crt

NOTE The certificate needs to be in CRT format and myCA.crt needs to be installed onto console server at /etc/config/ldaps_ca.crt. Also the file name must be ldaps_ca.crt. You need to copy the file to this location and file name manually using 'scp' or the like e.g.

```
scp /local/path/to/myCA.c  
rt root@console_server:/etc/config/ldaps_ca.crt
```

5. Enter the **Server Password**

6. Click **Apply**. LDAP remote authentication is used for all user access to console server and serially or network attached devices

8.1.5 RADIUS/TACACS user configuration

Users may be added to the local console server appliance. If they are not added and they log in via remote AAA, a user will be added for them. This user will not show up in the Opengear configurators unless they are specifically added, at which point they are transformed into a local user. The newly added user must authenticate off of the remote AAA server and will have no access if it is down.

If a local user logs in, they may be authenticated / authorized from the remote AAA server, depending on the chosen priority of the remote AAA. A local user's authorization is the union of local and remote privileges.

Example 1:

User Tim is locally added and has access to ports 1 and 2. He is also defined on a remote TACACS server, which says he has access to ports 3 and 4. Tim may log in with either his local or TACACS password and will have access to ports 1 through 4. If TACACS is down, he will need to use his local password, and will only be able to access ports 1 and 2.

Example 2:

User Lynn is only defined on the TACACS server, which says she has access to ports 5 and 6. When she attempts to log in a new user will be created for him, and she will be able to access ports 5 and 6. If the TACACS server is down she will have no access.

Example 3:

User Paul is defined on a RADIUS server only. He has access to all serial ports and network hosts.

Example 4:

User Don is locally defined on an appliance using RADIUS for AAA. Even if Don is also defined on the RADIUS server he will only have access to those serial ports and network hosts he has been authorized to use on the appliance.

If a **no local AAA** option is selected, root will be authenticated locally.

Remote users may be added to the admin group via either RADIUS or TACACS. Users may have a set of authorizations set on the remote TACACS server. Users automatically added by RADIUS will have authorization for all resources, whereas those added locally will need their authorizations specified.

LDAP has not been modified and needs locally defined users.

8.1.6 Group support with remote authentication

All console servers allow remote authentication via RADIUS, LDAP and TACACS+. RADIUS and LDAP can provide additional restrictions on user access based on group information or membership. For example, with remote group support, users can belong to a local group that has been setup to have restricted access to serial ports, network hosts and managed devices.

Remote authentication with group support works by matching a local group name with a remote group name provided by the authentication service. If the list of remote group names returned by the

authentication service matches any local group names, the user is given permissions as configured in the local groups.

To enable group support to be used by remote authentication services:

1. Select **Serial & Network > Authentication**
2. Select the relevant **Authentication Method**
3. Check the **Use Remote Groups** button

Serial & Network: Authentication

Authentication Method	<input type="radio"/> Local <input type="radio"/> LocalTACACS <input type="radio"/> TACACS <input type="radio"/> TACACSLocal <input type="radio"/> TACACSDownLocal <input type="radio"/> LocalRADIUS <input checked="" type="radio"/> RADIUS <input type="radio"/> RADIUSLocal <input type="radio"/> RADIUSDownLocal <input type="radio"/> LocalLDAP <input type="radio"/> LDAP <input type="radio"/> LDAPLocal <input type="radio"/> LDAPDownLocal
Use Remote Groups	<input checked="" type="checkbox"/> <small>Use group membership information provided by remote authentication services</small>
Session lifetime	<input style="width: 100px;" type="text"/> <small>Session lifetime in minutes. The default setting is 20 minutes.</small>

8.1.7 Remote groups with RADIUS authentication

1. Enter the RADIUS **Authentication and Authorization Server Address** and **Server Password**
2. Click **Apply**.

RADIUS	
Authentication and Authorisation Server Address	<input style="width: 150px;" type="text" value="192.168.254.240"/> <small>Comma separated list of remote authentication and authorization servers.</small>
Accounting Server Address	<input style="width: 150px;" type="text"/> <small>Comma separated list of remote accounting servers. If unset, Authentication and Authorization Server Address will be used.</small>
Server Password	<input style="width: 150px;" type="password" value="*****"/> <small>The shared secret allowing access to the authentication server.</small>
Confirm Password	<input style="width: 150px;" type="password" value="*****"/> <small>Re-enter the above password for confirmation.</small>

3. Edit the Radius user's file to include group information and restart the Radius server

When using RADIUS authentication, group names are provided to the console server using the Framed-Filter-Id attribute. This is a standard RADIUS attribute and may be used by other devices that authenticate via RADIUS.

To interoperate with other devices using this field, the group names can be added to the end of any existing content in the attribute, in the following format:

```
:group_name=testgroup1,users:
```

The above example sets the remote user as a member of testgroup1 and users if groups with those names exist on the console server. Any groups which do not exist on the console server are ignored.

User Manual

When setting the Framed-Filter-Id, the system may also remove the leading colon for an empty field. To work around this, add some dummy text to the start of the string. For example:

dummy:group_name=testgroup1,users:

- If no group is specified for a user, for example AmandaJones, the user will have no user Interface and serial port access but limited console access
- Default groups available on the console server include 'admin' for administrator access and 'users' for general user access

TomFraser	Cleartext-Password := "FraTom70" Framed-Filter-Id=":group_name=admin:"
AmandaJones	Cleartext-Password := "JonAma83"
FredWhite	Cleartext-Password := "WhiFre62" Framed-Filter-Id=":group_name=testgroup1,users:"
JanetLong	Cleartext-Password := "LonJan57" Framed-Filter-Id=":group_name=admin:"

- Additional local groups such as testgroup1 can be added via **Users & Groups > Serial & Network**

Add a New group

Groups
A group with predefined privileges the user will belong to.

Description
A brief description of the groups role.

Accessible Host(s)

ubuntu (ntp.ubuntu.com)
 baytech (192.168.254.245)

Accessible Port(s)

Select/Unselect all Ports.

Port 1 Port 2 Port 3

Accessible RPC Outlet(s)

baytech

Select/Unselect all outlets.

Outlet 1 Outlet 2 Outlet 3 Outlet 4
 Outlet 5 Outlet 6 Outlet 7 Outlet 8

8.1.8 Remote groups with LDAP authentication

Unlike RADIUS, LDAP has built in support for group provisioning, which makes setting up remote groups easier. The console server will retrieve a list of all the remote groups that the user is a direct member of and compare their names with local groups on the console server. Spaces in group name will be converted to underscores.

For example, in an existing Active Directory setup, a group of users may be part of the *UPS Admin* and *Router Admin* groups. On the console server, these users will be required to have access to a group *Router_Admin*, with access to port 1 (connected to the router), and another group *UPS_Admin*, with access to port 2 (connected to the UPS). Once LDAP is setup, users that are members of each group will have the appropriate permissions to access the router and UPS.

Currently, the only LDAP directory service that supports group provisioning is Microsoft Active Directory. Support is planned for OpenLDAP at a later time.

To enable group information to be used with an LDAP server:

1. Complete the fields for standard LDAP authentication including LDAP Server Address, Server Password, LDAP Base DN, LDAP Bind DN and LDAP User Name Attribute
2. Enter `memberOf` for **LDAP Group Membership Attribute** as group membership is currently only supported on Active Directory servers
3. If required, enter the group information for **LDAP Console Server Group DN** and/or **LDAP Administration Group DN**

User Manual

A user must be a member of the LDAP Console Server Group DN group in order to gain access to the console and user interface. For example, the user must be a member of **MyGroup** on the Active Server to gain access to the console server.

Additionally, a user must be a member of the LDAP Administration Group DN in order to gain administrator access to the console server. For example, the user must be a member of **AdminGroup** on the Active Server to receive administration privileges on the console server.

4. Click **Apply**.

LDAP	
Server Address	<input type="text" value="192.168.254.18"/> <small>Comma separated list of remote servers.</small>
Server Password	<input type="password" value="••••••"/> <small>The shared secret allowing access to the authentication server.</small>
Confirm Password	<input type="password" value="••••••"/> <small>Re-enter the above password for confirmation.</small>
LDAP Base DN	<input type="text" value="cn=Users,dc=opengear,dc=c"/> <small>The distinguished name of the search base. For example: dc=my-company,dc=com</small>
LDAP Bind DN	<input type="text" value="cn=Administrator,cn=Users,d"/> <small>The distinguished name to bind to the server with. The default is to bind anonymously.</small>
LDAP Username Attribute	<input type="text" value="sAMAccountName"/> <small>The LDAP attribute corresponding to the login name. On Active Directory servers, the attribute is sAMAccountName</small>
LDAP Group Membership Attribute	<input type="text" value="memberOf"/> <small>The LDAP attribute that is used to indicate group memberships. On Active Directory servers, the attribute is memberOf</small>
LDAP Console Server Group DN	<input type="text" value="cn=MyGroup,cn=Users,dc=o"/> <small>The distinguished name of a group existing on the server which all users with access to the console server must belong to.</small>
LDAP Administration Group DN	<input type="text" value="cn=AdminGroup,cn=Users,dc"/> <small>The distinguished name of a group existing on the server whose members will be given admin access</small>

5. Ensure the LDAP service is operational and group names are correct within the Active Directory

NOTE When you are using remote groups with LDAP remote auth, you need to have corresponding local groups on the console server BUT where the LDAP group names can contain upper case and space characters the local group name on the console server must be all lower case and the spaces replaced with underscores. For example, a remote group on the LDAP server may be **My Ldap Access Group** needs a corresponding local group on the console server called **my_ldap_access_group**. The local group on the console server must specify what the group member is granted access to for any group membership to be effective.

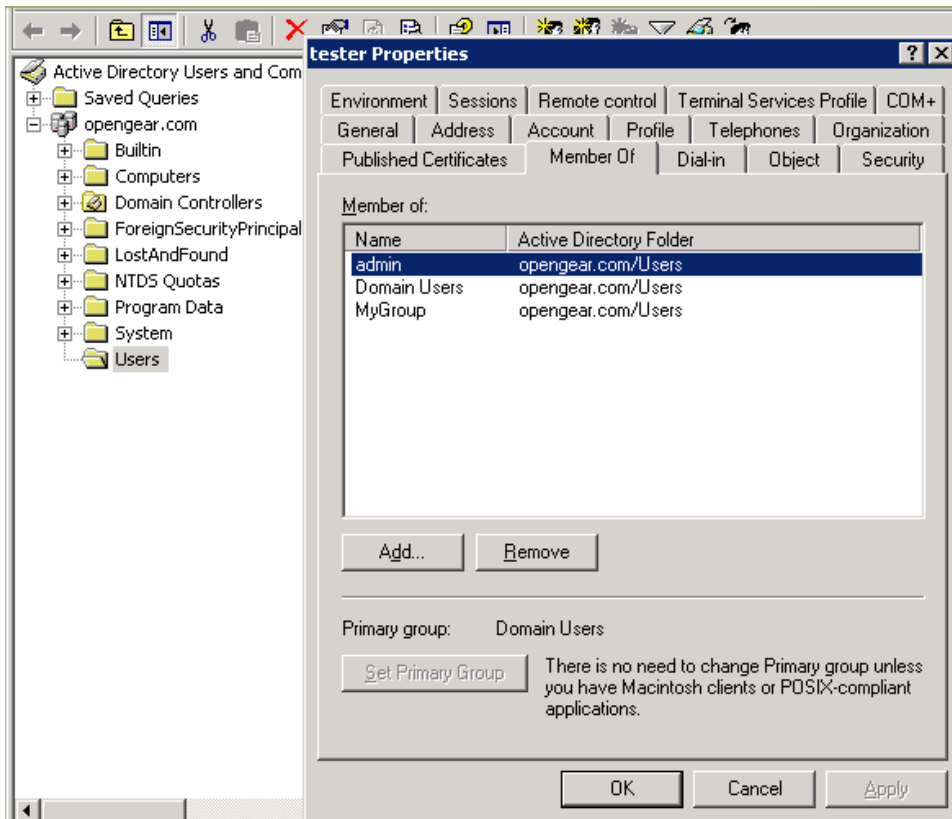

8.1.9 Remote groups with TACACS+ authentication

When using TACACS+ authentication, there are two ways to grant a remotely authenticated user privileges. The first is to set the `priv-lvl` and `port` attributes of the `raccess` service to 12, discussed further in section 8.2. Also, group names can be provided to the console server using the `groupname` custom attribute of the `raccess` service.

An example Linux `tac-plus` config snippet might look like:

```
user = myuser {
    service = raccess {
        groupname="users"
        groupname1="routers"
        groupname2="dracs"
    }
}
```

You may also specify multiple groups in one comma-delimited, e.g. `groupname="users,routers,dracs"` but be aware that the maximum length of the attribute value string is 255 characters.

To use an attribute name other than `groupname`, set Authentication > TACACS+ > TACACS Group Membership Attribute.

User Manual

8.1.10 Idle timeout

You can specify amount of time in minutes the console server waits before it terminates an idle SSH, pmshell or web connection.

Web Management Session Timeout	<input type="text"/>	Web Management Console session idle timeout in minutes. The default setting is 20 minutes.
CLI Management Session Timeout	<input type="text"/>	CLI Management Console session idle timeout in minutes. The default setting is to never expire.
Console Server Session Timeout	<input type="text"/>	Serial console server session idle timeout in minutes. The default setting is to never expire.

Select **Serial & Network > Authentication**

- **Web Management Session Timeout** specifies the browser console session idle timeout in minutes. The default setting is 20 minutes
- **CLI Management Session Timeout** specifies the SSH console session idle timeout in minutes. The default setting is to never expire
- **Console Server Session Timeout** specifies the pmshell serial console server session idle timeout in minutes. The default setting is to never expire

8.1.11 Kerberos authentication

The Kerberos authentication can be used with UNIX and Windows (Active Directory) Kerberos servers. This form of authentication does not provide group information, so a local user with the same username must be created, and permissions set.

NOTE Kerberos is sensitive to time differences between the Key Distribution Center (KDC) authentication server and the client device. Make sure that NTP is enabled, and the time zone is set correctly on the console server.

When authenticating against Active Directory, the Kerberos Realm will be the domain name, and the Master KDC will be the address of the primary domain controller.

Kerberos V	
Kerberos Realm	<input type="text"/> The domain name of the realm users must authenticate against
Master KDC address	<input type="text"/> The address of the Master KDC to authenticate against
Slave KDC Address	<input type="text"/> The address of a Slave KDC to authenticate against if the Master is not available
Discover Slave KDCs using DNS	<input type="checkbox"/> Use DNS to find slave KDCs. Only enable this if the DNS contains Kerberos information

8.1.12 Authentication testing

The Authentication Testing tab enables the connection to the remote authentication server to be tested.

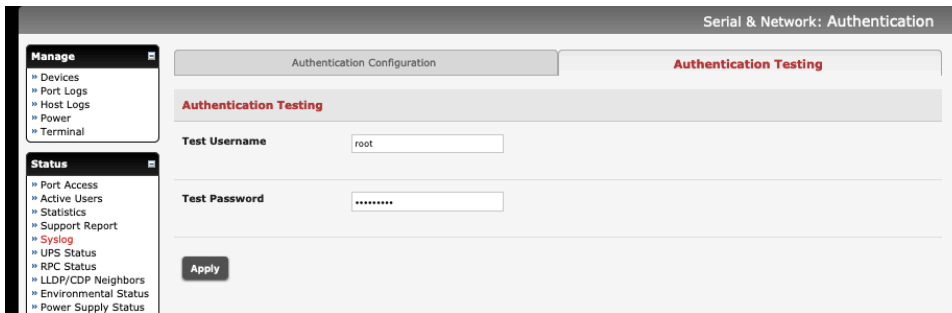

8.2 PAM (Pluggable Authentication Modules)

The console server supports RADIUS, TACACS+ and LDAP for two-factor authentication via PAM (Pluggable Authentication Modules). PAM is a flexible mechanism for authenticating users. Nowadays a number of new ways of authenticating users have become popular. The challenge is that each time a new authentication scheme is developed; it requires all the necessary programs (login, ftpd etc.) to be rewritten to support it.

PAM provides a way to develop programs that are independent of authentication scheme. These programs need authentication modules to be attached to them at run-time in order to work. Which authentication module is to be attached is dependent upon the local system setup and is at the discretion of the local administrator.

The console server family supports PAM to which we have added the following modules for remote authentication:

RADIUS	- pam_radius_auth	(http://www.freeradius.org/pam_radius_auth/)
TACACS+	- pam_tacplus	(http://echelon.pl/pubs/pam_tacplus.html)
LDAP	- pam_ldap	(http://www.padl.com/OSS/pam_ldap.html)

Further modules can be added as required.

Changes may be made to files in `/etc/config/pam.d` / which will persist, even if the authentication configurator is run.

- Users added on demand:

When a user attempts to log in but does not have an account on the console server, a new user account is created. This account will have no rights and no password set. They will not appear in the Opengear configuration tools.

Automatically added accounts will not be able to log in if the remote servers are unavailable

- Admin rights granted over AAA:

Users may be granted administrator rights via networked AAA. For TACACS a priv-lvl of 12 or above indicates an administrator. For RADIUS, administrators are indicated via the Framed Filter ID. (See the example configuration files below)

- Authorization via TACACS, LDAP or RADIUS for using remote groups
- Authorization via TACACS for both serial ports and host access:

Permission to access resources may be granted via TACACS by indicating an Opengear Appliance and a port or networked host the user may access. (See the example configuration files below for example.)

TACACS Example:

```
user = tim {
  service = raccess {
    priv-lvl = 11
    port1 = acm7004/port02
  }
  global = cleartext mit
}
```

RADIUS Example:

```
paul Cleartext-Password := "luap"
  Service-Type = Framed-User,
  Fall-Through = No,
  Framed-Filter-Id=":group_name=admin:"
```

The list of groups may include any number of entries separated by a comma. If the admin group is included, the user will be an administrator.

If there is already a Framed-Filter-Id, add the list of group_names after the existing entries, including the separating colon ":".

8.3 SSL Certificate

The console server uses the Secure Socket Layer (SSL) protocol for encrypted network traffic between itself and a connected user. During the connection establishment the console server has to expose its identity to the user's browser using a cryptographic certificate. The default certificate that comes with the console server device upon delivery is for testing purpose only and should not be relied on for secured global access.



The System Administrator should not rely on the default certificate as the secured global access mechanism for use through Internet

1. Activate your preferred browser and enter https://IP address. Your browser may respond with a message that verifies the security certificate is valid but notes that it is not necessarily verified by a certifying authority. To proceed you need to click yes if you are using Internet Explorer or select accept this certificate permanently (or temporarily) if you are using Mozilla Firefox.
2. You will be prompted for the administrator account and password.

It is recommended you generate and install a new base64 X.509 certificate that is unique for a particular console server.

The screenshot shows a configuration page for generating a Certificate Signing Request (CSR). The left sidebar contains a navigation menu with categories: Manage, Status, Serial & Network, Alerts & Logging, and System. The main configuration area includes the following fields:

- Common name:** (Currently empty) - The full canonical name for this device.
- Organizational unit:** (Currently empty) - The group overseeing this device.
- Organization:** (Currently empty) - The name of the organization to which the device belongs.
- Locality/City:** (Currently empty) - The City where the organization is located.
- State/Province:** (Currently empty) - The State or Province where the organization is located.
- Country:** US - The country where the organization is located.
- Email:** root - The email address of a contact person for this device.
- Challenge Password:** (Masked) - An optional (dependent on CA) password.
- Confirm Password:** (Masked) - Confirmation of the challenge password.
- Digest Algorithm:** sha256 - The digest algorithm to use when signing.
- Key Length (bits):** 1024 - Length of generated key in bits.

Below the fields is a table for **Subject Alternative Names**:

Name	Name Type	
		x

A **Generate CSR** button is located at the bottom left of the main configuration area.

To do this the console server must be enabled to generate a new cryptographic key and the associated Certificate Signing Request (CSR) that needs to be certified by a Certification Authority (CA). A certification authority verifies that you are the person who you claim you are and signs and issues a SSL certificate to you. To create and install an SSL certificate for the console server:

1. Select **System > SSL Certificate** and fill out the fields as explained below:

- **Common name** This is the network name of the console server once it is installed in the network (usually the fully qualified domain name). It is identical to the name that is used to access the console server with a web browser (without the http:// prefix). In case the name given here and the actual network name differ, the browser will pop up a security warning when the console server is accessed using HTTPS
- **Organizational Unit** This field is used for specifying to which department within an organization the console server belongs
- **Organization** The name of the organization to which the console server belongs
- **Locality/City** The city where the organization is located
- **State/Province** The state or province where the organization is located
- **Country** The country where the organization is located. This is the two-letter ISO code, e.g. DE for Germany, or US for the USA. (Note: the country code has to be entered in CAPITAL LETTERS)
- **Email** The email address of a contact person that is responsible for the console server and its security
- **Challenge Password** Some certification authorities require a challenge password to authorize later changes on the certificate (e.g. revocation of the certificate). The minimal length of this password is 4 characters
- **Confirm Challenge Password** Confirmation of the Challenge Password

User Manual

- **Key length** This is the length of the generated key in bits. 1024 Bits are supposed to be sufficient for most cases. Longer keys may result in slower response time of the console server during connection establishment
- **Subject Alternative Names** set one or more Subject Alternative Name certificate entries to allow for multi-homing the device.

NOTE: Set the Common Name of the device as a Subject Alternative Name when the CSR is generated as some Chrome and Firefox versions will give warnings if this is not done.

2. Once this is done, click on the button **Generate CSR** which will initiate the Certificate Signing Request generation. The CSR can be downloaded to your administration machine with the **Download** button
3. Send the saved CSR string to a Certification Authority (CA). for certification. You will get the new certificate from the CA after a more or less complicated traditional authentication process (depending on the CA)
4. Upload the certificate to the console server using the **Upload** button as shown below

Common name	192.168.0.1 The full canonical name for this device.
Organizational unit	unknown The group overseeing this device.
Organization	unknown The name of the organization to which the device belongs.
Locality/City	unknown The City where the organization is located.
State/Province	unknown The State or Province where the organization is located.
Country	unknown The country where the organization is located.
Email	unknown The email address of a contact person for this device.
Key Length (bits)	2048 Length of generated key in bits.
Digest Algorithm	sha256WithRSAEncryption The digest algorithm to use when signing
Serial Number	8DE7E7C5A81445C2 Unique Identifier of the currently installed certificate.
Valid From	Feb 20 16:55:08 2019 GMT Date at which the currently installed certificate became valid.
Valid Until	Jan 27 16:55:08 2119 GMT Date at which the currently installed certificate will become invalid.
Issuer	unknown The name of the CA who issued the currently installed certificate.
Subject Alternative Names	IP Address:192.168.0.1, DNS:192.168.0.1 Subject Alternative Names

New CSR

After completing these steps, the console server has its own certificate that is used for identifying the console server to its users.

8.4 Adding Opengear custom attributes

You can use an Opengear Vendor Specific Attribute when specifying group mappings via RADIUS. Opengear has an IANA enterprise number of 25049 with our own vendor specific attributes under that enterprise number.

Create a file called `/etc/freeradius/$VERSION/dictionary.opengear` containing:

```
VENDOR          Opengear          25049
BEGIN-VENDOR    Opengear
ATTRIBUTE       Opengear-MappedGroups  1    string
END-VENDOR      Opengear
```

Edit `/etc/freeradius/$VERSION/dictionary` to include that file:

```
$INCLUDE dictionary.opengear
```

Add the following “update reply {}” block to `/etc/freeradius/$VERSION/sites-enabled/default` inside the “authorize {}” section at the end. (

NOTE the ‘&’ before ‘Opengear’ should not be there in some older versions of freeradius eg. 2.1.12

```
authorize {
...
...
...
    update reply {
        &Opengear-MappedGroups = "group1,group2,group3"
    }
}
```

Check if configuration is correct and restart the server

```
sudo freeradius -CX
sudo service freeradius restart
```

9 NAGIOS INTEGRATION

Nagios is a powerful, highly extensible open source tool for monitoring network hosts and services. The core Nagios software package is installed on the central Nagios server.

Console servers operate in conjunction with a central/upstream Nagios server to provide distributed monitoring of attached network hosts and serial devices. They embed the NSCA (Nagios Service Checks Acceptor) and NRPE (Nagios Remote Plug-in Executor) add-ons – this allows them to communicate with the central Nagios server, eliminating the need for a dedicated slave Nagios server at remote sites.

The console server products all support distributed monitoring. Even if distributed monitoring is not required, the Console servers can be deployed locally alongside the Nagios monitoring host server, to provide additional diagnostics and points of access to managed devices.

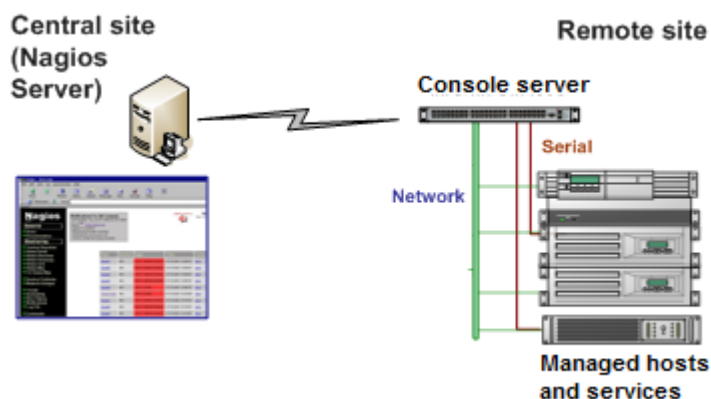

NOTE If you have an existing Nagios deployment, you may wish to use the console server gateways in a distributed monitoring server capacity only. If this case and you are already familiar with Nagios, skip ahead to section 9.3.

9.1 Nagios Overview

Nagios provides central monitoring of the hosts and services in your distributed network. Nagios is freely downloadable, open source software. This section offers a quick background of Nagios and its capabilities. A complete overview, FAQ and comprehensive documentation are available at: <http://www.nagios.org>

Nagios forms the core of many leading commercial system management solutions such as GroundWork: <http://www.groundworkopensource.com>

Nagios provides an outstanding network monitoring system. With Nagios you can:

- Display tables showing the status of each monitored server and network service in real time
- Use a wide range of freely available plug-ins to make detailed checks of specific services – e.g. check that a database can validate requests and return real data
- Display warnings and send warning e-mails, pager or SMS alerts when a service failure or degradation is detected
- Assign contact groups who are responsible for specific services in specific time frames

9.2 Configuring Nagios distributed monitoring

To activate the console server Nagios distributed monitoring:

- Nagios integration must be enabled and a path established to the central/upstream Nagios server
- If the console server is to periodically report on Nagios monitored services, the NSCA client embedded in the console server must be configured – the NSCA program enables scheduled check-ins with the remote Nagios server and is used to send passive check results across the network to the remote server
- If the Nagios server is to actively request status updates from the console server, the NRPE server embedded in the console server must be configured – the NRPE server is the Nagios daemon for executing plug-ins on remote hosts
- Each of the Serial Ports and each of the Hosts connected to the console server which are to be monitored must have Nagios enabled and any specific Nagios checks configured
- Lastly the central/upstream Nagios monitoring host must be configured

9.2.1 Enable Nagios on the console server

1. Select **System > Nagios** on the console server Management Console and tick the Nagios service **Enabled**

Enabled	<input type="checkbox"/>	Switch on the Nagios service.
Nagios Host Name	<input type="text"/>	Name of this system in Nagios. <i>Generated from System Name if unspecified.</i>
Nagios Host Address	<input type="text"/>	Address for Nagios to find this device at. <i>Defaults to Network 1 IP if set.</i>
Nagios Server Address	<input type="text"/>	Address of the upstream server.
Disable SDT Nagios Extensions	<input type="checkbox"/>	Don't show sdt:// links in service status.
SDT Gateway Address	<input type="text"/>	External address of this system, shown in sdt:// links. <i>Defaults to Nagios Host Address.</i>
Prefer NRPE	<input type="checkbox"/>	Use NRPE instead of NSCA whenever possible. <i>Defaults to prefer NSCA.</i>

2. Enter the **Nagios Host Name** that the Console server will be referred to in the Nagios central server – this will be generated from local System Name (entered in **System > Administration**) if unspecified
3. In **Nagios Host Address** enter the IP address or DNS name that the upstream Nagios server will use to reach the console server – if unspecified this will default to the first network port's IP (Network (1) as entered in **System > IP**)
4. In **Nagios Server Address** enter the IP address or DNS name that the console server will use to reach the upstream Nagios monitoring server

5. Check the **Disable SDT Nagios Extensions** option if you wish to disable the SDT Connector integration with your Nagios server at the head end – this would only be checked if you want to run a vanilla Nagios monitoring
6. If not, enter the IP address or DNS name the SDT Nagios clients will use to reach the console server in **SDT Gateway Address**
7. When NRPE and NSCA are both enabled, NSCA is preferred method for communicating with the upstream Nagios server – check **Prefer NRPE** to use NRPE whenever possible (i.e. for all communication except for alerts)

9.2.2 Enable NRPE monitoring

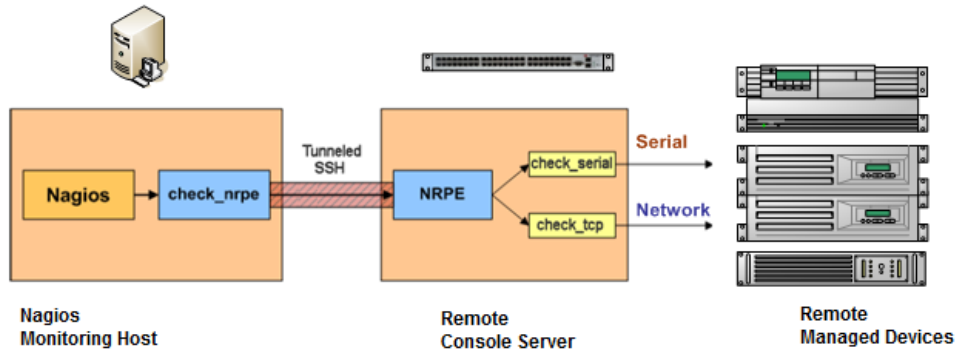

Enabling NRPE allows you to execute plug-ins (such as `check_tcp` and `check_ping`) on the remote Console server to monitor serial or network attached remote servers. This will offload CPU load from the upstream Nagios monitoring machine which is especially valuable if you are monitoring hundreds or thousands of hosts. To enable NRPE:

NRPE	
NRPE Enabled	<input checked="" type="checkbox"/> Switch on the NRPE service.
NRPE Port	<input type="text"/> Port to listen on for NRPE. Defaults to 5666.
NRPE User	<input type="text"/> User to run as Defaults to nrpe.
NRPE Group	<input type="text"/> Group to run as. Defaults to nobody.

1. Select **System > Nagios** and check **NRPE Enabled**
2. Enter the details the user connection to the upstream Nagios monitoring server and see the sample Nagios configuration example below for details of configuring specific NRPE checks

The console server accepts a connection between the upstream Nagios monitoring server and the NRPE server with SSL encryption, without SSL, or tunneled through SSH. The security for the connection is configured at the Nagios server.

9.2.3 Enable NSCA monitoring

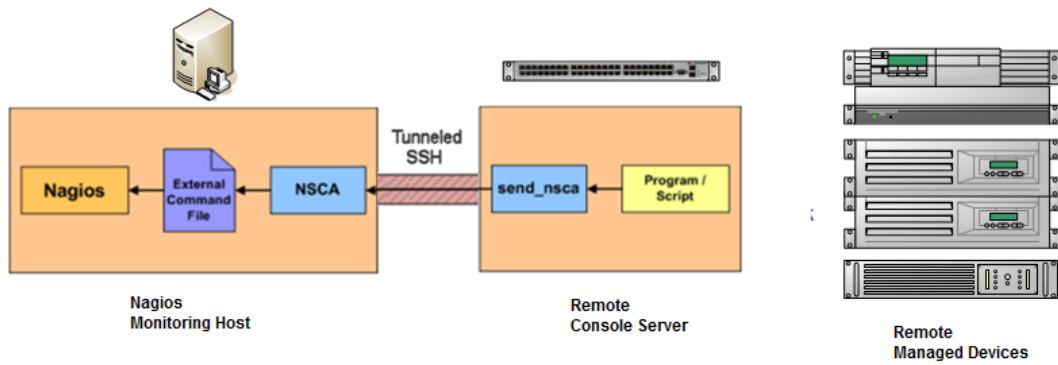

NSCA is the mechanism that allows you to send passive check results from the remote console server to the Nagios daemon running on the monitoring server. To enable NSCA:

NSCA	
NSCA Enabled	<input checked="" type="checkbox"/> Schedule check-ins with the NSCA server.
NSCA Encryption	<input type="text" value="None"/> Type of encryption.
NSCA Secret	<input type="text"/> Password for NSCA.
NSCA Confirm	<input type="text"/> Re-enter password for NSCA.
NSCA Interval	<input type="text" value="4354"/> Check-in frequency in minutes.
NSCA Port	<input type="text"/> Port to connect to. Defaults to 5667.
NSCA User	<input type="text"/> User to run as Defaults to nsca.
NSCA Group	<input type="text"/> Group to run as. Defaults to nobody.
<input type="button" value="Apply"/>	

1. Select **System > Nagios** and check **NSCA Enabled**
2. Select the **Encryption** from the drop-down list and enter a **Secret** password and specify a check **Interval**
3. See the sample Nagios configuration section below for some examples of configuring specific NSCA checks

9.2.4 Configure selected Serial Ports for Nagios monitoring

The individual Serial Ports connected to the console server to be monitored must be configured for Nagios checks. To enable Nagios to monitor on a device connected to the console server serial port:

1. Select **Serial & Network > Serial Port** and click **Edit** on the serial Port # to be monitored

2. Select **Enable Nagios**, specify the name of the device on the upstream server and determine the check to be run on this port. **Serial Status** monitors the handshaking lines on the serial port and **Check Port** monitors the data logged for the serial port

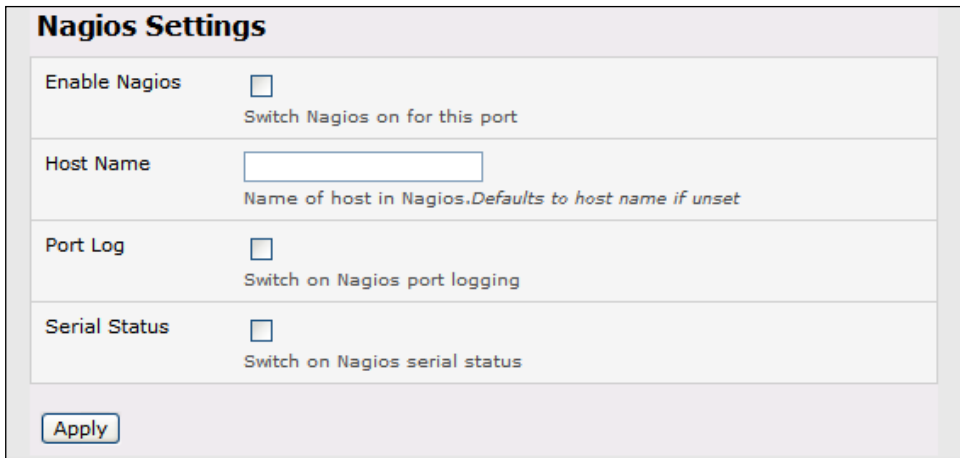

The screenshot shows a web form titled "Nagios Settings" for configuring a port. It contains four rows of settings, each with a checkbox and a descriptive label:

- Enable Nagios**: Switch Nagios on for this port
- Host Name**: Name of host in Nagios. Defaults to host name if unset
- Port Log**: Switch on Nagios port logging
- Serial Status**: Switch on Nagios serial status

At the bottom left of the form is an **Apply** button.

9.2.5 Configure selected Network Hosts for Nagios monitoring

The individual Network Hosts connected to the console server to be monitored must also be configured for Nagios checks:

1. Select **Serial & Network > Network Port** and click **Edit** on the Network Host to be monitored

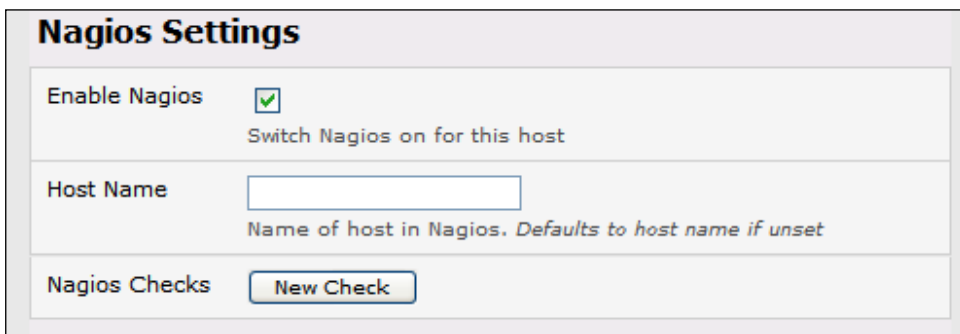

The screenshot shows a web form titled "Nagios Settings" for configuring a host. It contains three rows of settings:

- Enable Nagios**: Switch Nagios on for this host
- Host Name**: Name of host in Nagios. Defaults to host name if unset
- Nagios Checks**:

2. Select **Enable Nagios**, specify the name of the device as it will appear on the upstream Nagios server
3. Click **New Check** to add a check which will be run on this host
4. Select **Check Permitted TCP/UDP** to monitor a service that you have previously added as a **Permitted Service**
5. Select **Check TCP/UDP** to specify a service port that you wish to monitor, but do not wish to allow external (SDT Connector) access to
6. Select **Check TCP** to monitor

The screenshot shows the 'Nagios Settings' form. At the top, there is an 'Enable Nagios' checkbox which is unchecked. Below it is a 'Host Name' text input field. The 'Nagios Checks' section contains a table with one row. The first column has the number '1'. The second column is a dropdown menu currently showing 'Check NRPE', with a list of other options: 'Check Ping', 'Check Permitted TCP', 'Check Permitted UDP', 'Check TCP', and 'Check UDP'. To the right of the dropdown is a 'Use Default Args' dropdown menu. Further right is a 'Command:' text input field containing 'check-host-alive'. A 'Delete' button is to the right of the command field. Below the command field is a radio button that is currently selected. At the bottom left of the form is an 'Apply' button.

7. The **Nagios Check** nominated as the **check-host-alive** check is the check used to determine whether the network host is up or down
8. This will be *Check Ping* – although in some cases the host will be configured not to respond to pings
9. If no **check-host-alive** check is selected, the host will always be assumed to be up
10. You may deselect **check-host-alive** by clicking **Clear check-host-alive**
11. If required, customize the selected **Nagios Checks** to use custom arguments
12. Click **Apply**

This screenshot is similar to the previous one, but the dropdown menu in the 'Nagios Checks' section is open, showing options: 'Use Default Args', 'Override Default Args', and 'Add to default args'. Below the dropdown menu, there are two buttons: 'New Check' and 'Clear check-host-alive'. The 'Command:' field still contains 'check-host-alive' and the radio button remains selected. The 'Apply' button is at the bottom left.

9.2.6 Configure the upstream Nagios monitoring host

See the Nagios documentation (<http://www.nagios.org/documentation/>) for configuring the upstream server:

The section entitled *Distributed Monitoring* steps through what you need to do to configure NSCA on the upstream server (under *Central Server Configuration*)

NRPE Documentation has recently been added which steps through configuring NRPE on the upstream server <http://nagios.sourceforge.net/docs/nrpe/NRPE.pdf>

At this stage, Nagios at the upstream monitoring server has been configured, and individual serial port and network host connections on the console server configured for Nagios monitoring. If NSCA is enabled, each selected check will be executed once over the period of the check interval. If NRPE is enabled, the upstream server will be able to request status updates under its own scheduling.

9.3 Advanced Distributed Monitoring Configuration

9.3.1 Sample Nagios configuration

An example configuration for Nagios is listed below. It shows how to set up a remote Console server to monitor a single host, with both network and serial connections. For each check it has two configurations, one each for NRPE and NSCA. In practice, these would be combined into a single check which used NSCA as a primary method, falling back to NRPE if a check was late – for details see the Nagios documentation <http://www.nagios.org/documentation/> on Service and Host Freshness Checks

```
; Host definitions
;
; Opendgear Console server
define host{
    use          generic-host
    host_name    opengear
    alias        Console server
    address      192.168.254.147
}

; Managed Host
define host{
    use          generic-host
    host_name    server
    alias        server
    address      192.168.254.227
}

; NRPE daemon on gateway
define command {
    command_name    check_nrpe_daemon
    command_line    $USER1$/check_nrpe -H 192.168.254.147 -p 5666
}

define service {
    service_description    NRPE Daemon
    host_name              opengear
    use                    generic-service
    check_command          check_nrpe_daemon
}

; Serial Status
define command {
    command_name    check_serial_status
    command_line    $USER1$/check_nrpe -H 192.168.254.147 -p 5666 -c
check_serial_${HOSTNAME}$
}

define service {
    service_description    Serial Status
    host_name              server
    use                    generic-service
    check_command          check_serial_status
}

define service {
    service_description    serial-signals-server
    host_name              server
```

```
use generic-service
check_command check_serial_status
active_checks_enabled 0
passive_checks_enabled 1
}

define servicedependency{
name opengear_nrpe_daemon_dep
host_name opengear
dependent_host_name server
dependent_service_description Serial Status
service_description NRPE Daemon
execution_failure_criteria w,u,c
}

; Port Log
define command{
command_name check_port_log
command_line $USER1$/check_nrpe -H 192.168.254.147 -p 5666 -c
port_log_${HOSTNAME}$
}

define service {
service_description Port Log
host_name server
use generic-service
check_command check_port_log
}

define service {
service_description port-log-server
host_name server
use generic-service
check_command check_port_log
active_checks_enabled 0
passive_checks_enabled 1
}

define servicedependency{
name opengear_nrpe_daemon_dep
host_name opengear
dependent_host_name server
dependent_service_description Port Log
service_description NRPE Daemon
execution_failure_criteria w,u,c
}

; Ping
define command{
command_name check_ping_via_opengear
command_line $USER1$/check_nrpe -H 192.168.254.147 -p 5666 -c
host_ping_${HOSTNAME}$
}

define service {
service_description Host Ping
host_name server
}
```

```

        use                generic-service
        check_command      check_ping_via_opengear
    }

define service {
    service_description    host-ping-server
    host_name              server
    use                    generic-service
    check_command          check_ping_via_opengear
    active_checks_enabled  0
    passive_checks_enabled 1
}

define servicedependency{
    name                    opengear_nrpe_daemon_dep
    host_name               opengear
    dependent_host_name     server
    dependent_service_description Host Ping
    service_description     NRPE Daemon
    execution_failure_criteria w,u,c
}

; SSH Port
define command{
    command_name    check_conn_via_opengear
    command_line    $USER1$/check_nrpe -H 192.168.254.147 -p 5666 -c
host_$HOSTNAME$_$ARG1$_$ARG2$
}

define service {
    service_description    SSH Port
    host_name              server
    use                    generic-service
    check_command          check_conn_via_opengear!tcp!22
}

define service {
    service_description    host-port-tcp-22-server
                                ; host-port-<protocol>-<port>-<host>
    host_name              server
    use                    generic-service
    check_command          check_conn_via_opengear!tcp!22
    active_checks_enabled  0
    passive_checks_enabled 1
}

define servicedependency{
    name                    opengear_nrpe_daemon_dep
    host_name               opengear
    dependent_host_name     server
    dependent_service_description SSH Port
    service_description     NRPE Daemon
    execution_failure_criteria w,u,c
}

```

9.3.2 Basic Nagios plug-ins

Plug-ins are compiled executables or scripts that can be scheduled to be run on the console server to check the status of a connected host or service. This status is communicated to the upstream Nagios server which uses the results to monitor the current status of the distributed network. Each console server is preconfigured with a selection of the checks that are part of the Nagios plug-ins package:

check_tcp and check_udp are used to check open ports on network hosts

check_ping is used to check network host availability

check_nrpe is used to execute arbitrary plug-ins in other devices

Each console server is preconfigured with two checks:

check_serial_signals is used to monitor the handshaking lines on the serial ports

check_port_log is used to monitor the data logged for a serial port.

9.3.3 Additional plug-ins

Additional Nagios plug-ins (listed below) are available for all the CM7100 or IM7200 products:

```
check_apt
check_by_ssh
check_clamd
check_dig
check_dns
check_dummy
check_fping
check_ftp
check_game
check_hpjd
check_http
check_imap
check_jabber
check_ldap
check_load
check_mrtg
check_mrtgtraf
check_nagios
check_nntp
check_nntpS
check_nt
check_ntp
check_nwstat
check_overcr
check_ping
check_pop
check_procs
check_real
check_simap
check_smtp
check_snmp
check_spop
check_ssh
check_ssntp
check_swap
check_tcp
check_time
```

```

check_udp
check_ups
check_users

```

These plug-ins from the Nagios plug-ins package can be downloaded from ftp.opengear.com.

There also are bash scripts which can be downloaded and run (primarily check_log.sh).

To configure additional checks the downloaded plug-in program must be saved in the tftp addins directory on the USB flash and the downloaded text plug-in file saved in /etc/config

To enable these new additional checks you select **Serial & Network > Network Port**, **Edit** the Network Host to be monitored, and select **New Checks**. The additional check option will have been included in the updated **Nagios Checks** list, and you can again customize the arguments

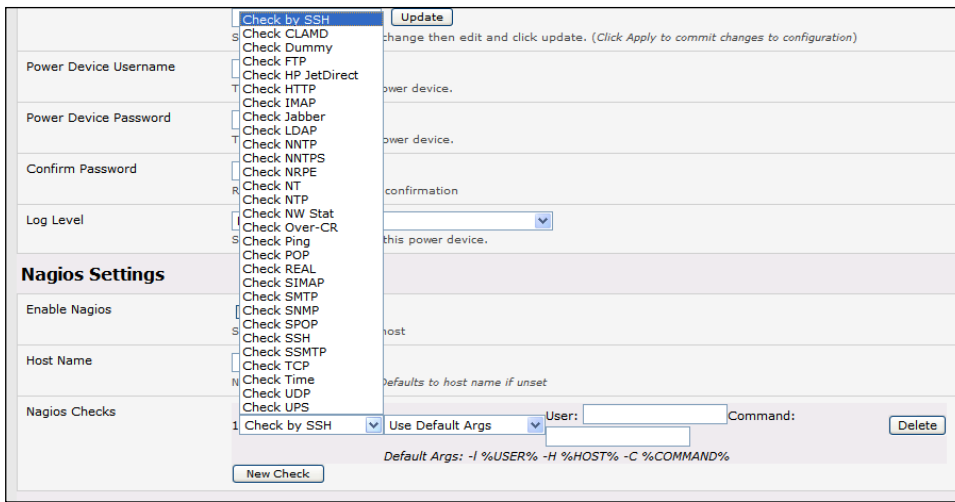

If you need other plug-ins to be loaded into the CM7100 or IM7200 firmware:

- If the plug-in is a Perl script, it must be rewritten as the console server does not support Perl. However, if you do require Perl support, make a feature request to support@opengear.com
- Individual compiled programs may be generated using gcc for ARM. Contact support@opengear.com for details

9.3.4 Number of supported devices

The number of devices that can be supported by any particular console server is a function of the number of checks being made, and how often they are performed. Access method will also play a part. The table below shows the performance of three of the console server models (1/2 port, 8 port and 16/48 port) tabulating:

Time	No encryption	3DES	SSH tunnel
NCSA for single check	~ ½ second	~ ½ second	~ ½ second
NCSA for 100 sequential checks	100 seconds	100 seconds	100 seconds
NCSA for 10 sequential checks, batched upload	1 ½ seconds	2 seconds	1 second
NCSA for 100 sequential checks, batched upload	7 seconds	11 seconds	6 seconds

	No encryption	SSL	no encryption - tunneled over existing SSH session
NRPE time to service 1 check	1/10 th second	1/3 rd second	1/8 th second
NRPE time to service 10 simultaneous checks	1 second	3 seconds	1 ¼ seconds
Maximum number of simultaneous checks before timeouts	30	20 (1,2 and 8) or 25 (16 and 48 port)	25 (1,2 and 8 port), 35 (16 and 48 port)

The results were from running tests 5 times in succession with no timeouts on any runs. However there are a number of ways to increase the number of checks you can do:

Usually when using NRPE checks, an individual request will need to set up and tear down an SSL connection. This overhead can be avoided by setting up an SSH session to the console server and tunneling the NRPE port. This allows the NRPE daemon to be run securely without SSL encryption, as SSH will take care of the security.

When the console server submits NSCA results it staggers them over a certain time period (e.g. 20 checks over 10 minutes will result in two check results every minute). Staggering the results like this means that in the event of a power failure or other incident that causes multiple problems, the individual freshness checks will be staggered too.

NSCA checks are also batched, so in the previous example the two checks per minute will be sent through in a single transaction.

9.3.5 Distributed Monitoring Usage Scenarios

Below are a number of distributed monitoring Nagios scenarios:

I. Local office

In this scenario, the console server is set up to monitor the console of each managed device. It can be configured to make a number of checks, either actively at the Nagios server's request, or passively at preset intervals, and submit the results to the Nagios server in a batch.

The console server may be augmented at the local office site by one or more Intelligent Power Distribution Units (IPDUs) to remotely control the power supply to the managed devices.

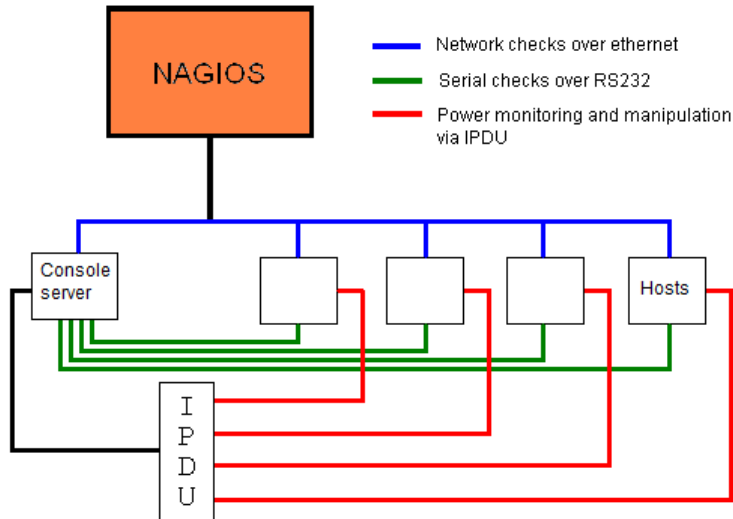

II. Remote site

In this scenario the console server NRPE server or NSCA client can be configured to make active checks of configured services and upload to the Nagios server waiting passively. It can also be configured to service NRPE commands to perform checks on demand.

In this situation, the console server will perform checks based on both serial and network access.

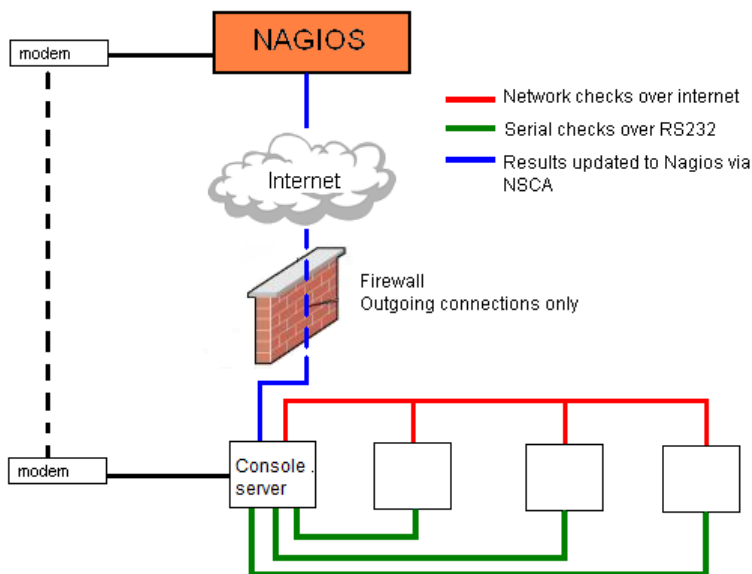

Remote site with restrictive firewall

In this scenario the role of the console server will vary. One aspect may be to upload check results through NSCA. Another may be to provide an SSH tunnel to allow the Nagios server to run NRPE commands.

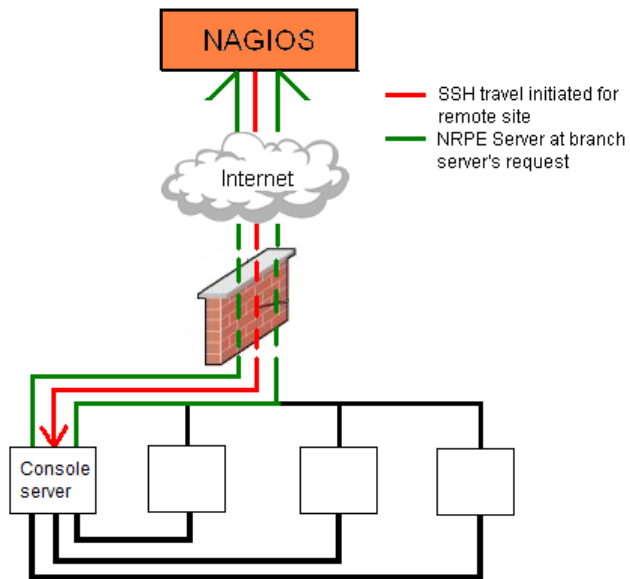

Remote site with no network access

In this scenario the console server allows dial-in access for the Nagios server. Periodically, the Nagios server establishes a connection to the console server and execute any NRPE commands before dropping the connection

10 SYSTEM MANAGEMENT

This chapter describes how an administrator can perform a range of general console server system administration and configuration tasks such as:

- Applying Soft and Hard Resets to the gateway
- Re-flashing the Firmware
- Configuring the Date, Time and NTP
- Setting up Backup of the configuration files
- Delayed configuration commits
- Configuring the console server in FIPS mode

10.1 System Administration and Reset

Administrators can reboot or reset the gateway to default settings.

To perform a soft reset, select **Reboot** in the **System > Administration** menu and clicking **Apply**

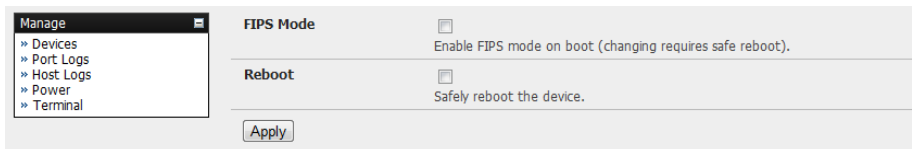

The console server reboots with all settings (e.g. the assigned network IP address) preserved. This soft reset disconnects all users and ends any SSH sessions that had been established.

A soft reset will also occur when you switch OFF power from the console server and switch the power back ON. However, if you cycle the power and the unit is writing to flash you could corrupt or lose data, so the software reboot is the safer option.

To perform a hard erase (hard reset), with the unit ON, push the Erase button on the rear panel **twice** with a ball point pen or bent paper clip.

This resets the console server back to its factory default settings and clear the console server's stored configuration information (i.e. the IP address will be reset to 192.168.0.1). You will be prompted to log in and must enter the default administration username and password:

Username: *root*

Password: *default*

10.2 Upgrade Firmware

Before upgrading you should ascertain if you are already running the most current firmware in your Opengear device. Your Opengear device will not allow you to upgrade to the same or an earlier version.

The **Firmware** version is displayed in the header of each page. **Status > Support Report** also reports the **Firmware Version**



1. Download the latest firmware image <http://ftp.opengear.com/download/release/current/>
2. Save the downloaded file on a system on the same subnet as the Opengear device
3. Download and read the Release Notes file for the latest information
4. To up-load the firmware image file, select **System > Firmware**

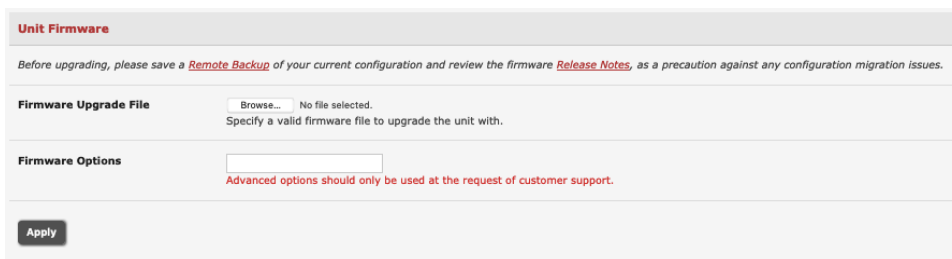

5. Specify the address and name of the downloaded Firmware Upgrade File, or **Browse** the local subnet and locate the downloaded file
6. Click **Apply** and the Opengear device will undertake a soft reboot and commence upgrading the firmware. This process will take several minutes
7. After the firmware upgrade has completed, click **here** to return to the Management Console. Your Opengear device will have retained all its pre-upgrade configuration information

10.3 Configure Date and Time

It is important to set the local Date and Time in your Opengear appliance as soon as it is configured. Features such as Syslog and NFS logging use the system time for time-stamping log entries, while certificate generation depends on a correct Timestamp to check the validity period of the certificate.

Your Opengear appliance can synchronize its system time with a remote Network Time Protocol (NTP) server. NTP uses Coordinated Universal Time (UTC) for all time synchronizations so it is not affected by different time zones.

You need to specify your local time zone so the system clock shows correct local time. Set your appropriate region/locality in the **Time Zone** selection box and click **Set Timezone**

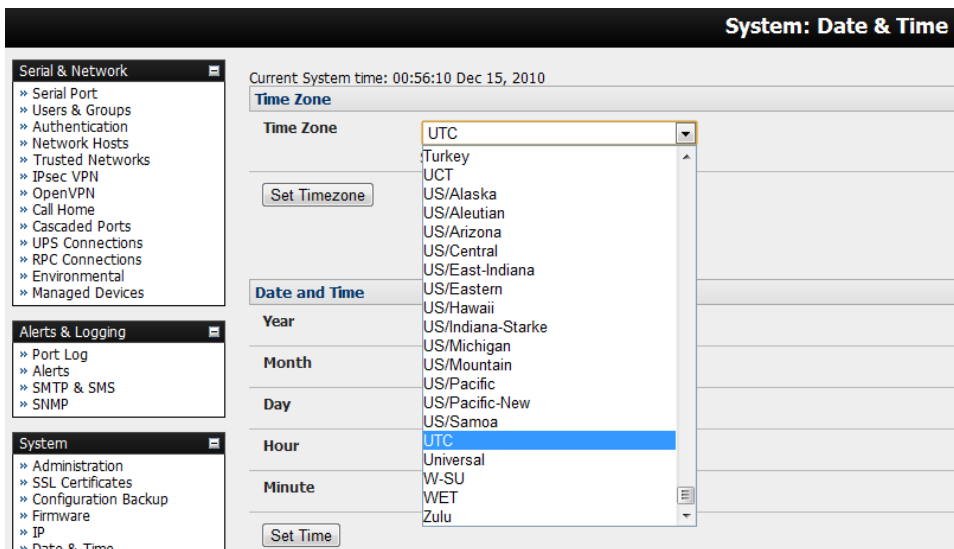

NOTE Time Zone can also be set to UTC which replaced Greenwich Mean Time as the World standard for time in 1986.

Configuring NTP ensures the Opengear appliance clock is kept accurate (once Internet connection has been established).

1. Select the **Enable NTP** checkbox in the **Network Time Protocol** section of the **System > Date & Time** page
2. Enter the IP address of the remote **NTP Server**
3. If your external NTP server requires authentication, you need to specify the **NTP Authentication Key** and the **Key Index** to use when authenticating with the NTP server
4. Click **Apply NTP Settings**

System: Date & Time

Current System time: 20:00:40 Oct 08, 2012

Time Zone

Time Zone Select your timezone.

Date and Time

Year

Month

Day

Hour

Minute

Network Time Protocol

Enable NTP Enable Network-Time-Protocol Support.

NTP Server List	Remote NTP Server Address	NTP Authentication Key <small>if NTP authentication is required</small>	NTP Authentication Key Index <small>Must be the same between the server and client</small>
<input type="text"/>	<input type="text"/>	<input type="text" value="0"/>	<input type="button" value="Remove"/>
<input type="button" value="New Server"/>			

If remote NTP is not used, the time can be set manually:

1. Enter the **Year, Month, Day, Hour** and **Minute** using the **Date** and **Time** selection boxes
2. Check **Set Time**

NOTE All Opengear appliances have an internal battery-backed hardware clock. When the time and date is set through the management console or retrieved from an NTP server, the hardware clock of the Opengear appliance is automatically updated. The hardware clock uses a battery to allow the current time and date to be maintained across reboots or when the appliance has been powered down for longer periods of time.

NOTE With the NTP peering model, the Opengear appliance can share its time information with other devices connected to it, so all devices can be time synchronized. To do this, tick Enable NTP on the Time and Date page, and ensure that the appropriate networks are selected on the Service Access page.

System: Services

Service Settings			Service Access			
Services	Service Enabled	Network Interface	Management LAN	Dialout/Cellular	Dial-in	VPN
NTP Server	Enabled	<input type="checkbox"/>	<input checked="" type="checkbox"/>	<input type="checkbox"/>	<input checked="" type="checkbox"/>	<input checked="" type="checkbox"/>

10.4 Configuration Backup

It is recommended that you back up the console server configuration whenever you make significant changes, such as adding new users or managed devices, before performing a firmware upgrade.



1. Select the **System > Configuration Backup** menu option or click the  icon

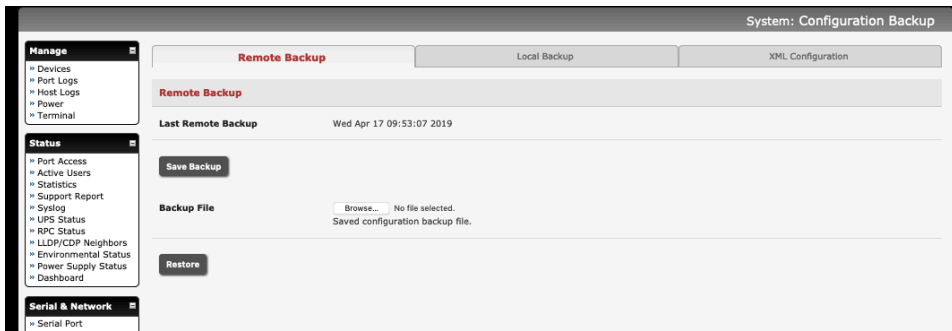

With all console servers you can save the backup file remotely on your PC and you can restore configurations from remote locations:

2. Click **Save Backup** in the Remote Configuration Backup menu
3. The config backup file (System Name_date_config.opg) is downloaded to your PC and saved in the location you nominate

To restore a remote backup:

1. Click **Browse** in the Remote Configuration Backup menu and select the **Backup File** you wish to restore
2. Click **Restore** and click **OK**. This will overwrite all the current configuration settings in your console server

With some console servers, you can save the backup file locally onto the USB storage. Your console server must support USB and you must have an internal or external USB flash drive installed.

To backup and restore using USB:

1. Ensure the USB flash is the only USB device attached to the console server
2. Select the **Local Backup** tab and **click here to proceed**. This will set a Volume Label on the USB storage device. This preparation step is only necessary the first time and will not affect any other information you have saved onto the USB storage device. We recommend that you back up any critical data from the USB storage device before using it with your console server. If there are multiple USB devices installed, a warning to remove them appears



3. To back up to the USB enter a brief **Description** of the backup in the Local Backup menu and select **Save Backup**
4. The Local Backup menu will display all the configuration backup files you have stored onto the USB flash
5. To restore a backup from the USB, select **Restore** on the particular backup you wish to restore and click **Apply**

After saving a local configuration backup, you may choose to use it as the alternate default configuration. When the console server is reset to factory defaults, it will load your alternate default configuration instead of its factory settings:

To set an alternate default configuration, check **Load On Erase** and click **Apply**

NOTE Before selecting Load On Erase, ensure you have tested your alternate default configuration by clicking Restore

If for some reason your alternate default configuration causes the console server to become unbootable recover your unit to factory settings using the following steps:

- If the configuration is stored on an external USB storage device, unplug the storage device and reset to factory defaults as per section 10.1.
- If the configuration is stored on an internal USB storage device reset to factory defaults using a prepared USB storage device:
 - The USB storage device must be formatted with a Windows FAT32/VFAT file system on the first partition or the entire disk, most USB thumb drives are already formatted this way
 - The file system must have the volume label: OPG_DEFAULT
 - Insert this USB storage device into an external USB port on the console server and reset to factory defaults as per section 10.1

After recovering your console server, ensure the problematic configuration is no longer selected for Load On Erase

10.5 Delayed Configuration Commit

This mode allows the grouping or queuing of configuration changes and the simultaneous application of these changes to a device. For example, changes to authentication methods or user accounts may be grouped and run once to minimize system downtime. To enable:

1. Check the **Delayed Config Commits** button under **System > Administration**
2. Click **Apply**

The Commit Config icon is displayed in top right-hand corner of the screen between the Backup and Log Out icons



To queue and run configuration changes:

1. Apply all the required changes to the configuration e.g. modify user accounts, amend authentication method, enable OpenVPN tunnel or modify system time
2. Click the **Commit Config** button. This will generate the **System > Commit Configuration** screen displaying all the configurators to be run
3. Click **Apply** to run all the configurators in the queue or click **Cancel** if you wish to discard all the delayed configuration changes

NOTE All the queued configuration changes will be lost if Cancel is selected

To disable the Delayed Configuration Commits mode:

1. Uncheck the **Delayed Config Commits** button under **System > Administration** and click **Apply**
2. Click the **Commit Config** button in top right-hand corner of the screen to display the **System > Commit Configuration** screen
3. Click **Apply** to run the systemsettings configurator

The **Commit Config** button will no longer be displayed in the top right-hand corner of the screen and configurations will no longer be queued.

10.6 FIPS Mode

The console servers use an embedded cryptographic module that has been validated to meet the FIPS 140-2 standards.

NOTE Opengear console servers use an embedded OpenSSL cryptographic module that has been validated to meet the FIPS 140-2 standards and has received Certificate #1051

When configured in FIPs mode all SSH, HTTPS and SDT Connector access to all services on the console servers will use the embedded FIPS compliant cryptographic module. To connect you must also be using cryptographic algorithms that are FIPs approved in your browser or client or the connection will fail.

1. Select the **System > Administration** menu option
2. Check **FIPS Mode** to enable FIPS mode on boot, and check **Reboot** to reboot the console server

The screenshot shows a configuration interface with three rows of settings, each with a checkbox and a description:

- FIPS Mode**: Enable FIPS mode on boot (changing requires safe reboot).
- Config Erase**: Restore factory default settings (requires safe reboot).
- Reboot**: Safely reboot the device.

At the bottom left of the configuration area is a button labeled **Apply**.

3. Click **Apply** and the console server reboots. It takes several minutes to reconnect as secure communications with your browser are validated, and when reconnected it will display **FIPs mode: Enabled** in the banner

NOTE To enable FIPS mode from the command line, login and run these commands:

```
config -s config.system.fips=on
touch /etc/config/FIPS
chmod 444 /etc/config/FIPS
flatfsd -b
```

The final command saves to flash and reboots the unit. The unit will take a few minutes to boot into FIPS mode. To disable FIPS mode:

```
config -d config.system.fips
rm /etc/config/FIPS
flatfsd -b
```

11 STATUS REPORTS

This chapter describes the dashboard feature and the status reports that are available:

- Port Access and Active Users
- Statistics
- Support Reports
- Syslog
- Dashboard

11.1 Port Access and Active Users

Administrators can see which users have access privileges with which serial ports. Select the **Status > Port Access**

User	From	Port 1	Port 2	Port 3	Port 4	Port 5	Port 6	Port 7	Port 8	Port 9	Port 10	Port 11	Port 12	Port 13	Port 14	Port 15	Port 16	Front, Upper USB	Front, Lower USB	GPS
root	Anywhere	A	A	A	A	A	A	A	A	A	A	A	A	A	A	A	A	A	A	A

Administrators can also see the current status of users who have active sessions on those ports. Select the **Status > Active Users**

Port	Label	Active Users
1	Port 1	<button>Disconnect Sessions</button>
2	Port 2	<button>Disconnect Sessions</button>
3	Port 3	<button>Disconnect Sessions</button>
4	Port 4	<button>Disconnect Sessions</button>
5	Port 5	<button>Disconnect Sessions</button>
6	Port 6	<button>Disconnect Sessions</button>

The **Status > Active Users** menu enables administrators to selectively terminate serial sessions. Connection types Telnet, SSH, raw TCP and unauthenticated Telnet can be disconnected. You cannot disconnect an RFC2217 session

The root user, any user in the admin group, and port-level administrators can access the **Active Users** page, which shows a snapshot of the connected sessions, at the time indicated by the timestamp

displayed at the top of the page. This page shows the local console ports and not any cascaded ports, or in the case of port admins, the ports they have permission to administer.

There are **Disconnect Sessions** buttons along the right-hand side of the table listing active users. These buttons disconnect all sessions from the Port they correspond to. If the port is not set up in Console server mode, the user will see a pop up error informing them that they need to configure the port as Console server mode before they can connect and disconnect.

After the buttons have been pressed, the selected sessions will be disconnected, and the number of disconnect sessions will be displayed to the user.

To allow more detailed control of who to disconnect, there is a table at the bottom of the page with drop-down lists for all connected users and all connected ports that allow the user to choose who to disconnect. If you wish to disconnect the user *tester* from all ports, choose *tester* in the user's box, and All ports in the Ports box and hit the Disconnect Sessions button.

NOTE You can also disconnect serial sessions from the command line using the `--disconnect` option with the `pmusers` command.

11.2 Statistics

The Statistics report provides a snapshot of the status, current traffic and other activities and operations of your console server. Select **Status > Statistics**

```
eth0 Link encap:Ethernet HWaddr 00:13:C6:04:5F:B8
inet addr:10.250.241.5 Bcast:10.250.241.255 Mask:255.255.255.0
inet6 addr: fd0d:41a4:5559:fae1:213:c6ff:fe04:5fb9/64 Scope:Global
inet6 addr: fd0d:41a4:5559:fae1:ffff:53ff:c62e:e046/128 Scope:Global
inet6 addr: fe80::213:c6ff:fe04:5fb9/64 Scope:Link
UP BROADCAST RUNNING MULTICAST  MTU:1500  Metric:1
RX packets:17536165  errors:0  dropped:0  overruns:0  frame:0
TX packets:14017137  errors:0  dropped:0  overruns:0  carrier:0
collisions:0  txqueuelen:1000
Interrupt:11

eth1 Link encap:Ethernet HWaddr 00:13:C6:04:5F:B9
inet addr: fd0d:41a4:5559:fae9:213:c6ff:fe04:5fb9/64 Scope:Global
inet6 addr: fe80::213:c6ff:fe04:5fb9/64 Scope:Link
UP BROADCAST RUNNING MULTICAST  MTU:1500  Metric:1
RX packets:7613  errors:0  dropped:0  overruns:0  frame:0
TX packets:5  errors:0  dropped:0  overruns:0  carrier:0
collisions:0  txqueuelen:1000
Interrupt:15

ihvpn1 Link encap:UNSPEC HWaddr 00-00-00-00-00-00-00-00-00-00-00-00-00-00-00-00-00
inet addr:192.168.128.2 P-t-P:192.168.128.2 Mask:255.255.224.0
UP POINTOPOINT RUNNING NOARP MULTICAST  MTU:1500  Metric:1
RX packets:17246807  errors:0  dropped:0  overruns:0  frame:0
TX packets:13821262  errors:0  dropped:0  overruns:0  carrier:0
collisions:0  txqueuelen:100
```

Detailed statistics reports can be found by selecting the various submenus.

11.3 Support Reports

The Support Report provides useful status information that will assist the Opengear technical support team to solve any problems you may experience with your console server.

If you do experience a problem and have to contact support, ensure you include the Support Report with your email support request. The Support Report should be generated when the issue is occurring and attached in plain text format.

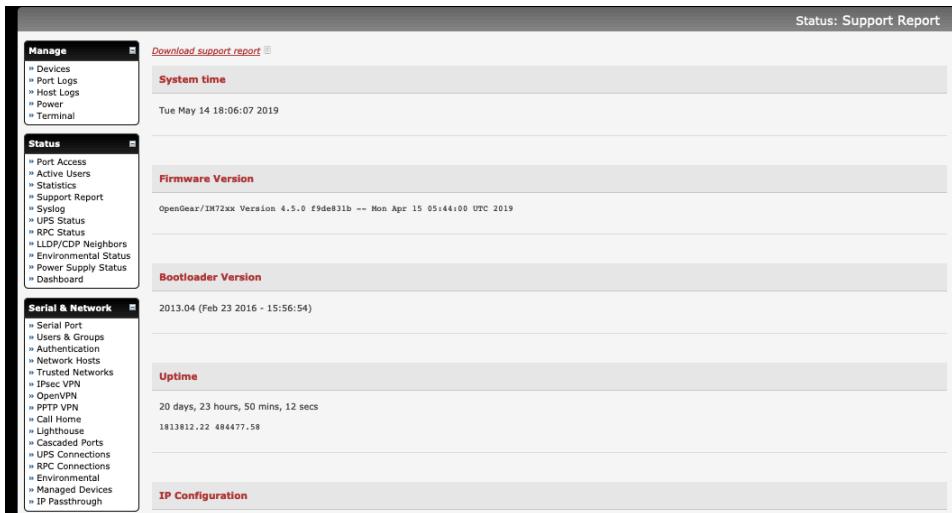

1. Select **Status > Support Report**. A status snapshot appears
2. Save the file as a text file and attach it to your support email

11.4 Syslog

The Linux System Logger in the console server maintains a record of all system messages and errors, select **Status > Syslog**

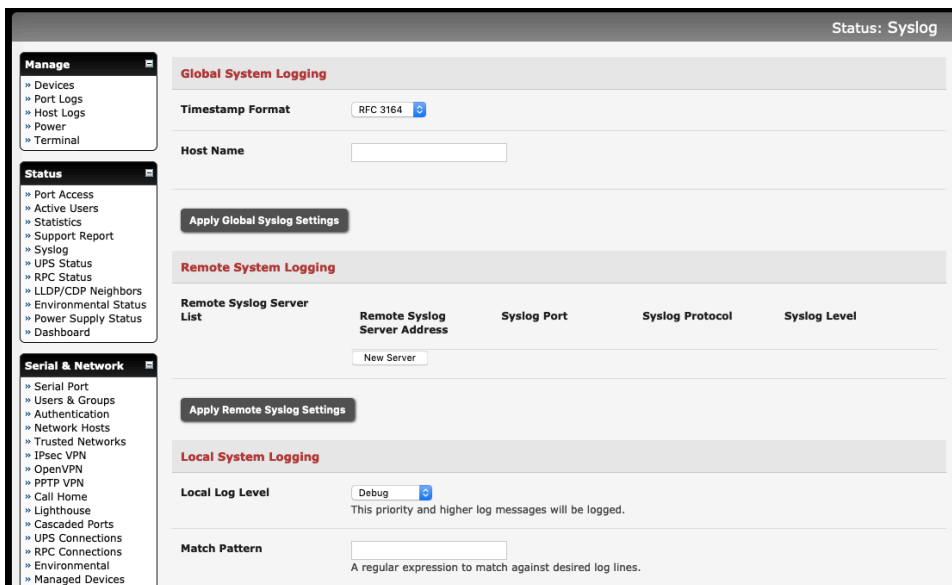

11.4.1 Global System Logging

The **Global System Logging** setting lets you specify the level of detail of the timestamp and domain name in the syslog. The options are:

- **RFC 3164** This option displays a timestamp in seconds and IP addresses, for example:

```
<14>Jun  5 23:22:01 cgi[3176]: INFO      /home/httpd/cgi-bin/index.cgi -
WebUI User: root - LOGIN from 192.168.100.1:51380
```

- **RFC 3339** This option displays a timestamp in milliseconds as well as fully qualified domain names (FQDN), for example:

```
<46>2019-06-05T23:25:52.547326-04:00 syslog: [origin
software="rsyslogd" swVersion="8.33.0" x-pid="3492" x-
info="http://www.rsyslog.com"] start
```

11.4.2 Syslog Server Address and Port

The syslog record can be redirected to a remote Syslog Server. Enter the remote **Syslog Server Address** and **Syslog Server Port** details and click **Apply**

11.4.3 Power State Changes in Syslog

For IM72xx DDC or rev6a AC models with power monitoring capabilities, power state changes are captured in the syslog.

Voltage transitions from around 0 to around 10-13 -> emit syslog("PSU xxx power up")

Voltage transitions from around 12 to < 9 for over a period of time (lets say 5 to 10 seconds) -> emit syslog("PSU xxx power down")

When both PSU #1 and #2 are on, the syslog reports it. For example:

```
14>May 7 16:57:37 psmon[2508]: INFO psmon - Internal Voltage[PSU #1] status
OPERATIONAL, value 12.025001
<14>May 7 16:57:37 psmon[2508]: INFO psmon - Internal Voltage[PSU #2] status
OPERATIONAL, value 12.050000
```

If PSU #1 is turned off, the syslog reports it. For example:

```
<14>May 7 16:59:08 psmon[2508]: INFO psmon - Internal Voltage[PSU #1]
status LOW, value 8.100000
```

1

If PSU #1 is turned on again, the syslog captures that. For example:

```
<14>May 7 16:59:23 psmon[2508]: INFO psmon - Internal Voltage[PSU #1]
status OPERATIONAL, value 12.025001
```

11.4.4 Syslog Match Pattern

To make it easier to find information in the local Syslog file, a pattern matching filter tool is provided.

Specify the **Match Pattern** that is to be searched for (e.g. the search for mount is shown below) and click **Apply**. The Syslog will be represented with those entries that include the specified pattern

11.5 Dashboard

The Dashboard provides administrators with a summary of the status of the console server and its managed devices. Custom dashboards can be configured for each user groups.

The screenshot shows the 'Status: Dashboard' page with a left-hand navigation menu and several status widgets. The widgets include:

- UPS Status:** No UPSes have been configured.
- Auto-Responses:** No check types selected. Please configure on the Configure Dashboard page.
- RPC Status:** No RPCs have been configured.
- Managed Devices:** A table with columns for Device Name, Description/Notes, and Related Connections. A note states 'Widget is disabled'.
- Environmental Status:** No EMDs have been configured.
- Port Activity:** A table with columns for Port and Active Users. A note says 'To disconnect users, go to Active Users'.
- Connection Manager:**
 - Members:** A table with columns for Network, Network (Main), and Active Connection. It shows 'Main' as active.
 - Connections:** A table with columns for IP Address and Status. It lists Network and Internal Cellular Modem connections.
- Cellular Statistics - Internal Cellular Modem:** A table with columns for Access Technology, Preferred Carrier, Signal Quality (%), and Current Bands.

11.5.1 Configuring the Dashboard

Admin group users can configure and access the dashboard. To configure a custom dashboard:

Select **System > Configure Dashboard** and select the user (or group) you are configuring this custom dashboard layout for

The screenshot shows the 'System: Configure Dashboard' page. It features a 'Select Dashboard' section with a dropdown menu. The dropdown is open, showing options for 'Default Dashboard', 'Groups', 'admin', and 'Users'. Below the dropdown, there is a text field and a description: 'to configure the dashboard for.' There are also 'Edit' and 'Delete Dashboard' buttons.

You can configure a custom dashboard for any admin user or for the admin group or you can reconfigure the default dashboard.

The **Status > Dashboard** screen is the first screen displayed when admin users (other than root) log into the console manager. If you log in as John, are in the admin group, and there is a dashboard layout configured for John, the dashboard for John appears on log-in and when you click on the **Status > Dashboard** menu item.

If there is no dashboard layout configured for John but there is an admin group dashboard configured, you see the admin group dashboard. You will see the default dashboard if there is no user dashboard or admin group dashboard configured.

The root user does not have its own dashboard.

The above configuration options are intended to enable admin users to setup their own custom dashboards.

The Dashboard displays a configurable number of widgets. These widgets include status for major subsystems such as conma, Auto-Response, Managed Devices, and cellular. The admin user can configure which of these widgets is to be displayed where:

1. Go to the **Dashboard layout** panel and select which widget is to be displayed in each of the **Widget Slots**
2. Click **Save Dashboard**

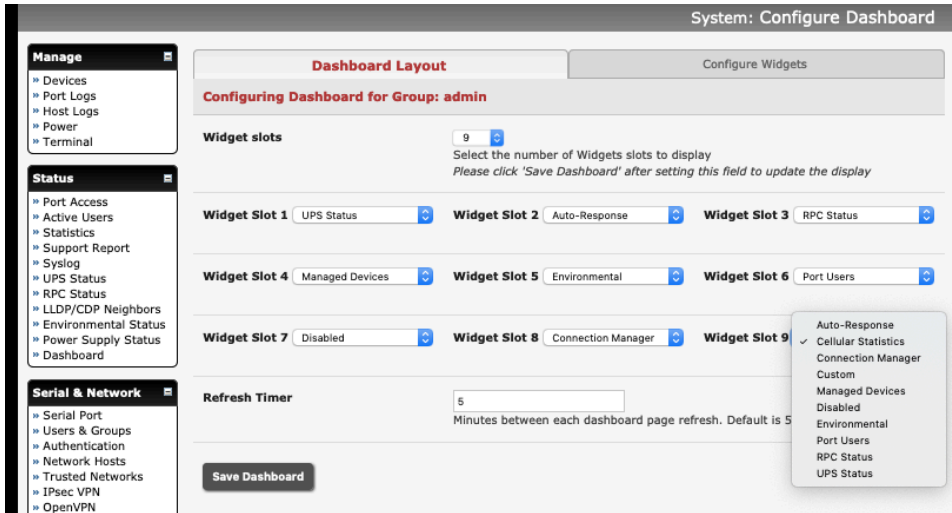

NOTE The Alerts widget is a new screen that shows the current alerts status. When an alert gets triggered, a corresponding .XML file is created in /var/run/alerts/. The dashboard scans all these files and displays a summary status in the alerts widget. When an alert is deleted the corresponding .XML files that belong to that alert are also deleted.

To configure what is to be displayed by each widget:

3. Go to the **Configure widgets** panel and configure each selected widget (e.g. specify which UPS status is to be displayed on the ups widget or the maximum number of managed devices to be displayed in the devices widget)
4. Click **Apply**

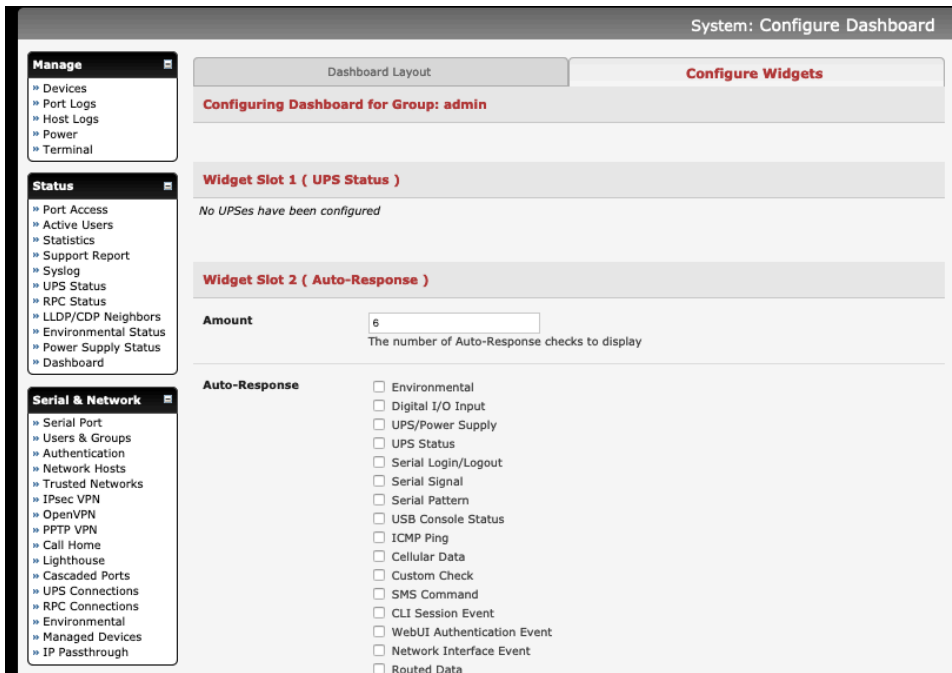

NOTE Dashboard configuration is stored in the `/etc/config/config.xml` file. Each configured dashboard will increase the config file. If this file gets too big, you can run out of memory space on the console server.

11.5.2 Creating custom widgets for the Dashboard

To run a custom script inside a dashboard widget:

Create a file called `widget-<name>.sh` in the folder `/etc/config/scripts /` where `<name>` can be anything. You can have as many custom dashboard files as you want.

Inside this file you can put any code you wish. When configuring the dashboard, choose `widget-<name>.sh` in the drop-down list. The dashboard will run the script and display the output of the script commands on the screen inside the widget.

The best way to format the output would be to send HTML commands back to the browser by adding `echo` commands in the script:

```
echo '<table>'
```

You can run any command and its output will be displayed in the widget window directly.

Below is an example script which writes the current date to a file, and echo's HTML code back to the browser. The HTML code gets an image from a URL and displays it in the widget.

```
#!/bin/sh

date >> /tmp/test
echo '<table>'
echo '<tr><td> This is my custom script running </td></tr>'
```

```
echo '<tr><td>'
echo ''
echo '</td></tr>'
echo '</table>'

exit 0
```

12 MANAGEMENT

The console server has a small number of **Manage** reports and tools that are available to all users:

- Access and control authorized devices
- View serial port logs and host logs for those devices
- Use SSH or the Web Terminal to access serially attached consoles
- Control of power devices (where authorized)

All other Management Console menu items are only available to administrators.

12.1 Device Management

To display managed devices and their grouped serial, network and power connections:

Select **Manage > Devices** or click the **Manage Devices** icon in the top right of the UI.

Admin-group users are presented with a list of all configured managed devices and their constituent connections, **user-group** users only see the **Managed Devices** for each **Related Connection** where they have been permitted access.

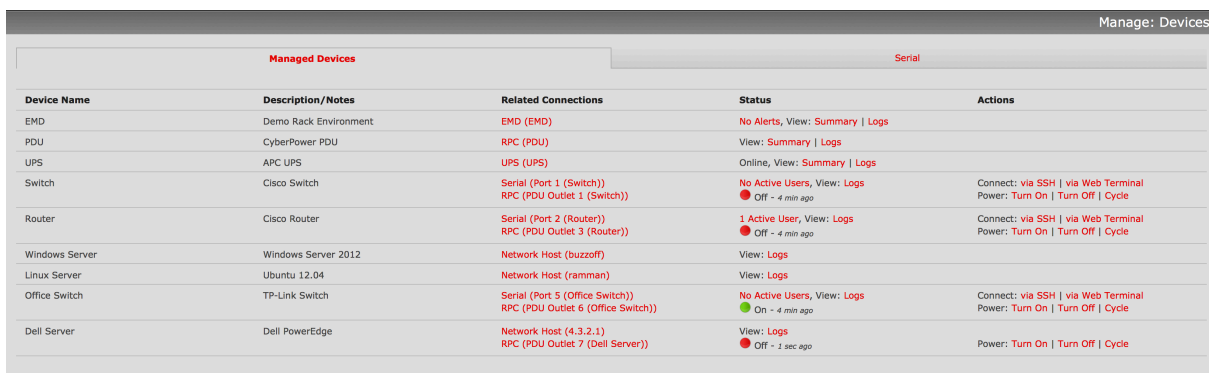

The screenshot shows the 'Manage: Devices' interface. It features two tabs: 'Managed Devices' (selected) and 'Serial'. Below the tabs is a table with the following columns: Device Name, Description/Notes, Related Connections, Status, and Actions. The table lists various devices such as EMD, PDU, UPS, Switch, Router, Windows Server, Linux Server, Office Switch, and Dell Server, each with its associated connections and current status.

Device Name	Description/Notes	Related Connections	Status	Actions
EMD	Demo Rack Environment	EMD (EMD)	No Alerts, View: Summary Logs	
PDU	CyberPower PDU	RPC (PDU)	View: Summary Logs	
UPS	APC UPS	UPS (UPS)	Online, View: Summary Logs	
Switch	Cisco Switch	Serial (Port 1 (Switch)) RPC (PDU Outlet 1 (Switch))	No Active Users, View: Logs ● Off - 4 min ago	Connect: via SSH via Web Terminal Power: Turn On Turn Off Cycle
Router	Cisco Router	Serial (Port 2 (Router)) RPC (PDU Outlet 3 (Router))	1 Active User, View: Logs ● Off - 4 min ago	Connect: via SSH via Web Terminal Power: Turn On Turn Off Cycle
Windows Server	Windows Server 2012	Network Host (buzzoff)	View: Logs	
Linux Server	Ubuntu 12.04	Network Host (ramman)	View: Logs	
Office Switch	TP-Link Switch	Serial (Port 5 (Office Switch)) RPC (PDU Outlet 6 (Office Switch))	No Active Users, View: Logs ● On - 4 min ago	Connect: via SSH via Web Terminal Power: Turn On Turn Off Cycle
Dell Server	Dell PowerEdge	Network Host (4.3.2.1) RPC (PDU Outlet 7 (Dell Server))	View: Logs ● Off - 1 sec ago	Power: Turn On Turn Off Cycle

The **Status** column displays the current status for each Related Connection with links to detailed status.

The links in the **Actions** column are used to control the managed device.

Administrators will see all configured managed devices. Non-admin users will see the managed devices they or their group have been given access privileges for.

Select the **Serial** tab for an ungrouped view of permitted serial port connections for the current user.

Manage: Devices				
Managed Devices			Serial	
Port #	Port Label	Status	Signals	Actions
1	Switch	No Active Users, View: Logs	RTS DTR	Connect: via SSH via Web Terminal
2	Router	1 Active User, View: Logs	RTS DTR	Connect: via SSH via Web Terminal
3	UPS		No signal data available	
4	PDU	No Active Users, View: Logs	RTS DTR	Connect: via SSH via Web Terminal
5	Office Switch	No Active Users, View: Logs	RTS DTR	Connect: via SSH via Web Terminal
6	Port 6	No Active Users	No signal data available	
7	Port 7	No Active Users	No signal data available	
8	EMD		No signal data available	
9	Port 9	No Active Users	No signal data available	
10	Port 10	No Active Users	No signal data available	
11	Port 11	No Active Users	No signal data available	
12	Port 12	No Active Users	No signal data available	
13	Port 13	No Active Users	No signal data available	
14	Port 14	No Active Users	No signal data available	
15	Port 15	No Active Users	No signal data available	
16	Port 16	No Active Users	RTS DTR	Connect: via SSH
17	Port 17	No Active Users	RTS DTR	

The **Signals** column displays the current state of the serial pins.

NOTE To use the **Connect: via SSH** links, your computer's operating system must recognize the `ssh://` URI scheme and have a protocol handler configured (e.g. an SSH client like SecureCRT).

12.2 Port and Host Logs

Users can view and download logs of data transferred to and from connected devices.

1. Select **Manage > Port Logs** and the serial Port # to be displayed
2. To display Host logs select **Manage > Host Logs** and the Host to be displayed

This will display logs stored locally on the console server memory or USB flash.

12.3 Terminal Connection

There are two methods available for accessing the console server command line and devices attached to the console server serial ports, directly from a web browser:

- The Web Terminal service uses AJAX to enable the web browser to connect to the console server using HTTP or HTTPS, as a terminal - without the need for additional client installation on the user's PC
- The SDT Connector service launches a pre-installed SDT Connector client on the user's PC to establish secure SSH access and uses pre-installed client software on the client PC to connect to the console server

Web browser access is available to users who are a member of the admin or users groups.

12.3.1 Web Terminal

The AJAX based Web Terminal service may be used to access the console server command line or attached serial devices.

NOTE Any communication using the Web Terminal service using HTTP is unencrypted and not secure. The Web Terminal connects to the command line or serial device using the same protocol that is being used to browse to the Opengear Management Console, i.e. if you are browsing using an `https://` URL (this is the default), the Web Terminal connects using HTTPS.

Administrators can communicate with the console server command line from their browser:

Select **Manage > Terminal** to display the Web Terminal from which you can log in to the console server command line

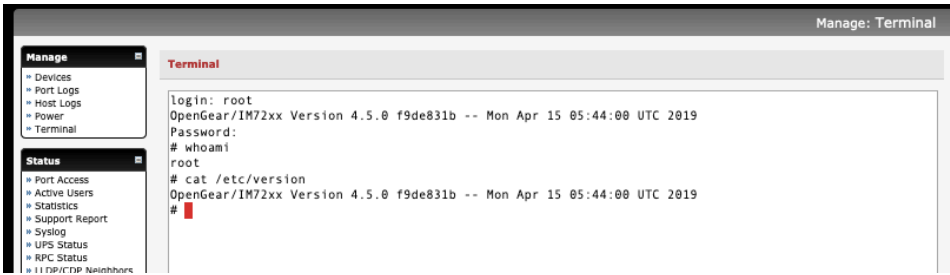

Web Terminal to Serial Device

To enable the Web Terminal service for each serial port you want to access:

1. Select **Serial & Network > Serial Port** and click **Edit**. Ensure the serial port is in Console server Mode
2. Check **Web Terminal** and click **Apply**

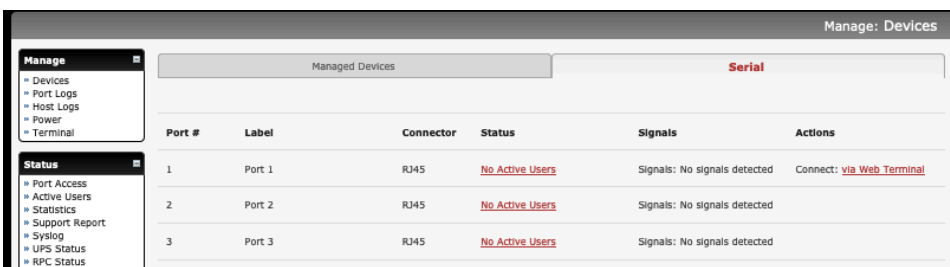
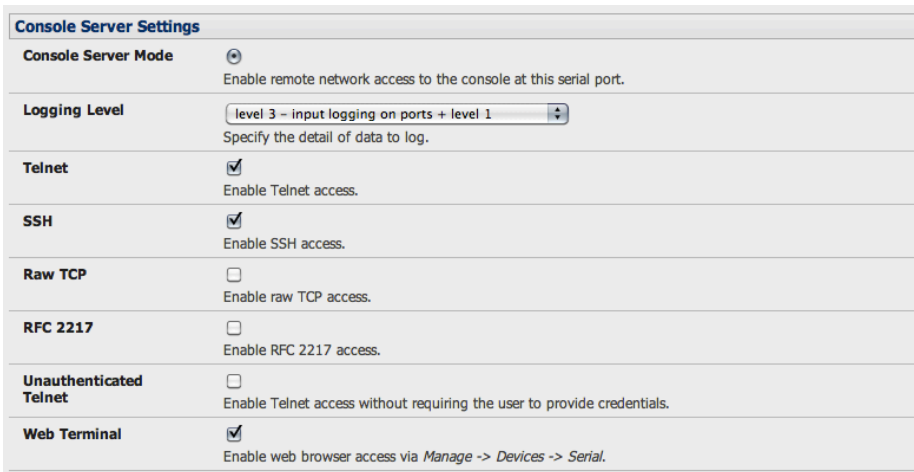

12.3.2 SDT Connector access

Users can communicate with the console server command line and devices attached to the console server serial ports using SDT Connector and their local tenet client or by using a Web terminal and their browser

1. Select **Manage > Terminal**

2. Click **Connect to SDT Connector**. This will to activate the SDT Connector client on the computer you are browsing and load your local Telnet client to connect to the command line or serial port using SSH

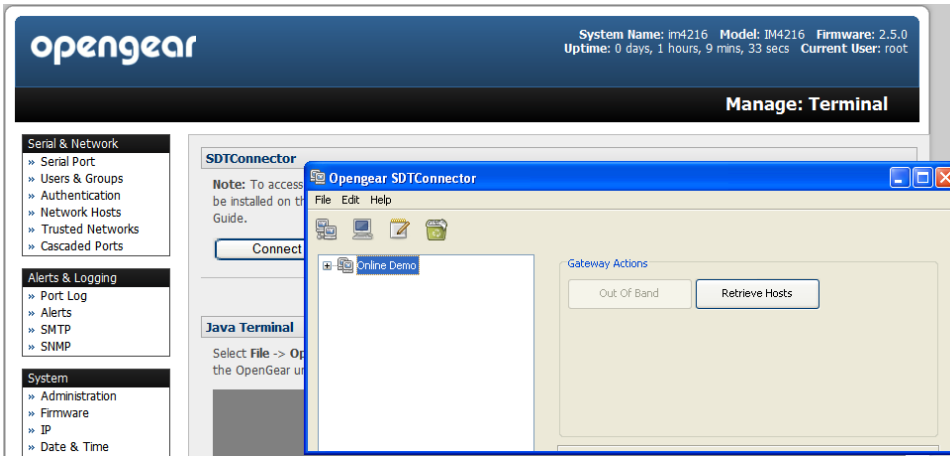

NOTE SDT Connector must be installed on the computer you are browsing from and the console server must be added as a gateway.

12.4 Power Management

Users can access and manage the connected power devices. Select **Manage > Power**. This enables the user to power Off/On/Cycle any power outlet on any PDU the user has been given access privileges to.

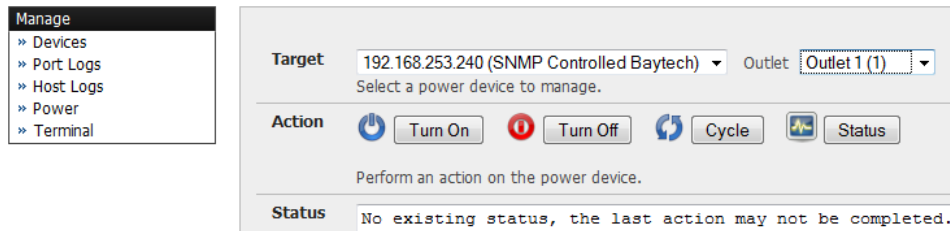

APPENDIX A: Hardware Specification

FEATURE	VALUE
Dimensions	ACM7004, ACM7004-2-L(V/A/R/MA/MV/MCR/MCT): 5 1/8 x 4 3/4 x 1 3/8 in (13 x 12 x 3.5 cm) IM7216/32/48: 17 x 10 x 1.75 in (44 x 25.4 x 4.5 cm) CM7116/32/48: 17 x 6.9 x 1.75 in (44 x 17 x 4.5 cm)
Weight	ACM7004, ACM7004-2-L(V/A/R/MA/MV/MCR/MCT): 0.6kg (1.3 lbs) IM7216/32/48: 4.5 kg (10 lbs) CM7116/32/48: 4 kg (9 lbs)
Ambient operating temperature	5°C to 50°C (41°F to 122°F) Higher for -I models
Non-operating storage temp	-30°C to +60°C (-20°F to +140°F)
Humidity	5% to 90%
Power	IM7200, CM7100: DAC have dual socket 100-240V AC DDC models dual +/- 36V to 72V DC Power consumption of IM7216-24E – 40W CM7100: SAC models – single socket universal 100-240V AC ACM7000: 110-240V AC to 12V DC external power adapter
Power Consumption	All less than 30W
CPU	IM7200: 1GHz ARM SoC (Marvell 88F6283) CM7100: 800MHz ARM SoC (Marvell 88F6W11) ACM7000: 800MHz ARM SoC (Marvell 88F6W11) Others: Micrel KS8695P controller
Memory	ACM7004, ACM7004-2-L(V/A/R/MA/MV/MCR/MCT): 254MB SDRAM, 256MB + 4GB Flash IM7216/32/48: 256MB SDRAM, 64MB + 16 GB Flash CM7116/32/48: 256MB SDRAM, 32MB + 4GB Flash
USB ports	ACM7004, ACM7004-2-L(V/A/R/MA/MV/MCR/MCT): 4 external USB2.0 IM7216/32/48: 2 external USB3.0 CM7116/32/48: 2 external USB2.0
Serial Connectors	ACM7004, ACM7004-2-L(V/A/R/MA/MV/MCR/MCT): 4 RJ-45 RS-232 serial ports IM7216-2: 16 RJ-45 RS-232 serial ports ** IM7232-2: 32 RJ-45 RS-232 serial ports ** IM7248-2: 48 RJ-45 RS-232 serial ports** CM7116-2: 16 RJ-45 RS-232 serial ports ** CM7132-2: 32 RJ-45 RS-232 serial ports ** CM7148-2: 48 RJ-45 RS-232 serial ports ** * models also have 1 DB-9 RS-232 console / modem serial port ** models also have 1 RJ45 console port
Serial Baud Rates	RJ45 ports - 50 to 230,400bps DB9 port - 2400 to 115,200 bps
Ethernet Connectors	IM7216/32/48: Two 10/100/1000 GbE copper or SFP fiber ports ACM7004, ACM7004-2-L(V/A/R/MA/MV/MCR/MCT): Two 10/100/1000 GbE ports CM7116/32/48: Two 10/100/1000 GbE ports

Connectivity, TCP Ports & Serial I/O

IM7216/32/48: Two 10/100/1000 GbE ports

Cellular Modem Frequency

Resilience Gateway ACM7000-L	Cellular Modem	LTE	UMTS/HSDPA HSUPA/HSPA	CDMA	GSM	EGSM	DCS	PCS
ACM700x-x-LMR	Sierra MC7304	2100 MHz 1800 MHz 2600 MHz 900 MHz (Band 1, 3, 8, 20) 800 MHz (Band 7)	2100 MHz 1900 MHz 850 MHz 900 MHz (Band 1, 2, 5, 8)		850 MHz	900 MHz	1800 MHz	1900 MHz
ACM700x-x-LMP	Sierra MC7430	2100 MHz 1800 MHz 850 MHz 2600 MHz 900 MHz 850 MHz 1500 MHz 700 MHz 2600 MHz 1900 MHz 2300 MHz 2500 MHz	2100 MHz 850 MHz 800 MHz 900 MHz 1700 MHz TD-SCDMA 1880 – 1920 MHz					
ACM700x-x-LMA ACM700x-x-LMV ACM700x-x-LMCR ACM700x-x-LMCT	Sierra MC7354	1900 MHz 1700/2100 MHz 850 MHz 700 MHz (LTE Band 2, 4, 5, 13, 17, 25)	2100 MHz 1900 MHz AWS 1700/2100 MHz 850 MHz 900 MHz	Cellular – 800 MHz PCS – 1900 MHz Secondary – 800 MHz				
Infrastructure Manager IM7200	Cellular Modem	LTE	UMTS/HSDPA HSUPA/HSPA	CDMA	GSM	EGSM	DCS	PCS
IM72xx-2-LR	Sierra MC7304	2100 MHz 1800 MHz 2600 MHz 900 MHz (Band 1, 3, 8, 20) 800 MHz (Band 7)	2100 MHz 1900 MHz 850 MHz 900 MHz (Band 1, 2, 5, 8)		850 MHz	900 MHz	1800 MHz	1900 MHz
IM72xx-2-LMP	Sierra MC7430	2100 MHz 1800 MHz 850 MHz 2600 MHz 900 MHz 850 MHz 1500 MHz 700 MHz 2600 MHz 1900 MHz 2300 MHz 2500 MHz	2100 MHz 850 MHz 800 MHz 900 MHz 1700 MHz TD-SCDMA 1880 – 1920 MHz					
IM72xx-2-LMA IM72xx-2-LMV IM72xx-2-LMCB IM72xx-2-LMCR IM72xx-2-LMCT	Sierra MC7354	1900 MHz 1700/2100 MHz 850 MHz 700 MHz (LTE Band 2, 4, 5, 13, 17, 25)	2100 MHz 1900 MHz AWS 1700/2100 MHz 850 MHz 900 MHz	Cellular – 800 MHz PCS – 1900 MHz Secondary – 800 MHz				

Band	Frequency (Tx)	Frequency (Rx)
Band 1	1920-1980 MHz	2110-2170 MHz
Band 5	824-849 MHz	869-894 MHz
Band 6	830-840 MHz	875-885 MHz

Band 8	880-915 MHz	925-960 MHz
Band 9	1749.9-1784.9 MHz	1844.9-1879.9 MHz
Band 19	830-845 MHz	875-890 MHz

APPENDIX B: Safety & Certifications

Follow the safety precautions below when installing and operating the console server:

- Do not remove the metal covers. There are no operator serviceable components inside. Opening or removing the cover may expose you to dangerous voltage which may cause fire or electric shock. Refer all service to Opendgear qualified personnel
- To avoid electric shock the power cord protective grounding conductor must be connected through to ground.
- Always pull on the plug, not the cable, when disconnecting the power cord from the socket.

Do not connect or disconnect the console server during an electrical storm. It is recommended you use a surge suppressor or UPS to protect the equipment from transients.

FCC Warning Statement

This device complies with Part 15 of the FCC rules. Operation of this device is subject to the following conditions: (1) This device may not cause harmful interference, and (2) this device must accept any interference that may cause undesired operation.

WEEE Statement

The symbol on the product or its packaging indicates that this product must not be disposed of with your other household waste. Instead, it is your responsibility to dispose of your waste equipment by handing it over to a designated collection point for the recycling of waste electrical and electronic equipment. The separate collection and recycling of your waste equipment at the time of disposal will help conserve natural resources and ensure that it is recycled in a manner that protects human health and the environment. For more information about where you can drop off your waste for recycling, please contact your local authority, or where you purchased your product.

Mexico Certification for IM7232-2-DAC-LMV

IFETEL number: **RTIOPIM19-0374**

La operación de este equipo está sujeta a las siguientes dos condiciones: (1) es posible que este equipo o dispositivo no cause interferencia perjudicial y (2) este equipo o dispositivo debe aceptar cualquier interferencia, incluyendo la que pueda causar su operación no deseada.

APPENDIX C: Connectivity, TCP Ports & Serial I/O

Pin-out standards exist for both DB9 and DB25 connectors. There are not pin-out standards for serial connectivity using RJ45 connectors. Most console servers and serially managed servers / router / switches / power devices have adopted their own unique pin-out, so custom connectors and cables may be required to interconnect your console server.

Serial Port Pinout

Opengear's console servers come with 1 to 48 serial connectors (notated *SERIAL* or *SERIAL PORTS*) for the RS232 serial ports:

- The RJ45 serial ports are located on the rear panel of the rack mount IM7200 and CM7100
- The CM7100 and ACM7000 models have Cisco Straight serial pinouts on its RJ45 connectors
- The IM7200 has software selectable Cisco Straight or Cisco Rolled RJ45

Cisco Straight RJ45 pinout (option -X2)

Straight through RJ-45 cable to equipment such as Cisco, Juniper, SUN, and more...

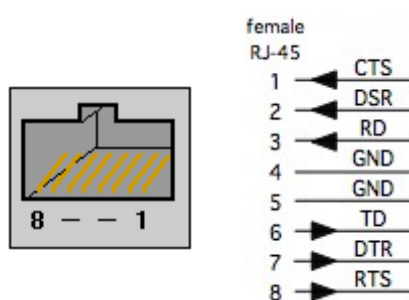

PIN	SIGNAL	DEFINITION	DIRECTION
1	CTS	Clear To Send	Input
2	DSR	Data Set Ready	Input
3	RXD	Receive Data	Input
4	GND	Signal Ground	NA
5	GND	Signal Ground	NA
6	TXD	Transmit Data	Output
7	DTR	Data Terminal Ready	Output
8	RTS	Request To Send	Output

Opengear Classic (X0) RJ45 pinout

This is the same RJ45 pinout as the Avocent /Equinox brand console server:

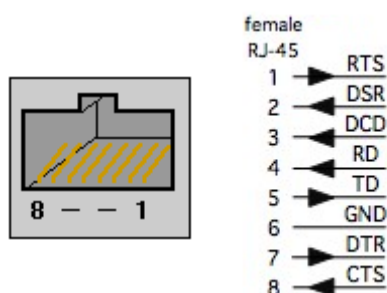

PIN	SIGNAL	DEFINITION	DIRECTION
1	RTS	Request To Send	Output
2	DSR	Data Set Ready	Input
3	DCD	Data Carrier Detect	Input
4	RXD	Receive Data	Input
5	TXD	Transmit Data	Output
6	GND	Signal Ground	NA
7	DTR	Data Terminal Ready	Output
8	CTS	Clear To Send	Input

Cisco Rolled RJ45 pinout (option -X1)

Easy to replace Avocent/Cyclades products, for use with rolled RJ-45 cable:

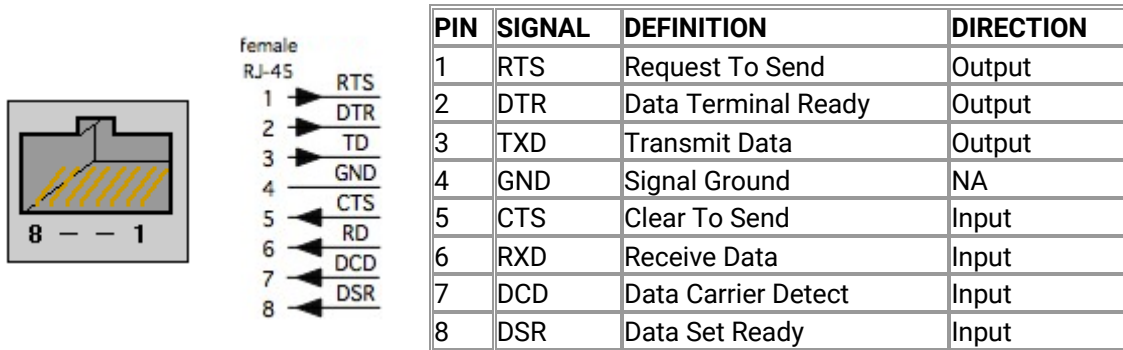

Local Console Port

Console servers with a dedicated LOCAL console/modem port use a standard DB9 connector for this port.

To connect to the LOCAL modem/console port on the console servers using a computer or terminal device use the 319001 or 319003 adaptors with standard UTP Cat 5 cable.

To connect the LOCAL console ports to modems (for out of band access) use the 319004 adaptor with standard UTP Cat 5 cable.

Each Opengear console server is supplied with UTP Cat 5 cables.

RS232 Standard Pinouts

The RS232 pinout standards for the DB9 (and DB25) connectors are tabled below:

DB25	SIGNAL	DB9	DEFINITION
1			Protective Ground
2	TXD	3	Transmitted Data
3	RXD	2	Received Data
4	RTS	7	Request To Send
5	CTS	8	Clear To Send
6	DSR	6	Data Set Ready
7	GND	5	Signal Ground
8	CD	1	Received Line Signal Detector
9			Reserved for data set testing
10			Reserved for data set testing
11			Unassigned
12	SCF		Secondary Rcvd Line Signal Detector
13	SCB		Secondary Clear to Send
14	SBA		Secondary Transmitted Data
15	DB		Transmission Signal Timing
16	SBB		Secondary Received Data
17	DD		Receiver Signal Element Timing
18			Unassigned
19	SCA		Secondary Request to Send
20	DTR	4	Data Terminal Ready
21	CG		Signal Quality Detector
22		9	Ring Indicator
23	CH/CI		Data Signal Rate Selector
24	DA		Transmit Signal Element Timing
25			Unassigned

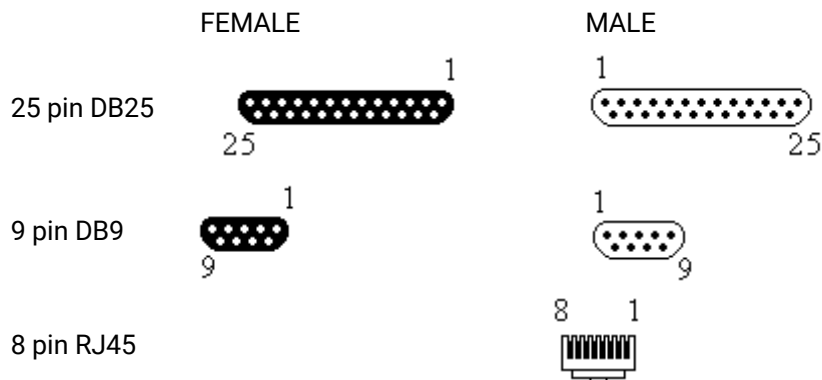

Connectors included in console server

The ACM7000, CM7100 and IM7200 families have the Cisco pinout by default and ship with cross-over / straight RJ45-DB9 connectors:

		WIRING TABLE	
		RJ-45	DB9 F
 Part # 319014	DB9F-RJ45S straight connector	1 CTS -----	8 CTS
		2 DCD -----	1 DCD
		3 RXD -----	2 RXD
		4 N/C	
		5 GND -----	5 GND
		6 TXD -----	3 TXD
		7 DTR -----	4 DTR
		8 RTS -----	7 RTS

		WIRING TABLE	
		RJ-45	DB9 F
 Part # 319015	DB9F-RJ45S cross-over connector	1 CTS -----	7 RTS
		2 DCD -----	4 DTR
		3 RXD -----	3 TXD
		4 N/C	
		5 GND -----	5 GND
		6 TXD -----	2 RXD
		7 DTR -----	1 DCD
		8 RTS -----	6 DSR

Other available connectors and adapters

Opengear also supplies a range of cables and adapters that enables you to connect to popular servers and network appliances. More detailed information can be found online at <http://www.opengear.com/cabling.html>

For Local/Console connection:

These adapters connect the console server LOCAL/Console port (via standard UTP Cat 5 cable) to modem devices (for out-of-band access):

319000 DB9F to RJ45 straight console server LOCAL Console Port to Modem

319002 DB25M to RJ45 straight console server LOCAL Console Port to Modem

For console server Serial Port connection, the Opengear connectors and adapters detailed below are specified to work with standard UTP Cat 5 cable.

For console servers with Cisco pinouts:

319014 DB9F to RJ45 straight Console server with Cisco pinout to IP Power and other serial device

319015 DB9F to RJ45 crossover DCE adapter - Console server with Cisco pinout to X86 and other

319016 DB9M to RJ45 straight DTE adapter - Console server with Cisco pinout to Netscreen and Dell

319004 DB9M to RJ45 straight DTE adapter - Console server OOB modem connection

For console servers with Opengear Classic pinouts:

319000 DB9F to RJ45 straight Console server with Opengear classic pinout to IP Power and other serial device

319001 DB9F to RJ45 crossover DCE adapter - Console server with Opengear classic pinout to X86 and other

319002 DB25M to RJ45 straight DTE adapter for console server with Opengear classic pinout

319003 DB25M to RJ45 crossover DCE adapter - Console server with Opengear classic pinout to Sun and other

319004 DB9M to RJ45 straight DTE adapter - Console server with Opengear classic pinout to Netscreen and Dell; and OOB modem connection

319005 DB25F to RJ45 crossover DCE adapter - Console server with Opengear classic pinout to Cisco 7200 AUX

440016 5ft Cat5 RJ-45 to RJ-45 cables

Extension cables

449016 RJ-45 plug to RJ-45 jack adapter for console server with Opengear classic pinout to Cisco console (and to Netscreen with reversing cable)

449017 RJ-45 plug to RJ-45 jack adapter for console server with Opengear classic pinout to Rackable Systems console

TCP/UDP Port Numbers

Port numbers are divided into three ranges: Well Known Ports (0 through 1023), Registered Ports (1024 through 49151), and Dynamic and/or Private Ports (49152 through 65535).

Well Known Ports are assigned by IANA, and on most systems can only be used by system processes or programs executed by privileged users. The table below lists some of the well-known port numbers. For more details, please visit the IANA website: <http://www.iana.org/assignments/port-numbers>

Port Number	Protocol	TCP/UDP
21	FTP (File Transfer Protocol)	TCP
22	SSH (Secure Shell)	TCP
23	Telnet	TCP
25	SMTP (Simple Mail Transfer Protocol)	TCP
37	Time	TCP, UCP

39	RLP (Resource Location Protocol)	UDP
49	TACACS, TACACS+	UDP
53	DNS	UDP
67	BOOTP server	UDP
68	BOOTP client	UDP
v69	TFTP	UDP
70	Gopher	TCP
79	Finger	TCP
80	HTTP	TCP
110	POP3	TCP
119	NNTP (Network News Transfer Protocol)	TCP
161/162	SNMP	UDP
443	HTTPS	TCP

13 APPENDIX E: TERMINOLOGY

TERM	MEANING
AES	The Advanced Encryption Standard (AES) is a new block cipher standard to replace DES, developed by NIST, the US National Institute of Standards and Technology. AES ciphers use a 128-bit block and 128-, 192-, or 256-bit keys. The larger block size helps resist birthday attacks while the large key size prevents brute force attacks.
APN	Access Point Name (APN) is used by carriers to identify an IP packet data network that a mobile data user wants to communicate with and the type of wireless service
Authentication	Authentication is the technique by which a process verifies that its communication partner is who it is supposed to be and not an imposter. Authentication confirms that data is sent to the intended recipient and assures the recipient that the data originated from the expected sender and has not been altered on route
BIOS	Basic Input/Output System is the built-in software in a computer that are executed on startup (boot) and that determine what the computer can do without accessing programs from a disk. On PCs, the BIOS contains all the code required to control the keyboard, display screen, disk drives, serial communications, and a number of miscellaneous functions
Bonding	Ethernet Bonding or Failover is the ability to detect communication failure transparently, and switch from one LAN connection to another.
BOOTP	Bootstrap Protocol. A protocol that allows a network user to automatically receive an IP address and have an operating system boot without user interaction. BOOTP is the basis for the more advanced DHCP
Certificates	A digitally signed statement that contains information about an entity and the entity's public key, thus binding these two pieces of information together. A certificate is issued by a trusted organization (or entity) called a Certification Authority (CA) after the CA has verified that the entity is who it says it is.
Certificate Authority	A Certificate Authority is a trusted third party, which certifies public keys belong to their claimed owners. It allows users to trust that a given public key is the one they wish to use, either to send a private message to its owner or to verify the signature on a message sent by that owner.
Certificate Revocation List	A list of certificates that have been revoked by the CA before they expired. This may be necessary if the private key certificate has been compromised or if the holder of the certificate is to be denied the ability to establish a connection to the console server.
CHAP	Challenge-Handshake Authentication Protocol (CHAP) is used to verify a user's name and password for PPP Internet connections. It is more secure than PAP, the other main authentication protocol.

DES	The Data Encryption Standard is a block cipher with 64-bit blocks and a 56-bit key.
DHCP	Dynamic Host Configuration Protocol. A communications protocol that assigns IP addresses to computers when they are connected to the network.
DNS	Domain Name System that allocates Internet domain names and translates them into IP addresses. A domain name is a meaningful and easy to remember name for an IP address.
DUN	Dial Up Networking
Encryption	The technique for converting a readable message (plaintext) into random material (ciphertext) which cannot be read if intercepted. The proper decryption key is required to read the message.
Ethernet	A physical layer protocol based upon IEEE standards
Firewall	A network gateway device that protects a private network from users on other networks. A firewall is installed to allow users on an intranet access to the public Internet without allowing public Internet users access to the intranet.
Gateway	A machine that provides a route (or pathway) to the outside world.
Hub	A network device that allows more than one computer to be connected as a LAN, usually using UTP cabling.
Internet	A worldwide system of computer networks - a public, cooperative, and self-sustaining network of networks accessible to hundreds of millions of people worldwide. The Internet uses the TCP/IP set of protocols.
Intranet	A private TCP/IP network within an enterprise.
IPMI	Intelligent Platform Management Interface (IPMI) is a set of common interfaces to a computer system which system administrators can use to monitor system health and manage the system. The IPMI standard defines the protocols for interfacing with a service processor embedded into a server platform.
Key lifetimes	The length of time before keys are renegotiated
LAN	Local Area Network
LDAP	The Lightweight Directory Access Protocol (LDAP) is a protocol used to access information stored in an LDAP server. It is based on the X.500 standard but is simpler and more readily adapted to meet custom needs. The core LDAP specifications are defined in RFCs.
LED	Light-Emitting Diode
MAC address	Every piece of Ethernet hardware has a unique number assigned to it called a MAC address. The MAC address is used by the local Internet router in order

	to direct console server traffic to it. It is a 48-bit number written as a series of 6 hexadecimal octets, e.g. 00:d0:cf:00:5b:da. Each console server has its MAC address printed on a label underneath the device.
MSCHAP	Microsoft Challenge Handshake Authentication Protocol (MSCHAP) is authentication for PPP connections between a computer using a Microsoft Windows operating system and a network access server. It is more secure than PAP or CHAP and also supports data encryption.
NAT	Network Address Translation. The translation of an IP address used on one network to an IP address on another network. Masquerading is one particular form of NAT.
Net mask	The way that computers know which part of a TCP/IP address refers to the network and which part refers to the host range.
NFS	Network File System is a protocol that allows file sharing across a network. Users can view, store, and update files on a remote computer.
NTP	Network Time Protocol (NTP) used to synchronize clock times in a network of computers
Out-of-Band Management	Out-of-Band (OOB) management is any management done over channels and interfaces that are separate from those used for user/customer data. Examples would include a serial console interface or a network interface connected to a dedicated management network that is not used to carry customer traffic, or to a BMC/service processor. Any management done over the same channels and interfaces used for user/customer data is In Band.
PAP	Password Authentication Protocol (PAP) is the usual method of user authentication used on the internet: sending a username and password to a server where they are compared with a table of authorized users. Whilst most common, PAP is the least secure of the authentication options.
PPP	Point-to-Point Protocol. A networking protocol for establishing links between two peers.
RADIUS	The Remote Authentication Dial-In User Service (RADIUS) protocol was developed by Livingston Enterprises as an access server authentication and accounting protocol. The RADIUS server can support a variety of methods to authenticate a user. When it is provided with the username and original password given by the user, it can support PPP, PAP or CHAP, UNIX login, and other authentication mechanisms.
Router	A network device that moves packets of data. A router differs from hubs and switches because it is intelligent and can route packets to their final destination.
SIM	Subscriber Identity Module (SIM) card stores unique serial numbers and security authentication used to identify a subscriber on mobile telephony devices
SMASH	Systems Management Architecture for Server Hardware is a standards-based protocols aimed at increasing productivity of the management of a

	data center. The SMASH Command Line Protocol (SMASH CLP) specification provides an intuitive interface to heterogeneous servers independent of machine state, operating system or OS state, system topology or access method. It is a standard method for local and remote management of server hardware using out-of-band communication
SMTP	Simple Mail Transfer Protocol. Console server includes, SMTPclient, a minimal SMTP client that takes an email message body and passes it on to a SMTP server (default is the MTA on the local host).
SOL	Serial Over LAN (SOL) enables servers to transparently redirect the serial character stream from the baseboard universal asynchronous receiver/transmitter (UART) to and from the remote-client system over a LAN. With SOL support and BIOS redirection (to serial) remote managers can view the BIOS/POST output during power on, and reconfigured.
SSH	Secure Shell is secure transport protocol based on public-key cryptography.
SSL	Secure Sockets Layer is a protocol that provides authentication and encryption services between a web server and a web browser.
TACACS+	The Terminal Access Controller Access Control System (TACACS+) security protocol is a more recent protocol developed by Cisco. It provides detailed accounting information and flexible administrative control over the authentication and authorization processes. TACACS+ allows for a single access control server (the TACACS+ daemon) to provide authentication, authorization, and accounting services independently. Each service can be tied into its own database to take advantage of other services available on that server or on the network, depending on the capabilities of the daemon. There is a draft RFC detailing this protocol.
TCP/IP	Transmission Control Protocol/Internet Protocol. The basic protocol for Internet communication.
TCP/IP address	Internet addressing method that uses the form nnn.nnn.nnn.nnn.
Telnet	Terminal protocol that provides an easy-to-use method of creating terminal connections to a network.
UDP	User Datagram Protocol
UTC	Coordinated Universal Time.
UTP	Unshielded Twisted Pair cabling. A type of Ethernet cable that can operate up to 100Mb/s. Also known as Category 5 or CAT 5.
VNC	Virtual Network Computing (VNC) is a desktop protocol to remotely control another computer. It transmits the keyboard presses and mouse clicks from one computer to another relaying the screen updates back in the other direction over a network.

VPN	Virtual Private Network (VPN) is a network that uses a public telecommunication infrastructure and Internet to provide remote offices or individual users with secure access to their organization's network
WAN	Wide Area Network
WINS	Windows Internet Naming Service (WINS) manages the association of workstation names and locations with IP addresses

END USER LICENSE AGREEMENTS

READ BEFORE USING THE ACCOMPANYING SOFTWARE

YOU SHOULD CAREFULLY READ THE FOLLOWING TERMS AND CONDITIONS BEFORE USING THE ACCOMPANYING SOFTWARE, THE USE OF WHICH IS LICENSED FOR USE ONLY AS SET FORTH BELOW. IF YOU DO NOT AGREE TO THE TERMS AND CONDITIONS OF THIS AGREEMENT, DO NOT USE THE SOFTWARE. IF YOU USE ANY PART OF THE SOFTWARE, SUCH USE WILL INDICATE THAT YOU ACCEPT THESE TERMS.

You have acquired a product that includes Opengear (“Opengear”) proprietary software and/or proprietary software licensed to Opengear. This Opengear End User License Agreement (“EULA”) is a legal agreement between you (either an individual or a single entity) and Opengear for the installed software product of Opengear origin, as well as associated media, printed materials, and “online” or electronic documentation (“Software”). By installing, copying, downloading, accessing, or otherwise using the Software, you agree to be bound by the terms of this EULA. If you do not agree to the terms of this EULA, Opengear is not willing to license the Software to you. In such event, do not use or install the Software. If you have purchased the Software, promptly return the Software and all accompanying materials with proof of purchase for a refund.

Products with separate end user license agreements that may be provided along with the Software are licensed to you under the terms of those separate end user license agreements.

LICENSE GRANT. Subject to the terms and conditions of this EULA, Opengear grants you a nonexclusive right and license to install and use the Software on a single CPU, provided that, (1) you may not rent, lease, sell, sublicense or lend the Software; (2) you may not reverse engineer, decompile, disassemble or modify the Software, except and only to the extent that such activity is expressly permitted by applicable law notwithstanding this limitation; and (3) you may not transfer rights under this EULA unless such transfer is part of a permanent sale or transfer of the Product, you transfer at the same time all copies of the Software to the same party or destroy such materials not transferred, and the recipient agrees to this EULA.

No license is granted in any of the Software’s proprietary source code. This license does not grant you any rights to patents, copyright, trade secrets, trademarks or any other rights with respect to the Software.

You may make a reasonable number of copies of the electronic documentation accompanying the Software for each Software license you acquire, provided that, you must reproduce and include all copyright notices and any other proprietary rights notices appearing on the electronic documentation. Opengear reserves all rights not expressly granted herein.

INTELLECTUAL PROPERTY RIGHTS. The Software is protected by copyright laws, international copyright treaties, and other intellectual property laws and treaties. Opengear and its suppliers retain all ownership of, and intellectual property rights in (including copyright), the Software components and all copies thereof, provided however, that (1) certain components of the Software, including *SDT Connector*, are components licensed under the GNU General Public License Version 2, which Opengear supports, and (2) the *SDT Connector* includes code from JSch, a pure Java implementation of SSH2 which is licensed under BSD style license. Copies of these licenses are detailed below and Opengear will provide source code for any of the components of the Software licensed under the GNU General Public License upon request.

EXPORT RESTRICTIONS. You agree that you will not export or re-export the Software, any part thereof, or any process or service that is the direct product of the Software in violation of any applicable laws or regulations of the United States or the country in which you obtained them.

U.S. GOVERNMENT RESTRICTED RIGHTS. The Software and related documentation are provided with Restricted Rights. Use, duplication, or disclosure by the Government is subject to restrictions set forth in subparagraph (c) (1) (ii) of the Rights in Technical Data and Computer Software clause at DFARS 252.227-7013 or subparagraphs (c) (1) and (2) of the Commercial Computer Software – Restricted Rights at 48 C.F.R. 52.227-19, as applicable, or any successor regulations.

TERM AND TERMINATION. This EULA is effective until terminated. The EULA terminates immediately if you fail to comply with any term or condition. In such an event, you must destroy all copies of the Software. You may also terminate this EULA at any time by destroying the Software.

GOVERNING LAW AND ATTORNEY’S FEES. This EULA is governed by the laws of the State of Utah, USA, excluding its conflict of law rules. You agree that the United Nations Convention on Contracts for the International Sale of Goods is hereby excluded in its entirety and does not apply to this EULA. If you acquired this Software in a country outside of the United States, that country’s laws may apply. In any action or suit to enforce any right or remedy under this EULA

or to interpret any provision of this EULA, the prevailing party will be entitled to recover its costs, including reasonable attorneys' fees.

ENTIRE AGREEMENT. This EULA constitutes the entire agreement between you and Opengear with respect to the Software, and supersedes all other agreements or representations, whether written or oral. The terms of this EULA can only be modified by express written consent of both parties. If any part of this EULA is held to be unenforceable as written, it will be enforced to the maximum extent allowed by applicable law, and will not affect the enforceability of any other part.

Should you have any questions concerning this EULA, or if you desire to contact Opengear for any reason, please contact the Opengear representative serving your company.

THE FOLLOWING DISCLAIMER OF WARRANTY AND LIMITATION OF LIABILITY IS INCORPORATED INTO THIS EULA BY REFERENCE. THE SOFTWARE IS NOT FAULT TOLERANT. YOU HAVE INDEPENDENTLY DETERMINED HOW TO USE THE SOFTWARE IN THE DEVICE, AND OPENGEAR HAS RELIED UPON YOU TO CONDUCT SUFFICIENT TESTING TO DETERMINE THAT THE SOFTWARE IS SUITABLE FOR SUCH USE.

LIMITED WARRANTY Opengear warrants the media containing the Software for a period of ninety (90) days from the date of original purchase from Opengear or its authorized retailer. Proof of date of purchase will be required. Any updates to the Software provided by Opengear (which may be provided by Opengear at its sole discretion) shall be governed by the terms of this EULA. In the event the product fails to perform as warranted, Opengear's sole obligation shall be, at Opengear's discretion, to refund the purchase price paid by you for the Software on the defective media, or to replace the Software on new media. Opengear makes no warranty or representation that its Software will meet your requirements, will work in combination with any hardware or application software products provided by third parties, that the operation of the software products will be uninterrupted or error free, or that all defects in the Software will be corrected.

OPENGEAR DISCLAIMS ANY AND ALL OTHER WARRANTIES, WHETHER EXPRESS OR IMPLIED, INCLUDING WITHOUT LIMITATION, ANY IMPLIED WARRANTIES OF MERCHANTABILITY OR FITNESS FOR A PARTICULAR PURPOSE. OTHER THAN AS STATED HEREIN, THE ENTIRE RISK AS TO SATISFACTORY QUALITY, PERFORMANCE, ACCURACY, AND EFFORT IS WITH YOU. ALSO, THERE IS NO WARRANTY AGAINST INTERFERENCE WITH YOUR ENJOYMENT OF THE SOFTWARE OR AGAINST INFRINGEMENT. IF YOU HAVE RECEIVED ANY WARRANTIES REGARDING THE DEVICE OR THE SOFTWARE, THOSE WARRANTIES DO NOT ORIGINATE FROM, AND ARE NOT BINDING ON, OPENGEAR.

NO LIABILITY FOR CERTAIN DAMAGES. EXCEPT AS PROHIBITED BY LAW, OPENGEAR SHALL HAVE NO LIABILITY FOR COSTS, LOSS, DAMAGES OR LOST OPPORTUNITY OF ANY TYPE WHATSOEVER, INCLUDING BUT NOT LIMITED TO, LOST OR ANTICIPATED PROFITS, LOSS OF USE, LOSS OF DATA, OR ANY INCIDENTAL, EXEMPLARY SPECIAL OR CONSEQUENTIAL DAMAGES, WHETHER UNDER CONTRACT, TORT, WARRANTY OR OTHERWISE ARISING FROM OR IN CONNECTION WITH THIS EULA OR THE USE OR PERFORMANCE OF THE SOFTWARE. IN NO EVENT SHALL OPENGEAR BE LIABLE FOR ANY AMOUNT IN EXCESS OF THE LICENSE FEE PAID TO OPENGEAR UNDER THIS EULA. SOME STATES AND COUNTRIES DO NOT ALLOW THE LIMITATION OR EXCLUSION OF LIABILITY FOR INCIDENTAL OR CONSEQUENTIAL DAMAGES, SO THIS LIMITATION MAY NOT APPLY TO YOU.

JSch License

SDT Connector includes code from JSch, a pure Java implementation of SSH2. JSch is licensed under BSD style license and it is:

Copyright (c) 2002, 2003, 2004 Atsuhiko Yamanaka, JCraft, Inc. All rights reserved.

Redistribution and use in source and binary forms, with or without modification, are permitted provided that the following conditions are met:

1. Redistributions of source code must retain the above copyright notice, this list of conditions and the following disclaimer.
2. Redistributions in binary form must reproduce the above copyright notice, this list of conditions and the following disclaimer in the documentation and/or other materials provided with the distribution.
3. The names of the authors may not be used to endorse or promote products derived from this software without specific prior written permission.

THIS SOFTWARE IS PROVIDED ``AS IS" AND ANY EXPRESSED OR IMPLIED WARRANTIES, INCLUDING, BUT NOT LIMITED TO, THE IMPLIED WARRANTIES OF MERCHANTABILITY AND FITNESS FOR A PARTICULAR PURPOSE ARE DISCLAIMED. IN NO EVENT SHALL JCRAFT, INC. OR ANY CONTRIBUTORS TO THIS SOFTWARE BE LIABLE FOR ANY DIRECT, INDIRECT, INCIDENTAL, SPECIAL, EXEMPLARY, OR CONSEQUENTIAL DAMAGES (INCLUDING, BUT NOT LIMITED TO, PROCUREMENT OF SUBSTITUTE GOODS OR SERVICES; LOSS OF USE, DATA, OR PROFITS; OR BUSINESS INTERRUPTION) HOWEVER CAUSED AND ON ANY THEORY OF LIABILITY, WHETHER IN CONTRACT, STRICT LIABILITY, OR TORT (INCLUDING NEGLIGENCE OR OTHERWISE) ARISING IN ANY WAY OUT OF THE USE OF THIS SOFTWARE, EVEN IF ADVISED OF THE POSSIBILITY OF SUCH DAMAGE.

GNU GENERAL PUBLIC LICENSE
Version 2, June 1991

Copyright (C) 1989, 1991 Free Software Foundation, Inc.
51 Franklin Street, Fifth Floor, Boston, MA 02110-1301, USA

Everyone is permitted to copy and distribute verbatim copies of this license document, but changing it is not allowed.

GNU GENERAL PUBLIC LICENSE
TERMS AND CONDITIONS FOR COPYING, DISTRIBUTION AND MODIFICATION

0. This License applies to any program or other work which contains a notice placed by the copyright holder saying it may be distributed under the terms of this General Public License. The "Program", below, refers to any such program or work, and a "work based on the Program" means either the Program or any derivative work under copyright law: that is to say, a work containing the Program or a portion of it, either verbatim or with modifications and/or translated into another language. (Hereinafter, translation is included without limitation in the term "modification".) Each licensee is addressed as "you".

Activities other than copying, distribution and modification are not covered by this License; they are outside its scope. The act of running the Program is not restricted, and the output from the Program is covered only if its contents constitute a work based on the Program (independent of having been made by running the Program). Whether that is true depends on what the Program does.

1. You may copy and distribute verbatim copies of the Program's source code as you receive it, in any medium, provided that you conspicuously and appropriately publish on each copy an appropriate copyright notice and disclaimer of warranty; keep intact all the notices that refer to this License and to the absence of any warranty; and give any other recipients of the Program a copy of this License along with the Program.

You may charge a fee for the physical act of transferring a copy, and you may at your option offer warranty protection in exchange for a fee.

2. You may modify your copy or copies of the Program or any portion of it, thus forming a work based on the Program, and copy and distribute such modifications or work under the terms of Section 1 above, provided that you also meet all of these conditions:

a) You must cause the modified files to carry prominent notices stating that you changed the files and the date of any change.

b) You must cause any work that you distribute or publish, that in whole or in part contains or is derived from the Program or any part thereof, to be licensed as a whole at no charge to all third parties under the terms of this License.

c) If the modified program normally reads commands interactively when run, you must cause it, when started running for such interactive use in the most ordinary way, to print or display an announcement including an appropriate copyright notice and a notice that there is no warranty (or else, saying that you provide a warranty) and that users may redistribute the program under these conditions, and telling the user how to view a copy of this License. (Exception: if

the Program itself is interactive but does not normally print such an announcement, your work based on the Program is not required to print an announcement.)

These requirements apply to the modified work as a whole. If identifiable sections of that work are not derived from the Program, and can be reasonably considered independent and separate works in themselves, then this License, and its terms, do not apply to those sections when you distribute them as separate works. But when you distribute the same sections as part of a whole which is a work based on the Program, the distribution of the whole must be on the terms of this License, whose permissions for other licensees extend to the entire whole, and thus to each and every part regardless of who wrote it.

Thus, it is not the intent of this section to claim rights or contest your rights to work written entirely by you; rather, the intent is to exercise the right to control the distribution of derivative or collective works based on the Program.

In addition, mere aggregation of another work not based on the Program with the Program (or with a work based on the Program) on a volume of a storage or distribution medium does not bring the other work under the scope of this License.

3. You may copy and distribute the Program (or a work based on it, under Section 2) in object code or executable form under the terms of Sections 1 and 2 above provided that you also do one of the following:

a) Accompany it with the complete corresponding machine-readable source code, which must be distributed under the terms of Sections 1 and 2 above on a medium customarily used for software interchange; or,

b) Accompany it with a written offer, valid for at least three years, to give any third party, for a charge no more than your cost of physically performing source distribution, a complete machine-readable copy of the corresponding source code, to be distributed under the terms of Sections 1 and 2 above on a medium customarily used for software interchange; or,

c) Accompany it with the information you received as to the offer to distribute corresponding source code. (This alternative is allowed only for noncommercial distribution and only if you received the program in object code or executable form with such an offer, in accord with Subsection b above.)

The source code for a work means the preferred form of the work for making modifications to it. For an executable work, complete source code means all the source code for all modules it contains, plus any associated interface definition files, plus the scripts used to control compilation and installation of the executable. However, as a special exception, the source code distributed need not include anything that is normally distributed (in either source or binary form) with the major components (compiler, kernel, and so on) of the operating system on which the executable runs, unless that component itself accompanies the executable.

If distribution of executable or object code is made by offering access to copy from a designated place, then offering equivalent access to copy the source code from the same place counts as distribution of the source code, even though third parties are not compelled to copy the source along with the object code.

4. You may not copy, modify, sublicense, or distribute the Program except as expressly provided under this License. Any attempt otherwise to copy, modify, sublicense or distribute the Program is void, and will automatically terminate your rights under this License. However, parties who have received copies, or rights, from you under this License will not have their licenses terminated so long as such parties remain in full compliance.

5. You are not required to accept this License, since you have not signed it. However, nothing else grants you permission to modify or distribute the Program or its derivative works. These actions are prohibited by law if you do not accept this License. Therefore, by modifying or distributing the Program (or any work based on the Program), you indicate your acceptance of this License to do so, and all its terms and conditions for copying, distributing or modifying the Program or works based on it.

6. Each time you redistribute the Program (or any work based on the Program), the recipient automatically receives a license from the original licensor to copy, distribute or modify the Program subject to these terms and conditions. You may not impose any further restrictions on the recipients' exercise of the rights granted herein. You are not responsible for enforcing compliance by third parties to this License.

7. If, as a consequence of a court judgment or allegation of patent infringement or for any other reason (not limited to patent issues), conditions are imposed on you (whether by court order, agreement or otherwise) that contradict the

conditions of this License, they do not excuse you from the conditions of this License. If you cannot distribute so as to satisfy simultaneously your obligations under this License and any other pertinent obligations, then as a consequence you may not distribute the Program at all. For example, if a patent license would not permit royalty-free redistribution of the Program by all those who receive copies directly or indirectly through you, then the only way you could satisfy both it and this License would be to refrain entirely from distribution of the Program.

If any portion of this section is held invalid or unenforceable under any particular circumstance, the balance of the section is intended to apply and the section as a whole is intended to apply in other circumstances.

It is not the purpose of this section to induce you to infringe any patents or other property right claims or to contest validity of any such claims; this section has the sole purpose of protecting the integrity of the free software distribution system, which is implemented by public license practices. Many people have made generous contributions to the wide range of software distributed through that system in reliance on consistent application of that system; it is up to the author/donor to decide if he or she is willing to distribute software through any other system and a licensee cannot impose that choice.

This section is intended to make thoroughly clear what is believed to be a consequence of the rest of this License.

8. If the distribution and/or use of the Program is restricted in certain countries either by patents or by copyrighted interfaces, the original copyright holder who places the Program under this License may add an explicit geographical distribution limitation excluding those countries, so that distribution is permitted only in or among countries not thus excluded. In such case, this License incorporates the limitation as if written in the body of this License.

9. The Free Software Foundation may publish revised and/or new versions of the General Public License from time to time. Such new versions will be similar in spirit to the present version, but may differ in detail to address new problems or concerns.

Each version is given a distinguishing version number. If the Program specifies a version number of this License which applies to it and "any later version", you have the option of following the terms and conditions either of that version or of any later version published by the Free Software Foundation. If the Program does not specify a version number of this License, you may choose any version ever published by the Free Software Foundation.

10. If you wish to incorporate parts of the Program into other free programs whose distribution conditions are different, write to the author to ask for permission. For software which is copyrighted by the Free Software Foundation, write to the Free Software Foundation; we sometimes make exceptions for this. Our decision will be guided by the two goals of preserving the free status of all derivatives of our free software and of promoting the sharing and reuse of software generally.

NO WARRANTY

11. BECAUSE THE PROGRAM IS LICENSED FREE OF CHARGE, THERE IS NO WARRANTY FOR THE PROGRAM, TO THE EXTENT PERMITTED BY APPLICABLE LAW. EXCEPT WHEN OTHERWISE STATED IN WRITING THE COPYRIGHT HOLDERS AND/OR OTHER PARTIES PROVIDE THE PROGRAM "AS IS" WITHOUT WARRANTY OF ANY KIND, EITHER EXPRESSED OR IMPLIED, INCLUDING, BUT NOT LIMITED TO, THE IMPLIED WARRANTIES OF MERCHANTABILITY AND FITNESS FOR A PARTICULAR PURPOSE. THE ENTIRE RISK AS TO THE QUALITY AND PERFORMANCE OF THE PROGRAM IS WITH YOU. SHOULD THE PROGRAM PROVE DEFECTIVE, YOU ASSUME THE COST OF ALL NECESSARY SERVICING, REPAIR OR CORRECTION.

12. IN NO EVENT UNLESS REQUIRED BY APPLICABLE LAW OR AGREED TO IN WRITING WILL ANY COPYRIGHT HOLDER, OR ANY OTHER PARTY WHO MAY MODIFY AND/OR REDISTRIBUTE THE PROGRAM AS PERMITTED ABOVE, BE LIABLE TO YOU FOR DAMAGES, INCLUDING ANY GENERAL, SPECIAL, INCIDENTAL OR CONSEQUENTIAL DAMAGES ARISING OUT OF THE USE OR INABILITY TO USE THE PROGRAM (INCLUDING BUT NOT LIMITED TO LOSS OF DATA OR DATA BEING RENDERED INACCURATE OR LOSSES SUSTAINED BY YOU OR THIRD PARTIES OR A FAILURE OF THE PROGRAM TO OPERATE WITH ANY OTHER PROGRAMS), EVEN IF SUCH HOLDER OR OTHER PARTY HAS BEEN ADVISED OF THE POSSIBILITY OF SUCH DAMAGES.

END OF TERMS AND CONDITIONS

Wireless Driver License

The Opengear firmware includes 802.11 driver code which is used in various console server models. This code is:

Copyright (c) 2007, Ralink Technology Corporation All rights reserved.

Redistribution and use in binary form, without modification, are permitted provided that the following conditions are met:

- Redistributions must reproduce the above copyright notice and the following disclaimer in the documentation and/or other materials provided with the distribution
- Neither the name of Ralink Technology Corporation nor the names of its suppliers may be used to endorse or promote products derived from this software without specific prior written permission
- No reverse engineering, decompilation, or disassembly of this software is permitted

Ralink Technology Corporation grants a world-wide, royalty-free, non-exclusive license under patents it now or hereafter owns or controls to make, have made, use, import, offer to sell and sell ("Utilize") this software, but solely to the extent that any such patent is necessary to Utilize the software alone, or in combination with an operating system licensed under an approved Open Source license as listed by the Open Source Initiative at <http://opensource.org/licenses>. The patent license shall not apply to any other combinations which include this software. No hardware per se is licensed hereunder.

DISCLAIMER. THIS SOFTWARE IS PROVIDED BY THE COPYRIGHT HOLDERS AND CONTRIBUTORS "AS IS" AND ANY EXPRESS OR IMPLIED WARRANTIES, INCLUDING, BUT NOT LIMITED TO, THE IMPLIED WARRANTIES OF MERCHANTABILITY AND FITNESS FOR A PARTICULAR PURPOSE ARE DISCLAIMED. IN NO EVENT SHALL THE COPYRIGHT OWNER OR CONTRIBUTORS BE LIABLE FOR ANY DIRECT, INDIRECT, INCIDENTAL, SPECIAL, EXEMPLARY, OR CONSEQUENTIAL DAMAGES (INCLUDING, BUT NOT LIMITED TO, PROCUREMENT OF SUBSTITUTE GOODS OR SERVICES; LOSS OF USE, DATA, OR PROFITS; OR BUSINESS INTERRUPTION) HOWEVER CAUSED AND ON ANY THEORY OF LIABILITY, WHETHER IN CONTRACT, STRICT LIABILITY, OR TORT (INCLUDING NEGLIGENCE OR OTHERWISE) ARISING IN ANY WAY OUT OF THE USE OF THIS SOFTWARE, EVEN IF ADVISED OF THE POSSIBILITY OF SUCH

14 APPENDIX G: SERVICE & STANDARD WARRANTY

STANDARD WARRANTY

Opengear, Inc., its parent, affiliates and subsidiaries, (collectively, "Opengear") warrant your Opengear product to be in good working order and to be free from defects in workmanship and material (except in those cases where the materials are supplied by the Purchaser) under normal and proper use and service for the period of four (4) years from the date of original purchase from an Authorized Opengear reseller. In the event that this product fails to meet this warranty within the applicable warranty period, and provided that Opengear confirms the specified defects, Purchaser's sole remedy is to have Opengear, in Opengear's sole discretion, repair or replace such product at the place of manufacture, at no additional charge other than the cost of freight of the defective product to and from the Purchaser. Repair parts and replacement products will be provided on an exchange basis and will be either new or reconditioned. Opengear will retain, as its property, all replaced parts and products. Notwithstanding the foregoing, this hardware warranty does not include service to replace or repair damage to the product resulting from accident, disaster, abuse, misuse, electrical stress, negligence, any non- Opengear modification of the product except as provided or explicitly recommended by Opengear, or other cause not arising out of defects in material or workmanship. This hardware warranty also does not include service to replace or repair damage to the product if the serial number or seal or any part thereof has been altered, defaced or removed. If Opengear does not find the product to be defective, the Purchaser will be invoiced for said inspection and testing at Opengear's then current rates, regardless of whether the product is under warranty.

RMA RETURN PROCEDURE

If this product requires service during the applicable warranty period, a Return Materials Authorization (RMA) number must first be obtained from Opengear. Product that is returned to Opengear for service or repair without an RMA number will be returned to the sender unexamined. Product should be returned, freight prepaid, in its original or equivalent packaging, to:

Opengear Service Center
Suite A, 630 West 9560 South
Sandy, Utah 84070

Proof of purchase date must accompany the returned product and the Purchaser shall agree to insure the product or assume the risk of loss of damage in transit. Contact Opengear by emailing support@opengear.com for further information.

TECHNICAL SUPPORT

Purchaser is entitled to thirty (30) days free telephone support and twelve (12) months free e-mail support (worldwide) from date of purchase provided that the Purchaser first register their product(s) with Opengear by filling in the on-line form <http://www.opengear.com/product-registration.html>.

Direct telephone, help-desk and e-mail support is available from 9:00 AM to 5:00 PM, Mountain Time. <http://www.opengear.com/support>

Opengear's standard warranty includes free access to Opengear's Knowledge Base as well as any application notes, white papers and other on-line resources that may become available from time to time.

Opengear reserves the right to discontinue all support for products that are no longer covered by warranty.

LIMITATION OF LIABILITY

No action, regardless of form, arising from this warranty may be brought by either party more than two (2) years after the cause of action has occurred. Purchaser expressly agrees that Opengear's liability, if any, shall be limited solely to the replacement or repair of the product in accordance with the warranties specifically and expressly set forth herein. The remedies of the Purchaser are the exclusive and sole remedies available, and, in the event of a breach or repudiation of any provision of this agreement by Opengear, the Purchaser shall not be entitled to receive any incidental damages as that term is defined in Section 2-715 of the Uniform Commercial Code. Opengear waives the benefit of any rule that disclaimer of warranty shall be construed against Opengear and agrees that such disclaimers herein shall be construed liberally in favor of Opengear.

THE FOREGOING WARRANTIES ARE THE SOLE ANDEXCLUSIVE WARRANTIES GIVEN IN CONNECTION WITH THE PRODUCT AND THE HARDWARE. OPENGEAR DISCLAIMS ALL OTHER WARRANTIES, EXPRESS OR IMPLIED, INCLUDING WITHOUT LIMITATION, ANY WARRANTIES AS TO THE SUITABILITY OR MERCHANTABILITY OR FITNESS FOR ANY PARTICULAR PURPOSE AND NONINFRINGEMENT OF THIRD PARTY RIGHTS. OPENGEAR DOES NOT PROMISE THAT THE PRODUCT IS ERROR-FREE OR WILL OPERATE WITHOUT INTERRUPTION. IN NO EVENT SHALL OPENGEAR BE LIABLE FOR ANY LOST OR ANTICIPATED PROFITS, OR ANY INCIDENTAL, EXEMPLARY, SPECIAL OR CONSEQUENTIAL DAMAGES, REGARDLESS OF WHETHER OPENGEAR WAS ADVISED OF THE POSSIBILITY OF SUCH DAMAGES.