

Marshall

Broadcast A/V Division

CV420-30X-NDI

30X NDI®|HX Camera



User Manual

Table of Contents

- NDI Instruction 03
- Safety Instructions 04
- 1. Package Contents 06
- 2. Function Introduction 06
 - 2.1 I/O Functions Introduction 06
 - 2.2 Tally Indicator Light Function Description 07
- 3. Installation Instructions 07
 - 3.1 Installation Basics 07
 - 3.2 Connecting Devices 08
- 4. Network Function Settings 11
 - 4.1 Web System Requirements 11
 - 4.2 Connecting Camera to Network 11
 - 4.3 Web Page Function Description 14
- 5. Specifications 26
- 6. Troubleshooting 28
- Warranty 29

Copyright Information

Copyrights © Marshall Electronics Incorporated. All rights reserved.

Marshall Electronics is a trademark of Marshall Electronics Incorporated

Copying, reproducing or transmitting this file is not allowed if a license is not provided by Marshall Electronics Inc. unless copying this file is for the purpose of backup after purchasing this product.

In order to keep improving the product, Marshall Electronics Inc. hereby reserves the right to make changes to product specifications without prior notice. The information in this file is subject to change without prior notice.

To fully explain or describe how this product should be used, this manual may refer to names of other products or companies without any intention of infringement.

Disclaimer of warranties: Marshall Electronics Inc. is neither responsible for any possible technological, editorial errors or omissions, nor responsible for any incidental or related damages arising from providing this file, using, or operating this product.



Understanding Quick setup of CV420-30X-NDI with NDI|HX

This section explains how to quickly configure the Marshall CV420-30X-NDI camera with NDI|HX.

It also explains how to update the device, and where you can find additional NDI software to extend your workflow. Complete NDI® Tools can be found here: <https://www.ndi.tv/tools/>

Here you will choose whether you will require NDI® Tools for Windows or Mac and download.

After completing this short section, you will be all set to begin using your new NDI|HX camera.

OVERVIEW: Unlike typical cameras, CV420-30X-NDI leverages the easy plug-n-play benefits of the NDI-based IP workflow supported by leading video software and hardware developers around the globe.

GETTING READY: Your new CV420-30X-NDI uses the NDI|HX protocol for audio/video transmission, and more. Your first step will be to install NDI|HX drivers if using a TriCaster, or Microsoft HEVC decode on non-TriCaster systems, as appropriate for your computer platform or device.

1. Navigate to [ndi.tv/formats](https://www.ndi.tv/formats) in your web browser and follow the relevant directions to download and install the drivers for your computer platform. NOTE: The NDI|HX driver also installs NewTek's NDI Studio Monitor application, which will not only display the output of your camera but also provide easy access to its settings. Also contains built-in PTZ controls.
2. NDI Studio Monitor and other useful NDI tools can be found here: <https://www.ndi.tv/tools/>
3. Then simply plug the Ethernet (NDI) port to same Network your computer or Newtek equipment are plugged into and off you go.

NOTE: The End User License Agreement under which you use the NDI|HX driver specifies that “you may use up to five (5), and no more than five, copies on separate machines at one time.”

OPTIONAL – for Microsoft Windows® users, downloading and installing the NewTek NDI® Tools pack, available at no cost from [ndi.tv/tools/](https://www.ndi.tv/tools/), the download pack will provide learning tools and utilities to maximize your NDI|HX experience.

FINAL NOTE – if you are experiencing any problems with the NDI® platform, NDI® software, NDI® drivers please contact Newtek for technical assistance or join the NDI community to review HOW-TO videos, social media, forums, blogs: www.ndi.tv/community

If you are having a hardware problem, and need assistance please contact Marshall Electronics.

Marshall Customer Support

Toll Free: 800-800-6608 or 310-333-0606

Email: support@marshall-usa.com

Safety Instructions

1. Operation

- 1.1 Use camera in the recommended operating environments.
- 1.2 Do not place the camera in tilted position.
- 1.3 Do not place the product on an unstable cart, stand or table.
- 1.4 Do not use this product near water, extreme humidity or high heat.
- 1.5 Use recommended ¼”-20 mounts and attachments.
- 1.6 Use the power supply that is provided in box.
- 1.7 Always take the following precautions when handling the power plug. Failure to do so may result in sparks, shock or fire:
 - Ensure the plug is free of dust before inserting it into a socket.
 - Ensure that the plug is inserted into the socket completely and securely.
- 1.8 Do not overload wall sockets, use long extension cords, or plug camera into multi-output power strips.
- 1.9 Do not block vents on the camera body as they provide ventilation and prevent the product from overheating.
- 1.10 Do not open or remove camera body, camera warranty is void if opened.
- 1.11 Unplug the product from the wall outlet and consult a licensed service technician when the following conditions arise:
 - If the power cords are damaged or frayed.
 - If liquid is spilled into the product or the product has been exposed to rain or water.

2. Installation

- 2.1 For security consideration, please make sure any mounts that are used are standard UL or CE safety certified and installed by technician personnel.

3. Storage

- 3.1 Do not mount camera where power cord can be stepped on, as this may result in fraying or damage to the lead or the plug.
- 3.2 Never allow debris or objects of any kind to penetrate camera body. Never allow liquid of any kind to spill onto or into the camera body.
- 3.3 Unplug this product during thunderstorms, during electrical surges, or if it is not going to be used for an extended period of time.
- 3.4 Do not place camera or accessories on top of vibrating equipment or heated objects.

4. Cleaning

- 4.1 Unplug all the cables before cleaning. Use a damp cloth for cleaning. Do not use liquid or aerosol cleaners or allow any liquids to enter camera body.

Precautions

Warning: To reduce the risk of fire or electric shock, do not expose this camera to rain, moisture, debris or liquids.

If the HD camera will not be used for an extended time, unplug it from the power socket.



Caution: To reduce the risk of electric shock, do not remove cover (or back). No user-serviceable parts inside. Refer servicing to licensed service personnel. Please do not open it by yourself



This symbol indicates that this equipment may contain dangerous voltage which could cause electric shock.



This symbol indicates that there are important operating and maintenance instructions in this User Manual with this unit.

FCC Warning

This product has been tested and found to comply with the limits for a Class B computer device, pursuant to Article 15-J of FCC Rules. These limits are designed to provide reasonable protection against harmful interference in a residential installation.

This digital apparatus does not exceed the Class B limits for radio noise emissions from digital apparatus as set out in the interference-causing equipment standard entitled “Digital Apparatus” ICES-003 of Industry Canada.

Cet appareil numérique respecte les limites de bruits radioélectriques applicables aux appareils numériques de Classe B prescrites dans la norme sur le matériel brouilleur: “Appareils Numériques,” NMB-003 édictée par l’Industrie.

EN55032 (CE Radiation) Warning

Operation of this equipment in a residential environment could cause radio interference.

1. Package Contents

CV420-30X-NDI



Power Cord



*Appearance may vary depending on country/region

Power Adapter



2. Function Introduction

2.1 I/O functions Introductions



No.	Item.	Function Descriptions
1	Lens	30x HD/UHD camera lens
2	Tally indicator light	Tally light displays status of the camera
3	Network port	Network port. Support routers or hubs (IEEE 802.3 af) with PoE power supply support
4	HDMI output	The factory output resolution is 4K/30. Please make sure that the connected display device supports 4K resolution
5	Reset	Push for factory default and IP address reset
6	RS232 output	RS232 output port. At most 7 cameras can be connected in a serial connection
7	RS232 input	RS232 input port. At most 7 cameras can be connected in a serial connection
8	DC 12 V power connector	AC power supply connecting port
9	Power indicator light	After power is on, the indicator light will display in red
10	Audio input	3.5mm Audio Input supports Line-level or Mic-level Stereo/Mono input
11	Audio output	Loop-through 3.5mm Output
12	Tripod screw holes	The camera is mounted on a (specification) 1/4", 20 UNC tripod deck
13	Fiducial Hole	Ø5; depth 2mm

2.2 Tally Indicator Light Function Description

2.2.1 The tally indicator light function may be enabled through the control of RS232 command.

The setting method is as follows:
Tally Mode : 8x 01 7E 01 0A 01 0p FF
p = 0 : OFF
p = 4 : On (half-brightness)
p = 5 : On (full-brightness)

3. Installation Instructions

3.1 Installation Basics

3.1.1 CV420-30X-NDI Dimensions

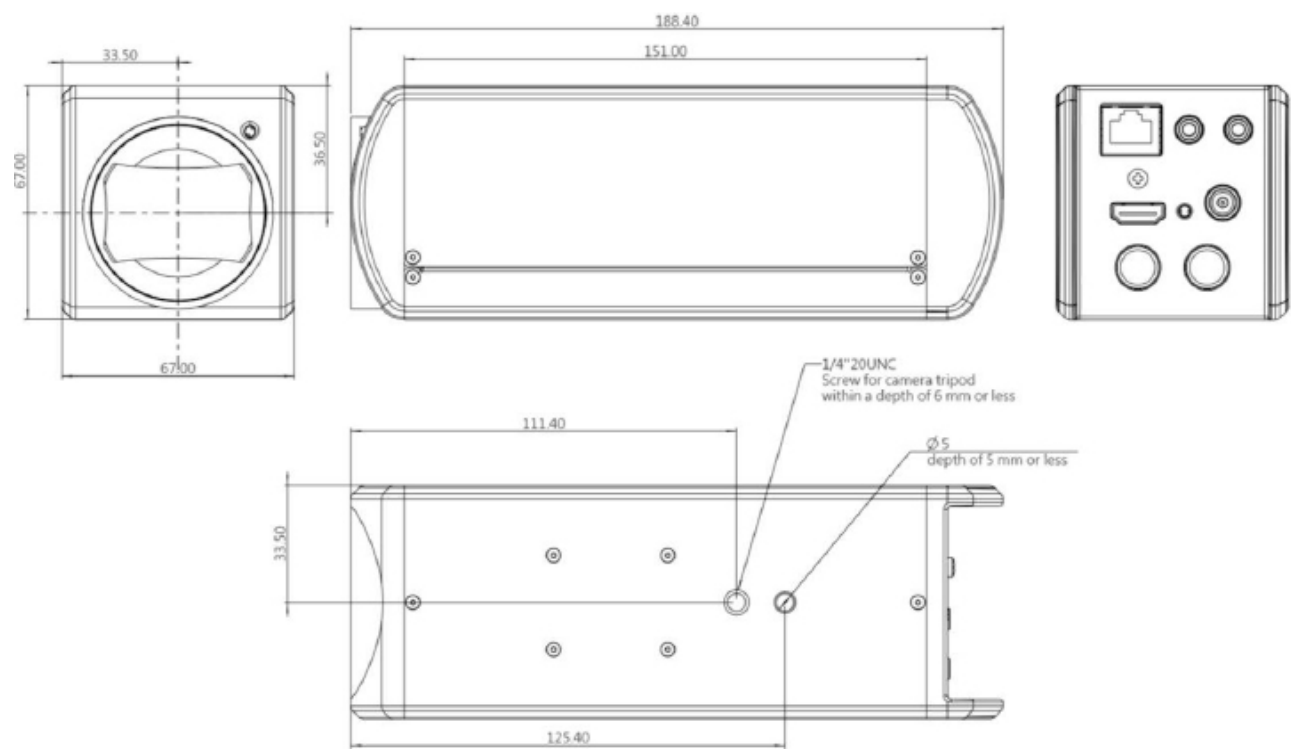

3.2 Connecting devices

3.2.1 HDMI connection to TV/display screen

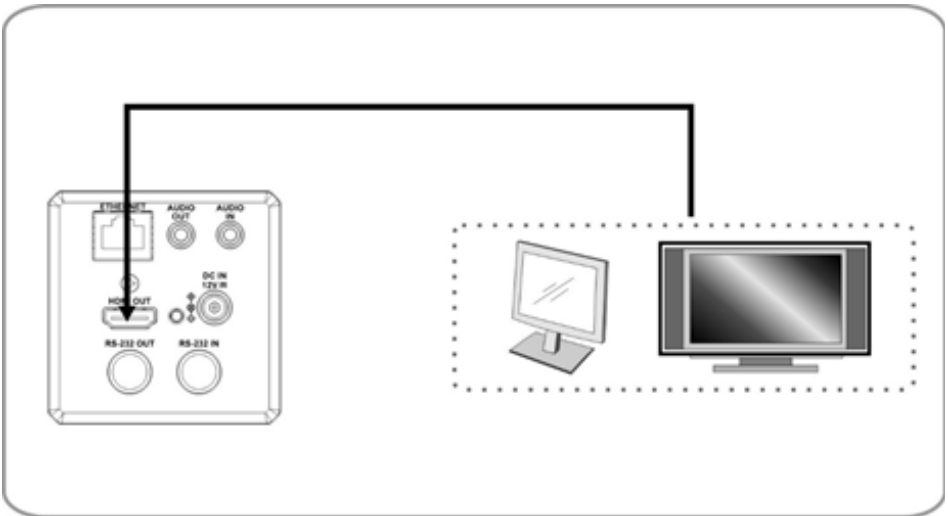

3.2.2 Connecting to Internet

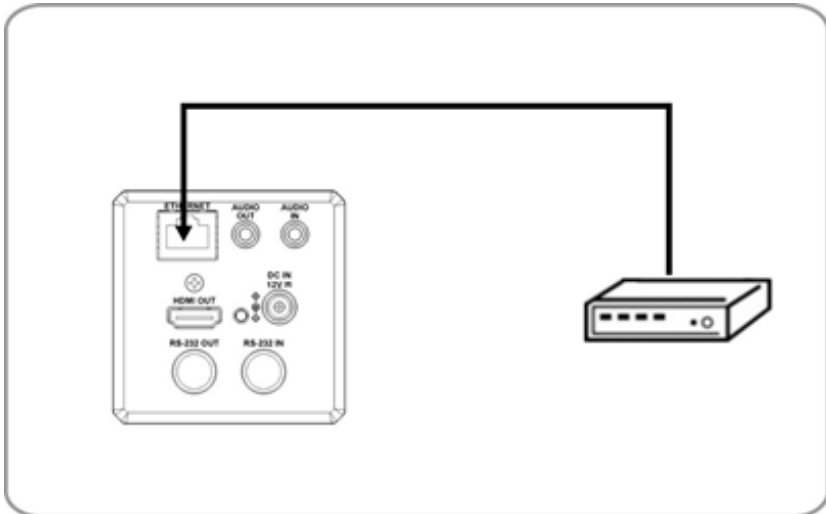

For details of web page connection setting and description, please refer to Chapter 5 Network Function Settings Description.

3.2.3 Connecting AUDIO IN

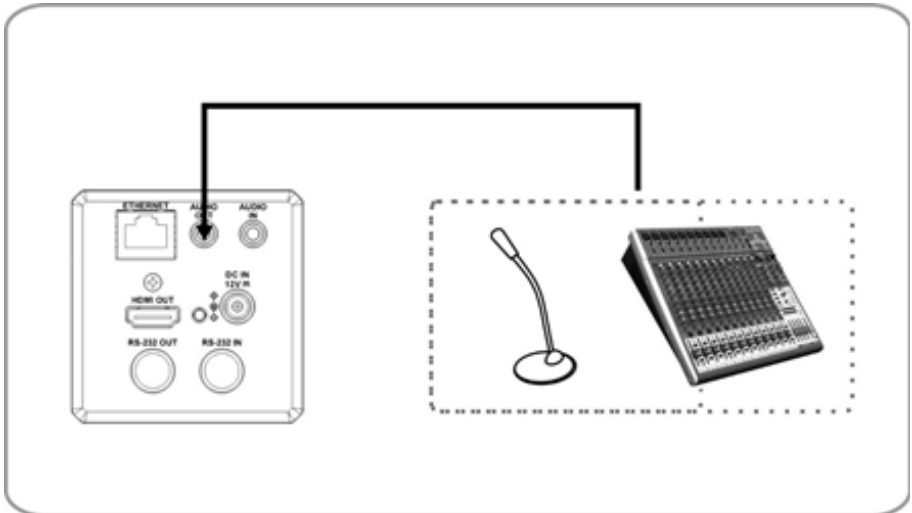

3.2.4 Connecting RS-232

CV420 camera includes a RS232 IN and OUT for Daisy Chain style connections, or can be setup via home run using splitters (use CV620-CABLE-07 extenders to convert to CAT RJ45 cables for longer runs).

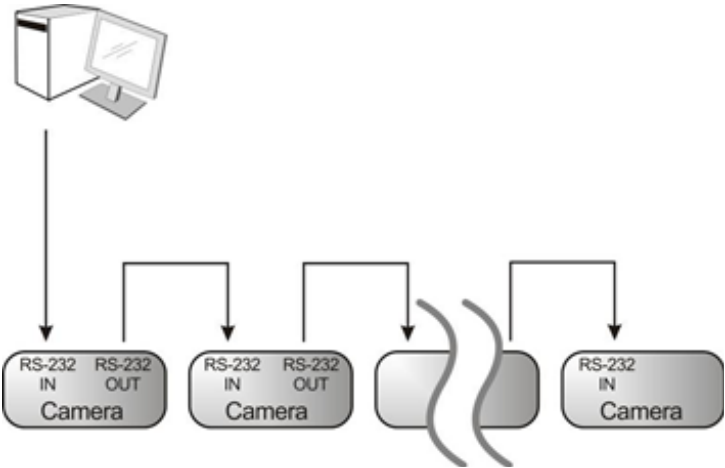

- RS-232 pin definition description

RS-232 IN Pins Instructions

NO	Pins	Signals
1	DTR	Data Transmission Reade
2	DSR	Data Set Reade
3	TXD	Transmit Data
4	GND	Ground
5	RXD	Receive Data
6	GND	Ground
7	IR OUT	IR Commander Signal
8	N.C.	No Connection

RS-232 OUT Pins Instructions

NO	Pins	Signals
1	DTR	Data Transmission Reade
2	DSR	Data Set Reade
3	TXD	Transmit Data
4	GND	Ground
5	RXD	Receive Data
6	GND	Ground
7	OPEN	Reserved
8	OPEN	Reserved

RS-232 Connection Instructions

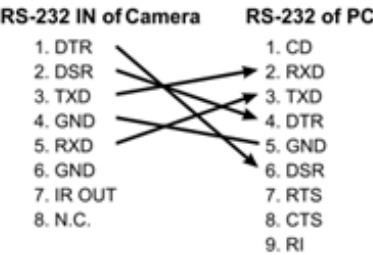

RS-232 Connection Instructions

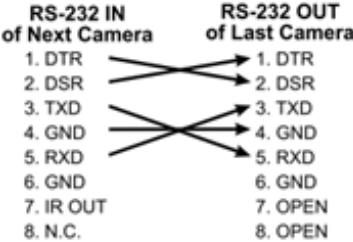

4. Network Function Settings

4.1 Web System Requirements

4.1.1 Web Browser:

- Internet Explorer 11 or above
- FireFox 66.0.3 or above
- Chrome 73 or above
- Edge 42.17134 or above
- Safari 12.1 or above

4.2 Connecting Camera to Network

4.2.1 Connecting to Internet

Two common connection methods are shown below

1. Connecting via switch or router



2. If the camera is connected to the computer directly, the computer IP address must be modified to have the same network segment as the camera

For example, the factory-preset default IP address of CV420-30X-NDI is 192.168.100.100. The computer IP address must be set with the same subnet, such as 192.168.100.101, so that the computer can be connected correctly with the camera

- Connection Diagram
- Change network settings

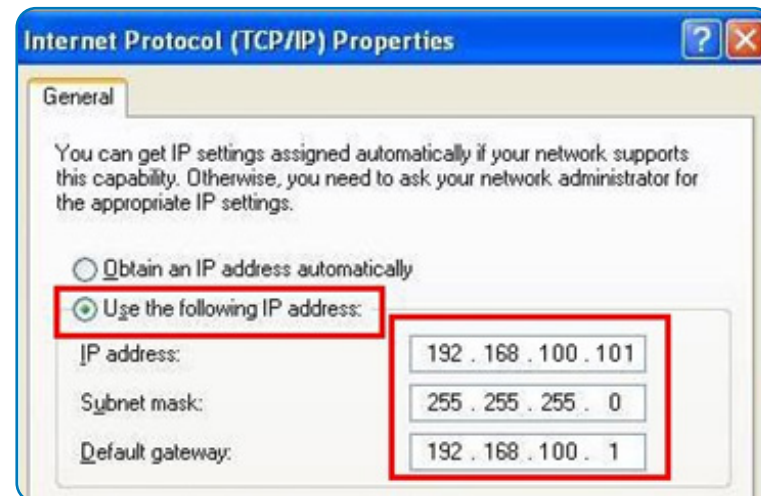

Suggested minimum system requirement for HEVC 4K60 IP Streaming:

- Windows 10
- CPU: Intel i5 (7th gen and above)
- GPU: intel (7th gen and above) or Nvidia GTX 1050 and above
- Memory: 8GB(64-bits) RAM
- Ethernet : Gigabyte
- 1GB Free Disk Space

4.2.2 Using the Browser to View the Images

- Open the browser, and enter the URL of CV420-30X-NDI in the IP address bar
e.g.: http://192.168.100.100 (default IP address)
- Enter administrator’s account and password
Account: admin (Default)
Password: 9999 (Default)



4.3 Web Page Function Description

4.3.1 Login Screen



No.	Item.	Function Descriptions
1	Username	Enter user account name (default: admin)
2	Password	Enter user password (default: 9999)
3	Language selection	The system currently supports English, Traditional Chinese, and Simplified Chinese
4	Remember password	Saves user account name and password to the browser.
5	Login	Log into the administrator screen on the website

4.3.2 Viewing In Real Time

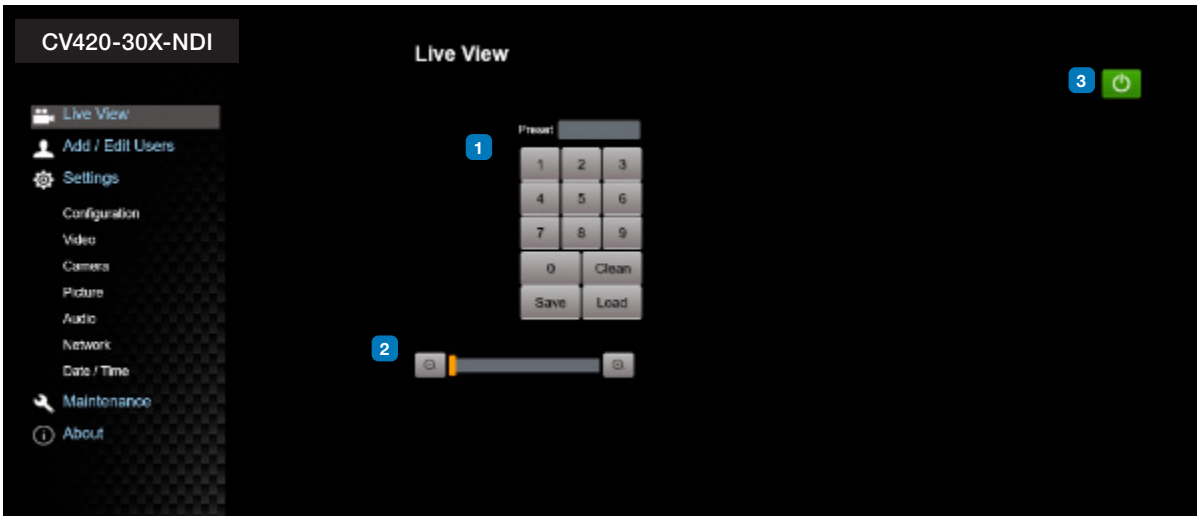

No.	Item.	Function Descriptions
1	Preset setting	Select the number first and then select SAVE or LOAD
2	Zoom ratio	Adjust the zoom-in or zoom-out ratio via scroll bar
3	Power button	Turn on or turn off the camera power

4.3.3 Account Management

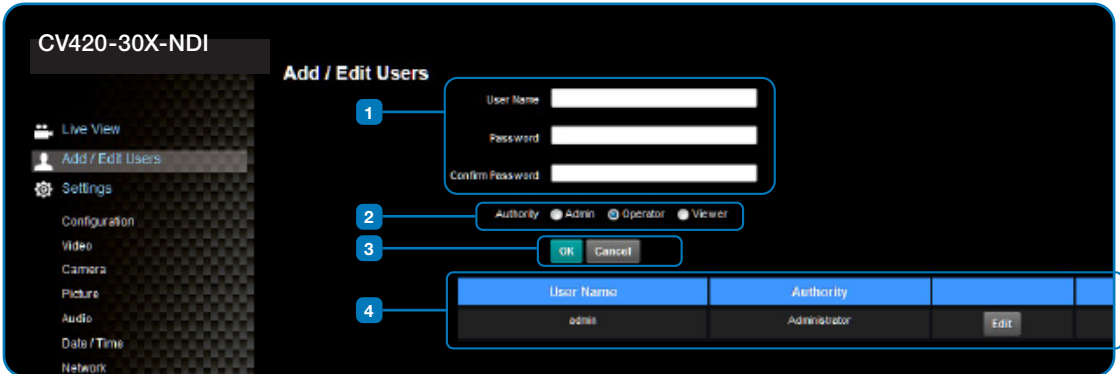

No.	Item.	Function Descriptions																
1	Add user account	Enter a username and password to add a new user																
2	Permission setting	Set the new account management permissions <table border="1" style="margin-left: 20px;"> <thead> <tr> <th>User Type</th> <th>Admin</th> <th>Operator</th> <th>Viewer</th> </tr> </thead> <tbody> <tr> <td>View images</td> <td>Y</td> <td>Y</td> <td>Y</td> </tr> <tr> <td>Settings</td> <td>Y</td> <td>Y</td> <td>N</td> </tr> <tr> <td>Account management</td> <td>Y</td> <td>N</td> <td>N</td> </tr> </tbody> </table>	User Type	Admin	Operator	Viewer	View images	Y	Y	Y	Settings	Y	Y	N	Account management	Y	N	N
User Type	Admin	Operator	Viewer															
View images	Y	Y	Y															
Settings	Y	Y	N															
Account management	Y	N	N															
3	Applying setting	Add the newly created user to the account list																
4	List of accounts	Edit: Modify the user password and permissions																

4.3.4 System Configurations

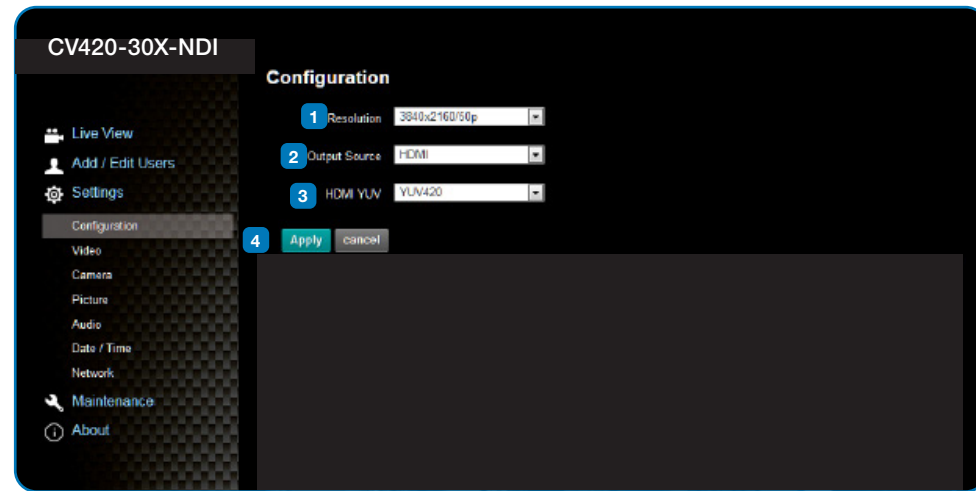

No.	Item.	Function Descriptions																	
1	Resolution	Set the resolution of the camera. Resolutions supported by the camera are as follows: 3840x2160P 59.94/50/29.97 fps 1080P 59.94/50/29.97/25 fps 720P 59.94/50/29.97/25 fps After switching to the resolution, the camera will restart. Please refresh the browser																	
2	Output signal	According to the output resolution, selections are available for HDMI output, streaming output, or HDMI + streaming output. For output signals supported by different resolution, please refer to the following table: <table border="1" style="margin-left: 20px;"> <thead> <tr> <th>Resolution</th> <th>Available output modes</th> </tr> </thead> <tbody> <tr> <td>3840x2160/59.94p</td> <td>HDMI or streaming single output</td> </tr> <tr> <td>3840x2160/50p</td> <td>HDMI or streaming single output</td> </tr> <tr> <td>3840x2160/29.97p</td> <td rowspan="7">Simultaneous HDMI and streaming outputs</td> </tr> <tr> <td>3840x2160/25p</td> </tr> <tr> <td>1080p/59.94</td> </tr> <tr> <td>1080p/50</td> </tr> <tr> <td>1080p/29.97</td> </tr> <tr> <td>1080p/25</td> </tr> <tr> <td>720p/59.94</td> </tr> <tr> <td>720p/50</td> </tr> <tr> <td>720p/29.97</td> </tr> <tr> <td>720p/25</td> </tr> </tbody> </table>	Resolution	Available output modes	3840x2160/59.94p	HDMI or streaming single output	3840x2160/50p	HDMI or streaming single output	3840x2160/29.97p	Simultaneous HDMI and streaming outputs	3840x2160/25p	1080p/59.94	1080p/50	1080p/29.97	1080p/25	720p/59.94	720p/50	720p/29.97	720p/25
Resolution	Available output modes																		
3840x2160/59.94p	HDMI or streaming single output																		
3840x2160/50p	HDMI or streaming single output																		
3840x2160/29.97p	Simultaneous HDMI and streaming outputs																		
3840x2160/25p																			
1080p/59.94																			
1080p/50																			
1080p/29.97																			
1080p/25																			
720p/59.94																			
720p/50																			
720p/29.97																			
720p/25																			
3	HDMI YUV	Select YUV422 or YUV420 (This function is only available for these two resolutions, 3840x2160/59.94p and 3840x2160/50p and remains in display mode for all other resolutions)																	
4	Apply	After the setting has been modified, select this button to apply the setting																	

4.3.5 Video Settings

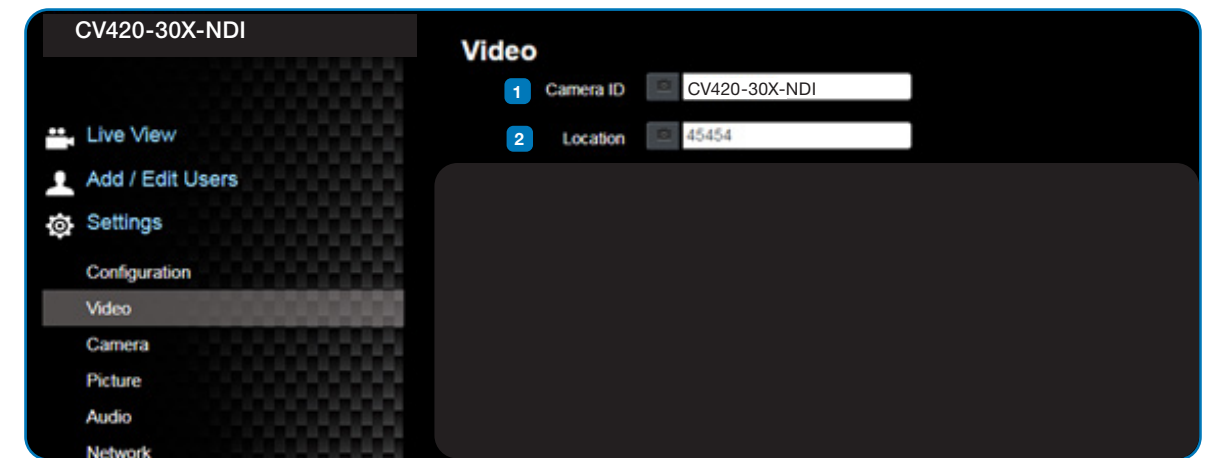

No.	Item.	Function Descriptions
1	Camera name	Modify the camera name <ul style="list-style-type: none"> • Camera names are limited to 1-12 characters • Please use a camera name by mixing uppercase and lowercase letters and numbers. Do not use “/” and “space” or special symbols
2	Camera location	Modify the location of the camera, such as Meeting Room 1 <ul style="list-style-type: none"> • Camera locations are limited to 1-12 characters • Please use a camera name by mixing uppercase and lowercase letters and numbers. Do not use “/” and “space” or special symbols

4.3.6 Camera Settings



No.	Item.	Function Descriptions
1	Zoom ratio	Adjust the zoom-in or zoom-out ratio via scroll bar
2	Exposure	<ul style="list-style-type: none"> Mode: Select exposure mode (Automatic/Shutter Priority/Aperture Priority/Manual) Exposure Comp. Level: Select exposure compensation level Gain: The gain limit is adjustable when the exposure mode is set to "Manual" Iris: The size of aperture is adjustable when the exposure mode is set to "Manual" or "Aperture Priority" WDR: Set the level of wide dynamic range (WDR) in order to obtain better images in dynamic lighting environments. Shutter Speed: The shutter speed is adjustable when the exposure mode is set to "Manual" or "Shutter Priority"
3	White balance	<ul style="list-style-type: none"> Mode: Select the color temperature mode <ul style="list-style-type: none"> Auto Indoor Outdoor One Push WB ATW Manual Sodium Lamp Open Push Trigger: One push color temperature is adjustable when the white balance mode is set to "One Push Trigger" Manual Red/Blue: Manually adjust blue/red color temperature
4	Focus	<ul style="list-style-type: none"> Mode: Select manual/automatic focus Focus Range: The focusing range is adjustable when the focus mode is set to "Manual" AF Sensitivity: Set automatic focus sensitivity AF Frame: Set automatic focus range
5	MIRROR	<ul style="list-style-type: none"> Mirror: Set automatic flip mode

4.3.7 Picture Settings

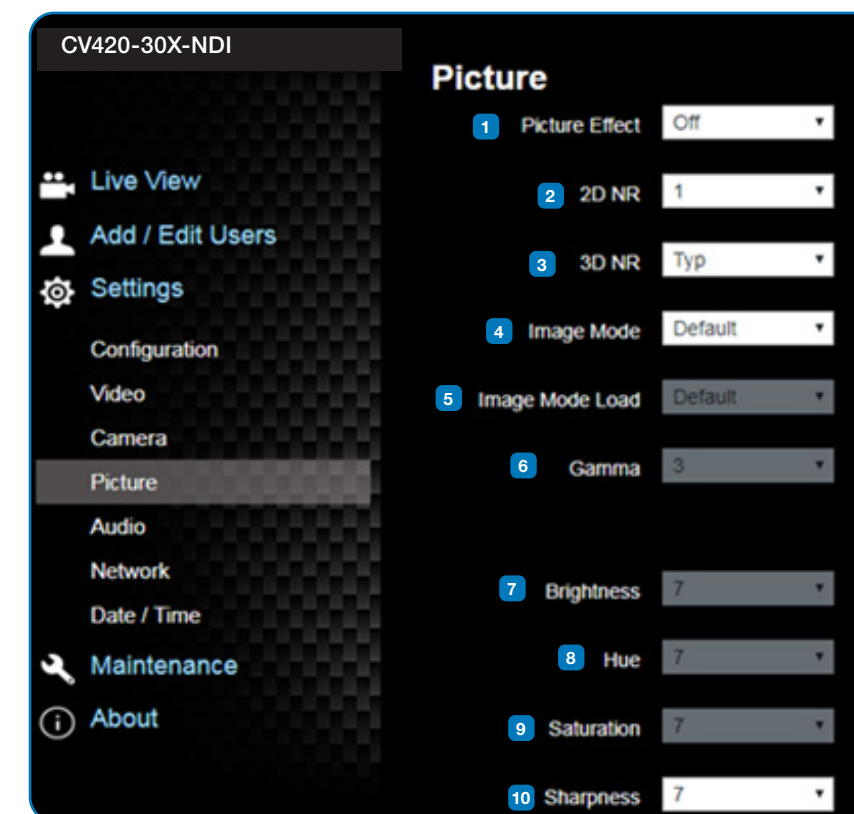

No	Item	Function Descriptions
1	Picture effect	Set picture effect, Off / Film / Black and White
2	2D noise reduction settings	<ul style="list-style-type: none"> 2D noise reduction settings
3	3D noise reduction settings	<ul style="list-style-type: none"> 3D noise reduction settings
4	Image mode	<ul style="list-style-type: none"> The user may customize his/her desired image mode
5	Image mode load	<ul style="list-style-type: none"> When no custom setting is needed, reset the picture parameters back to the factory default by selecting this item
6	Gamma	<ul style="list-style-type: none"> Gamma Level adjustment; Adjustable when the image mode is set to Custom
7	Brightness	<ul style="list-style-type: none"> Brightness adjustment; Adjustable when the image mode is set to Custom
8	Contrast	<ul style="list-style-type: none"> Contrast adjustment; Adjustable when the image mode is set to Custom
9	Saturation	<ul style="list-style-type: none"> Saturation adjustment; Adjustable when the image mode is set to Custom
10	Sharpness	<ul style="list-style-type: none"> Adjust the sharpness of the image

4.3.8 Camera Settings

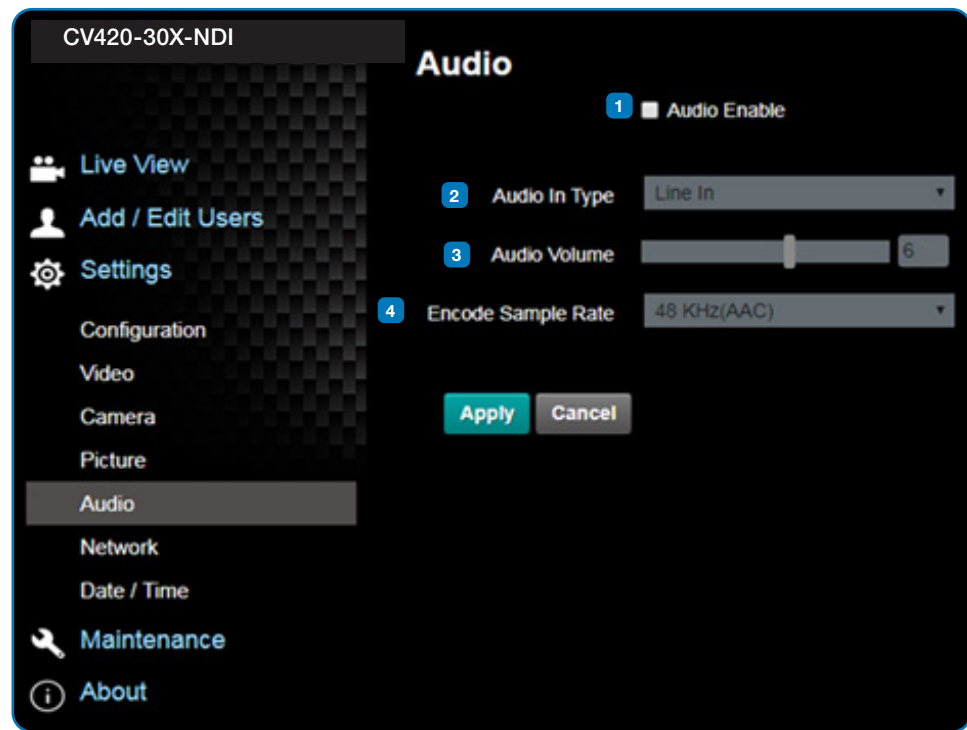

No.	Item.	Function Descriptions
1	Open audio	Turn on / off sound
2	Soundtrack effect setting	Set MIC In / Line In
3	Audio Volume	Adjust Volume
4	Encode sample rate	Set Encode sample rate <ul style="list-style-type: none"> • 48 KHz(AAC) • 44.1 KHz(AAC) • 16 KHz(G.711) • 8 KHz(G.711)

4.3.9 Time Settings

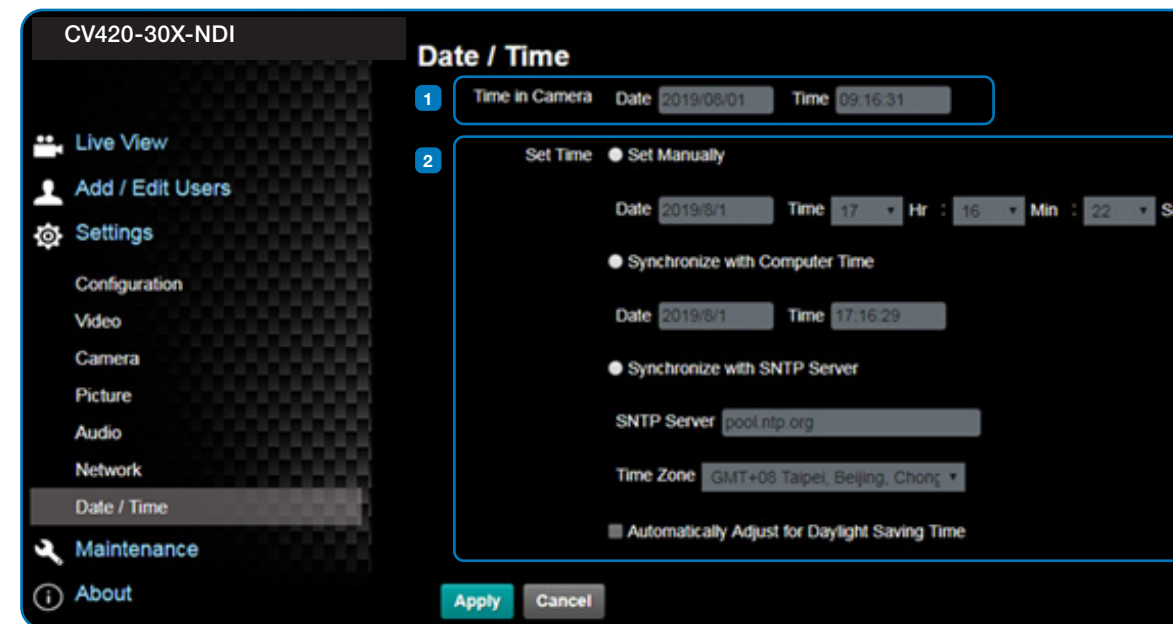

No.	Item.	Function Descriptions
1	Camera Time	Display the date and time of the camera
2	Set the Time	<ul style="list-style-type: none"> • Set Manually: Set time manually • Synchronize with computer time: Set the camera time according to the computer time • Synchronize with SNTP server: Set the camera time synchronously with the SNTP server <p><Remark> SNTP server address: Please change in network setting</p>

4.3.10 Network Settings

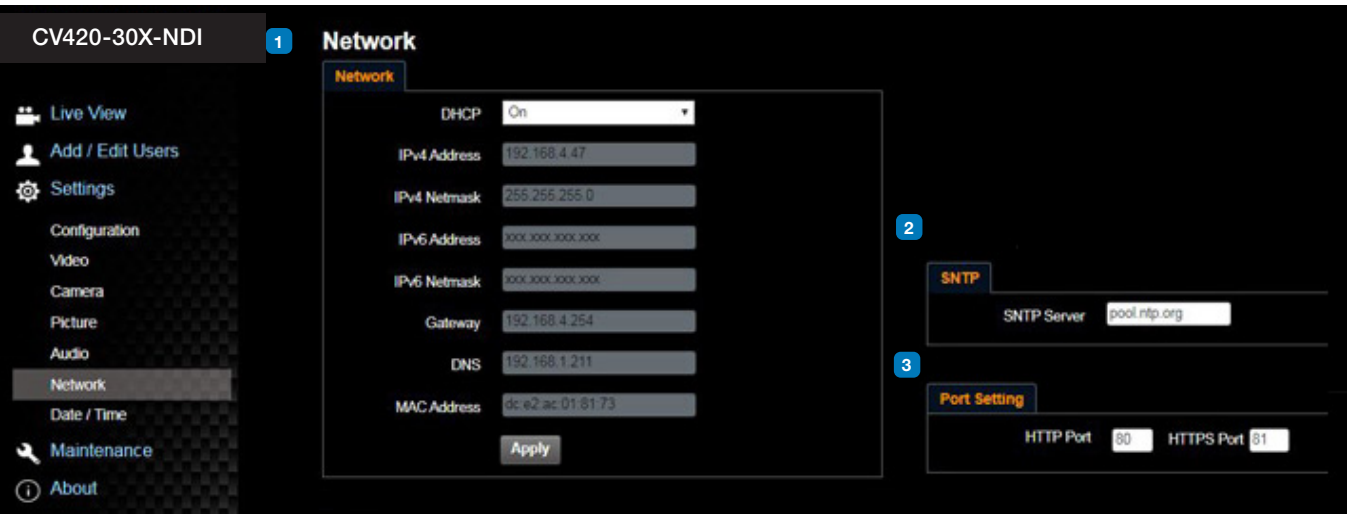

No.	Item.	Function Descriptions
1	Network	Network setting of camera. Change of setting is available only when DHCP function is closed.
2	SNTP Setting	Set SNTP Server IP
3	Port Setting	Set HTTP and HTTPS ports. The default values are Port 80 and Port 81 respectively <Remark> Change of setting is available only when DHCP function of camera is closed

4.3.11 Maintenance and Updating Firmware

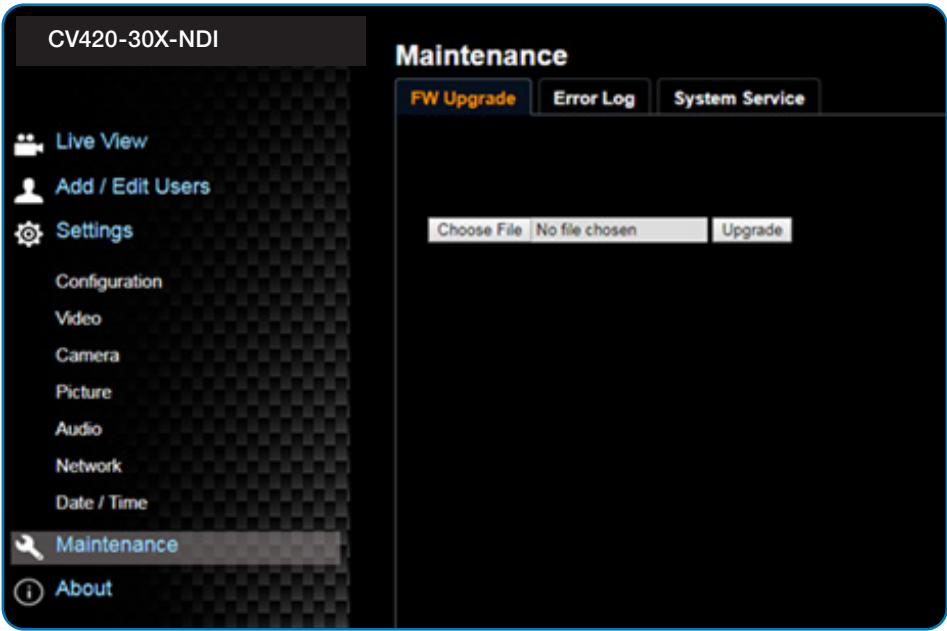

No.	Item.	Function Descriptions
1	Firmware Update	The camera firmware may be upgraded via web page. For the upgrade method, please download the FW upgrade manual from Marshall website

4.3.12 Incident/Error Logs

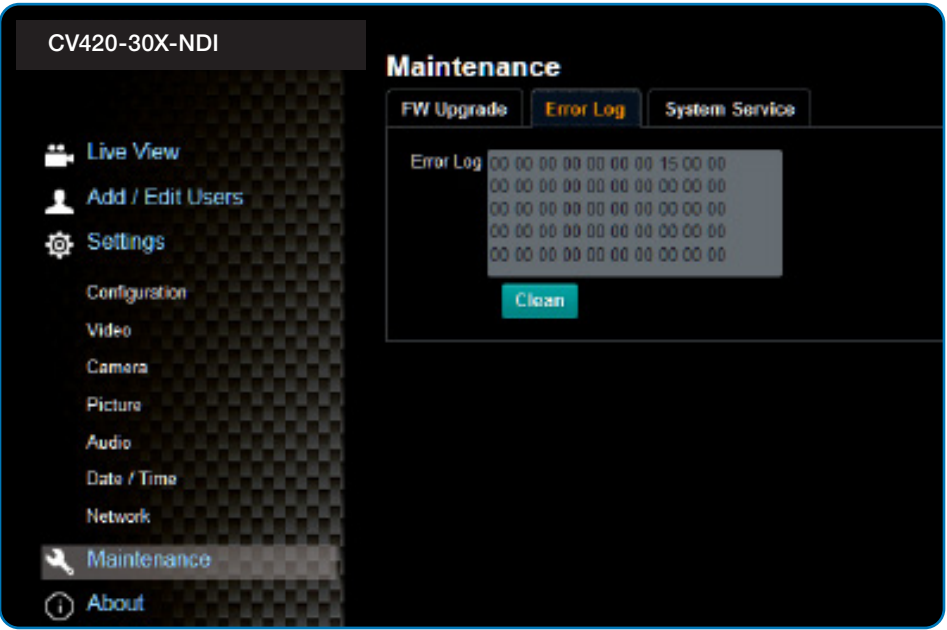

No.	Item.	Function Descriptions
1	Event Logs	If the camera encounters errors, an error code log will be established

4.3.13 Additional Maintenance Settings

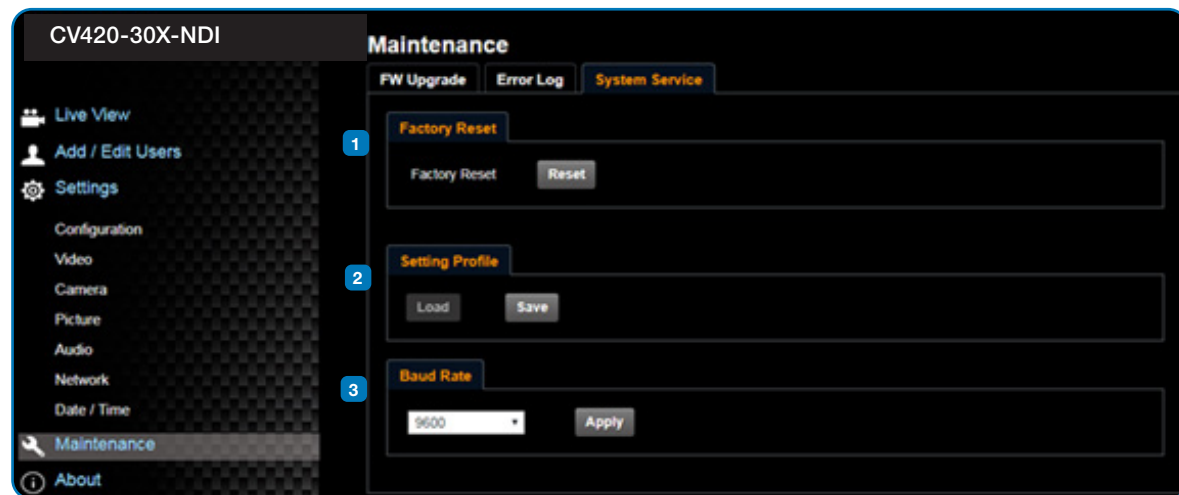

No.	Item.	Function Descriptions
1	Reset to the default value	Select the reset button to resume the factory default setting as the web page setting value
2	Setting File	The web page setting parameters can be exported from the computer and imported/applied to another camera
3	Baud Rate	Set the camera Baud Rate for the use of connecting RS-232 communication

4.3.14 About

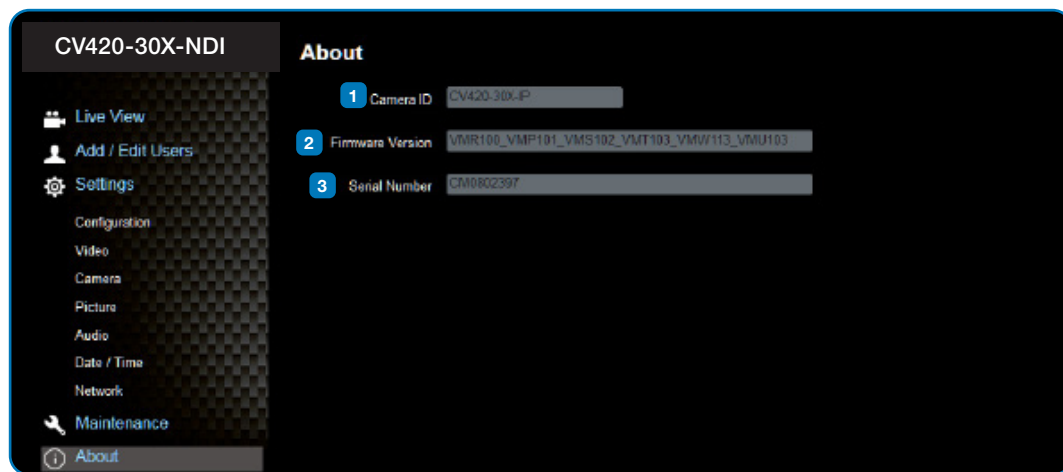

No.	Item.	Function Descriptions
1	Camera ID	Display the camera name
2	Firmware Version	Display the firmware version of the camera
3	Serial Number	Display the camera serial No.

5. Specifications

Sensor	1/2.5" 8MP CMOS
Video Format	"Resolution: 3840x2160p (UHD), 1920x1080p (HD), 1280x720p
Frame-rate : 59.94/50/29.97/25 fps"	30x
Optical Zoom	30x
Focal Length	4.6mm ~ 135mm
Angle-of-View (Horizontal)	68° ~ 3.5°
Aperture	F1.5 ~ F3.4
Shutter Speed	1/1 ~ 1/10,000 sec
Minimum Object Distance	1.5m (Wide/Tele)
Video S/N Ratio	> 50dB
Color	Color: 0.1 Lux, F1.6, 50 IRE, AGC on
Night	BW: 0.02 Lux, F1.6, 50 IRE, AGC on
Preset Points	256
Iris Control	Auto or Manual (remote control)
Lens Control	Autofocus: Auto, One-Push fast AF, Interval AF, Zoom Trigger AF, Zoom Tracking, ICR Compensation AF
Exposure Control	"Auto mode:
Manual mode: shutter speed 1/1~1/10000	"AGC
Shutter-Priority mode: shutter speed 1/1~1/10000	Manual gain"
IRIS Pri	"Auto (2500K~7500K) ATW (2000K~10000K) Manual WB (R/B gain, One-push WB) Indoor (3200K) Outdoor (5800K)"
Gain Control	"AGC
Manual gain"	Yes
White Balance	"Auto (2500K~7500K) ATW (2000K~10000K)
Manual WB (R/B gain, One-push WB) Indoor (3200K)	Yes
Outdoor (5800K)"	Configurable
Backlight Compensation	On/Off
Defog	Yes
EV Compensation	Auto/IRIS Pri/Shutter-Priority Mode: -5~+5
Gamma Correction	Yes

Sharpness	Configurable
Noise Reduction	2D/3D NR
Dynamic Range	WDR
Video Orientation	OFF, Flip, Mirror, Both
Video Standard	HEVC, H.264
Multiple Video Stream	Two streaming structure
HEVC 4K60fps + H.264 640x360 30fps	ONVIF profile S
Audio Compression Format	AAC
Protocols	DHCP, DNS, HTTP, HTTPS, IPv4, UDP, NDI
Internet Security	"IEEE 802.1X HTTPS"
Control Interface	RS-232 and NDI
HDMI Output	HDMI 2.0
Audio Out	Line Out, 3.5mm (Stereo/Mono)
Audio in	Line In, 3.5mm (Stereo/Mono)
RS-232 In	8 Pin Mini-Din
RS-232 Out	8 Pin Mini-Din
DC In	12V +/- 20%
PoE	802.3 af
Power consumption	< 12W
Storage Temperatures	-20°C ~ 60°C (-4°F ~ 140°F)
Operating Temperatures	0°C ~ 40°C (32°F ~ 104°F)
Weight	1 kg
Dimension	188.4mm (L) x 67mm (H) x 67 mm (W)

6. Troubleshooting

This chapter describes problems you may encounter while using CV420-30X-NDI. If you have questions, please refer to related chapters and follow all the suggested solutions. If the problem remains, please contact your distributor or the service center.

No.	Problem	Solution
1	Boot without power signal	<ol style="list-style-type: none"> 1. Make sure you have plugged in the power cord. 2. When using a PoE connection, ensure that the power supply supports IEEE 802.3af hubs
2	There is no image output from CV420-30X-NDI	<ol style="list-style-type: none"> 1. Check the power supply or PoE supply functions. 2. Confirm the output signals are in streaming output. 3. If the camera is connected to a monitor, confirm the monitor equipment supports 4K output 4. Replace the cables and make sure they are not faulty.
3	CV420-30X-NDI image is severely delayed	Please use 4K, 1080p or 720p 60/50 Hz signals rather than 25/30 Hz signals.
4	RS-232 cannot be controlled	<ol style="list-style-type: none"> 1. Confirm the connection is correct (RS-232 Input / Output). 2. Please make sure the Baud rate setting is the same as the control equipment.
5	Whether the Internet can be used for operation	Please refer to Chapter 5 Network Function Description for the Internet usage or call marshall tech support.

Warranty

Marshall Electronics warrants to the first consumer that this device will, under normal use, be free from defects in workmanship and materials, when received in its original container, for a period of three years from the purchase date. This warranty is extended to the first consumer only, and proof of purchase is necessary to honor the warranty. If there is no proof of purchase provided with a warranty claim, Marshall Electronics reserves the right not to honor the warranty set forth above. Therefore, labor and parts may be charged to the consumer. This warranty does not apply to the product exterior or cosmetics. Misuse, abnormal handling, alterations or modifications in design or construction void this warranty. No sales personnel of the seller or any other person is authorized to make any warranties other than those described above, or to extend the duration of any warranties on behalf of Marshall Electronics, beyond the time period described above.

Due to constant effort to improve products and product features, specifications may change without notice.

Marshall

20608 Madrona Avenue, Torrance, CA 90503

Tel: (800) 800-6608 / (310) 333-0606 • Fax: 310-333-0688

www.marshall-usa.com

support@marshall-usa.com