

# **ST-C8000/ST-C8090 User's Guide**



---

# Contents

<b>ST-C8000/ST-C8090 User's Guide</b> .....	<b>15</b>
<b>Product Basics</b> .....	<b>16</b>
Using the Control Panel .....	16
Control Panel Buttons and Lights .....	17
The LCD Screen .....	18
Status Icon Information .....	18
Entering Characters on the LCD Screen .....	19
Job/Status Screen.....	21
Viewing Animations.....	21
Selecting the Date and Time .....	22
Selecting Your Country or Region .....	23
Setting a Password and Locking the Control Panel .....	24
Using Presets.....	25
Setting User Feature Restrictions (Access Control) .....	28
Changing LCD Screen Language.....	29
Adjusting Control Panel Sounds .....	30
Adjusting the Screen Brightness.....	31
Turning Off the Operation Time Out Setting .....	32
Preventing PC Connection via USB .....	33
Product Parts Locations .....	33
Product Parts - Front .....	34
Product Parts - Inside .....	36
Product Parts - Back.....	38
Using Power Saving Settings .....	38
Changing the Sleep Timer Settings .....	39
Changing the Power Off Timer Settings .....	39
Epson Connect Solutions for Smartphones, Tablets, and More .....	40
Setting Up Epson Connect Services.....	41
Using Epson Email Print .....	42
Using the Epson iPrint Mobile App .....	43

Using Epson Remote Print .....	43
Using Epson Scan to Cloud .....	44
Using AirPrint .....	45
Android Printing Using the Epson Print Enabler .....	45
Using Fire OS Printing .....	46
Using Windows 10 Mobile Printing .....	46
Using Epson Print and Scan App with Windows Tablets .....	47
Using the Mopria Print Service .....	47
<b>Wi-Fi or Wired Networking.....</b>	<b>49</b>
Network Security Recommendations .....	49
Wi-Fi Infrastructure Mode Setup.....	50
Selecting Wireless Network Settings from the Control Panel .....	51
Wi-Fi Direct Mode Setup .....	53
Enabling Wi-Fi Direct Mode (Simple AP) .....	54
Modifying the Wi-Fi Direct Network Name or Password .....	55
Wi-Fi Protected Setup (WPS).....	58
Using WPS to Connect to a Network .....	58
Printing a Network Status Sheet.....	59
Printing a Network Connection Report .....	60
Network Connection Report Codes and Messages .....	62
Configuring Email Server Settings.....	67
Changing or Updating Network Connections .....	69
Accessing the Web Config Utility .....	69
Changing a USB Connection to a Wi-Fi Connection.....	70
Changing a Wi-Fi Connection to a Wired Network Connection.....	70
Connecting to a New Wi-Fi Router .....	70
Disabling Wi-Fi Features .....	71
Disabling Wi-Fi Direct Features .....	72
<b>Enabling PCL or PostScript Printing (ST-C8090).....</b>	<b>74</b>
Installing the PCL Driver - Windows .....	74
Installing the PostScript (PS3) Printer Software - Windows .....	76
Installing the PostScript (PS3) Printer Software - Mac .....	76
Selecting PDL (Page Description Language) Settings .....	77

PDL Print Configuration Options.....	78
Selecting Printer Language and Interface Settings .....	80
Printing Language and Interface Options .....	81
Printing a PCL or PS3 (PostScript) Status Sheet .....	82
<b>Loading Paper .....</b>	<b>84</b>
Loading Paper in the Cassettes .....	84
Paper Loading Capacity .....	87
Double-sided Printing Capacity .....	91
Compatible Epson Papers.....	93
Paper or Media Type Settings - Printing Software.....	94
Selecting the Paper Settings for Each Source - Control Panel .....	95
Paper Type Settings - Control Panel .....	96
Selecting Default Paper Settings - Administrator.....	97
Selecting the Default Printer Settings .....	97
Paper Source Settings Options.....	97
Selecting the Universal Print Settings.....	98
Universal Print Settings Options .....	99
<b>Placing Originals on the Product .....</b>	<b>101</b>
Placing Originals on the Scanner Glass .....	101
Placing Originals in the Automatic Document Feeder .....	102
<b>Copying.....</b>	<b>106</b>
Copying Documents or Photos.....	106
Copying Options.....	107
<b>Printing from a Computer .....</b>	<b>111</b>
Printing with the Standard Epson Printer Software - Windows .....	111
Selecting Basic Print Settings - Windows .....	112
Paper Source Options - Windows .....	115
Print Quality Options - Windows .....	115
Multi-Page Printing Options - Windows.....	115
Selecting Double-sided Printing Settings - Windows .....	116
Double-sided Printing Options - Windows.....	119
Print Density Adjustments - Windows .....	119

Selecting Additional Layout and Print Options - Windows .....	120
Custom Color Correction Options - Windows.....	122
Image Options and Additional Settings - Windows.....	123
Header/Footer Settings - Windows .....	123
Selecting a Printing Preset - Windows.....	125
Selecting Extended Settings - Windows .....	127
Extended Settings - Windows .....	128
Printing Your Document or Photo - Windows.....	129
Locking Printer Settings - Windows .....	130
Locked Setting Options.....	132
Entering a User ID and Password for Printing .....	133
Selecting Default Print Settings - Windows.....	135
Changing the Language of the Printer Software Screens .....	136
Changing Automatic Update Options .....	137
Printing with the Built-in Epson Driver - Windows 10 S.....	138
Selecting Print Settings - Windows 10 S.....	138
Printing with the Epson Standard Printer Software - Mac.....	142
Selecting Basic Print Settings - Mac .....	143
Paper Source Options - Mac.....	146
Print Quality Options - Mac .....	146
Selecting Page Setup Settings - Mac .....	147
Selecting Print Layout Options - Mac.....	148
Selecting Double-sided Printing Settings - Mac.....	148
Double-sided Printing Options and Adjustments - Mac.....	150
Selecting Printing Preferences - Mac .....	150
Printing Preferences - Mac.....	151
Printing Your Document or Photo - Mac .....	152
Checking Print Status - Mac.....	153
Setting Up Printing on a Chromebook .....	154
Printing with the PCL Printer Software - Windows.....	154
Synchronizing Printer Settings - PCL Driver - Windows .....	154
Selecting Basic Print Settings - PCL Driver - Windows.....	155
Selecting Default Print Settings - PCL Driver - Windows .....	157

Locking Printer Settings - PCL Driver - Windows.....	158
PCL Driver Locked Setting Options .....	160
Printing with the PostScript (PS3) Printer Software - Windows .....	161
Selecting Basic Print Settings - PostScript Printer Software - Windows .....	161
Selecting Default Print Settings - PostScript Printer Software - Windows.....	164
Printing with the PostScript (PS3) Printer Software - Mac .....	165
Selecting Basic Print Settings - PostScript Printer Software - Mac .....	166
Cancelling Printing Using a Product Button.....	170
<b>Scanning .....</b>	<b>171</b>
Starting a Scan.....	171
Starting a Scan Using the Product Control Panel .....	171
Scanning to Email .....	173
Scanning to a Connected Computer .....	175
Scanning to a Memory Device .....	176
Scanning to the Cloud.....	178
Control Panel Scanning Options .....	180
Setting Up and Scanning to a Network Folder or FTP Server .....	182
Creating a Shared Network Folder.....	182
Registering Contacts for Network Folder or FTP Scanning - Web Config .....	184
Registering Contacts for Email, Network, or FTP Scanning - Control Panel .....	185
Scanning to a Network Folder or FTP Server.....	186
Starting a Scan Using the Epson Scan 2 Icon .....	189
Starting a Scan from a Scanning Program.....	191
Starting a Scan from a Smartphone or Tablet.....	193
Entering a User ID and Password for Scanning.....	193
Scanning a Document in Epson ScanSmart.....	194
Saving a Scan .....	197
Attaching a Scan to Email.....	198
Sending a Scan to a Cloud Service .....	199
Printing a Scan .....	201
Selecting Epson ScanSmart Settings.....	202
Changing the Epson Product.....	202
Changing the Scan Settings .....	203

Changing the File Name Settings .....	206
Changing the Save Settings .....	207
Save Settings.....	209
Customizing Action Icons .....	211
Scanning in Epson Scan 2 .....	212
Available Document Source Settings .....	215
Additional Scanning Settings - Main Settings Tab .....	215
Additional Scanning Settings - Advanced Settings Tab .....	216
Saving Scanned Documents as a Searchable PDF Using Epson Scan 2 .....	217
Image Format Options .....	219
Scan Resolution Guidelines .....	219
<b>Faxing.....</b>	<b>221</b>
Connecting a Telephone or Answering Machine .....	221
Setting Up Fax Features .....	224
Setting Up Basic Fax Features .....	224
Using the Fax Setup Wizard .....	224
Selecting the Line Type.....	226
Setting the Number of Rings to Answer .....	227
Selecting Advanced Fax Settings .....	228
Basic Settings - Fax .....	229
Send Settings - Fax.....	230
Receive Settings - Fax .....	231
Report Settings - Fax .....	233
Security Settings - Fax .....	234
Setting Up the Fax Utility - Windows.....	235
Setting Up Fax Features Using the Fax Utility - Mac .....	237
Setting Up Contacts and Contact Groups.....	238
Creating a Contact.....	239
Editing or Deleting a Contact .....	241
Creating a Contact Group.....	242
Editing or Deleting a Contact Group .....	244
Sending Faxes .....	246
Sending Faxes from the Product Control Panel.....	246



Sending a Fax Using the Keypad, Contact List, or History .....	246
Fax Sending Options .....	249
Sending a Fax at a Specified Time .....	251
Sending a Fax on Demand .....	252
Sending a Stored Fax .....	254
Dialing Fax Numbers from a Connected Telephone .....	255
Sending Faxes Using the Fax Utility - Windows .....	256
Sending Faxes Using the Fax Utility - Mac .....	258
Receiving Faxes.....	261
Fax Reception .....	261
Receiving Faxes Automatically .....	262
Receiving Faxes Manually.....	262
Forwarding Received Faxes.....	263
Receiving a Fax by Polling .....	264
Viewing a Fax on the LCD Screen (Using the Fax Box).....	265
Checking Fax Status .....	266
Printing Fax Reports.....	267
Fax Report Options .....	268
<b>Using External USB Devices with Your Product.....</b>	<b>270</b>
Connecting a USB Device .....	270
USB Device Photo File Specifications .....	270
Disconnecting a USB Device.....	271
<b>Refilling Ink and Replacing the Maintenance Box .....</b>	<b>272</b>
Ink Safety Precautions .....	272
Checking the Ink and Maintenance Box Levels.....	274
Checking the Ink Levels on Your Product.....	274
Checking Maintenance Box Status on the LCD Screen.....	275
Checking Ink and Maintenance Box Levels - Windows .....	275
Checking Ink and Maintenance Box Levels - Mac .....	277
Disabling Special Offers with Windows .....	278
Purchase Epson Ink and Maintenance Box.....	279
Ink Bottle and Maintenance Box Part Numbers .....	280
Refilling the Ink Tanks .....	280

Maintenance Box Replacement .....	284
<b>Adjusting Print Quality.....</b>	<b>286</b>
Print Head Maintenance.....	286
Print Head Nozzle Check.....	286
Checking the Nozzles Using the Product Control Panel .....	286
Checking the Nozzles Using a Computer Utility .....	288
Print Head Cleaning .....	290
Cleaning the Print Head Using the Product Control Panel .....	291
Cleaning the Print Head Using a Computer Utility.....	292
Print Quality Adjustment.....	294
Adjusting the Print Quality Using the Product Control Panel.....	295
Power Cleaning.....	296
Power Cleaning Using a Computer Utility.....	297
Power Cleaning Using the Product Control Panel .....	298
Cleaning the Paper Guide .....	299
<b>Cleaning and Transporting Your Product .....</b>	<b>301</b>
Cleaning Your Product .....	301
Transporting Your Product .....	304
<b>Solving Problems .....</b>	<b>310</b>
Checking for Software Updates.....	310
Product Status Messages .....	311
Running a Product Check .....	313
Resetting Control Panel Defaults .....	315
Solving Setup Problems .....	316
Product Does Not Turn On or Off.....	316
Noise After Filling the Ink.....	316
Software Installation Problems .....	317
Solving Network Problems .....	317
Product Cannot Connect to a Wireless Router or Access Point .....	318
Network Software Cannot Find Product on a Network.....	319
Product Does Not Appear in Mac Printer Window .....	320
Wireless Network Connection is Unstable on a Mac .....	320
Cannot Print Over a Network.....	321

Cannot Scan Over a Network .....	322
Solving Copying Problems .....	322
Product Makes Noise, But Nothing Copies .....	323
Product Makes Noise When It Sits for a While.....	323
Originals Do Not Feed From the Automatic Document Feeder.....	323
Solving Paper Problems .....	324
Paper Feeding Problems .....	325
Paper Jams Inside the Product.....	326
Paper Ejection Problems .....	326
Solving Problems Printing from a Computer.....	326
Nothing Prints .....	327
Product Icon Does Not Appear in Windows Taskbar .....	328
Printing is Slow .....	329
Solving Page Layout and Content Problems .....	330
Inverted Image.....	331
Too Many Copies Print .....	331
Blank Pages Print .....	331
Incorrect Margins on Printout.....	332
Incorrect Characters Print.....	332
Incorrect Image Size or Position .....	333
Slanted Printout .....	334
Solving Print Quality Problems .....	334
White or Dark Lines in Printout .....	335
Blurry or Smearred Printout .....	336
Faint Printout or Printout Has Gaps .....	337
Grainy Printout.....	338
Incorrect Colors .....	339
Solving Scanning Problems .....	340
Scanning Software Does Not Operate Correctly .....	341
Cannot Start Epson Scan 2 .....	341
Scanning is Slow .....	342
Cannot Save a Scan to a Shared Folder Over a Network.....	343
Solving Scanned Image Quality Problems .....	344

Image Consists of a Few Dots Only .....	345
Line of Dots Appears in All Scanned Images .....	345
Straight Lines in an Image Appear Crooked .....	345
Scanned Image Quality Problems .....	346
Image Colors are Patchy at the Edges .....	347
Ripple Patterns Appear in an Image .....	347
Scanned Image Edges are Cropped .....	347
Solving Faxing Problems.....	348
Cannot Send or Receive Faxes.....	348
Cannot Receive Faxes with a Telephone Connected to Your Product .....	350
Fax Memory Full Error Appears.....	351
Sent Fax is Received in an Incorrect Size .....	351
Received Fax is Not Printed .....	352
Solving USB Device Problems .....	352
Cannot View or Print from a USB Device.....	352
Cannot Save Files on a USB Device .....	353
Cannot Transfer Files To or From a USB Device.....	353
Uninstall Your Product Software.....	353
Uninstalling Product Software - Windows .....	354
Uninstalling Product Software - Mac.....	355
Where to Get Help.....	356
<b>Technical Specifications .....</b>	<b>357</b>
Windows System Requirements .....	357
Mac System Requirements .....	358
Paper Specifications .....	359
Printable Area Specifications .....	360
Automatic Document Feeder (ADF) Specifications .....	361
Scanning Specifications .....	362
Fax Specifications .....	362
Ink Specifications .....	363
Dimension Specifications .....	364
Electrical Specifications .....	364
Environmental Specifications .....	365

Interface Specifications .....	365
External USB Device Specifications .....	366
Network Interface Specifications .....	367
Safety and Approvals Specifications .....	369
<b>Notices .....</b>	<b>371</b>
Important Safety Instructions.....	371
General Product Safety Instructions .....	371
Wireless Connection Safety Instructions .....	373
LCD Screen Safety Instructions.....	373
Telephone Equipment Safety Instructions .....	374
FCC Compliance Statement.....	374
Binding Arbitration and Class Waiver .....	377
Trademarks .....	380
Copyright Notice.....	381
libTIFF Software Acknowledgment.....	381
A Note Concerning Responsible Use of Copyrighted Materials.....	382
Default Delay Times for Power Management for Epson Products .....	382
Copyright Attribution .....	382



---

# **ST-C8000/ST-C8090 User's Guide**

Welcome to the ST-C8000/ST-C8090 *User's Guide*.

For a printable PDF copy of this guide, [click here](#).

---

## Product Basics

See these sections to learn about the basic features of your product.

[Using the Control Panel](#)

[Product Parts Locations](#)

[Using Power Saving Settings](#)

[Epson Connect Solutions for Smartphones, Tablets, and More](#)

[Using AirPrint](#)

[Android Printing Using the Epson Print Enabler](#)

[Using Fire OS Printing](#)

[Using Windows 10 Mobile Printing](#)

[Using Epson Print and Scan App with Windows Tablets](#)

[Using the Mopria Print Service](#)

## Using the Control Panel

See these sections to learn about the control panel and select control panel settings.

[Control Panel Buttons and Lights](#)

[Selecting the Date and Time](#)

[Selecting Your Country or Region](#)

[Setting a Password and Locking the Control Panel](#)

[Setting User Feature Restrictions \(Access Control\)](#)

[Changing LCD Screen Language](#)

[Adjusting Control Panel Sounds](#)

[Adjusting the Screen Brightness](#)

[Turning Off the Operation Time Out Setting](#)

[Preventing PC Connection via USB](#)

**Parent topic:** [Product Basics](#)



## Control Panel Buttons and Lights

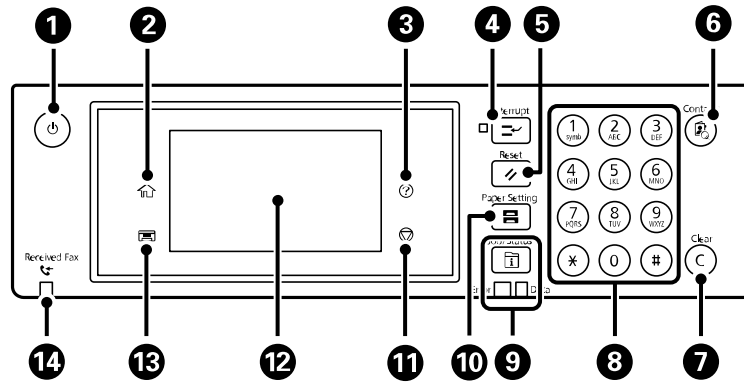

- 1 The power button and power light
- 2 The home button
- 3 The help button
- 4 The **Interrupt** button
- 5 The **Reset** button
- 6 The **Contacts** button
- 7 The **C Clear** button
- 8 The numeric keypad
- 9 The **Job/Status** button, the **Error** light, and the **Data** light
- 10 The **Paper Setting** button
- 11 The stop button
- 12 The LCD screen
- 13 The output tray button
- 14 The **Received Fax** light

[The LCD Screen](#)

[Status Icon Information](#)

## Entering Characters on the LCD Screen

### Job/Status Screen

### Viewing Animations

### Parent topic: Using the Control Panel

## The LCD Screen

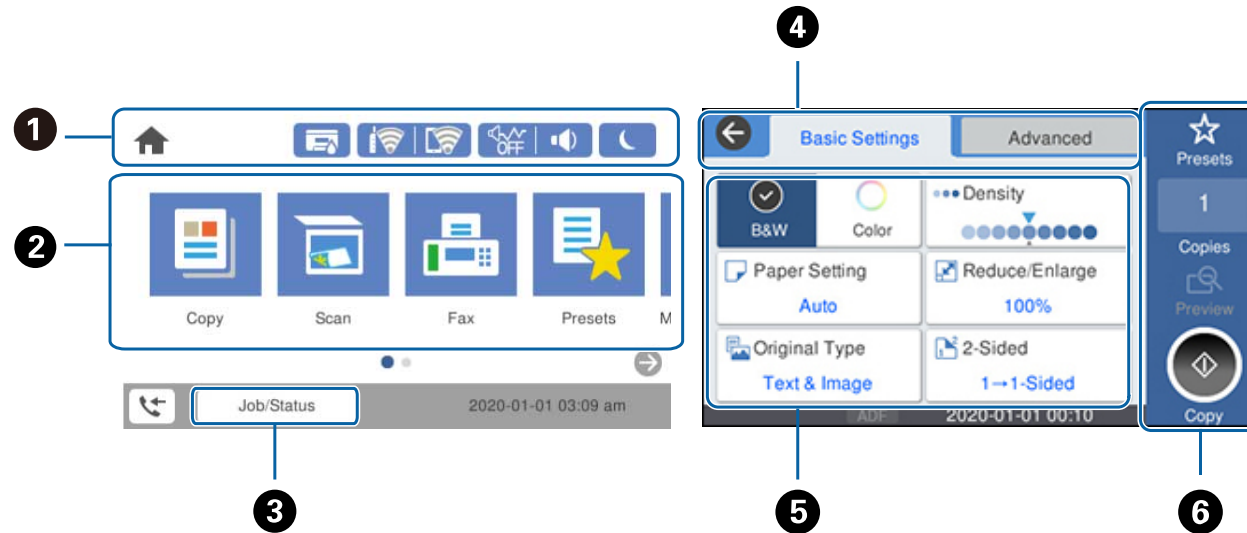









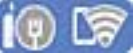



- 1 Displays various status information; select an icon to check its status or adjust its settings
- 2 Menu options
- 3 Select to display the **Job/Status** menu
- 4 Select a tab to view different options and settings
- 5 Setting options
- 6 Displays available buttons

### Parent topic: Control Panel Buttons and Lights

## Status Icon Information

Your product displays status icons on the LCD screen for certain product status conditions.

Icons	Description
	Displays the maintenance box status screen.
	<p>Displays the network connection status; select the icon to set up or change your network connection.</p> <ul style="list-style-type: none"> <li> The product is not connected to a wired (Ethernet) network.</li> <li> The product is connected to a wired (Ethernet) network.</li> <li> The product is not connected to a wireless network.</li> <li> The product is searching for an SSID or experiencing a wireless network connection issue.</li> <li> The product is connected to a wireless network; the number of bars indicates the connection's signal strength.</li> <li> Wi-Fi Direct is not enabled.</li> <li> Wi-Fi Direct is enabled.</li> </ul>
	The <b>Quiet Mode</b> setting is enabled or disabled. Select the icon to change the setting. Depending on the selected paper type and print quality, when this feature is enabled noise is reduced during printing, but print speed may also be reduced.
	Displays the <b>Fax Data Information</b> screen.
	Displays additional information or instructions, such as loading paper or placing a document on the scanner; select the icon to display the information.
	There is a problem with the indicated setting; select the icon for information on resolving the problem.

Parent topic: [Control Panel Buttons and Lights](#)

### Entering Characters on the LCD Screen

Follow these guidelines to enter characters for passwords and other settings.

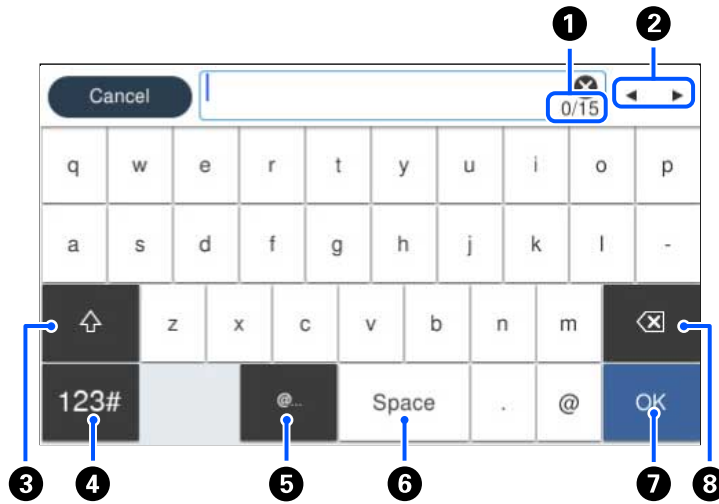

- 1 Displays the character count
- 2 Moves the cursor left or right
- 3 Switches between uppercase and lowercase characters, numbers and symbols
- 4 Switches between characters and numbers or symbols
- 5 Displays a list of common domain names to choose from
- 6 Enters a space
- 7 Select when you are finished
- 8 Deletes the previous character

**Parent topic:** [Control Panel Buttons and Lights](#)

## Job/Status Screen

You can press the  **Job/Status** button to view the status of your product or print jobs.

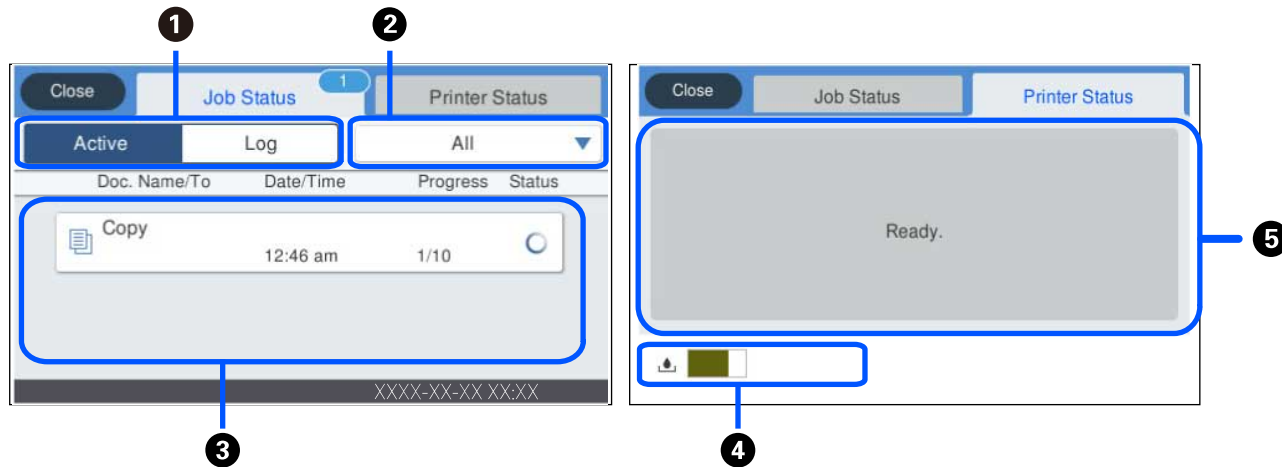

- 1 Select to view active jobs or the job history
- 2 Select a job filter
- 3 Displays a list of ongoing jobs or the job history
- 4 Displays approximate maintenance box level
- 5 Displays any errors; select the error for details

**Parent topic:** [Control Panel Buttons and Lights](#)

## Viewing Animations

You can view animations on the LCD screen to help guide you with a procedure or to troubleshoot a problem.

1. Select the  help icon.
2. Select **Troubleshooting** if you are experiencing a problem or **How To** to view instructions on common procedures.
3. Select a topic from the list of available topics and follow the on-screen instructions.

**Parent topic:** [Control Panel Buttons and Lights](#)

## Selecting the Date and Time

Before using your product, select the current date, time, and daylight saving phase in your area, and choose your preferred date and time format.

**Note:** This setting can be locked by an administrator. If you cannot access or change this setting, contact your administrator for assistance.

1. Press the  home button, if necessary.
2. Select **Settings** > **General Settings** > **Basic Settings** > **Date/Time Settings**.

You see a screen like this:

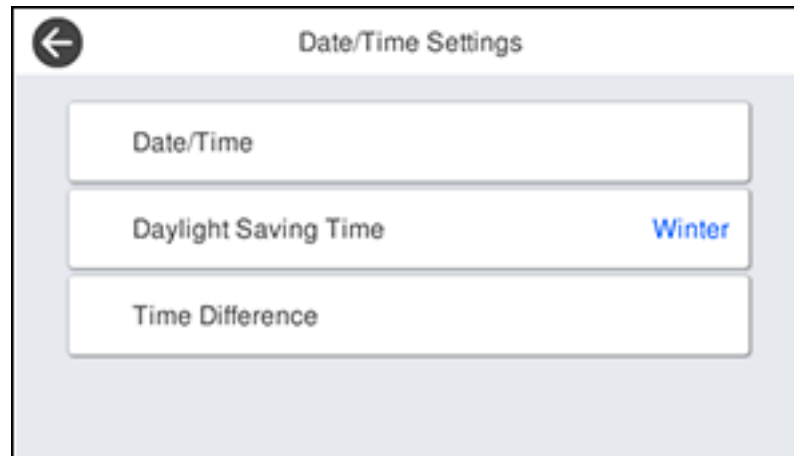

3. Select **Daylight Saving Time**.
4. Select the setting that applies to your area:
  - **Winter:** it is winter or your region does not use Daylight Saving Time (DST)
  - **Summer:** it is spring or summer and your region uses Daylight Saving Time (DST)

**Note:** If your region uses Daylight Saving Time (DST), you must change this setting to match the season. When you change from **Winter** to **Summer**, your product automatically sets its clock ahead one hour. When you change from **Summer** to **Winter**, it sets its clock back one hour.

5. Select **Date/Time**.

6. Select the date format you want to use.
7. Use the numeric keypad to enter the current date.
8. Select the time format you want to use.
9. Use the numeric keypad to enter the current time.

**Parent topic:** [Using the Control Panel](#)

## Selecting Your Country or Region

Before using your product, select the country or region in which you are using your product.

**Note:** If you change the country or region, your fax settings return to their defaults and you must select them again. This setting can be locked by an administrator. If you cannot access or change this setting, contact your administrator for assistance.

1. Press the  home button, if necessary.
2. Select **Settings** > **General Settings** > **Basic Settings** > **Country/Region**.

You see a screen like this:

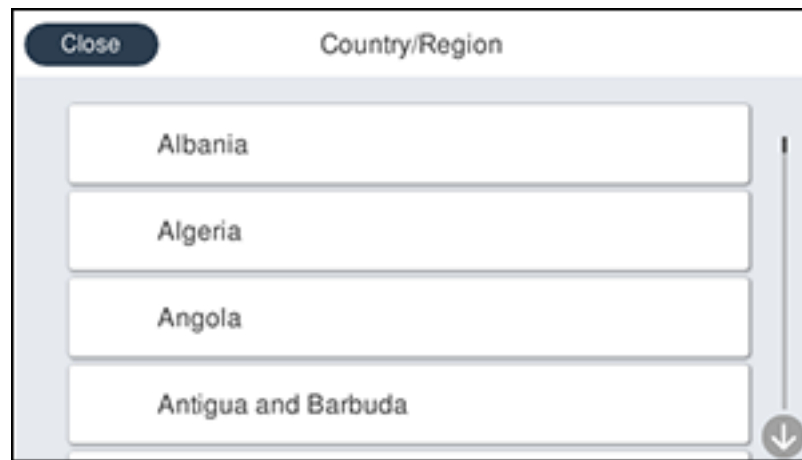

3. Scroll up or down, if necessary, and select your country or region.  
You see a confirmation screen.
4. If the setting is correct, select **Yes**. (If not, select **No** and retry.)

Parent topic: [Using the Control Panel](#)

## Setting a Password and Locking the Control Panel

You can set an administrator password to lock the following settings and prevent them from being changed:

- Network settings
- Web Service settings
- Scan settings
- System Administration settings
- Fax settings
- Web Config settings
- EpsonNet Config settings

**Note:** For more information on administration settings, see the [Administrator's Guide](#).

1. Press the  home button, if necessary.
2. Select **Settings** > **General Settings** > **System Administration** > **Security Settings** > **Admin Settings** > **Admin Password** > **Register**.

You see a screen like this:





3. Use the displayed keyboard to enter a password and select **OK**.
4. Enter your password again to confirm.

**Note:** Keep a copy of your password in a safe place.

5. Select **OK**.
6. Turn **Lock Setting** on.

When the control panel is locked, you must enter the password to access any of the locked settings.

**Note:** If you forget your password, contact Epson for assistance.

### [Using Presets](#)

**Parent topic:** [Using the Control Panel](#)

#### **Related tasks**

[Setting User Feature Restrictions \(Access Control\)](#)

### **Using Presets**

You can save frequently used copy, fax, and scan settings as presets. This lets you easily reuse them whenever necessary.

**Note:** Presets can be locked by an administrator. If you cannot access or change presets, contact your administrator for assistance.

1. Press the  home button, if necessary.
2. Select **Presets**.

You see a screen like this:

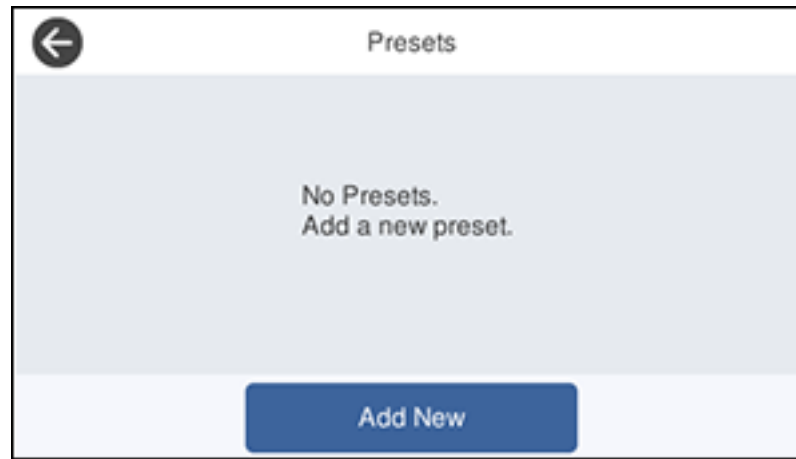

3. Select **Add New**. Enter the Administrator password, if necessary.

**Note:** You can save up to 50 presets.

4. Select the function for which you want to set up a preset.

You see the main screen for that function, such as the Copy screen:

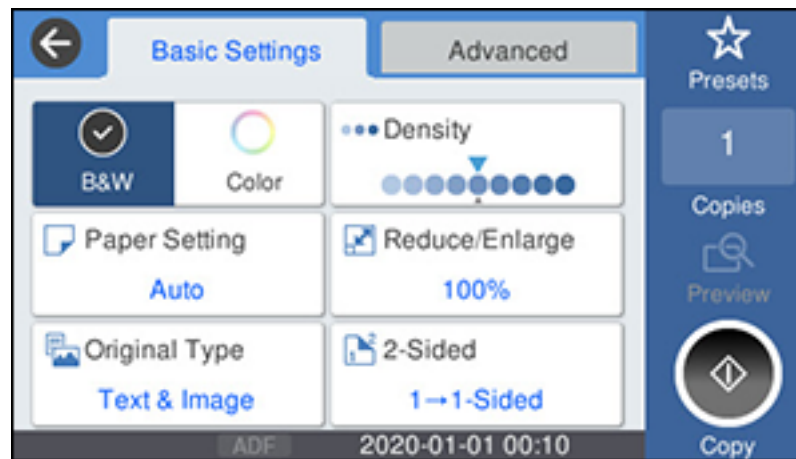

5. Select the settings you want to save and select **Register**.  
You see a screen like this:

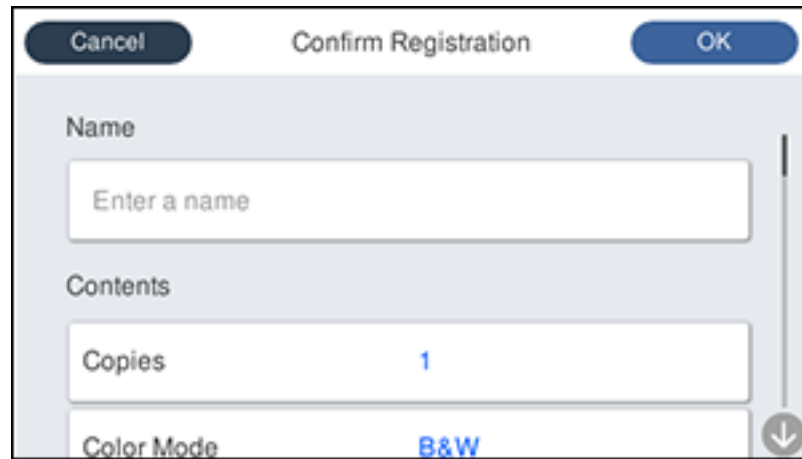

A screenshot of a mobile application dialog box titled "Confirm Registration". At the top, there are three buttons: "Cancel" on the left, "Confirm Registration" in the center, and "OK" on the right. Below the title bar, there are three input fields. The first field is labeled "Name" and contains the placeholder text "Enter a name". The second field is labeled "Contents" and contains "Copies" with the value "1". The third field is labeled "Color Mode" and contains the value "B&W". A vertical scrollbar is visible on the right side of the dialog box.

6. Select **Name**.  
You see a screen like this:

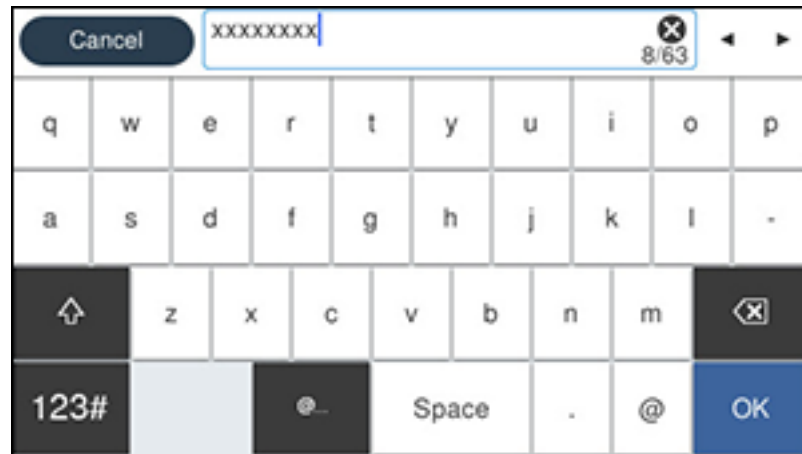

A screenshot of a text input field with a virtual keyboard displayed below it. The input field contains the text "xxxxxxxx" and has a character count of "8/63". The keyboard is a standard QWERTY layout with a blue "OK" button on the bottom right. The top row of the keyboard contains the letters q, w, e, r, t, y, u, i, o, p. The second row contains a, s, d, f, g, h, j, k, l, -. The third row contains an arrow key, z, x, c, v, b, n, m, and a backspace key. The bottom row contains "123#", a function key, "Space", ".", "@", and "OK".

7. Use the displayed keyboard to enter a name for the preset and select **OK**.

8. Select **OK**.

When you copy, fax, or scan, you can use the preset by selecting **Presets** and selecting your preset name from the list.

**Parent topic:** [Setting a Password and Locking the Control Panel](#)

**Related tasks**

[Entering Characters on the LCD Screen](#)

## Setting User Feature Restrictions (Access Control)

Using Web Config Access Control Settings, you can restrict product features for individual users to prevent misuse of the product. Restricted features require the user to enter an ID and password on the product control panel.

After you setup feature restrictions, you must enable them using the product control panel.

**Note:** For more information on administration settings, see the [Administrator's Guide](#).

1. Press the  home button, if necessary.
2. Select **Settings > General Settings**.

You see a screen like this:



3. Scroll down and select **System Administration > Security Settings > Access Control**.

4. Select **On**.
5. Enable **Accept Unknown User Jobs** to allow users to print from generic drivers or use the WSD scanning function.

**Parent topic:** [Using the Control Panel](#)

**Related tasks**

[Setting a Password and Locking the Control Panel](#)

[Entering a User ID and Password for Scanning](#)

[Entering a User ID and Password for Printing](#)

## Changing LCD Screen Language

You can change the language used on the LCD screen.

**Note:** This setting can be locked by an administrator. If you cannot access or change this setting, contact your administrator for assistance.

1. Press the  home button, if necessary.
2. Select **Settings** > **General Settings**.

You see a screen like this:



3. Select **Basic Settings**.

4. Scroll down and select **Language**.
5. Select a language.

**Parent topic:** [Using the Control Panel](#)

## Adjusting Control Panel Sounds

You can adjust the sound level heard when you press buttons on the control panel.

**Note:** This setting can be locked by an administrator. If you cannot access or change this setting, contact your administrator for assistance.

1. Press the  home button, if necessary.
2. Select **Settings > General Settings > Basic Settings > Sound**.

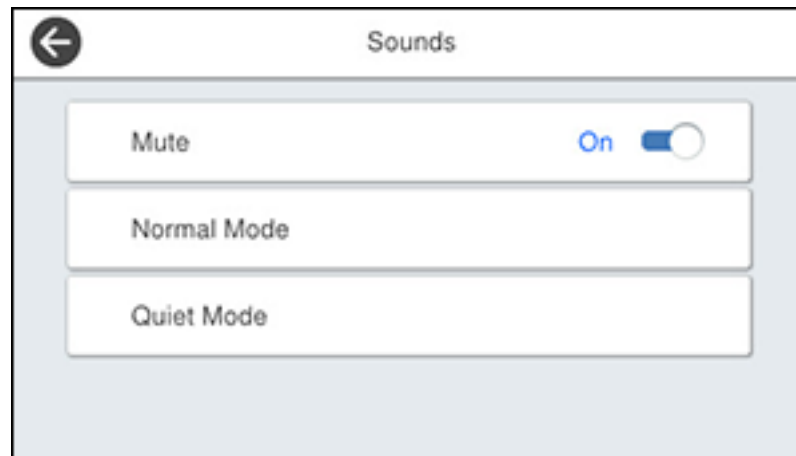

You see a screen like this:



3. Do one of the following:
  - To mute all control panel sounds, turn the **Mute** setting on.

- To select a specific sound level, select **Normal Mode** or **Quiet Mode**.

**Note:** Press the  icon on the home screen to switch between Normal Mode and Quiet Mode.

4. If you did not mute the sounds, select **Button Press** to adjust the volume level.
5. Press  to decrease or  to increase the sound.
6. Select **OK** to exit.

**Note:** You can also adjust the **Sound Type** and the sound level for various product functions.

**Parent topic:** [Using the Control Panel](#)

## Adjusting the Screen Brightness

You can adjust the brightness of the LCD screen.

1. Press the  home button, if necessary.
2. Select **Settings** > **General Settings**.

You see a screen like this:



3. Select **Basic Settings** > **LCD Brightness**.

4. Press the – or + icons to decrease or increase the brightness.
5. Select **OK** to exit.

**Parent topic:** [Using the Control Panel](#)

## Turning Off the Operation Time Out Setting

The Operation Time Out setting causes the LCD screen to return to the Home screen after a few minutes of inactivity. This feature is enabled by default, but you can turn it off.

**Note:** This setting can be locked by an administrator. If you cannot access or change this setting, contact your administrator for assistance.

1. Press the  home button, if necessary.
2. Select **Settings** > **General Settings**.

You see a screen like this:



3. Select **Basic Settings**.
4. Scroll down and set **Operation Time Out** to **Off**.

**Parent topic:** [Using the Control Panel](#)



## Preventing PC Connection via USB

You can disable access from a USB-connected computer. This restricts non-network access to the product and protects the security of confidential scanned documents.

1. Press the  home button, if necessary.
2. Select **Settings** > **General Settings** > **Printer Settings** > **PC Connection via USB**.

You see a screen like this:



3. Select **Disable**.

**Parent topic:** [Using the Control Panel](#)

## Product Parts Locations

See these sections to identify the parts on your product.

[Product Parts - Front](#)

[Product Parts - Inside](#)

[Product Parts - Back](#)

**Parent topic:** [Product Basics](#)

## Product Parts - Front

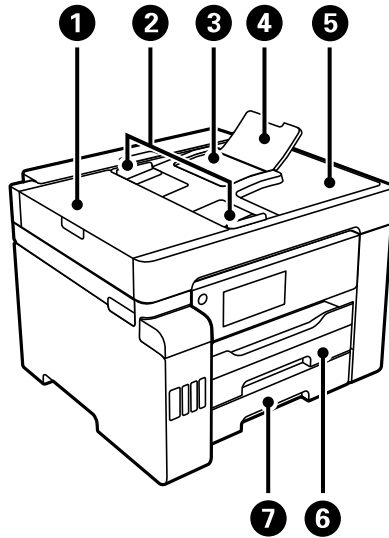

- 1 Automatic Document Feeder (ADF) cover
- 2 ADF edge guides
- 3 ADF input tray
- 4 ADF input support
- 5 ADF output tray
- 6 Paper cassette 1
- 7 Paper cassette 2

7 Paper cassette 2

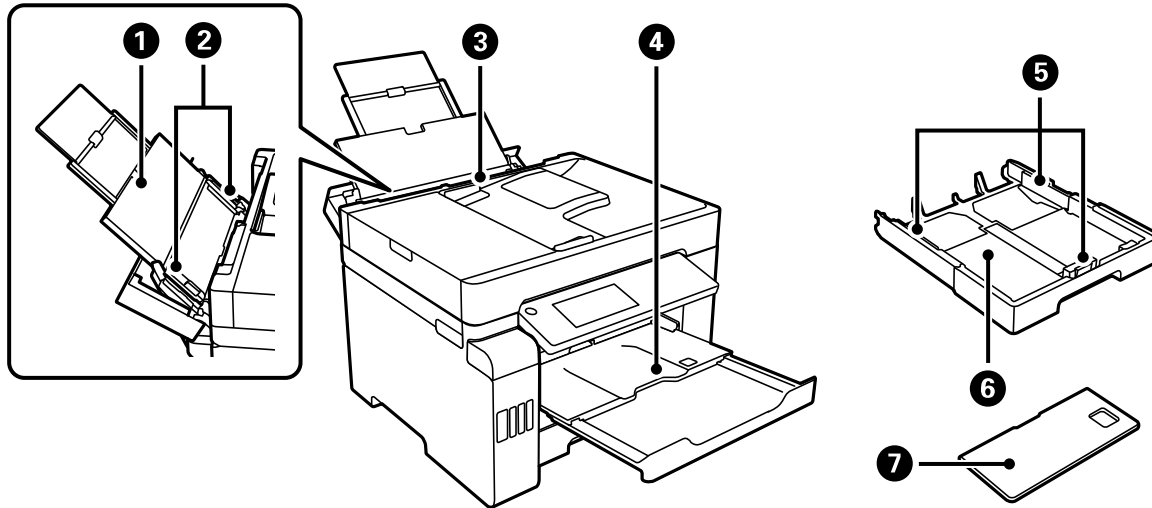

- 1 Paper support and extension
- 2 Rear paper feed edge guides
- 3 Rear paper feed slot (paper tray)
- 4 Output tray
- 5 Paper cassette edge guides
- 6 Paper cassette
- 7 Paper cassette cover

Parent topic: [Product Parts Locations](#)

## Product Parts - Inside

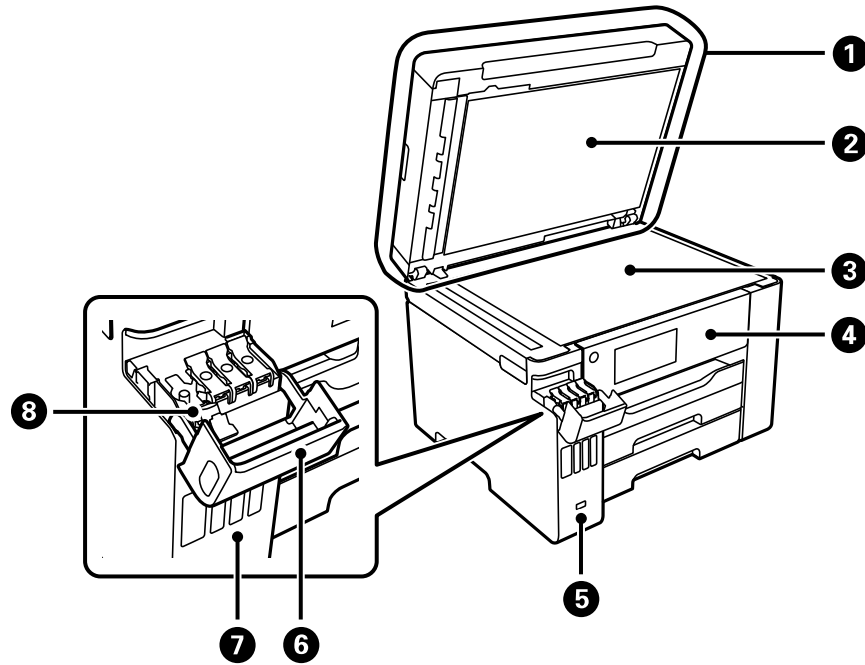

- 1 Document cover
- 2 Document mat
- 3 Scanner glass
- 4 Control panel
- 5 USB Type A port for external devices
- 6 Ink tank cover
- 7 Ink tanks

8 Ink tank cap

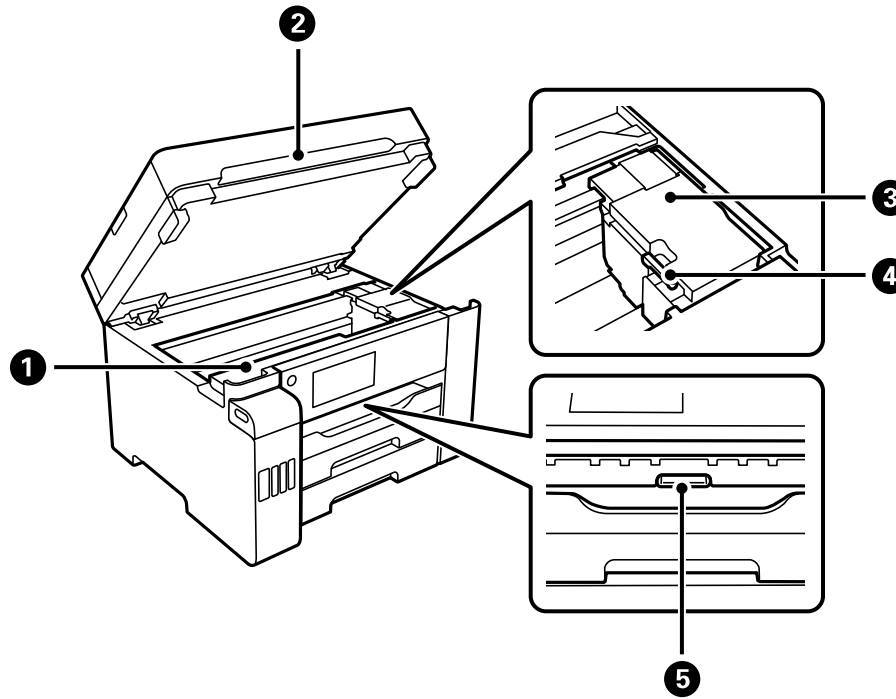

- 1 Maintenance box cover
- 2 Scanner unit
- 3 Print head
- 4 Transportation lock
- 5 Inner cover

Parent topic: [Product Parts Locations](#)

## Product Parts - Back

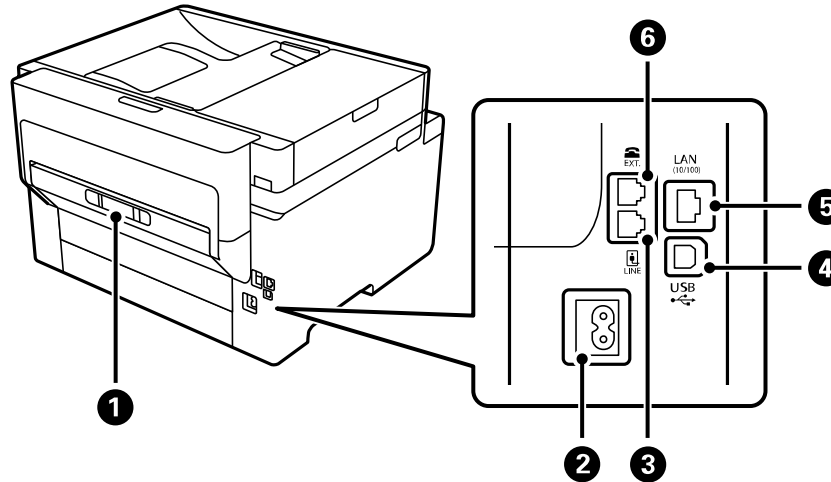

- 1 Rear cover
- 2 AC inlet
- 3 **Line** port
- 4 **USB** port
- 5 **LAN** port
- 6 **EXT.** port

Parent topic: [Product Parts Locations](#)

## Using Power Saving Settings

Your product enters sleep mode automatically and turns off the LCD screen if it is not used for a period of time. You can make the time period shorter and select other options to save energy and resources.

[Changing the Sleep Timer Settings](#)

[Changing the Power Off Timer Settings](#)

Parent topic: [Product Basics](#)

## Changing the Sleep Timer Settings

You can adjust the time period before your product enters sleep mode and turns off the LCD screen.

**Note:** This setting can be locked by an administrator. If you cannot access this setting, contact your administrator for assistance.

1. Press the  home button, if necessary.
2. Select **Settings** > **General Settings** > **Basic Settings** > **Sleep Timer**.

You see a screen like this:

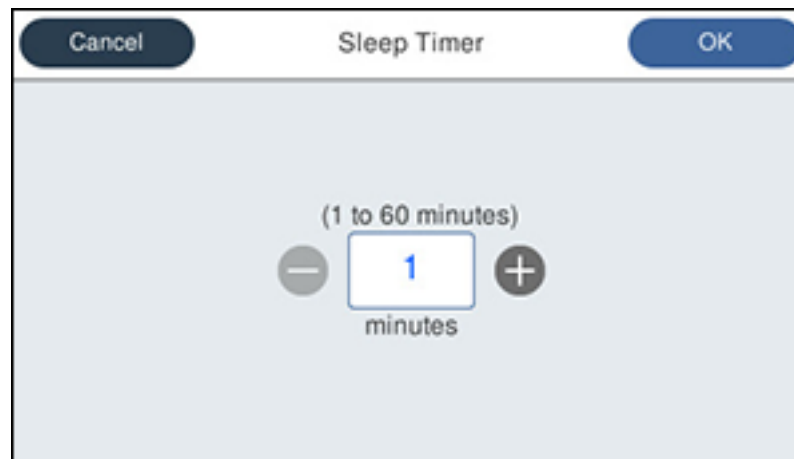

3. Do one of the following:
  - Select the **-** or **+** icon to decrease or increase the number of minutes.
  - Select the number of minutes on the LCD screen, select the number of minutes from the on-screen keypad, and select **OK**.
4. Select **OK**.

Parent topic: [Using Power Saving Settings](#)

## Changing the Power Off Timer Settings

You can have the product turn off automatically if it is not used for a specified period of time.

**Note:** This setting can be locked by an administrator. If you cannot access this setting, contact your administrator for assistance.

1. Press the  home button, if necessary.
2. Select **Settings** > **General Settings** > **Basic Settings** > **Power Off Timer**.

You see a screen like this:



3. Select a time period between **30minutes** and **12h** (12 hours).

**Parent topic:** [Using Power Saving Settings](#)

## Epson Connect Solutions for Smartphones, Tablets, and More

Use your smartphone, tablet, or computer to print and scan documents, photos, emails, and web pages from your home, office, or even across the globe.

**Note:** If you are using your Epson product with the Windows 10 S operating system, you cannot use the software described in this section. You also cannot download and install any Epson product software from the Epson website for use with Windows 10 S; you must obtain software only from the Windows Store.

Print from anywhere with these Epson Connect solutions:

- Epson Email Print



- Epson iPrint Mobile App
- Epson Remote Print

Scan and send a file as an email or upload it to an online service directly from your Epson product with Epson Scan to Cloud or the Epson iPrint Mobile App.

[Setting Up Epson Connect Services](#)

[Using Epson Email Print](#)

[Using the Epson iPrint Mobile App](#)

[Using Epson Remote Print](#)

[Using Epson Scan to Cloud](#)

**Parent topic:** [Product Basics](#)

## Setting Up Epson Connect Services

If you did not activate your product's email address for use with Epson Connect when you set up your product, you can activate it using the product control panel.

1. Press the  home button, if necessary.
2. Select **Settings** > **General Settings**.

You see a screen like this:

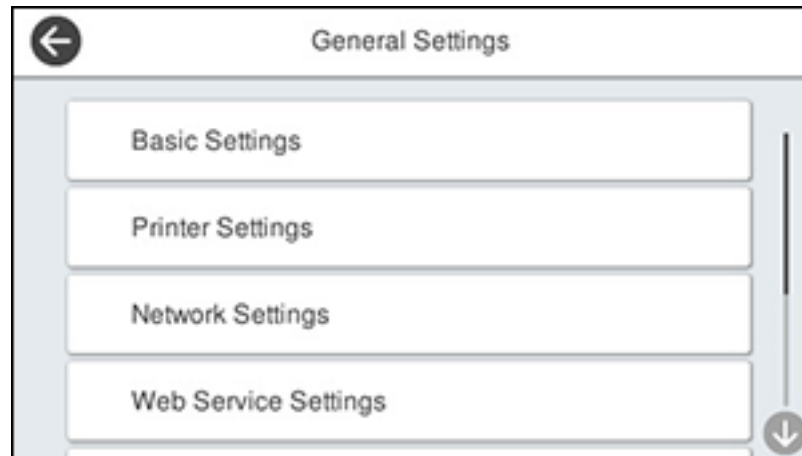

3. Select **Web Service Settings** > **Epson Connect Services**.

You see a screen like this:

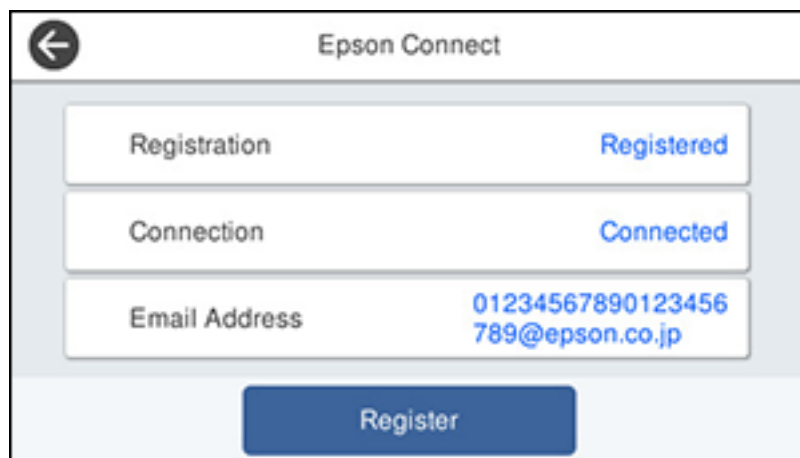

4. Select **Register**.
5. Follow the instructions on the screen to activate your product's email address.

**Parent topic:** [Epson Connect Solutions for Smartphones, Tablets, and More](#)

## Using Epson Email Print

With Epson Email Print, you can print from any device that can send email, such as your smartphone, tablet, or laptop. Just activate your product's unique email address. When you want to print, attach a PDF, Microsoft Office document, or photo to an email and send it to your product. Both the email and the attachments will print automatically.

1. Connect your product to your network. See the link below.
2. If you did not already set up Email Print when you installed your product software, see the link below to use your product control panel to activate your unique email address. Or visit [epson.com/connect](http://epson.com/connect) (U.S), [epson.ca/connect](http://epson.ca/connect) (Canada), or [latin.epson.com/connect](http://latin.epson.com/connect) (Caribbean) to learn more about Email Print, create your Epson Connect account, and register your product to the Epson Connect service.
3. Now you are ready to send and print emails to your product's Email Print address.

**Note:** Go to [epsonconnect.com](http://epsonconnect.com) and log into your Epson Connect account to personalize your product's email, adjust print settings, and set up other Epson Connect services.

**Parent topic:** [Epson Connect Solutions for Smartphones, Tablets, and More](#)

**Related tasks**

[Setting Up Epson Connect Services](#)

**Related topics**

[Wi-Fi or Wired Networking](#)

## Using the Epson iPrint Mobile App

Use this free Apple and Android app to print and scan with networked Epson products. Epson iPrint lets you print PDFs, Microsoft Office documents, photos, and web pages over a wireless network. You can scan and save a file on your device, send it as an email, or upload it to an online service such as Box, Dropbox, Evernote, or Google Drive.

1. Connect your product to your wireless network. See the link below.
2. Visit [epson.com/connect](http://epson.com/connect) (U.S), [epson.ca/connect](http://epson.ca/connect) (Canada), or [latin.epson.com/connect](http://latin.epson.com/connect) (Caribbean) to learn more about Epson iPrint and check the compatibility of your mobile device.
3. Download Epson iPrint from the Apple App Store or Google Play.
4. Connect your mobile device to the same wireless network as your product.
5. Open Epson iPrint and select your Epson product.

Now you are ready to print or scan with your mobile device and your Epson product.

**Parent topic:** [Epson Connect Solutions for Smartphones, Tablets, and More](#)

**Related topics**

[Wi-Fi or Wired Networking](#)

## Using Epson Remote Print

With Epson Remote Print software, you can print from your laptop or desktop computer to an Epson Email-enabled product anywhere in the world.

1. Connect your Epson product to your wireless network. See the link below.
2. If you did not already set up an Epson Connect account when you installed your product software, visit [epsonconnect.com](http://epsonconnect.com) to create your account and register your product to the Epson Connect service.

**Note:** Make a note of your product's email address.

3. Visit [epsonconnect.com](http://epsonconnect.com) to learn more about Remote Print and how to download the Remote Print Driver software.
4. Download and install the Remote Print software.
5. Enter the email address and optional access key of your Epson product during Remote Print setup.
6. Now you are ready to print remotely. Select the print command in your laptop or desktop computer application and choose the Remote Print option for your Epson product.

**Parent topic:** [Epson Connect Solutions for Smartphones, Tablets, and More](#)

**Related topics**

[Wi-Fi or Wired Networking](#)

## Using Epson Scan to Cloud

The Epson Scan to Cloud service allows you to scan and send a file as an email or upload it to an online service directly from your Epson product. Register an email address or online services such as Box, DropBox, or Google Drive with your Epson Connect account.

1. Connect your Epson product to your network. See the link below.
2. If you did not already set up an Epson Connect account when you installed your product software, visit [epsonconnect.com](http://epsonconnect.com) to create your account and register your product to the Epson Connect service.

**Note:** Make a note of your product's email address and password.

3. Visit [epsonconnect.com](http://epsonconnect.com) to sign into your account with the email address and password you selected.
4. Select your product, select **Scan to Cloud**, and select **Destination List**.
5. Click **Add**, then follow the instructions on the screen to create your destination list.
6. Now you are ready to use Scan to Cloud. Select the setting for scanning to Scan to Cloud on your Epson product control panel.

**Parent topic:** [Epson Connect Solutions for Smartphones, Tablets, and More](#)

**Related topics**

[Wi-Fi or Wired Networking](#)

## Using AirPrint

AirPrint enables instant wireless printing from iPhone, iPad, iPod touch, and Mac without the need to install drivers or download software.



1. Load paper in your product.
2. Set up your product for wireless printing. See the link below.
3. Connect your Apple device to the same wireless network that your product is using.
4. Print from your device to your product.

**Note:** For details, see the AirPrint page on the Apple website.

**Parent topic:** [Product Basics](#)

### **Related topics**

[Wi-Fi or Wired Networking](#)

[Selecting Default Paper Settings - Administrator](#)

## Android Printing Using the Epson Print Enabler

You can wirelessly print your documents, emails, photos, and web pages right from your Android phone or tablet (Android v4.4 or later). With a few taps, your Android device will discover your nearby Epson product and print.

1. Connect your Epson product to your wireless network. See the link below.
2. On your Android device, download the Epson Print Enabler plug-in from Google Play.
3. Go to **Settings** on your Android device, select **Printing**, and enable the Epson plug-in, if necessary.
4. Connect your Android device to the same wireless network as your product.
5. Now you are ready to print. From an Android application such as Chrome or Gmail, tap the menu icon and print whatever is on the screen.

**Note:** If you do not see your product, tap **All Printers** and select your product.

**Parent topic:** [Product Basics](#)

**Related topics**

[Wi-Fi or Wired Networking](#)

## Using Fire OS Printing

You can wirelessly print from Amazon Fire tablets and phones to your nearby networked Epson product. There is no software to download, no drivers to install, and no cables to connect. With just a few taps in Email, Calendar, Contacts, and WPS Office, you can send whatever is on the screen to an Epson product.

1. Connect your Epson product to your wireless network. See the link below.
2. Connect your Amazon device to the same wireless network as your product.
3. Now you are ready to print. From your Amazon application, tap the print option and select your product to print whatever is on the screen.

**Note:** If you see a message telling you that a plug-in is required, tap **OK** and tap **Download**. If your Amazon Fire product uses Fire OS 5 and above, your device automatically uses the built-in Mopria Print Service app to print.

**Parent topic:** [Product Basics](#)

**Related topics**

[Wi-Fi or Wired Networking](#)

## Using Windows 10 Mobile Printing

You can wirelessly print from Windows 10 Mobile tablets and phones to your nearby networked Epson product. There is no software to download, no drivers to install, and no cables to connect. Look for the print option in your Windows 10 application to send whatever is on the screen to an Epson product.

1. Connect your Epson product to your wireless network. See the link below.
2. Connect your Windows 10 Mobile device to the same wireless network as your product.
3. Now you are ready to print. From your Windows 10 application, tap the print option and select your product to print whatever is on the screen.

**Parent topic:** [Product Basics](#)

**Related topics**

[Wi-Fi or Wired Networking](#)

## Using Epson Print and Scan App with Windows Tablets

You can use this free app to print photos and scan from your Windows (Windows 8 or higher) Surface RT or Pro tablet with networked Epson products. The Epson Print and Scan app allows you to scan and capture images right to your tablet or to Microsoft OneDrive.

**Note:** The Epson Print and Scan app does not support Windows 10 Mobile printing and does not supply scanning functions for products without scanners.

1. Connect your Epson product to your wireless network. See the link below.
2. Download the Epson Print and Scan app from the Microsoft Windows Store.
3. Connect your Windows tablet to the same wireless network as your product.
4. Open the Epson Print and Scan app and select your Epson product.

Now you are ready to print photos or scan.

**Parent topic:** [Product Basics](#)

**Related topics**

[Wi-Fi or Wired Networking](#)

## Using the Mopria Print Service

You can use the Mopria Print Service to print from your Android phone or tablet (Android v4.4 or later) to your Epson product or any Mopria-certified product from other manufacturers. You can download the Mopria Print Service from Google Play.

**Note:** For details on the Mopria Print Service, [click here](#) (U.S.) or [click here](#) (Canada).

1. Connect your Epson product to your wireless network. See the link below.
2. On your Android device, download the Mopria Print Service app from Google Play.

**Note:** On some Samsung Galaxy devices, Mopria may come preinstalled.

3. Go to **Settings** on your Android device, select **Printing**, and enable the Mopria Print Service, if necessary.
4. Connect your Android device to the same wireless network as your product.

5. Now you are ready to print. From an Android application such as Chrome or Gmail, tap the menu icon and select **Print**. Then select **All printers**, select your Epson product, adjust your print settings, and print.

**Parent topic:** [Product Basics](#)

**Related topics**

[Wi-Fi or Wired Networking](#)



---

# Wi-Fi or Wired Networking

See these sections to use your product on a Wi-Fi or wired network.

[Network Security Recommendations](#)

[Wi-Fi Infrastructure Mode Setup](#)

[Wi-Fi Direct Mode Setup](#)

[Wi-Fi Protected Setup \(WPS\)](#)

[Printing a Network Status Sheet](#)

[Printing a Network Connection Report](#)

[Configuring Email Server Settings](#)

[Changing or Updating Network Connections](#)

## Network Security Recommendations

To help deter unauthorized access to your product over a network, you should protect your network environment using appropriate security measures.

Security measures such as these can help deter threats such as loss of user data, use of telephone and fax lines, and other intrusions:

- **Enable security on your wireless LAN**

Enable the appropriate security on the wireless LAN you plan to use with your product. Network security such as a network password can deter interception of traffic over the wireless LAN. Your router may already have a default password enabled by your Internet service provider (ISP). See your ISP and router documentation for instructions on how to change the default password and better secure your network.

- **Connect your product only to a network protected by a firewall**

Connecting your product directly to the Internet may leave it vulnerable to security threats. Instead, connect it to a router or other network connection protected by a firewall. Your router may already have a firewall set up by your Internet service provider; check with your ISP for confirmation. For best results, set up and use a private IP address for your network connection.

- **Change the default administrator password on your product**

If your product has an option to set an administrator password, change the default administrator password to deter access by unauthorized users to personal data stored on your product, such as IDs, passwords, and contact lists.

**Parent topic:** [Wi-Fi or Wired Networking](#)

## Wi-Fi Infrastructure Mode Setup

You can set up your product to communicate with your computer using a wireless router or access point. The wireless router or access point can be connected to your computer over a wireless or wired network.

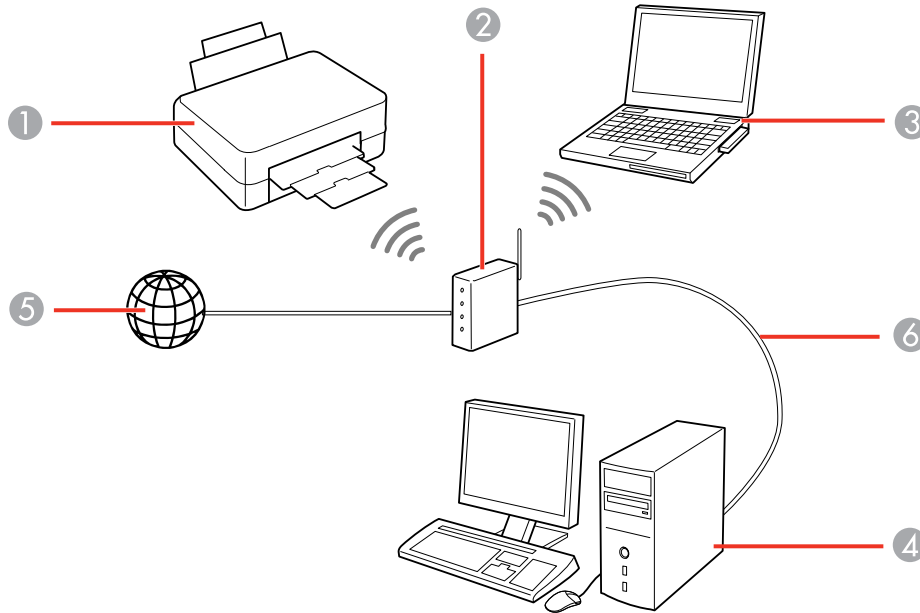

- 1 Epson product
- 2 Wireless router or access point
- 3 Computer with a wireless interface
- 4 Computer
- 5 Internet
- 6 Ethernet cable (used only for wired connection to the wireless router or access point)

[Selecting Wireless Network Settings from the Control Panel](#)



**Parent topic:** [Wi-Fi or Wired Networking](#)

## Selecting Wireless Network Settings from the Control Panel

You can select or change wireless network settings using your product control panel.

To install your product on a wireless network, follow the instructions on the *Start Here* sheet and install the necessary software by downloading it from the Epson website. The installer program guides you through network setup.

**Note:** Breakdown or repair of this product may cause loss of network data and settings. Epson is not responsible for backing up or recovering data and settings during or after the warranty period. We recommend that you make your own backup or print out your network data and settings.

1. Press the  home icon, if necessary.
2. Select the   icon.

You see a screen like this:

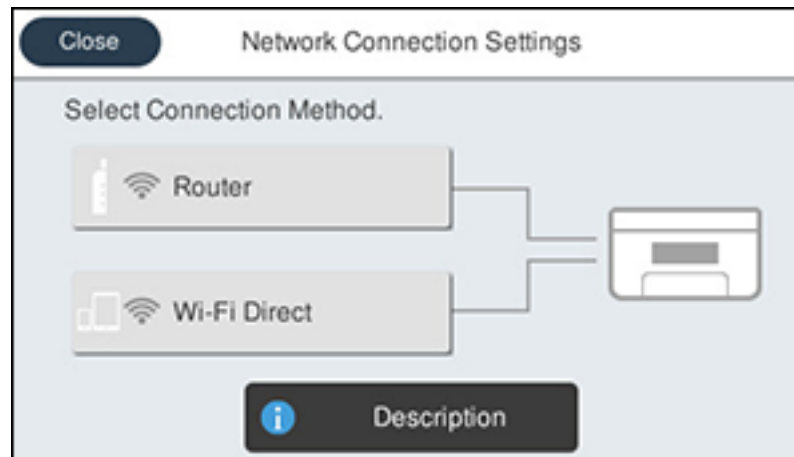



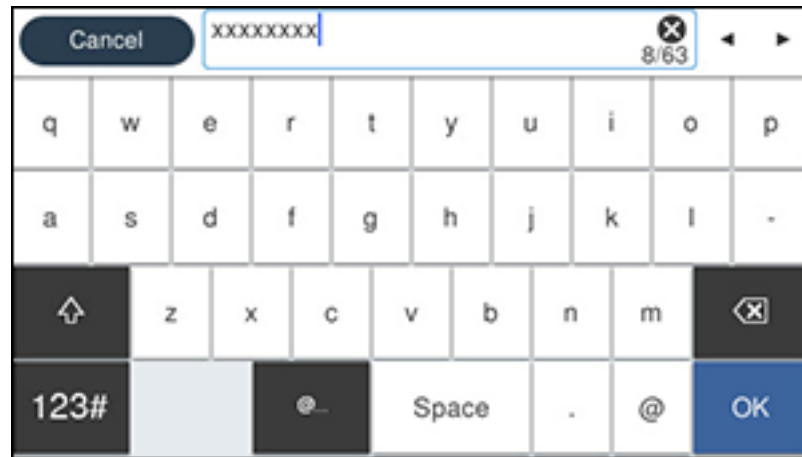

3. Select **Router**.
4. Select **Start Setup**, **Change Settings**, or **Change to Wi-Fi connection**, depending on your current connection settings.
5. Select **Wi-Fi Setup Wizard**.
6. Select the name of your wireless network or select **Enter Manually** to enter the name manually. Use the displayed keyboard to enter your network name.

7. Select the **Enter Password** field and enter your wireless password using the on-screen keyboard.



**Note:** The network name and password are case sensitive. Be sure to correctly enter uppercase and lowercase letters, and numeric or special characters.

- To move the cursor, press the left or right arrows.
  - To change the case of letters, select .
  - To delete the previous character, select .
  - To enter numbers and symbols, select .
  - To enter a space, select **Space**.
8. Select **OK** when you finish entering your password.
  9. Confirm the displayed network settings and select **Start Setup** to save them.
  10. Do one of the following:
    - If setup was successful, select **Close** to exit.
    - If setup was unsuccessful, select **Print Check Report** to print a network setup report or select **Re-enter** to re-enter your network name and password.
  11. Press the  home icon to return to the Home screen.

The  Wi-Fi icon displayed on the LCD screen indicates your wireless connection status. If the product is not connected to the network, you may have selected the wrong network name or entered the password incorrectly. Repeat these steps to try again.

If you are printing from a computer, make sure you installed the network software as described on the *Start Here* sheet.

**Parent topic:** [Wi-Fi Infrastructure Mode Setup](#)

**Related references**

[Status Icon Information](#)

**Related tasks**

[Entering Characters on the LCD Screen](#)

## Wi-Fi Direct Mode Setup

You can set up your product to communicate directly with your computer or another device without requiring a wireless router or access point. In Wi-Fi Direct Mode, the product itself acts as a network access point for up to 8 devices.

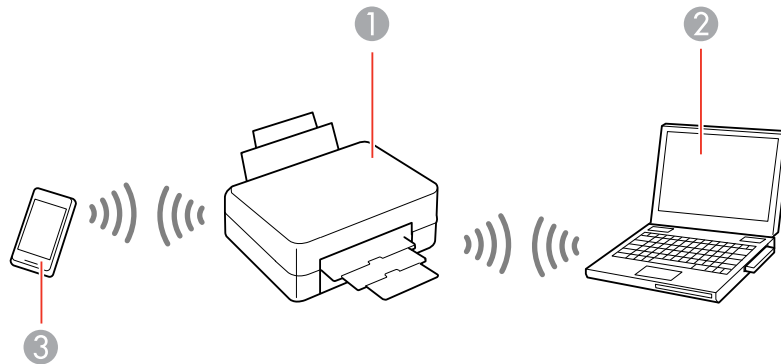

- 1 Epson product
- 2 Computer with a wireless interface
- 3 Other wireless device

[Enabling Wi-Fi Direct Mode \(Simple AP\)](#)



[Modifying the Wi-Fi Direct Network Name or Password](#)

Parent topic: [Wi-Fi or Wired Networking](#)

## Enabling Wi-Fi Direct Mode (Simple AP)

You can enable Wi-Fi Direct mode to allow direct communication between your product and computer, mobile devices, or other devices (up to 8) without a wireless router or access point.

**Note:** Make sure the Epson iPrint app or another compatible Epson printing app is installed on your mobile device before connecting to the product.

1. Press the  home icon, if necessary.
2. Select the  icon.

You see a screen like this:

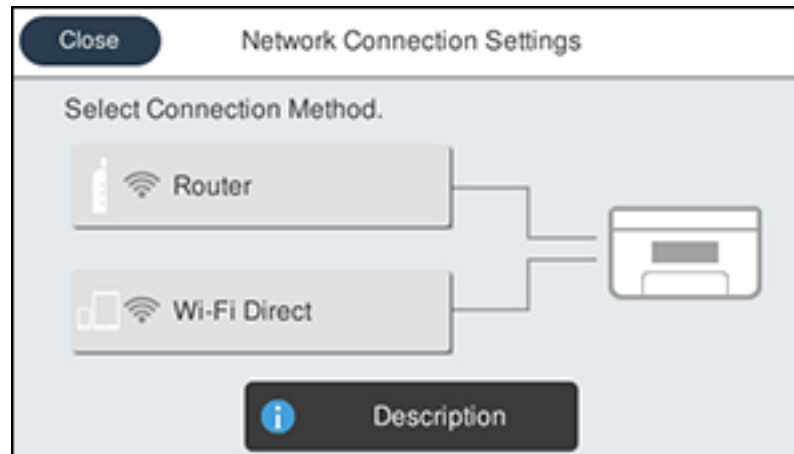

3. Select **Wi-Fi Direct**.
4. Select **Start Setup**.

You see this screen:

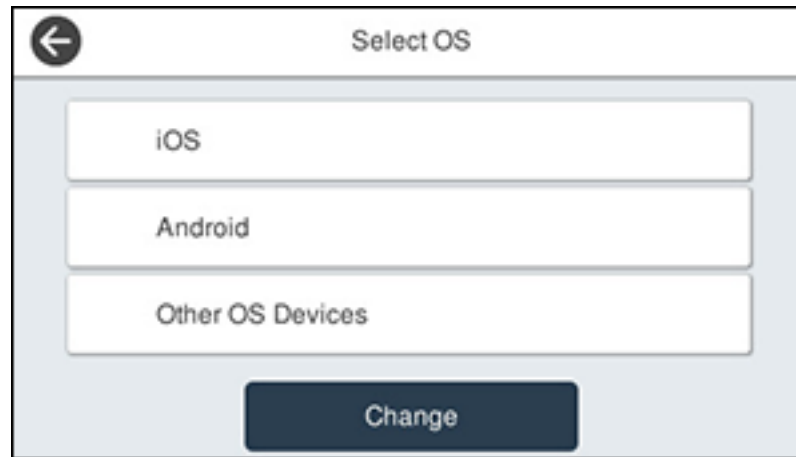

5. Do one of the following to complete Wi-Fi Direct setup:
  - For iOS devices, select **iOS**. Scan the QR code with the camera app on your device and follow the instructions on your device. Select **Next** on the LCD screen to display your product information, then open the compatible Epson printing app on your device and select your product. Select **Complete** on the LCD screen.
  - For Android devices, select **Android**. Open the compatible Epson printing app on your device and select your product. Select **Complete** on the LCD screen.
  - For other types of devices, select **Other OS Devices**. Use your device to select the Wi-Fi network name (SSID) displayed on the LCD screen and enter the password shown. Select **Next** on the LCD screen to display your product information, then follow the instructions on the LCD screen.



The  Wi-Fi Direct icon is displayed on the LCD screen and indicates if Wi-Fi Direct is enabled on the product.

Parent topic: [Wi-Fi Direct Mode Setup](#)

## Modifying the Wi-Fi Direct Network Name or Password

You can modify the Wi-Fi Direct name and password to create a more descriptive and secure Wi-Fi Direct network.

**Note:** If you are printing from a computer, make sure you installed the network software as described on the *Start Here* sheet.

1. Press the  home button, if necessary.
2. Select the   icon.

You see a screen like this:

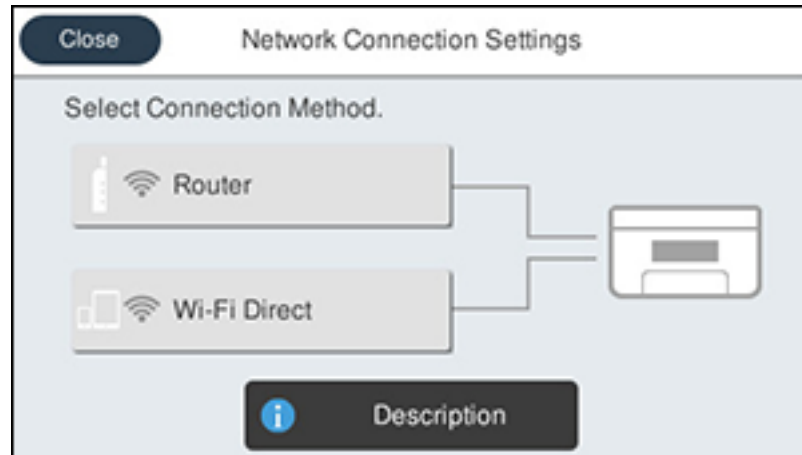

3. Select **Wi-Fi Direct**.
4. Select **Start Setup**.
5. Select **Change**.



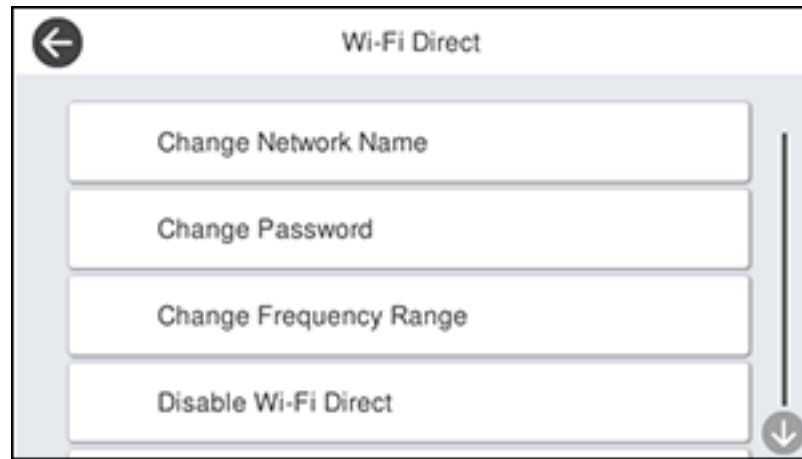

You see this screen:



6. Do one of the following:
  - To change the Wi-Fi Direct network name, select **Change Network Name** and select **Yes**. Select **Change**, then use the on-screen keyboard to enter the new network name.
  - To change the Wi-Fi Direct password, select **Change Password** and select **Yes**. Use the on-screen keyboard to enter your new Wi-Fi Direct password.

**Note:** Your password must be at least 8 and no more than 22 characters long.

**Note:** If you have already connected devices or computers to your product via Wi-Fi Direct, they will be disconnected when you change the network name or password.

7. When entering your Wi-Fi Direct network name or password, do the following:
  - To move the cursor, press the left or right arrow.
  - To change the case of letters, select .
  - To delete the previous character, select .
  - To enter numbers and symbols, select .

- To enter a space, select **Space**.
  - To finish entering your network name or password, select **OK**.
8. Use your computer or wireless device to select the Wi-Fi network name (SSID) displayed on the LCD screen, then enter the password shown.

**Note:** Make a note of the SSID and password that appear.

9. Press the  home button to return to the Home screen.

Computers and wireless devices can now access the product using the new network name and password.

**Parent topic:** [Wi-Fi Direct Mode Setup](#)

## Wi-Fi Protected Setup (WPS)

If your network uses a WPS-enabled wireless router or access point, you can quickly connect your product to the network using Wi-Fi Protected Setup (WPS).

**Note:** To check if your router is WPS-enabled, look for a button labeled **WPS** on your router or access point. If there is no hardware button, there may be a virtual WPS button in the software for the device. Check your network product documentation for details.

[Using WPS to Connect to a Network](#)

**Parent topic:** [Wi-Fi or Wired Networking](#)

## Using WPS to Connect to a Network

If you have a WPS-enabled wireless router or access point, you can use Wi-Fi Protected Setup (WPS) to connect your product to the network.

1. Press the  home icon, if necessary.
2. Select the   icon.

You see a screen like this:

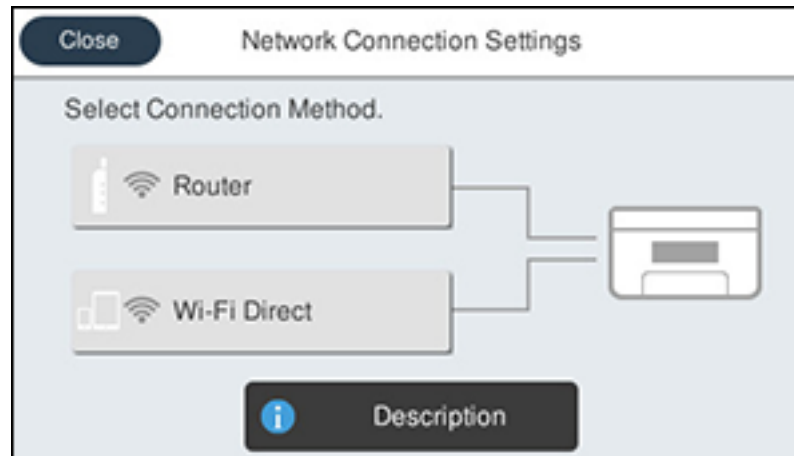

3. Select **Router**.
4. Select **Start Setup** or **Change Settings**.
5. Select **Push Button Setup (WPS)**.
6. Follow the instructions on the LCD screen to complete WPS setup.

**Note:** Make sure you press **Start Setup** within two minutes of activating WPS on your router.

7. Press the  home icon to return to the Home screen.

The  Wi-Fi icon displayed on the LCD screen indicates your wireless connection status. If the product is not connected to the network, repeat these steps to try again.

If you are printing from a computer, make sure you installed the network software as described on the *Start Here* sheet.

Parent topic: [Wi-Fi Protected Setup \(WPS\)](#)

## Printing a Network Status Sheet

You can print a network status sheet to help you determine the causes of any problems you may have using your product on a network.

1. Make sure a few sheets of plain paper are loaded in the cassette.
2. Press the  home icon, if necessary.
3. Select **Settings** > **General Settings** > **Network Settings**.

You see a screen like this:

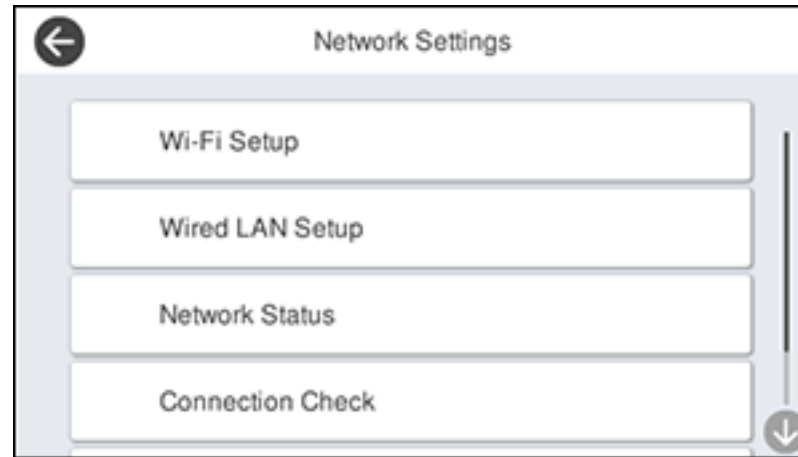

4. Select **Network Status** > **Print Status Sheet**.
5. Select **Print**.

Examine the settings shown on the network status sheet to diagnose any problems you have.

**Parent topic:** [Wi-Fi or Wired Networking](#)

## Printing a Network Connection Report

You can print a network connection report to view solutions to any problems you may have using your product on a network.

1. Make sure a few sheets of plain paper are loaded in the lower cassette.
2. Press the  home icon, if necessary.
3. Select **Settings** > **General Settings** > **Network Settings**.

You see a screen like this:

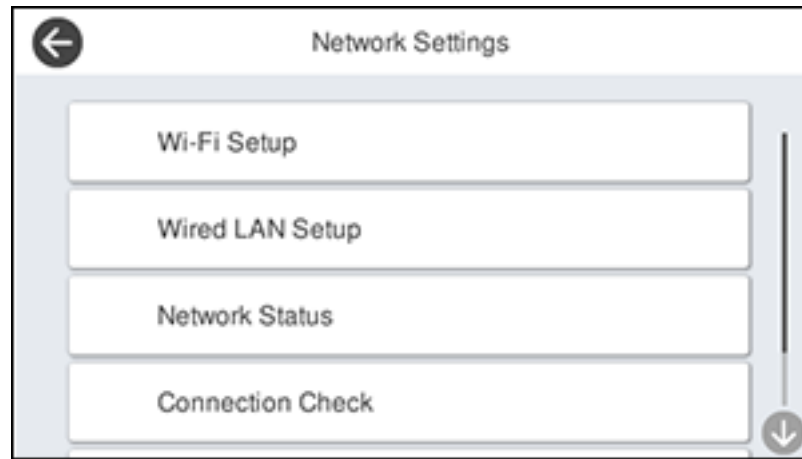

4. Select **Connection Check**.
  5. Select **Print Check Report** to print the network connection report.
- Examine any error codes and solutions shown on the network connection report.  
[Network Connection Report Codes and Messages](#)
- Parent topic:** [Wi-Fi or Wired Networking](#)

## Network Connection Report Codes and Messages

Check the error codes and messages on the network connection report to solve problems you may encounter with network connections. The tables here list solutions to problems based on the error codes and messages that may appear on the top of the report.

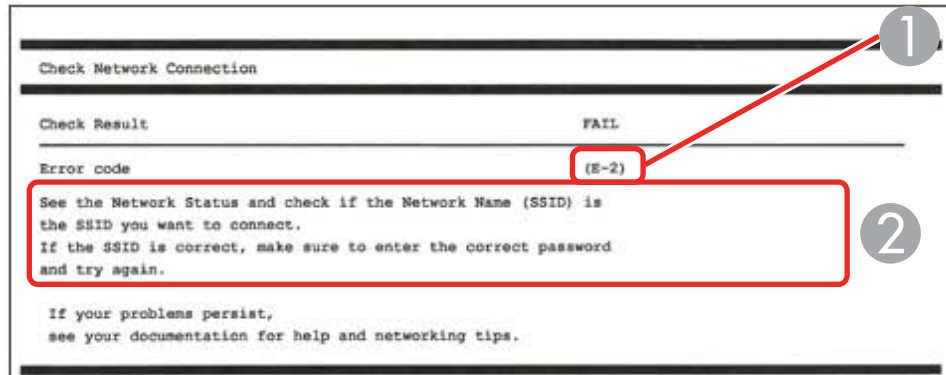

- 1 Error code
- 2 Message

**Note:** Error codes and messages listed here may not all apply to your product.

### Error Codes and Messages

Error code and message	Solution
<b>E-1</b> Confirm that the network cable is connected and network devices such as hub, router, or access point are turned on.	Make sure your router, access point, and/or hub are turned on, and the network cable is securely connected to your device and to your product.  If you are trying to set up Wi-Fi, remove the network cable and set up Wi-Fi again. Ethernet and Wi-Fi cannot be connected at the same time.

Error code and message	Solution
<p><b>E-2, E-3, or E-7</b></p> <p>No wireless network names (SSID) found. Confirm that the router/access point is turned on and the wireless network (SSID) is set up correctly. Contact your network administrator for assistance.</p> <p>No wireless network names (SSID) found. Confirm that the wireless network name (SSID) of the PC you wish to connect is set up correctly. Contact your network administrator for assistance.</p> <p>Entered security key/password does not match the one set for your router/access point. Confirm security key/password. Contact your network administrator for assistance.</p>	<p>Check the following:</p> <ul style="list-style-type: none"> <li>• Make sure your router or access point is turned on, and is correctly connected to your computer or network device.</li> <li>• Turn off the router or access point, wait about 10 seconds, and turn it on again.</li> <li>• Move your product closer to your router or access point, and remove any obstacles between them. Also move your product away from devices such as wireless phones or microwaves.</li> <li>• Confirm that the SSID shown on the network connection report matches the label on your router or access point. Also make sure your SSID uses only ASCII characters and symbols, or your product cannot display the SSID correctly.</li> <li>• If you are trying to connect using the WPS push button method, make sure your router or access point supports it.</li> <li>• If you are using a network password, check the label on your router or access point to confirm that you are using the correct password, or check with your network administrator or router/access point documentation.</li> <li>• If you are connecting to a smart device that generates an SSID, check the device documentation for the SSID and password you should use.</li> <li>• If your wireless connection suddenly disconnects, and another smart device was added to the network using a WPS push button method or your network was set up using a non-WPS push button method, try downloading and installing your product software again.</li> </ul>

Error code and message	Solution
<p><b>E-5</b> Security mode (e.g. WEP, WPA) does not match the current setting of the printer. Confirm security mode. Contact your network administrator for assistance.</p>	<p>If the security on your router or access point is not one of the following types, change the type of security on your router or access point and reset your product's network settings.</p> <ul style="list-style-type: none"> <li>• WEP-64 bit (40 bit)</li> <li>• WEP-128 bit (104 bit)</li> <li>• WPA PSK (TKIP/AES); also known as WPA Personal</li> <li>• WPA2 PSK (TKIP/AES); also known as WPA2 Personal</li> <li>• WPA (TKIP/AES)</li> <li>• WPA2 (TKIP/AES)</li> <li>• WPA3-SAE (AES)</li> <li>• WPA2/WPA3-Enterprise</li> </ul>
<p><b>E-6</b> MAC address of your printer may be filtered. Check whether your router/access point has restrictions such as MAC address filtering. See the documentation of the router/access point or contact your network administrator for assistance.</p>	<p>If your router or access point has MAC address filtering enabled, register your product's MAC address so it is not filtered. Locate the MAC address on the network connection report and check your router or access point documentation for instructions.</p> <p>If your router or access point is using shared authentication with WEP security, confirm that you are using the correct authentication key and index.</p> <p>If your router or access point limits the number of connected devices, raise the connection limit. See your router or access point documentation for instructions.</p>
<p><b>E-8</b> Incorrect IP address is assigned to the printer. Confirm IP address setup of the network device (hub, router, or access point). Contact your network administrator for assistance.</p>	<p>If your product's <b>Obtain IP Address</b> setting is set to <b>Auto</b>, enable DHCP on your router or access point. If it is set to <b>Manual</b>, the IP address may be out of range or on a different network segment; set a valid IP address using your product control panel or the Web Config utility.</p> <p>You can also try turning off your product and the router or access point, waiting about 10 seconds, and turning them on again.</p>



Error code and message	Solution
<p><b>E-9</b></p> <p>Confirm the connection and network setup of the PC or other device. Connection using the EpsonNet Setup is available. Contact your network administrator for assistance.</p>	<p>Make sure your computer or network device are turned on. Also make sure that you can access the Internet and other devices on the same network from the devices you are trying to connect to your product.</p> <p>If you still cannot connect to your product, turn off your router or access point, wait about 10 seconds, and turn it on again. Download and install your product software again to reset your network settings.</p>
<p><b>E-10</b></p> <p>Confirm IP address, subnet mask, and default gateway setup. Connection using the EpsonNet Setup is available. Contact your network administrator for assistance.</p>	<p>Make sure other devices on the network are turned on and do the following:</p> <ul style="list-style-type: none"> <li>• If your product's <b>Obtain IP Address</b> setting is set to <b>Manual</b>, check the IP address, subnet mask, and default gateway addresses on the network connection report to see if they are correct. If not, correct the settings.</li> <li>• If DHCP is enabled, set your product's <b>Obtain IP Address</b> setting to <b>Auto</b>. If you want to use the DHCP-assigned address as a static address, set the <b>Obtain IP Address</b> setting to <b>Manual</b>, enter the product's IP address as listed on the network connection report, and set the subnet mask to 255.255.255.0.</li> </ul> <p>If you still cannot connect to your product, turn off your router or access point, wait about 10 seconds, and turn it on again.</p>
<p><b>E-11</b></p> <p>Setup is incomplete. Confirm default gateway setup. Connection using the EpsonNet Setup is available. Contact your network administrator for assistance.</p>	<p>If you set your product's <b>TCP/IP Setup</b> setting to <b>Manual</b>, check that the default gateway address listed on the network connection report is correct. Also turn on the device that is set as the default gateway.</p>

Error code and message	Solution
<p><b>E-12</b></p> <p>Confirm the following:</p> <ul style="list-style-type: none"> <li>-Entered security key/password is correct</li> <li>-Index of the security key/password is set to the first number</li> <li>-IP address, subnet mask, or default gateway setup is correct</li> </ul> <p>Contact your network administrator for assistance.</p>	<p>Make sure other devices on the network are turned on and do the following:</p> <ul style="list-style-type: none"> <li>• Make sure the IP address, subnet mask, and default gateway addresses are correct, if you are entering them manually.</li> <li>• Confirm that the subnet mask and default gateway addresses for other devices are the same.</li> <li>• Make sure the IP address does not conflict with other devices.</li> </ul> <p>If you still cannot connect to your product, do the following:</p> <ul style="list-style-type: none"> <li>• Turn off your router or access point, wait about 10 seconds, and turn it on again.</li> <li>• Download and install your product software again to reset your network settings.</li> <li>• If your router or access point uses WEP security with several registered passwords, make sure that the first registered password is set on your product.</li> </ul>
<p><b>E-13</b></p> <p>Confirm the following:</p> <ul style="list-style-type: none"> <li>-Entered security key/password is correct</li> <li>-Index of the security key/password is set to the first number</li> <li>-Connection and network setup of the PC or other device is correct</li> </ul> <p>Contact your network administrator for assistance.</p>	<p>Make sure your router, access point, and/or hub are turned on. Also make sure the TCP/IP setup on your router, access point, and/or hub is not set manually; this may cause your product's network settings to differ from the manually set up devices.</p> <p>If you still cannot connect to your product, do the following:</p> <ul style="list-style-type: none"> <li>• Turn off your router or access point, wait about 10 seconds, and turn it on again.</li> <li>• Download and install your product software again to reset your network settings.</li> <li>• If your router or access point uses WEP security with several registered passwords, make sure that the first registered password is set on your product.</li> </ul>

## Network Environment Messages

Message	Solution
The Wi-Fi environment needs to be improved. Turn the wireless router off and then turn it on. If the connection does not improve, see the documentation for the wireless router.	Move your product closer to your router or access point, and remove any obstacles between them. Then turn off your router or access point, wait about 10 seconds, and turn it back on again. If you still cannot connect to your product, check the documentation that came with your router or access point for solutions.
*No more devices can be connected. Disconnect one of the connected devices if you want to add another one.	You can connect up to 8 computers or other devices to your product using a Wi-Fi Direct (Simple AP) connection. If you want to add another device, disconnect an existing connected device first.
The same SSID as Wi-Fi Direct exists in the environment. Change the Wi-Fi Direct SSID if you cannot connect a smart device to the printer.	Change the Wi-Fi Direct SSID.

Parent topic: [Printing a Network Connection Report](#)

## Configuring Email Server Settings

To use features such as scanning to email or forwarding faxes to email, you need to configure the email server. You can select settings for the email server using the product control panel.

**Note:** These settings can be locked by an administrator. If you cannot access these settings, contact your administrator for assistance.

1. Press the  home button, if necessary.
2. Select **Settings > General Settings > Network Settings**.

You see a screen like this:

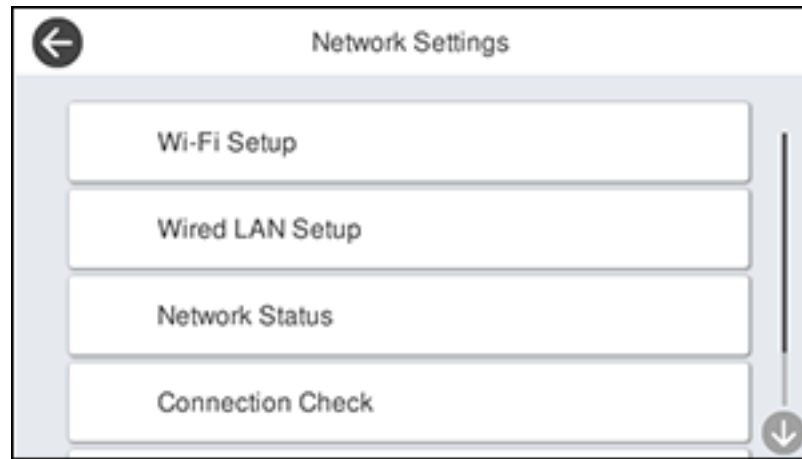

3. Select **Advanced > Email Server > Server Settings**.

You see a screen like this:

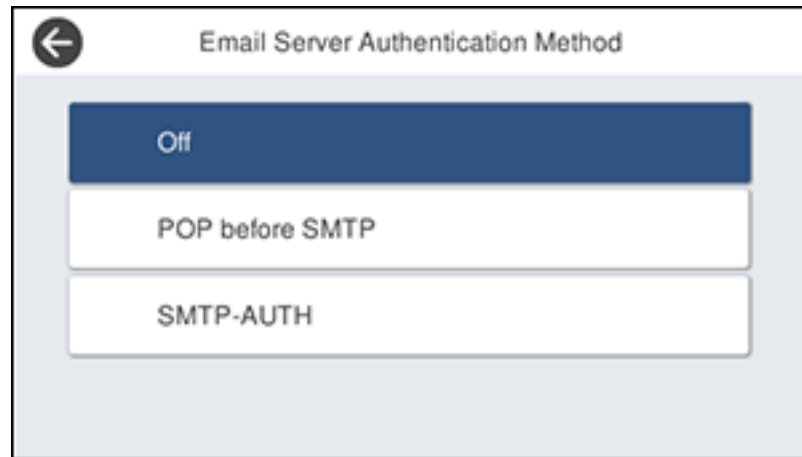

4. Select one of the options shown above, then select the settings you want to use. Contact your internet service provider if necessary to confirm the authentication method for the email server.

5. Select **Proceed** to save your settings.
6. Select **Close** to exit.
7. Select **Connection Check** to verify the connection to the email server.

**Parent topic:** [Wi-Fi or Wired Networking](#)

**Related tasks**

[Scanning to Email](#)

[Forwarding Received Faxes](#)

## Changing or Updating Network Connections

See these sections to change or update how your product connects to a network.

[Accessing the Web Config Utility](#)

[Changing a USB Connection to a Wi-Fi Connection](#)

[Changing a Wi-Fi Connection to a Wired Network Connection](#)

[Connecting to a New Wi-Fi Router](#)

[Disabling Wi-Fi Features](#)

[Disabling Wi-Fi Direct Features](#)

**Parent topic:** [Wi-Fi or Wired Networking](#)

## Accessing the Web Config Utility

You can select your product's network settings and confirm its operating status using a web browser. You do this by accessing your product's built-in Web Config utility from a computer or other device that is connected to the same network as your product.

**Note:** For more information on the Web Config utility, see the [Administrator's Guide](#).

1. Print a network status sheet.
2. Locate the IP address for your product that is listed on the network status sheet.
3. On a computer or other device connected to the same network as your product, open a web browser.
4. Enter your product's IP address into the address bar.

You see the available Web Config utility options.

**Parent topic:** [Changing or Updating Network Connections](#)

## Changing a USB Connection to a Wi-Fi Connection

If you have already connected your product to your computer using a USB connection, you can change to a Wi-Fi connection.

1. Disconnect the USB cable from your product.
2. Uninstall your product software.
3. Download and install your product software from the Epson website using the instructions on the *Start Here* sheet.

**Parent topic:** [Changing or Updating Network Connections](#)

## Changing a Wi-Fi Connection to a Wired Network Connection

If you have already connected your product to your computer wirelessly, you can change to a wired network connection if necessary.

1. Disable your product's Wi-Fi features.
2. Connect one end of an Ethernet network cable to the product's **LAN** port.
3. Connect the other end to any available LAN port on your router or access point.
4. Uninstall your product software.
5. Download and install your product software from the Epson website.
6. Follow the on-screen instructions to install the software.
7. When you see the Select Your Connection screen, select **Wired network connection**.
8. If you see a Select Setup Option screen, select **Set up printer for the first time**.
9. Continue following the rest of the on-screen instructions.

**Parent topic:** [Changing or Updating Network Connections](#)

### Related tasks

[Disabling Wi-Fi Features](#)

## Connecting to a New Wi-Fi Router

If you change the wireless router you have been using on your network, you need to update your product's Wi-Fi connection to the new router.

1. Do one of the following:
  - **Windows:** Uninstall your product software.

- **Mac:** Go to the next step.
2. Download and install your product software from the Epson website using the instructions on the *Start Here* sheet.

**Parent topic:** [Changing or Updating Network Connections](#)



**Related concepts**

[Uninstall Your Product Software](#)

## Disabling Wi-Fi Features

You may need to disable your product's Wi-Fi features if you change your network connection type or need to solve a problem with your network connection.

**Note:** Before disabling Wi-Fi features, make a note of your product's SSID (network name) and password, and any network settings selected for the Epson Connect services you may use.

1. Press the  home icon, if necessary.
2. Select the   icon.

You see a screen like this:

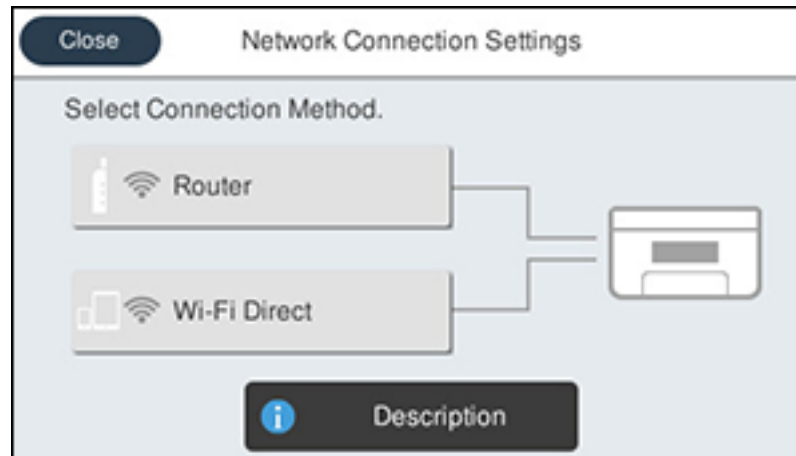



3. Select **Router**.
4. Select **Change Settings**.

5. Select **Others**.
6. Select **Disable Wi-Fi**.
7. Select **Start Setup** to disable Wi-Fi.
8. Select **Close**.

Parent topic: [Changing or Updating Network Connections](#)

## Disabling Wi-Fi Direct Features

You may need to disable your product's Wi-Fi Direct features if you change your connection type or need to solve a problem with your Wi-Fi Direct connection.

1. Press the  home icon, if necessary.
2. Select the  icon.

You see a screen like this:

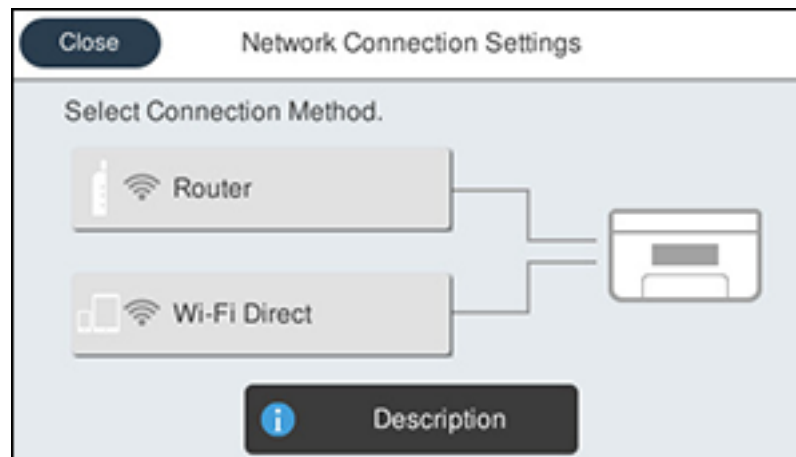

3. Select **Wi-Fi Direct**.
4. Select **Change**.
5. Select **Disable Wi-Fi Direct**.
6. Select **Disable the settings** to disable Wi-Fi Direct.
7. Select **Close**.



**Parent topic:** [Changing or Updating Network Connections](#)

---

## Enabling PCL or PostScript Printing (ST-C8090)

Before enabling PCL or PostScript printing on your product, make sure you have installed the software as described on the *Start Here* sheet (ST-C8090).

To download the PCL or PostScript drivers, visit [epson.com/support](http://epson.com/support) (U.S.), [epson.ca/support](http://epson.ca/support) (Canada), or [epson.com.jm/support](http://epson.com.jm/support) (Caribbean) and select your product.

[Installing the PCL Driver - Windows](#)

[Installing the PostScript \(PS3\) Printer Software - Windows](#)

[Installing the PostScript \(PS3\) Printer Software - Mac](#)

[Selecting PDL \(Page Description Language\) Settings](#)

[Selecting Printer Language and Interface Settings](#)

[Printing a PCL or PS3 \(PostScript\) Status Sheet](#)

### Installing the PCL Driver - Windows

The PCL driver can be installed on a Windows computer. Before enabling PCL printing on your product, make sure you have installed the software as described on the *Start Here* sheet.

**Note:** Make sure your product is turned on and connected to the same network as your computer before installing the printer software. Depending on your model, not all printer languages may be supported.

1. To download the PCL file, visit [epson.com/support](http://epson.com/support) (U.S.), [epson.ca/support](http://epson.ca/support) (Canada), or [epson.com.jm/support](http://epson.com.jm/support) (Caribbean) and select your product.
2. After downloading the installer file, double-click the downloaded file to install the software.

3. Follow the on-screen instructions until you see this screen:

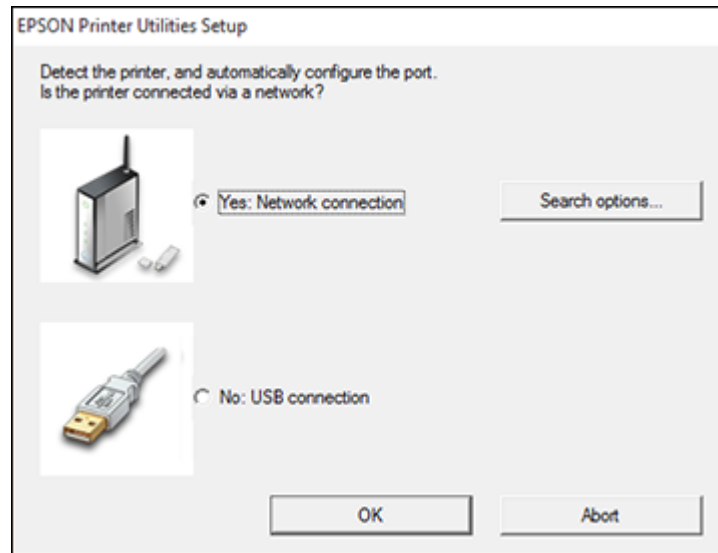

4. If your product is already connected to a network, select **Yes: Network connection** and click **OK**. You see a screen like this:

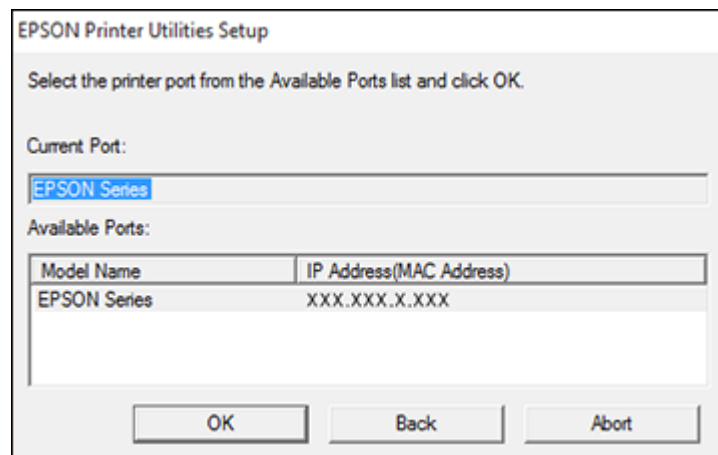

5. Make sure your product is selected, and click **OK**.  
A message appears when the installation is complete.
6. If your product is not connected to a network, select **No: USB connection** and click **OK**. Connect a USB cable to your product's USB port, and connect the other end of the cable to your computer.  
A message appears when the installation is complete.

**Parent topic:** [Enabling PCL or PostScript Printing \(ST-C8090\)](#)

## Installing the PostScript (PS3) Printer Software - Windows

If you did not install the standard Epson printer software, you need to install the PostScript (PS3) printer software before you can adjust the print settings and print to your network printer.

**Note:** Make sure your product is turned on and connected to the same network as your computer before installing the printer software.

1. To download the PS3/Postscript software package, visit [epson.com/support](http://epson.com/support) (U.S.), [epson.ca/support](http://epson.ca/support) (Canada), or [epson.com.jm/support](http://epson.com.jm/support) (Caribbean) and select your product.
2. After downloading the installer file, double-click the downloaded file to install the software.
3. Click **OK**.
4. Click **Accept**.
5. Click **Install**.
6. Click **Next** and follow the on-screen instructions.

**Parent topic:** [Enabling PCL or PostScript Printing \(ST-C8090\)](#)

## Installing the PostScript (PS3) Printer Software - Mac

If you did not install the standard Epson printer software, you need to install the PostScript (PS3) printer software before you can adjust the print settings and print to your network printer.

**Note:** Make sure your product is turned on and connected to the same network as your computer before installing the printer software.

1. To download the PS3 Postscript software package, visit [epson.com/support](http://epson.com/support) (U.S.), [epson.ca/support](http://epson.ca/support) (Canada), or [epson.com.jm/support](http://epson.com.jm/support) (Caribbean) and select your product.
2. After downloading the installer file, double-click the downloaded file to install the software.

3. Double-click **EPSON**.
4. Click **Continue** on the next two screens.
5. Click **Agree**.
6. Click **Install**.
7. If necessary, enter the administrator password.
8. Click **Start** and follow the on-screen instructions.

**Parent topic:** [Enabling PCL or PostScript Printing \(ST-C8090\)](#)

## Selecting PDL (Page Description Language) Settings

You can select settings for PCL and PostScript printing using the control panel on the product.

**Note:** These settings can be locked by an administrator. If you cannot access these settings, contact your administrator for assistance.

1. Press the  home button, if necessary.
2. Select **Settings** > **General Settings** > **Printer Settings** > **PDL Print Configuration**.

You see a screen like this:



3. Select one of the options shown above, then select the PDL print configuration options you want to use.
4. When you are finished, press the  home button to return to the Home screen.

[PDL Print Configuration Options](#)

**Parent topic:** [Enabling PCL or PostScript Printing \(ST-C8090\)](#)

## PDL Print Configuration Options

Select the **PDL Print Configuration** options you want to use for PCL or PostScript printing.

**Common Settings** menu

Option	Available settings	Description
<b>Paper Size</b>	Various sizes	Sets the default paper size for PCL or PostScript printing
<b>Paper Type</b>	Various paper types	Sets the default paper type for PCL or PostScript printing
<b>Orientation</b>	<b>Portrait</b>	Sets the default orientation for PCL or PostScript printing
	<b>Landscape</b>	
<b>Quality</b>	<b>Draft</b>	Sets the quality for PCL or PostScript printing
	<b>Standard</b>	
	<b>Best</b>	
<b>Ink Save Mode</b>	<b>On/Off</b>	Saves ink by reducing print density
<b>Print Order</b>	<b>Last Page on Top</b>	Starts printing from the first page of a file
	<b>First Page on Top</b>	Starts printing from the last page of a file
<b>Number of Copies</b>	1 to 999	Selects the number of copies to print
<b>Binding Margin</b>	<b>Left Edge</b>	Specifies the binding edge for double-sided documents
	<b>Top Edge</b>	
<b>Auto Paper Ejection</b>	<b>On/Off</b>	Ejects paper automatically when printing is stopped during a print job
<b>2-Sided Printing</b>	<b>On/Off</b>	Selects duplex printing

**PCL Menu**

Option	Available settings	Description
<b>Font Source</b>	<b>Resident</b>	Uses a font preinstalled on the printer
	<b>Download</b>	Uses a font you have downloaded
<b>Font Number</b>	0 to 111	Selects the default font number for the default font source
<b>Pitch</b>	0.44 to 99.99 cpi	Selects the default font pitch if the font is scalable and fixed-pitch (availability depends on font source and number settings)
<b>Height</b>	4.00 to 999.75 pt	Selects the default font height if the font is scalable and proportional (availability depends on font source and number settings)
<b>Symbol Set</b>	Various	Selects the default symbol set. If the selected font is not available for the selected symbol set, the font source and number are replaced with <b>IBM-US</b> (the default setting).
<b>Form</b>	5 to 128 lines	Sets the number of lines for the selected paper size and orientation. Changes the line spacing (VMI) stored in the printer. Later changes in page size or orientation cause changes in the <b>Form</b> value based on the stored VMI.
<b>CR Function</b>	<b>CR</b>	Selects the line feed command when printing with a driver from a specific operating system
	<b>CR+LF</b>	
<b>LF Function</b>	<b>LF</b>	
	<b>CR+LF</b>	
<b>Paper Source Assign</b>	<b>4</b>	Makes the paper source select command compatible with HP LaserJet 4
	<b>4K</b>	Makes the paper source select command compatible with HP LaserJet 4000, 5000, and 8000
	<b>5S</b>	Makes the paper source select command compatible with HP LaserJet 5S

## PS Menu

Option	Available settings	Description
Error Sheet	On/Off	Prints a sheet showing the status when errors occur during PostScript or PDF printing
Coloration	Color	Selects the color mode for PostScript printing
	Mono	
Binary	On/Off	Enable when printing files that contain binary images (available when the product is connected to the network). Allows you to print binary images even if the driver is set to ASCII.
PDF Page Size	Various sizes	Selects the paper size when printing a PDF file. If <b>Auto</b> is selected, the paper size is determined based on the size of the first page.

Parent topic: [Selecting PDL \(Page Description Language\) Settings](#)

## Selecting Printer Language and Interface Settings

You can select printer language and interface settings using the control panel on the product.

**Note:** These settings can be locked by an administrator. If you cannot access these settings, contact your administrator for assistance.

1. Press the  home button, if necessary.
2. Select **Settings** > **General Settings** > **Printer Settings**.



You see a screen like this:



3. Select the printing language and interface options for your connection type.
4. When you are finished, press the  home button to return to the Home screen.

[Printing Language and Interface Options](#)

**Parent topic:** [Enabling PCL or PostScript Printing \(ST-C8090\)](#)

## Printing Language and Interface Options

Select the printing language and interface options you want to use.

Main **Printer Settings** menu

Option	Available settings	Description
<b>PC Connection via USB</b>	<b>Enable</b>	Select whether to allow USB communication with the product
	<b>Disable</b>	
<b>USB I/F Timeout Setting</b>	0.5 to 300 seconds	Specify the length of time before ending USB communication from a computer using the PCL or PostScript driver. This setting is necessary to avoid endless USB communication.

### Printing Language menu

Option	Available settings	Description
USB	Auto	Select the language for the USB or network interface
Network	PCL PS PDF	

Parent topic: [Selecting Printer Language and Interface Settings](#)

## Printing a PCL or PS3 (PostScript) Status Sheet

You can print a PCL or PS3 (PostScript) status sheet to confirm the current font information.

1. Press the  home button, if necessary.
2. Select **Settings** > **Printer Status/Print** > **Print Status Sheet**.

You see a screen like this:

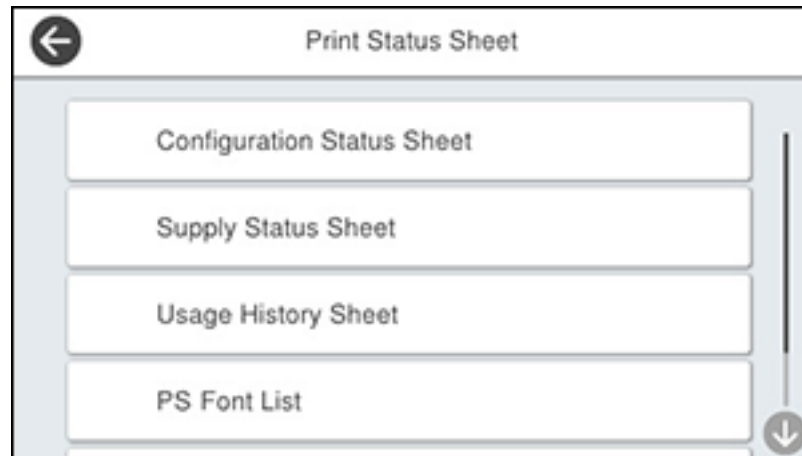

3. Select **PS Font List** or **PCL Font List**.
4. Select **Print** to print the status sheet.

**Parent topic:** [Enabling PCL or PostScript Printing \(ST-C8090\)](#)

---

# Loading Paper

Before you print, load paper for the type of printing you will do.

[Loading Paper in the Cassettes](#)

[Paper Loading Capacity](#)

[Double-sided Printing Capacity](#)

[Compatible Epson Papers](#)

[Paper or Media Type Settings - Printing Software](#)

[Selecting the Paper Settings for Each Source - Control Panel](#)

[Selecting Default Paper Settings - Administrator](#)

## Loading Paper in the Cassettes

You can load paper up to this size in the paper cassettes: A3 (11.7 × 16.5 inches [297 × 420 mm])

1. Make sure the product is not operating and pull out the paper cassette.

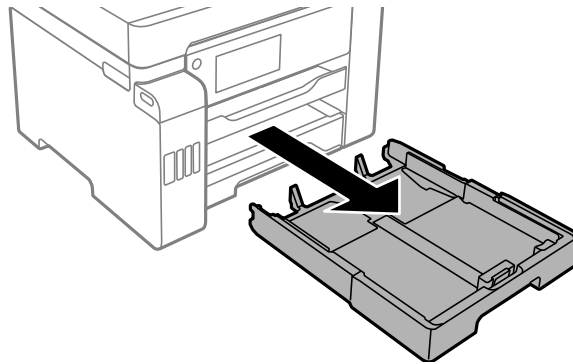

2. Slide the side edge guides outward all the way, then slide the side front edge guide to the paper size you are using.

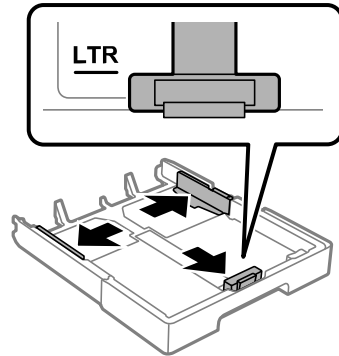

3. Load paper with the printable side facedown.

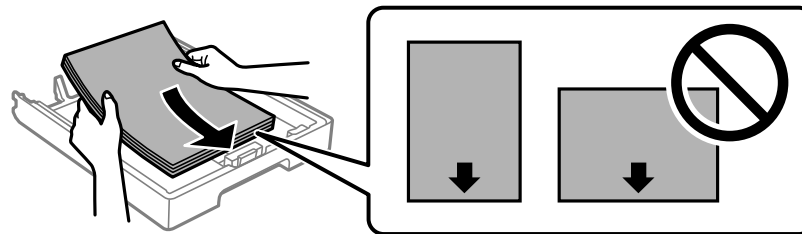

4. Slide the side edge guides against the paper.

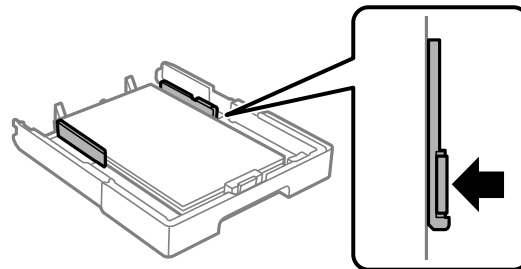

**Note:** Make sure the paper fits beneath the arrow mark inside the edge guides.

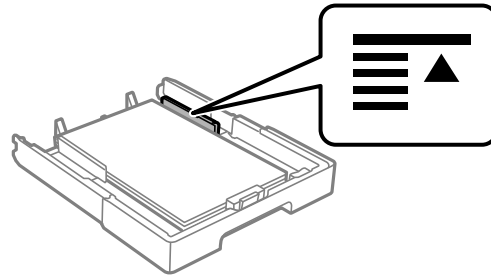

5. Insert the paper cassette all the way into the product.

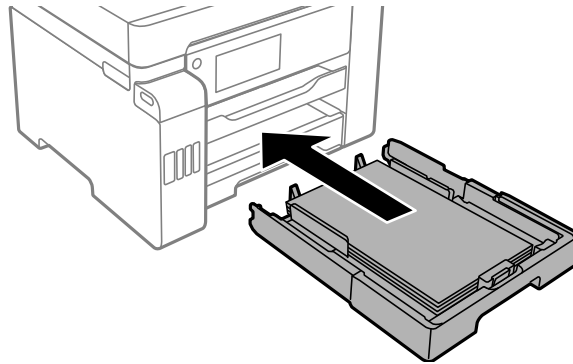

6. Do one of the following:

- Select the size and type of paper you loaded on the LCD screen.
- Press the **≡ Paper Setting** button, select the paper source, and select the size and type of paper you loaded.
- Select **Settings > General Settings > Printer Settings > Paper Source Settings > Paper Setting** to select the size and type of paper you loaded.

Always follow these paper loading guidelines:

- Load only the recommended number of sheets.
- Load only plain paper in cassette 2.

- Load paper short edge first, no matter which way your document faces.
- Load the printable side facedown.
- Load letterhead or pre-printed paper top edge first.
- Do not load paper above the line underneath the arrow mark inside the edge guides.
- Check the paper package for any additional loading instructions.

**Parent topic:** [Loading Paper](#)

**Related references**

[Paper Loading Capacity](#)

[Paper Specifications](#)

## Paper Loading Capacity

As described in the tables below, do not load paper in the paper cassettes above the arrow marks on these stickers inside the cassette:

- Use this guide for standard paper: 

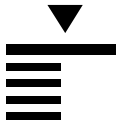
- Use this guide for thick paper and envelopes: 

### Standard and Thick Paper Capacity

You can load up to the following number of sheets in the rear paper feed slot (paper tray):

- 50 sheets of standard paper; load only 1 sheet of paper in a user-defined size between 19 inches (483.1 mm) and 236 inches (6000 mm) long (available only when printing from a computer)
- 20 sheets of thick paper (25 to 68 lb [91 to 256 g/m<sup>2</sup>]); load only 1 sheet of thick paper in a user-defined size between 19 inches (483.1 mm) and 236 inches (6000 mm) long (available only when printing from a computer)
- 10 envelopes

Paper type	Paper size	Loading capacity		
		Cassette 1	Cassette 2	Rear paper feed (paper tray)
Plain paper Letterhead paper	13 × 19 inches (330 × 483 mm)	—		50
Recycled paper Colored paper Pre-printed paper High-quality plain paper	A3 (11.7 × 16.5 inches [297 × 420 mm]), A4 (8.3 × 11.7 inches [210 × 297 mm]), Letter (8.5 × 11 inches [216 × 279 mm]), Legal (8.5 × 14 inches [216 × 356 mm]), 11 × 17 inches (279 × 432 mm), Executive (7.25 × 10.5 inches [184 × 267 mm]), Mexico-Oficio (8.5 × 13.4 inches [216 × 340 mm]), Oficio 9 (8.46 × 12.4 inches [215 × 315 mm])	250		50
	A5 (5.8 × 8.2 inches [148 × 210 mm]), A6 (4.1 × 5.8 inches [105 × 148 mm]), B6 (5 × 7.2 inches [128 × 182 mm]), Half Letter (5.5 × 8.5 inches [140 × 216 mm])	250	—	50



Paper type	Paper size	Loading capacity		
		Cassette 1	Cassette 2	Rear paper feed (paper tray)
Plain paper Letterhead paper Recycled paper Colored paper Pre-printed paper High-quality plain paper	User defined (3.5 × 5 inches [89 × 127 mm] to 11.7 × 17 inches [297 × 431.8 mm])	250	—	—
	User defined (3.5 × 17 inches [89 × 431.9 mm] to 11.7 × 47.2 inches [297 × 1200 mm])	1	—	—
	User defined (7.5 × 10.1 inches [182 × 257 mm] to 11.7 × 17 inches [297 × 431.8 mm])	—	250	—
	User defined (7.5 × 17 inches [182 × 431.9 mm] to 11.7 × 47.2 inches [297 × 1200 mm])	—	1	—
	User defined (2.5 × 5 inches [64 × 127] to 13 × 19 inches [329 × 483])	—	—	50
	User defined (2.5 × 19 inches [64 × 483.1] to 13 × 236.2 inches [329 × 6000 mm])	—	—	1
	Envelopes	#10	10	—

Paper type	Paper size	Loading capacity		
		Cassette 1	Cassette 2	Rear paper feed (paper tray)
Thick paper (24 to 43 lb [91 to 160 g/m <sup>2</sup> ])	Supported paper sizes*	50	—	20
	User defined (3.5 × 5 inches [89 × 127 mm] to 11.7 × 17 inches [297 × 431.8 mm])	50	—	—
	User defined (3.5 × 17 inches [89 × 431.9 mm] to 11.7 × 47.2 inches [297 × 1200 mm])	1	—	—
	User defined (2.5 × 5 inches [64 × 127 mm] to 13 × 19 inches [329 × 483 mm])	—	—	20
	User defined (2.5 × 13 inches [64 × 329 mm] to 19 × 236.2 inches [483.1 × 6000 mm])	—	—	1

\* Select the paper specification link below to view the list of supported paper sizes.

### Epson Paper Capacity

Paper type	Loading capacity		
	Cassette 1	Cassette 2	Rear paper feed slot
Epson Bright White Paper Epson Bright White Premium Paper Epson Multipurpose Plus Paper	250 sheets		50 sheets

Paper type	Loading capacity		
	Cassette 1	Cassette 2	Rear paper feed slot
Epson Presentation Paper Matte Epson High Quality Ink Jet Paper	100 sheets	—	20 sheets
Epson Premium Photo Paper Glossy Epson Premium Photo Paper Semi-gloss Epson Ultra Premium Photo Paper Glossy Epson Premium Presentation Paper Matte	50 sheets	—	20 sheets

**Note:** When printing at a user-defined size on genuine Epson paper, you can print using **Standard** or **Normal** print quality. Even if the printer driver allows you to choose a higher print quality, your product uses **Standard** or **Normal** print quality.

**Parent topic:** [Loading Paper](#)

**Related references**

[Paper Specifications](#)

## Double-sided Printing Capacity

### Automatic Double-sided Printing

You can automatically print double-sided from any paper source on the following sizes of standard paper:

- Letter (8.5 × 11 inches [216 × 279 mm])
- A4 (8.3 × 11.7 inches [210 × 297 mm])
- Executive (7.25 × 10.5 inches [184 × 267 mm])
- A5 (5.8 × 8.2 inches [148 × 210 mm])

- B5 (7.2 × 10.1 inches [182 × 257 mm])
- Mexico-Oficio (8.5 × 13.4 inches [216 × 340 mm])
- Oficio 9 (8.46 × 12.4 inches [215 × 315 mm])

**Note:** You can automatically print double-sided on thick paper in supported sizes from cassette 1 or the rear paper feed slot (paper tray) only.

### Manual Double-sided Printing

You can use the rear paper feed to manually print double-sided pages on the following papers:

Paper type	Size	Manual double-sided printing capacity
Plain paper Copier paper Letterhead paper Recycled paper Colored paper Pre-printed paper High quality plain paper	Supported paper sizes <sup>1</sup>	30 sheets
Epson Bright White Paper Epson Bright White Premium Paper Epson Multipurpose Plus Paper	Letter (8.5 × 11 inches [216 × 279 mm])	30 sheets
Thick paper 1 (25 to 43 lb [91 to 160 g/m <sup>2</sup> ])	Supported paper sizes <sup>1</sup>	10 sheets
Thick paper 2 (43 to 68 lb [161 to 256 g/m <sup>2</sup> ])	User defined <sup>2</sup>	1 sheet

<sup>1</sup>: Select the paper specification link below to view the list of supported paper sizes.

<sup>2</sup>: Available only when printing from a computer.

**Parent topic:** [Loading Paper](#)

## Related references

[Paper Specifications](#)

## Compatible Epson Papers

You can purchase genuine Epson ink, maintenance boxes, and paper at [epson.com](http://epson.com) (U.S. sales), [epson.ca](http://epson.ca) (Canadian sales), or [latin.epson.com](http://latin.epson.com) (Latin American sales). You can also purchase supplies from an Epson authorized reseller. To find the nearest one, call 800-GO-EPSON (800-463-7766) in the U.S. or 800-807-7766 in Canada.

**Note:** Paper/media availability varies by country.

Paper Type	Size	Part number	Sheet count
Epson Bright White Pro Paper	Letter (8.5 × 11 inches [216 × 279 mm])	S041586	500
Epson Bright White Premium Paper	Letter (8.5 × 11 inches [216 × 279 mm])	S450218	500
Epson Multipurpose Plus Paper	Letter (8.5 × 11 inches [216 × 279 mm])	S450217	500
Epson Presentation Paper Matte	Legal (8.5 × 14 inches [216 × 356 mm])	S041067	100
	Letter (8.5 × 11 inches [216 × 279 mm])	S041062	100
Epson Premium Presentation Paper Matte	8 × 10 inches (203 × 254 mm)	S041467	50
	Letter (8.5 × 11 inches [216 × 279 mm])	S041257 S042180	50 100
Epson Photo Paper Glossy	Letter (8.5 × 11 inches [216 × 279 mm])	S041141	20
		S041649	50
		S041271	100
Epson Premium Photo Paper Glossy	8 × 10 inches (203 × 254 mm) Letter (8.5 × 11 inches [216 × 279 mm])	S041465	20
		S042183	25
		S041667	50

Paper Type	Size	Part number	Sheet count
Epson Ultra Premium Photo Paper Glossy	8 × 10 inches (203 × 254 mm)	S041946	20
	Letter (8.5 × 11 inches [216 × 279 mm])	S042182	25
		S042175	50
Epson Premium Photo Paper Semi-gloss	Letter (8.5 × 11 inches [216 × 279 mm])	S041331	20

Parent topic: [Loading Paper](#)

## Paper or Media Type Settings - Printing Software

For this paper	Select this paper Type or Media Type setting
Plain paper Epson Bright White Paper Epson Bright White Premium Paper Epson Multipurpose Plus Paper	Plain Paper / Bright White Paper
High-quality plain paper	High-Quality Plain Paper
Letterhead paper	Letterhead
Recycled paper	Recycled
Colored paper	Color
Pre-printed paper	Preprinted
Envelopes	Envelope
Epson Ultra Premium Photo Paper Glossy	Ultra Premium Photo Paper Glossy
Epson Premium Photo Paper Glossy	Premium Photo Paper Glossy
Epson Photo Paper Glossy	Photo Paper Glossy
Epson Premium Photo Paper Semi-gloss	Premium Photo Paper Semi-Gloss
Epson Presentation Paper Matte Epson Premium Presentation Paper Matte	Premium Presentation Paper Matte
Thick paper (25 to 40 lb [91 to 150 g/m <sup>2</sup> ])	Card Stock 1

For this paper	Select this paper Type or Media Type setting
Thick paper (40 to 53 lb [151 to 200 g/m <sup>2</sup> ])	Card Stock 2
Thick paper (53 to 68 lb [201 to 256 g/m <sup>2</sup> ])	Card Stock 3

**Note:** The settings listed here are available only when printing from your computer; they do not apply to your product's control panel settings.

Parent topic: [Loading Paper](#)

## Selecting the Paper Settings for Each Source - Control Panel

You can change the default paper size and paper type for each source using the control panel on the product.

1. Press the  **Paper Setting** button.

You see a screen like this:

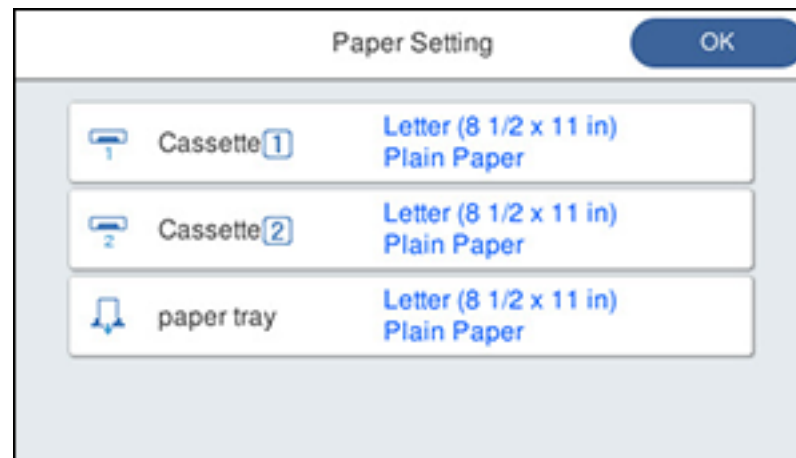

2. Select a paper source.
3. Select the size and type of paper you loaded.
4. Select the back arrow to select another paper source or press the  home button to return to the Home screen.

## Paper Type Settings - Control Panel

Select a **Paper Type** setting that matches the paper you loaded.

Paper type loaded	Paper Type setting
Plain paper Epson Bright White Paper Epson Bright White Premium Paper Epson Multipurpose Plus Paper	Plain Paper
Letterhead paper	Letterhead
Recycled paper	Recycled
Colored paper	Color
Pre-printed paper	Preprinted
High-quality plain paper	High Quality Plain Paper
Envelopes	Envelope
Epson Ultra Premium Photo Paper Glossy	Ultra Glossy
Epson Premium Photo Paper Glossy	Prem. Glossy
Epson Photo Paper Glossy	Glossy
Epson Premium Photo Paper Semi-gloss	Prem. Semi-Gloss
Epson Presentation Paper Matte Epson Premium Presentation Paper Matte	Prem. Matte
Thick paper (25 to 40 lb [91 to 150 g/m <sup>2</sup> ])	Card Stock 1
Thick paper (40 to 53 lb [151 to 200 g/m <sup>2</sup> ])	Card Stock 2
Thick paper (53 to 68 lb [201 to 256 g/m <sup>2</sup> ])	Card Stock 3



## Selecting Default Paper Settings - Administrator

As an administrator, you can adjust default paper settings that apply to all print jobs sent to the product.

**Note:** These settings can be locked by an administrator. If you cannot access these settings, contact your administrator for assistance.

[Selecting the Default Printer Settings](#)



[Selecting the Universal Print Settings](#)

**Parent topic:** [Loading Paper](#)

## Selecting the Default Printer Settings

You can change default printer settings using the control panel on the product.

**Note:** These settings can be locked by an administrator. If you cannot access these settings, contact your administrator for assistance.

1. Press the  home button, if necessary.
2. Select **Settings > General Settings > Printer Settings**.
3. Select one of these options for the **Auto Error Solver** setting:
  - Turn on this setting to display a warning and print single-sided when a 2-sided printing error occurs, or to print only what the printer could process when a full memory error occurs.
  - Turn off this setting to display an error message and stop printing if an error occurs.
4. Select **Paper Source Settings**.
5. Select the Paper Source Settings options you want to use.
6. When you are finished, press the  home button to return to the Home screen.

[Paper Source Settings Options](#)

**Parent topic:** [Selecting Default Paper Settings - Administrator](#)

## Paper Source Settings Options

Select the paper source options you want to use for your print jobs.

Paper Source Settings option	Available settings	Description
<b>Paper Setting</b>	Various	Select the paper size and type for each paper source
<b>Rear Paper Feed Priority</b>	<b>On</b>	Select <b>On</b> to give printing priority to paper loaded in the rear paper feed slot
	<b>Off</b>	
<b>A4/Letter Auto Switching</b>	<b>On</b>	Select <b>On</b> to switch the selected paper size to match the loaded paper (Letter or A4) if the wrong size is selected
	<b>Off</b>	
<b>Auto Select Settings</b>	<b>Copy</b>	Select <b>On</b> for any of these settings to automatically print on paper from any source containing paper that matches your paper settings
	<b>Fax</b>	
	<b>Other</b>	
<b>Error Notice</b>	<b>Paper Size Notice</b>	Select <b>On</b> for either of these settings to display an error message when the selected paper type or size does not match the loaded paper
	<b>Paper Type Notice</b>	
<b>Paper Setup Auto Display</b>	<b>On</b>	Select <b>On</b> to automatically display a menu that lets you select the paper size and type when you load paper in the product  <b>Note:</b> If you disable this setting, you will not be able to print using AirPrint.
	<b>Off</b>	

Parent topic: [Selecting the Default Printer Settings](#)

## Selecting the Universal Print Settings

You can change the default universal print settings using the control panel on the product.

**Note:** These settings can be locked by an administrator. If you cannot access these settings, contact your administrator for assistance.

1. Press the  home button, if necessary.
2. Select **Settings** > **General Settings** > **Printer Settings** > **Universal Print Settings**.

You see a screen like this:



3. Adjust the settings as necessary.
4. When you are finished, press the  home button to return to the Home screen.

[Universal Print Settings Options](#)

**Parent topic:** [Selecting Default Paper Settings - Administrator](#)

### Universal Print Settings Options

Select the universal print setting options you want to use for your print jobs.

Universal Print Settings option	Available settings	Description
Top Offset	—	Adjust the top or left margin
Left Offset		
Top Offset in Back	—	Adjust the top or left margin of the back page when printing double-sided
Left Offset in Back		
Check Paper Width	On	Select <b>On</b> to check the paper width before printing. This prevents printing beyond the edges of the paper when the paper size settings are incorrect, but may reduce the printing speed.
	Off	

Universal Print Settings option	Available settings	Description
Skip Blank Page	On	Select <b>On</b> to skip printing of blank pages automatically
	Off	

Parent topic: [Selecting the Universal Print Settings](#)

---

## Placing Originals on the Product

Follow the instructions here to place your original documents or photos on the product.

**Caution:** Do not place anything on top of your product or use its cover as a writing surface to avoid damaging it.

[Placing Originals on the Scanner Glass](#)

[Placing Originals in the Automatic Document Feeder](#)

## Placing Originals on the Scanner Glass

You can place originals up to this size on the scanner glass: A3 (11.7 × 16.5 inches [297 × 420 mm]).

**Note:** To view animated instructions on how to place originals on the scanner glass, press the  help button and select **How To > Place Originals > Scanner Glass**.

**Note:** When originals are placed in the ADF and on the scanner glass, priority is given to the originals in the ADF.

1. Open the document cover.

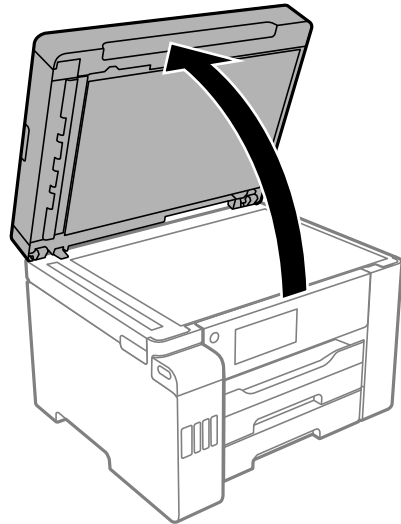

2. Place your original facedown on the scanner glass with the top facing into the corner. Slide the original to the edges of the indicated corner.

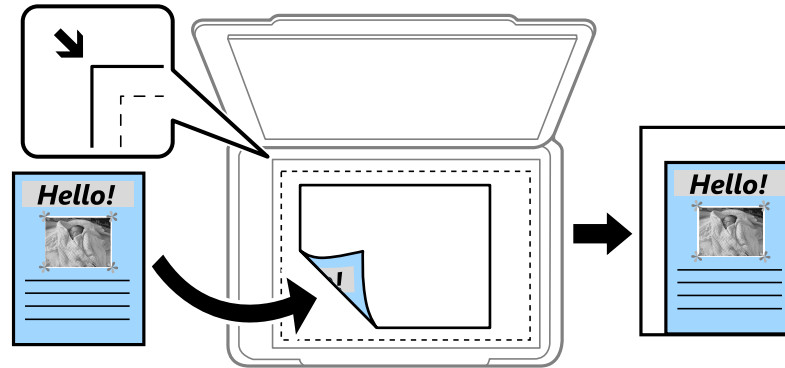

**Note:** The edges of your original may be cropped by 0.06 inch (1.5 mm) from the edge of the scanner glass. Manually position your original away from the edges to prevent cropping.

3. Close the document cover gently to keep your original in place.

**Caution:** Do not push down on the document cover or scanner glass or you may damage the product.

Remove your originals after scanning. If you leave the originals on the scanner glass for a long time, they may stick to the glass surface.

**Parent topic:** [Placing Originals on the Product](#)

#### **Related topics**

[Scanning](#)

[Copying](#)

[Faxing](#)

## **Placing Originals in the Automatic Document Feeder**

You can place single- or multi-page original documents in the Automatic Document Feeder (ADF). You can also use the ADF to scan both sides of a 2-sided document. Make sure the originals meet the Automatic Document Feeder specifications before loading them.

**Caution:** Make sure your originals are not creased or folded, and do not contain holes, staples, tape, or other materials that could obstruct the feeder.

**Caution:** Do not place photographs or valuable artwork in the ADF. Place fragile or valuable originals on the scanner glass to avoid wrinkling or damaging them.

**Note:** To view animated instructions on how to place originals in the ADF, press the  help button and select **How To > Place Originals > ADF**.

**Note:** When originals are placed in the ADF and on the scanner glass, priority is given to the originals in the ADF.

1. Slide the ADF edge guides outward.

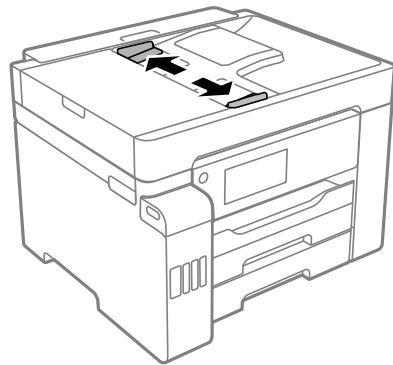

2. Fan your stack of originals and tap them gently on a flat surface to even the edges.

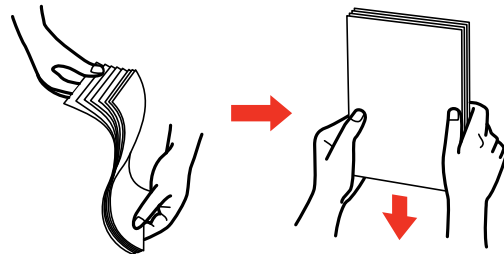

3. Insert the originals into the ADF faceup and short edge first.

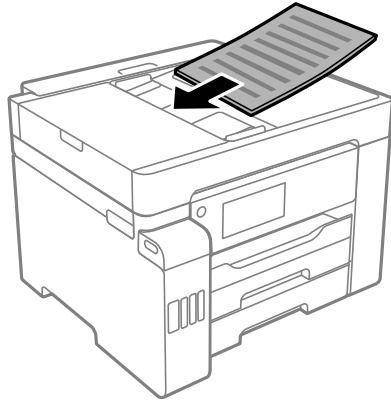

**Note:** Do not load originals above the arrow mark on the ADF edge guide.

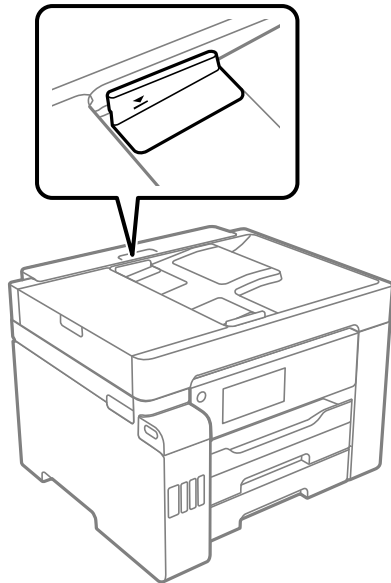

The **ADF** icon on the Copy, Scan, and Fax screens lights up.



4. Slide the ADF edge guides against the originals, but not too tightly.

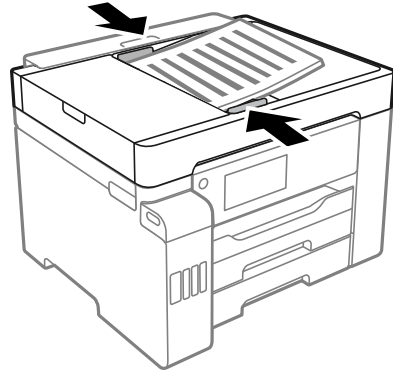

**Parent topic:** [Placing Originals on the Product](#)

**Related topics**

[Scanning](#)

[Copying](#)

[Faxing](#)

---

# Copying

See the information here to copy documents or photos using your product.

**Note:** Copies may not be exactly the same size as your originals.

[Copying Documents or Photos](#)

[Copying Options](#)

## Copying Documents or Photos

You can copy documents or photos onto various sizes and types of paper, including Epson special papers.

1. Place your original document or photo on the scanner glass, or in the ADF.
2. Load the paper you want to print on.
3. Press the  home button, if necessary.
4. Select **Copy**.

You see a screen like this:

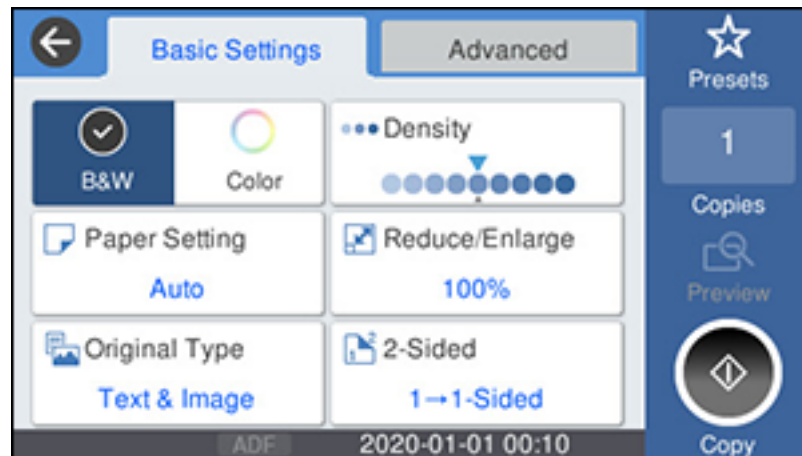

5. To print more than one copy, press a number key on the product's control panel, or select **Copies** and use the displayed keypad to enter the number of copies.

6. Change any of the displayed settings as necessary.
7. Select **Advanced** to view and change additional copy settings, if necessary.
8. Select **Preview** to preview your copy on the LCD screen.
9. Select **Presets** to save your copy settings.

**Note:** Presets can be locked by an administrator. If you can't access or change this setting, contact your administrator for assistance.

10. When you are ready to copy, press the **Copy** icon.

**Note:** To cancel printing, press the  stop button or select **Cancel**.

**Parent topic:** [Copying](#)

**Related references**

[Copying Options](#)

**Related tasks**

[Using Presets](#)

**Related topics**

[Loading Paper](#)

[Placing Originals on the Product](#)

## Copying Options

Select the copying options you want to use for your copies.

**Note:** Not all options or settings may be available, depending on other copying settings.

**Basic Settings**

Copying option	Available settings	Description
<b>B&amp;W</b>	—	Copies the document in black and white
<b>Color</b>	—	Copies the document in color

Copying option	Available settings	Description
<b>Paper Setting</b>	Various sources	Select the paper source that you want to use. If you select <b>Auto</b> , paper is fed automatically depending on the paper settings you selected for the paper sources.
<b>Original Type</b>	<b>Text</b>	Specifies the document type of your originals and adjusts the quality of your copies
	<b>Text &amp; Image</b>	
	<b>Photo</b>	
	<b>Text &amp; Image(Best)</b>	
<b>Density</b>	Varying levels	Adjusts the lightness or darkness of copies
<b>Reduce/Enlarge</b>	<b>Reduce to Fit Paper</b>	Automatically sizes the image to fit the paper size you selected
	<b>100%</b>	Copies the original at its full size
	<b>195%-&gt;45% and other conversions</b>	Automatically converts from one size to another
	<b>%</b>	Automatically increases or decreases the size of the image by the percentage you enter (range is 25% to 400%)
<b>2-Sided</b>	<b>1&gt;1-Sided</b>	Select to make 2-sided copies. When you select <b>1&gt;2-Sided</b> or <b>2&gt;1-Sided</b> , also select the orientation and binding edge for your originals or copies.
	<b>2&gt;2-Sided</b>	
	<b>1&gt;2-Sided</b>	
	<b>2&gt;1-Sided</b>	

#### Advanced settings

Copying option	Available settings	Description
<b>Multi-Page</b>	<b>Single Page</b>	Copies each page of the original onto an individual sheet
	<b>2-up</b>	Copies multiple page documents onto one sheet. Scroll down and select the document orientation and layout order settings as necessary.
	<b>4-up</b>	
<b>Original Size</b>	Various sizes	Select the document size of your original

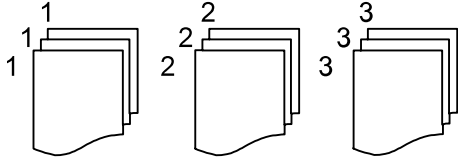
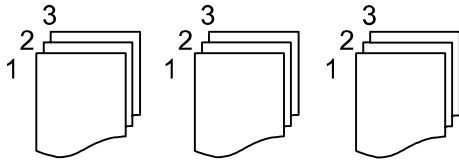
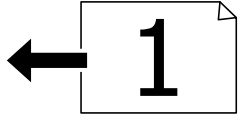
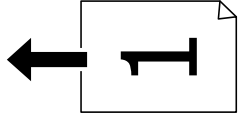
Copying option	Available settings	Description
<b>Finishing</b>	<b>Group (Same Pages)</b>	Select to print multiple copies of a multi-page document in unordered groups  
	<b>Collate (Page Order)</b>	Select to print multiple copies of a multi-page document in ordered sets  
<b>Mixed Size Originals</b>	<b>Off</b>	Select <b>On</b> to copy originals of varying sizes in their original sizes
	<b>On</b>	
<b>Orientation (Original)</b>	<b>Readable Direction</b>	Specifies the orientation of your originals
	<b>Left Direction</b>	<b>Readable Direction:</b>  <b>Left Direction:</b> 
<b>Image Quality</b>	Various settings	Select advanced quality settings such as <b>Saturation</b> and <b>Sharpness</b>
<b>Binding Margin</b>	<b>Off</b>	Select <b>On</b> to adjust the margin and orientation of the pages when copying a book
	<b>On</b>	

Copying option	Available settings	Description
<b>Reduce to Fit Paper</b>	<b>Off</b>	Select <b>On</b> to automatically decrease the image by the percentage you select
	<b>On</b>	
<b>Remove Shadow</b>	<b>Off</b>	Select <b>On</b> to erase the shadows that appear in the center of a document when copying a book or that appear around a document when copying thick paper
	<b>On</b>	
<b>Remove Punch Holes</b>	<b>Off</b>	Select <b>On</b> to erase the binding holes on a document
	<b>On</b>	
<b>ID Card Copy</b>	<b>Off</b>	Select <b>On</b> to copy both sides of an ID card onto one side of a sheet of paper
	<b>On</b>	

Parent topic: [Copying](#)

---

# Printing from a Computer

Before printing from your computer, make sure you have set up your product and installed its software as described on the *Start Here* sheet.

**Note:** If you have an Internet connection, it is a good idea to check for updates to your product software on Epson's support website. If you see a Software Update screen, select **Enable automatic checking** and click **OK**. The update scans your system to see if you have the latest product software. Follow the on-screen instructions.

[Printing with the Standard Epson Printer Software - Windows](#)

[Printing with the Built-in Epson Driver - Windows 10 S](#)

[Printing with the Epson Standard Printer Software - Mac](#)

[Setting Up Printing on a Chromebook](#)

[Printing with the PCL Printer Software - Windows](#)

[Printing with the PostScript \(PS3\) Printer Software - Windows](#)

[Printing with the PostScript \(PS3\) Printer Software - Mac](#)

[Cancelling Printing Using a Product Button](#)

## Printing with the Standard Epson Printer Software - Windows

You can print with the standard Epson printer software using any Windows printing program, as described in these sections.

**Note:** If you are using your Epson product with the Windows 10 S operating system, you cannot use the software described in this section. You also cannot download and install any Epson product software from the Epson website for use with Windows 10 S; you must obtain software only from the Windows Store.

[Selecting Basic Print Settings - Windows](#)

[Selecting Double-sided Printing Settings - Windows](#)

[Selecting Additional Layout and Print Options - Windows](#)

[Selecting a Printing Preset - Windows](#)

[Selecting Extended Settings - Windows](#)

[Printing Your Document or Photo - Windows](#)

[Locking Printer Settings - Windows](#)

[Entering a User ID and Password for Printing](#)

[Selecting Default Print Settings - Windows](#)

[Changing Automatic Update Options](#)

**Parent topic:** [Printing from a Computer](#)

## Selecting Basic Print Settings - Windows

Select the basic settings for the document or photo you want to print.

1. Open a photo or document for printing.
2. Select the print command in your application.

**Note:** You may need to select a print icon on your screen, the **Print** option in the **File** menu, or another command. See your application's help utility for details.

3. If necessary, select your product name as the printer you want to use.

**Note:** You may also need to select **Properties** or **Preferences** to view your print settings.



You see the Main tab of your printer settings window:

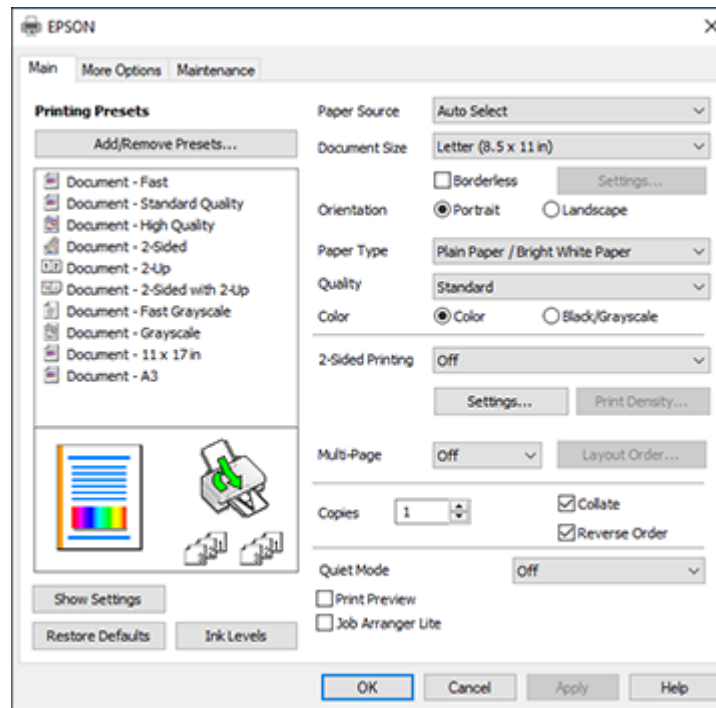

4. For the **Paper Source** setting, select where you loaded the paper you want to print on.
5. Select the size of the paper you loaded as the **Document Size** setting.

**Note:** You can also select the **User-Defined** setting to create a custom paper size.

6. If you are printing a borderless photo, select **Borderless**. You can click **Settings** to access additional options for borderless printing.

**Note:** You must select a compatible borderless paper type and size to print without borders. Check the borderless paper compatibility list for details.

7. Select the orientation of your document.

**Note:** If you are printing an envelope, select **Landscape**.

8. Select the type of paper you loaded as the **Paper Type** setting.

**Note:** The setting may not exactly match the name of your paper. Check the paper type settings list for details.

9. Select the **Quality** setting that matches the print quality you want to use.

10. Select a Color option:

- To print a color document or photo, select the **Color** setting.
- To print text and graphics in black or shades of gray, select the **Black/Grayscale** setting.

11. To print on both sides of the paper, select a **2-Sided Printing** option.

12. To print multiple pages on one sheet of paper, or print one image on multiple sheets of paper, select one of the settings in the **Multi-Page** menu and select the printing options you want.

13. To print multiple copies and arrange their print order, select the **Copies** options.

14. To reduce noise during printing, turn on **Quiet Mode** (printing will be slower).

15. To preview your job before printing, select **Print Preview**.

16. To save your print job as a project that can be modified and combined with other print jobs, select **Job Arranger Lite**.

[Paper Source Options - Windows](#)

[Print Quality Options - Windows](#)

[Multi-Page Printing Options - Windows](#)

**Parent topic:** [Printing with the Standard Epson Printer Software - Windows](#)

#### **Related references**

[Paper or Media Type Settings - Printing Software](#)

[Double-sided Printing Capacity](#)

#### **Related tasks**

[Entering a User ID and Password for Printing](#)

[Printing Your Document or Photo - Windows](#)

## Paper Source Options - Windows

You can select any of the available options in the Paper Source menu to print on the paper loaded in that source.

### **Auto Select**

Automatically selects the paper source based on the selected paper size.

### **Paper Cassette 1**

Selects the paper in cassette 1 as the paper source.

### **Paper Cassette 2**

Selects the paper in cassette 2 as the paper source.

### **Paper Tray**

Selects the paper in the rear feed as the paper source.

**Parent topic:** [Selecting Basic Print Settings - Windows](#)

## Print Quality Options - Windows

You can select any of the available Quality options to fine-tune the quality of your print. Some settings may be unavailable, depending on the paper type and border setting you have chosen.

### **Draft**

For draft printing on plain paper.

### **Standard**

For everyday text and image printing.

### **Standard - Vivid**

For text and graphics with good quality and print speed.

### **High**

For photos and graphics with high print quality.

### **More Settings**

Opens a window that lets you choose among levels of speed and quality.

**Parent topic:** [Selecting Basic Print Settings - Windows](#)

## Multi-Page Printing Options - Windows

You can select any of the available options in the Multi-Page menu to set up your multi-page print job.

### **2-Up, 4-Up, 6-Up, 8-Up, 9-Up, and 16-Up**

Prints several pages on one sheet of paper. Click the **Layout Order** button to select page layout and border options.

### **2×1 Poster, 2×2 Poster, 3×3 Poster, 4×4 Poster**

Prints one image on multiple sheets of paper to create a larger poster. Click the **Settings** button to select image layout and guideline options.

**Parent topic:** [Selecting Basic Print Settings - Windows](#)

## **Selecting Double-sided Printing Settings - Windows**

You can print on both sides of the paper by selecting one of the **2-Sided Printing** options on the **Main** tab.

**Note:** Some options may be pre-selected or unavailable, depending on other settings you have chosen or if you are accessing the product over a network.



1. Select one of the following options for **2-Sided Printing**:
  - **Auto (Long-edge binding)** to print your double-sided print job by automatically flipping the paper on the long edge.
  - **Auto (Short-edge binding)** to print your double-sided print job by automatically flipping the paper on the short edge.
  - **Manual (Long-edge binding)** to print your double-sided print job by printing one side and prompting you to flip the paper over on the long edge to print the other side (recommended for paper types that do not support automatic duplexing).
2. Click the **Settings** button.

You see this window:

Binding Settings

Binding Edge

Left Long-edge     Top Short-edge     Right Long-edge

Binding Margin

Front Page    0.00 [0.00 ... 1.18]

Back Page    0.00 [0.00 ... 1.18]

Unit     mm     inch



Start Page

From Front     From Back

Create Folded Booklet

Booklet

Center Binding     Side Binding

    

OK    Cancel    Help

3. Select the double-sided printing options you want to use.
4. Click **OK** to return to the **Main** tab.

5. Click the **Print Density** button.

You see this window:

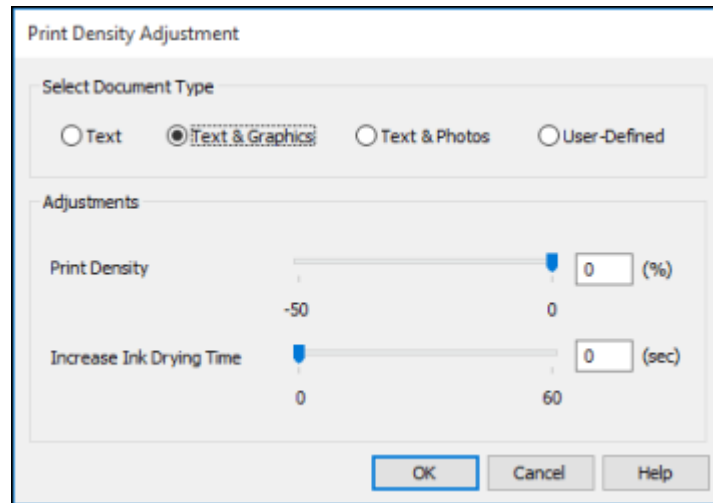

6. Select the type of document you are printing as the Document Type setting. The software automatically sets the **Adjustments** options for that document type.
7. If necessary, select the **Adjustments** options you want to use.
8. Click **OK** to return to the **Main** tab.
9. Print a test copy of your double-sided document to test the selected settings.
10. Follow any instructions displayed on the screen during printing.

[Double-sided Printing Options - Windows](#)

[Print Density Adjustments - Windows](#)

**Parent topic:** [Printing with the Standard Epson Printer Software - Windows](#)

#### **Related references**

[Double-sided Printing Capacity](#)

#### **Related tasks**

[Selecting Basic Print Settings - Windows](#)

## **Double-sided Printing Options - Windows**

You can select any of the available options on the 2-Sided Printing Settings window to set up your double-sided print job.

### **Binding Edge Options**

Select a setting that orients double-sided print binding in the desired direction.

### **Binding Margin Options**

Select options that define a wider margin to allow for binding.

### **Start Page**

Selects whether printing starts on the front or back page.

### **Create Folded Booklet Options**

Select the **Booklet** checkbox and a binding option to print double-sided pages as a booklet.

**Parent topic:** [Selecting Double-sided Printing Settings - Windows](#)

## **Print Density Adjustments - Windows**

You can select any of the available options on the Print Density Adjustment window to adjust the print quality of your double-sided print job.

### **Print Density**

Sets the level of ink coverage for double-sided printing.

### **Increase Ink Drying Time**

Sets the amount of time required for drying ink after printing on one side of the paper before printing the other side in double-sided printing to prevent ink smearing.

**Parent topic:** [Selecting Double-sided Printing Settings - Windows](#)

## Selecting Additional Layout and Print Options - Windows

You can select a variety of additional layout and printing options for your document or photo on the **More Options** tab.

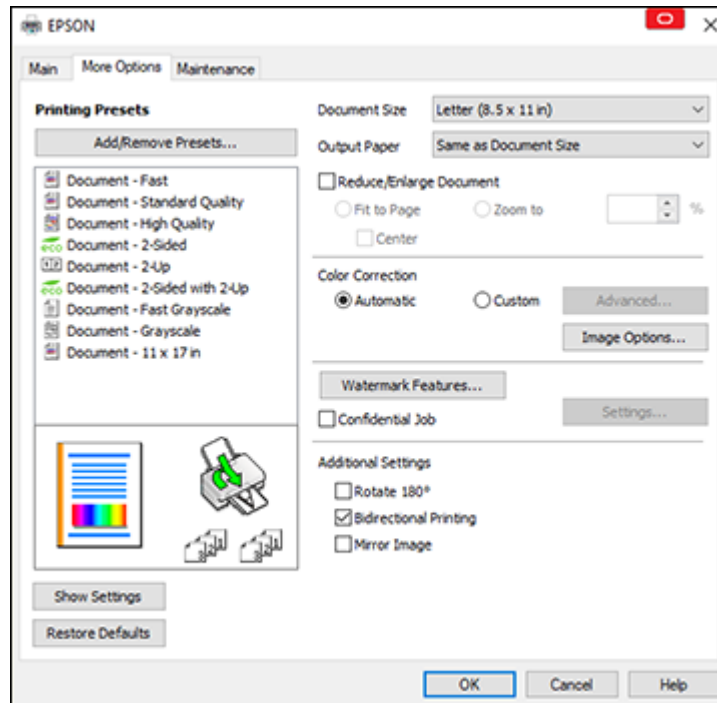

1. To change the size of your printed document or photo, select the **Reduce/Enlarge Document** checkbox and select one of these sizing options:
  - Select the **Fit to Page** option to size your image to fit the paper you loaded. Select the size of your document or photo as the **Document Size** setting, and the size of your paper as the **Output Paper** setting. If you want to center your image on the paper, select the **Center** option.
  - Select the **Zoom to** option to reduce or enlarge your document or photo by a specific percentage. Select the percentage in the % menu.
2. Select one of the following Color Correction options:
  - Select **Automatic** to automatically adjust the sharpness, brightness, contrast, and color saturation for your image.



- Select **Custom** and click the **Advanced** button to manually adjust the color correction settings or turn off color management in your printer software.
  - Select **Image Options** to access additional settings for improving printed images.
3. To add the following features, click the **Watermark Features** button:
- **Watermark**: adds a visible watermark to your printout
  - **Header/Footer**: adds information such as the date and time to the top or bottom of your printout

**Note:** Click the **Settings** button to customize the text and location of the header or footer.

4. To add a password to your print job, select the **Confidential Job** checkbox, then enter a password. Confidential jobs are stored in the product's memory without being printed. To print the job, enter the password for the confidential job on the product's control panel.

**Note:** Confidential print jobs are cleared from the product's memory after printing.

5. Select any of the Additional Settings options to customize your print.

[Custom Color Correction Options - Windows](#)

[Image Options and Additional Settings - Windows](#)

[Header/Footer Settings - Windows](#)

**Parent topic:** [Printing with the Standard Epson Printer Software - Windows](#)

#### **Related tasks**

[Printing Your Document or Photo - Windows](#)

## Custom Color Correction Options - Windows

You can select any of the available options in the Color Correction window to customize the image colors for your print job.

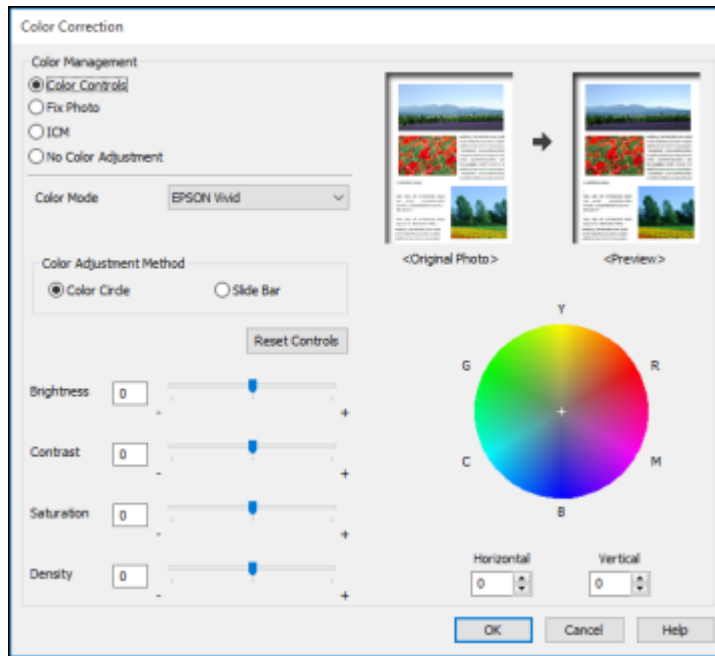

### Color Controls

Lets you select a **Color Mode** setting, individual settings for **Brightness**, **Contrast**, **Saturation**, and **Density**, and individual color tones. Depending on the selected color mode, you can also adjust the midtone density using the **Gamma** setting.

### Fix Photo

Improves the color, contrast, and sharpness of flawed photos.

**Note:** Fix Photo uses a sophisticated face recognition technology to optimize photos that include faces. For this to work, both eyes and the nose must be visible in the subject's face. If your photo includes a face with an intentional color cast, such as a statue, you may want to turn off **Fix Photo** to retain the special color effects.

**ICM**

Lets you manage color using installed color printing profiles.

**No Color Adjustment**

Turns off color management in your printer software so you can manage color using only your application software.

**Parent topic:** [Selecting Additional Layout and Print Options - Windows](#)

**Image Options and Additional Settings - Windows**

You can select any of the Image Options and Additional Settings to customize your print. Some options may be pre-selected or unavailable, depending on other settings you have chosen.

**Image Options****Emphasize Text**

Adjusts the weight of printed text to increase readability.

**Emphasize Thin Lines**

Adjusts the weight of printed lines to increase visibility.

**Edge Smoothing**

Smooths jagged edges in low-resolution images such as screen captures or images from the Web.

**Fix Red-Eye**

Reduces or removes red-eye in photos.

**Additional Settings Options****Rotate 180°**

Prints the image rotated 180° from its original orientation.

**Bidirectional Printing**

Prints in both directions (right-to-left and left-to-right), speeding up printing, but may reduce print quality.

**Mirror Image**

Flips the printed image left to right.

**Parent topic:** [Selecting Additional Layout and Print Options - Windows](#)

**Header/Footer Settings - Windows**

You can select any of the Header/Footer Settings options to add headers or footers when you print. The items are available to print at the top or bottom of your pages, in either the left, right, or center of the page.

**Note:** These settings are not saved with your document.

**Header/Footer Settings**

Top Left	Top Center	Top Right
User Name	None	Date/Time
Bottom Left	Bottom Center	Bottom Right
None	None	None

Starting number: 1

Start printing on page: 1

Text:

Color: Black

Font: Arial

Size: 11 pt [6 ... 72]

Style: Bold, Italic

Buttons: Reset Defaults, OK, Cancel, Help

You can select to print the following information:

- User Name
- Computer Name
- Date
- Date/Time
- Document Name
- Collate Number
- Page Number

- Text

You can also adjust the text settings for the printed information.

**Note:** The user name, computer name, date, and time come from the Windows Control Panel on your computer.

**Parent topic:** [Selecting Additional Layout and Print Options - Windows](#)

## Selecting a Printing Preset - Windows

For quick access to common groups of print settings, you can select a printing preset on the **Main** or **More Options** tab.

**Note:** You can create your own preset by clicking the **Add/Remove Presets** button.

1. Click the **Main** or **More Options** tab.

You see the available **Printing Presets** on the left:

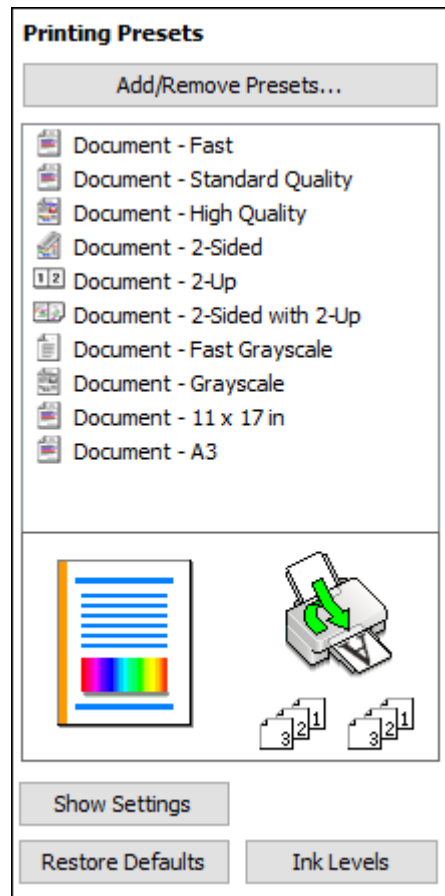



2. Place your cursor over one of the **Printing Presets** to view its list of settings.
3. Click on a preset to change its settings or delete it, or use any of the available options on the screen to control your printing presets.
4. To choose a preset for printing, select it.
5. Click **OK**.

**Parent topic:** [Printing with the Standard Epson Printer Software - Windows](#)

## Selecting Extended Settings - Windows

You can select additional settings that apply to all the print jobs you send to your product.

1. Access the Windows Desktop and right-click the  icon for your product in the right side of the Windows taskbar, or click the up arrow and right-click .
2. Select **Printer Settings**.
3. Click the **Maintenance** tab.

You see the maintenance options:

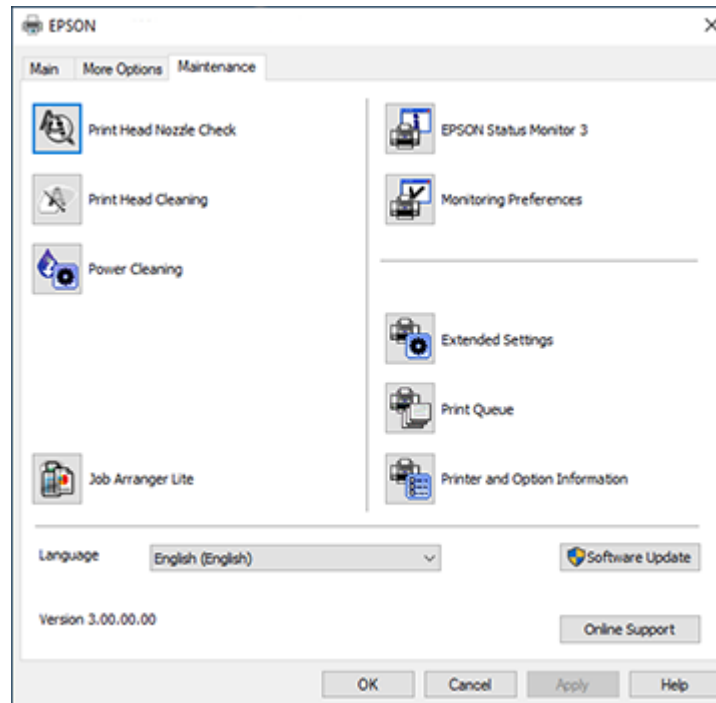

4. Click the **Extended Settings** button.

You see this window:

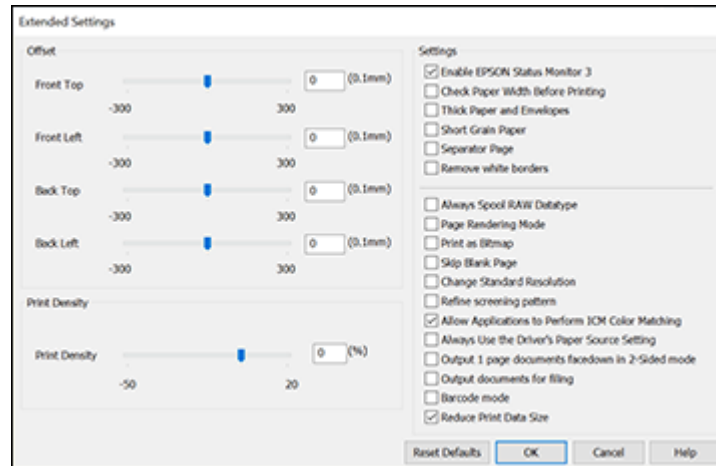

5. Select any of the extended settings to customize your print.
6. Click **OK** to close the Extended Settings window.
7. Click **OK** to close the printer software window.

### [Extended Settings - Windows](#)

**Parent topic:** [Printing with the Standard Epson Printer Software - Windows](#)

## **Extended Settings - Windows**

You can select these settings on the Extended Settings window.

### **Enable EPSON Status Monitor 3**

Enables product monitoring for ink and paper supplies and other issues.

### **Check Paper Width Before Printing**

Prevents printing beyond the edges of the paper if the paper size setting is incorrect; may reduce print speed.

### **Thick Paper and Envelopes**

Prevents ink from smearing when you print on envelopes or other thick paper.

### **Short Grain Paper**

Prevents ink from smearing when you print on envelopes or other thick paper, and the **Thick Paper** setting does not help.

### **Separator Page**

Before each document, prints a separator page containing the title, user, date, and time.



**Remove white borders**

Removes white margins that may appear when you print borderless photos.

**Always Spool RAW Datatype**

Increases print speed and may solve other printing problems.

**Page Rendering Mode**

Increases print speed when printing is extremely slow or the print head stops during printing.

**Print as Bitmap**

Increases print speed when printing is extremely slow or the print head stops during printing, and other settings do not help.

**Skip Blank Page**

Ensures that your product does not print pages that contain no text or images.

**Change Standard Resolution**

Reduces the resolution of print data to correct printing problems.

**Refine screening pattern**

Prints graphics with a finer screening pattern.

**Allow Applications to Perform ICM Color Matching**

Allows applications to perform ICM color matching.

**Always Use the Driver's Paper Source Setting**

Prints using the paper source setting in the printer driver, rather than the setting in your application.

**Output 1 page documents facedown in 2-Sided mode**

Outputs single-sided pages in a 2-sided print job facedown instead of faceup.

**Output documents for filing**

Outputs all landscape, portrait, 1-sided, and 2-sided documents in the same orientation for easier filing.

**Barcode mode**

Reduces bleeding when printing barcodes on plain paper, letterhead paper, recycled paper, preprinted paper, envelopes, and thick paper.

**Reduce Print Data Size**

Increases print data compression to improve print speed. Not recommended when printing fine patterns.

Parent topic: [Selecting Extended Settings - Windows](#)

## Printing Your Document or Photo - Windows

Once you have selected your print settings, you are ready to save your settings and print.

1. Click **OK** to save your settings.

You see your application's Print window, such as this one:

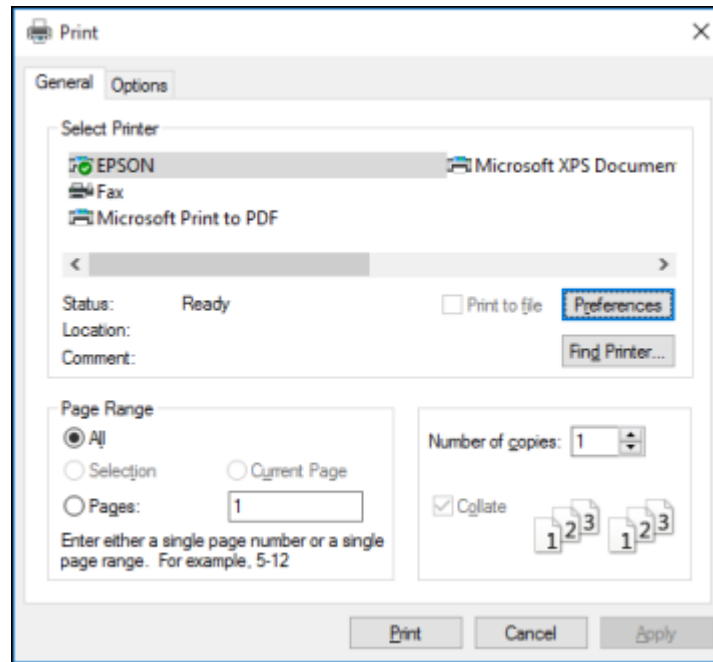



2. Click **OK** or **Print** to start printing.



**Parent topic:** [Printing with the Standard Epson Printer Software - Windows](#)

## Locking Printer Settings - Windows

Windows administrators can lock access to some printer settings to prevent unauthorized changes.

1. Do one of the following:

- **Windows 10:** Click  and select  (Settings) > **Devices** > **Printers & scanners**. Select your product name and select **Manage** > **Printer properties**.
- **Windows 8.x:** Navigate to the **Apps** screen and select **Control Panel** > **Hardware and Sound** > **Devices and Printers**. Right-click your product and select **Printer properties**.

- **Windows 7:** Click  and select **Devices and Printers**. Right-click your product and select **Printer properties**.
  - **Windows Vista:** Click  and select **Control Panel**. Click **Printer** under **Hardware and Sound**, then right-click your product and select **Properties**.
2. Click the **Optional Settings** tab.

**Note:** You can prevent access to the **Optional Settings** tab by changing the user or group permissions in the **Security** tab.

3. Click **Driver Settings**.

You see this window:

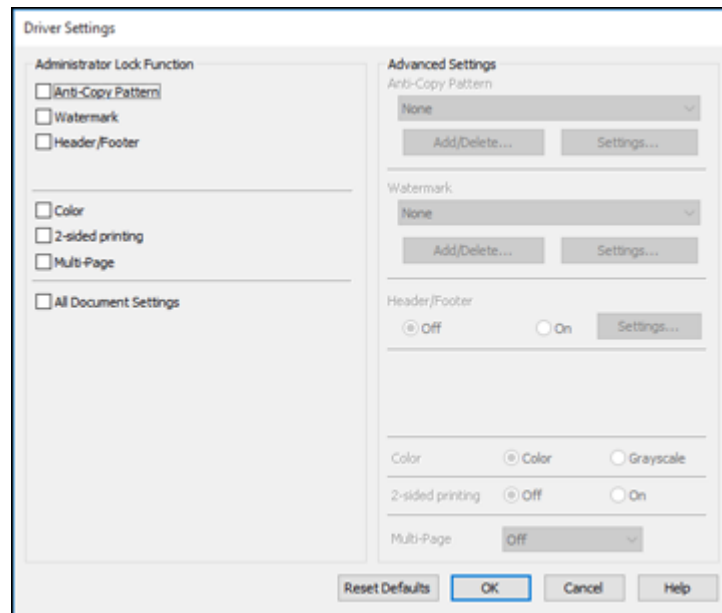

4. Select the checkbox for each setting you want to lock. To lock all print settings, select **All Document Settings**.
5. Under **Advanced Settings**, select the setting option you want to use for each locked setting.
6. Click **OK**.

## Locked Setting Options

**Parent topic:** [Printing with the Standard Epson Printer Software - Windows](#)

### Locked Setting Options

Select the options you want to use for any locked print settings.

Setting	Options	Description
<b>Anti-Copy Pattern</b>	Various data items	Lets you select the data to use for the pattern or prohibit anti-copy patterns
	<b>Add/Delete</b>	Lets you add or delete a customized anti-copy pattern
	<b>Settings</b>	Lets you select the arrangement, size, and other settings for the custom anti-copy pattern
<b>Watermark</b>	Various text watermarks	Lets you select the text for the watermark or prohibit watermarks
	<b>Add/Delete</b>	Lets you add or delete a customized text or image-based watermark
	<b>Settings</b>	Lets you select the size, position, and other watermark settings
<b>Header/Footer</b>	<b>Off</b>	Prohibits headers or footers
	<b>On</b>	Allows headers and footers
	<b>Settings</b>	Lets you select the text and position for printing headers and footers
<b>Color</b>	<b>Color</b>	Allows color printing
	<b>Grayscale</b>	Allows printing in black or shades of gray only
<b>2-sided printing</b>	<b>Off</b>	Allows printing on one side of the paper only
	<b>On</b>	Allows printing on both sides of the paper



Setting	Options	Description
<b>Multi-Page</b>	<b>Off</b>	Prohibits multi-page settings
	<b>2-Up</b>	Allows printing of 2 pages on one sheet of paper
	<b>4-Up</b>	Allows printing of 4 pages on one sheet of paper
	<b>6-Up</b>	Allows printing of 6 pages on one sheet of paper
	<b>8-Up</b>	Allows printing of 8 pages on one sheet of paper
	<b>9-Up</b>	Allows printing of 9 pages on one sheet of paper
	<b>16-Up</b>	Allows printing of 16 pages on one sheet of paper
<b>All Document Settings</b>	—	Lets you lock all print settings

Parent topic: [Locking Printer Settings - Windows](#)

## Entering a User ID and Password for Printing

If you enabled Access Control on the product, you must enter a user ID and password in the printer driver to be able to print.

**Note:** If you do not know the user ID or password, contact your administrator for assistance.

1. Access the Windows Desktop and right-click the  icon for your product in the right side of the Windows taskbar, or click the up arrow and right-click . Select **Printer Settings** and click the **Maintenance** tab.

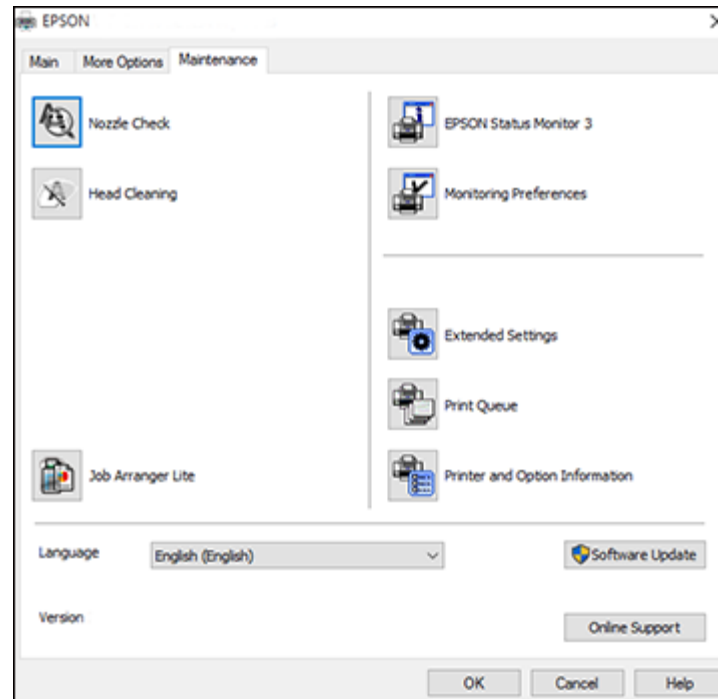



2. Click the **Printer and Option Information** button.
3. Select the **Save Access Control settings** checkbox.
4. Click the **Settings** button.
5. Enter your user name and password.
6. Click **OK**.

**Parent topic:** [Printing with the Standard Epson Printer Software - Windows](#)

## Selecting Default Print Settings - Windows

When you change your print settings in a program, the changes apply only while you are printing in that program session. If you want to change the print settings you use in all your Windows programs, you can select new default print settings.

1. Access the Windows Desktop and right-click the  icon for your product in the right side of the Windows taskbar, or click the up arrow and right-click .
2. Select **Printer Settings**.

You see the printer settings window:

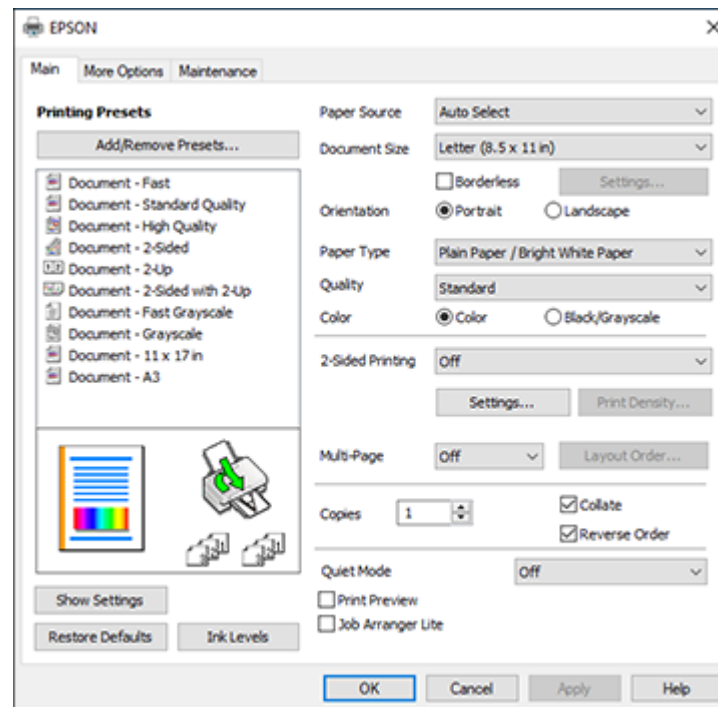

3. Select the print settings you want to use as defaults in all your Windows programs.
4. Click **OK**.



These settings are now the defaults selected for printing. You can still change them as needed for printing in any program session.

## Changing the Language of the Printer Software Screens

**Parent topic:** [Printing with the Standard Epson Printer Software - Windows](#)

### Changing the Language of the Printer Software Screens

You can change the language used on the Windows printer software screens.

1. Access the Windows Desktop and right-click the  icon for your product in the right side of the Windows taskbar, or click the up arrow and right-click .

2. Select **Printer Settings**.

You see the printer settings window.

3. Click the **Maintenance** tab.

You see the maintenance options:

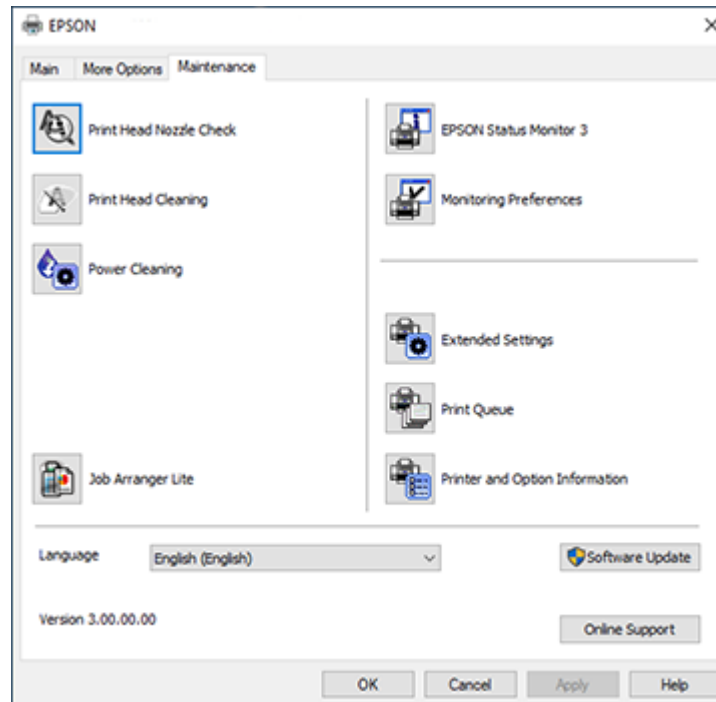

4. Select the language you want to use as the **Language** setting.





5. Click **OK** to close the printer software window.

The printer software screens appear in the language you selected the next time you access them.

**Parent topic:** [Selecting Default Print Settings - Windows](#)

## Changing Automatic Update Options

Your printer software for Windows automatically checks for updates to the product software. You can change how often the software checks for updates or disable this feature.

1. Access the Windows Desktop and right-click the  icon for your product in the right side of the Windows taskbar, or click the up arrow and right-click .
2. Select **Software Update Settings**.

You see this window:

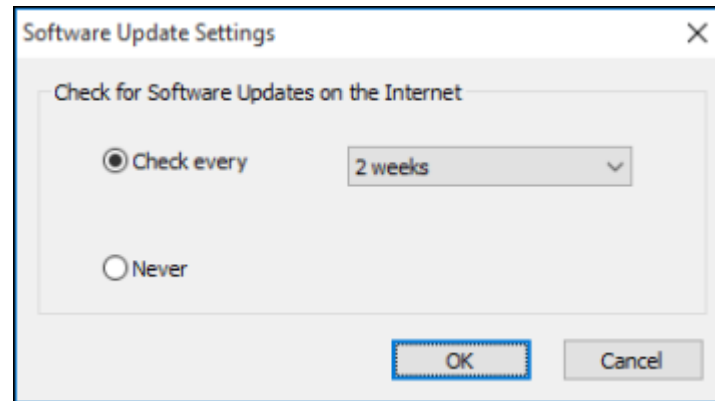

3. Do one of the following:
  - To change how often the software checks for updates, select a setting in the **Check every** menu.
  - To disable the automatic update feature, select the **Never** option.
4. Click **OK** to exit.

**Note:** If you choose to disable the automatic update feature, you can check for updates manually.

**Parent topic:** [Printing with the Standard Epson Printer Software - Windows](#)

## Related tasks

[Checking for Software Updates](#)

# Printing with the Built-in Epson Driver - Windows 10 S

You can print with the built-in Epson printer driver using any printing program on Windows 10 S, as described in these sections.

**Note:** The built-in Epson driver in Windows 10 S does not include all the available print settings for your product. To print with additional settings, download and install the Epson Print and Scan utility from the Windows Store. You cannot download and install any Epson product software from the Epson website for use with Windows 10 S; you must obtain software only from the Windows Store.

[Selecting Print Settings - Windows 10 S](#)

**Parent topic:** [Printing from a Computer](#)

## Selecting Print Settings - Windows 10 S

Select the settings for your print job in your Windows 10 S application.

1. Open a photo or document for printing.
2. Select the print command in your application.

**Note:** You may need to select a print icon on your screen, the **Print** option in the **File** menu, or another command. See your application's help utility for details.

3. If necessary, select your product name as the printer you want to use.

**Note:** You may also need to select **Properties** or **Preferences** to view your print settings.

You see a window like this:

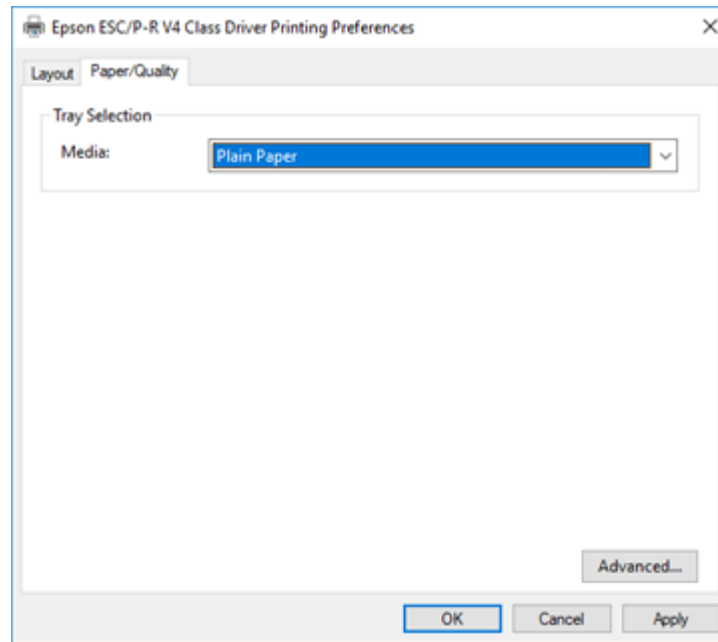

4. Select the type of paper you loaded as the **Media** setting.

**Note:** The setting may not exactly match the name of your paper. Check the paper type settings list for details.

5. Click the **Advanced** button.

You see a window like this:

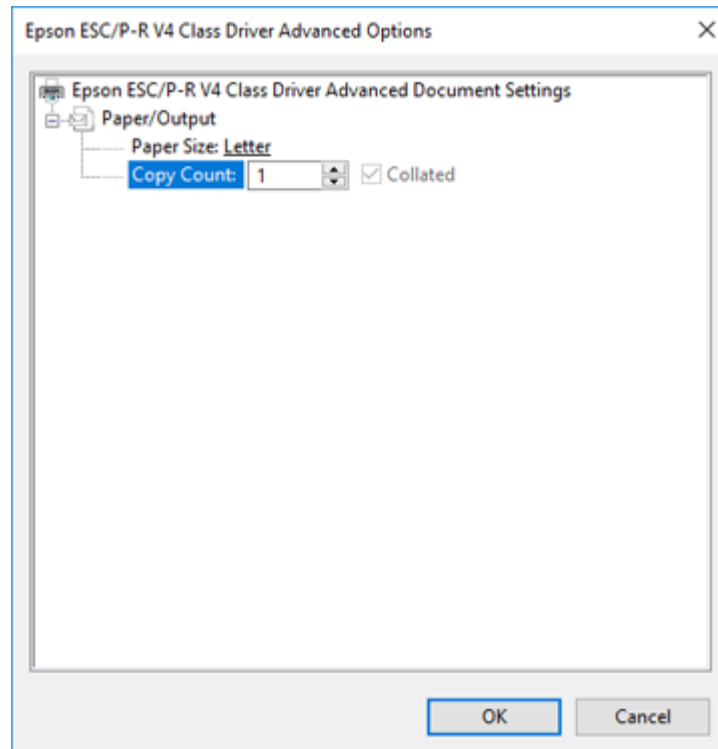

6. Select the size of the paper you loaded as the **Paper Size** setting.
7. To print multiple copies, select or enter the number as the **Copy Count** setting.
8. To print multiple copies of multi-page documents in sets, select the **Collated** checkbox.
9. Click **OK**.

You return to the printing preferences window.

10. Select the **Layout** tab.

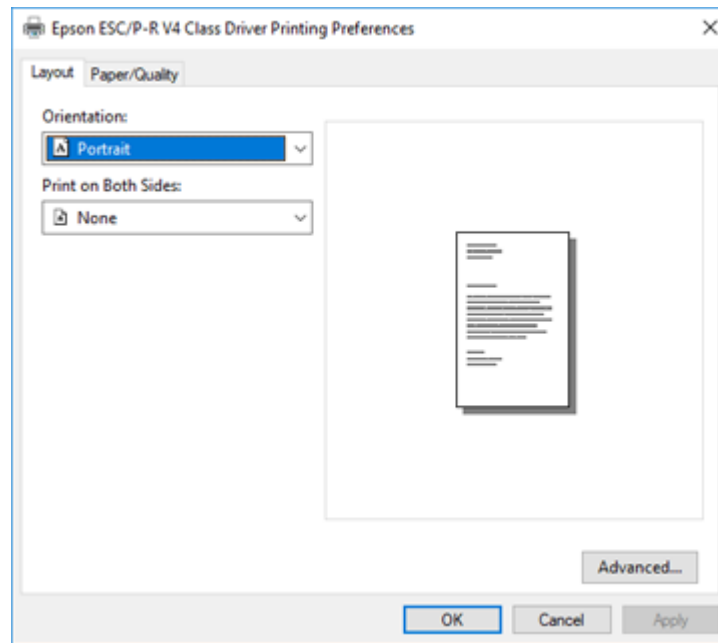

11. Select the orientation of your document as the **Orientation** setting.

- To print double-sided, select one of the **Print on Both Sides** options, depending on how you want to orient the page layout. The icon next to each option shows the layout.

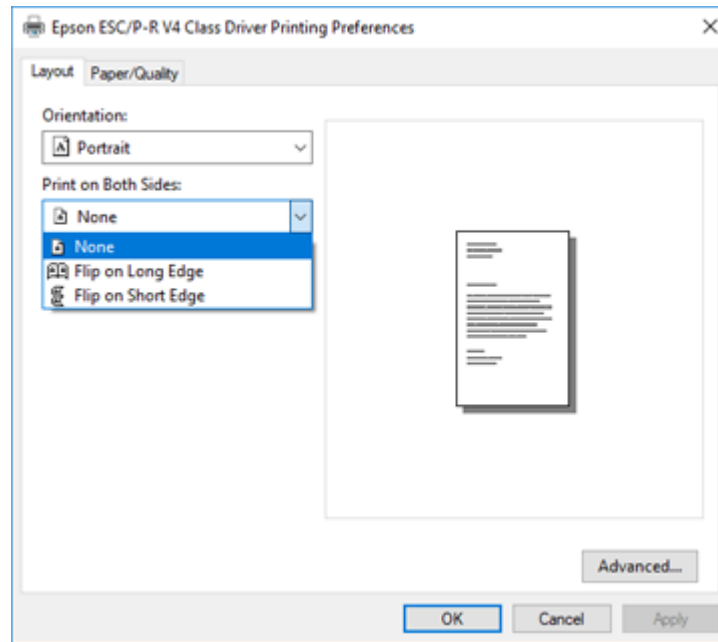

- Click **OK** to save your settings.

You see your application's **Print** window.

- Click **OK** or **Print** to start printing.

**Parent topic:** [Printing with the Built-in Epson Driver - Windows 10 S](#)

## Printing with the Epson Standard Printer Software - Mac

You can print with your product using any Mac printing program, as described in these sections.

**Note:** If you have an Internet connection, it is a good idea to check for updates to your product software on Epson's support website.

[Selecting Basic Print Settings - Mac](#)

[Selecting Page Setup Settings - Mac](#)

[Selecting Print Layout Options - Mac](#)  
[Selecting Double-sided Printing Settings - Mac](#)  
[Selecting Printing Preferences - Mac](#)  
[Printing Your Document or Photo - Mac](#)

**Parent topic:** [Printing from a Computer](#)

## Selecting Basic Print Settings - Mac

Select the basic settings for the document or photo you want to print.

1. Open a photo or document for printing.
2. Select the print command in your application.

**Note:** You may need to select a print icon on your screen, the **Print** option in the File menu, or another command. See your application's help utility for details.

3. Select your product as the **Printer** setting.

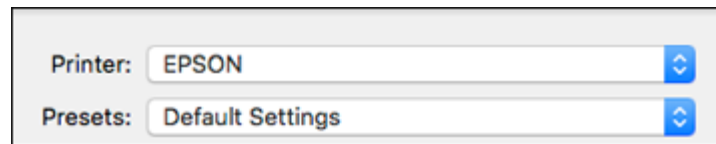

4. If necessary, click the arrow next to the Printer setting or the **Show Details** button to expand the print window.

You see the expanded printer settings window for your product:

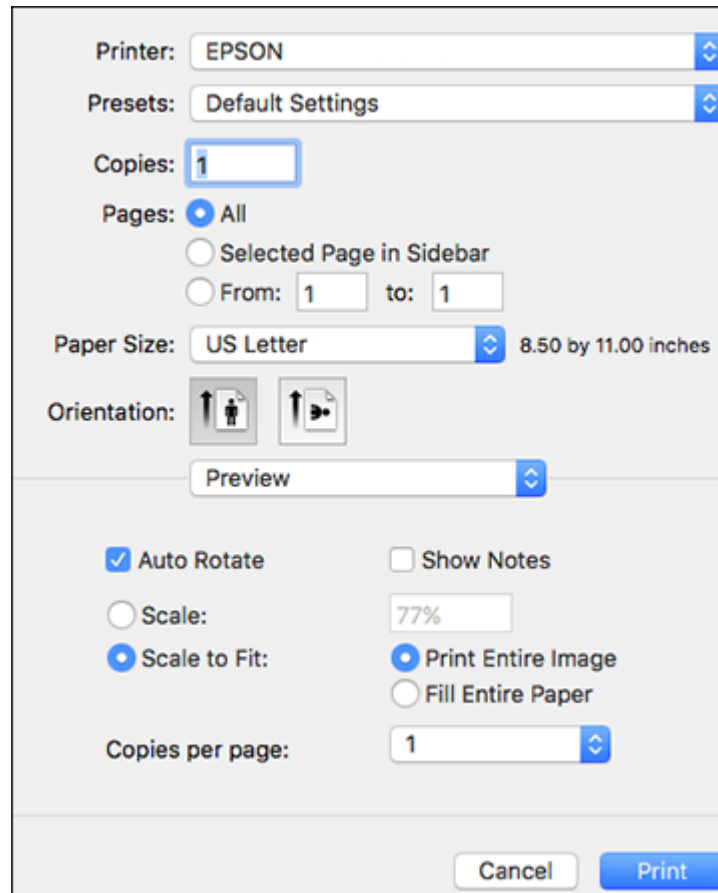

**Note:** The print window may look different, depending on the Mac OS version and the application you are using.

5. Select the **Copies** and **Pages** settings as necessary.

**Note:** If you do not see these settings in the print window, check for them in your application before printing.



6. Select the page setup options: **Paper Size** and **Orientation**.

**Note:** If you do not see these settings in the print window, check for them in your application before printing. They may be accessible by selecting **Page Setup** from the File menu.

7. Select any application-specific settings that appear on the screen, such as those shown in the image above for the Preview application.
8. Select **Print Settings** or **Printer Features** from the pop-up menu.

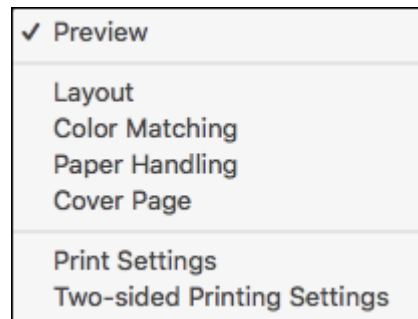

You see these settings:

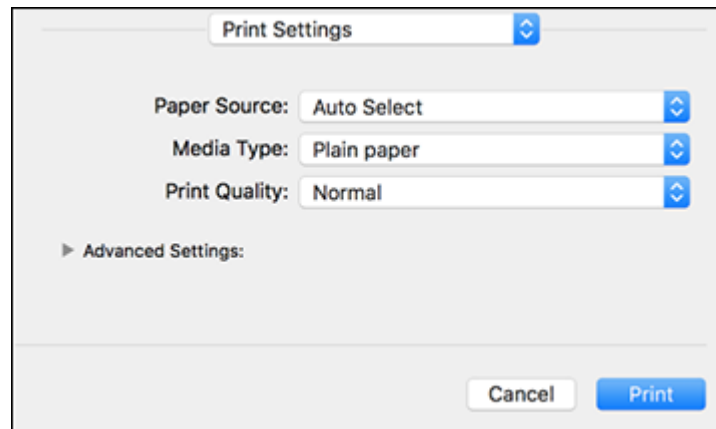

**Note:** The available print settings and appearance of the print window may be different than those covered here, depending on the Mac OS version and the application you are using.

9. Select the **Paper Source** you wish to print from.
10. Select the type of paper you loaded as the **Media Type** setting.

**Note:** The setting may not exactly match the name of your paper. Check the paper type settings list for details.

11. Select the **Print Quality** setting you want to use.
12. Select any of the available print options.

[Paper Source Options - Mac](#)

[Print Quality Options - Mac](#)

**Parent topic:** [Printing with the Epson Standard Printer Software - Mac](#)

#### **Related tasks**

[Selecting Page Setup Settings - Mac](#)

### **Paper Source Options - Mac**

You can select any of the available options in the Paper Source menu to print on the paper loaded in that source.

#### **Auto Select**

Automatically selects the paper source based on the selected paper size.

#### **Paper Tray**

Selects the paper in the rear feed as the paper source.

#### **Cassette 1**

Selects the paper in cassette 1 as the paper source.

#### **Cassette 2**

Selects the paper in cassette 2 as the paper source.

**Parent topic:** [Selecting Basic Print Settings - Mac](#)

### **Print Quality Options - Mac**

You can select any of the available Print Quality options to fine-tune the quality of your print. Some settings may be unavailable, depending on the paper type setting you have chosen.

#### **Draft**

For draft printing on plain paper.

**Normal**

For everyday text and image printing.

**Fine**

For text and graphics with good quality and print speed.

**Quality**

For text and graphics with increased quality and print speed.

**Best Quality**

For the best print quality, but the slowest print speed.

**Parent topic:** [Selecting Basic Print Settings - Mac](#)

## Selecting Page Setup Settings - Mac

Depending on your application, you may be able to select the paper size and orientation settings from the print window.

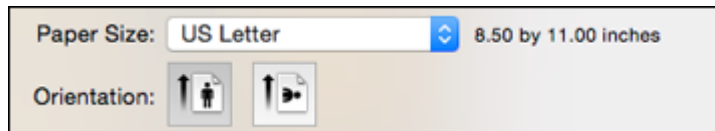

**Note:** If you do not see these settings in the print window, check for them in your application before printing. They may be accessible by selecting **Page Setup** from the File menu.

1. Select the size of the paper you loaded as the **Paper Size** setting.
2. Select the orientation of your document or photo as shown in the print window.

**Note:** If you are printing an envelope, select the  icon.

**Note:** You can reduce or enlarge the size of the printed image by selecting **Paper Handling** from the pop-up menu and selecting a scaling option.

**Parent topic:** [Printing with the Epson Standard Printer Software - Mac](#)

## Selecting Print Layout Options - Mac

You can select a variety of layout options for your document or photo by selecting **Layout** from the pop-up menu on the print window.

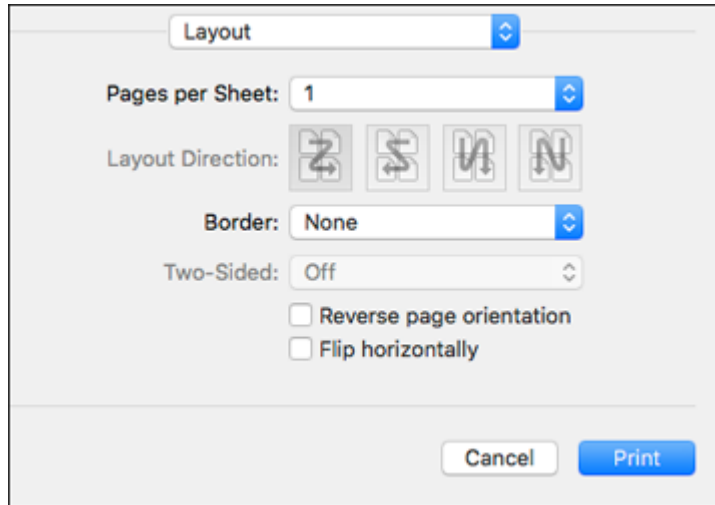

- To print multiple pages on one sheet of paper, select the number of pages in the **Pages per Sheet** pop-up menu. To arrange the print order of the pages, select a **Layout Direction** setting.
- To print borders around each page on the sheet, select a line setting from the **Border** pop-up menu.
- To print on both sides of each page, select a setting from the **Two-Sided** pop-up menu.
- To invert or flip the printed image, select the **Reverse page orientation** or **Flip horizontally** settings.

**Parent topic:** [Printing with the Epson Standard Printer Software - Mac](#)

## Selecting Double-sided Printing Settings - Mac

You can print on both sides of the paper by selecting **Two-sided Printing Settings** from the pop-up menu on the print window.

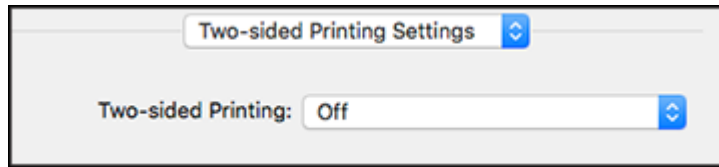

**Note:** Some options may be pre-selected or unavailable, depending on other settings you have chosen or if you are accessing the product over a network. This screen may be different, depending on the Mac OS version you are using.

1. Select one of the **Two-sided Printing** options.
2. Select the type of document you are printing as the **Document Type** setting. The software automatically sets the Adjustments options for that document type.

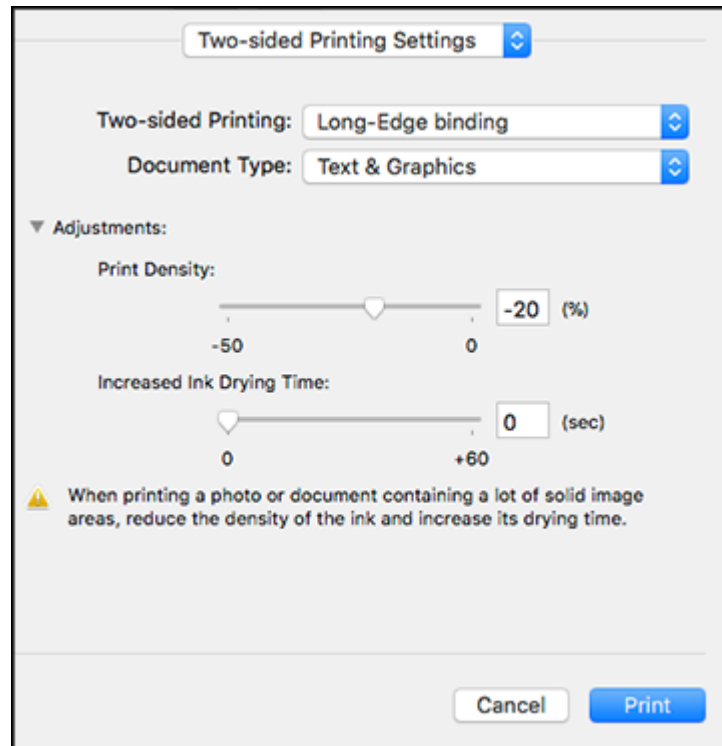

3. If necessary, customize the Adjustments settings as instructed on the screen.

4. Print a test copy of your double-sided document to test the selected settings.
5. Follow any instructions displayed on the screen during printing.

[Double-sided Printing Options and Adjustments - Mac](#)

**Parent topic:** [Printing with the Epson Standard Printer Software - Mac](#)

#### **Related references**

[Double-sided Printing Capacity](#)

### **Double-sided Printing Options and Adjustments - Mac**

You can select any of the available options in the **Two-sided Printing Settings** pop-up menu to set up your double-sided print job.

#### **Long-Edge binding**

Orients double-sided printed pages to be bound on the long edge of the paper.

#### **Short-Edge binding**

Orients double-sided printed pages to be bound on the short edge of the paper.

#### **Print Density**

Sets the level of ink coverage for double-sided printing.

#### **Increased Ink Drying Time**

Sets the amount of time required for drying ink after printing on one side of the paper before printing the other side in double-sided printing.

**Parent topic:** [Selecting Double-sided Printing Settings - Mac](#)

### **Selecting Printing Preferences - Mac**

You can select printing preferences that apply to all the print jobs you send to your product.

1. In the Apple menu or the Dock, select **System Preferences**.
2. Select **Print & Fax**, **Print & Scan**, or **Printers & Scanners**, select your product, and select **Options & Supplies**.
3. Select **Driver** or **Options**.

You see a screen like this:

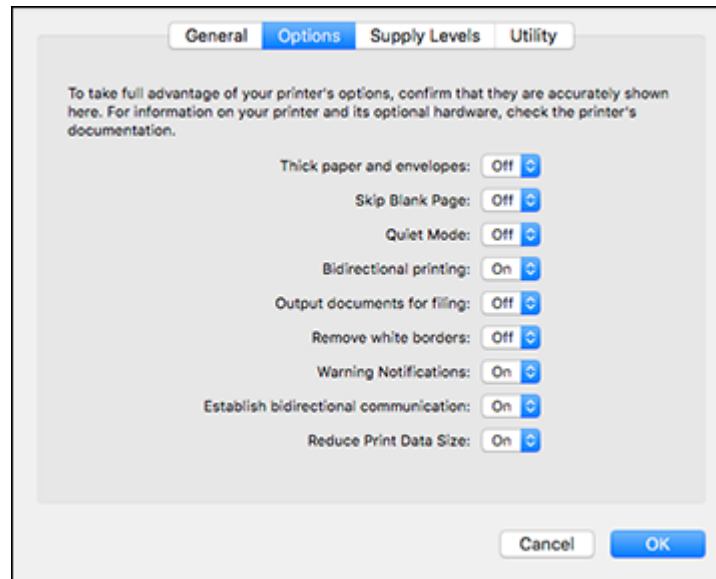

4. Select any of the available printing preferences.
5. Click **OK**.

[Printing Preferences - Mac](#)

**Parent topic:** [Printing with the Epson Standard Printer Software - Mac](#)

### Printing Preferences - Mac

You can select these settings on the **Options** or **Driver** tab.

#### **Thick Paper and Envelopes**

Prevents ink from smearing when you print on envelopes or other thick paper.

#### **Skip Blank Page**

Ensures that your product does not print pages that contain no text or images.

#### **Quiet Mode**

Lessens noise during printing but may decrease print speed.

**Bidirectional printing**

Prints in both directions (right-to-left and left-to-right), speeding up printing, but may reduce print quality.

**Output documents for filing**

Outputs all landscape, portrait, 1-sided, and 2-sided documents in the same orientation for easier filing.

**Remove white borders**

Removes white margins that may appear when you print borderless photos.

**Warning Notifications**

Lets you choose whether or not to receive warning notifications from the printer software for various operating conditions.

**Establish bidirectional communication**

Allows the product to communicate with the computer. Do not change the default setting unless you experience issues when using a shared printing pool.

**Reduce Print Data Size**

Increases print data compression to improve print speed. Not recommended when printing fine patterns.

Parent topic: [Selecting Printing Preferences - Mac](#)

## Printing Your Document or Photo - Mac

Once you have selected your print settings, you are ready to print.

Click **Print** at the bottom of the print window.

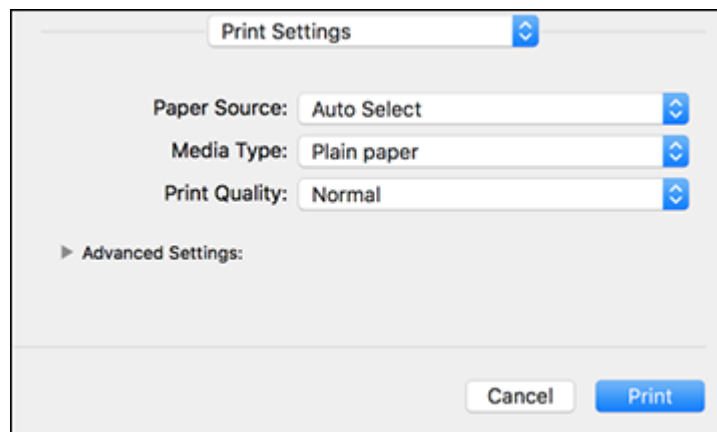



## Checking Print Status - Mac

**Parent topic:** [Printing with the Epson Standard Printer Software - Mac](#)

### Checking Print Status - Mac



During printing, you can view the progress of your print job, control printing, and check ink status.

1. Click the printer icon when it appears in the Dock.

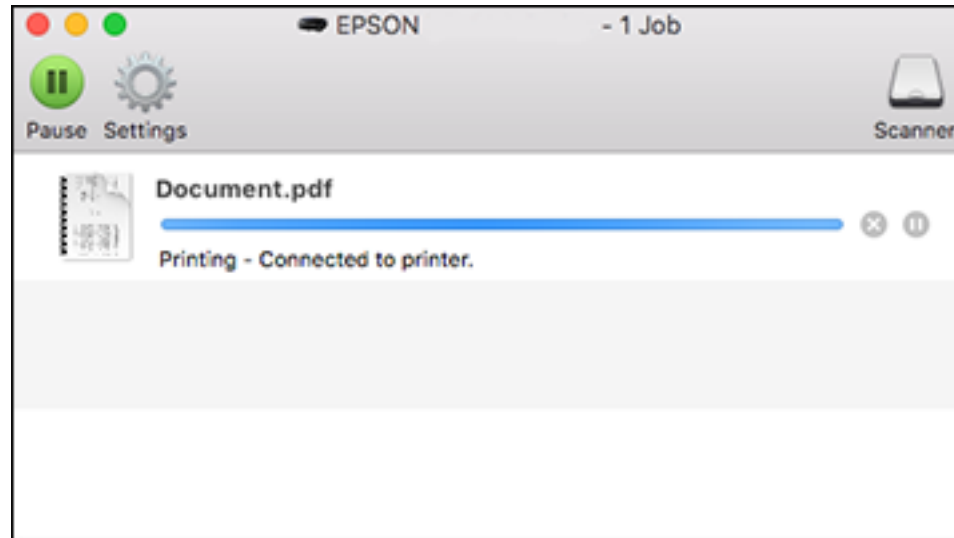
You see the print status window:



2. Select the following options as necessary for your Mac OS version:

- To cancel printing, click the print job and click  or **Delete**.
- To pause a print job, click the print job and click  or **Hold**. To resume a print job, click the paused print job and click  or **Resume**.
- To pause printing for all queued print jobs, click **Pause** or **Pause Printer**.
- To display other printer information, click **Settings** or **Supply Levels**.

**Parent topic:** [Printing Your Document or Photo - Mac](#)

## Setting Up Printing on a Chromebook

Your Epson printer supports native printing on Chromebook, allowing you to print from a Chromebook without drivers or cables.

For directions on setting up your printer, visit [Setting Up Your Epson Printer on Your Chromebook \(U.S\)](#) or [Setting Up Your Epson Printer on Your Chromebook \(Canada\)](#).

**Parent topic:** [Printing from a Computer](#)

## Printing with the PCL Printer Software - Windows

You can print with the PCL printer software using any Windows printing program, as described in these sections (ST-C8090).

[Synchronizing Printer Settings - PCL Driver - Windows](#)

[Selecting Basic Print Settings - PCL Driver - Windows](#)

[Selecting Default Print Settings - PCL Driver - Windows](#)





[Locking Printer Settings - PCL Driver - Windows](#)

**Parent topic:** [Printing from a Computer](#)

## Synchronizing Printer Settings - PCL Driver - Windows

You may need to synchronize the printer driver with the product if the printer driver does not detect the correct information or settings from the product.

1. Do one of the following:

- **Windows 10:** Click  and select  (Settings) > **Devices** > **Printers & scanners**. Right-click on your product, select the PCL option, and select **Manage** > **Printer properties**.
- **Windows 8.x:** Navigate to the **Apps** screen and select **Control Panel** > **Hardware and Sound** > **Devices and Printers**. Right-click on your product, select the PCL option, and select **Printer properties**.
- **Windows 7:** Click  and select **Devices and Printers**. Right-click on your product, select the PCL option, and select **Printer properties**.
- **Windows Vista:** Click  and select **Control Panel**. Click **Printer** under **Hardware and Sound**, then right-click on your product, select the PCL option, and select **Properties**.

2. Click the **Optional Settings** tab.

You see a window like this:

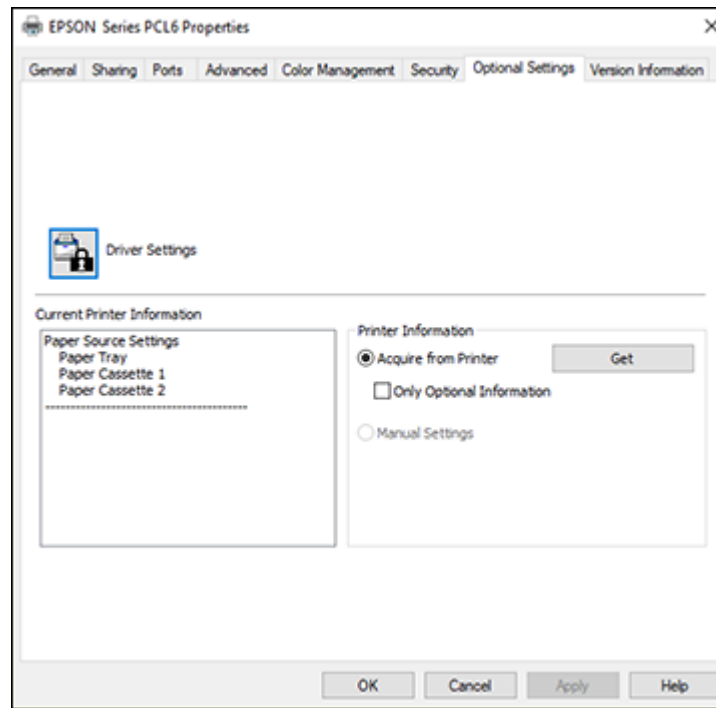

3. Make sure **Acquire from Printer** is selected and click **Get**.  
The product's settings and other information appears in the Current Printer Information area.
4. Click **OK**.

**Parent topic:** [Printing with the PCL Printer Software - Windows](#)

## Selecting Basic Print Settings - PCL Driver - Windows

Select the basic settings for the document or photo you want to print.

**Note:** The names of settings on the PCL driver screens may vary slightly, depending on the version of the driver you have installed.

1. Open a photo or document for printing.

2. Select the print command in your application.

**Note:** You may need to select a print icon on your screen, the **Print** option in the **File** menu, or another command. See your application's help utility for details.

3. If necessary, select the PCL option of your product as the printer you want to use.

**Note:** You may also need to select **Properties** or **Preferences** to view your print settings.

You see the **Main** tab of your printer settings window:

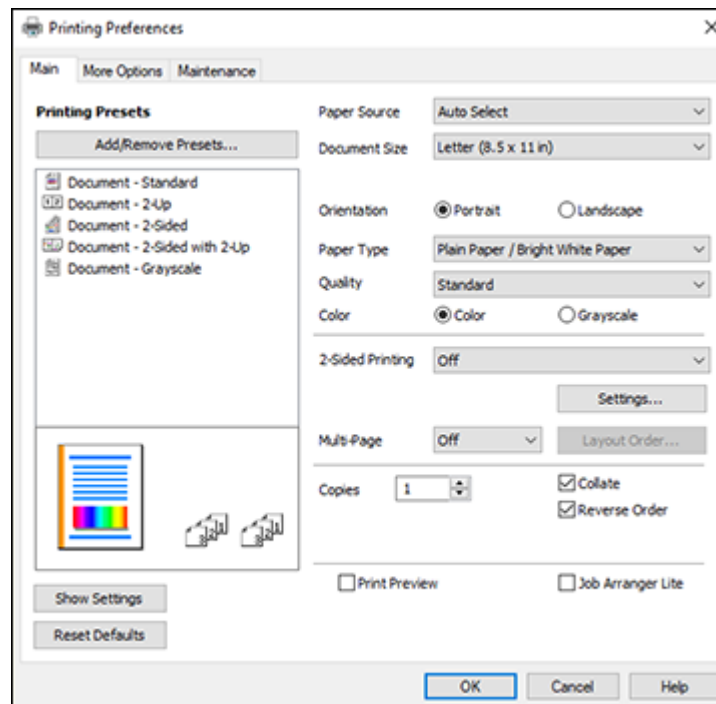

**Note:** For more information about a setting, right-click it and select **Help**.

4. For the **Paper Source** setting, select where you loaded the paper you want to print on.

5. Select the size of the paper you loaded as the **Document Size** setting.

**Note:** You can also select the **User-Defined** setting to create a custom paper size.

6. Select the orientation of your document.

**Note:** If you are printing an envelope, select **Landscape**.

7. Select the type of paper you loaded as the **Paper Type** setting.

**Note:** The setting may not exactly match the name of your paper. Check the paper type settings list for details.

8. Select any of the available print options.

9. To select a variety of additional layout and printing options for your document or photo, select the **More Options** tab and select the printing options you want.





10. To select maintenance and other optional settings, select the **Maintenance** tab and select the options you want.

**Parent topic:** [Printing with the PCL Printer Software - Windows](#)

## Selecting Default Print Settings - PCL Driver - Windows

When you change your print settings in a program, the changes apply only while you are printing in that program session. If you want to change the print settings you use in all your Windows programs, you can select new default print settings.

1. Do one of the following:

- **Windows 10:** Click  and select  (Settings) > **Devices** > **Printers & scanners**. Right-click on your product, select the PCL option, and select **Manage** > **Printing preferences**.
- **Windows 8.x:** Navigate to the **Apps** screen and select **Control Panel** > **Hardware and Sound** > **Devices and Printers**. Right-click on your product, select the PCL option, and select **Printing preferences**.
- **Windows 7:** Click  and select **Devices and Printers**. Right-click on your product, select the PCL option, and select **Printing preferences**.
- **Windows Vista:** Click  and select **Control Panel**. Click **Printer** under **Hardware and Sound**, then right-click on your product, select the PCL option, and select **Properties**.

You see the printer settings window:

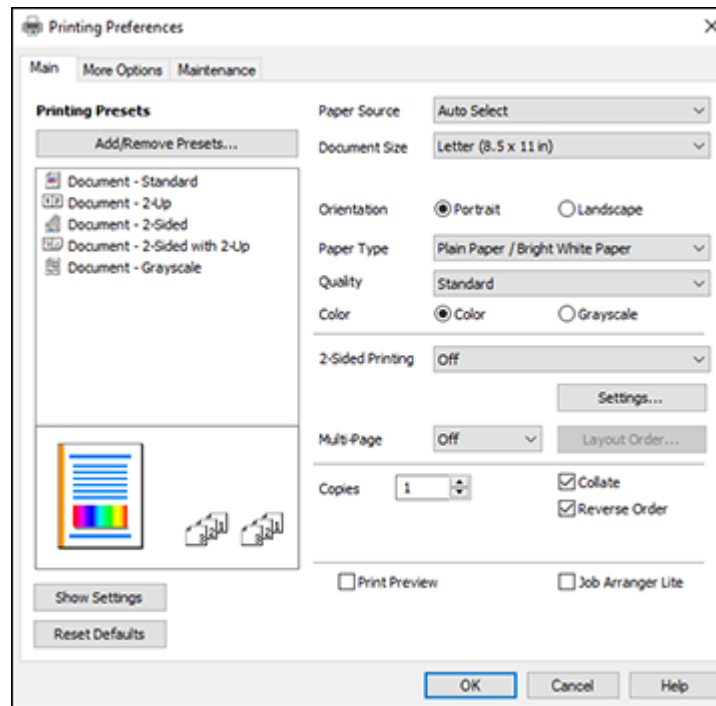

**Note:** For more information about a setting, right-click it and select **Help**.





2. Select the print settings you want to use as defaults in all your Windows programs.
3. Click **OK**.

These settings are now the defaults selected for printing. You can still change them as needed for printing in any program session.

**Parent topic:** [Printing with the PCL Printer Software - Windows](#)

## Locking Printer Settings - PCL Driver - Windows

Administrators can lock some printer settings to prevent unauthorized changes.

1. Do one of the following:
  - **Windows 10:** Click  and select  (Settings) > **Devices > Printers & scanners**. Right-click on your product, select the PCL option, and select **Manage > Printer properties**.
  - **Windows 8.x:** Navigate to the **Apps** screen and select **Control Panel > Hardware and Sound > Devices and Printers**. Right-click on your product, select the PCL option, and select **Printer properties**.
  - **Windows 7:** Click  and select **Devices and Printers**. Right-click on your product, select the PCL option, and select **Printer properties**.
  - **Windows Vista:** Click  and select **Control Panel**. Click **Printer** under **Hardware and Sound**, then right-click on your product, select the PCL option, and select **Properties**.
2. Click the **Optional Settings** tab.
3. Click **Driver Settings**.

You see this window:

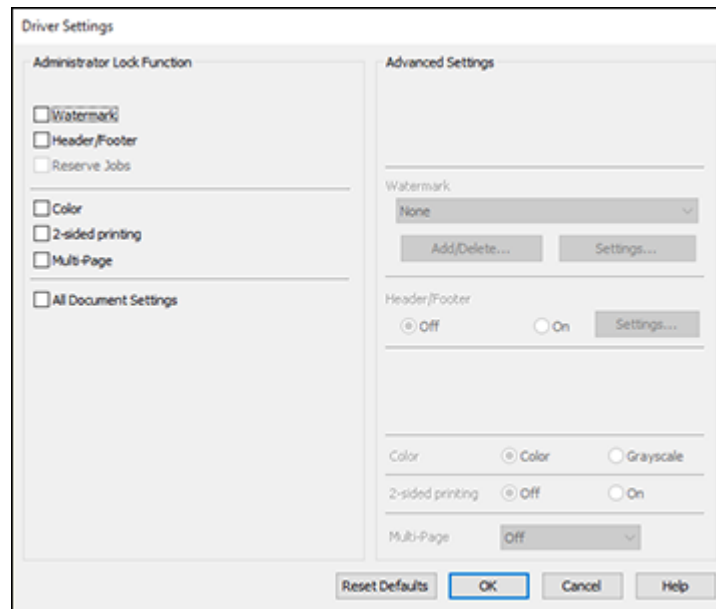

4. Select the checkbox for the settings you want to lock. To lock all print settings, select **All Document Settings**.
5. Under **Advanced Settings**, select the setting option you want to use for each locked setting.
6. Click **OK**.

[PCL Driver Locked Setting Options](#)

**Parent topic:** [Printing with the PCL Printer Software - Windows](#)

### PCL Driver Locked Setting Options

Select the options you want to use for any locked print settings.

Setting	Options	Description
<b>Watermark</b>	Various text watermarks	Lets you select the text for the watermark or prohibit watermarks
	<b>Add/Delete</b>	Lets you add or delete a customized text or image-based watermark
	<b>Settings</b>	Lets you select the size, position, and other watermark settings
<b>Header/Footer</b>	<b>Off</b>	Prohibits headers or footers
	<b>On</b>	Allows headers and footers
	<b>Settings</b>	Lets you select the text and position for printing headers and footers
<b>Color</b>	<b>Color</b>	Allows color printing
	<b>Grayscale</b>	Allows printing in black or shades of gray only
<b>2-sided printing</b>	<b>Off</b>	Allows printing on only one side of the paper
	<b>On</b>	Allows printing on both sides of the paper



Setting	Options	Description
<b>Multi-Page</b>	<b>Off</b>	Prohibits multi-page settings
	<b>2-Up</b>	Allows printing of 2 pages on one sheet of paper
	<b>4-Up</b>	Allows printing of 4 pages on one sheet of paper
	<b>6-Up</b>	Allows printing of 6 pages on one sheet of paper
	<b>8-Up</b>	Allows printing of 8 pages on one sheet of paper
	<b>9-Up</b>	Allows printing of 9 pages on one sheet of paper
	<b>16-Up</b>	Allows printing of 16 pages on one sheet of paper

Parent topic: [Locking Printer Settings - PCL Driver - Windows](#)

## Printing with the PostScript (PS3) Printer Software - Windows

You can print with the PostScript (PS3) printer software using any Windows printing program, as described in these sections (ST-C8090).

[Selecting Basic Print Settings - PostScript Printer Software - Windows](#)

[Selecting Default Print Settings - PostScript Printer Software - Windows](#)

Parent topic: [Printing from a Computer](#)

## Selecting Basic Print Settings - PostScript Printer Software - Windows

Select the basic settings for the document or photo you want to print.

The PostScript printer software supports plain paper printing on these paper and envelope sizes:

- A4 (8.3 × 11.7 inches [210 × 297 mm])
- Letter (8.5 × 11 inches [216 × 279 mm])
- Legal (8.5 × 14 inches [216 × 356 mm])
- A6 (4.1 × 5.8 inches [105 × 148 mm])
- Executive (7.25 × 10.5 inches [184 × 267 mm])
- No. 10 (4.1 × 9.5 inches [105 × 241 mm])

1. Open a photo or document for printing.

2. Select the print command in your application.

**Note:** You may need to select a print icon on your screen, the **Print** option in the **File** menu, or another command. See your application's help utility for details.

3. If necessary, select your product name as the printer you want to use, and then click the **Preferences** button.

You see this window:

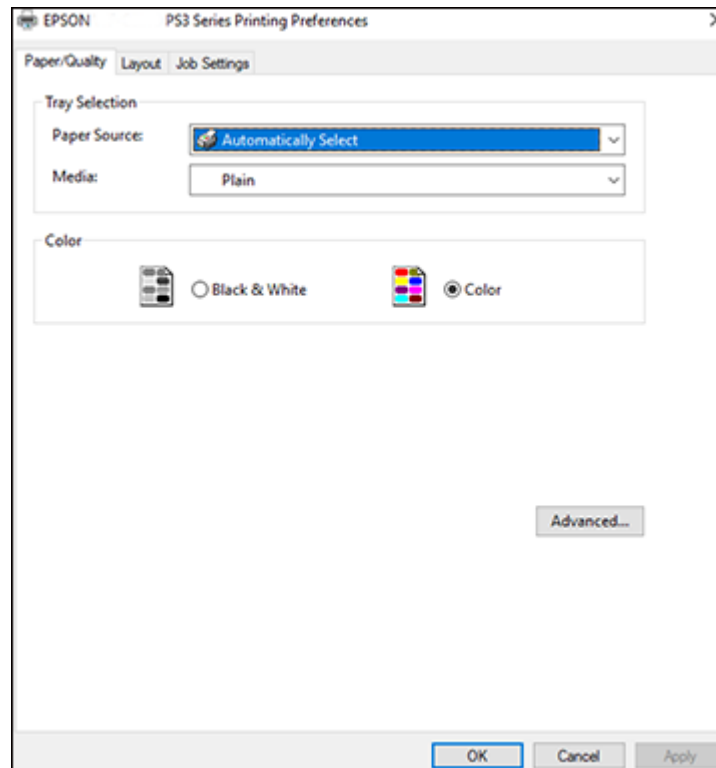

4. Select the **Paper Source** that matches where you loaded the paper you want to print on.
5. Select **Plain** as the **Media** setting.

6. Select one of the following as the Color setting:
  - To print text and graphics in black only, select the **Black & White** setting.
  - To print a color document or photo, select the **Color** setting.
7. To select additional layout and printing options, select **Advanced** and select additional settings as necessary.
8. Click the **Layout** tab.  
You see this window:

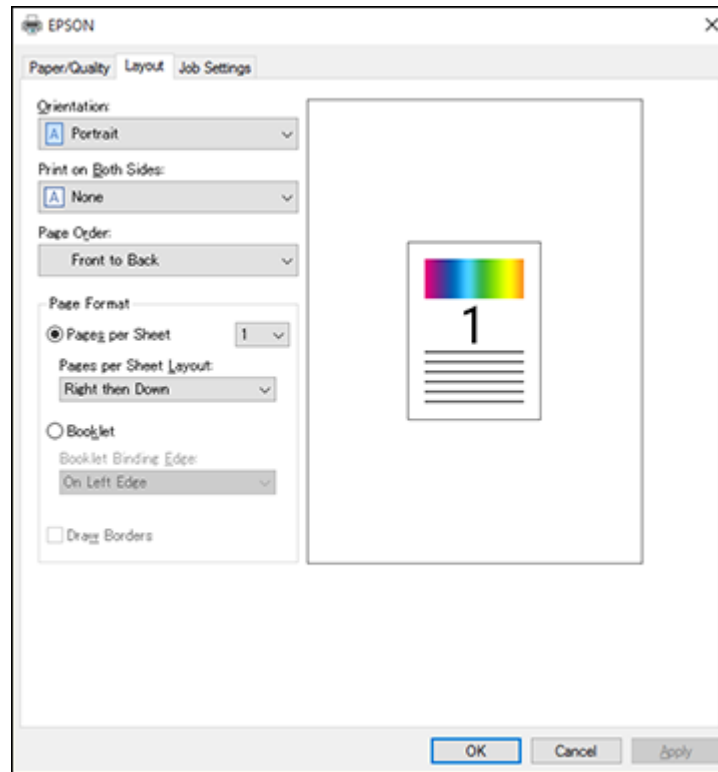





9. Select the print options as necessary.
10. Click **OK** when you are finished.

**Parent topic:** [Printing with the PostScript \(PS3\) Printer Software - Windows](#)

## Selecting Default Print Settings - PostScript Printer Software - Windows

When you change your print settings in a program, the changes apply only while you are printing in that program session. If you want to change the print settings you use in all your Windows programs, you can select new default print settings.

1. Do one of the following:

- **Windows 10:** Click  and select  (Settings) > **Devices** > **Printers & scanners**. Select your product name and select **Manage** > **Printing preferences**.
- **Windows 8.x:** Navigate to the **Apps** screen and select **Control Panel** > **Hardware and Sound** > **Devices and Printers**. Right-click your product name and select **Print Preferences**.
- **Windows 7:** Click  and select **Devices and Printers**. Right-click your product name and select **Printing Preferences**.
- **Windows Vista:** Click  and select **Control Panel**. Click **Printer** under **Hardware and Sound**, right-click your product name, and select **Printing Preferences**.

You see the printer settings window:

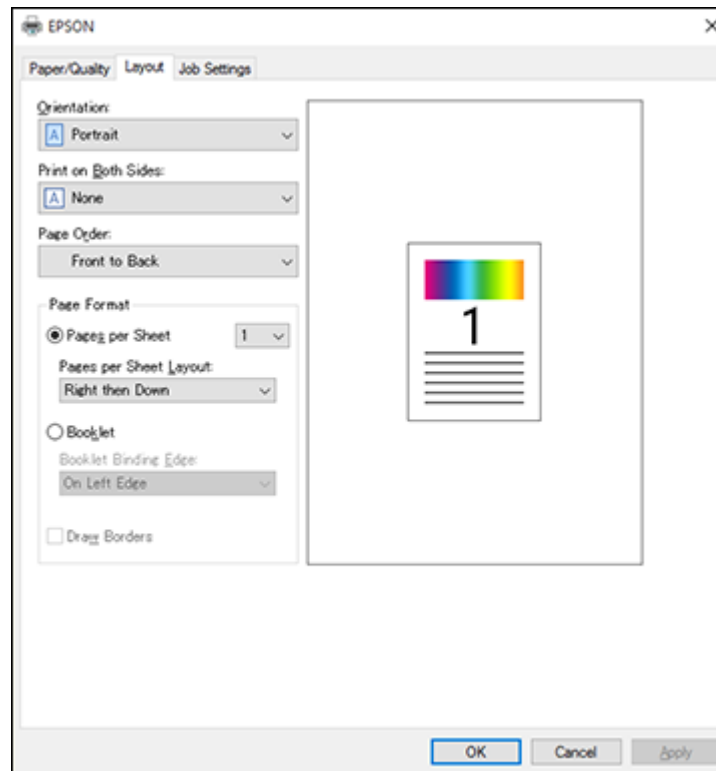

2. Select the print settings you want to use as defaults in all your Windows programs.
3. Click **OK**.

These settings are now the defaults selected for printing. You can still change them as needed for printing in any program session.

**Parent topic:** [Printing with the PostScript \(PS3\) Printer Software - Windows](#)

## Printing with the PostScript (PS3) Printer Software - Mac

You can print with the PostScript (PS3) printer software using any Mac printing program, as described in these sections (ST-C8090).

[Selecting Basic Print Settings - PostScript Printer Software - Mac](#)

Parent topic: [Printing from a Computer](#)

## Selecting Basic Print Settings - PostScript Printer Software - Mac

Select the basic settings for the document or photo you want to print.

The PostScript printer software supports plain paper printing on these paper and envelope sizes:

- A4 (8.3 × 11.7 inches [210 × 297 mm])
- Letter (8.5 × 11 inches [216 × 279 mm])
- No. 10 (4.1 × 9.5 inches [105 × 241 mm])
- A5 (5.8 × 8.2 inches [148 × 210 mm])
- A6 (4.1 × 5.8 inches [105 × 148 mm])
- Executive (7.25 × 10.5 inches [184 × 267 mm])
- Legal (8.5 × 14 inches [216 × 356 mm])

1. Open a photo or document for printing.
2. Select the print command in your application.

**Note:** You may need to select a print icon on your screen, the **Print** option in the **File** menu, or another command. See your application's help utility for details.

3. Select your product as the **Printer** setting.

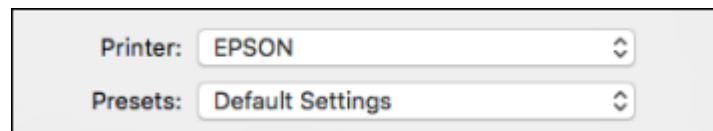

4. If necessary, click the arrow next to the Printer setting or the **Show Details** button to expand the print window.

You see the expanded printer settings window for your product:

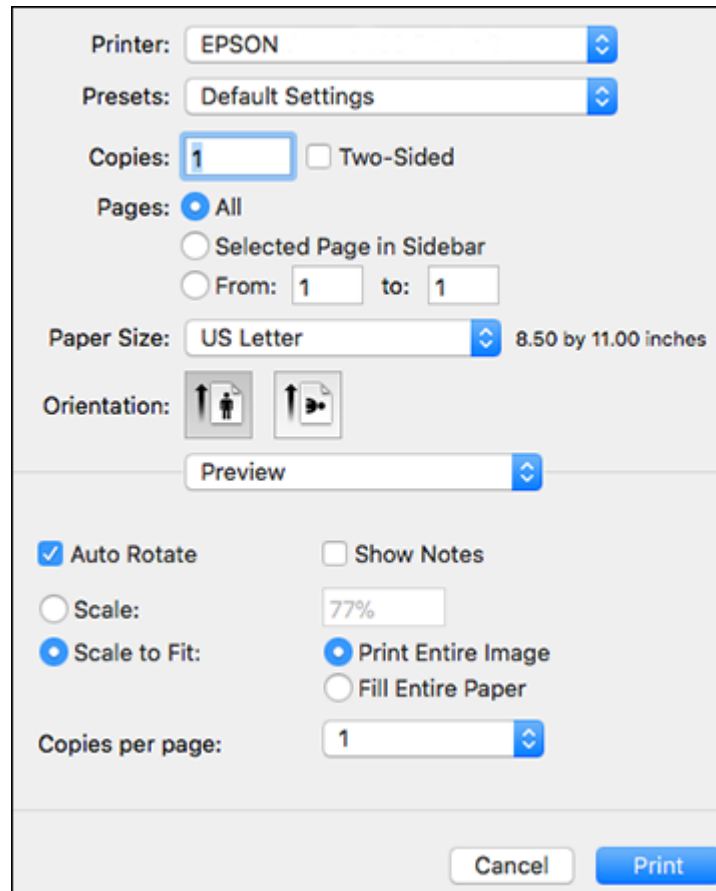

**Note:** The print window may look different, depending on the Mac OS version and the application you are using.

5. Select the **Two-Sided**, **Copies**, and **Pages** settings as necessary.

**Note:** If you do not see these settings in the print window, check for them in your application before printing.

6. Select the page setup options: **Paper Size** and **Orientation**.

**Note:** If you do not see these settings in the print window, check for them in your application before printing. They may be accessible by selecting **Page Setup** from the File menu.

7. Select any application-specific settings that appear on the screen, such as those shown in the image above for the Preview application.
8. Select **Paper Feed** from the pop-up menu.

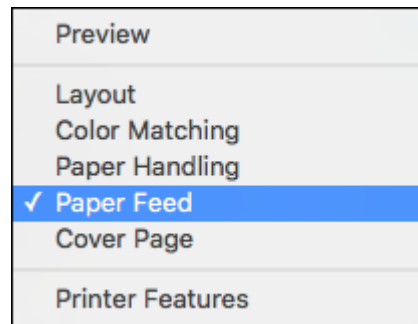

You see these settings:

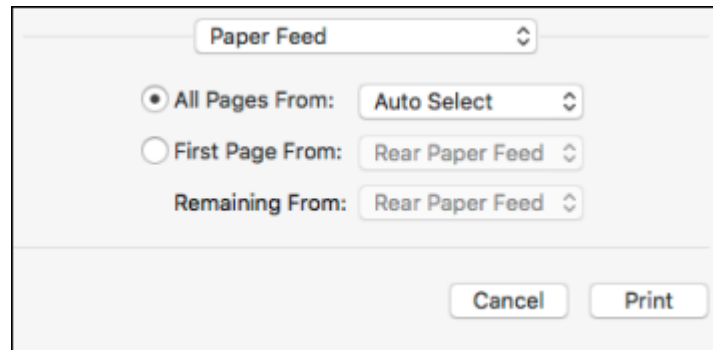

9. Select **All Pages From** or **First Page From** and select the paper source you want to print from.



10. Select **Printer Features** from the pop-up menu.

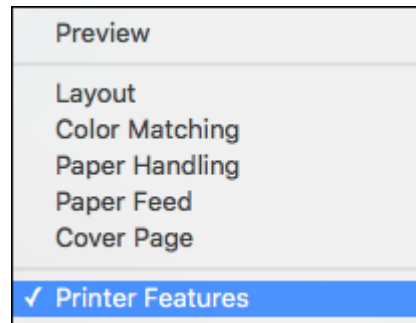

You see these settings:

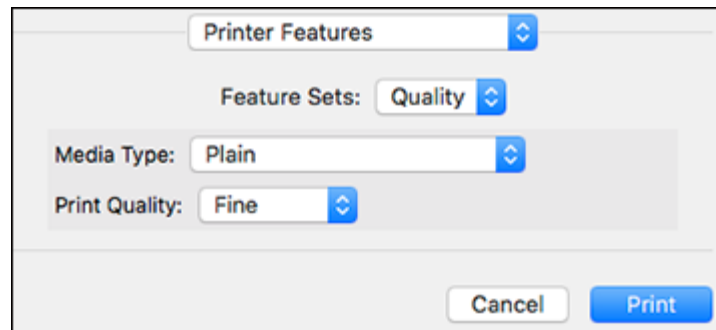

11. Select **Plain** as the **Media Type** setting.

12. Select one of the following **Print Quality** options:

- For fast printing with reduced quality, select **Fast**.
- For printing text and graphics with good quality and print speed, select **Fine**.
- For the best printing with reduced speed, select **Maximum**.

13. Select any of the following from the pop-up menu as necessary:

- Select **Layout** to adjust a variety of layout options for your document or photo.
- Select **Paper Handling** to adjust the size of the image as you print it.

- Select **Color Matching** to fine-tune the colors in your printout.

**Parent topic:** [Printing with the PostScript \(PS3\) Printer Software - Mac](#)

## **Cancelling Printing Using a Product Button**

If you need to cancel printing, select **Cancel** on the LCD screen.

**Parent topic:** [Printing from a Computer](#)

---

# Scanning

You can scan your originals and save them as digital files.

[Starting a Scan](#)

[Scanning a Document in Epson ScanSmart](#)

[Selecting Epson ScanSmart Settings](#)

[Scanning in Epson Scan 2](#)

## Starting a Scan

After placing your originals on your product for scanning, start scanning using one of these methods.

[Starting a Scan Using the Product Control Panel](#)

[Setting Up and Scanning to a Network Folder or FTP Server](#)

[Starting a Scan Using the Epson Scan 2 Icon](#)

[Starting a Scan from a Scanning Program](#)

[Starting a Scan from a Smartphone or Tablet](#)

[Entering a User ID and Password for Scanning](#)

**Parent topic:** [Scanning](#)

**Related tasks**

[Scanning a Document in Epson ScanSmart](#)

**Related topics**

[Placing Originals on the Product](#)

## Starting a Scan Using the Product Control Panel

You can scan an image to a variety of destinations using your product's control panel.

1. Make sure you installed the product software and connected the product to your computer or network.

**Note:** Restart your computer after installing the product software to enable scanning from the control panel.

2. Place your original on the product for scanning.

**Note:** To scan a double-sided or multi-page document, place your originals in the ADF.

3. Press the  home button, if necessary.
4. Select **Scan**.

You see a screen like this:

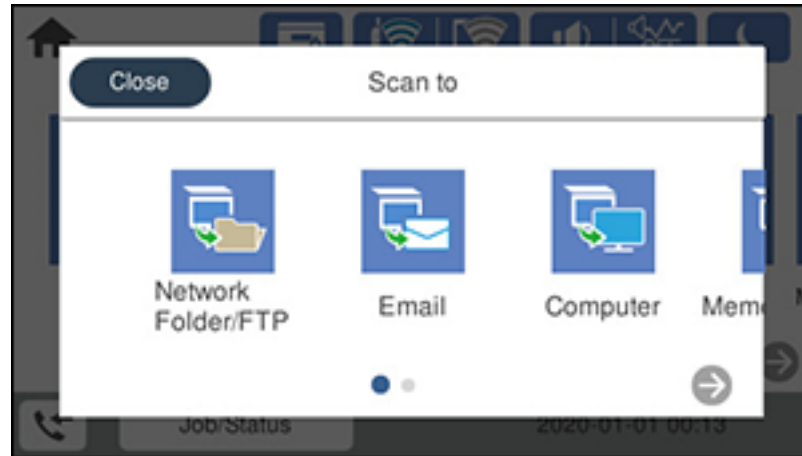

5. Select one of the following **Scan to** options:
  - **Network Folder/FTP** saves your scan file to a specified folder on a network.
  - **Email** lets you send scanned files through a pre-configured email server.
  - **Computer** lets you scan to a connected computer using your saved scan settings.
  - **Memory Device** saves your scan file on a USB device and lets you select the file format, quality, and other settings.
  - **Cloud** sends your scanned files to a destination that you have registered with Epson Connect.
  - **WSD** lets you manage network scanning in Windows 10, Windows 8.x, Windows 7, or Windows Vista (English only). To use this feature, you must first set up a WSD (Web Services for Devices) port on your Windows 7 or Windows Vista computer (the port is set up automatically on Windows 10 and Windows 8.x).
6. Follow the instructions in the links below to complete your scan.

[Scanning to Email](#)

[Scanning to a Connected Computer](#)

[Scanning to a Memory Device](#)

[Scanning to the Cloud](#)  
[Control Panel Scanning Options](#)

**Parent topic:** [Starting a Scan](#)

**Related tasks**

[Using Presets](#)  
[Entering Characters on the LCD Screen](#)

**Related topics**

[Placing Originals on the Product](#)

## Scanning to Email

You can scan an original and email the scanned file using your product's control panel. You need to have a preconfigured email server before you can scan to email. You can enter email addresses directly on the product's control panel or select them from the **Recipient** tab. Make sure the date and time are set correctly so the time stamps on your emails are accurate.

1. Place your original on the product for scanning.

**Note:** To scan a double-sided or multi-page document, place all of the pages in the ADF.

2. Press the  home button, if necessary.
3. Select **Scan**.

You see a screen like this:

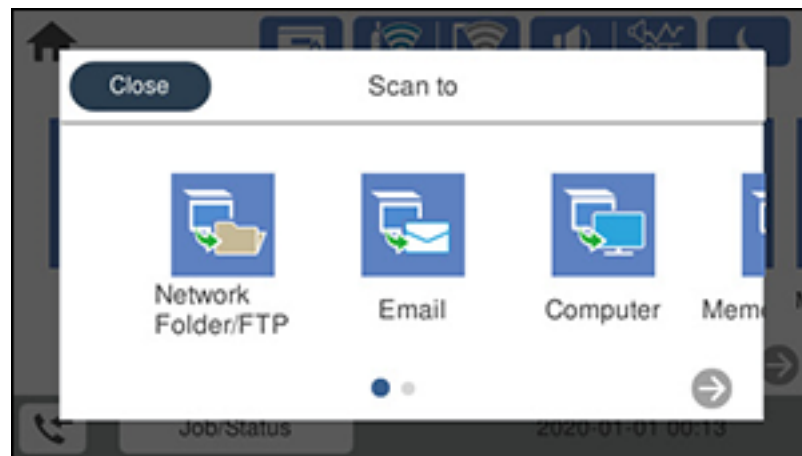

4. Select **Email**.

You see a screen like this:

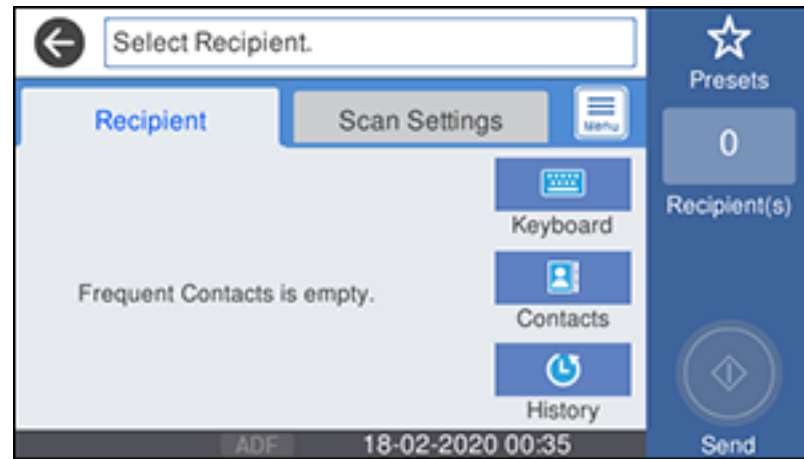

5. Do one of the following:

- Select an email address from any of the displayed frequent contacts.
- Select **Keyboard** to use the on-screen keyboard to enter the email address for the recipient(s) and select **OK**.
- Select **Contacts** and choose an email address from the list.
- Select **History** to choose an email address from your recent scan history.

6. Select **Scan Settings**.

7. Select **File Format** to choose the file format for your scan.

8. Scroll down to change the **Subject** and **File Name**, if necessary.

9. Select any additional scan settings as necessary.

10. Select **Presets** to save your scan settings.

**Note:** Presets can be locked by an administrator. If you cannot access or change this setting, contact your administrator for assistance.

11. Select  **Send**.

Your product scans your original and emails the scanned file.

**Parent topic:** [Starting a Scan Using the Product Control Panel](#)

### Scanning to a Connected Computer

You can scan an original and save it to a connected computer using your product's control panel. The computer must be connected using a USB cable or connected to the same network as your product.

You can save the scanned file as a JPEG or PDF file, or attach it to an email. You can also set up custom scan settings using Event Manager and automatically scan using those settings on your product control panel.

**Note:** Be sure you have installed Epson Scan 2, ScanSmart, and Event Manager on your computer before scanning to your computer.

1. Place your original on the product for scanning.

**Note:** To scan a multi-page document, place all of the pages in the ADF.

2. Press the  home button, if necessary.
3. Select **Scan**.

You see a screen like this:

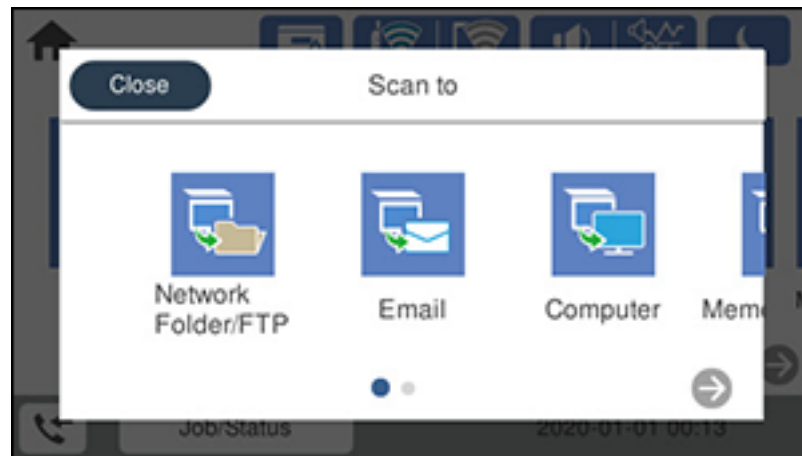

4. Select **Computer**.

You see a screen like this:

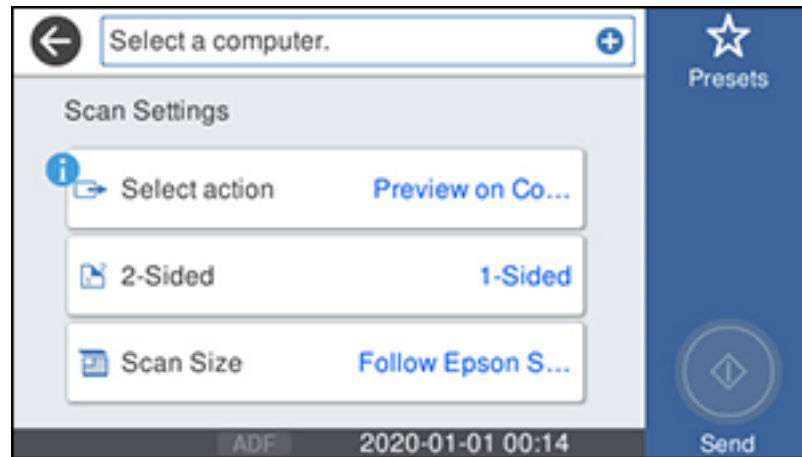

5. Select **Select action** and choose one of the following options:
  - **Preview on Computer** to preview the scan and select file save settings in ScanSmart.
  - **Save as JPEG** to save the scanned image as a JPEG file.
  - **Save as PDF** to save the scanned document or image as a PDF file.
6. Change any of the displayed settings as necessary.
7. Select  **Send**.

Your product scans the original and sends the file to the connected computer.

**Parent topic:** [Starting a Scan Using the Product Control Panel](#)

### Scanning to a Memory Device

You can scan an original and save the scanned image to a external USB device connected to your product.

1. Insert an external USB device into the product's USB port.
2. Place your original on the product for scanning.

**Note:** To scan a double-sided or multi-page document, place all of the pages in the ADF.



3. Press the  home button, if necessary.
4. Select **Scan**.

You see a screen like this:

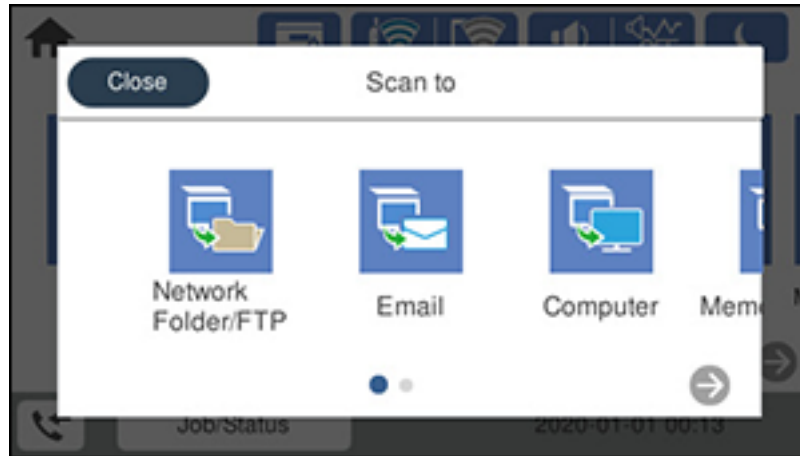

5. Select **Memory Device**.

You see a screen like this:

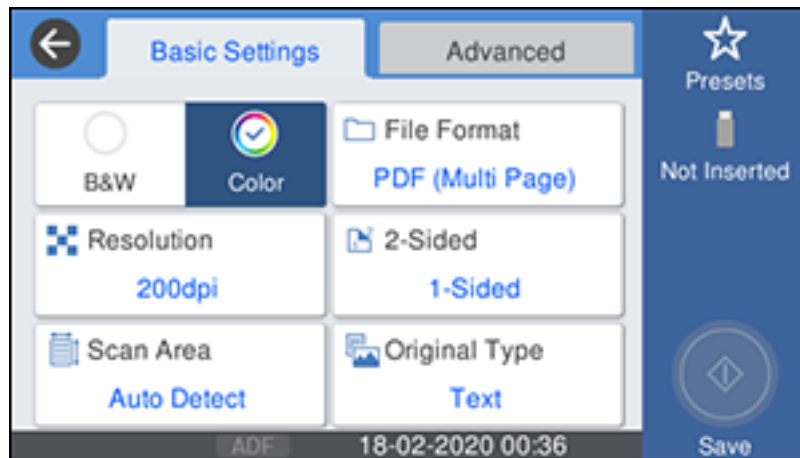

6. Select the settings as necessary.
7. Select **Presets** to save your scan settings.

**Note:** Presets can be locked by an administrator. If you cannot access or change this setting, contact your administrator for assistance.

8. Select  **Save**.

Your product scans your original and saves the scanned file to the connected memory device.

**Parent topic:** [Starting a Scan Using the Product Control Panel](#)

### Scanning to the Cloud

You can use the control panel to send your scanned files to a destination that you have registered with Epson Connect.

**Note:** Make sure to set up your product using Epson Connect before using this feature.

1. Place your original on the product for scanning.

**Note:** To scan a double-sided or multi-page document, place all of the pages in the ADF.

2. Press the  home button, if necessary.
3. Select **Scan**.

You see a screen like this:

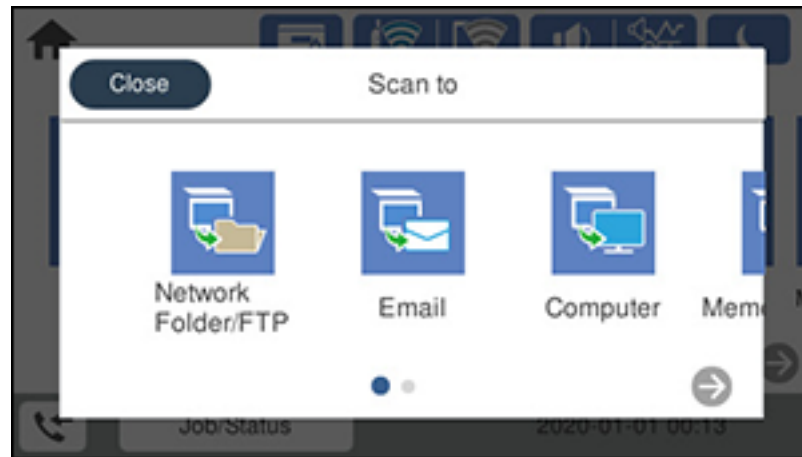

4. Select **Cloud**.

You see a screen like this:

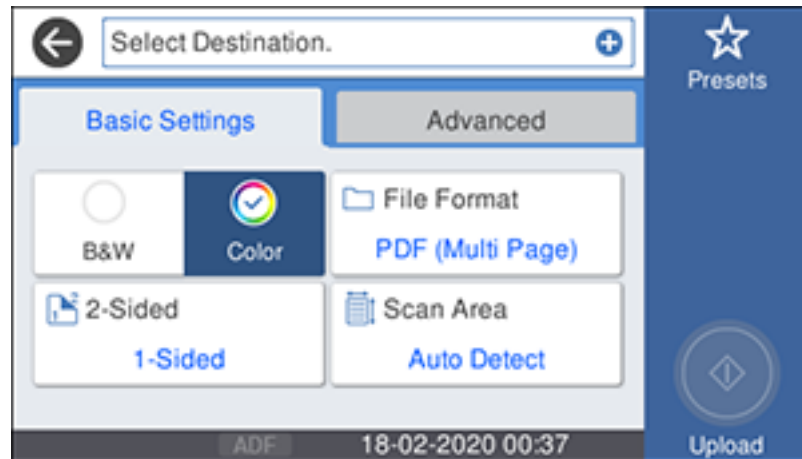

5. Select the + icon and select a cloud destination.
6. Select the settings as necessary.

7. Select **Presets** to save your scan settings.

**Note:** Presets can be locked by an administrator. If you cannot access or change this setting, contact your administrator for assistance.

8. Select  **Upload**.

Your product scans your original and saves the scanned file to the selected destination.

**Parent topic:** [Starting a Scan Using the Product Control Panel](#)

### Control Panel Scanning Options

Select the options you want to use for scanning.

**Note:** Not all options or settings may be available, depending on the **Scan to** option selected.

Scan Settings	Available options	Description
<b>Color Mode</b>	<b>B&amp;W</b>	Select to scan images in black and white
	<b>Color</b>	Select to scan images in color
<b>File Format</b>	<b>JPEG</b>	Select for photos. You can also select the <b>Compression Ratio</b> .
	<b>PDF (Single Page)</b>	Select for documents. You can also select the <b>Compression Ratio</b> and <b>PDF Settings</b> .
	<b>PDF (Multi Page)</b>	
	<b>PDF/A (Single Page)</b>	
	<b>PDF/A (Multi Page)</b>	
	<b>TIFF (Single Page)</b>	Select for scanned files that you can print from a device. Multi Page TIFF documents are scanned in black and white.
<b>TIFF (Multi Page)</b>		
<b>Resolution</b>	<b>200dpi</b>	Select for documents
	<b>300dpi</b>	Select for photos
	<b>600dpi</b>	Select for highest quality printing

Scan Settings	Available options	Description
<b>2-Sided</b>	<b>1-Sided</b>	Lets you scan 2-sided originals placed in the ADF. If you select <b>2-Sided</b> , you can also select the <b>Orientation (Original)</b> and the <b>Binding (Original)</b> .
	<b>2-Sided</b>	
<b>Scan Area</b>	<b>Auto Detect</b>	Select to automatically adjust the scan area
	Various sizes	Select the page size for documents
	<b>Max Area</b>	Select for most photos
<b>Original Type</b>	<b>Text</b>	Specify the type of original you are scanning
	<b>Text &amp; Image</b>	
	<b>Photo</b>	
<b>Orientation (Original)</b>	<b>Readable Direction</b>	Select the orientation direction for how you placed the originals
	<b>Left Direction</b>	
<b>Mixed Size Originals</b>	<b>Off</b>	Select <b>On</b> to scan originals of varying sizes in their original sizes
	<b>On</b>	
<b>Density</b>	Varying levels	Adjust the lightness or darkness of scanned images.
<b>Remove Shadow</b>	<b>Off</b>	Erase the shadows that appear in the center of a document when copying a book or the shadows that appear around a document when copying thick paper
	<b>On</b>	
<b>Remove Punch Holes</b>	<b>Off</b>	Erase the binding holes on a document
	<b>On</b>	
<b>Subject</b>	—	Enter a subject for your email
<b>Attached File Max Size</b>	Various sizes	Select the maximum file size that can be attached to an email
<b>File Name</b>	—	Enter a prefix, the date, and the time to the file name for your scanned file

Parent topic: [Starting a Scan Using the Product Control Panel](#)

## Setting Up and Scanning to a Network Folder or FTP Server

Before you can scan to a network folder on your computer or on an FTP server, you need to create a shared folder and optionally register its location to your product's contact list. Select the links below as necessary to create and register the folder, and to scan to it over the network.

[Creating a Shared Network Folder](#)

[Registering Contacts for Network Folder or FTP Scanning - Web Config](#)

[Registering Contacts for Email, Network, or FTP Scanning - Control Panel](#)

[Scanning to a Network Folder or FTP Server](#)

**Parent topic:** [Starting a Scan](#)

### Creating a Shared Network Folder

You can create a shared network folder on your computer or an FTP site and register its location to your product's **Contacts** list.

**Note:** If you are creating a shared network folder on a Mac, see your Mac documentation for instructions on creating the folder. The instructions here are for Windows.

First make sure you connected your product and computer to the same network.

**Note:** If you are running a Home version of the Windows operating system, you cannot create a shared folder on your Windows desktop or in the Documents or Pictures folder unless you have created a Home Group Configuration for sharing. You can, however, create a shared folder in the root of the C: drive on your system.

If you want to scan to a folder on an FTP server, contact the FTP server administrator for the server address and authentication access to a shared folder on the server.

1. If you are scanning to a network folder on your computer, do one of the following to check the format of your computer name:
  - **Windows 10 or Windows 8.x:** Hold down the Windows key on your keyboard and press the **X** key. Select **System** from the list that appears. Check the Computer Name or Device Name listed for your computer on the System window.
  - **Windows 7:** Click , right-click **Computer**, and select **Properties**. Check the Computer Name listed for your computer on the System window.

**Note:** The settings in these steps may vary, depending on your version of Windows. See Windows Help for details on your operating system.

2. If the computer's name uses any characters that are not alphanumeric (letters or numbers), do one of the following to change the computer's name:
  - **Windows 10 or 8.x:** Select **Rename this PC** and follow the on-screen prompts.
  - **Windows 7:** Select **Change Settings**, change the computer's name, and click **OK**. (See Windows Help for instructions, if necessary.)

**Note:** You need to be logged into Windows as an administrator to change the computer's name. After changing the name, restart your computer.

3. Start File Explorer or Windows Explorer.
4. Create a folder on the Windows desktop with a folder name of 12 characters or less; otherwise, your product may not be able to access the folder.

**Note:** You need to be logged into Windows as an administrator to access the desktop folder and the document folder under each User folder.

5. Right-click the folder you created and select **Properties**.
6. On the **General** tab, deselect the **Read-only** checkbox to allow users to access the folder over the network.
7. Select the **Sharing** tab and click the **Advanced Sharing** button.

**Note:** You need to be logged into Windows as an administrator to select the **Advanced Sharing** button.

8. On the Advanced Sharing screen, select the **Share this folder** checkbox.
9. Click the **Permissions** button and select the following on the Share Permissions tab:
  - Select **Everyone** under Group or user names.
  - Select the checkbox in the **Allow** column for the **Change** setting.
10. Click **OK** to save the settings, then click **OK** again to close the Advanced Sharing window.
11. Select the **Security** tab and check that the Group or user names list at the top includes the current computer user and the administrators who can now access the folder.
12. Select the **Sharing** tab again and write down the **Network Path** listed under Network File and Folder Sharing at the top. This is the path you will register to your product contacts list so you can select it for network scanning.

13. Click **OK** or **Close**.

Now you can register the folder path to your product contacts list.

**Parent topic:** [Setting Up and Scanning to a Network Folder or FTP Server](#)

### Registering Contacts for Network Folder or FTP Scanning - Web Config

You can register a list of contacts for scanning to a network folder or FTP server using Web Config and your computer's internet browser.

Before you begin, print a network status sheet and locate the IP address for your product on the sheet.

**Note:** These instructions use Internet Explorer as an example browser.

1. Start Internet Explorer on a computer that is using the same network as your product.
2. Type your product's IP address into the address bar and press **Enter**.
3. Click **Continue to this website (not recommended)**.
4. Click the **Scan/Copy** tab.
5. Click **Contacts**.
6. Select an empty number you want to use for the contact you are adding and click **Edit**.
7. Enter the following information for the contact:
  - **Name:** The name to display in your product's contact list.
  - **Index Word:** Enter a word to identify this entry when searching for it (up to 30 characters). This field is optional.
  - **Type:** Select **Network Folder (SMB)** or **FTP**.
  - **Assign to Frequent Use:** If you want to identify the contact as a frequently used address, select **On**. This makes it quicker to select the contact when you scan.
  - **Save to:** The network path to the shared folder.  
Enter the folder path name in one of the following formats depending on the **Type** setting you selected:
    - **SMB:** host\_name\folder
    - **FTP:** host\_name/folder\_name
  - **Secure Connection:** For FTP locations, select the secure connection type.
  - **User Name** and **Password:** Enter only if you have set up a password on your computer.



- **Connection Mode:** For FTP locations, select **Passive Mode** if there is a firewall between the product and FTP server.
  - **Port Number:** For FTP locations, enter the port number.
  - **Certificate Validation:** For FTP locations, choose to enable or disable an imported certificate.
8. Click **Apply**.  
After a moment, you see a message telling you that contact registration is complete.
  9. Close your web browser.

**Parent topic:** [Setting Up and Scanning to a Network Folder or FTP Server](#)

### Registering Contacts for Email, Network, or FTP Scanning - Control Panel

You can create a list of contacts for scanning to email or to a network folder or FTP.

**Note:** Contacts can be locked by an administrator. If you cannot access or change contacts, contact your administrator for assistance. You can create up to 200 contacts and contact groups combined (including fax contacts).

1. Press the  home button, if necessary.
2. Select **Settings > Contacts Manager > Register/Delete**.

You see a screen like this:

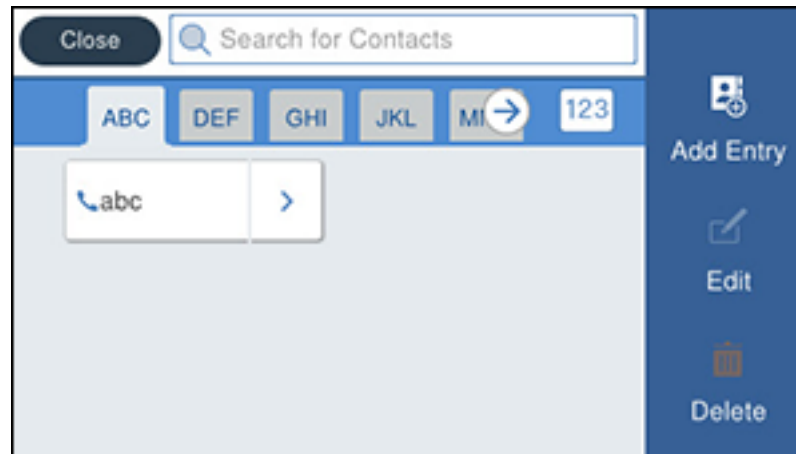

3. Select **Add Entry**.
4. Select **Add Contact**.
5. Do one of the following:
  - To create a contact for scanning to fax, select **Fax**.
  - To create a contact for scanning to email, select **Email**.
  - To create a location for scanning to a network folder or FTP, select **Network Folder/FTP**.
6. Select the number you want to use for the contact you are adding.
7. Select the **Name** field. Use the on-screen keyboard to enter the contact name (up to 30 characters) and select **OK**.
8. Select the **Index Word** field. Use the on-screen keyboard to enter a word to use when searching for an entry (up to 30 characters) and select **OK**. (This field is optional.)
9. Do one of the following:
  - For a fax contact, select the **Enter Fax Number** field. Use the displayed keyboard to enter the fax number and select **OK**.  
Select any other fax settings as necessary.
  - For an email contact, select the **Enter Email Address** field. Use the on-screen keyboard to enter the address and select **OK**.
  - For a network folder or FTP location, select the **Communication Mode** field and select an option. Then select the **Enter Location** field, use the on-screen keyboard to enter the location, and select **OK**. Enter other information if necessary.  
Enter the folder path name for the location setting in one of the following formats depending on the **Communication Mode** setting you selected:
    - **SMB**: \\host name\folder
    - **FTP**: ftp://host name/folder name
10. Select **OK**.

**Note:** If you need to edit or delete scanning contacts, the procedures are the same as for fax contacts.

**Parent topic:** [Setting Up and Scanning to a Network Folder or FTP Server](#)

### Scanning to a Network Folder or FTP Server

You can scan an image and save it to a network folder using your product's control panel. You can either enter the folder path directly on the product's control panel or select a folder from the **Destination** tab.

**Note:** Make sure the date and time are set correctly before using this feature.

1. Place your original on the product for scanning.

**Note:** To scan a double-sided or multi-page document, place your originals in the ADF.

2. Press the  home button, if necessary.
3. Select **Scan**.

You see a screen like this:

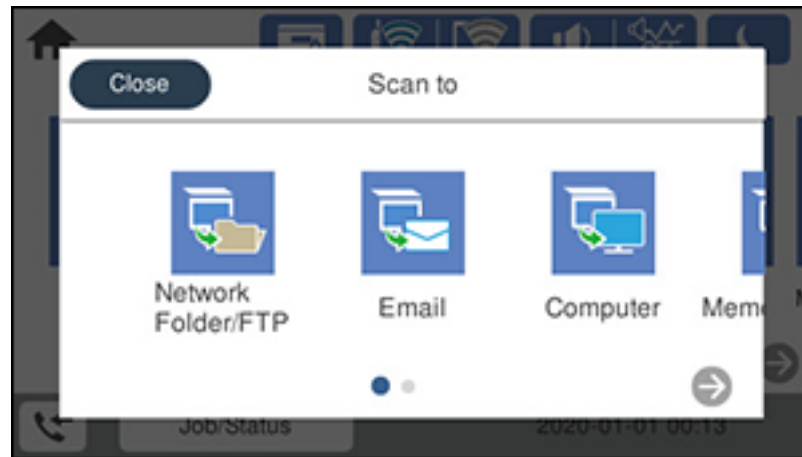

4. Select **Network Folder/FTP**.

You see a screen like this:

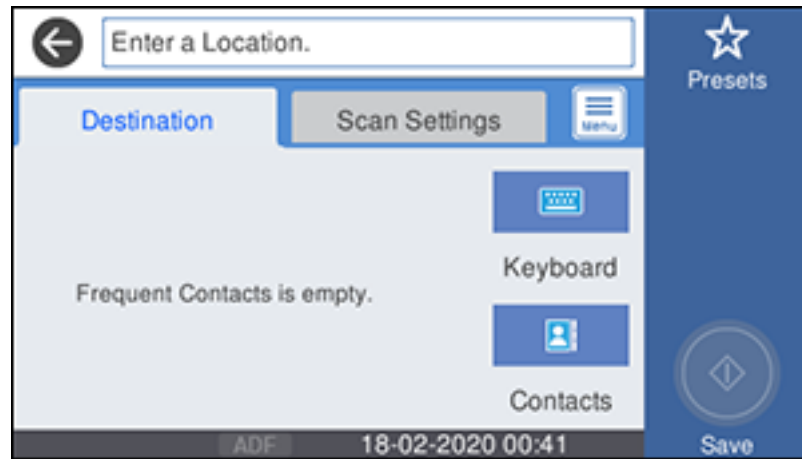

5. Do one of the following:
  - Choose a saved location on the **Destination** tab.
  - Select **Keyboard**, select the **Communication Mode** field, and select **Network Folder (SMB)** or **FTP**. Then select the **Enter Location** field, enter the folder location, and select **OK**. Enter other information as necessary.

Enter the folder path name for the location setting in one of the following formats depending on the **Communication Mode** setting you selected:

    - **SMB**: \\host name\folder
    - **FTP**: ftp://host name/folder name
    - Select an email address from any displayed frequent contacts.
6. Select **Scan Settings**.
7. Select **File Format** to choose the file format for your scan.
8. Scroll down to select **File Name** and change it if necessary.
9. Select any additional scan settings as necessary.

10. Select **Presets** to save your scan settings.

**Note:** Presets can be locked by an administrator. If you cannot access or change this setting, contact your administrator for assistance.

11. Select  **Save**.

Your product scans your original and saves it in the selected location.

**Parent topic:** [Setting Up and Scanning to a Network Folder or FTP Server](#)

**Related tasks**

[Entering Characters on the LCD Screen](#)

[Selecting the Date and Time](#)



**Related topics**

[Placing Originals on the Product](#)

## Starting a Scan Using the Epson Scan 2 Icon

You can start the Epson Scan 2 program to select scan settings, scan, and save the scanned image to a file.

**Note:** If you are using your Epson product with the Windows 10 S operating system, you cannot use the software described in this section. You also cannot download and install any Epson product software from the Epson website for use with Windows 10 S; you must obtain software only from the Windows Store.

- **Windows 10:** Click  and select **EPSON > Epson Scan 2**.
- **Windows 8.x:** Navigate to the **Apps** screen and select **Epson Scan 2**.
- **Windows (other versions):** Click  or **Start**, and select **All Programs** or **Programs**. Select **EPSON > Epson Scan 2 > Epson Scan 2**.
- **Mac:** Open the **Applications** folder, open the **Epson Software** folder, and select **Epson Scan 2**.

You see an Epson Scan 2 window like this:

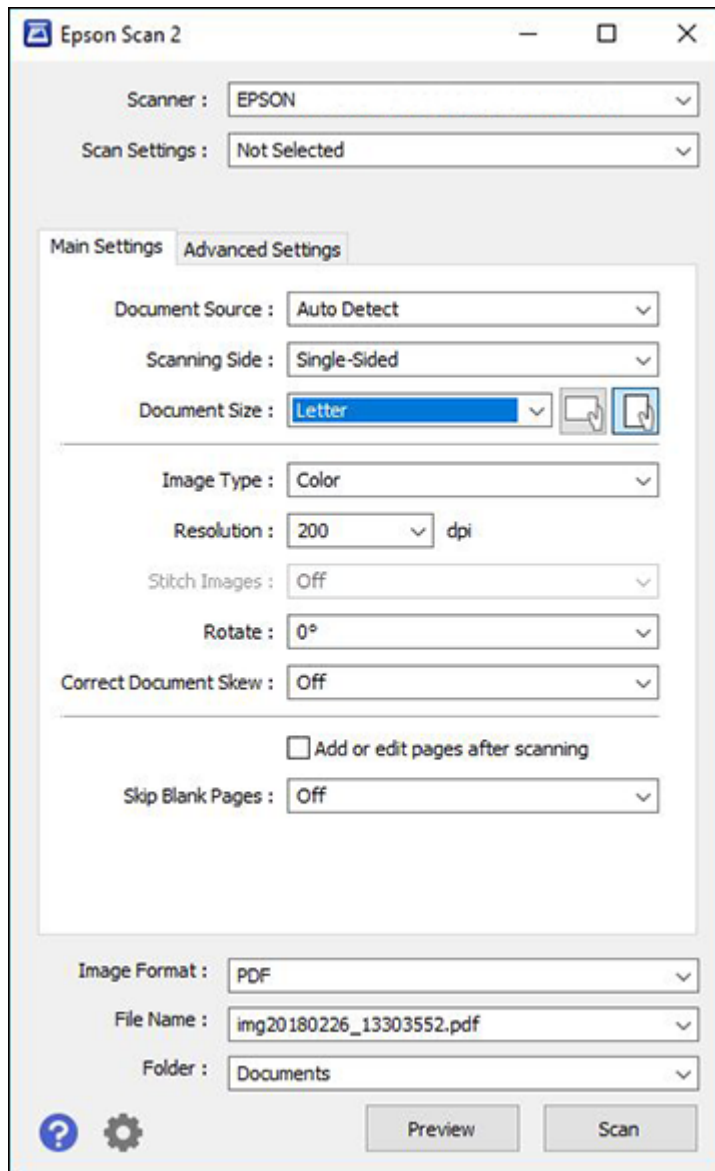

**Parent topic:** [Starting a Scan](#)

**Related tasks**

[Starting a Scan from a Scanning Program](#)

[Entering a User ID and Password for Scanning](#)

**Related topics**

[Placing Originals on the Product](#)

## Starting a Scan from a Scanning Program

You can start Epson Scan 2 from a TWAIN-compliant scanning program to select scan settings, scan, and open the scanned image in the program.

**Note:** If you are using your Epson product with the Windows 10 S operating system, you cannot use the software described in this section. You also cannot download and install any Epson product software from the Epson website for use with Windows 10 S; you must obtain software only from the Windows Store.

1. Open your scanning program and select its scanning option. (See your scanning program help for instructions.)
2. Select your product.

**Note:** In certain programs, you may need to select your product as the "source" first. If you see a **Select Source** option, choose it and select your product. With Windows, do not select a **WIA** option for your product; not all scan functions will be available.

You see an Epson Scan 2 window like this:

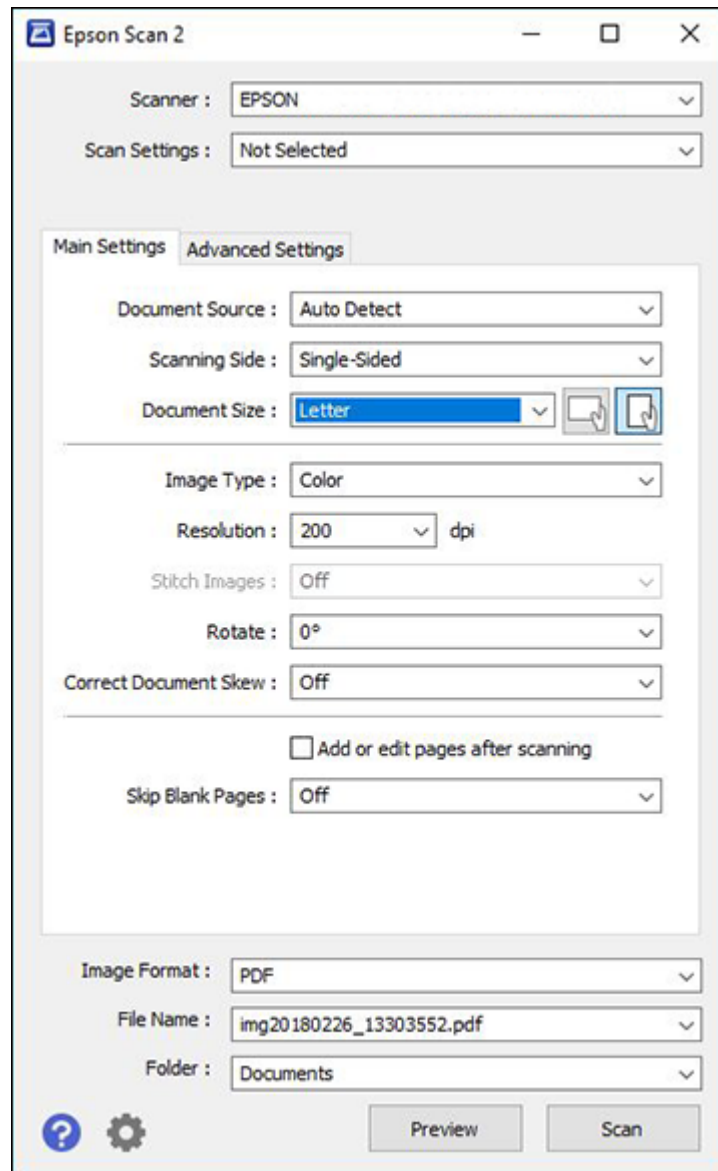



**Parent topic:** [Starting a Scan](#)

**Related tasks**

[Entering a User ID and Password for Scanning](#)

**Related topics**

[Placing Originals on the Product](#)

## Starting a Scan from a Smartphone or Tablet

You can start a scan from a smart device using the Epson iPrint app. You can save the scanned document to your device or a cloud service, e-mail it, or print it.

**Note:** If you are using your Epson product with the Windows 10 S operating system, you cannot use the software described in this section. You also cannot download and install any Epson product software from the Epson website for use with Windows 10 S; you must obtain software only from the Windows Store.

**Note:** Your device must be connected to the same wireless network as your Epson product.

1. Download the Epson iPrint app from your device's app store or from Epson's website.
2. Place your original on the product for scanning.
3. Open the Epson iPrint app and select your product.
4. Select the scan settings and scan your original.
5. Save your scanned image to a file or cloud location.

**Parent topic:** [Starting a Scan](#)

## Entering a User ID and Password for Scanning

If you enabled Access Control on your product, a user ID and password may be required to scan. You can enter the user ID and password in Epson Scan 2.

**Note:** If you do not know the user ID or password, contact your administrator for assistance.

1. Start Epson Scan 2.
2. Select **Settings** from the **Scanner** drop-down list.

You see this window:

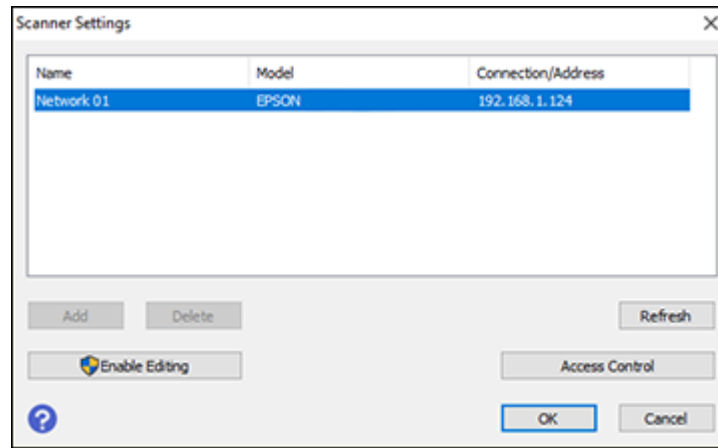



3. Select **Access Control**.
4. Enter your user name and password.
5. Click **OK**.

**Parent topic:** [Starting a Scan](#)

## Scanning a Document in Epson ScanSmart

You can scan and review documents and photos in Epson ScanSmart.

**Note:** The images in this guide show Windows screens. Mac screens may be slightly different. Depending on your product model and software version, not all options may be available.

1. Load your original into the product.
2. Open Epson ScanSmart on your computer. Do one of the following:
  - **Windows 10:** Click  > **Epson Software** > **Epson ScanSmart**.
  - **Windows 8.x:** Navigate to the **Apps** screen and select **Epson ScanSmart**.
  - **Windows (other versions):** Click  or **Start**, and select **All Programs** or **Programs**. Select **Epson Software** > **Epson ScanSmart**.

- **Mac:** Open the **Applications** folder, open the **Epson Software** folder, and select **Epson ScanSmart**.

You see a screen like this:

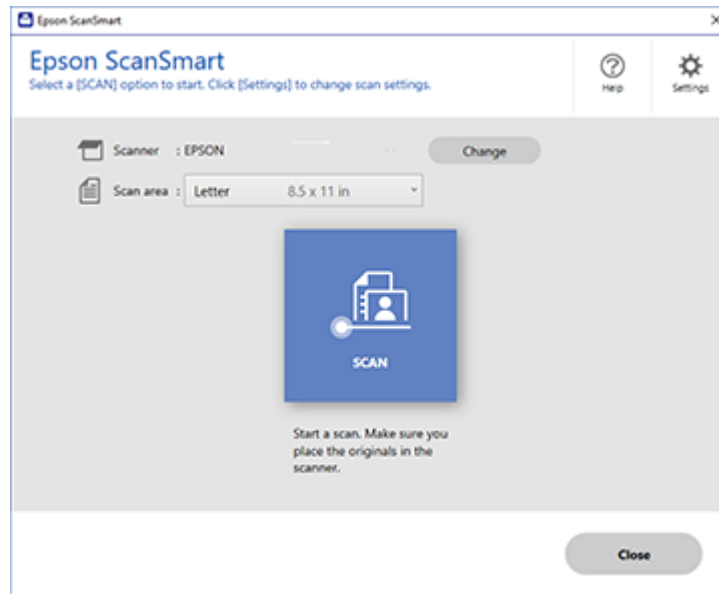

3. Select an option for the **Scan area** setting, if necessary.

**Note:** The **Scan area** setting limits the scan area to a selected size starting at the placement arrow on the scanner bed. It does not scale the image to the selected size.

4. Select **SCAN**.

The original is scanned. When scanning is complete, you see a screen like this:

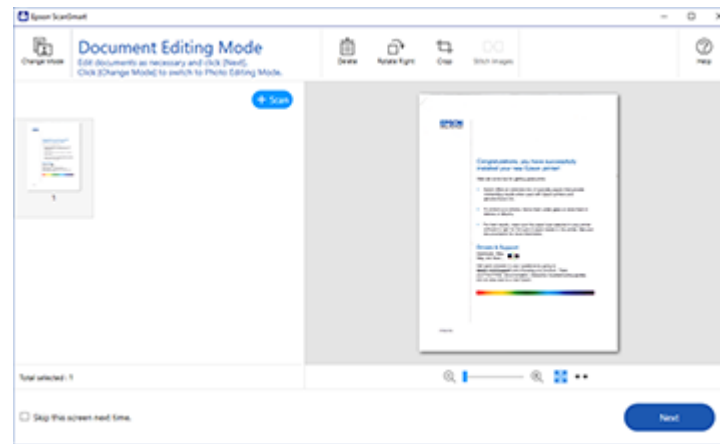

5. You can review, edit, or reorder the scanned images as follows:
  - Select **+ Scan** to scan more originals.
  - Select **Delete** to delete selected scanned images.
  - Select **Rotate Right** to rotate each scanned image.
  - Select **Crop** to crop the selected image.
  - Control-click two images, select **Stitch Images**, and follow the on-screen instructions to combine them into a single image.
6. If Photo Mode is automatically detected, the following enhancement options are available:
  - **Auto Color Enhancement**: automatically adjusts the brightness, contrast, and saturation of your photos
  - **Restore Faded Colors**: restores the colors in faded photos automatically
  - **Remove Red Eye**: automatically removes the red-eye effect from your photos
  - **Auto Cropping**: automatically crops the scanned image edges
7. When you finish reviewing and editing the scanned images, click **Next**.

You see a screen like this:

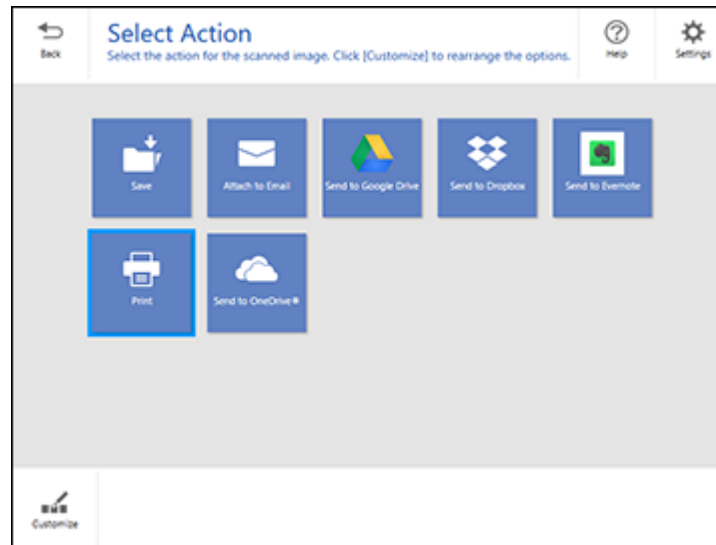

8. Select an option to save, send, or print the scanned images. See the links below.

[Saving a Scan](#)

[Attaching a Scan to Email](#)

[Sending a Scan to a Cloud Service](#)

[Printing a Scan](#)

**Parent topic:** [Scanning](#)

## **Saving a Scan**

You can save a scanned image to your computer in a variety of formats.

1. Make sure your originals are scanned and reviewed. See the link below.
2. In the **Select Action** window, click **Save**.

You see a screen like this:

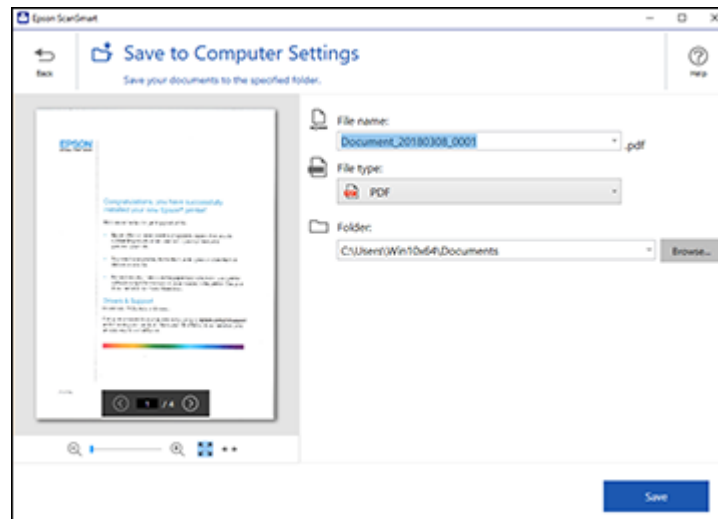

3. Change the settings as follows:
  - The document type and scan date for the file name are automatically detected. You can change them as necessary.
  - You can save the scanned image in a variety of formats. If you select Searchable PDF as the **File type** setting, you can select the OCR (Optical Character Recognition) language.
  - Select the folder on your computer where the document is saved.
4. Click **Save**.

**Parent topic:** [Scanning a Document in Epson ScanSmart](#)

## Attaching a Scan to Email

You can attach a scanned image to an email as a file attachment.

**Note:** Your email app and account settings should be configured before scanning. You must install a MAPI-type email program such as Outlook Express, Windows Live Mail, Entourage, or Mac Mail. Web-based email services such as Gmail are not supported. If you do not have a supported email program, you see an error message.

1. Make sure your originals are scanned and reviewed. See the link below.
2. In the **Select Action** window, click **Attach to Email**.

You see a screen like this:

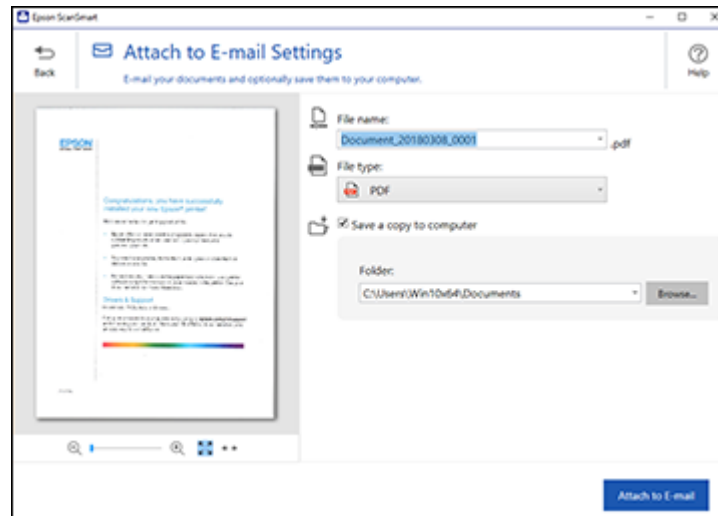

3. Change the settings as follows:
  - The document type and scan date for the file name are automatically detected. You can change them as necessary.
  - You can save the scanned image in a variety of formats. If you select Searchable PDF as the **File type** setting, you can select the OCR (Optical Character Recognition) language.
  - If you also want to save a copy of the scanned image to your computer, make sure the checkbox is selected and select the folder on your computer in which to save the file.
4. Click **Attach to E-mail**.

Your email program opens with the file attached to a new email.

**Parent topic:** [Scanning a Document in Epson ScanSmart](#)

## **Sending a Scan to a Cloud Service**

You can upload scanned images to a cloud service.

1. Make sure your originals are scanned and reviewed. See the link below.

- In the **Select Action** window, click one of the cloud service send options.  
You see a screen like this:

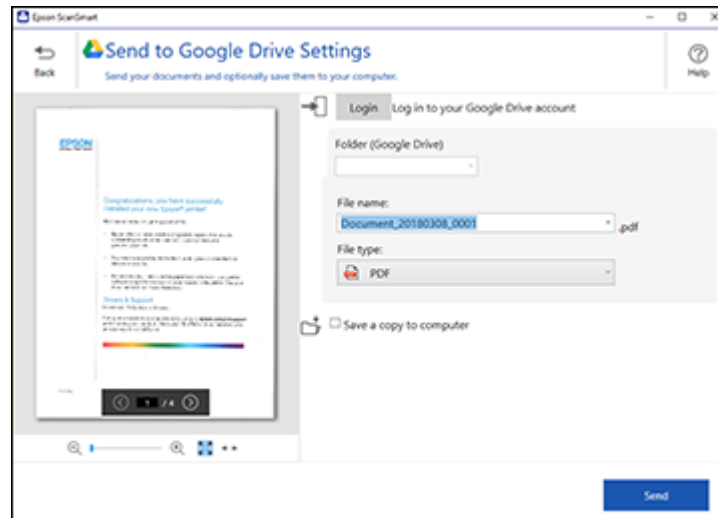

- Log in to your account.

**Note:** You may need to allow Epson ScanSmart access to your account. The first time you log in, you may be prompted to enter an authentication code.

- Change the settings as follows:
  - Select the folder in your account where you want to send the document.
  - The document type and scan date for the file name are automatically detected. You can change them as necessary.
  - You can save the scanned image in a variety of formats. If you select Searchable PDF as the **File type** setting, you can select the OCR (Optical Character Recognition) language.
  - If you also want to save a copy of the scanned image to your computer, click the checkbox.
- Click **Send**.

**Parent topic:** [Scanning a Document in Epson ScanSmart](#)



## Printing a Scan

You can print your scanned image and save the scanned file to your computer.

**Note:** Printing scanned images is available only with Epson printers.

1. Make sure your originals are scanned and reviewed. See the link below.
2. In the **Select Action** window, click **Print**.

You see a screen like this:

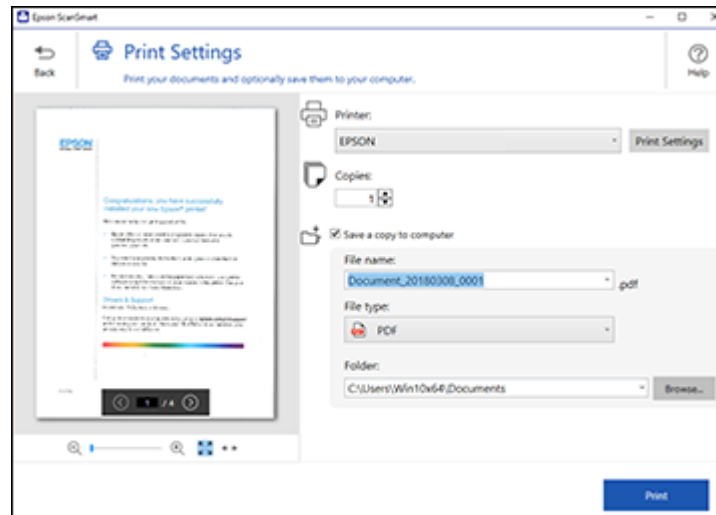

3. Change the settings as follows:
  - Select the Epson printer and change the print settings, if necessary.
  - Select the number of copies you want to print.
  - If you also want to save a copy of the scanned image to your computer, click the checkbox.
  - The document type and scan date for the file name are automatically detected. You can change them as necessary.
  - You can save the scanned image in a variety of formats. If you select Searchable PDF as the **File type** setting, you can select the OCR (Optical Character Recognition) language.
  - Select the folder on your computer in which to save the file.

4. Click **Print**.

**Parent topic:** [Scanning a Document in Epson ScanSmart](#)

## Selecting Epson ScanSmart Settings

After starting Epson ScanSmart, you can change various scanning settings.

[Changing the Epson Product](#)

[Changing the Scan Settings](#)

[Changing the File Name Settings](#)

[Changing the Save Settings](#)

[Customizing Action Icons](#)

**Parent topic:** [Scanning](#)

## Changing the Epson Product

If you are using more than one Epson product with Epson ScanSmart, you can change the product that you are using with your computer.

**Note:** A product connected to your computer via USB takes priority over a product with a Wi-Fi connection.

1. On the main screen, click **Change**.

You see a screen like this:

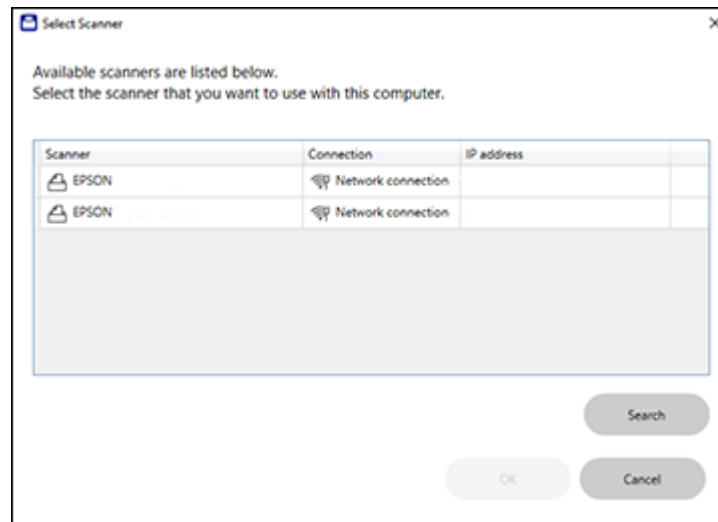

2. Select the Epson product you want to use with your computer and click **OK**.

Parent topic: [Selecting Epson ScanSmart Settings](#)

## Changing the Scan Settings

You can change detailed scan settings such as the resolution, document size, and more.

**Note:** If you select **Auto Mode**, you cannot change the scan settings.

1. Click the  **Settings** button.

You see a screen like this:

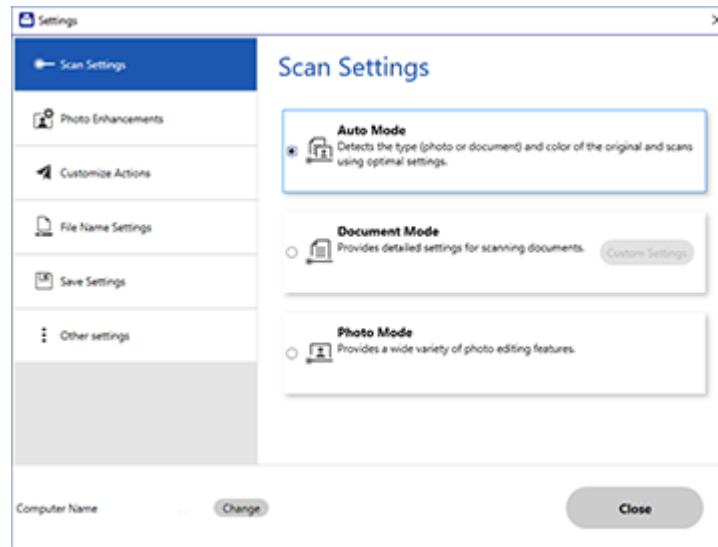

2. Do one of the following:

- To change Document Mode settings, select **Document Mode > Custom Settings**.
- To change Photo Mode settings, select **Photo Mode** and click **Close**. When you start a scan, you will be prompted to select scan settings.

You see a screen like this:

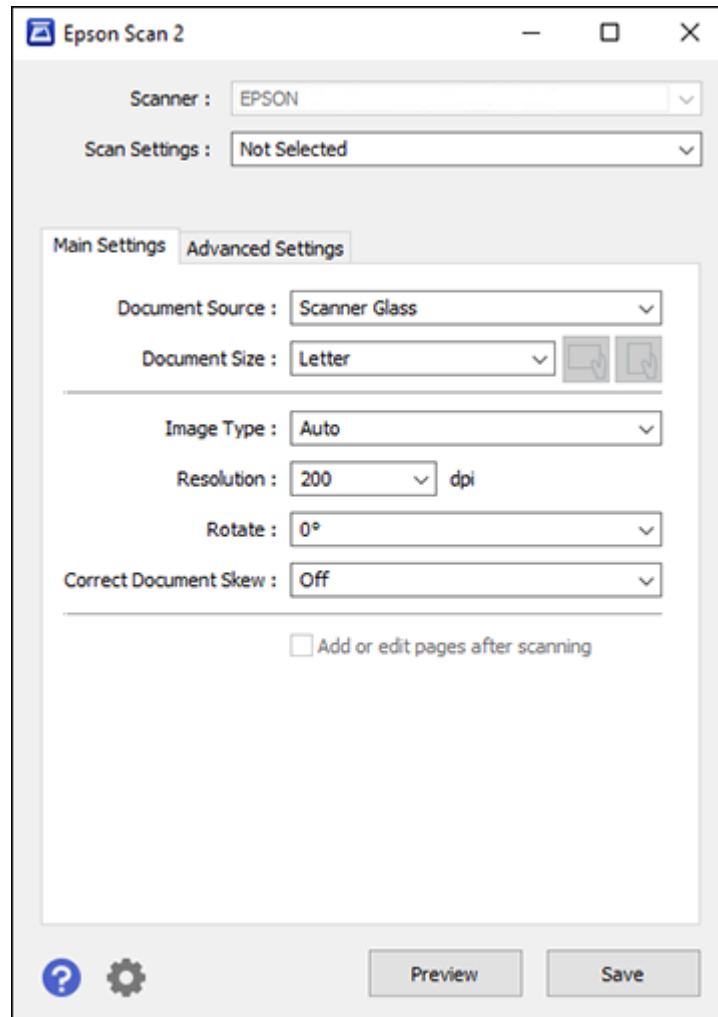

3. Change the settings as necessary and click **Save**.

**Parent topic:** [Selecting Epson ScanSmart Settings](#)

## Changing the File Name Settings

You can change the default file naming method for your scans.

1. Click the  **Settings** button.

You see a screen like this:

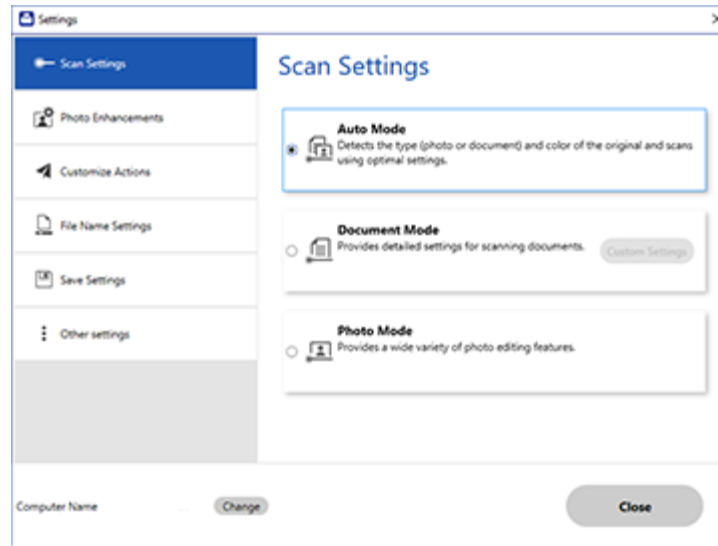

2. Click the **File Name Settings** tab.

You see a screen like this:

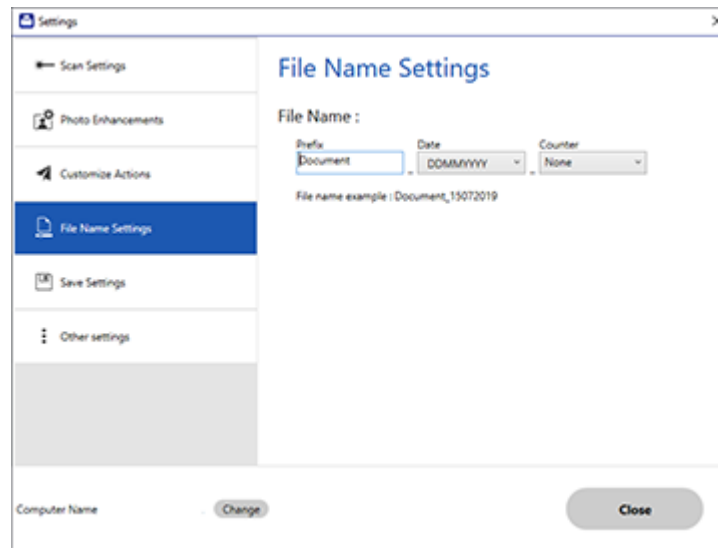

3. Change the settings as necessary:
  - Enter a prefix for the file name.
  - Select the date format.
  - Select a numbering format as the counter format.

4. Click **Close**.

**Parent topic:** [Selecting Epson ScanSmart Settings](#)

## Changing the Save Settings

You can change the file type options for saving your scans.

1. Click the  **Settings** button.

You see a screen like this:

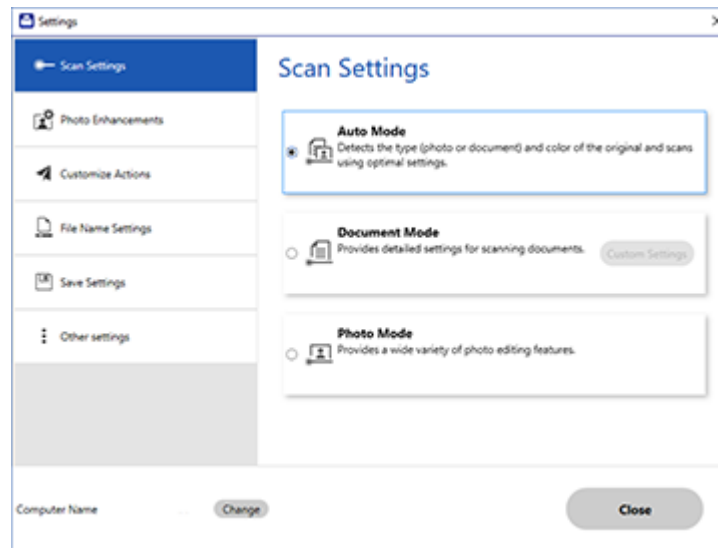

2. Click the **Save Settings** tab.



You see a screen like this:

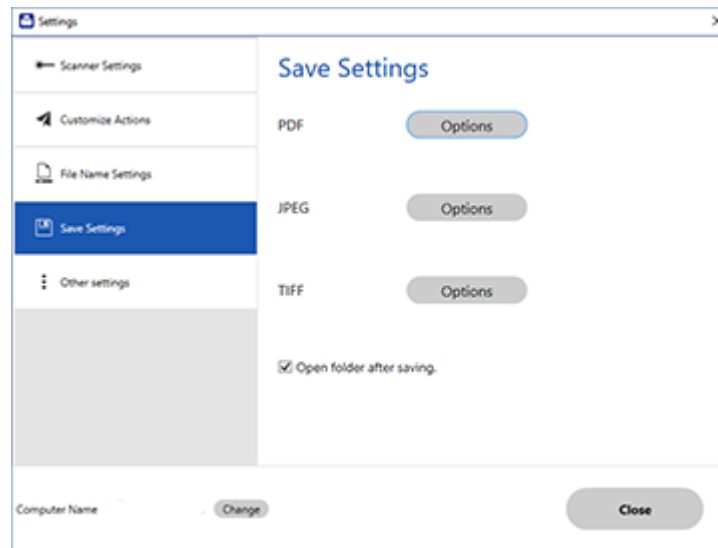

3. Click **Options** for a file format and change the settings as necessary.
4. Click **Open folder after saving** to open the file folder after a file is saved.
5. Click **Close**.

[Save Settings](#)

**Parent topic:** [Selecting Epson ScanSmart Settings](#)

## Save Settings

You can change the settings for how scanned images are saved.

### PDF Options

Setting	Options	Description
<b>General</b>	<b>Generate PDF/A File</b>	Creates a PDF that conforms to PDF/A-1 standards
	<b>Create file with all pages</b>	Saves all pages as one file
	<b>Compression Level</b>	Selects the compression level for color or grayscale images

### JPEG Options

Setting	Options	Description
<b>Image Quality Options</b>	—	Sets a compression level by moving a slider or entering a value. File size increases the higher the resolution is.
<b>Encoding</b> (Windows only)	<b>Standard</b>	Images load from top to bottom in a web browser. It takes longer to load the entire image.
	<b>Progressive</b>	Images first load completely at low resolution and then adjust to high resolution in a web browser
<b>Embed ICC Profile</b> (Windows only)	—	Allows you to add ICC profiles to the image

### TIFF Options

Setting	Options	Description
<b>Byte Order</b>	<b>Windows</b> <b>Macintosh</b>	Specifies the operating system where the scanned image will be used
<b>Compression</b> (Windows only)	—	Specifies the compression format and level for Color/Grayscale and B&W images. File size increases with higher quality.
<b>Embed ICC Profile</b> (Windows only)	—	Allows you to add ICC profiles to the image

Parent topic: [Changing the Save Settings](#)

## Customizing Action Icons

You can customize which scan action icons appear on the **Select Action** screen.

**Note:** You can also customize them by clicking the **Customize** icon on the **Select Action** screen.

1. Click the  **Settings** button.

You see a screen like this:

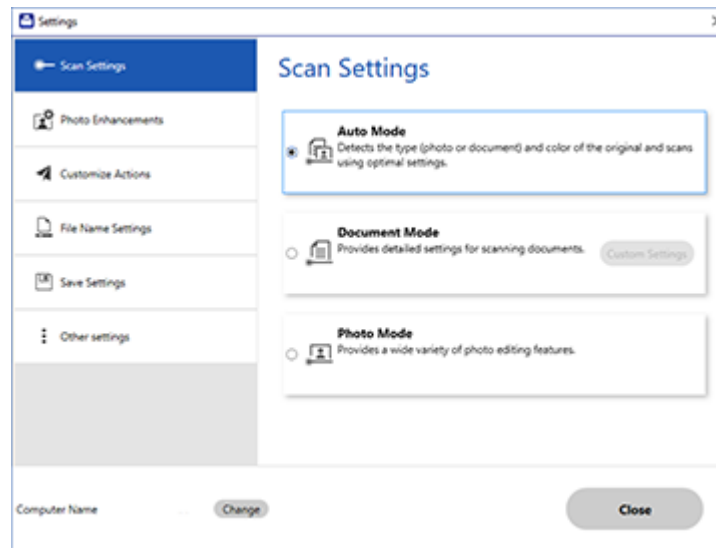

2. Click the **Customize Actions** tab.

You see a screen like this:

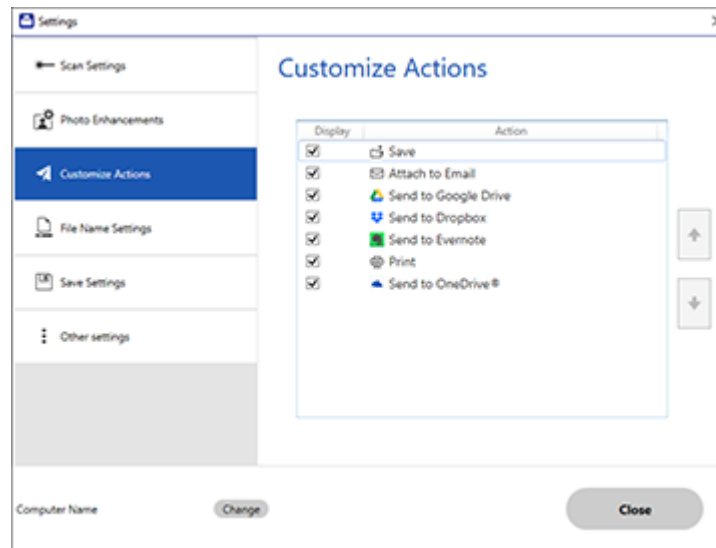

3. Choose which action icons to display by selecting or deselecting each checkbox. Click the arrow icons to move the icons up or down in the display order you want.
4. Click **Close**.

**Parent topic:** [Selecting Epson ScanSmart Settings](#)

## Scanning in Epson Scan 2

Epson Scan 2 gives you access to basic and advanced scanning features. You can scan your document and save the scanned image in various file formats in your operating system's Documents or My Documents folder, or open it in your scanning program. You can preview the scanned image and select or change settings as necessary.

**Note:** If you are using your Epson product with the Windows 10 S operating system, you cannot use the software described in this section. You also cannot download and install any Epson product software from the Epson website for use with Windows 10 S; you must obtain software only from the Windows Store.

1. Start Epson Scan 2.

You see this window:

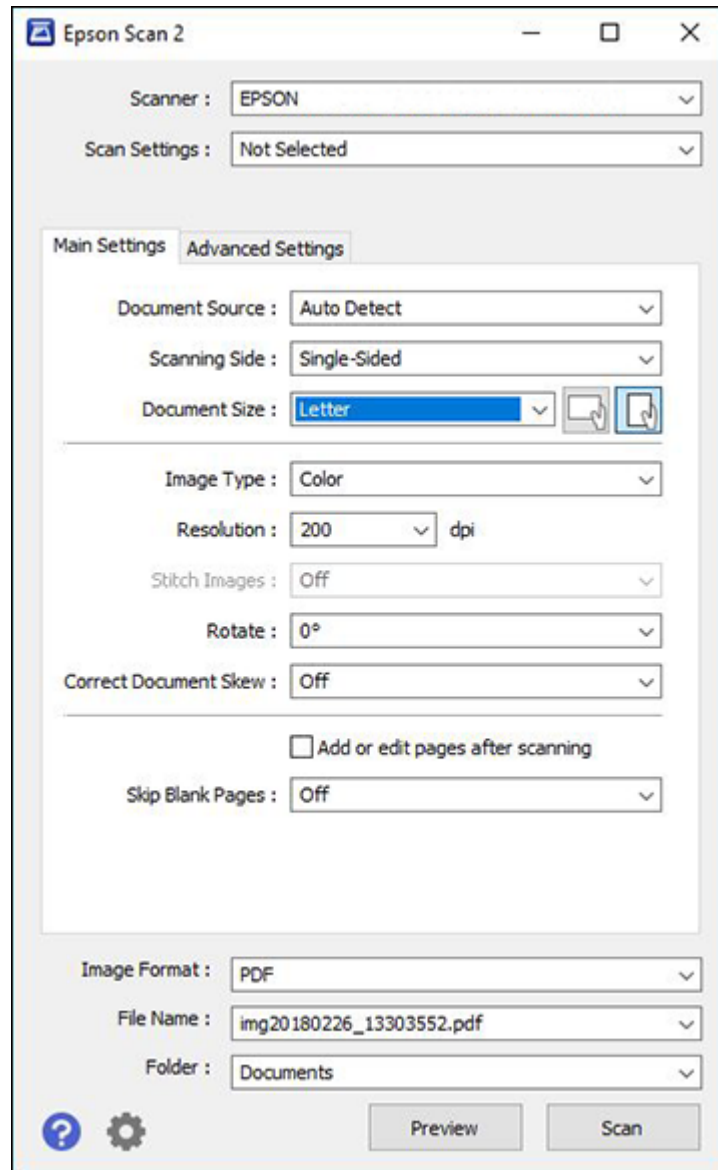

2. Select the **Document Source** setting that matches where you placed your original, or select **Auto Detect** to have Epson Scan 2 automatically detect the source.
3. Select the **Scanning Side** setting if you are scanning from the ADF.
4. Select the **Document Size** setting that matches the size of your original, or select **Auto Detect** to have Epson Scan 2 automatically detect the size. You can select **Customize** to enter a custom size, if necessary.
5. Select the image type of your original and how you want it scanned as the **Image Type** setting.
6. Select the **Resolution** setting you want to use for your scan.
7. Select the **Rotate** setting to rotate the scanned image.
8. Select the **Correct Document Skew** setting to correct skewed originals, image contents, or both.
9. Click the **Preview** button.

Epson Scan 2 previews your original and displays the results in the Epson Scan 2 window.

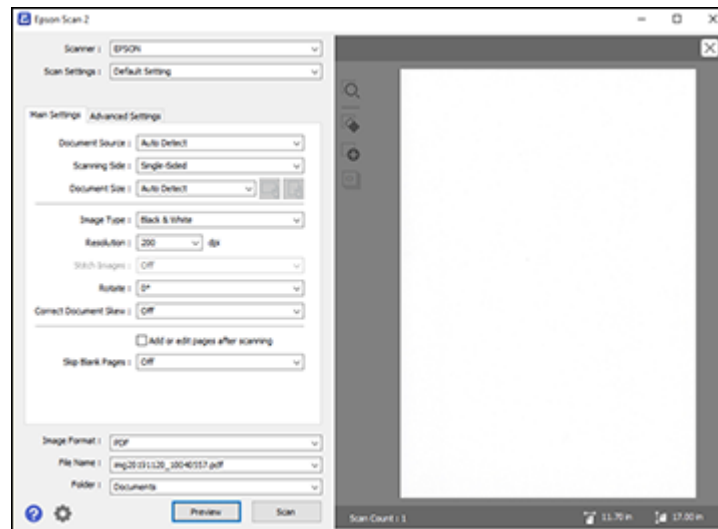

10. Reinsert your original into the ADF, if necessary.
11. Select any of the additional settings that you want to use on the Main Settings tab.
12. Click the **Advanced Settings** tab and select any settings that you want to use.

13. Select the format in which you want to save your scanned file as the **Image Format** setting. If necessary, select **Options** and select any desired format options.
14. Enter the file name for your scanned file in the **File Name** field. If necessary, select **Settings** to modify the file name settings.
15. Select the location in which you want to save your scanned file as the **Folder** setting. If necessary, select **Select** to create a new folder.
16. Click **Scan**.

The product scans your original and saves the scanned file in the location you specified.

[Available Document Source Settings](#)

[Additional Scanning Settings - Main Settings Tab](#)

[Additional Scanning Settings - Advanced Settings Tab](#)

[Saving Scanned Documents as a Searchable PDF Using Epson Scan 2](#)

[Image Format Options](#)

[Scan Resolution Guidelines](#)

**Parent topic:** [Scanning](#)

**Related topics**

[Placing Originals on the Product](#)

## Available Document Source Settings

You can select these Document Source options in Epson Scan 2:

### **Auto Detect**

Automatically detects where the originals are placed on your product for scanning.

### **ADF**

Selects the Automatic Document Feeder as the location where the originals are placed on your product for scanning.

### **Scanner Glass**

Selects the scanner glass as the location where the originals are placed on your product for scanning.

**Parent topic:** [Scanning in Epson Scan 2](#)

## Additional Scanning Settings - Main Settings Tab

You can select these additional scanning settings on the Epson Scan 2 Main Settings tab. Not all adjustment settings may be available, depending on other settings you have chosen.

**Stitch Images**

When scanning double-sided originals, lets you lay out images from both sides of the original onto one scanned page.

**Rotate**

Rotates the original image clockwise to the desired angle before scanning it. Select **Auto** to allow your product to automatically rotate the image based on the orientation of the text (may take longer to scan).

**Correct Document Skew**

Corrects skewed originals, image contents, or both.

**Add or edit pages after scanning**

Lets you add, remove, or edit the pages in a scan, including rotating pages and changing the page order.

**Note:** To save multiple pages in a single file, you must select a file format that supports multiple pages such as **PDF** or **Multi-TIFF**. If you select another file format, each scanned image or page is saved as a separate file.

**Skip Blank Pages**

If the scanner detects marks from the other side of a blank page and adds the marks to the scanned image, adjust this setting to prevent this.

Parent topic: [Scanning in Epson Scan 2](#)

## Additional Scanning Settings - Advanced Settings Tab

You can select these additional scanning settings on the Epson Scan 2 Advanced Settings tab. Not all adjustment settings may be available, depending on other settings you have chosen.

**Remove Background**

Removes the background of the originals.

**Text Enhancement**

Sharpens the appearance of letters in text documents.

**Auto Area Segmentation**

Makes black and white images clearer and text recognition more accurate by separating the text from the graphics.

**Threshold**

Adjusts the level at which black areas in text and line art are delineated, improving text recognition in OCR (Optical Character Recognition) programs.



**Color Enhance**

Enhances the shades of the color you select in the scanned image. This setting is available only if you select **Grayscale** or **Black & White** as the Image Type setting.

**Brightness**

Adjusts the overall lightness and darkness of the scanned image.

**Contrast**

Adjusts the difference between the light and dark areas of the overall scanned image.

**Gamma**

Adjusts the midtone density of the scanned image.

**Unsharp Mask**

Makes the edges of certain image areas clearer. Turn off this option to leave softer edges.

**Descreening**

Removes the ripple pattern that might appear in subtly shaded image areas, such as skin tones. This option improves results when scanning magazines or newspapers. (The results of descreening do not appear in the preview image, only in your scanned image.)

**Edge Fill**

Corrects shadowing around the edges of the image by filling the shadows with black or white.

**Dual Image Output**

Scans the original image twice using different output settings (Windows only).

Parent topic: [Scanning in Epson Scan 2](#)

## Saving Scanned Documents as a Searchable PDF Using Epson Scan 2

You can scan a document and save the text in a searchable PDF. In a searchable PDF, text is recognized using Optical Character Recognition (OCR) and then embedded in the scanned original.

**Note:** The required Epson Scan 2 OCR Component is installed automatically when you install your product software as instructed on the *Start Here* sheet. If you install your scanner software programs individually, be sure to also install this component if you want to perform OCR.

1. Load your original in the product for scanning.
2. Start Epson Scan 2.
3. Select your scan settings.
4. Click **Preview** and adjust the area you want to scan, if necessary.
5. If you are using the ADF, reload the ejected original.

6. Select **Searchable PDF** as the Image Format setting.
7. Select **Options** from the Image Format list.

You see this window:

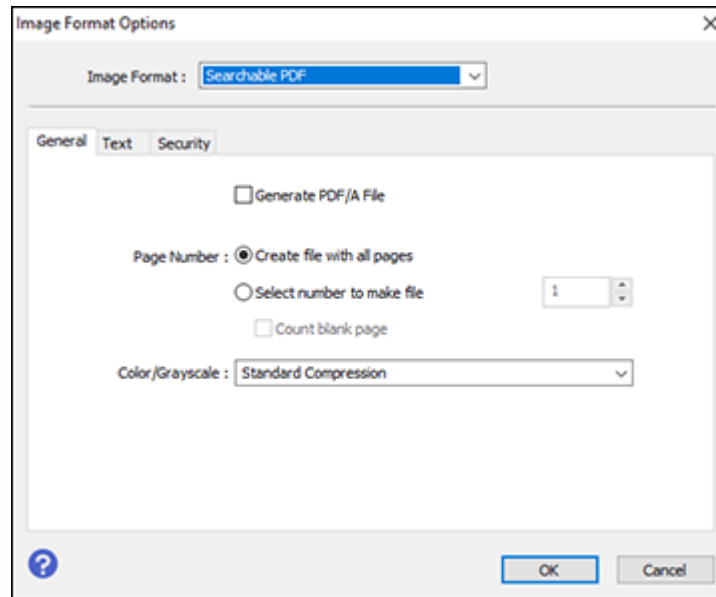

8. Select any of the options on the **General** tab.
9. Select the **Text** tab.
10. Make sure the language used in the document text is selected as the **Text Language** setting.
11. Select the **Security** tab if you want to add a password to the PDF or protect printing or editing properties.
12. Click **OK**.
13. Confirm the **File Name** setting and select a **Folder** setting for your document.
14. Click **Scan**.

The scanned image is saved as a searchable PDF.

**Parent topic:** [Scanning in Epson Scan 2](#)

## Related topics

[Placing Originals on the Product](#)

## Image Format Options

You can select different image formats and related options. For details on available options, click the ? icon on the Epson Scan 2 Image Format Options window. Not all image formats have options.

### **BITMAP (\*.bmp)**

A standard image file format for most Windows programs.

### **JPEG (\*.jpg)**

An image format that lets you highly compress image data. However, the higher the compression, the lower the image quality. (The TIFF format is recommended when you need to modify or retouch your scanned image.)

### **PNG (\*.png)**

An image format that does not lose quality during editing.

### **TIFF (\*.tif)**

A file format created for exchanging data between many programs, such as graphic and DTP software.

### **Multi-TIFF (\*.tif)**

A TIFF file format when multiple pages are saved to the same file, allowing you to edit the images using a compatible program.

### **PDF (\*.pdf)**

A document format that is readable by Windows and Mac systems using Adobe Reader, Acrobat, or other programs. You can save multi-page documents in one PDF file.

### **Searchable PDF (\*.pdf)**

A document format that is readable by Windows and Mac systems using Adobe Reader, Acrobat, or other programs. You can save multi-page documents in one PDF file. Recognized text in the scanned document can be searched.

**Parent topic:** [Scanning in Epson Scan 2](#)

## Scan Resolution Guidelines

The **Resolution** setting, measured in dpi (dots per inch), controls the amount of detail captured in your scans. Increasing the resolution raises the amount of detail captured but comes with the following disadvantages:

- Larger file sizes
- It takes longer to scan your originals, send/receive your scans by email or fax, and to print your scans

- The image may become too large to fit on your display or print on paper

If you plan to enlarge a scanned image so you can print it at a larger size, you may need to increase the resolution from the default resolution set by Epson Scan 2. Follow these guidelines to determine the resolution setting you need:

- You will scan the image at its original size but enlarge it later in an image-editing program.

Increase the Epson Scan 2 Resolution setting in your scan. Increase the resolution by the same amount you will increase the image size to retain a high image quality. For example, if the resolution is 300 dpi (dots per inch) and you will double the image size later, change the Resolution setting to 600 dpi.

- You will scan the image at 100% or a smaller size.

Select the Epson Scan 2 Resolution setting based on how you will use the scanned image:

- Email/view on a computer screen/post on the web: 96 to 200 dpi
- Print/fax/convert to editable text (OCR)/create searchable PDF: 200 to 300 dpi

**Parent topic:** [Scanning in Epson Scan 2](#)

---

## Faxing

See these sections to fax using your product.

**Note:** This product allows you to store names, telephone numbers, and fax data in its memory even when the power is turned off. Make sure you restore all of the default settings if you give away or dispose of the product. This will erase all of your network settings and fax data.

[Connecting a Telephone or Answering Machine](#)

[Setting Up Fax Features](#)

[Setting Up Contacts and Contact Groups](#)

[Sending Faxes](#)

[Receiving Faxes](#)

[Checking Fax Status](#)

[Printing Fax Reports](#)

## Connecting a Telephone or Answering Machine

You must connect your product to a telephone wall jack to send or receive faxes. If you want to use the same telephone line to receive calls, you can connect a telephone or answering machine to your product using an additional phone cable.

**Note:** If you do not connect a telephone to your product, make sure Receive Mode is set to **Auto**. Otherwise, you cannot receive faxes.

1. Connect a phone cable to your telephone wall jack and to the **LINE** port on your product.

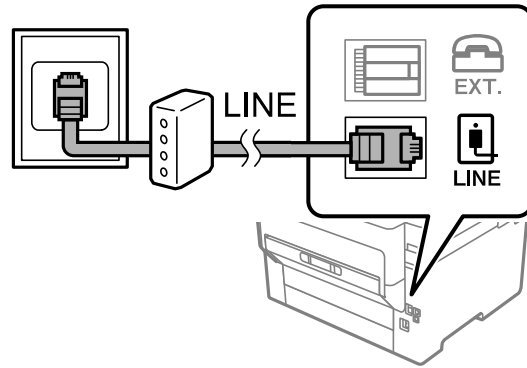

**Note:** If you have a DSL or ISDN connection, you must connect the appropriate DSL filter, or ISDN terminal adapter or router to the wall jack to be able to use the line for faxing or voice calls using your product. Contact your DSL or ISDN provider for the necessary equipment.

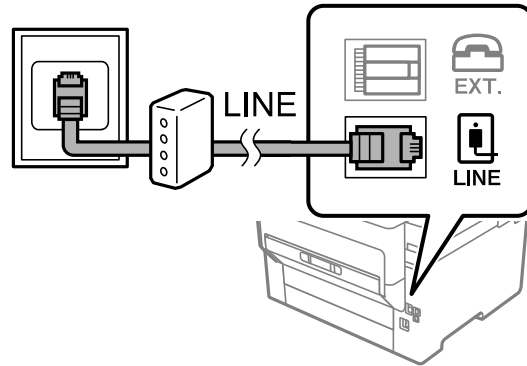

2. If you are connecting a telephone or answering machine to your product using a second phone cable, remove the cap from the **EXT** port on your product.

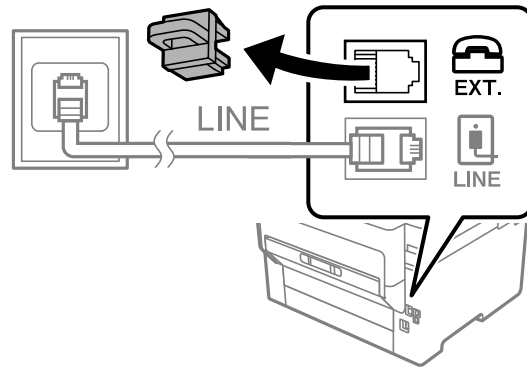

3. Connect a second phone cable to your telephone or answering machine and to the **EXT** port on your product.

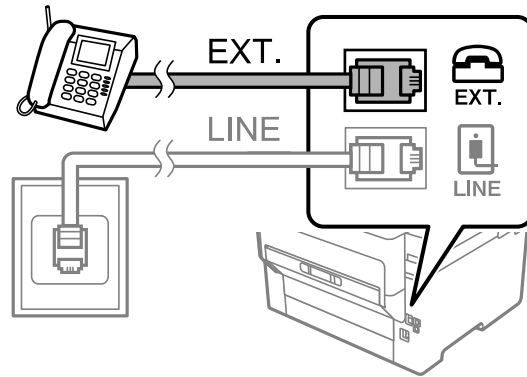

**Note:** If you connect an answering machine and Receive Mode is set to **Auto**, set the number of rings before your product answers a call to a number that is higher than your answering machine's setting for the number of rings.

**Parent topic:** [Faxing](#)

**Related references**

[Cannot Receive Faxes with a Telephone Connected to Your Product](#)

### Related tasks

[Using the Fax Setup Wizard](#)  
[Receiving Faxes Automatically](#)

## Setting Up Fax Features

Before faxing with your product, set up your fax header and select the fax features you want to use.

**Note:** If you leave your product unplugged for a long period of time, you may need to reset the date and time settings for faxes.

[Setting Up Basic Fax Features](#)  
[Selecting Advanced Fax Settings](#)  
[Setting Up the Fax Utility - Windows](#)  
[Setting Up Fax Features Using the Fax Utility - Mac](#)

**Parent topic:** [Faxing](#)

## Setting Up Basic Fax Features

See these sections to select the basic settings you need to use the product's fax features.

[Using the Fax Setup Wizard](#)  
[Selecting the Line Type](#)  
[Setting the Number of Rings to Answer](#)

**Parent topic:** [Setting Up Fax Features](#)

### Using the Fax Setup Wizard

You can setup the product's basic fax settings using the Fax Setting Wizard. This wizard is automatically displayed when the product is turned on for the first time. You can also change these settings individually from the Fax Settings menu.

**Note:** These settings can be locked by an administrator. If you cannot access or change these setting, contact your administrator for assistance.

1. Press the  home button, if necessary.
2. Select **Settings > General Settings > Fax Settings > Fax Setting Wizard**.



You see a screen like this:



3. Select **Proceed**.
4. On the Fax Header screen, use the displayed keypad to enter the sender name for your fax source, such as your name or a business name. You can enter up to 40 characters. Select **OK** when you are done.
5. On the Your Phone Number screen, use the displayed keypad to enter your fax number, up to 20 characters. Select **OK** when you are done.

**Note:** The name and phone number in the fax header identifies the source of the faxes you send.

6. On the Distinctive Ring Setting screen, do one of the following:
  - If you have subscribed to a distinctive ring service from your telephone company, select **Proceed**. Select the ring pattern to be used for incoming faxes or select **All**. Go to the next step.
  - If you do not have a distinctive ring service, select **Skip** and go to step 9.

**Note:** Distinctive ring services allows you to have several phone numbers on one phone line. Each number is assigned a different ring pattern. You can use one number for voice calls and another for fax calls. Select the ring pattern assigned to fax calls in the DRD Setting. If you select a ring pattern other than **All**, Receive Mode is automatically set to **Auto**.

7. On the Proceed screen, confirm the displayed settings and select **Proceed**, or press the back arrow to change the settings.
8. On the Run Check Fax Connection screen, select **Start Checking** and follow the on-screen instructions to check the fax connection and print a report of the check result. If there are any errors reported, try the solutions on the report and run the check again.

If the Select Line Type screen appears, select the correct line type.

If the Dial Tone Detection screen appears, select **Do Not Detect**. However, disabling the dial tone detection function may drop the first digit of a fax number and send the fax to the wrong number.

**Parent topic:** [Setting Up Basic Fax Features](#)

### Selecting the Line Type

If you connect the product to a PBX phone system or terminal adapter, you must change the product's line type. PBX (Private Branch Exchange) is used in office environments where an external access code such as "9" must be dialed to call an outside line. The default Line Type setting is PSTN (Public Switched Telephone Network), which is a standard home phone line.

**Note:** This setting can be locked by an administrator. If you can't access or change this setting, contact your administrator for assistance.

1. Press the  home button, if necessary.
2. Select **Settings > General Settings > Fax Settings > Basic Settings > Line Type > PBX**.

You see a screen like this:

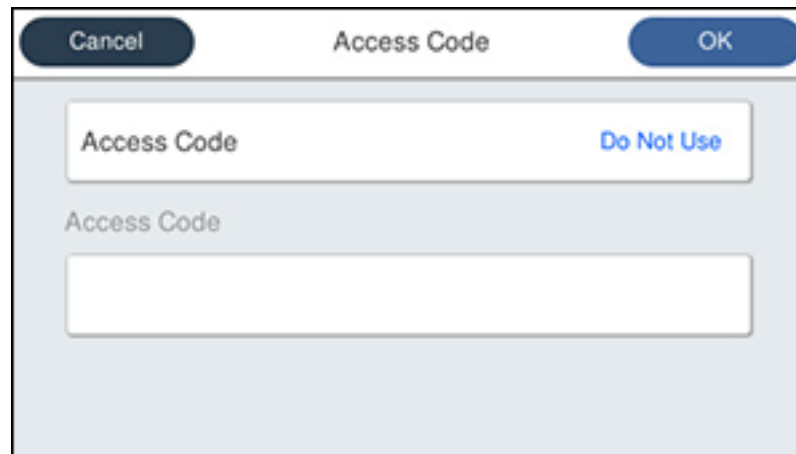

The screenshot shows a mobile application interface for setting an access code. At the top, there is a title bar with three buttons: 'Cancel' on the left, 'Access Code' in the center, and 'OK' on the right. Below the title bar, there is a text input field labeled 'Access Code' with a blue 'Do Not Use' button to its right. Below that is another text input field labeled 'Access Code'.

3. Select **Access Code**.
4. Select **Use**.
5. Select the Access Code field.
6. Use the displayed keypad to enter the access code, such as 9, and select **OK**.

**Parent topic:** [Setting Up Basic Fax Features](#)

### Setting the Number of Rings to Answer

If you connect an external answering machine and select to receive faxes automatically, make sure the Rings to Answer setting is correct. The number of rings should be higher than the number of rings your answering machine is set to for answering a call.

**Note:** This setting can be locked by an administrator. If you cannot access or change this setting, contact your administrator for assistance.

1. Press the  home button, if necessary.
2. Select **Settings > General Settings > Fax Settings > Basic Settings > Rings to Answer**.

You see a screen like this:

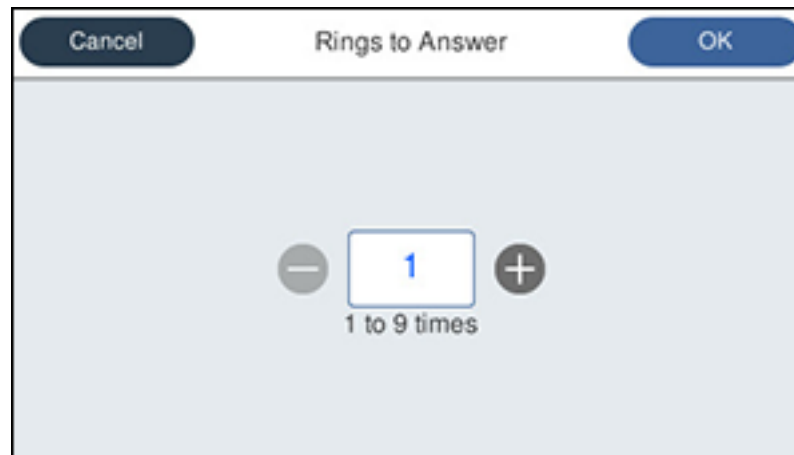

3. Select the number of rings and select **OK**. Make sure to select a number higher than the number of rings your answering machine is set to for answering a call.

**Note:** An answering machine picks up every call faster than the product, but the product can detect fax tones and start receiving faxes. If you answer the phone and hear a fax tone, check that the product has started receiving the fax, then hang up the phone.

**Parent topic:** [Setting Up Basic Fax Features](#)

## Selecting Advanced Fax Settings

You can select a variety of advanced fax settings.

**Note:** These settings can be locked by an administrator. If you cannot access or change these setting, contact your administrator for assistance.

1. Press the  home button, if necessary.
2. Select **Settings** > **General Settings** > **Fax Settings**.

You see a screen like this:



3. If you want to create shortcuts for up to three fax operations, select **Quick Operation Button** and select a setting and a shortcut button.

**Note:** These shortcuts are displayed on the Fax Settings tab in the main **Fax** screen.

4. Select the group of settings you want to change.

[Basic Settings - Fax](#)  
[Send Settings - Fax](#)  
[Receive Settings - Fax](#)  
[Report Settings - Fax](#)  
[Security Settings - Fax](#)

**Parent topic:** [Setting Up Fax Features](#)

## Basic Settings - Fax

Set the basic options you want to use for incoming and outgoing faxes.

Setting	Options	Description
Fax Speed	Fast(33,600bps)	Sets the speed at which you send and receive faxes.
	Medium(14,400bps)	
	Slow(9,600bps)	
ECM	On	Turns on Error Correction Mode (ECM) to automatically correct errors in sent or received fax data.
	Off	Turns off Error Correction Mode (ECM); color faxes cannot be sent or received.
Dial Tone Detection	On	Automatically dials the number you enter for faxing when the product detects a dial tone.
	Off	Turns off automatic dial tone detection, which may be necessary if the product is connected to a PBX (Private Branch Exchange) or a TA (Terminal Adapter). However, turning this setting off may cause the product to drop the first digit of a fax number.
Line Type	PSTN	Selects a standard phone line (Public Switched Telephone Network).
	PBX	Selects Private Branch Exchange, the type of phone line used in office environments where an access code such as 9 must be used to call an outside line.
Header	Your Phone Number	Select to enter the header information and your phone number for inclusion on outgoing faxes.
	Fax Header	

Setting	Options	Description
<b>Receive Mode</b>	<b>Manual</b>	Lets you confirm whether an incoming fax should be printed; a telephone must be connected to the product
	<b>Auto</b>	Automatically receives and prints faxes.
<b>Distinctive Ring</b>	<b>All</b>	If you are using a Distinctive Ring Service on your phone line, your telephone company can assign two or more phone numbers to the same line and assign different ring patterns to each. If you use this service, select the number of rings for your fax number so your product can receive faxes on the correct number of rings. Select <b>All</b> for phones lines that do not use this service.
	<b>Single</b>	
	<b>Double</b>	
	<b>Triple</b>	
	<b>Double&amp;Triple</b>	
<b>Rings to Answer</b>	1 to 9	Sets the number of rings before your product receives a fax. If Receive Mode is set to <b>Auto</b> and an answering machine is connected to the product, make sure this setting is set higher than the number of rings your answering machine is set to answer a call.
<b>Remote Receive</b>	<b>Off</b>	Lets you start receiving faxes using your phone instead of operating the product (if the Receive Mode is set to <b>Auto</b> ). When you select <b>On</b> , you must also set a <b>Start Code</b> . If you are using a cordless handset with its base connected to the product, you can start receiving the fax by entering the code using the handset.
	<b>On</b>	
	<b>Start Code</b>	
<b>Rejection Fax</b>	Various	Lets you automatically reject faxes from blocked numbers, with blank headers, or from unrecognized contacts.

Parent topic: [Selecting Advanced Fax Settings](#)

### Send Settings - Fax

Set the send options you want to use for outgoing faxes.

Setting	Options	Description
<b>Auto Rotation</b>	<b>Off</b>	Sends an A4 or letter-size document that is placed long edge first into the ADF as an A3-size fax.
	<b>On</b>	
<b>Batch Send</b>	<b>Off</b>	Sorts outgoing faxes by recipient in the product's memory, and then sends them as a batch.
	<b>On</b>	
<b>Save Failure Data</b>	<b>Off</b>	Saves faxes that failed to be sent in the product's memory. You can resend the faxes from the product's Job Status menu.  When you select <b>On</b> , you can select a time period to store the saved faxes.
	<b>On</b>	
<b>Wait Time for Next Original</b>	<b>Off</b>	Sets a time in between sending the next fax
	<b>On</b>	
<b>Fax Preview Display Time</b>	<b>Off</b>	Sets a time for previewing the scanned document on the LCD screen before it is sent
	<b>On</b>	

Parent topic: [Selecting Advanced Fax Settings](#)

### Receive Settings - Fax

Set the save/forward or print options you want to use for incoming faxes.

#### Save/Forward Settings

Setting	Options	Description
<b>Unconditional Save/Forward</b>	<b>Save to Inbox</b>	Saves received faxes in printer's inbox
	<b>Save to Computer</b>	Converts received faxes to PDFs and saves them on a computer connected to the printer
	<b>Save to Memory Device</b>	Converts received faxes to PDFs and saves them on an external memory device connected to the printer
	<b>Forward</b>	Forwards received faxes to another fax machine, or converts them to PDFs and forwards them to a shared folder on a network or an email address. Forwarded faxes are deleted from the printer.
	<b>Email Notifications</b>	Sends an email notification after a fax is received, printed, saved, or forwarded
<b>Conditional Save/Forward</b>	—	Sets up conditions to save, forward, or print received faxes. Select <b>Enable</b> to enable a condition. Select the arrow icon to enter conditions and other settings.
<b>Common Settings</b>	<b>Inbox Settings</b>	Sets up what happens when the fax memory is full, or sets up a password for the inbox
	<b>Email Subject to Forward</b>	Specifies a subject when forwarding a fax to an email address

### Print Settings

Setting	Options	Description
<b>Auto Reduction</b>	<b>On</b>	Select to reduce the size of large received faxes to fit on the paper size in the selected paper source.
	<b>Off</b>	Select to print large incoming faxes at their original size on multiple sheets, if necessary.
<b>Split Page Settings</b>	<b>Delete Print Data After Split</b>	Select how to split large incoming faxes across multiple sheets when using the <b>Auto Reduction</b> option.
	<b>Overlap When Split</b>	
<b>Auto Rotation</b>	<b>On</b>	If you have loaded A4-size paper, select <b>On</b> to rotate landscape-oriented incoming faxes so that they print correctly on the paper.
	<b>Off</b>	



Setting	Options	Description
<b>Add Reception Information</b>	<b>On</b>	Select <b>On</b> to include the date, time, the sender's information, and a page number in the header of your incoming faxes.
	<b>Off</b>	
<b>2-Sided</b>	<b>On</b>	Select <b>On</b> to print incoming faxes double sided. You can also select the <b>Binding Margin</b> .
	<b>Off</b>	
<b>Print Start Timing</b>	<b>All Pages Received</b>	Select to print incoming faxes after the product receives all of the pages of the document.
	<b>First Page Received</b>	Select to print incoming faxes as soon as the product receives the first page of the document.
<b>Collation Stack</b>	<b>On</b>	Select <b>On</b> to print incoming faxes so that the pages are stacked in the correct page order. (When the product is low on memory, this option may not be available.)
	<b>Off</b>	
<b>Print Suspend Time</b>	<b>Off</b>	Select <b>On</b> to set a time period to stop automatic printing of faxes or reports and save received faxes in the product's memory. (Make sure there is enough free memory before using this function.)
	<b>On</b>	
	<b>Time to Stop</b>	
	<b>Time to Restart</b>	
<b>Quiet Mode</b>	<b>On</b>	Select <b>On</b> to reduce noise during printing (printing speed may be reduced).
	<b>Off</b>	

Parent topic: [Selecting Advanced Fax Settings](#)

### Report Settings - Fax

Set the options you want for fax reports.

Setting	Options	Description
<b>Forwarding Report</b>	<b>Print on Error</b>	Prints a report after forwarding a received document only if an error occurs
	<b>Print</b>	Prints a report after forwarding a received document
	<b>Do Not Print</b>	Does not print a report after forwarding a received document

Setting	Options	Description
<b>Backup Error Report</b>	<b>On</b>	Select <b>On</b> to print a report when a backup error for sending faxes occurs
	<b>Off</b>	
<b>Fax Log Auto Print</b>	<b>Off</b>	Does not print a fax log
	<b>On(Every 30)</b>	Prints a fax log after every 30 fax jobs are completed
	<b>On(Time)</b>	Prints a fax log at a specified time. If the number of completed fax jobs exceeds 30, the fax log prints before the specified time.
<b>Attach Fax Image to Report</b>	<b>Off</b>	Does not include an image on the Transmission Report
	<b>On(Large Image)</b>	Prints a Transmission Report that includes the upper part of the first page of the sent document
	<b>On(Small Image)</b>	Prints a Transmission Report that includes a reduced size of the entire first page of the sent document
<b>Fax Log Layout</b>	<b>Combine Send and Receive</b>	Prints a Transmission Report and a Reception Report on the same sheet when you print a fax log
	<b>Separate Send and Receive</b>	Prints a Transmission Report and a Reception Report on separate sheets when you print a fax log
<b>Report Format</b>	<b>Simple</b>	Prints a simple fax report
	<b>Detail</b>	Prints a fax report that includes error codes
<b>Output Method</b>	<b>Print</b>	Prints fax reports
	<b>Save to Memory Device</b>	Saves fax reports to an inserted memory device. Select <b>Create a folder to save fax data</b> to create a folder on the inserted memory device.
	<b>Forward</b>	Forwards fax reports to a specified destination

Parent topic: [Selecting Advanced Fax Settings](#)

### Security Settings - Fax

Set the security options you want to use for fax data.



Setting	Options	Description
<b>Direct Dialing Restrictions</b>	<b>Off</b>	Does not restrict dialed fax numbers.
	<b>On</b>	Allows faxing only to numbers stored in the contacts list or history.
	<b>Enter Twice</b>	Requires you to enter fax numbers twice to prevent errors.
<b>Broadcasting Restrictions</b>	<b>Off</b>	Select <b>On</b> to allow only one fax number to be entered as the recipient
	<b>On</b>	
<b>Confirm Address List</b>	<b>Off</b>	Selects whether or not to display a recipient confirmation screen before a fax is sent.
	<b>On</b>	
<b>Backup Data Auto Clear</b>	<b>Off</b>	Automatically erases sent or received fax data from your product's memory.
	<b>On</b>	
<b>Clear Backup Data</b>	—	Deletes all sent or received fax data remaining in your product's memory; run this function if you are giving away or disposing of your product.

Parent topic: [Selecting Advanced Fax Settings](#)

## Setting Up the Fax Utility - Windows

You can set up the FAX Utility for Windows for use with your product.

**Note:** Before using the FAX Utility for Windows, make sure you have set up the fax features on your product using the product control panel. Also first confirm that you can send and receive faxes using the control panel.

- Do one of the following:
  - Windows 10:** Click  and select **EPSON Software**.
  - Windows 8.x:** Navigate to the **Apps** screen.
  - Windows (other versions):** Click  or **Start > Programs** or **All Programs > EPSON Software**.
- Select **FAX Utility**.

The first time you use the FAX Utility, you see this introduction window:

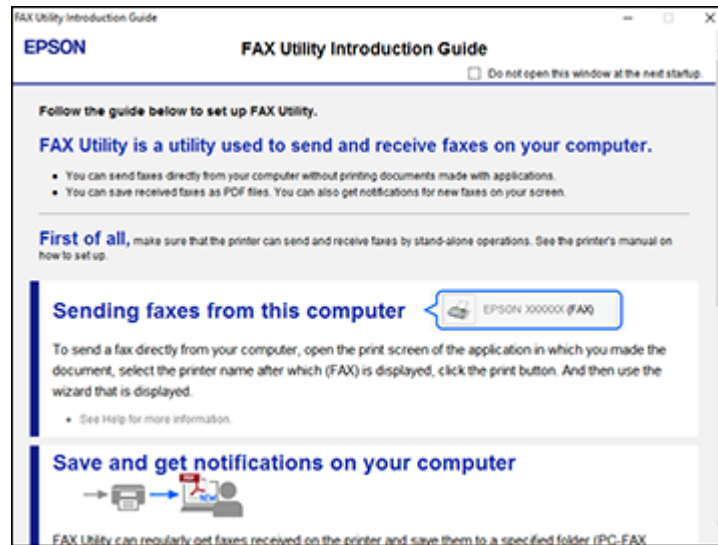

3. Read about the FAX Utility and click **Return to the main window** at the bottom of the window.

You see this window:

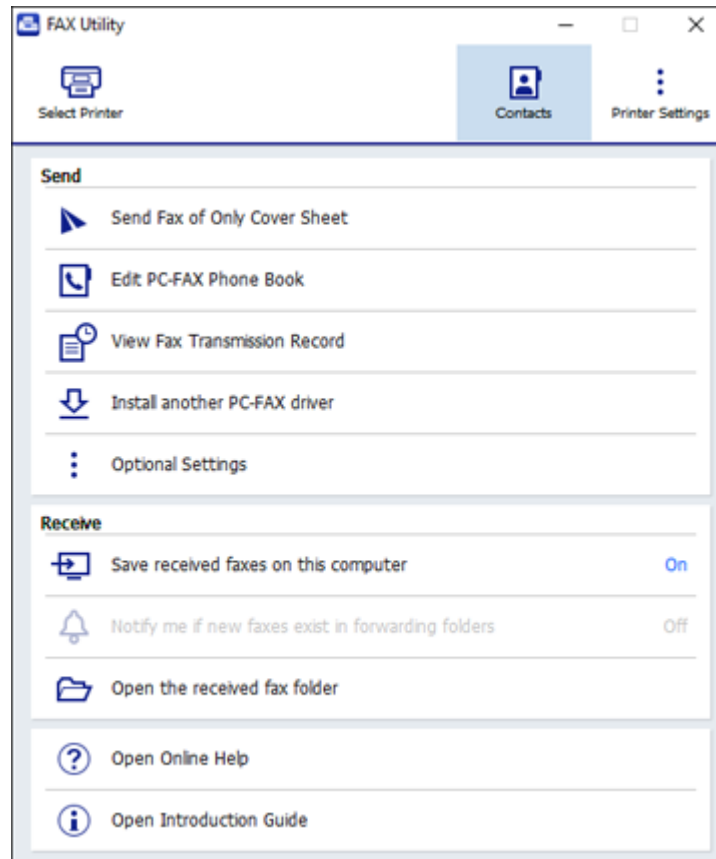

4. Click **Select Printer** and follow the on-screen instructions to transfer your product's fax settings to the FAX Utility.

**Note:** For detailed information, click **Help** or **Open Online Help**.

Parent topic: [Setting Up Fax Features](#)

## Setting Up Fax Features Using the Fax Utility - Mac

You can set up your fax header and select your fax settings using the FAX Utility for Mac.

1. In the Apple menu or the Dock, select **System Preferences**. Select **Print & Fax**, **Print & Scan**, or **Printers & Scanners**, select the **FAX** option for your product, and select **Options & Supplies**. Select **Utility** and select **Open Printer Utility**.
2. Double-click **FAX Utility**, if necessary.

You see this window:

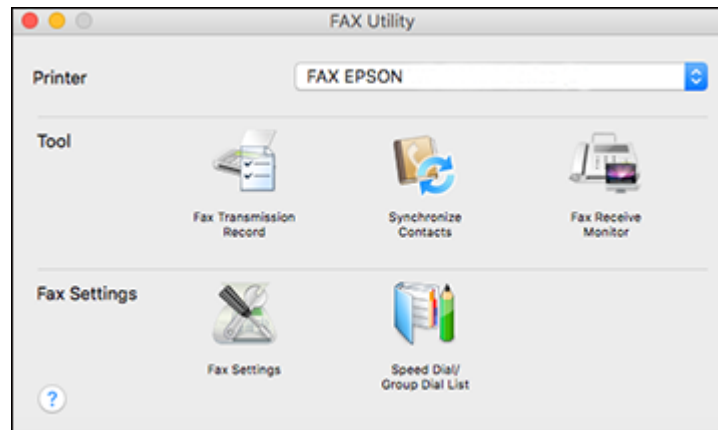

3. Select your **FAX** product in the Printer list.
4. Select **Fax Settings**.
5. Follow the prompts that appear on the screen to enter your fax header information and select your fax settings.

**Note:** For detailed information, select the FAX Utility ? icon.

**Parent topic:** [Setting Up Fax Features](#)

## Setting Up Contacts and Contact Groups

You can set up a list of contacts and their fax numbers so you can quickly select them for faxing. You can also set up contact groups to send a fax message to multiple contacts.

**Note:** Contacts can be locked by an administrator. If you cannot access or change contacts, contact your administrator for assistance.

[Creating a Contact](#)  
[Editing or Deleting a Contact](#)  
[Creating a Contact Group](#)  
[Editing or Deleting a Contact Group](#)

**Parent topic:** [Faxing](#)

## Creating a Contact

You can create a list of contacts to save frequently used fax numbers.

**Note:** You can create up to 200 contacts and contact groups combined.

1. Press the  home button, if necessary.
2. Select **Fax**.

You see a screen like this:

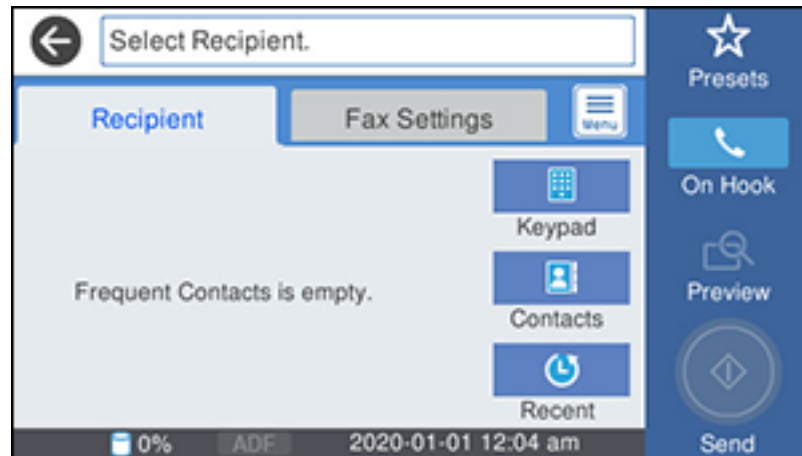

3. Select **Contacts**. Enter the administrator password, if necessary.

You see a screen like this:

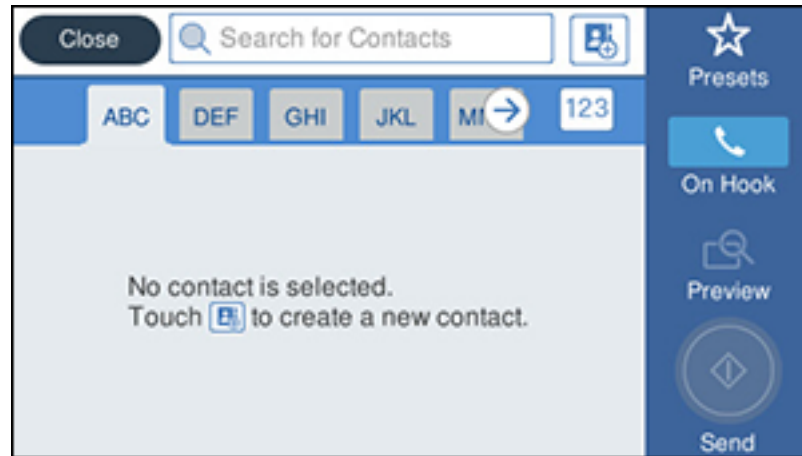

4. Select the  icon.
5. Select **Add Contact**.  
You see a screen like this:

6. Select the registry number you want to use for the contact you are adding.
7. Select the **Name** field, use the displayed keyboard to enter the contact name (up to 30 characters), and select **OK**.



8. Select the **Index Word** field, use the displayed keyboard to enter a word to use when searching for an entry (up to 30 characters), and select **OK**.

**Note:** This field is automatically populated after you enter the name. This field is optional.

9. Select the **Fax Number** field, and use the numeric keypad on the LCD screen or the buttons on the product to enter the fax number. You can enter up to 64 characters. Select **OK** when you are done.

**Note:** If necessary, enter an outside line access code (such as **9**) at the beginning of the fax number. If the access code has been set up in the **Line Type** setting, enter the **#** pound sign instead of the code.

10. Set the **Fax Speed**, **Subaddress**, and **Password** settings, if necessary.

11. Select **OK**.

**Parent topic:** [Setting Up Contacts and Contact Groups](#)

## Editing or Deleting a Contact

You can edit or delete any of the contacts on your list.

1. Press the  home button, if necessary.
2. Select **Fax**.

You see a screen like this:

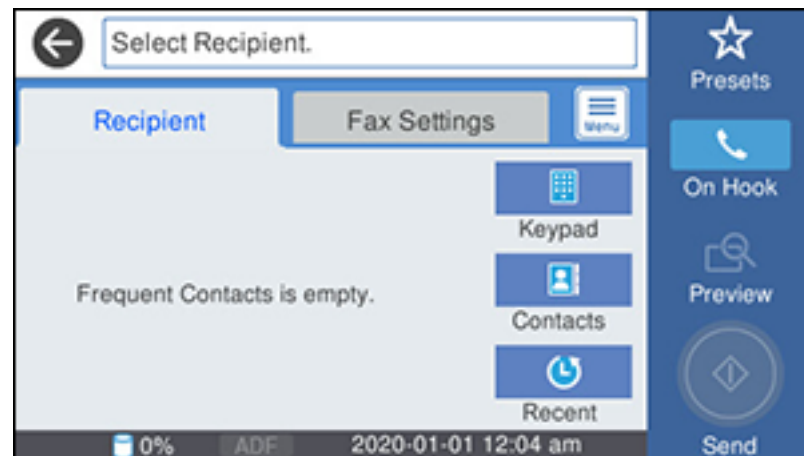

3. Select **Contacts**. Enter the administrator password, if necessary.

4. Select the  icon next to the contact you want to edit or delete.

You see a screen like this:

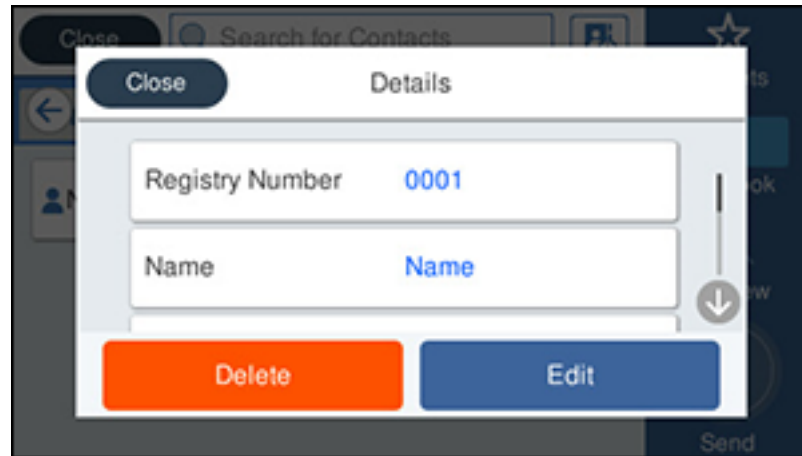

5. Do one of the following:

- To delete the contact, select **Delete** and select **Yes** on the confirmation screen.
- To edit the contact, select **Edit**, select the item you want to change, enter the correct information, and select **OK**. When you are finished editing, select **OK**.

**Parent topic:** [Setting Up Contacts and Contact Groups](#)

## Creating a Contact Group

You can create a group of contacts so that you can easily send faxes to multiple recipients.

**Note:** You can create up to 200 contacts and contact groups combined.

1. Press the  home button, if necessary.
2. Select **Fax**.

You see a screen like this:

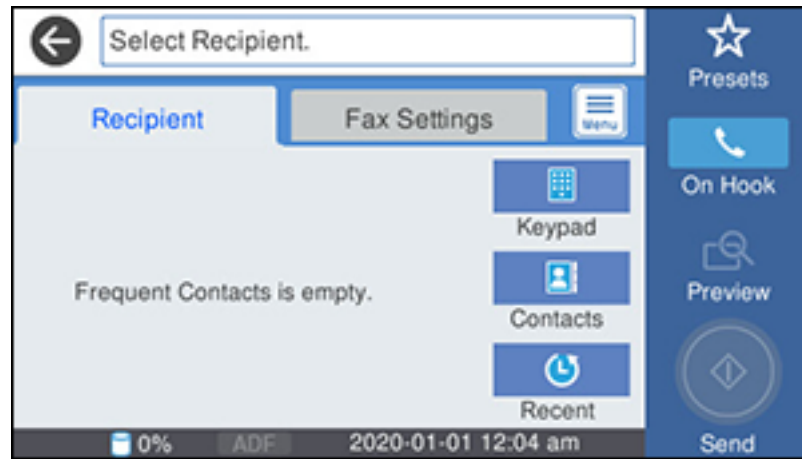

3. Select **Contacts**. Enter the administrator password, if necessary.
4. Select the  icon.
5. Select **Add Group**.

You see a screen like this:

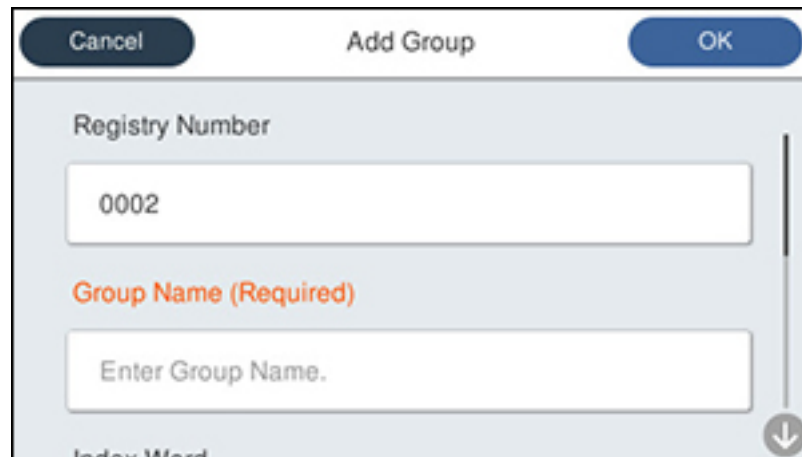

6. Select the registry number you want to use for the group you are adding.
7. Select the **Group Name** field, use the displayed keyboard to enter the group name (up to 30 characters), and select **OK**.
8. Select the **Index Word** field, use the displayed keyboard to enter a word to use when searching for a group (up to 30 characters), and select **OK**.

**Note:** This field is automatically populated after you enter the group name. This field is optional.

9. Select **Contact(s) Added to the Group**.  
You see your contacts list.
10. Select each contact you want to include in your group.  
Each selected contact is highlighted.
11. Select **Close**.
12. Select **OK**.

**Parent topic:** [Setting Up Contacts and Contact Groups](#)

## Editing or Deleting a Contact Group

You can edit an existing contact group to add or delete entries. You can also delete the entire contact group.

1. Press the  home button, if necessary.
2. Select **Fax**.

You see a screen like this:

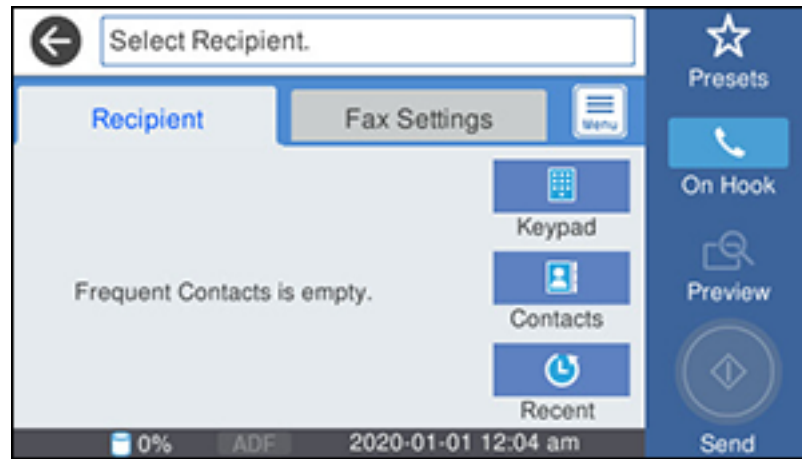

3. Select **Contacts**. Enter the administrator password, if necessary.

4. Select the  icon next to the group you want to edit or delete.

You see a screen like this:

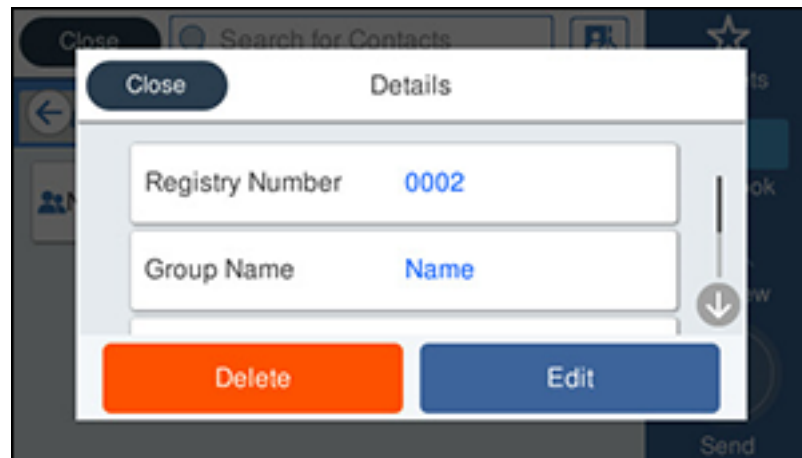

**Note:** If you want to delete the entire group, select **Delete**.

5. To edit the group, select **Edit**.
6. Select **Contact(s) Added to the Group**.  
You see a list of the contacts in your group.
7. Select the contact you want to add or delete.  
Each selected contact is highlighted.
8. Select **Close**.
9. Select **OK**.

**Parent topic:** [Setting Up Contacts and Contact Groups](#)

## **Sending Faxes**

See these sections to send faxes using your product.

[Sending Faxes from the Product Control Panel](#)

[Sending Faxes Using the Fax Utility - Windows](#)

[Sending Faxes Using the Fax Utility - Mac](#)

**Parent topic:** [Faxing](#)

## **Sending Faxes from the Product Control Panel**

See these sections to send faxes using the product's control panel.

[Sending a Fax Using the Keypad, Contact List, or History](#)

[Fax Sending Options](#)

[Sending a Fax at a Specified Time](#)

[Sending a Fax on Demand](#)

[Sending a Stored Fax](#)

[Dialing Fax Numbers from a Connected Telephone](#)

**Parent topic:** [Sending Faxes](#)

### **Sending a Fax Using the Keypad, Contact List, or History**

You can send a fax from your product control panel by entering the fax number, or selecting the number from either the contact list or fax history.

**Note:** You can send a black-and-white fax to up to 200 recipients at a time, or send a color fax to one recipient at a time. If your recipient's fax machine does not print in color, your fax is automatically sent in black-and-white.

**Note:** The product can queue up to 50 black-and-white fax jobs. You can check or cancel fax jobs in the queue using the Job Status menu.

1. Place your original on the product for faxing.
2. Press the  home button, if necessary.
3. Select **Fax**.

You see a screen like this:

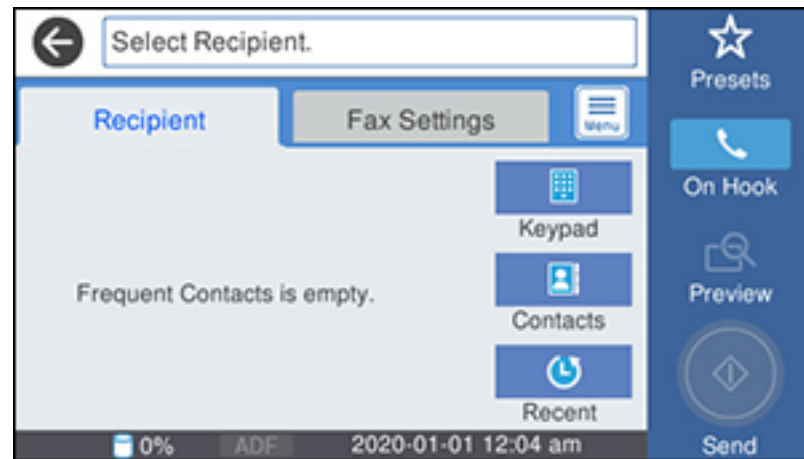

**Note:** To fax a double-sided document, place your document in the ADF and turn on the **ADF 2-Sided** setting. (You cannot fax double-sided documents in color.)

4. Do one of the following to select fax recipients:
  - Select **Keypad** and enter a fax number. Select **OK** when done. To add another fax number, repeat the same steps. You can also use the numeric keypad on the control panel to enter a fax number.

**Note:** If direct dialing has been restricted, you can only select the number from the contact list or fax history. If necessary, enter an outside line access code (such as 9) at the beginning of the fax

number. If the access code has been set up in the **Line Type** setting, enter the # pound sign instead of the code. If your fax number requires a brief pause, select the  icon to insert a pause symbol (-).

- Select **Contacts** to display the contact list. Select one or more contacts (select the contact again to deselect it). You can also select the **Search for Contacts** field to search for recipients by name, index name, or entry number. Select **Close** when you are finished.
- Select **Recent** to display the sent fax history.

**Note:** To delete entered recipients, select the **Select Recipient** field, select the recipient you want to delete, and select **Remove**.

5. If you need to change any fax settings, select **Fax Settings** and select your settings.
6. If you want to preview your fax in black-and-white on the LCD, press the  **Preview** icon. (If the preview looks incorrect, select **Cancel**, reposition the document or change the fax settings, and repeat this step.)

**Note:** If you do not touch the preview screen for the amount of time selected as the **Settings > General Settings > Fax Settings > Send Settings > Fax Preview Display Time** setting, your product sends the fax automatically. You cannot preview images when the Direct Send setting is turned on.

7. If you want to save your fax settings for later use, select **Presets** and add a new entry.
8. Select the  **Send** icon.

**Note:** To cancel faxing, select the  stop button. You can also cancel the job or check the job status from the Job Status menu.

Your product scans your original and prompts you to place additional pages, if necessary. After scanning your originals, your product dials the number and sends the fax.

**Note:** Your product does not save sent color faxes to its memory. If the **Save Failure Data** option is enabled, faxes that failed to be sent are stored to the product's memory and you can resend them from the Job Status menu screen.

**Parent topic:** [Sending Faxes from the Product Control Panel](#)



**Related references**[Fax Sending Options](#)**Related tasks**[Using Presets](#)[Selecting the Line Type](#)**Related topics**[Placing Originals on the Product](#)[Setting Up Contacts and Contact Groups](#)**Fax Sending Options**

While sending a fax, you can select **Fax Settings** and select these options.

Setting	Options	Description
<b>Resolution</b>	<b>Standard</b>	Adjusts the scan resolution and print quality of outgoing faxes
	<b>Fine</b>	
	<b>Super Fine</b>	
	<b>Ultra Fine</b>	
<b>Density</b>	Varying levels available	Lets you select from various density levels
<b>Original Type</b>	<b>Text</b>	Specifies the document type of your originals and adjusts the quality of your copies
	<b>Text &amp; Image</b>	
	<b>Photo</b>	
<b>Remove Background</b>	<b>Auto</b>	Automatically removes any background color on scanned images
	Varying levels available	Lets you select from various levels of background color adjustment
<b>Sharpness</b>	Varying levels available	Lets you adjust the sharpness level of outgoing faxes
<b>ADF 2-Sided</b>	<b>Off</b>	Select <b>On</b> to enable 2-sided faxing from the ADF. The Direct Send option and color faxing are disabled when you turn on this setting.
	<b>On</b>	

Setting	Options	Description
<b>Continuous Scan (ADF)</b>	<b>Off</b>	Select <b>On</b> to have the product to ask if you want to scan another page after a document in the ADF has finished scanning
	<b>On</b>	
<b>Original Size (Glass)</b>	Various sizes	Select the size for a document placed on the scanner glass, or select <b>Auto Detect</b> to have the product automatically detect the size of the document.
	<b>Auto Detect</b>	
<b>Color Mode</b>	<b>B&amp;W</b>	Select whether to scan images in color or black and white
	<b>Color</b>	
<b>Direct Send</b>	<b>Off</b>	Select <b>On</b> to send black-and-white faxes to a single recipient as soon as the connection is made, without saving the scanned image to memory. You cannot use this setting when sending a color fax or sending a fax to multiple recipients.
	<b>On</b>	
<b>Priority Send</b>	<b>Off</b>	Select <b>On</b> to send the current fax before other faxes waiting to be sent
	<b>On</b>	
<b>Send Fax Later</b>	<b>Off</b>	Select <b>On</b> to send the current fax at a selected time
	<b>On</b>	
<b>Add Sender Information</b>	<b>Off</b>	Lets you include a header, your phone number, or a destination list in the selected location on your outgoing faxes
	<b>Outside of Image</b>	
	<b>Inside of Image</b>	
<b>Notify Send Result</b>	<b>Off</b>	Sends a notification to the selected email address when an outgoing fax is sent
	<b>On</b>	
<b>Transmission Report</b>	<b>Print on Error</b>	Lets you select when to print transmission reports
	<b>Print</b>	
	<b>Do Not Print</b>	
<b>Backup</b>	<b>Off</b>	Saves a copy of the scanned fax to the selected email address or network folder/FTP location
	<b>On</b>	

Parent topic: [Sending Faxes from the Product Control Panel](#)

## Sending a Fax at a Specified Time

You can send a fax at a time of your choice.

**Note:** Make sure the product's date and time settings are correct. You can only send faxes in black-and-white when you use this option.

1. Place your original on the product for faxing.
2. Press the  home button, if necessary.
3. Select **Fax**.

You see a screen like this:

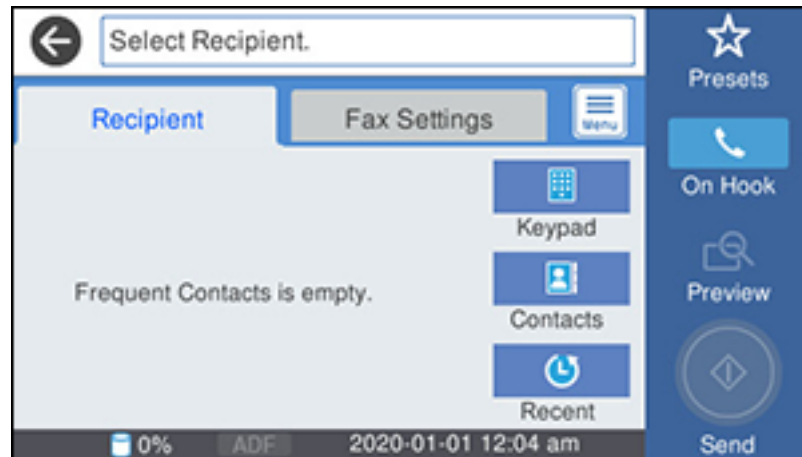

4. Enter a fax number or select a number from the **Contacts** or **Recent** lists.
5. Select **Fax Settings**.
6. Select **Send Fax Later**.
7. Select **On**.
8. Select **Time**, use the displayed keypad on the LCD screen to enter your desired time, and select **OK**.

9. Select the  **Send** icon.

**Note:** To cancel faxing, select the  stop button.

After scanning your originals, your product dials the number and sends the fax at the specified time.

**Note:** If the product is turned off at the specified time, the fax is sent when it is powered on.

**Parent topic:** [Sending Faxes from the Product Control Panel](#)

**Related references**

[Fax Sending Options](#)

**Related tasks**

[Selecting the Date and Time](#)

**Related topics**

[Placing Originals on the Product](#)

[Setting Up Contacts and Contact Groups](#)



### **Sending a Fax on Demand**

You can store one scanned document (up to 100 black-and-white pages) and have it sent automatically when another fax machine requests it. Other fax users can receive the document by calling your fax number and using the polling receive function on their fax machines.

1. Place your original on the product for faxing.
2. Press the  home button, if necessary.
3. Select **Fax Box**.

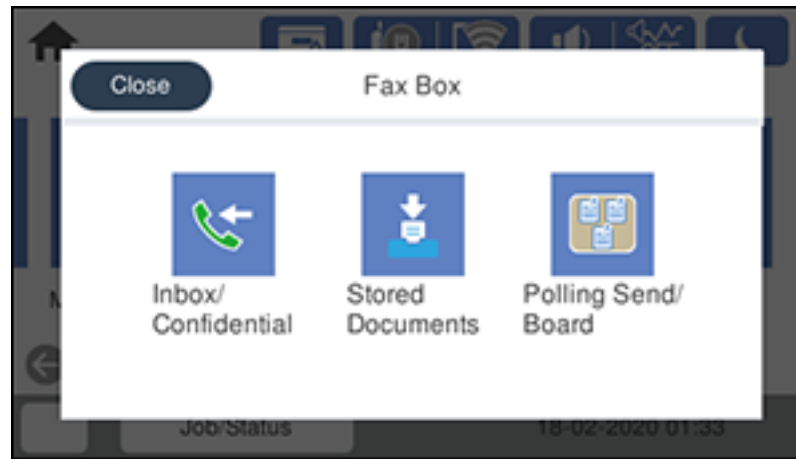
You see a screen like this:



4. Select **Polling Send/Board**.
5. Select **Polling Send**.
6. Review the displayed Polling Send Box settings. If you need to make changes, select the  icon and select **Settings**. Make any necessary changes and select **OK**.
7. Select **Add Document**.
8. Review the displayed Fax Settings. Make any necessary changes.
9. Select the  **Store** icon.

Your document is scanned and stored until you overwrite or delete it.

You can store only one document at a time. Subsequent documents overwrite the existing document. You can also delete a stored document from the Job Status menu.

**Parent topic:** [Sending Faxes from the Product Control Panel](#)

#### **Related references**

[Fax Sending Options](#)

#### **Related topics**

[Placing Originals on the Product](#)



## Sending a Stored Fax

You can store one black-and-white scanned document (up to 100 pages) and send it whenever necessary.

1. Place your original on the product for faxing.
2. Press the  home button, if necessary.
3. Select **Fax**.

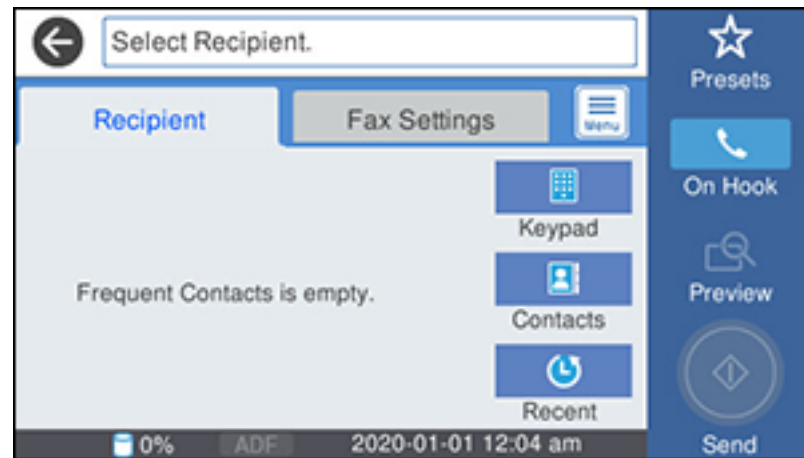
You see a screen that looks like this:



4. Select the  icon.
5. Select **Extended Fax**.
6. Select **Store Fax Data** and select **On**.
7. Select **Close**.
8. Select any other fax settings as necessary and select **Close**.
9. Select the  **Store** icon.  
Your document is scanned, stored, and briefly previewed.
10. When you are ready to send the document, press the  home button, if necessary, and select **Fax Box**.

11. Select **Stored Documents**.
12. Select the stored fax job you want to send.
13. Select the  **Send** icon.

You can store only one document at a time. Subsequent documents overwrite the existing document.

**Parent topic:** [Sending Faxes from the Product Control Panel](#)

#### **Related references**

[Fax Sending Options](#)

#### **Related topics**

[Placing Originals on the Product](#)

### **Dialing Fax Numbers from a Connected Telephone**

If you have connected a telephone to the **EXT** port on your product, you can send a fax by dialing the fax number from the connected telephone. If the recipient's phone number and fax number are the same, you can speak to the recipient before sending the fax.

1. Place your original on the product for faxing.
2. Press the  home button, if necessary.
3. Dial the fax number from the connected telephone. Speak to the recipient if necessary.

**Note:** If you are using a pre-paid calling card, enter the number and password required to use the card before entering the destination fax number.

4. Select **Fax** on the LCD screen.
5. Select **Fax Settings** and select any settings as necessary.

**Note:** Your product now communicates with the recipient's fax machine. Do not hang up the telephone.

6. When you hear a fax tone, select the  **Send** icon to start sending the fax.

**Note:** If your recipient's fax machine does not print in color, your fax is automatically sent in black-and-white.

7. Hang up the telephone.

Parent topic: [Sending Faxes from the Product Control Panel](#)

**Related references**

[Fax Sending Options](#)

**Related topics**

[Placing Originals on the Product](#)

## Sending Faxes Using the Fax Utility - Windows

You can send a fax from a printing program in Windows. You can fax up to 100 pages at a time, including a cover sheet.

1. Open the file you want to fax and select the print command.

You see a window like this:

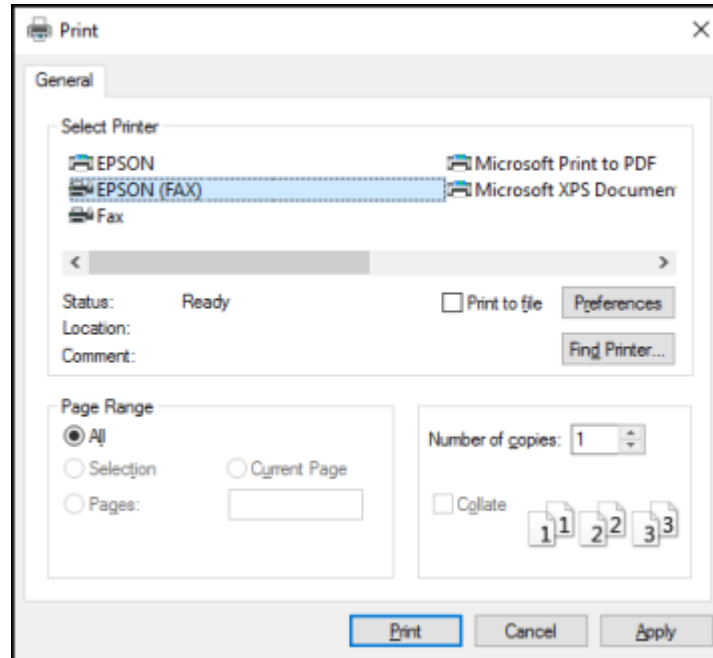

2. Select your product with the **FAX** option as the printer.



3. To change the Paper Size, Orientation, Color, Image Quality, or Character Density settings, click the **Preferences** or **Properties** button, change the necessary settings, and click **OK**.

**Note:** If you see a **Setup**, **Printer**, or **Options** button, click it. Then click **Preferences** or **Properties** on the next screen. For more information about selecting fax print settings, click **Help**.

4. Select the Page Range as necessary. (Leave the Number of copies set to 1.)
5. Click **Print** or **OK**.

If you're faxing for the first time, you see a window like this one:

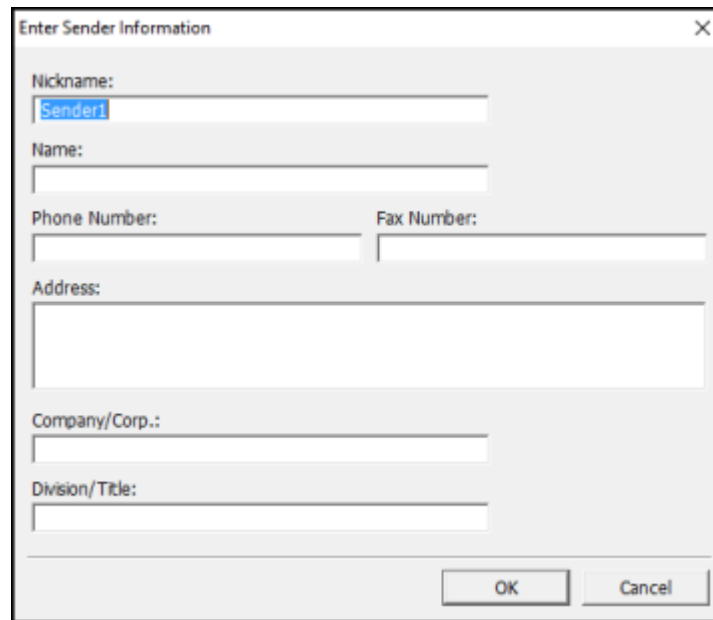

The screenshot shows a dialog box titled "Enter Sender Information" with a close button (X) in the top right corner. The dialog contains the following fields and labels:

- Nickname: [Sender1]
- Name: [ ]
- Phone Number: [ ]
- Fax Number: [ ]
- Address: [ ]
- Company/Corp.: [ ]
- Division/Title: [ ]

At the bottom of the dialog are two buttons: "OK" and "Cancel".

6. Enter your sender information so that recipients can identify the origin of the fax. Then click **OK** to save the sender information.

You see a window like this:

Recipient Settings (1 / 3)

Recipient List: Recipient Total: 0

Name/Group Name	Fax Number	Company/Corp.	Division/Title
-----------------	------------	---------------	----------------

Add Delete

Phone Book Manual Dial

Name:  Fax Number:

Title:

Company/Corp.:  Division/Title:

Save to Phone Book... Clear

< Back Next > Cancel Help

7. Enter the recipient's name and fax number or select a recipient from the phonebook, then click **Next**.

**Note:** For detailed instructions on using the Epson FAX Utility, click **Help**.

8. Select a cover sheet and enter a subject and message, then click **Next**.
9. Click **Send** to transmit your fax.

**Parent topic:** [Sending Faxes](#)

## Sending Faxes Using the Fax Utility - Mac

You can send a fax from a Mac printing program using the FAX Utility. You can fax up to 100 pages at a time, including a cover sheet.

1. Open the file you want to fax.

2. Select the print command in your application.

**Note:** You may need to select a print icon on your screen, the **Print** option in the **File** menu, or another command. See your application's help utility for details.

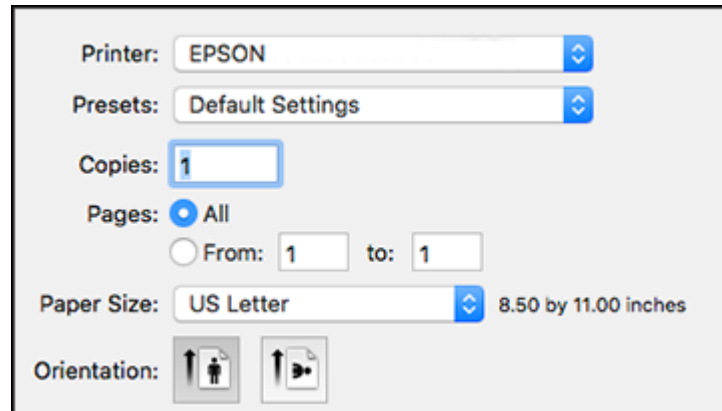

3. Select your product **FAX** option as the **Printer** setting.
4. If necessary, click the arrow next to the Printer setting or the **Show Details** button to expand the print window.
5. Select the number of pages you are faxing as the **Pages** setting.

**Note:** Leave the **Copies** setting set to **1**.

6. Select **Recipient Settings** from the pop-up menu.

You see this window:

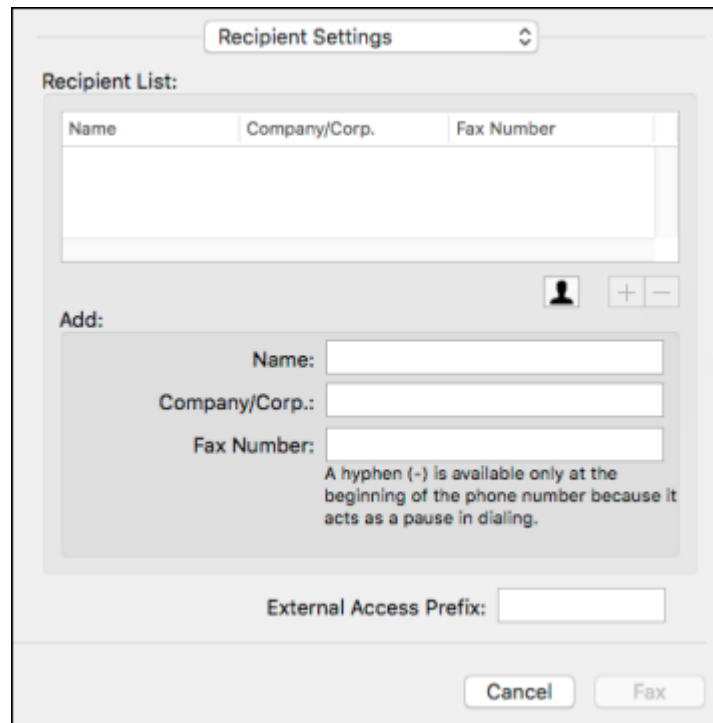

The image shows a 'Recipient Settings' dialog box. At the top, there is a title bar with 'Recipient Settings' and a dropdown arrow. Below the title bar is a section labeled 'Recipient List:' containing a table with three columns: 'Name', 'Company/Corp.', and 'Fax Number'. The table is currently empty. To the right of the table are three buttons: a person icon, a plus sign, and a minus sign. Below the table is an 'Add:' section with three input fields labeled 'Name:', 'Company/Corp.:', and 'Fax Number:'. Below the 'Fax Number:' field is a note: 'A hyphen (-) is available only at the beginning of the phone number because it acts as a pause in dialing.' At the bottom of the dialog is an 'External Access Prefix:' input field. At the very bottom are two buttons: 'Cancel' and 'Fax'.

7. Do one of the following to choose your recipient:
  - Select a name or group from the **Recipient List**.
  - Enter a name, company, and fax number and click the **+** button.
  - Click the  icon and select a recipient from your address book.
8. Select **Fax Settings** from the pop-up menu.

You see this window:

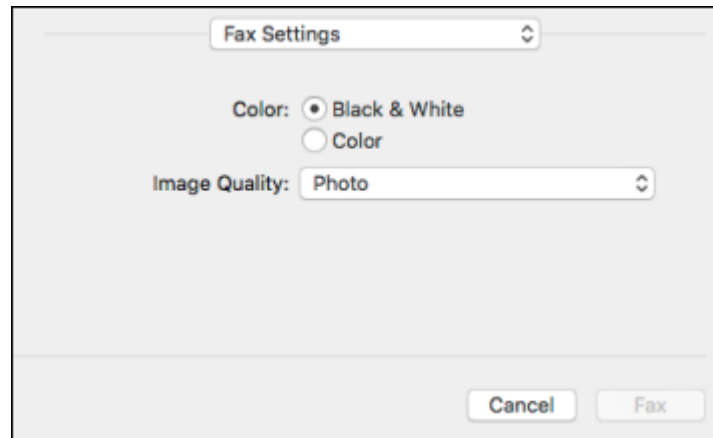

9. Select the **Color** and **Image Quality** settings you want to use for your fax.
10. Click **Fax**.

**Parent topic:** [Sending Faxes](#)

## Receiving Faxes

See these sections to receive faxes with your product.

[Fax Reception](#)

[Receiving Faxes Automatically](#)

[Receiving Faxes Manually](#)

[Forwarding Received Faxes](#)

[Receiving a Fax by Polling](#)

[Viewing a Fax on the LCD Screen \(Using the Fax Box\)](#)

**Parent topic:** [Faxing](#)

## Fax Reception

Your product will automatically receive and print faxes when you set the Receive Mode to **Auto**.

If you connected a telephone to your product so you can use the same phone line for faxes and voice calls, you can also set your product to receive faxes manually. This allows you to check for a fax tone using the telephone and press a button on your product to receive the fax.

Make sure to load paper in your product and select your fax settings before receiving a fax.

**Note:** If you run out of paper during fax printing, load more paper and press the button indicated on your product's LCD screen to continue.

**Parent topic:** [Receiving Faxes](#)

## Receiving Faxes Automatically

To receive faxes automatically, make sure Receive Mode is set to **Auto** (the default setting for the product).

To change the Receive Mode if necessary, select **Settings > General Settings > Fax Settings > Basic Settings > Receive Mode**.

If an answering machine is connected, make sure the product's **Rings to Answer** setting is set higher than the number of rings your answering machine is set to answer a call. For example, if the answering machine is set to pick up on the fourth ring, set the product to pick up on the fifth ring or later.

**Parent topic:** [Receiving Faxes](#)

### Related references

[Basic Settings - Fax](#)

### Related tasks

[Receiving Faxes Manually](#)

## Receiving Faxes Manually

You can set up your product to receive faxes manually by setting the Receive Mode to **Manual**. This lets you check for a fax tone on the connected telephone before receiving a fax.

1. To change the Receive Mode, select **Settings > General Settings > Fax Settings > Basic Settings > Receive Mode** and select **Manual**.
2. When the connected telephone rings, answer the call.
3. If you hear a fax tone, select **Fax** on the LCD display.
4. Select **Send/Receive**.
5. Select **Receive**.

6. Select the  **Receive** icon to start receiving the fax.
7. Hang up the telephone.

**Parent topic:** [Receiving Faxes](#)

**Related references**

[Basic Settings - Fax](#)

**Related tasks**

[Receiving Faxes Automatically](#)

## Forwarding Received Faxes

You can forward received faxes to another fax machine, or convert the faxes into PDF documents and forward them to a shared folder on the network or to an email address. Forwarded faxes are deleted from the product's memory. Before using this feature, make sure the date and time are set correctly, the forwarding destination is set up in the contact list, and the email server settings are configured.

1. Press the  home button, if necessary.
2. Select **Settings > General Settings > Fax Settings > Receive Settings > Save/Forward Settings > Unconditional Save/Forward > Forward > Yes**.

You see a screen like this:

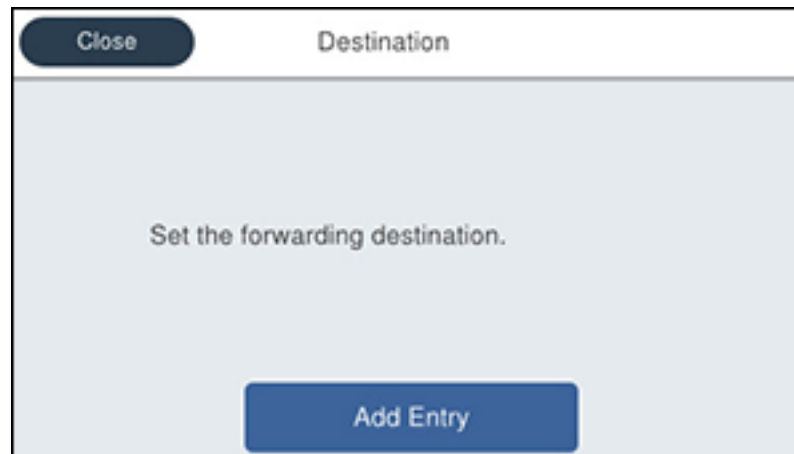

**Note:** If you want to print the fax automatically before forwarding it, select **Yes and Print**.

3. Select **Add Entry** and select the forwarding destinations from the contacts list.
4. When you are finished selecting your forwarding destinations, select **Close**.
5. Confirm the displayed forwarding destinations and select **Close**.
6. Select an **Options When Forwarding Failed** option to choose whether you want to print the faxes or save them in the printer's inbox if forwarding received faxes fails.

Parent topic: [Receiving Faxes](#)

## Receiving a Fax by Polling

You can use polling to receive a fax from another fax machine (such as a fax information service).

**Note:** You cannot use polling to receive a fax from a fax information service that uses audio guidance.

1. Press the  home button, if necessary.
2. Select **Fax**.

You see a screen like this:

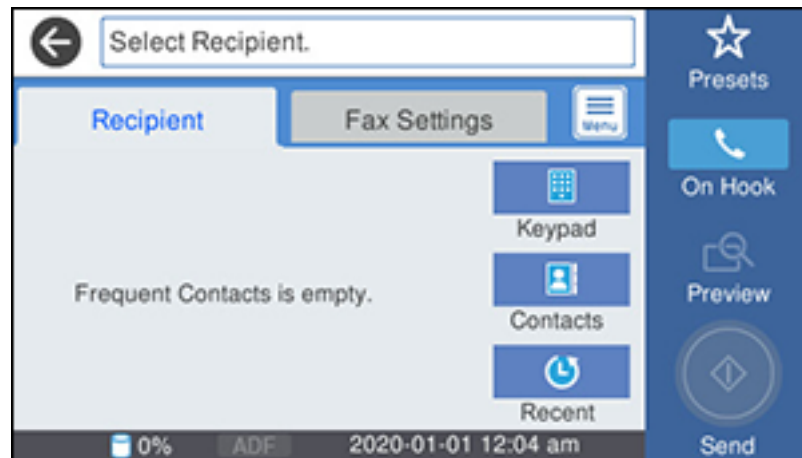

3. Select the  icon.
4. Select **Extended Fax**.
5. Set **Polling Receive** to **On**.



6. Select **Close**.
7. Select **Close**.
8. Enter the fax number you expect to receive the fax from.
9. Select the  **Polling** icon to start receiving the fax.

Parent topic: [Receiving Faxes](#)

## Viewing a Fax on the LCD Screen (Using the Fax Box)

You can save received faxes in your product's memory and view them on the LCD screen.

**Note:** The Inbox can be locked by an administrator. If you cannot access the Inbox, contact your administrator for assistance.

1. Press the  home button, if necessary.
2. Select **Settings > General Settings > Fax Settings > Receive Settings > Save/Forward Settings > Unconditional Save/Forward**.

You see a screen like this:

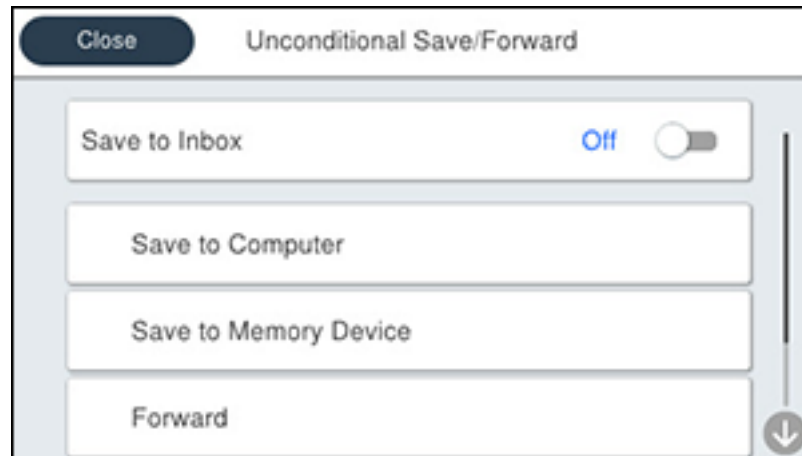

3. Set **Save to Inbox** to **On**.
4. Press the  home button.

5. Select **Fax Box**.
6. Do one of the following:
  - Select **Inbox/Confidential** to view received documents.
  - Select **Stored Documents** to view saved documents that have not been sent when **Store Fax Data** is set to **On**.
  - Select **Polling Send/Board** to view documents that are stored for fax polling.
7. Select the fax you want to view.  
You see the fax displayed on the screen.
8. Select the  icon.
9. Select one of the printing or deleting options, and follow the on-screen instructions.

**Note:** Delete faxes after you print or view them to prevent the product's memory from filling up. When the memory is full, you can only forward or print incoming faxes.

**Parent topic:** [Receiving Faxes](#)

## Checking Fax Status



You can check the status of current fax jobs, or faxes that have been received or sent on the product control panel.

1. Press the  **Job/Status** button. Select the **Job Status** tab if necessary.

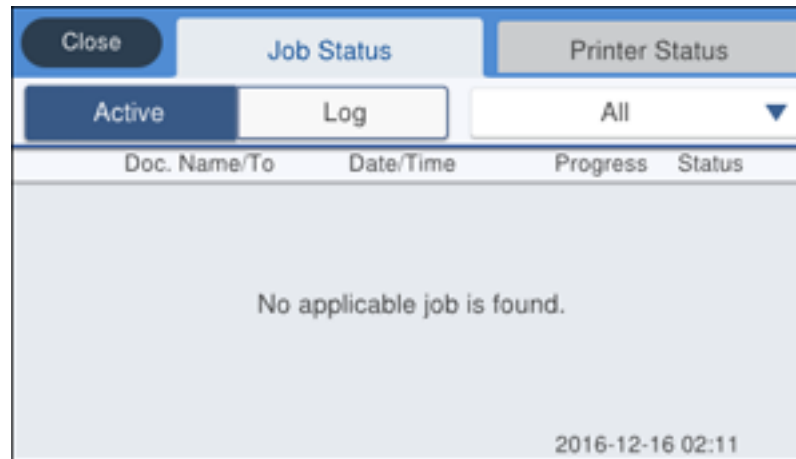
You see a screen like this:



2. Do one of the following:
  - To check the status of current fax jobs, select the fax job you want to check.
  - To check the history of faxes that have been sent, received, or saved, select **Log** and select the job you want to check.

**Note:** If you see a numbered icon above the  icon on your product's LCD screen or the  **Received Fax** light is flashing, received faxes have been temporarily saved to the product's memory.

Parent topic: [Faxing](#)

## Printing Fax Reports

You can print several types of fax reports whenever necessary. You can also print the fax log printed automatically by turning on **Fax Log Auto Print**.

1. Press the  home button, if necessary.
2. Select **Fax**.

You see a screen like this:

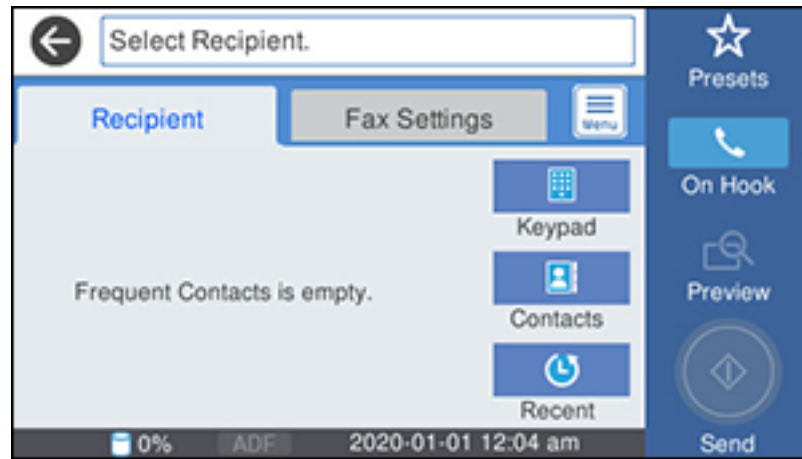

3. Select the  icon.
4. Select **Fax Report**.
5. Select the fax report you want to print.

[Fax Report Options](#)

Parent topic: [Faxing](#)

## Fax Report Options

Select the fax report or list you want to print.

### Last Transmission

Print a report on the previous fax that was sent or received through polling.

### Fax Log

View or print a report on recent fax transmissions.

### Stored Fax Documents

Print a list of the fax jobs currently stored in the product's memory.

### Fax Settings List

Print a list of the current fax communication settings.

**Conditional Save/Forward List**

Print a list of the current conditional save/forward settings.

**Protocol Trace**

Print a detailed report for the previous sent or received fax.

**Parent topic:** [Printing Fax Reports](#)

---

# Using External USB Devices with Your Product

Follow the instructions here to work with an external USB device connected to your product.

[Connecting a USB Device](#)

[Disconnecting a USB Device](#)

## Connecting a USB Device

Connect a USB device or its USB cable to the USB port on the front of the product.

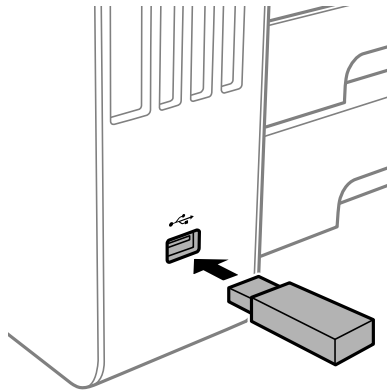

**Note:** Epson cannot guarantee the compatibility of your device. Make sure the files on the device are compatible with the product.

[USB Device Photo File Specifications](#)

**Parent topic:** [Using External USB Devices with Your Product](#)

**Related tasks**

[Disconnecting a USB Device](#)

## USB Device Photo File Specifications

You can use USB devices with your product containing files that meet these specifications.

<b>File format</b>	JPEG with the Exif version 2.31 standard taken by digital cameras with the DCF (Design Rule for Camera File system) version 1.0 or 2.0 standard TIFF 6.0-compliant uncompressed images: RGB full-color or binary (not CCITT-encoded) PDF created by the <b>Scan to Memory Device</b> option
<b>Image size</b>	80 × 80 pixels to 10200 × 10200 pixels
<b>File size</b>	Up to 2GB
<b>Number of files</b>	JPEG: Up to 9990* TIFF: Up to 999 PDF: Up to 999

\* If the number of files exceeds 999, the files are displayed in groups.

**Parent topic:** [Connecting a USB Device](#)

## Disconnecting a USB Device

After you finish working with a USB device, follow these steps to remove it.

1. If your product is connected to your computer using a USB cable, do one of the following:
  - **Windows:** Open the **My Computer**, **Computer**, **This PC**, or **Windows Explorer** utility. Then right-click the name of your USB device (listed as a removable disk) and select **Eject**.
  - **Mac:** Drag the removable disk icon for your USB device from the desktop into the trash.

**Caution:** Do not remove a USB device before completing the procedure above or you may lose data from the flash drive.

2. Pull the USB device or cable out of the USB port on the front of the product.

**Parent topic:** [Using External USB Devices with Your Product](#)

---

# Refilling Ink and Replacing the Maintenance Box

Periodically check the ink tanks to see if they need to be refilled.

Before checking the ink level or refilling an ink tank as described here, be sure to read the ink safety precautions.

**Caution:** Visually check the ink levels in the product's ink tanks to confirm the actual ink levels. Continued use of the product when the ink is expended could damage the product.

[Ink Safety Precautions](#)

[Checking the Ink and Maintenance Box Levels](#)

[Purchase Epson Ink and Maintenance Box](#)

[Refilling the Ink Tanks](#)

[Maintenance Box Replacement](#)

**Related concepts**

[Print Head Maintenance](#)

## Ink Safety Precautions

### Ink Handling Precautions

- Keep ink bottles and the ink tanks out of the reach of children. Do not allow children to drink from or handle the ink bottles and bottle caps.
- Do not tilt or shake an ink bottle after opening it; otherwise, ink may leak.
- If ink gets on your skin, wash it thoroughly with soap and water. If ink gets into your eyes, flush them immediately with water. If discomfort or problems persist, see a doctor immediately. If ink gets into your mouth, spit it out and see a doctor right away.
- Do not shake or squeeze the ink bottles.
- If ink spills, wipe it up immediately. To prevent the ink from spreading, blot the spill with a dry cloth, then wipe it with a damp cloth. The ink will be hard to remove once it has dried.

### Ink Refilling Precautions

- Use ink bottles with the correct part number for this product.
- Epson's warranties do not extend to any damage caused by the use of third-party ink or ink not designed for your printer.



- This product requires careful handling of ink. Ink may splatter when the ink tanks are filled or refilled with ink. If ink gets on your clothes or belongings, it may not come off.
- Do not open the ink bottle package until you are ready to fill an ink tank. Ink bottles are vacuum packed to maintain reliability. If you leave an ink bottle unpacked for a long time before using it, print quality may be affected.
- If the ink level is below the lower line on an ink tank, refill the ink. Continued use of the product when the ink level is below the lower line on an ink tank could damage the product.
- Visually check the ink levels in the product's ink tanks to confirm the actual ink levels. Continued use of the product when the ink is expended could damage the product.
- For optimum printing results, refill the ink tanks to the upper line at least once a year.
- After bringing an ink bottle inside from a cold storage site, allow it to warm up at room temperature for at least three hours before using it.
- Use the ink bottle before the date printed on the package.
- After opening an ink bottle, Epson recommends using it as soon as possible.
- Store ink bottles in a cool, dark place. Keep them out of direct sunlight.
- Do not store the ink bottles in high or freezing temperatures.
- Store the ink bottles in the same environment as the product. When storing or transporting an opened ink bottle, do not tilt the bottle and do not subject it to impacts or temperature changes. Otherwise, ink may leak even if the cap on the ink bottle is tightened securely. Be sure to keep the ink bottle upright when tightening the cap, and take measures to prevent ink from leaking when you transport the bottle.

### **Ink Bottle and Ink Tank Information**

- To maintain optimum print head performance, some ink is consumed from all ink tanks during printing and when performing maintenance operations, such as cleaning the print head. Ink may also be consumed when the product is turned on.
- Part of the ink from the included bottles is used for printer setup. You will notice ink levels in the tank decrease during charging. This decrease is normal and does not affect the stated in-box yields.
- Quoted ink yields may vary depending on the images you are printing, the paper type you are using, how often you print, and environmental conditions such as temperature.
- The ink bottles may contain recycled materials, but this does not affect product function or performance.
- When printing in monochrome or grayscale, color ink may be used instead of black ink, depending on the paper type or print quality settings. This is because a mixture of color inks is used to create black.

- A reserve amount of ink remains in the tank when your product indicates that a refill is necessary.

**Parent topic:** [Refilling Ink and Replacing the Maintenance Box](#)

## Checking the Ink and Maintenance Box Levels

Your product and software will let you know when to refill an ink tank or replace the maintenance box.

[Checking the Ink Levels on Your Product](#)

[Checking Maintenance Box Status on the LCD Screen](#)

[Checking Ink and Maintenance Box Levels - Windows](#)

[Checking Ink and Maintenance Box Levels - Mac](#)

[Disabling Special Offers with Windows](#)

**Parent topic:** [Refilling Ink and Replacing the Maintenance Box](#)

## Checking the Ink Levels on Your Product

To confirm the actual ink remaining, visually check the ink levels in the product's ink tanks. Make sure the ink levels are above the lower line on the ink tanks. If any of the ink tanks are below the lower line, fill them to the upper line on the ink tank.

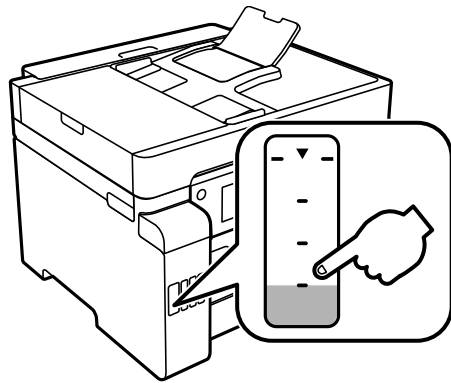

**Note:** The product has a low ink alert system. The accuracy of this system depends on the user refilling the ink tanks correctly. The product cannot directly measure the ink levels in the tanks; instead it estimates the amount of ink remaining by internally monitoring ink usage. The low ink alert system may generate inaccurate messages if the ink tanks are not refilled according to these instructions.

As a precaution, perform regular visual inspections of the ink tanks to ensure ink levels do not fall below the lower line. Continued use of the product when the ink level is below the lower line on the tank could damage the product.

**Parent topic:** [Checking the Ink and Maintenance Box Levels](#)

## Checking Maintenance Box Status on the LCD Screen

You can check the status of your maintenance box using your product's LCD screen.

1. Press the  home button, if necessary.
2. Select **Settings**
3. Select **Supply Status**.

You see the remaining ink capacity of the maintenance box.

4. Press the  home button again to exit the screen.



**Parent topic:** [Checking the Ink and Maintenance Box Levels](#)

### Related concepts

[Maintenance Box Replacement](#)

## Checking Ink and Maintenance Box Levels - Windows

A low ink reminder appears if you try to print when ink is low, and you can check your ink levels at any time using a utility on your Windows computer.

1. To check your ink and maintenance box levels, access the Windows Desktop and double-click the  icon for your product in the right side of the Windows taskbar, or click the up arrow and double-click .

You see a window like this:

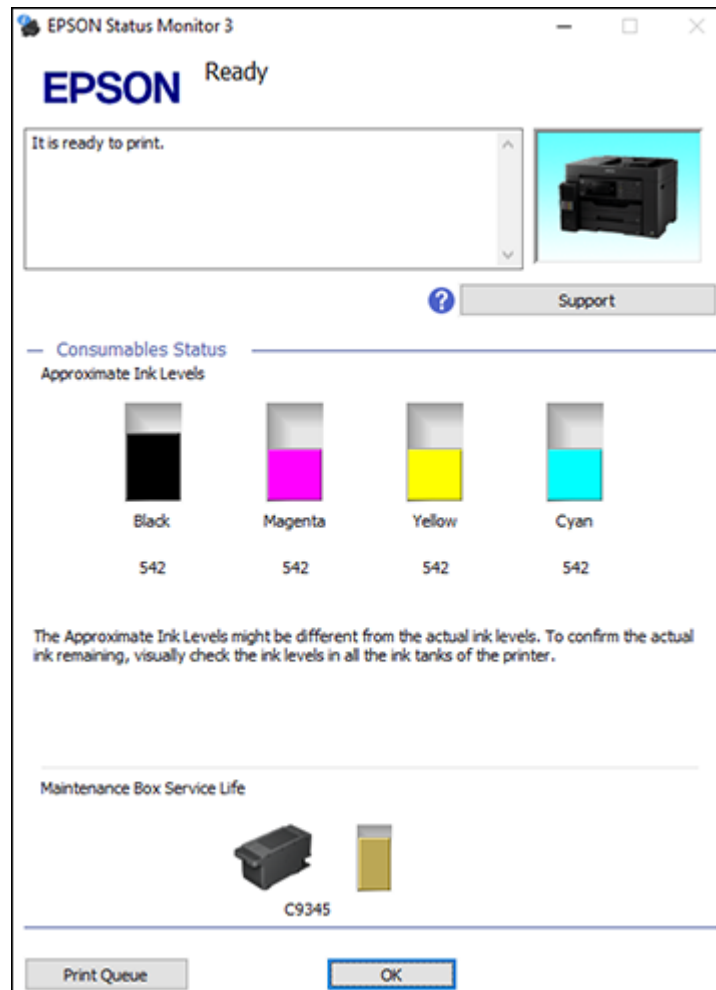

2. Refill any ink tank or replace the maintenance box as needed.

**Note:** The ink levels displayed are an estimate and may differ from the actual ink remaining in the ink tanks. To confirm the actual remaining ink, visually check the ink levels in the ink tanks. Continued use of the product when the ink level is below the lower line on the tank could damage the product.

**Parent topic:** [Checking the Ink and Maintenance Box Levels](#)

**Related concepts**

[Maintenance Box Replacement](#)

**Related tasks**

[Refilling the Ink Tanks](#)

## Checking Ink and Maintenance Box Levels - Mac

You can check your ink levels using a utility on your Mac.

1. In the Apple menu or the Dock, select **System Preferences**. Select **Print & Fax**, **Print & Scan**, or **Printers & Scanners**, select your product, and select **Options & Supplies**. Select **Utility** and select **Open Printer Utility**.
2. Select **EPSON Status Monitor**.

You see a window like this:

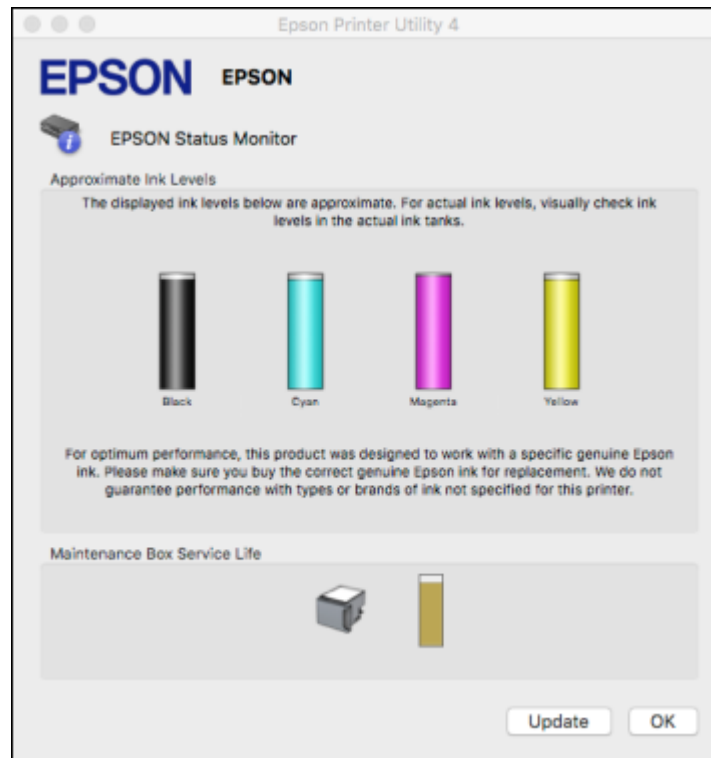

3. Refill any ink tank or replace the maintenance box as needed.

**Note:** To update or refresh the displayed ink levels, click **Update**.

**Note:** The ink levels displayed are an estimate and may differ from the actual ink remaining in the ink tanks. To confirm the actual remaining ink, visually check the ink levels in the ink tanks. Continued use of the product when the ink level is below the lower line on the tank could damage the product.

**Parent topic:** [Checking the Ink and Maintenance Box Levels](#)

**Related concepts**



[Maintenance Box Replacement](#)

**Related tasks**

[Refilling the Ink Tanks](#)

## Disabling Special Offers with Windows

You can disable special offers messages from Epson using a utility on your Windows computer.

1. Access the Windows Desktop and right-click the  icon for your product in the right side of the Windows taskbar, or click the up arrow and right-click . Select **Monitoring Preferences**.

You see this window:

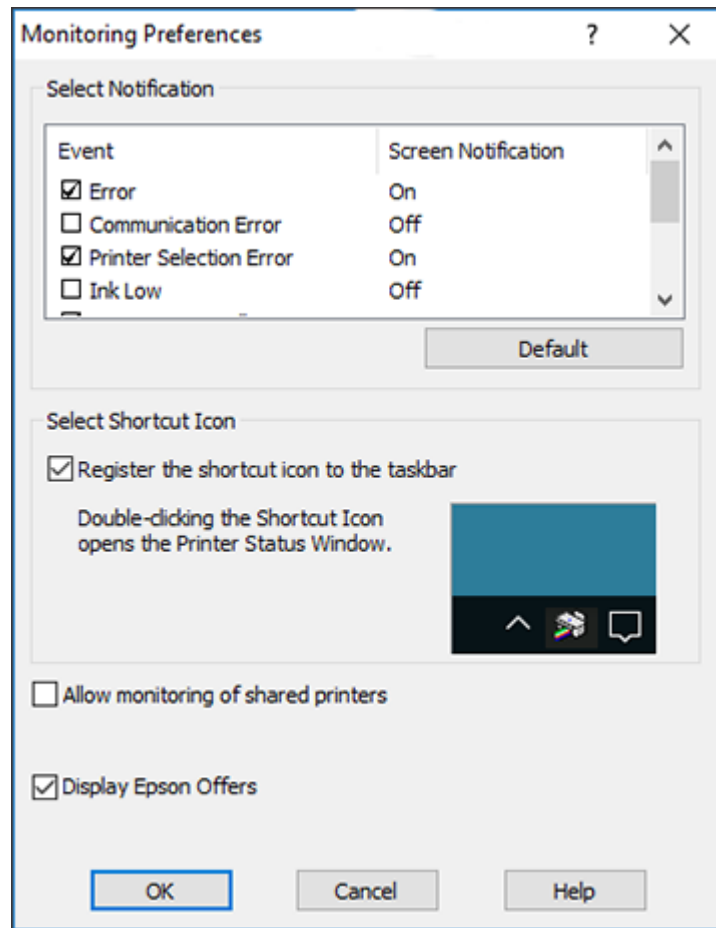

2. To disable promotional offers, deselect the **Display Epson Offers** checkbox.

Parent topic: [Checking the Ink and Maintenance Box Levels](#)

## Purchase Epson Ink and Maintenance Box

You can purchase genuine Epson ink, maintenance boxes, and paper at [epson.com](http://epson.com) (U.S. sales), [epson.ca](http://epson.ca) (Canadian sales), or [latin.epson.com](http://latin.epson.com) (Latin American sales). You can also purchase supplies from an Epson authorized reseller. To find the nearest one, call 800-GO-EPSON (800-463-7766) in the U.S. or 800-807-7766 in Canada.

**Note:** Epson's warranties do not extend to any damage caused by the use of third-party ink or ink not designed for your printer.

The included initial ink bottles must be used for printer setup and are not for resale. The printer ships with full ink bottles and part of the ink from the first bottles is used to charge the print head. Yields vary considerably based on images printed, print settings, paper type, frequency of use and temperature.

#### [Ink Bottle and Maintenance Box Part Numbers](#)

**Parent topic:** [Refilling Ink and Replacing the Maintenance Box](#)

## Ink Bottle and Maintenance Box Part Numbers

Use these part numbers when you order or purchase new ink bottles or a new maintenance box. Use the ink by the date printed on the package.

Ink color	Part number
Black	542120
Cyan	542220
Magenta	542320
Yellow	542420

**Maintenance box part number:** C12C934591

**Parent topic:** [Purchase Epson Ink and Maintenance Box](#)

## Refilling the Ink Tanks

Make sure you have a new ink bottle handy and have read the ink safety precautions before you begin.

You can continue to use the product even if one or more ink tanks are not filled all the way. However, for the most accurate ink level monitoring, fill all the ink tanks up to the upper line.

**Note:** The product has a low ink alert system. The accuracy of this system depends on the user refilling the ink tanks correctly. The product cannot directly measure the ink levels in the tanks; instead it estimates the amount of ink remaining by internally monitoring ink usage. The low ink alert system may generate inaccurate messages if the ink tanks are not refilled according to these instructions.

As a precaution, perform regular visual inspections of the ink tanks to ensure ink levels do not fall below the lower line. Continued use of the product when the ink level is below the lower line on the tank could damage the product.



**Caution:** If ink spills, wipe it off immediately with a damp towel to avoid permanent stains. If ink gets on your clothes or belongings, it may not come off.

1. Turn on your product.
2. Open the ink tank cover, then open the cap for the ink tank you are going to fill.

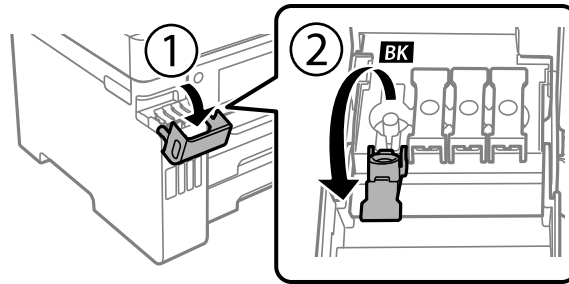

3. Hold the ink bottle upright and slowly turn the bottle cap to remove it.



**Caution:** Do not shake or squeeze the ink bottle. Do not touch the top of the bottle after its cap is removed.

**Warning:** If ink gets on your skin, wash it thoroughly with soap and water. If ink gets into your eyes, flush them immediately with water. If ink gets into your mouth, spit it out immediately. Seek medical advice if problems persist. Keep the ink bottles out of the reach of children and do not drink the ink.

4. Insert the ink bottle into the filling port and wait for the ink to fill the tank. Do not squeeze the bottle. Ink flows into the tank and stops automatically when the ink is filled to the upper line.

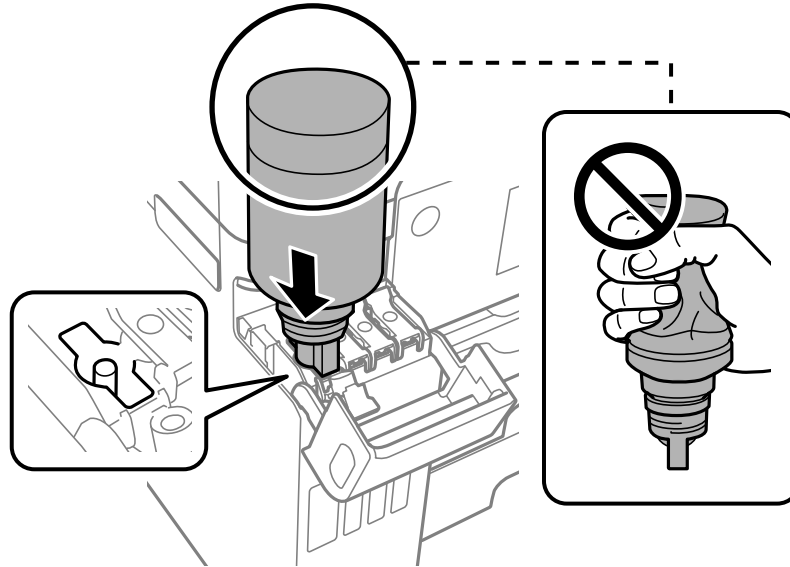

**Note:** Refer to the color-coded sticker on the ink tank unit to identify the color of each tank. Do not force the bottles into position; they are keyed for each color.

**Note:** If ink does not flow from the bottle, lift and reinsert the bottle.

5. When the ink tank is full, remove the ink bottle and securely close it with the cap.



**Note:** If any ink remains in the bottle, store the bottle upright for later use.

6. Close the ink tank cap.

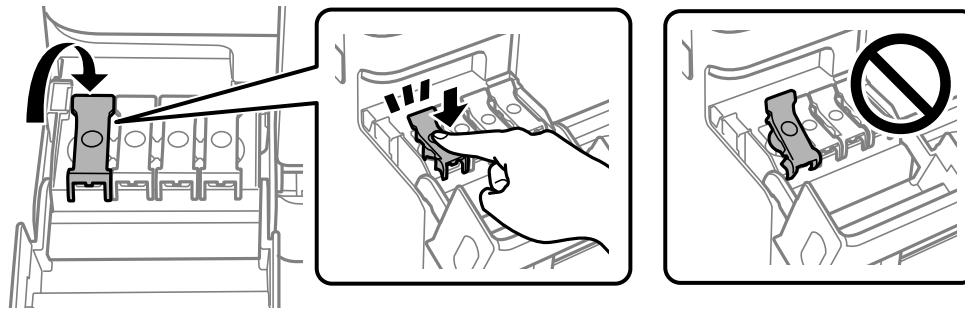

7. Repeat the previous steps as necessary for each ink tank you need to refill.

8. Close the ink tank cover.

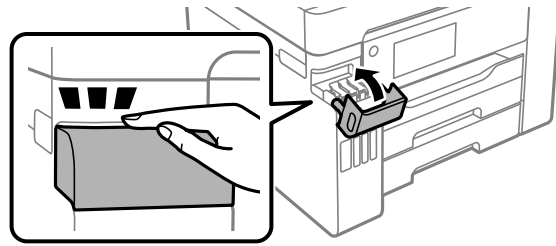

9. Select **Settings** > **Maintenance** > **Fill Ink** and follow the on-screen instructions to reset the ink levels.

**Parent topic:** [Refilling Ink and Replacing the Maintenance Box](#)

## Maintenance Box Replacement

The maintenance box stores surplus ink that gets collected during printing or print head cleaning. When you see a message on the LCD screen, follow the on-screen instructions to replace the maintenance box.

**Note:** When the maintenance box is full, you cannot print or clean the print head until it is replaced. However, you can perform operations that do not require ink, such as scanning.

Note the following precautions when replacing the maintenance box:

- Do not remove the maintenance box or its cover except when replacing the maintenance box; otherwise, ink may leak.
- Do not touch the green chip on the side of the maintenance box.
- Do not tilt the maintenance box after removing it or ink may leak.
- Do not touch the openings in the maintenance box or you may get ink on you.
- Do not drop the maintenance box or subject it to strong shocks.
- If you cannot replace the cover, the maintenance box may not be installed correctly. Remove and reinstall the maintenance box.
- Do not store the maintenance box in high or freezing temperatures.
- Do not replace the maintenance box during printing; otherwise, ink may leak.

- Keep the maintenance box out of direct sunlight.

**Caution:** Do not reuse a maintenance box that has been removed and left uninstalled for a long period. Keep the maintenance box away from direct sunlight.

**Note:** The maintenance box is a user-replaceable part and is not covered by the product warranty.

**Parent topic:** [Refilling Ink and Replacing the Maintenance Box](#)

---

## Adjusting Print Quality

If your print quality declines, you may need to run a utility to clean or align the print head.

If running these utilities does not solve the problem, you may need to run a Power Cleaning or clean the paper path.

[Print Head Maintenance](#)

[Print Quality Adjustment](#)

[Power Cleaning](#)

[Cleaning the Paper Guide](#)

## Print Head Maintenance

If your printouts become too light, or you see dark or light bands across them, you may need to clean the print head nozzles. Cleaning uses ink, so clean the nozzles only if print quality declines.

You can check for clogged nozzles before you clean them so you don't clean them unnecessarily.

**Note:** You may not be able to clean the print head when the ink level in any of the tanks is low. You may have to refill the ink tank first.

If you still see white or dark lines or gaps in your printouts, even after cleaning the print head several times, you can run a Power Cleaning.

[Print Head Nozzle Check](#)

[Print Head Cleaning](#)

**Parent topic:** [Adjusting Print Quality](#)

## Print Head Nozzle Check

You can print a nozzle check pattern to check for clogged nozzles.

[Checking the Nozzles Using the Product Control Panel](#)

[Checking the Nozzles Using a Computer Utility](#)

**Parent topic:** [Print Head Maintenance](#)

## Checking the Nozzles Using the Product Control Panel

You can check the print head nozzles using the control panel on your product.

1. Make sure there are no errors on the LCD screen.

2. Load a few sheets of plain paper in the product.
3. Press the  home button, if necessary.
4. Select **Settings** > **Maintenance** > **Print Head Nozzle Check**.

You see a screen like this:



5. Select **Start**.  
The nozzle pattern prints.
6. Check the printed pattern to see if there are gaps in the lines.

**Print head is clean**



## Print head needs cleaning



7. Do one of the following:
  - If there are no gaps, select **O**.
  - If there are gaps or the pattern is faint, select **X** and continue.
8. Follow the instructions on the screen to clean the print head, check the nozzles, and repeat the process as necessary.

**Caution:** Never turn off the product or open the front cover during a cleaning cycle or you may not be able to print.

If you don't see any improvement after cleaning the print head up to 3 times, wait at least 12 hours without printing or longer if printing. Then try cleaning the print head again. If quality does not improve, run a Power Cleaning. If quality still does not improve, contact Epson.

**Parent topic:** [Print Head Nozzle Check](#)

### Related concepts



[Print Head Cleaning](#)

### Related topics

[Loading Paper](#)

## Checking the Nozzles Using a Computer Utility

You can check the print head nozzles using a utility on your Windows or Mac computer.

1. Load a few sheets of plain paper in the product.
2. Do one of the following:
  - **Windows:** Access the Windows Desktop and right-click the  icon for your product in the right side of the Windows taskbar, or click the up arrow and right-click .



- **Mac:** In the Apple menu or the Dock, select **System Preferences**. Select **Print & Fax**, **Print & Scan**, or **Printers & Scanners**, select your product, and select **Options & Supplies**. Select **Utility** and select **Open Printer Utility**.
3. Select **Print Head Nozzle Check**.

You see a window like this:

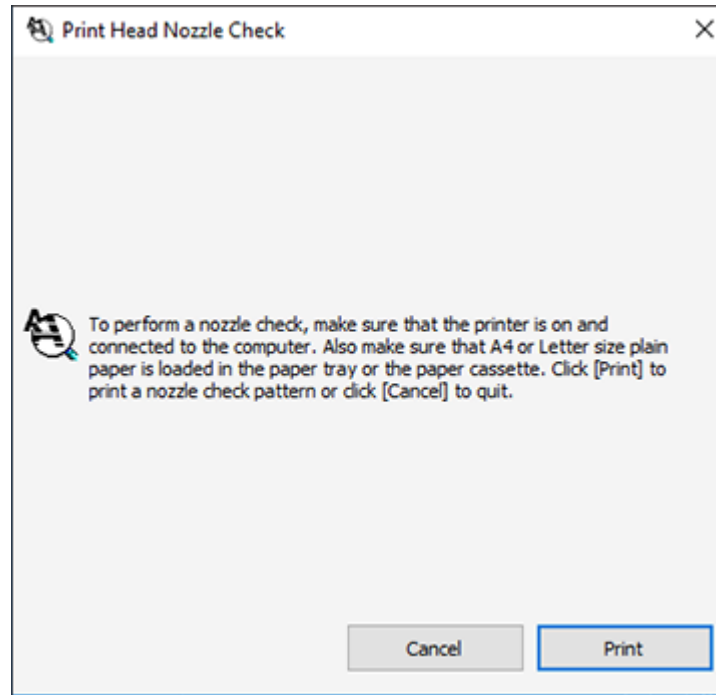

4. Click **Print**.

5. Check the printed pattern to see if there are gaps in the lines.

**Print head is clean**



**Print head needs cleaning**



6. If there are no gaps, click **Finish**.  
If there are gaps or the pattern is faint, clean the print head.

**Parent topic:** [Print Head Nozzle Check](#)

**Related concepts**

[Print Head Cleaning](#)

**Related topics**

[Loading Paper](#)

## Print Head Cleaning

If print quality has declined and the nozzle check pattern indicates clogged nozzles, you can clean the print head.

**Note:** You may not be able to clean the print head when the ink level in any of the tanks is low. You may have to refill the ink tank first.

[Cleaning the Print Head Using the Product Control Panel](#)

[Cleaning the Print Head Using a Computer Utility](#)

**Parent topic:** [Print Head Maintenance](#)

## Related tasks

[Refilling the Ink Tanks](#)

### Cleaning the Print Head Using the Product Control Panel

You can clean the print head using the control panel on your product.

1. Make sure there are no errors on the LCD screen.
2. Load a few sheets of plain paper in the product.
3. Press the  home button, if necessary.
4. Select **Settings** > **Maintenance** > **Print Head Cleaning**.

You see a screen like this:

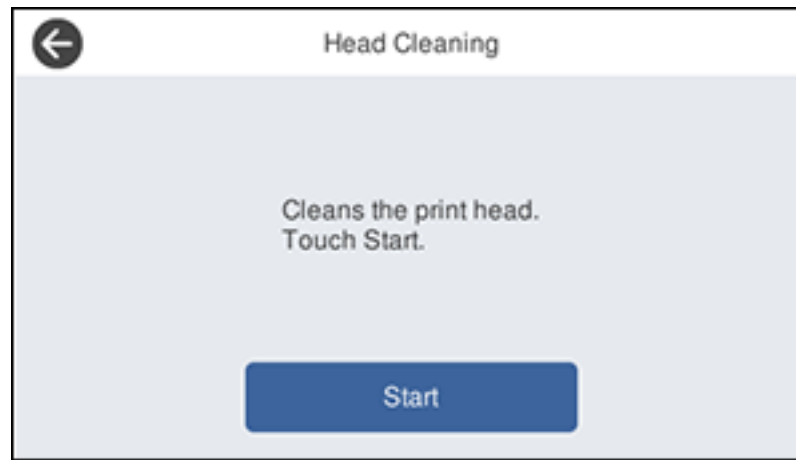

5. Select **Start** to clean the print head.

When the cleaning cycle is finished, you see a message on the screen.

**Caution:** Never turn off the product or open the front cover during a cleaning cycle or you may not be able to print.

6. Select **Yes** if you want to print a new nozzle check pattern.
7. Select **Start** to print a nozzle check pattern and confirm that the print head is clean.

8. Check the printed pattern to see if there are gaps in the lines.

#### **Print head is clean**



#### **Print head needs cleaning**



If you don't see any improvement after cleaning the print head up to 3 times, wait at least 12 hours without printing or longer if printing. Then try cleaning the print head again. If quality does not improve, run a Power Cleaning. If quality still does not improve, contact Epson.



**Parent topic:** [Print Head Cleaning](#)

#### **Related topics**

[Loading Paper](#)

### **Cleaning the Print Head Using a Computer Utility**

You can clean the print head using a utility on your Windows or Mac computer.

1. Make sure there are no errors on the LCD screen.
2. Load a few sheets of plain paper in the product.
3. Do one of the following:
  - **Windows:** Access the Windows Desktop and right-click the  icon for your product in the right side of the Windows taskbar, or click the up arrow and right-click .
  - **Mac:** In the Apple menu or the Dock, select **System Preferences**. Select **Print & Fax**, **Print & Scan**, or **Printers & Scanners**, select your product, and select **Options & Supplies**. Select **Utility** and select **Open Printer Utility**.
4. Select **Print Head Cleaning**.

You see a window like this:

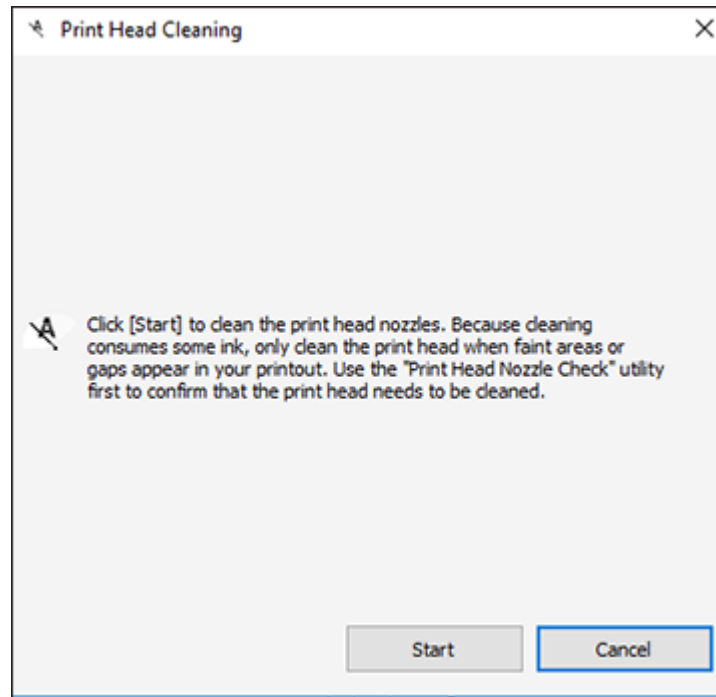

5. Click **Start** to begin the cleaning cycle.

The  power light flashes throughout the cleaning cycle and stays on when the cleaning cycle is finished.

**Caution:** Never turn off the product or open the scanner unit during a cleaning cycle or you may not be able to print.

6. When the cleaning cycle is finished, you can check to see if the nozzles are clean; click **Print Nozzle Check Pattern** and click **Print**.

7. Check the printed pattern to see if there are gaps in the lines.

#### Print head is clean



#### Print head needs cleaning



- If there are no gaps, click **Finish**.
- If there are gaps or the pattern is faint, click **Clean** to clean the print head again.

If you don't see any improvement after cleaning the print head up to 3 times, turn off the product and wait at least 12 hours. Then try cleaning the print head again. If quality still does not improve, run a Power Cleaning. If there is still no improvement, contact Epson support.

**Parent topic:** [Print Head Cleaning](#)

#### Related topics

[Loading Paper](#)

## Print Quality Adjustment

If your printouts become grainy or blurry, you notice misalignment of vertical lines, or you see dark or light horizontal bands, you may need to adjust the print quality.

**Note:** Banding may also occur if your print head nozzles need cleaning.

[Adjusting the Print Quality Using the Product Control Panel](#)

**Parent topic:** [Adjusting Print Quality](#)

## Adjusting the Print Quality Using the Product Control Panel

You can adjust the print quality using the control panel on your product.

1. Make sure there are no errors on the LCD screen.
2. Load a few sheets of plain paper in the product.
3. Press the  home button, if necessary.
4. Select **Settings > Maintenance > Print Quality Adjustment**.
5. Follow the on-screen instructions to print an alignment sheet.

**Note:** Do not cancel printing while you are printing head alignment patterns.

6. Check the printed patterns on the alignment sheet and select number of the best printed pattern for each set:
  - Select the number representing the pattern with the least amount of separation or overlap.

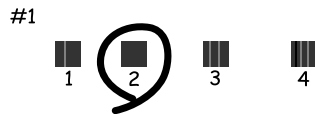

- Select the number representing the pattern with the least misaligned vertical line.

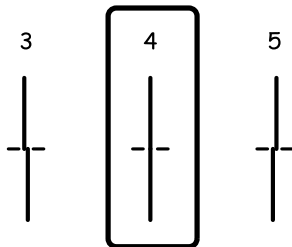

- Select the number representing the pattern with the least amount of separation or overlap.

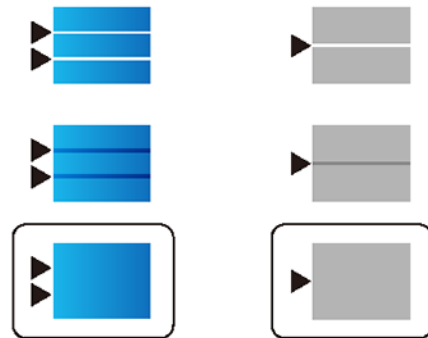

7. Continue following the on-screen instructions to finish the print quality adjustment.

**Parent topic:** [Print Quality Adjustment](#)

**Related topics**

[Loading Paper](#)

## Power Cleaning

If you still see white or dark lines or missing nozzles in your printouts, even after cleaning the print head several times, you can run a Power Cleaning.

If you do not see improvement after running a Power Cleaning, turn off the product and wait at least 12 hours before running another Power Cleaning.

**Caution:** Running a Power Cleaning consumes a lot of ink, so you should run it only if necessary. Make sure each ink tank is at least one-third full before running a Power Cleaning, or it may damage the product.

**Caution:** Power Cleaning may cause the maintenance box to reach its capacity sooner. When the maintenance box is full, you need to replace it to continue printing.

[Power Cleaning Using a Computer Utility](#)

[Power Cleaning Using the Product Control Panel](#)

**Parent topic:** [Adjusting Print Quality](#)



### Related concepts

[Maintenance Box Replacement](#)



### Related tasks

[Refilling the Ink Tanks](#)

## Power Cleaning Using a Computer Utility

You can run a Power Cleaning using a utility on your Windows or Mac computer.

**Note:** After running a Power Cleaning, you must turn off the product and wait at least 12 hours before running another Power Cleaning.

1. Make sure there are no errors on the LCD screen.
2. Load a few sheets of plain paper in the product.
3. Do one of the following:
  - **Windows:** Access the Windows Desktop and right-click the  icon for your product in the right side of the Windows taskbar, or click the up arrow and right-click . Select **Printer Settings** and click the **Maintenance** tab.
  - **Mac:** In the Apple menu or the Dock, select **System Preferences**. Select **Print & Fax**, **Print & Scan**, or **Printers & Scanners**, select your product, and select **Options & Supplies**. Select **Utility** and select **Open Printer Utility**.
4. Select **Power Cleaning**.

You see a window like this:

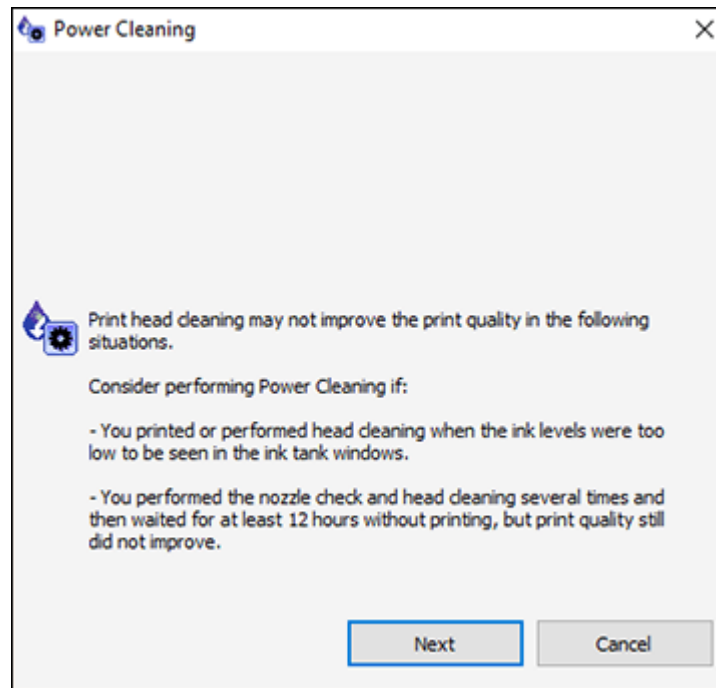

5. Follow the on-screen instructions to run a Power Cleaning.
6. When Power Cleaning is finished, run a nozzle check.

If print quality has not improved after running Power Cleaning, wait for at least 12 hours without printing, and then print the nozzle check pattern again. Run Print Head Cleaning or Power Cleaning again depending on the printed pattern. If quality still does not improve, contact Epson support.

**Parent topic:** [Power Cleaning](#)

**Related topics**

[Loading Paper](#)



## Power Cleaning Using the Product Control Panel

You can run a Power Cleaning using the control panel on your product.

After a Power Cleaning, you must turn off the product and wait at least 12 hours before running another Power Cleaning.

1. Turn off the product.
2. Visually check the ink levels and make sure each ink tank is at least one-third full.

**Caution:** If you run a Power Cleaning when the ink levels are low, you may damage the product.

3. Press and hold the  power button and the  help button at the same time until the Power Cleaning screen appears on the LCD screen.
4. Follow the on-screen instructions to run the Power Cleaning.
5. When the Power Cleaning is finished, run a nozzle check.

If the print quality did not improve, turn off the printer and wait at least 12 hours before running another Power Cleaning.

If the print quality does not improve after running the Power Cleaning utility multiple times, contact Epson for support.

**Parent topic:** [Power Cleaning](#)

#### **Related tasks**

[Refilling the Ink Tanks](#)

#### **Related topics**

[Loading Paper](#)

## **Cleaning the Paper Guide**

If you see ink on the back of a printout, you can clean the paper guide rollers to remove any excess ink.

1. If printouts are smeared or scuffed, load plain paper in the paper source that you want to clean in one of these sizes: Letter (8.5 × 11 inches [216 × 279 mm]) or A4 (8.3 × 11.7 inches [210 × 297 mm]).
2. Press the  home button, if necessary.
3. Select **Settings > Maintenance > Paper Guide Cleaning**.
4. Select the paper source you want to clean.
5. Follow the on-screen instructions to clean the paper guide.
6. Repeat these steps as necessary until the paper comes out clean.

**Note:** If the paper is still smeared or scuffed, repeat these steps to clean the other paper sources.

**Parent topic:** [Adjusting Print Quality](#)

**Related topics**

[Loading Paper](#)

---

# Cleaning and Transporting Your Product

See these sections if you need to clean or transport your product.

[Cleaning Your Product](#)

[Transporting Your Product](#)

## Cleaning Your Product

To keep your product working at its best, you should clean it several times a year.

**Caution:** Do not use a hard brush, benzene, alcohol, or paint thinner to clean the product or you may damage it. Do not use oil or other lubricants inside the product or let water get inside it. Close the rear paper feed slot when you are not using it, to keep out dust.

1. Turn off the product.
2. Wait for the  power light to turn off, then unplug the power cable.
3. Disconnect any connected cables.
4. Remove all the paper from the product.
5. Clean the outer case and control panel with a soft, dry cloth. Do not use liquid or chemical cleansers.
6. Clean any paper cassettes using a soft brush.

7. Clean the scanner glass and the glass area on the left with a soft, lint-free cloth (microfiber is recommended), moistened with a little glass cleaner.

**Caution:** Do not spray glass cleaner directly on the glass and do not press the glass surface with any force.

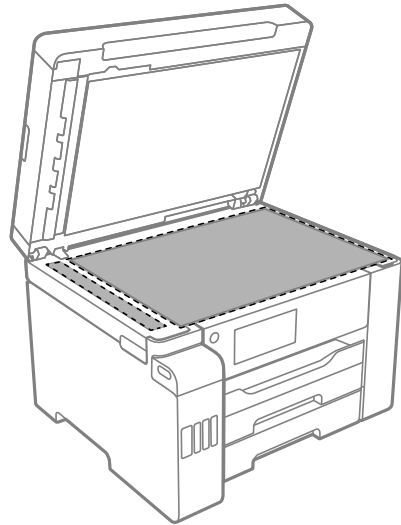

**Note:** If lines appear on the printout or in scanned images, carefully clean the scanner glass on the left.

8. Clean the document mat using a soft, lint-free cloth (microfiber is recommended), moistened with a mild detergent.

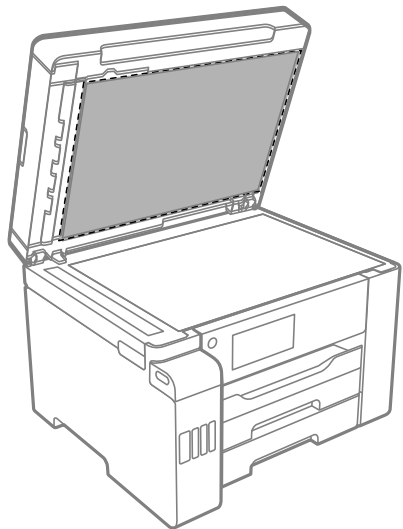

9. Wipe the document mat with a clean, dry cloth.
10. Open the ADF cover.

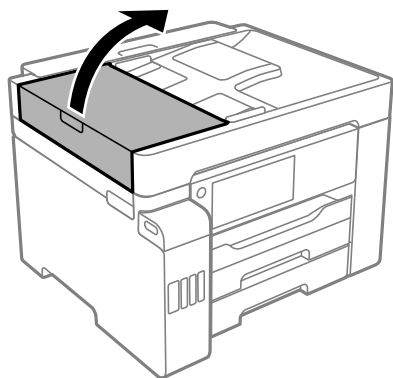

11. Use a soft, dry, lint-free cloth (microfiber is recommended) to clean the rollers and the interior of the ADF.

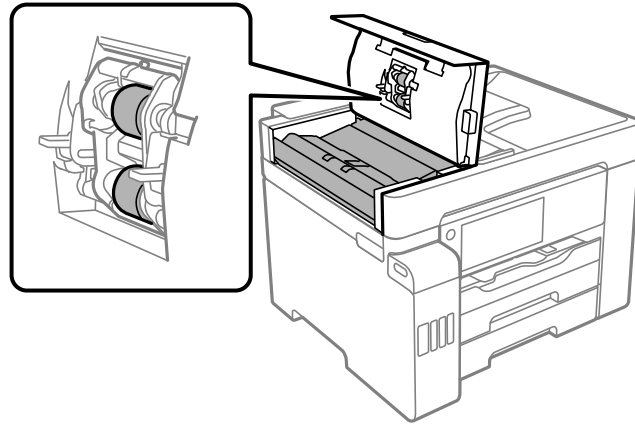

12. Close the ADF cover.

Parent topic: [Cleaning and Transporting Your Product](#)

## Transporting Your Product

If you need to store your product or transport it a long distance, prepare it for transportation as described here.

**Caution:** During transportation and storage, follow these guidelines:

- Because the product is heavy, two or more people should lift and carry it using the hand positions shown here:

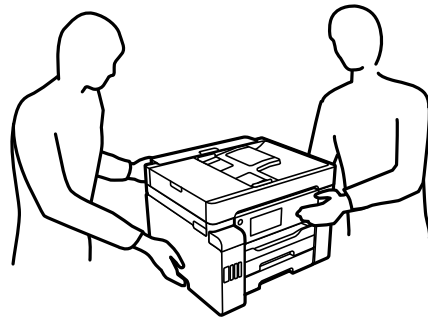



- Avoid tilting the product, placing it vertically, or turning it upside down; otherwise ink may leak. When storing or transporting the printer, place it in a plastic bag and fold it closed.

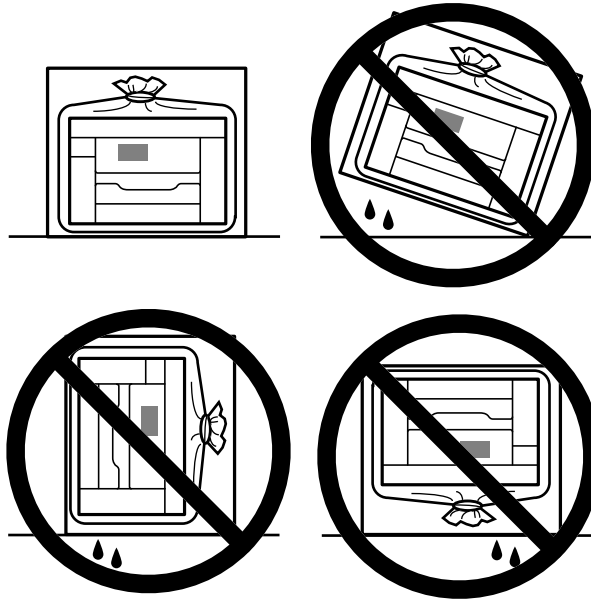

- When storing or transporting an ink bottle after removing its seal, do not tilt the bottle and do not subject it to impacts or temperature changes. Otherwise, ink may leak even if the cap on the ink bottle is tightened securely. Be sure to keep the ink bottle upright when tightening the cap, and take measures to prevent ink from leaking when transporting the ink bottles.
  - Do not put opened ink bottles in the box with the product.
1. Turn off the product.
  2. Wait for the  $\text{⏻}$  power light to turn off, then unplug the power cable.
  3. Disconnect any connected cables.
  4. Remove all the paper from the product and make sure there are no originals on the scanner glass.
  5. Lift up the scanner unit.

6. Make sure the print head is in the home position on the right and move the transportation lock to the transport position.

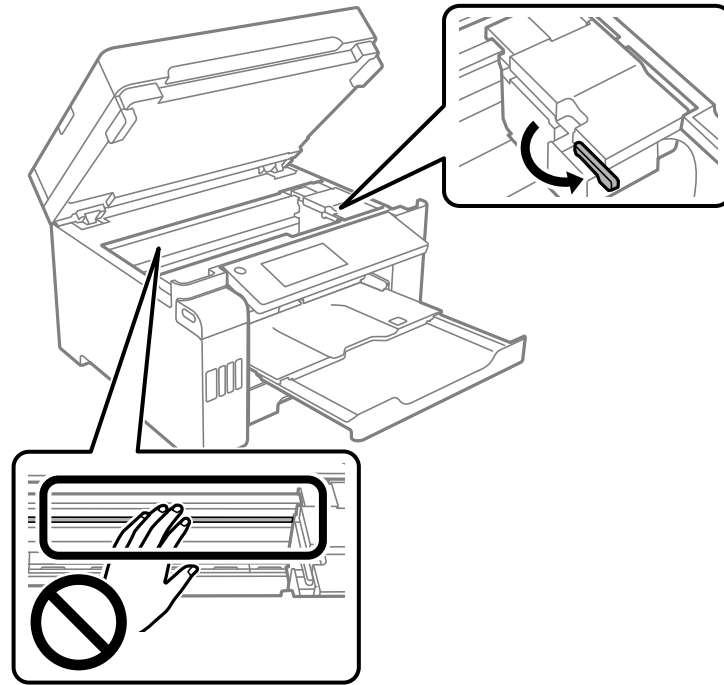

**Caution:** Do not touch the translucent film inside the product; otherwise, you may damage your product.

7. Secure the print head to the case with tape as shown.

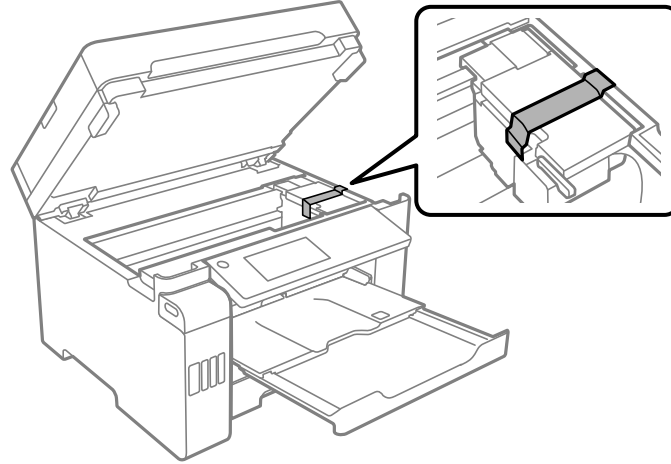

8. Lower the scanner unit.
9. Close the rear paper feed slot and output tray and lower the control panel.

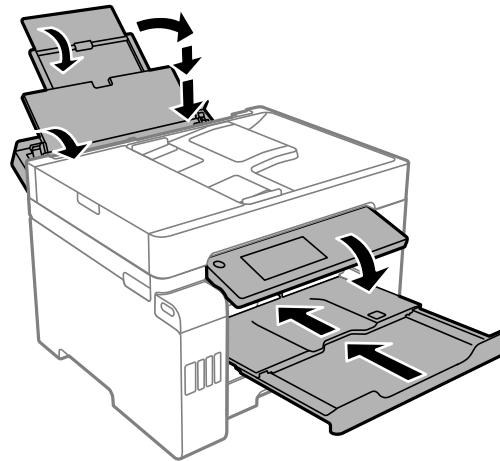

10. Place the printer in a plastic bag and fold it closed.

11. Place the product in its original packing materials, if possible, or use equivalent materials with cushioning around the product.

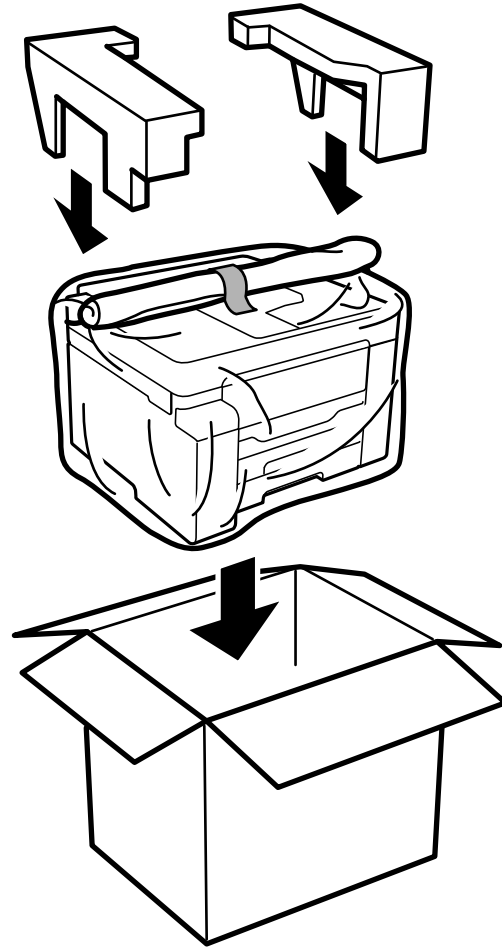

Keep the product level during transportation. If print quality has declined when you print again, clean and align the print head. Make sure you remove the tape securing the print head before using the printer.

**Parent topic:** [Cleaning and Transporting Your Product](#)

**Related concepts**

[Print Head Cleaning](#)

## Print Quality Adjustment

---

# Solving Problems

Check these sections for solutions to problems you may have using your product.

[Checking for Software Updates](#)

[Product Status Messages](#)

[Running a Product Check](#)

[Resetting Control Panel Defaults](#)

[Solving Setup Problems](#)

[Solving Network Problems](#)

[Solving Copying Problems](#)

[Solving Paper Problems](#)

[Solving Problems Printing from a Computer](#)

[Solving Page Layout and Content Problems](#)

[Solving Print Quality Problems](#)

[Solving Scanning Problems](#)

[Solving Scanned Image Quality Problems](#)

[Solving Faxing Problems](#)



[Solving USB Device Problems](#)

[Uninstall Your Product Software](#)

[Where to Get Help](#)

## Checking for Software Updates

It's a good idea to check Epson's support website occasionally for free updates to your product software. Visit [epson.com/support](http://epson.com/support) (U.S.), [epson.ca/support](http://epson.ca/support) (Canada), or [latin.epson.com/support](http://latin.epson.com/support) (Latin America) and select your product.

- **Windows:** Your printer software automatically checks for updates. You can also manually update the software by selecting **Software Update** here:
  - Accessing the Windows Desktop and right-clicking the  icon for your product in the right side of the Windows taskbar, or clicking the up arrow and right-clicking .
  - On the **Maintenance** tab in the printer settings window

You can also update the software by selecting **EPSON Software Updater** in the **EPSON** or **Epson Software** program group, accessible by the **Start** button, or on the **Start** or **Apps** screens, depending on your version of Windows.

- **OS X:** You can manually update the software by opening the **Applications > Epson Software** folder and selecting **EPSON Software Updater**.
- **macOS 10.12.x, 10.13.x, 10.14.x, or 10.15.x:** You can manually update the software by opening the **App Store**, selecting **Updates**, searching for a software update option for Epson Software, and selecting **Update**.

**Parent topic:** [Solving Problems](#)

**Related references**

[Where to Get Help](#)

## Product Status Messages

You can often diagnose problems with your product by checking the messages and status icons on its LCD screen. You can also check for errors by pressing the  **Job/Status** button and selecting **Printer Status**.

**Note:** If the LCD screen is dark, press the screen to wake the product from sleep mode.

LCD screen message	Condition/solution
Printer error. Turn the power off and on again. If the problem persists, contact Epson Support.	Turn the product off and then back on again. If the error persists, check for and remove any jammed paper or protective materials from the product. If the error still persists, contact Epson for support.
Printer error. Contact Epson Support. Non-printing features are available.	The product may be damaged, but features such as scanning are still available. Contact Epson for support.
Printer error. For details, see your documentation.	The product may be damaged. Contact Epson for support.
Paper out in XX. Load paper. Paper Size: XX/Paper Type: XX	Load the size and type of paper in the indicated paper source.
The printer's borderless printing ink pad is nearing the end of its service life. It is not a user-replaceable part. Please contact Epson support.	The ink pad is near the end of its service life and the message will be displayed until the ink pad is replaced. Contact Epson for support. (To resume printing, press <b>OK</b> .)

LCD screen message	Condition/solution
The printer's borderless printing ink pad has reached the end of its service life. It is not a user-replaceable part. Please contact Epson support.	The ink pad is at the end of its service life. Turn off the product and contact Epson for support. You can still perform operations that do not use ink, such as scanning.
Paper Setup Auto Display is set to Off. Some features may not be available. For details, see your documentation.	AirPrint is not available when the <b>Paper Setup Auto Display</b> setting is turned off. Change the <b>Paper Setup Auto Display</b> setting to <b>On</b> .
No dial tone detected.	Make sure the phone cable is connected correctly and the phone line works. If you connected the product to a PBX (Private Branch Exchange) phone line or Terminal Adapter, change the <b>Line Type</b> setting to <b>PBX</b> . Use a # (hash) instead of the actual access code when entering an outside fax number. This makes the connection more secure. If you still cannot send a fax, turn off the <b>Dial Tone Detection</b> setting. (Turning off the Dial Tone Detection setting may cause the product to drop the first digit of a fax number.)
Failed to receive faxes because the fax data capacity is full. Touch the Job/Status at the bottom of the Home Screen for details.	Press the  <b>Job/Status</b> button, select <b>Printer Status</b> , and resolve any printer errors that prevented faxes from printing. Make sure the product is connected to a computer or that an external USB device is connected to the product.
The combination of the IP address and the subnet mask is invalid. See your documentation for more details.	Contact your product administrator.
To use cloud services, update the root certificate from the Epson Web Config utility.	Contact your product administrator.
Check that the printer driver is installed on the computer and that the port settings for the printer are correct.	On a Windows computer, go to <b>Control Panel &gt; Hardware and Sound &gt; Devices and Printers</b> . Right-click the printer and select <b>Printer Properties</b> . Make sure the printer port is selected correctly in the <b>Ports</b> tab. Select the <b>USBXXX</b> setting for a USB connection or <b>EpsonNet Print Port</b> for a network connection.
Recovery mode	Contact your product administrator.



Parent topic: [Solving Problems](#)

## Running a Product Check

Running a product check helps you determine if your product is operating properly.

1. Disconnect any interface cables connected to your product.
2. Load plain paper in the paper cassette.
3. Press the  home button, if necessary.
4. Select **Settings** > **Maintenance**.

You see a screen like this:



5. Select **Print Head Nozzle Check**.

You see a screen like this:



6. Select **Start**.

The nozzle pattern prints.

7. Do one of the following, depending on the results of the product check:

- If the page prints and the nozzle check pattern is complete, the product is operating properly. Any operation problem you may have could be caused by your computer, cable, software, or selected settings. Check the other solutions in this guide or try uninstalling and reinstalling your printer software.
- If the page prints but the nozzle check pattern has gaps, clean the print head.
- If the page does not print, the product may have a problem. Check the other solutions in this manual. If they do not work, contact Epson.

**Parent topic:** [Solving Problems](#)

**Related concepts**

[Uninstall Your Product Software](#)

[Print Head Cleaning](#)

**Related references**

[Where to Get Help](#)

## Resetting Control Panel Defaults

If you have a problem with settings on the product control panel, you can reset them to their factory defaults. You can choose which settings to reset or reset them all.

**Note:** This setting can be locked by an administrator. If you cannot access or change this setting, contact your administrator for assistance.

1. Press the  home button, if necessary.
2. Select **Settings** > **General Settings** > **System Administration**. Enter the administrator password, if necessary.
3. Scroll down and select **Restore Default Settings**.

You see a screen like this:

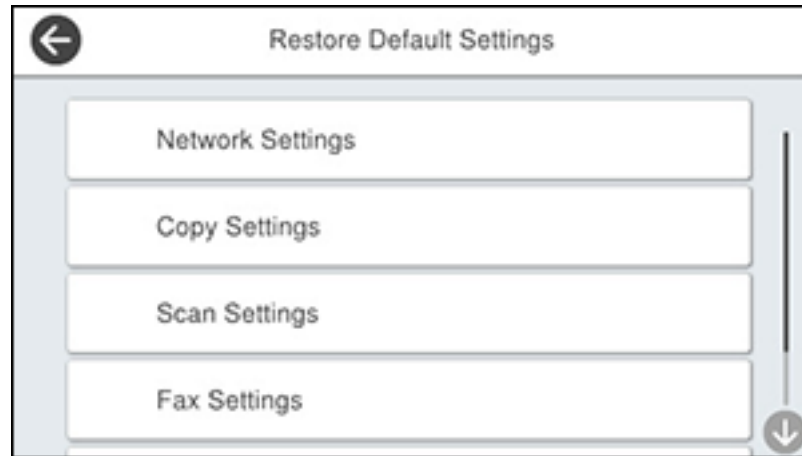

4. Select one of these options:
  - **Network Settings:** Resets all network settings
  - **Copy Settings:** Resets all settings for copying
  - **Scan Settings:** Resets all settings for scanning
  - **Fax Settings:** Resets all settings for faxing
  - **Clear All Data and Settings:** Resets all control panel settings including the contacts list

You see a confirmation screen.

5. Select **Yes** to reset the selected settings. (Select **No** if you want to cancel the operation.)

**Parent topic:** [Solving Problems](#)

## Solving Setup Problems

Check these sections if you have problems while setting up your product.

[Product Does Not Turn On or Off](#)

[Noise After Filling the Ink](#)

[Software Installation Problems](#)

**Parent topic:** [Solving Problems](#)

### Product Does Not Turn On or Off

If you cannot turn the product on or off, try these solutions:

- If you cannot turn on your product, make sure the power cord is securely connected and hold down the power button a little longer.
- If you cannot turn off your product, hold down the power button a little longer. If you still cannot turn off your product, unplug the power cord, plug the power cord back in, then turn your product on and off again using the power button.

**Parent topic:** [Solving Setup Problems](#)

### Noise After Filling the Ink

If you hear noises from your product after filling the ink tanks with ink, check these explanations:

- The first time you fill the tanks with ink, the product must charge its print head. Wait until charging finishes before you turn off the product, or it may charge improperly and use excess ink the next time you turn it on. Your product is finished charging the print head when the  power light stops flashing.
- If the product's print head stops moving or making noise, and the charging process has not finished after approximately 20 minutes, turn off your product. Turn it back on and check to see if charging is still in progress. If it is still in progress, contact Epson for help.

**Parent topic:** [Solving Setup Problems](#)

## Software Installation Problems

If you have problems while installing your product software, try these solutions:

- Make sure your product is turned on and any necessary cables are securely connected at both ends. If you still have problems installing software, disconnect the cable and carefully follow the instructions on the *Start Here* sheet. Also make sure your system meets the requirements for your operating system.
- Close any other programs, including screen savers and virus protection software, and install your product software again.
- In Windows, make sure your product is selected as the default printer and the correct port is shown in the printer properties.
- If you see any error message or your software does not install correctly in Windows, you may not have software installation privileges. Contact your system administrator.
- If you are printing over a network, make sure your product is set up properly on the network.

**Parent topic:** [Solving Setup Problems](#)

### Related references

[Windows System Requirements](#)

[Mac System Requirements](#)

## Solving Network Problems

Check these solutions if you have problems setting up or using your product on a network.

**Note:** Breakdown or repair of this product may cause loss of fax and network data and settings. Epson is not responsible for backing up or recovering data and settings during or after the warranty period. We recommend that you make your own backup or print out your fax and network data and settings.

[Product Cannot Connect to a Wireless Router or Access Point](#)

[Network Software Cannot Find Product on a Network](#)

[Product Does Not Appear in Mac Printer Window](#)

[Wireless Network Connection is Unstable on a Mac](#)

[Cannot Print Over a Network](#)

[Cannot Scan Over a Network](#)

**Parent topic:** [Solving Problems](#)

## Product Cannot Connect to a Wireless Router or Access Point

If your product has trouble finding or connecting to a wireless router or access point, try these solutions:

- If you are connecting the product via Wi-Fi Protected Setup (WPS) and the Wi-Fi icon on your product's LCD screen is not lit or does not appear, make sure you select one of the WPS options from the product control panel within 2 minutes of pressing the WPS button on your router.
- Make sure to place your product within contact range of your router or access point. Avoid placing your product near a microwave oven, cordless phone, or large metal object, such as a filing cabinet.
- Verify that your router or access point is operating correctly by connecting to it from your computer or another device.
- Print a network connection report and check the codes and messages on the report to help determine the cause of the problem.
- You may need to disable the firewall and any anti-virus software on your wireless router or access point.
- Try restarting your router following the instructions in your router documentation.

**Note:** If you are reading these instructions online, you will lose your Internet connection when you restart your router.

- Check to see if access restrictions, such as MAC address filtering, are set on the router or access point. If access restrictions are set, add your product's MAC address to your router's address list. To obtain your product's MAC address, print a network status sheet. Then follow the instructions in your router or access point documentation to add the address to the list.
- If your router or access point does not broadcast its network name (SSID), follow the instructions that came with your product to enter your wireless network name manually.
- If your router or access point has security enabled, determine the kind of security it is using and any required password or passphrase for connection. Then make sure to enter the exact WEP key or WPA passphrase correctly.
- Check if your computer is restricting the available wireless channels. If so, verify that your wireless access point is using one of the usable channels and change to a usable channel, if necessary.
- If you cannot connect your product to a device using Wi-Fi Direct, you may have exceeded the maximum number of devices connected to your product (8). Print a network status sheet or access Web Config on the browser for your device and check the number of connected devices. If 8 devices are already connected, disconnect a device by deleting the product's SSID from the Wi-Fi screen of that device. If fewer than 8 devices are connected, check the accuracy of your other network settings, move your device closer to your product, and try connecting again.

- If you are using a Wi-Fi Direct connection that suddenly disconnects, the Wi-Fi direct password on your device may have been changed. If necessary, delete the existing **DIRECT-xxxxxxx** connection settings from your device and enter a new password. See your device documentation for instructions.

**Parent topic:** [Solving Network Problems](#)

**Related concepts**

[Wi-Fi Direct Mode Setup](#)

**Related tasks**

[Selecting Wireless Network Settings from the Control Panel](#)

[Printing a Network Status Sheet](#)

[Printing a Network Connection Report](#)

**Related topics**

[Wi-Fi or Wired Networking](#)

## Network Software Cannot Find Product on a Network

If EpsonNet Setup cannot find your product on a network, try these solutions:

- Make sure your product is turned on and connected to your network. Verify the connection using your product control panel.
- Check if your network name (SSID) contains non-ASCII characters. Your product cannot display non-ASCII characters.
- Print a network connection report and check the codes and messages on the report to help determine the cause of the problem.
- Make sure your product is not connected to a guest network.
- If necessary, reinstall your product software and try running EpsonNet Setup again:
  1. Reset your product's network settings to their factory defaults.
  2. **Windows only:** Uninstall your product software.
  3. Restart your router following the instructions in your router documentation.

**Note:** If you are reading these instructions online, you will lose your Internet connection when you restart your router, so note the next step before restarting it.

4. Download your product software from the Epson website using the instructions on the *Start Here* sheet.
- If you have replaced your router, reinstall your product software to connect to the new router.

- Check to see if your wireless router or access point has an enabled Privacy Separator function that is preventing detection of your device over the network. See your router or access point documentation for instructions on disabling the Privacy Separator function.

**Parent topic:** [Solving Network Problems](#)

**Related concepts**

[Uninstall Your Product Software](#)

**Related tasks**

[Printing a Network Connection Report](#)

**Related topics**

[Wi-Fi or Wired Networking](#)

## Product Does Not Appear in Mac Printer Window

If your product does not appear in the Mac printer window, try these solutions:

- Turn your product off, wait 30 seconds, then turn it back on again.
- If you are connecting the product via Wi-Fi Protected Setup (WPS) and the Wi-Fi icon on your product's LCD screen is not lit, make sure you select one of the WPS options from the product control panel within 2 minutes of pressing the WPS button on your router.
- If you are connecting the product wirelessly via EpsonNet Setup and the Wi-Fi icon does not appear on your LCD screen, make sure your product software was installed correctly. If necessary, reinstall your software.

**Parent topic:** [Solving Network Problems](#)

**Related concepts**

[Uninstall Your Product Software](#)

## Wireless Network Connection is Unstable on a Mac

If you connected a device to a USB 3.0 port on your Mac, you may experience wireless network interference between your product and your Mac.

If you cannot connect to your product over the wireless network or the connection becomes unstable, move the device connected to your Mac USB 3.0 port further away from your Mac.

**Parent topic:** [Solving Network Problems](#)



## Cannot Print Over a Network

If you cannot print over a network, try these solutions:

- Make sure that your product is turned on.
- Make sure you install your product's network software as described in your product documentation.
- Print a network status sheet and verify that the network settings are correct. If the network status is **Disconnected**, check any cable connections and turn your product off and then on again.
- Print a network connection report and check the codes and messages on the report to help determine the cause of the problem.
- If you are using TCP/IP, make sure the product's IP address is set correctly for your network. If your network does not assign IP addresses using DHCP, set the IP address manually.
- Make sure your computer and product are both using the same wireless network.
- If network printing is slow, print a network status sheet and check the signal strength. If it is poor, place your product closer to your router or access point. Avoid placing your product near a microwave oven, cordless phone, or large metal object, such as a filing cabinet.
- Try restarting your router following the instructions in your router documentation.

**Note:** If you are reading these instructions online, you will lose your Internet connection when you restart your router.

- Check to see if your wireless router or access point has an enabled Privacy Separator function that is preventing printing from a device over the network. See your router or access point documentation for instructions on disabling the Privacy Separator function.
- If you are connecting the product wirelessly via EpsonNet Setup and the Wi-Fi connection icon is not lit or does not appear on the product's LCD screen, make sure your product software was installed correctly. If necessary, reinstall your software.

**Parent topic:** [Solving Network Problems](#)

### Related concepts

[Uninstall Your Product Software](#)

### Related tasks

[Printing a Network Status Sheet](#)

[Printing a Network Connection Report](#)

### Related topics

[Wi-Fi or Wired Networking](#)

## Cannot Scan Over a Network

If you have problems scanning over a network, try these solutions:

- If you cannot scan from your product control panel, make sure you restarted your computer after installing the product software. Make sure the Event Manager program is not being blocked by your firewall or security software.
- If you are scanning a large original at a high resolution, a network communication error may occur. Try scanning again at a lower resolution.
- If network communication was interrupted while starting Epson Scan 2, exit Epson Scan 2, wait a few seconds, and restart it. If Epson Scan 2 cannot restart, turn off your product, turn it back on, and try restarting Epson Scan 2 again.
- Check the scanner setting and reset the connection if necessary using Epson Scan 2 Utility:

**Windows 10:** Click  and select **EPSON > Epson Scan 2 Utility**. Make sure your product is selected. If necessary, select the **Other** tab and click **Reset**.

**Windows 8.x:** Navigate to the **Apps** screen, select **EPSON**, and select **Epson Scan 2 Utility**. Make sure your product is selected. If necessary, select the **Other** tab and click **Reset**.

**Windows (other versions):** Click  or **Start > All Programs** or **Programs > EPSON > Epson Scan 2 > Epson Scan 2 Utility**. Make sure your product is selected. If necessary, select the **Other** tab and click **Reset**.

**Mac:** Open the **Applications** folder, click **Epson Software**, and click **Epson Scan 2 Utility**. Make sure your product is selected. If necessary, select the **Other** tab and click **Reset**.

- You may need to disable the firewall and any anti-virus software on your wireless router or access point.

**Parent topic:** [Solving Network Problems](#)

## Solving Copying Problems

Check these solutions if you have problems copying with your product.

[Product Makes Noise, But Nothing Copies](#)

[Product Makes Noise When It Sits for a While](#)

[Originals Do Not Feed From the Automatic Document Feeder](#)

**Parent topic:** [Solving Problems](#)

## Product Makes Noise, But Nothing Copies

If your product makes a noise, but nothing copies, try these solutions:

- Run a nozzle check to see if any of the print head nozzles are clogged. Then clean the print head, if necessary.
- If the nozzle check page does not print, but the product's power is on, make sure your product software is installed correctly.
- Make sure your product is level (not tilted).

**Parent topic:** [Solving Copying Problems](#)

### Related concepts

[Print Head Cleaning](#)

[Print Head Nozzle Check](#)

## Product Makes Noise When It Sits for a While

Your product is performing routine maintenance. This is normal.

**Parent topic:** [Solving Copying Problems](#)

## Originals Do Not Feed From the Automatic Document Feeder

If your originals do not feed when placed in the ADF, try these solutions:

- Make sure the **ADF** icon lights up on the Copy, Fax, or Scan screen on the LCD screen. If not, reload the originals.
- Make sure the size, weight, and number of your originals are supported by the ADF.
- Make sure the originals are loaded correctly.
- Make sure the document is not curled or creased.
- Try cleaning the inside of the ADF.

- Do not load originals above the arrow mark on the ADF edge guide.

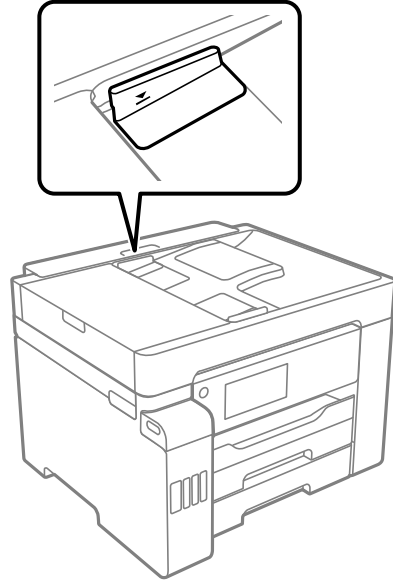

**Parent topic:** [Solving Copying Problems](#)

**Related references**

[Paper Feeding Problems](#)

[Paper Jams Inside the Product](#)

**Related tasks**

[Cleaning Your Product](#)

**Related topics**

[Placing Originals on the Product](#)

## Solving Paper Problems

Check these sections if you have problems using paper with your product.

[Paper Feeding Problems](#)

[Paper Jams Inside the Product](#)

[Paper Ejection Problems](#)

**Parent topic:** [Solving Problems](#)

## **Paper Feeding Problems**

If you have problems feeding paper, try these solutions:

- If paper does not feed for printing, remove it from the rear paper feeder or cassette. Reload it, then adjust the edge guides. Make sure the paper stack is not above the tab on the edge guides inside the cassette or rear paper feeder.
- Place the product on a flat surface and operate it in the recommended environmental conditions.
- Be sure to insert the paper cassette all the way into your product.
- If multiple pages feed at once, remove the paper, fan the edges to separate the sheets, and reload it.
- Do not load more than the recommended number of sheets. For plain paper, do not load paper above the arrow mark on the edge guides.
- Make sure your paper meets the specifications for your product.
- If paper jams when you print on both sides of the paper, try loading fewer sheets.
- Make sure the paper size and paper type settings are correct for the paper source.
- Run the paper guide cleaning utility to clean the paper path.
- For best results, follow these guidelines:
  - Use new, smooth, high-quality paper that is not curled, creased, old, too thin, or too thick.
  - Load paper in the cassette printable side down.
  - Follow any special loading instructions that came with the paper.

**Parent topic:** [Solving Paper Problems](#)

### **Related references**

[Paper Jams Inside the Product](#)

[Paper Loading Capacity](#)

[Paper Specifications](#)

### **Related tasks**

[Cleaning the Paper Guide](#)

### **Related topics**

[Loading Paper](#)

## Paper Jams Inside the Product

If you see a message that paper has jammed in the product, follow the on-screen instructions to locate and remove the jammed paper.

Take the following precautions when removing jammed paper from the product:

- Remove the jammed paper carefully. Using too much force may damage the product.
- Unless specifically instructed, avoid tilting the product, placing it on its side, or turning it upside down, as ink may spill.

**Warning:** Never touch the buttons on the control panel while your hand is inside the product. If the product starts operating, it may cause an injury. Do not touch any protruding parts inside the product.

**Parent topic:** [Solving Paper Problems](#)

**Related topics**

[Loading Paper](#)

## Paper Ejection Problems

If you have problems with paper ejecting properly, try these solutions:

- If paper does not eject fully, you may have set the wrong paper size. Cancel printing to eject the paper. Select the correct paper size when you reprint.
- If paper is wrinkled when it ejects, it may be damp or too thin. Load new paper and be sure to select the correct paper type setting when you reprint.

**Parent topic:** [Solving Paper Problems](#)

**Related references**

[Paper or Media Type Settings - Printing Software](#)

**Related tasks**

[Cancelling Printing Using a Product Button](#)

**Related topics**

[Loading Paper](#)

## Solving Problems Printing from a Computer

Check these sections if you have problems while printing from your computer.

**Note:** When printing using AirPrint, the available print settings are different from those covered in this manual. See the Apple website for details.

[Nothing Prints](#)



[Product Icon Does Not Appear in Windows Taskbar](#)

[Printing is Slow](#)

**Parent topic:** [Solving Problems](#)

## Nothing Prints

If you have sent a print job and nothing prints, try these solutions:

- Make sure your product is turned on and connected to your computer.
- Make sure any interface cables are connected securely at both ends.
- If you connected your product to a USB hub, make sure it is a first-tier hub. If it still does not print, connect your product directly to your computer instead of the hub.
- Make sure the printer status is not offline or pending.
- Run a product check to see if a test page prints. If the test page prints, check to see if your product software is installed correctly.
- Make sure you set the transportation lock to the unlocked (printing) position.
- Make sure your system meets the requirements for your operating system. If you are printing a high-resolution image, you may need more than the minimum requirements. Print the image at a lower resolution or if necessary, increase your system's memory.
- In Windows, make sure your product is selected as the default printer and the printer port setting matches the printer connection port.
- In Windows, delete all jobs from the Windows Spooler. Click **Print Queue** on the Maintenance tab in the printer settings window, and cancel any stalled print jobs.
- In Windows, do one of the following to open the Epson Printer Connection Checker and follow the on-screen instructions to check the connection status:
  - **Windows 10:** Click  and select **Epson Software > Epson Printer Connection Checker**.
  - **Windows 8.x:** Navigate to the **Apps** screen and select the **Epson Printer Connection Checker** icon.
  - **Windows 7:** Click  and select **All Programs > Epson Software > Epson Printer Connection Checker**.

- On a Mac, make sure the printer is added to the printer list and the printer is not paused.
- If you are using the PostScript printing software, make sure the printing language setting on the control panel is set to **Auto** or **PS** (ST-C8090).
- Make sure your product is selected as the printer in your printing program.

**Parent topic:** [Solving Problems Printing from a Computer](#)

#### **Related tasks**

[Running a Product Check](#)





[Entering a User ID and Password for Printing](#)

[Using AirPrint](#)

## **Product Icon Does Not Appear in Windows Taskbar**

If you do not see your product icon in the Windows taskbar, first try restarting your computer. If that does not work, try this solution:

1. Do one of the following:

- **Windows 10:** Click  and select  (Settings) > **Devices** > **Printers & scanners**. Select your product name and select **Manage** > **Printing preferences**.
- **Windows 8.x:** Navigate to the **Apps** screen and select **Control Panel** > **Hardware and Sound** > **Devices and Printers**. Right-click your product name, select **Printing Preferences**, and select your product name again if necessary.
- **Windows 7:** Click  and select **Devices and Printers**. Right-click your product name, select **Printing Preferences**, and select your product name again if necessary.
- **Windows Vista:** Click , select **Control Panel**, and click **Printer** under **Hardware and Sound**. Right-click your product name, select **Printing Preferences**, and select your product name again if necessary.

2. Click the **Maintenance** tab.

3. Click the **Extended Settings** button.

4. Select **Enable EPSON Status Monitor 3** and click **OK**.

5. Click the **Monitoring Preferences** button.

6. Click the checkbox for the option that adds the shortcut icon to the taskbar.

7. Click **OK** to close the open program windows.

**Parent topic:** [Solving Problems Printing from a Computer](#)



## Printing is Slow

If printing becomes slow, try these solutions:

- Make sure your system meets the requirements for your operating system. If you are printing a high-resolution image, you may need more than the minimum requirements. If necessary, increase your system's memory.
- If you are using Windows 7, close the **Devices and Printers** window before you print.
- On a Mac, make sure you download and install the Epson printer driver.
- Make sure **Quiet Mode** is turned off.
- Clear space on your hard drive or run a defragmentation utility to free up existing space.
- Close any programs you are not using when you print.
- If your product is connected to a USB hub, connect it directly to your computer instead.
- If printing becomes slower after printing continuously for a long time, the product may have automatically slowed down to protect the print mechanism from overheating or becoming damaged. Let the product rest with the power on for 30 minutes, then try printing again.
- If you are printing over a wireless network, factors such as interference, network traffic, or weak signal strength may affect your printing speed.

For the fastest printing, select the following settings in your product software:

- Make sure the paper type setting matches the type of paper you loaded.
- Turn on any high speed settings in your product software.
- Select a lower print quality setting.
- Make sure the ink drying time has not been increased for double-sided printing.
- **Windows:** Click the **Maintenance** or **Utility** tab, select **Extended Settings** or **Speed and Progress**, and select the following settings:
  - **Always Spool RAW Datatype**
  - **Page Rendering Mode**
  - **Print as Bitmap**
- **Mac:** Select **System Preferences**, select **Printers & Scanners**, and select your product. Select **Options & Supplies**, select **Options** (or **Driver**), and enable the **Bidirectional printing** setting.

If printing is still slow and you are using Windows 7 or Windows Vista, try the following:

1. Click  and select **Computer** or **My Computer**. Double-click the **C:** drive and open these folders: **ProgramData > EPSON > PRINTER**.

**Note:** If you do not see the ProgramData folder, open the **Organize** menu and select **Folder and search options**. In the window that appears, click the **View** tab, select **Show hidden files, folders, and drives** in the Advanced settings list, and click **OK**.

2. Right-click the **EPAUDF01.AUD** file and select **Delete**.
3. Restart your computer and try printing again.

**Parent topic:** [Solving Problems Printing from a Computer](#)

#### **Related references**

[Paper or Media Type Settings - Printing Software](#)

[Windows System Requirements](#)

[Mac System Requirements](#)

#### **Related tasks**

[Selecting Basic Print Settings - Windows](#)

[Selecting Extended Settings - Windows](#)

[Selecting Basic Print Settings - Mac](#)

## **Solving Page Layout and Content Problems**

Check these sections if you have problems with the layout or content of your printed pages.

**Note:** When printing using AirPrint, the available print settings are different from those covered in this manual. See the Apple website for details.

[Inverted Image](#)

[Too Many Copies Print](#)

[Blank Pages Print](#)

[Incorrect Margins on Printout](#)

[Incorrect Characters Print](#)

[Incorrect Image Size or Position](#)

[Slanted Printout](#)

**Parent topic:** [Solving Problems](#)

## Inverted Image

If your printed image is inverted unexpectedly, try these solutions:

- Turn off any mirror or inversion settings in your printing application.
- Turn off the **Mirror Image**, **Flip horizontally**, or **Reverse page orientation** settings in your printer software. (This option has different names, depending on your operating system version.)

**Parent topic:** [Solving Page Layout and Content Problems](#)

### Related tasks

[Selecting Basic Print Settings - Windows](#)

[Selecting Basic Print Settings - Mac](#)

## Too Many Copies Print

Make sure that the **Copies** setting in your printing program or printer software is not set for multiple copies.

**Parent topic:** [Solving Page Layout and Content Problems](#)

### Related tasks

[Selecting Basic Print Settings - Windows](#)

[Selecting Basic Print Settings - Mac](#)

## Blank Pages Print

If blank pages print unexpectedly, try these solutions:

- Make sure you selected the correct paper size settings in your printing program and printer software.
- If a blank page exists in a document you are printing and you want to skip printing it, select the **Skip Blank Page** setting in your printer software, if available.
- Run a print head nozzle check to see if any of the nozzles are clogged. Then clean the print head, if necessary.
- Make sure your product is selected as the printer in your printing program.
- You may need to refill the ink. Visually check the ink levels.

**Parent topic:** [Solving Page Layout and Content Problems](#)

### Related tasks

[Selecting Basic Print Settings - Windows](#)

[Selecting Extended Settings - Windows](#)

[Selecting Basic Print Settings - Mac](#)

[Selecting Printing Preferences - Mac](#)

## Incorrect Margins on Printout

If your printed page has incorrect margins, try these solutions:

- Make sure you selected the correct paper size settings in your printing program and printer software.
- Make sure you selected the correct margins for your paper size in your printing program.
- Make sure your paper is positioned correctly for feeding into the product.
- When placing originals on the scanner glass, align the corner of the original with the corner indicated by the arrow. If the edges of the copy are cropped, move the original slightly away from the corner.
- Clean the scanner glass and the document cover. If there is dust or stains on the glass, the copy area may extend to include the dust or stains.
- Load paper in the correct direction and slide the edge guides against the edges of the paper.
- Select the appropriate original size in the copy settings.

You can use the preview option in your printer software to check your margins before you print.

**Parent topic:** [Solving Page Layout and Content Problems](#)

### Related tasks

[Selecting Basic Print Settings - Windows](#)

[Selecting Basic Print Settings - Mac](#)

### Related topics

[Loading Paper](#)

## Incorrect Characters Print

If incorrect characters appear in your prints, try these solutions before reprinting:

- Make sure any cables are securely connected at both ends.
- In Windows, delete all jobs from the Windows Spooler. Click **Print Queue** on the Maintenance tab in the printer settings window, and cancel any stalled print jobs.
- If your product is connected to a USB hub, connect it directly to your computer instead.
- If incorrect characters still appear in your prints, try connecting your product using a different cable.

- If your computer entered sleep mode the last time you printed, the next print job after your computer exits sleep mode may contain garbled characters. Print your document again.
- If you are using the PostScript printer software, EPS files created in binary format may not print correctly. Try creating the file in ASCII format instead (ST-C8090).
- If you are using the Windows PostScript printer software, the product cannot print binary data if it is connected to the computer using a USB cable. Try selecting **ASCII** or **TBCP** as the **Output Protocol** setting on the Device Settings tab in the printer properties (ST-C8090).
- If you are using the Windows PostScript printer software, select the appropriate substitution fonts on the Device Settings tab in the printer properties (ST-C8090).

**Parent topic:** [Solving Page Layout and Content Problems](#)

## **Incorrect Image Size or Position**

If your printed image is the wrong size or in the wrong position, try these solutions:

- Make sure you selected the correct paper size and layout settings in your printing program and printer software.
- Make sure you selected the correct paper size on the control panel.
- Make sure your paper is positioned correctly for feeding into the printer.
- Slide the edge guides against the edges of the paper.
- Clean the scanner glass and document cover.
- If the edges of a copy are cropped, slightly move the original away from the edges of the scanner glass.
- Make sure you selected the correct margins for your paper size in your printing program.
- Be sure to select the appropriate original size setting for your original in the copy settings.

You can use the preview option in your printer software to check your margins before you print.

**Parent topic:** [Solving Page Layout and Content Problems](#)

### **Related tasks**

[Selecting Basic Print Settings - Windows](#)

[Selecting Additional Layout and Print Options - Windows](#)

[Selecting Basic Print Settings - Mac](#)

[Selecting Page Setup Settings - Mac](#)

## Slanted Printout

If your printouts are slanted, try these solutions:

- Make sure the paper is loaded in the correct direction.
- Do not load more than the recommended number of sheets.
- Slide the edge guides against the edges of the paper.
- Make sure the paper type setting matches the type of paper you loaded.
- Select a higher print quality setting in your printer software.
- Turn off any high speed settings in your product software.
- Adjust the print quality.
- Make sure the product is not printing while tilted or at an angle.

**Parent topic:** [Solving Page Layout and Content Problems](#)

### Related tasks

[Selecting Basic Print Settings - Windows](#)

[Selecting Basic Print Settings - Mac](#)

### Related topics

[Loading Paper](#)

## Solving Print Quality Problems

Check these sections if your printouts have problems with print quality, but your image looks fine on your computer screen.

**Note:** When printing using AirPrint, the available print settings are different from those covered in this manual. See the Apple website for details.

[White or Dark Lines in Printout](#)

[Blurry or Smearred Printout](#)

[Faint Printout or Printout Has Gaps](#)

[Grainy Printout](#)

[Incorrect Colors](#)

**Parent topic:** [Solving Problems](#)

## White or Dark Lines in Printout

If you notice white or dark lines in your prints (also called banding), try these solutions before you reprint:

- Run a nozzle check to see if any of the print head nozzles are clogged. Then clean the print head, if necessary.
- Make sure the paper type setting matches the type of paper you loaded.
- Make sure you loaded the printable side of the paper correctly for your product.
- Turn off any high speed settings in your product software.
- Adjust the print quality in the product software.
- If you continue to see horizontal or vertical bands or streaks in your printouts after cleaning and aligning the print head, you can finely tune the horizontal or vertical alignment in the Maintenance menu.
- You may need to refill the ink. Visually check the ink levels.
- If you have not used the product for a long time, run the Power Cleaning utility.

**Note:** Power Cleaning consumes a lot of ink, so run this utility only if you cannot improve print quality by cleaning the print head.

**Parent topic:** [Solving Print Quality Problems](#)

### Related concepts

[Print Head Nozzle Check](#)

[Print Head Cleaning](#)

[Print Quality Adjustment](#)

### Related references

[Paper or Media Type Settings - Printing Software](#)

### Related tasks

[Selecting Additional Layout and Print Options - Windows](#)

[Selecting Printing Preferences - Mac](#)

[Refilling the Ink Tanks](#)

### Related topics

[Loading Paper](#)

## Blurry or Smearred Printout

If your printouts are blurry or smeared, try these solutions:

- Make sure your paper is not damp, curled, old, or loaded incorrectly in your product.
- Use a support sheet with special paper, or load special paper one sheet at a time.
- Make sure your paper meets the specifications for your product.
- Use Epson papers to ensure proper saturation and absorption of genuine Epson inks.
- Make sure the paper type setting in your product software matches the type of paper you loaded.
- Make sure you loaded the printable side of the paper correctly for your product.
- If you are printing on thick paper or envelopes, make sure you select the appropriate settings.
- When manually printing 2-sided, make sure the ink is completely dry before loading the paper.
- Remove each sheet from the output tray as it is printed.
- Avoid handling printouts on glossy paper right after printing to allow the ink to set.
- Do not stack printouts immediately after printing.
- Turn off any high speed settings in your product software.
- If you print on both sides of a sheet of paper, smudges may appear on the reverse side of heavily saturated or dark images. If one side of a sheet will contain a lighter image or text, print that side first. Make sure the ink has dried before reloading the paper to print on the other side. Adjust the density and/or ink drying time settings.
- Lower the copy density setting on the product control panel.
- The ink levels may be low and you may need to refill the ink. Visually check the ink levels.
- Run a nozzle check to see if any of the print head nozzles are clogged. Then clean the print head, if necessary.
- Adjust the print quality in the product software.
- Clean the paper path.
- Do not press too hard on the original or the document cover when you are scanning originals on the scanner glass.
- Clean the scanner glass.
- Clean the ADF.
- Use the ink before the date printed on the package.



- If you printed when the ink levels were too low to be seen in the ink tank windows, refill the ink tanks to the upper lines and run the Power Cleaning utility. Then run a nozzle check to see if print quality has improved.
- If you have not used the product for a long time, run the Power Cleaning utility.

**Note:** Power Cleaning consumes a lot of ink, so run this utility only if you cannot improve print quality by cleaning the print head.

**Note:** Your product will not operate properly while tilted at an angle. Place it on a flat, stable surface that extends beyond the base of the product in all directions.

**Parent topic:** [Solving Print Quality Problems](#)

**Related concepts**

[Print Head Cleaning](#)

[Print Quality Adjustment](#)

**Related references**

[Compatible Epson Papers](#)

[Paper Specifications](#)

**Related tasks**

[Cleaning the Paper Guide](#)

[Selecting Basic Print Settings - Windows](#)

[Selecting Double-sided Printing Settings - Windows](#)

## Faint Printout or Printout Has Gaps

If your printouts are faint or have gaps, try these solutions:

- Run a nozzle check to see if any of the print head nozzles are clogged. Then clean the print head, if necessary.
- The ink levels may be low. Visually check the ink levels.
- Make sure the paper type setting matches the type of paper you loaded.
- Make sure your paper is not damp, curled, old, or loaded incorrectly in your product.
- Adjust the print quality in the product software.
- Clean the paper path.
- If you have not used the product for a long time, run the Power Cleaning utility.

**Note:** Power Cleaning consumes a lot of ink, so run this utility only if you cannot improve print quality by cleaning the print head.

**Parent topic:** [Solving Print Quality Problems](#)

**Related concepts**

[Print Head Nozzle Check](#)

[Print Head Cleaning](#)

[Print Quality Adjustment](#)

**Related references**

[Paper or Media Type Settings - Printing Software](#)

**Related tasks**

[Cleaning the Paper Guide](#)

[Selecting Basic Print Settings - Windows](#)

[Selecting Basic Print Settings - Mac](#)

**Related topics**

[Loading Paper](#)

## Grainy Printout

If your printouts are grainy, try these solutions:

- Make sure you loaded the printable side of the paper correctly for your product.
- Select a higher print quality setting and turn off any high speed settings in your product software.
- Run a nozzle check to see if any of the print head nozzles are clogged. Then clean the print head, if necessary.
- Adjust the print quality in the product software.
- You may need to increase the image resolution or print a smaller size; see your software documentation.

**Note:** Images from the Internet may be low resolution and not result in a high quality printout.

- If you enlarged the image size in an image-editing program, you need to increase the image resolution setting to retain a high image quality. Increase the image resolution by the same amount you increase the image size. For example, if the image resolution is 300 dpi (dots per inch) and you will double the image size for printing, change the resolution setting to 600 dpi.

**Note:** Higher resolution settings result in larger file sizes, which take longer to process and print. Consider the limitations of your computer system when selecting a resolution, and select the lowest possible resolution that produces acceptable quality to keep file sizes manageable.

**Parent topic:** [Solving Print Quality Problems](#)

**Related concepts**

[Print Head Nozzle Check](#)

[Print Head Cleaning](#)

[Print Quality Adjustment](#)

**Related tasks**

[Selecting Basic Print Settings - Windows](#)

[Selecting Additional Layout and Print Options - Windows](#)

[Selecting Basic Print Settings - Mac](#)

[Selecting Printing Preferences - Mac](#)

## Incorrect Colors

If your printouts have incorrect colors, try these solutions:

- Make sure the paper type setting matches the paper you loaded.
- Make sure the **Black/Grayscale** or **Grayscale** setting is not selected in your printer software.
- If you selected **Standard-Vivid** (Windows) or **Normal-Vivid** (Mac) as the quality setting in the printer software, try selecting **Standard** (Windows) or **Normal** (Mac) instead.
- Run a nozzle check to see if any of the print head nozzles are clogged. Then clean the print head, if necessary.
- The ink levels may be low and you may need to refill the ink. Visually check the ink levels.
- If you printed when the ink levels were too low to be seen in the ink tank windows, refill the ink tanks to the upper lines and run the Power Cleaning utility. Then run a nozzle check to see if print quality has improved.
- After you print, the colors in your printout need time to set as the ink dries. During this time, the colors may look different than you expect. To speed up drying time, do not stack your printouts on top of each other.
- Your printed colors can never exactly match your on-screen colors. However, you can use a color management system to get as close as possible. Try using the color management options in your printer software.

- If using the PostScript printer driver, try adjusting the **Color Mode** setting on the Advanced tab of the printer software (ST-C8090).
- If you are using the PostScript printer driver and the file you are printing was created in an application that allows you to change the data format, make sure the settings in the application match the settings in the printer driver (ST-C8090).
- For best results, use genuine Epson paper.
- If you have not used the product for a long time, run the Power Cleaning utility.

**Note:** Power Cleaning consumes a lot of ink, so run this utility only if you cannot improve print quality by cleaning the print head.

**Parent topic:** [Solving Print Quality Problems](#)

**Related concepts**

[Print Head Nozzle Check](#)

[Print Head Cleaning](#)

**Related references**

[Compatible Epson Papers](#)

**Related tasks**

[Selecting Basic Print Settings - Windows](#)

[Selecting Additional Layout and Print Options - Windows](#)

[Refilling the Ink Tanks](#)

## Solving Scanning Problems

Check these solutions if you have problems scanning with your product.

**Note:** For solutions when using the Epson ScanSmart software, see the Epson ScanSmart help utility.

[Scanning Software Does Not Operate Correctly](#)

[Cannot Start Epson Scan 2](#)

[Scanning is Slow](#)

[Cannot Save a Scan to a Shared Folder Over a Network](#)

**Parent topic:** [Solving Problems](#)

## Scanning Software Does Not Operate Correctly

If your scanning software does not operate correctly, try these solutions:

- Make sure your computer has adequate memory and meets the system requirements for your operating system.
- Make sure your computer is not running in a power-saving mode, such as sleep or standby. If so, wake your system and restart your scanning software.
- If you upgraded your operating system but did not reinstall your scanning software, try reinstalling it.
- In Windows, make sure your product is listed as a valid device in the **Scanners and Cameras** control panel.
- If you are scanning with the ADF, make sure the ADF and document covers are closed.
- Try scanning at a lower resolution or increase the free space on the computer's hard disk. Scanning stops if the total data size reaches the limit.

**Parent topic:** [Solving Scanning Problems](#)

### **Related concepts**

[Uninstall Your Product Software](#)

### **Related references**

[Windows System Requirements](#)

[Mac System Requirements](#)

## Cannot Start Epson Scan 2

If you cannot start Epson Scan 2, try these solutions:

- Make sure your product is turned on and any interface cables are securely connected at both ends.
- If your product is connected to a USB hub, connect it directly to your computer instead.
- If you scan at a high resolution over a network, a communication error may occur. Lower the resolution.
- If you are scanning with the ADF, check that the document cover and ADF cover are closed.
- Make sure Epson Scan 2 is selected as your scanning program.
- Make sure your computer is not running in a power-saving mode, such as sleep or standby. If so, wake your system and restart Epson Scan 2.
- Check the connection setting and test the connection using Epson Scan 2 Utility:

**Windows 10:** Click  and select **EPSON > Epson Scan 2 Utility**. Make sure the correct product is selected. If necessary, select the **Other** tab and click **Reset**.

**Windows 8.x:** Navigate to the **Apps** screen and select **Epson Scan 2 Utility**. Make sure the correct product is selected. If necessary, select the **Other** tab and click **Reset**.

**Windows (other versions):** Click  or **Start > All Programs** or **Programs > EPSON > Epson Scan 2 > Epson Scan 2 Utility**. Make sure the correct product is selected. If necessary, select the **Other** tab and click **Reset**.

**Mac:** Open the **Applications** folder, click **Epson Software**, and click **Epson Scan 2 Utility**. Make sure the correct product is selected. If necessary, select the **Other** tab and click **Reset**.

- Make sure you do not have multiple versions of Epson Scan 2 installed. If you do, uninstall both versions and install one version.
- If you upgraded your operating system but did not reinstall Epson Scan 2, try reinstalling it.
- If the user restriction feature (Access Control) is enabled, a user ID and password are required to scan. If you do not know the user ID or password, contact your administrator for assistance.

**Parent topic:** [Solving Scanning Problems](#)

#### **Related tasks**

[Starting a Scan Using the Epson Scan 2 Icon](#)

## **Scanning is Slow**

If scanning becomes slow, try these solutions:

- Scan your original at a lower resolution, if possible.
- Make sure your system meets the requirements for your operating system. If you are scanning a high-resolution image, you may need more than the minimum requirements. If necessary, increase your system's memory or reduce the resolution.

**Parent topic:** [Solving Scanning Problems](#)

#### **Related tasks**

[Entering a User ID and Password for Scanning](#)

#### **Related topics**

[Starting a Scan](#)

## Cannot Save a Scan to a Shared Folder Over a Network

If you cannot save a scan to a shared folder when scanning over a network, or saving takes a very long time, try these solutions:

- If you cannot scan to a shared folder over the network, make sure you did the following:
  - Created a shared folder on your computer (Windows).
  - If you registered the shared folder path to your product's control panel contact list or entered the path manually to scan, make sure you used the correct path.
  - Make sure the network folder does not already contain a file of the same name. If so, rename the file and try again.
- If you still cannot scan to the shared folder, your network type may be set to **Public**. You cannot scan to a shared folder when using a public network. Follow the steps here to check and change your network type, if necessary. Be sure to log into your Windows computer as an administrator.

**Note:** The name of available network types varies in the different Windows versions. For details on selecting Windows network sharing settings, see Windows help.

### Windows 10:

1. Click  and select **Settings**.
2. Select **Network & Internet**.
3. Click your network type: **Ethernet** or **Wi-Fi**.
4. Click your network name.
5. Make sure the **Make this PC discoverable** setting is set to **On**. Select this setting when connected to a private network so you can save a scan to a shared folder. If you select **Off**, you cannot save your scan to a shared folder on a private network.

### Windows 8.1:

1. At the Start screen, type **PC Settings** to automatically search the system.
2. Click **Network** in the PC Settings window.
3. Click your network name.
4. Make sure **Find devices and content** is set to **On**. Select this setting when connected to a private network so you can save a scan to a shared folder. If you select **Off**, you cannot save your scan to a shared folder on a private network.

### Windows 8.0:

1. At the Start screen, type **Settings** to automatically search the system.
2. Select **Settings** when it appears and type **Network** into the search field.
3. Right-click your network name in the window that appears and click **Turn sharing on or off**.
4. When you see this message, select **Yes**:

#### **Do you want to turn on sharing between the PCs and connect to devices on this network?**

Select this setting when connected to a private network so you can save a scan to a shared folder. If you select **No**, you cannot save your scan to a shared folder on a private network.

### Windows 7:

1. Click  or press the Windows key on your keyboard.
  2. Type **Network and Sharing Center** into the search field.
  3. Under View your active networks, make sure **Home network** or **Work network** is selected when connected to a private network so you can save a scan to a shared folder. (If you need to change the network type, click the network type name.) If you select **Public network**, you cannot save a scan to a shared folder.
- If saving your scan to a shared folder takes a very long time, make sure the DNS setting and the DNS domain name are correct. Contact your network administrator for instructions.

Parent topic: [Solving Scanning Problems](#)

## Solving Scanned Image Quality Problems

Check these sections if a scanned image on your computer screen has a quality problem.

**Note:** For solutions when using the Epson ScanSmart software, see the Epson ScanSmart help utility.

[Image Consists of a Few Dots Only](#)

[Line of Dots Appears in All Scanned Images](#)

[Straight Lines in an Image Appear Crooked](#)

[Scanned Image Quality Problems](#)

[Image Colors are Patchy at the Edges](#)

[Ripple Patterns Appear in an Image](#)

[Scanned Image Edges are Cropped](#)

Parent topic: [Solving Problems](#)



## Image Consists of a Few Dots Only

If your scanned image consists only of a few dots, try these solutions:

- Make sure you placed your original for scanning facing the correct way.
- If the **Image Type** setting is **Black & White**, adjust the **Threshold** and scan again. (The **Image Option** must be set to **None** or **Color Enhance**.)
- Remove any lint or dirt from your original.
- Do not press on the original or the document cover with too much force.

**Parent topic:** [Solving Scanned Image Quality Problems](#)

### Related references

[Additional Scanning Settings - Advanced Settings Tab](#)

### Related topics

[Placing Originals on the Product](#)

## Line of Dots Appears in All Scanned Images

If a line of dots appears in all your scanned images, try these solutions:

- Clean the scanner glass with a soft, dry, lint-free cloth or use a small amount of glass cleaner on the cloth, if necessary. Paper towels are not recommended.

**Caution:** Do not spray glass cleaner directly on the scanner glass.

- Make sure any interface cables are securely connected at both ends.

If you are scanning from the ADF, make sure the ADF edge guides fit against the loaded originals. You can also try cleaning the ADF and scanning again.

**Parent topic:** [Solving Scanned Image Quality Problems](#)

### Related tasks

[Cleaning Your Product](#)

## Straight Lines in an Image Appear Crooked

If straight lines in an original appear crooked in a scanned image, make sure to place your original straight when you scan it.

Clean the scanner glass with a soft, dry, lint-free cloth or use a small amount of glass cleaner on the cloth, if necessary. Paper towels are not recommended.

If you are scanning from the ADF, make sure the ADF edge guides fit against the loaded originals. You can also try cleaning the ADF and scanning again.

**Parent topic:** [Solving Scanned Image Quality Problems](#)

**Related tasks**

[Cleaning Your Product](#)

**Related topics**

[Placing Originals on the Product](#)

## Scanned Image Quality Problems

If you encounter quality problems with your scanned image, try these solutions:

### Image is Distorted or Blurry

- Do not move your original or your product during scanning.
- Your product will not operate properly while tilted at an angle. Place your product on a flat, stable surface that extends beyond its base in all directions.
- Adjust these Epson Scan 2 settings (if available) and try scanning again:
  - Increase the **Resolution** setting.
  - If the **Image Type** setting is **Black & White**, adjust the **Threshold** setting.
  - If the **Image Type** setting is **Color** or **Grayscale**, select the **Unsharp Mask** setting.
  - If the **Image Type** setting is **Black & White**, select **Text Enhancement**. If the **Image Type** setting is **Color** or **Grayscale**, change the **Text Enhancement** setting to **High**.

### Image is Too Dark

- If the **Image Type** is set to **Color** or **Grayscale**, adjust the **Brightness** setting.
- Check the brightness and contrast settings of your computer monitor.

### Back of Original Image Appears in Scanned Image

- Place a piece of black paper on the back of the original and scan it again.
- Adjust these Epson Scan 2 settings (if available) and try scanning again:
  - Select the **Advanced Settings** tab and adjust the **Brightness** setting.

### **Scanned Image Colors Do Not Match Original Colors**

Printed colors can never exactly match the colors on your computer monitor because printers and monitors use different color systems: monitors use RGB (red, green, and blue) and printers typically use CMYK (cyan, magenta, yellow, and black).

Check the color matching and color management capabilities of your computer, display adapter, and the software you are using to see if they are affecting the palette of colors you see on your screen.

To adjust the colors in your scanned image, adjust these Epson Scan 2 settings (if available) and try scanning again:

- If the **Image Type** setting is **Color** or **Grayscale**, adjust the **Contrast** setting.
- If the **Image Type** setting is **Black & White** or **Grayscale**, adjust the **Color Enhance** setting.

**Parent topic:** [Solving Scanned Image Quality Problems](#)

#### **Related references**

[Additional Scanning Settings - Advanced Settings Tab](#)

### **Image Colors are Patchy at the Edges**

If you are scanning a thick or warped original, cover its edges with paper to block external light as you scan it.

**Parent topic:** [Solving Scanned Image Quality Problems](#)

### **Ripple Patterns Appear in an Image**

You may see a ripple pattern (called a moiré) in scanned images of printed documents. This is caused by interference from differing pitches in the scanner's screen and your original's halftone screen. To reduce this effect, adjust these Epson Scan 2 settings (if available) and try scanning again:

- Select the **Descreening** setting.
- Select a lower **Resolution** setting.

**Parent topic:** [Solving Scanned Image Quality Problems](#)

#### **Related references**

[Additional Scanning Settings - Advanced Settings Tab](#)

### **Scanned Image Edges are Cropped**

If the edges of a scanned image are cropped, make sure your original is placed correctly for scanning. If necessary, move your original away from the edges of the scanner glass slightly.

In the Epson Scan 2 or Epson ScanSmart settings, set the **Edge Fill** setting to **None**.

**Parent topic:** [Solving Scanned Image Quality Problems](#)

**Related topics**

[Placing Originals on the Product](#)

## Solving Faxing Problems

Check these solutions if you have problems faxing with your product.

[Cannot Send or Receive Faxes](#)

[Cannot Receive Faxes with a Telephone Connected to Your Product](#)

[Fax Memory Full Error Appears](#)

[Sent Fax is Received in an Incorrect Size](#)

[Received Fax is Not Printed](#)

**Parent topic:** [Solving Problems](#)

## Cannot Send or Receive Faxes

If you cannot send or receive faxes, try these solutions:

- Use **Check Fax Connection** on the control panel (**Settings** > **General Settings** > **Fax Settings** > **Check Fax Connection**) to run the automatic fax connection check. Try the solutions suggested in the report.
- If you are faxing from a computer, use the Epson FAX Utility to send your fax.
- Make sure the recipient's fax machine is turned on and working.
- Make sure paper is loaded correctly in your product.
- Make sure you have set up your header information and have not blocked your caller ID. Otherwise, your faxes might be rejected by the recipient's fax machine.
- If user restriction has been enabled, you may need to enter a user name and password. Contact your administrator for assistance.
- If you did not connect a telephone to your product, set the Receive Mode setting to **Auto** so you can receive faxes automatically.
- Check that the cable connecting your telephone wall jack to your product's **LINE** port is secure.
- Print a fax connection report using your product control panel or fax software to help diagnose the problem.
- Verify that the telephone wall jack works by connecting a phone to it and testing it.

- If there is no dial tone and you connected the product to a PBX (Private Branch Exchange) phone line or Terminal Adapter, change the **Line Type** setting to **PBX**. If you still cannot send a fax, turn off the product's dial tone detection setting. (Turning off the dial tone setting may cause the product to drop the first digit of a fax number.)
- If you connected your product to a DSL phone line, you must connect a DSL filter to the phone jack to enable faxing over the line. Contact your DSL provider for the necessary filter.
- If you are connected to a DSL phone line, connect the product directly to a telephone wall jack and send a fax. If it works, the problem may be caused by the DSL filter. Contact your DSL provider.
- If your telephone line has static, turn off your product's error correction mode fax communication setting and try faxing again.
- Try lowering your product's fax speed setting.
- If a communication error occurs, change the **Fax Speed** setting to **Slow(9,600bps)** on the control panel.
- Make sure the error correction mode (ECM) setting is turned on if you are trying to send or receive a color fax.
- If your telephone line uses call waiting and you have trouble receiving faxes, turn off call waiting to prevent disruption of incoming faxes.
- If you have subscribed to a call forwarding service, the product may not be able to receive faxes. Contact your service provider for assistance.
- If the recipient fax machine does not answer your call within 50 seconds after the product has finished dialing, add pauses after the fax number to send the fax.
- Check your inbox and delete faxes after reading or printing them. If the inbox is full, the product cannot receive faxes.
- When sending faxes using the subaddress feature, ask the recipient if their fax machine can receive faxes using this feature. Check that the subaddress and password are correct, and that they match with the recipient subaddress and password. Check this when receiving faxes as well.
- Check if the sender's fax number is registered to the **Rejection Number List**
- If you enabled **Rejection Fax** options, check if the sender is blocked, did not set up header information, or is not registered in your contacts list, as necessary.
- If you have not connected a telephone to the printer, set the **Receive Mode** setting to **Auto** on the control panel.
- If you are receiving faxes using the Epson FAX Utility, check that your product is registered as a fax product in your operating system:

**Windows:** Make sure the product appears in **Devices and Printers**, **Printer**, or **Printers and Other Hardware**. If the product does not appear, uninstall and re-install the Epson FAX Utility.

**Mac:** Select **System Preferences > Printers & Scanners** (or **Print & Scan** or **Print & Fax**) and make sure your product appears. If your product does not appear, click **+** and add your product. If the product does appear, double-click it and make sure it is not paused.

**Note:** Do not turn the product off while it is receiving a fax. Otherwise, the fax transmission will be lost.

**Note:** If your product is connected to a VoIP (Voice over Internet Protocol) phone line, keep in mind that fax machines are designed to work over analog phone lines. Epson cannot guarantee that fax transmission will work when using VoIP.

If your phone line includes voice mail answering services, calls or faxes may be inadvertently received by your voice mail service.

**Parent topic:** [Solving Faxing Problems](#)

**Related tasks**

[Connecting a Telephone or Answering Machine](#)

[Using the Fax Setup Wizard](#)

[Selecting the Line Type](#)

[Selecting Advanced Fax Settings](#)

[Receiving Faxes Automatically](#)

[Printing Fax Reports](#)

**Related topics**

[Loading Paper](#)

## Cannot Receive Faxes with a Telephone Connected to Your Product

If you cannot receive faxes when a telephone is connected to your product, try these solutions:

- Make sure your telephone is connected to your product's **EXT** port.
- Make sure the Receive Mode is set to **Manual**.

**Note:** When answering a call that is a fax, wait until the product's LCD screen displays a message that a connection has been made before you hang up.

**Parent topic:** [Solving Faxing Problems](#)

## Related tasks

- [Connecting a Telephone or Answering Machine](#)
- [Using the Fax Setup Wizard](#)

## Fax Memory Full Error Appears

If you see an error message telling you that the product's fax memory is full, try these solutions:

- If you set the product to save received faxes in the product's memory or inbox, delete any faxes you have already read.

**Note:** Your product can store up to 100 faxes before its inbox is full.

- If you set the product to save received faxes on a computer, turn on the selected computer. Once the faxes are saved on the computer, they are deleted from the product's memory.
- If you set the product to save received faxes on a memory device, connect the selected memory device containing the save fax folder to the product. Once the faxes are saved on the memory device, they are deleted from the product's memory.

**Note:** Make sure the memory device has enough available memory and is not write protected.

- If the memory is full, try the following:
  - Send a monochrome fax using the direct sending feature
  - Send your faxes in smaller batches
- If the product cannot print a received fax due to a product error, such as a paper jam, the memory full error may appear. Clear any product errors, then ask the sender to resend the fax.

**Parent topic:** [Solving Faxing Problems](#)

## Sent Fax is Received in an Incorrect Size

If your recipient receives a fax in an incorrect size, try these solutions:

- If you are trying to fax an A3-size document, make sure the recipient's fax machine supports the paper size. If the message **OK (Reduced Size)** appears in the fax transmission report, the recipient's fax machine does not support A3-size documents.
- If you are sending a fax using the scanner glass, make sure your original is placed correctly and that the correct paper size is selected on the control panel.
- Clean the scanner glass and document cover.

**Parent topic:** [Solving Faxing Problems](#)

**Related tasks**

[Cleaning Your Product](#)

**Related topics**

[Placing Originals on the Product](#)

## Received Fax is Not Printed

If a received fax is not printed, try these solutions:

- Make sure the product is free of errors. The product cannot print received faxes if an error has occurred with the product, such as a paper jam.
- If the product has been set to save received faxes in the product's memory or inbox, received faxes are not automatically printed. Check the **Receive Settings** options on the product control panel and change them, if necessary.

**Parent topic:** [Solving Faxing Problems](#)

**Related references**

[Receive Settings - Fax](#)

## Solving USB Device Problems

Check these solutions if you have problems using USB devices with your product.

[Cannot View or Print from a USB Device](#)

[Cannot Save Files on a USB Device](#)

[Cannot Transfer Files To or From a USB Device](#)

**Parent topic:** [Solving Problems](#)

## Cannot View or Print from a USB Device

If you cannot view or print photos or documents from a USB device connected to your product, try these solutions:

- Make sure memory devices are enabled on the product.
- Make sure your device is compatible with the product.
- Make sure the files on your device are in the correct format.

**Parent topic:** [Solving USB Device Problems](#)



### **Related references**

[External USB Device Specifications](#)

[USB Device Photo File Specifications](#)

## **Cannot Save Files on a USB Device**

If you cannot save files on a USB device connected to your product, try these solutions:

- To save faxes on a USB device, create a folder using the unconditional save/forward settings on the product control panel.
- Make sure the device is not write-protected.
- Make sure the device has enough available space.
- Make sure memory devices are enabled on your product.
- Make sure the device is compatible with the product.

**Parent topic:** [Solving USB Device Problems](#)

### **Related references**

[External USB Device Specifications](#)

[USB Device Photo File Specifications](#)

## **Cannot Transfer Files To or From a USB Device**

If you have problems transferring files to or from a USB device connected to your product, try these solutions:

- Make sure your device is compatible with the product.
- Make sure your product is securely connected to your computer.
- Make sure that the file sharing setting for your product is enabled.

**Parent topic:** [Solving USB Device Problems](#)

### **Related references**

[External USB Device Specifications](#)

[USB Device Photo File Specifications](#)

## **Uninstall Your Product Software**

If you have a problem that requires you to uninstall and re-install your software, follow the instructions for your operating system.



[Uninstalling Product Software - Windows](#)

[Uninstalling Product Software - Mac](#)

Parent topic: [Solving Problems](#)

## Uninstalling Product Software - Windows

You can uninstall and then re-install your product software to solve certain problems.

1. Turn off the product.
2. Disconnect any interface cables.
3. Do one of the following:
  - **Windows 10:** Click  and select  (Settings) > **Apps** or **System** > **Apps & features**. Then select the program you want to uninstall and select **Uninstall**.
  - **Windows 8.x:** Navigate to the **Apps** screen and select **Control Panel** > **Programs** > **Programs and Features**. Select the uninstall option for your Epson product, then select **Uninstall/Change**.

**Note:** If you see a **User Account Control** window, click **Yes** or **Continue**.

Select your product again, if necessary, then select **OK**, and click **Yes** to confirm the uninstallation.

- **Windows (other versions):** Click  or **Start**, and select **All Programs** or **Programs**. Select **EPSON**, select your product, then click **EPSON Printer Software Uninstall**.

**Note:** If you see a **User Account Control** window, click **Yes** or **Continue**.

In the next window, select your product and click **OK**. Then follow any on-screen instructions.

4. Do one of the following to uninstall Epson Event Manager, then follow any on-screen instructions:
  - **Windows 10/8.x:** Select **Epson Event Manager** and click **Uninstall**.
  - **Windows 7/Windows Vista:** Open the Windows **Control Panel** utility. Select **Programs and Features**. (In Classic view, select **Programs** and click **Uninstall a program**.) Select **Epson Event Manager** and click **Uninstall/Change**.
5. Do one of the following to uninstall Epson Scan 2, then follow any on-screen instructions:
  - **Windows 10:** Select **Epson Scan 2** and click **Uninstall**.
  - **Windows 8.x/Windows 7/Windows Vista:** Select **Epson Scan 2** and click **Uninstall/Change**.

6. Do one of the following to uninstall Epson ScanSmart, then follow any on-screen instructions:
  - **Windows 10:** Select **Epson ScanSmart** and click **Uninstall**.
  - **Windows 8.x/Windows 7/Windows Vista:** Select **Epson ScanSmart** and click **Uninstall/Change**.
7. Restart your computer, then see the *Start Here* sheet to re-install your software.

**Note:** If you find that re-installing your product software does not solve a problem, contact Epson.

**Parent topic:** [Uninstall Your Product Software](#)

## Uninstalling Product Software - Mac

In most cases, you do not need to uninstall your product software before re-installing it. However, you can download the Uninstaller utility from the Epson support website to uninstall your product software as described here.

**Note:** If you find that re-installing your product software does not solve a problem, contact Epson.

1. To download the Uninstaller utility, visit [epson.com/support](http://epson.com/support) (U.S.), [epson.ca/support](http://epson.ca/support) (Canada), or [latin.epson.com/support](http://latin.epson.com/support) (Latin America) and select your product.
2. Click **Downloads**.
3. Select your operating system, click **Utilities**, locate the Uninstaller utility, and click **Download**.
4. Run the file you downloaded.
5. Double-click the **Uninstaller** icon.
6. In the Epson Uninstaller screen, select the checkbox for each software program you want to uninstall.
7. Click **Uninstall**.
8. Follow the on-screen instructions to uninstall the software.
9. Reinstall your product software.

**Note:** If you uninstall the printer driver and your product name remains in the **Print & Fax**, **Print & Scan**, or **Printers & Scanners** window, select your product name and click the – (remove) icon to remove it.

**Parent topic:** [Uninstall Your Product Software](#)

## Where to Get Help

If you need to contact Epson for technical support services, use the following support options.

### Internet Support

Visit Epson's support website at [epson.com/support](http://epson.com/support) (U.S.), [epson.ca/support](http://epson.ca/support) (Canada), or [latin.epson.com/support](http://latin.epson.com/support) (Latin America) and select your product for solutions to common problems. You can download drivers and documentation, get FAQs and troubleshooting advice, or e-mail Epson with your questions.

### Speak to a Support Representative

Before you call Epson for support, please have the following information ready:

- Product name
- Product serial number (located on a label on the product)
- Proof of purchase (such as a store receipt) and date of purchase
- Computer configuration
- Description of the problem

Then call:

- U.S.: (562) 276-4382, 6 AM to 8 PM, Pacific Time, Monday through Friday, and 7 AM to 4 PM, Pacific Time, Saturday
- Canada: (905) 709-3839, 6 AM to 8 PM, Pacific Time, Monday through Friday, and 7 AM to 4 PM, Pacific Time, Saturday

Days and hours of support are subject to change without notice. Toll or long distance charges may apply.

### Purchase Supplies and Accessories

You can purchase genuine Epson ink and paper at [epson.com](http://epson.com) (U.S. sales), [epson.ca](http://epson.ca) (Canadian sales), or [latin.epson.com](http://latin.epson.com) (Latin American sales). You can also purchase supplies from an Epson authorized reseller. To find the nearest one, call 800-GO-EPSON (800-463-7766) in the U.S. or 800-807-7766 in Canada.

**Parent topic:** [Solving Problems](#)

---

# Technical Specifications

These sections list the technical specifications for your product.

**Note:** Epson offers a recycling program for end of life Epson products. Please go to [this site](#) (U.S) or [this site](#) (Canada) for information on how to return your Epson products for proper disposal.

[Windows System Requirements](#)

[Mac System Requirements](#)

[Paper Specifications](#)

[Printable Area Specifications](#)

[Automatic Document Feeder \(ADF\) Specifications](#)

[Scanning Specifications](#)

[Fax Specifications](#)

[Ink Specifications](#)

[Dimension Specifications](#)

[Electrical Specifications](#)

[Environmental Specifications](#)

[Interface Specifications](#)

[External USB Device Specifications](#)

[Network Interface Specifications](#)

[Safety and Approvals Specifications](#)

## Windows System Requirements

To use your product and its software, your computer should use one of these Microsoft operating systems:

- Windows 10
- Windows 8.x
- Windows 7
- Windows Vista
- Windows Server 2019
- Windows Server 2016 R2

- Windows Server 2016
- Windows Server 2012 R2
- Windows Server 2012
- Windows Server 2008 R2
- Windows Server 2008
- Windows Server 2003 R2

Windows Server supports only the printer driver and Epson Scan 2; any additional included software is not supported.

**Note:** For the latest product software available for your operating system, visit the Epson support site at [epson.com/support](http://epson.com/support) (U.S.), [epson.ca/support](http://epson.ca/support) (Canada), or [latin.epson.com/support](http://latin.epson.com/support) (Latin America), select your product, and select **Downloads**.

**Parent topic:** [Technical Specifications](#)

## Mac System Requirements

To use your product and its software, your Mac should use one of these operating systems:

- macOS 11.x
- macOS 10.15.x
- macOS 10.14.x
- macOS 10.13.x
- macOS 10.12.x
- OS X 10.11.x
- OS X 10.10.x
- OS X 10.9.x
- OS X 10.8.x
- OS X 10.7.x
- OS X 10.6.8

**Note:** For the latest product software available for your operating system, visit the Epson support site at [epson.com/support](http://epson.com/support) (U.S.), [epson.ca/support](http://epson.ca/support) (Canada), or [latin.epson.com/support](http://latin.epson.com/support) (Latin America), select your product, and select **Downloads**.

Parent topic: [Technical Specifications](#)

## Paper Specifications

**Note:** Since the quality of any particular brand or type of paper may be changed by the manufacturer at any time, Epson cannot guarantee the quality of any non-Epson brand or type of paper. Always test a sample of paper stock before purchasing large quantities or printing large jobs.

### Single-sheets

<b>Size</b>	13 × 19 inches (330 × 483 mm)
	A3 (11.7 × 16.5 inches [297 × 420 mm])
	A4 (8.3 × 11.7 inches [210 × 297 mm])
	A5 (5.8 × 8.2 inches [148 × 210 mm])
	A6 (4.1 × 5.8 inches [105 × 148 mm])
	16:9 wide (4 × 7.1 inches [102 × 181 mm])
	Letter (8.5 × 11 inches [216 × 279 mm])
	Legal (8.5 × 14 inches [216 × 356 mm])
	8 × 10 inches (203 × 254 mm)
	8.5 × 13 inches (216 × 330 mm)
	11 × 17 inches (279 × 432 mm)
	Executive (7.25 × 10.5 inches [184 × 267 mm])
	Mexico-Oficio (8.5 × 13.4 inches [216 × 340 mm])
	Oficio 9 (8.46 × 12.4 inches [215 × 315 mm])
	Half Letter (5.5 × 8.5 inches [140 × 216 mm])

### Paper types

Plain paper and thick paper

**Note:** Your product also supports compatible papers distributed by Epson. See the link at the end of this topic for a list of compatible Epson papers.

**Weight**

Plain paper: 17 lb (64 g/m<sup>2</sup>) to 24 lb (90 g/m<sup>2</sup>)  
Thick paper: 25 lb (91 g/m<sup>2</sup>) to 68 lb (256 g/m<sup>2</sup>)

**Envelopes****Size**

No. 10 (4.1 × 9.5 inches [105 × 241 mm])

**Paper types**

Plain bond paper

**Weight**

20 lb (95 g/m<sup>2</sup>) to 24 lb (90 g/m<sup>2</sup>)

**Parent topic:** [Technical Specifications](#)

**Related references**

[Compatible Epson Papers](#)

## Printable Area Specifications

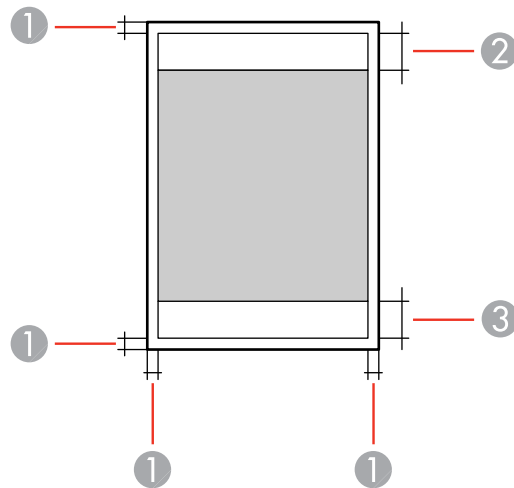
**Single sheets**

- 1 Top/bottom/right/left: 0.12 inch (3 mm) minimum
- 2 Reduced print quality area/top: 1.89 inches (48 mm) minimum



3 Reduced print quality area/bottom: 1.93 inches (49 mm) minimum

### Envelopes

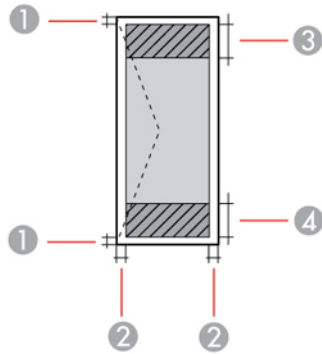

- 1 Left/right: 0.12 inch (3 mm) minimum
- 2 Top/bottom: 0.12 inch (3 mm) minimum
- 3 Reduced print quality area/left: 1.89 inch (48 mm) minimum
- 4 Reduced print quality area/right: 1.93 inches (49 mm) minimum

Parent topic: [Technical Specifications](#)

## Automatic Document Feeder (ADF) Specifications

<b>Paper input</b>	Faceup loading
<b>Paper output</b>	Facedown ejection
<b>Paper size</b>	US letter, legal, A3, or A4 size
<b>Paper type</b>	Plain paper, high-quality plain paper, or recycled paper
<b>Paper weight</b>	17 lb (64 g/m <sup>2</sup> ) to 24 lb (95 g/m <sup>2</sup> )
<b>Sheet feeding capacity</b>	Total thickness: 0.22 inch (5.5 mm) Approximately 50 sheets

Parent topic: [Technical Specifications](#)

## Scanning Specifications

<b>Scanner type</b>	Flatbed, color
<b>Photoelectric device</b>	CIS
<b>Effective pixels</b>	14040 × 20400 pixels at 1200 dpi
<b>Document size</b>	ADF Maximum: 11.7 × 17 inches (297 × 431.8 mm) Scanner glass: A3 (11.7 × 16.5 inches (297 × 420 mm))
<b>Scanning resolution</b>	1200 dpi (main scan) 2400 dpi (sub scan)
<b>Output resolution</b>	50 to 9600 dpi in 1 dpi increments
<b>Image data</b>	Color: 48 bits per pixel (16 bits per pixel per color) internal 24 bits per pixel (8 bits per pixel per color) external Grayscale: 16 bits per pixel internal 8 bits per pixel external Black and white: 16 bits per pixel internal 1 bit per pixel external
<b>Light source</b>	LED

Parent topic: [Technical Specifications](#)

## Fax Specifications

<b>Fax type</b>	Black-and-white and color fax capability (ITU-T Super Group 3)
<b>Supported lines</b>	Standard analog phone lines PBX (Private Branch Exchange) telephone systems
<b>Speed</b>	Up to 33.6 kbps

<b>Resolution</b>	<p><b>Monochrome</b></p> <p>Standard: 203 pixels per inch × 98 lines per inch (8 pixels per mm × 3.85 lines per mm)</p> <p>Fine: 203 pixels per inch × 196 lines per inch (8 pixels per mm × 7.7 lines per mm)</p> <p>Super Fine: 203 pixels per inch × 392 lines per inch (8 pixels per mm × 15.4 lines per mm)</p> <p>Ultra Fine: 406 pixels per inch × 392 lines per inch (16 pixels per mm × 15.4 lines per mm)</p> <p><b>Color</b></p> <p>200 × 200 dpi</p>
<b>Page memory</b>	Up to 550 pages (when an ITU-T No. 1 chart is received in monochrome draft mode)
<b>Redial</b>	2 times (with 1 minute interval); may differ depending on your country or region
<b>Interface</b>	<p>RJ-11 Phone Line</p> <p>RJ-11 Telephone set connection</p>

Parent topic: [Technical Specifications](#)

## Ink Specifications

**Note:** Epson's warranties do not extend to any damage caused by the use of third-party ink or ink not designed for your printer.

The included initial ink bottles must be used for printer setup and are not for resale. The printer ships with full ink bottles and part of the ink from the first bottles is used to charge the print head. Yields vary considerably based on images printed, print settings, paper type, frequency of use and temperature.

<b>Color</b>	Black, Cyan, Magenta, Yellow
<b>Ink life</b>	Do not use if the date on the package has expired

**Temperature**

Storage: -4 to 104 °F (-20 to 40 °C)

1 month at 104 °F (40 °C)

Ink freezes at 5 °F (-15 °C)

Ink thaws and is usable after approximately 2 hours at 77 °F (25 °C)

Parent topic: [Technical Specifications](#)**Dimension Specifications****Height**

Stored: 13.8 inches (350 mm)

Printing: 20.5 inches (521 mm)

**Width**

Stored: 20.3 inches (515 mm)

Printing: 20.3 inches (515 mm)

**Depth**

Stored: 19.7 inches (500 mm)

Printing: 38.4 inches (976 mm)

**Weight**

44.5 lb (20.2 kg)

(without ink or power cord)

Parent topic: [Technical Specifications](#)**Electrical Specifications****Power supply rating**

100 to 240 V

**Input voltage range**

90 to 264 V

**Rated frequency range**

50 to 60 Hz

**Input frequency range**

49.5 to 60.5 Hz

**Rated current**

0.8 to 0.4 A

**Power consumption**

Standalone copying ST-C8000: Approximately 19 W (ISO/IEC24712)

Standalone copying ST-C8090: Approximately 20 W (ISO/IEC24712)

Ready mode ST-C8000: Approximately 9.5 W

Ready mode ST-C8090: Approximately 10.3 W

Sleep mode ST-C8000: Approximately 0.8 W

Sleep mode ST-C8090: Approximately 0.9 W

Power off mode: Approximately 0.15 W

Parent topic: [Technical Specifications](#)

## Environmental Specifications

**Temperature**

Operating: 50 to 95 °F (10 to 35 °C)

Storage: -4 to 104 °F (-20 to 40 °C)

1 month at 104 °F (40 °C)

**Humidity**

(without condensation)

Operating: 20 to 80% RH

Storage: 5 to 85% RH

Parent topic: [Technical Specifications](#)

## Interface Specifications

**Interface type**

Hi-Speed USB (Device Class for computers)

Hi-Speed USB (for Mass storage class for external storage)

**Note:** Epson cannot guarantee the operation of externally connected devices.

Parent topic: [Technical Specifications](#)

## External USB Device Specifications

Do not use devices with the following requirements:

- Dedicated driver
- Security settings
- A built-in USB hub

**Note:** Use only external storage devices with independent AC power sources. External storage devices that are powered via USB are not recommended. Epson cannot guarantee the operation of externally connected devices.

**USB flash drive, HDD, or card reader** 2TB (formatted in FAT, FAT32, or exFAT)

**Note:** If you have a multi-card reader, only insert one memory card at a time. Multi-card readers with two or more memory cards inserted are not supported.

You can use USB devices with your product containing files that meet these specifications.

<b>File format</b>	JPEG with the Exif version 2.31 standard taken by digital cameras with the DCF (Design Rule for Camera File system) version 1.0 or 2.0 standard <sup>1</sup> TIFF 6.0-compliant uncompressed images: RGB full-color or binary (not CCITT-encoded) PDF version 1.7 compliant data
<b>Image size</b>	80 × 80 pixels to 10200 × 10200 pixels
<b>File size</b>	Up to 2GB
<b>Number of files</b>	JPEG: Up to 9990 <sup>2</sup> TIFF: Up to 999 PDF: Up to 999

<sup>1</sup> Files stored on digital cameras with built-in memory are not supported.

<sup>2</sup> If the number of files exceeds 999, the files are displayed in groups.

**Parent topic:** [Technical Specifications](#)

# Network Interface Specifications

## Wi-Fi

<b>Standard</b>	IEEE802.11a/b/g/n/ac; IEEE802.11n available only on the 20 MHz channel
<b>Frequency ranges</b>	IEEE802.11a/n/ac: 5 GHz IEEE802.11b/g/n: 2.4 GHz
<b>Wi-Fi channels</b>	5 GHz*: W52 (36/40/44/48) W53 (52/56/60/64) W56 (100/104/108/112/116/132/136/140) W58 (149/153/157/161/165) 2.4 GHz: 1/2/3/4/5/6/7/8/9/10/11/12/13
<b>Wi-Fi Direct channels</b>	5 GHz*: W52 (36/40/44/48) W58 (149/153/157/161/165) 2.4 GHz: 1/2/3/4/5/6/7/8/9/10/11/12/13
<b>Maximum radio-frequency power transmitted</b>	20 dBm (EIRP)
<b>Connection modes</b>	Infrastructure mode Wi-Fi Direct (Simple AP)

**Note:** Wi-Fi Direct (Simple AP) mode available for IEEE 802.11b.

**Wireless security protocols**

WEP (64/128 bit)

WPA2-PSK (AES); complies with WPA2 standards with support for WPA/WPA2 Personal

WPA3-SAE (AES)

WPA2/WPA3-Enterprise

**Note:** Wi-Fi Direct supports only WPA2-PSK (AES).

\*The availability of outdoor use over these channels varies by location, as described in the table below.

**Limitations for Using 5GHz Frequencies Outdoors**

Frequency range	W52	W53	W56	W58
Frequency	5150-5250 MHz	5250-5350 MHz	5470-5725 MHz	5725-5850 MHz
Channel	36/40/44/48	52/56/60/64	100/104/108/112/116/ 120/124/128/132/136/1 40	149/153/157/161/ 165
U.S.	Outdoor use allowed	Outdoor use allowed	Outdoor use allowed	Outdoor use allowed
Canada	Outdoor use prohibited	Outdoor use allowed	Outdoor use allowed	Outdoor use allowed

**Ethernet****Standards**

IEEE802.3i (10BASE-T)

IEEE802.3u (100BASE-TX)

IEEE802.3ab (1000BASE-T)

**Note:** To prevent risk of radio interference, use a Category-5e or higher shielded twisted pair cable.

IEEE802.3az (Energy Efficient Ethernet); connected device should be IEEE802.3az compliant



**Communication mode** Auto, 10Mbps Full duplex, 10Mbps Half duplex, 100Mbps Full duplex, 100Mbps Half duplex

**Connector** RJ-45

### **Security Protocol**

- IEEE802.1X (requires a connected device compliant with IEEE802.1X)
- IPsec/IP Filtering
- SSL/TLS; HTTPS Server/Client and IPPS
- SMTPS; STARTTLS and SSL/TLS
- SNMPv3

**Parent topic:** [Technical Specifications](#)

## **Safety and Approvals Specifications**

**United States** Safety: UL60950-1

EMC: FCC part 15 Subpart B class B

**Canada**

Safety: CAN/CSA C22.2 No. 60950-1

EMC: CAN ICES-3 (B)/NMB-3 (B)

This equipment contains the following wireless module:

- Manufacturer: Seiko Epson Corporation
- Type: J26H005

This product conforms to Part 15 of FCC Rules and RSS-210 of the IC Rules. Epson cannot accept responsibility for any failure to satisfy the protection requirements resulting from a non-recommended modification of the product. Operation is subject to the following two conditions: (1) this device may not cause harmful interference, and (2) this device must accept any interference received, including interference that may cause undesired operation of the device.

To prevent radio interference to the licensed service, this device is intended to be operated indoors and away from windows to provide maximum shielding. Equipment (or its transmit antenna) that is installed outdoors is subject to licensing.

This equipment complies with FCC/IC radiation exposure limits set forth for an uncontrolled environment and meets the FCC radio frequency (RF) Exposure Guidelines in Supplement C to OET65 and RSS-102 of the IC radio frequency (RF) Exposure rules. This equipment should be installed and operated so that

the radiator is kept at least 7.9 inches (20 cm) or more away from a person's body (excluding extremities: hands, wrists, feet and ankles).

**Parent topic:** [Technical Specifications](#)

---

## Notices

Check these sections for important notices about your product.

**Note:** Epson offers a recycling program for end of life Epson products. Please go to [this site](#) (U.S) or [this site](#) (Canada) for information on how to return your Epson products for proper disposal.

[Important Safety Instructions](#)

[FCC Compliance Statement](#)

[Binding Arbitration and Class Waiver](#)

[Trademarks](#)

[Copyright Notice](#)

## Important Safety Instructions

Before using your Epson product, read and follow these safety instructions.

[General Product Safety Instructions](#)

[Wireless Connection Safety Instructions](#)

[LCD Screen Safety Instructions](#)

[Telephone Equipment Safety Instructions](#)

**Parent topic:** [Notices](#)

## General Product Safety Instructions

- Be sure to follow all warnings and instructions marked on the product.
- Use only the type of power source indicated on the product's label.
- Use only the power cord that comes with the product. Use of another cord may cause fires or shock. Do not use the cord with any other equipment.
- Make sure the AC power cord meets the relevant local safety standard.
- Place the product near a wall outlet where the plug can be easily unplugged.
- Avoid plugging the product into an outlet on the same circuit as a photo copier or air control system that regularly switches on and off, or on an outlet controlled by a wall switch or timer.
- Do not let the power cord become damaged or frayed. Place it to avoid abrasions, cuts, fraying, crimping, and kinking. Do not place objects on top of it and do not allow it to be stepped on or run over. Be careful to keep the cord straight at each end.

- If you use an extension cord with the product, make sure the total ampere rating of the devices plugged into the extension cord does not exceed the cord's ampere rating. Also, make sure the total ampere rating of all devices plugged into the wall outlet does not exceed the wall outlet's ampere rating.
- Always turn off the product using the power button, and wait until the power light stops flashing before unplugging the product or cutting off power to the electrical outlet.
- If you will not be using the product for a long period, unplug the power cord from the electrical outlet.
- Place the product on a flat, stable surface that extends beyond its base in all directions. It will not operate properly if it is tilted or at an angle.
- Allow space behind the product for the cables, and space above the product so that you can fully raise the document cover.
- Leave enough space in front of the product for the paper to be fully ejected.
- Avoid locations that are subject to rapid changes in heat or humidity, shocks or vibrations, or dust.
- Do not place or store the product outdoors.
- Do not place the product near excessive heat sources or in direct sunlight.
- Leave enough room around the product for sufficient ventilation. Do not block or cover openings in the case or insert objects through the slots.
- Keep the product away from potential sources of electromagnetic interference, such as loudspeakers or the base units of cordless telephones.
- Keep your product at least 8.7 inches (22 cm) away from cardiac pacemakers to prevent your product's radio waves from affecting the operation of the pacemaker.
- When connecting the product to a computer or other device with a cable, ensure the correct orientation of the connectors. Each connector has only one correct orientation. Inserting a connector in the wrong orientation may damage both devices connected by the cable.
- Do not sit or lean on the product. Do not place heavy objects on the product.
- Do not touch the flat white cable or ink tubes inside the product.
- Do not move the print head by hand; this may damage the product.
- Do not put your hand inside the product while it is printing.
- Do not spill liquid on the product or use the product with wet hands.
- Do not use aerosol products that contain flammable gases inside or around the product. Doing so may cause fire.
- Do not press too hard on the scanner glass when placing originals.

- Do not open the scanner section while the product is copying, printing, scanning, or performing any other functions.
- Be careful not to trap your fingers when closing the document cover or scanner unit.
- Except as specifically explained in your documentation, do not attempt to service or disassemble the product yourself.
- Unplug the product and refer servicing to qualified service personnel under the following conditions: if the power cord or plug is damaged; if liquid has entered the product; if the product has been dropped or the case damaged; if the product does not operate normally or exhibits a distinct change in performance. Adjust only those controls that are covered by the operating instructions.
- If any of the ink tanks are not filled up to the lower line, refill the ink soon. Prolonged use of the product when the ink level is below the lower line could damage the product.
- Before transporting the product, make sure that the transportation lock is set to the locked position and that the print head is in the home (far right) position.
- When storing or transporting the product, do not tilt it, stand it on its side, or turn it upside down; otherwise, ink may leak.
- Do not attempt to move the product by yourself.

**Parent topic:** [Important Safety Instructions](#)

## Wireless Connection Safety Instructions

Radio waves from this product may adversely affect the operation of medical equipment or automatically controlled devices, such as pacemakers, automatic doors or fire alarms. When using this product near such devices or inside a medical facility, follow the directions from authorized staff members at the facility, and follow all posted warnings and directions on the device to avoid causing an accident.

**Parent topic:** [Important Safety Instructions](#)

## LCD Screen Safety Instructions

- Use only a dry, soft cloth to clean the LCD screen. Do not use liquid or chemical cleansers.
- If the LCD screen is damaged, contact Epson. If the liquid crystal solution gets on your hands, wash them thoroughly with soap and water. If the liquid crystal solution gets into your eyes, flush them immediately with water. If discomfort or vision problems remain after a thorough flushing, see a doctor immediately.
- Do not press too hard on the LCD screen or subject it to heavy impacts.
- Do not use a pointy or sharp object, such as a pen or your fingernail, to operate the LCD screen.

- If the LCD screen chips or cracks, do not touch or attempt to remove the broken pieces; contact Epson for support.
- Do not subject your product to sudden changes in temperature or humidity; this may cause condensation to develop inside the LCD screen and degrade its performance.
- The LCD screen may contain a few small bright or dark spots, and may display uneven brightness. These are normal and do not indicate that the screen is damaged in any way.

**Parent topic:** [Important Safety Instructions](#)

## Telephone Equipment Safety Instructions

When using telephone equipment, you should always follow basic safety precautions to reduce the risk of fire, electric shock, and personal injury, including the following:

- Do not use the Epson product near water.
- Avoid using a telephone during an electrical storm. There may be a remote risk of electric shock from lightning.
- Do not use a telephone to report a gas leak in the vicinity of the leak.

**Caution:** To reduce the risk of fire, use only a No. 26 AWG or larger telecommunication line cord.

**Parent topic:** [Important Safety Instructions](#)

## FCC Compliance Statement

### For United States Users

This equipment complies with Part 68 of the FCC rules and the requirements adopted by the Administrative Council for Terminal Attachments ("ACTA") . On the surface of this equipment is a label that contains, among other information, a product identifier in the format US:AAAEQ##TXXXX. If requested, this number must be provided to the telephone company.

Applicable certification jack Universal Service Order Codes ("USOC") for the equipment: RJ11C.

A plug and jack used to connect this equipment to the premises wiring and telephone network must comply with the applicable FCC Part 68 rules and requirements adopted by the ACTA. A compliant telephone cord and modular plug is provided with this product. It is designed to be connected to a compatible modular jack that is also compliant. See installation instructions for details.

The REN is used to determine the number of devices that may be connected to a telephone line. Excessive RENs on a telephone line may result in the devices not ringing in response to an incoming call. In most but not all areas, the sum of RENs should not exceed five (5.0). To be certain of the number

of devices that may be connected to a line, as determined by the total RENs, contact the local telephone company. For products approved after July 23, 2001, the REN for this product is part of the product identifier that has the format US:AAAEQ##TXXXX. The digits represented by ## are the REN without a decimal point (e.g., 03 is a REN of 0.3). For earlier products, the REN is separately shown on the label.

If this equipment causes harm to the telephone network, the telephone company will notify you in advance that temporary discontinuance of service may be required. But if advance notice isn't practical, the telephone company will notify the customer as soon as possible. Also, you will be advised of your right to file a complaint with the FCC if you believe it is necessary.

The telephone company may make changes in its facilities, equipment, operations or procedures that could affect the operation of the equipment. If this happens the telephone company will provide advance notice in order for you to make necessary modifications to maintain uninterrupted service.

If you have problems with this product and require technical or customer support, please visit [www.epson.com](http://www.epson.com) for more information.

This product is not intended to be repaired by the customer. If you experience trouble connecting this equipment to a telephone line, please contact:

Name: Epson America, Inc.

Address: 3131 Katella Ave., Los Alamitos, CA 90720 U.S.A.

Telephone: (562) 981-3840

If the equipment is causing harm to the telephone network, the telephone company may request that you disconnect the equipment until the problem is resolved.

This equipment may not be used on coin service provided by the telephone company. Connection to party line service is subject to state tariffs. Contact the state public utility commission, public service commission or corporation commission for information.

If your home has specially wired alarm equipment connected to the telephone line, ensure the installation of this equipment does not disable your alarm equipment. If you have questions about what will disable alarm equipment, consult your telephone company or a qualified installer.

The Telephone Consumer Protection Act of 1991 makes it unlawful for any person to use a computer or other electronic device, including fax machines, to send any message unless such message clearly contains in a margin at the top or bottom of each transmitted page or on the first page of the transmission, the date and time it is sent and an identification of the business or other entity, or other individual sending the message and the telephone number of the sending machine or such business, other entity, or individual. (The telephone number provided may not be a 900 number or any other number for which charges exceed local or long-distance transmission charges.)

In order to program this information into your fax machine, click the link below for instructions on entering fax header information.

According to the FCC's electrical safety advisory, we recommend that you may install an AC surge arrester in the AC outlet to which this equipment is connected. Telephone companies report that electrical surges, typically lightning transients, are very destructive to customer terminal equipment connected to AC power sources and that this is a major nationwide problem.

This equipment has been tested and found to comply with the limits for a Class B digital device, pursuant to Part 15 of the FCC Rules. These limits are designed to provide reasonable protection against harmful interference in a residential installation. This equipment generates, uses, and can radiate radio frequency energy and, if not installed and used in accordance with the instructions, may cause harmful interference to radio or television reception. However, there is no guarantee that interference will not occur in a particular installation. If this equipment does cause interference to radio and television reception, which can be determined by turning the equipment off and on, the user is encouraged to try to correct the interference by one or more of the following measures:

- Reorient or relocate the receiving antenna.
- Increase the separation between the equipment and receiver.
- Connect the equipment into an outlet on a circuit different from that to which the receiver is connected.
- Consult the dealer or an experienced radio/TV technician for help.

#### **WARNING**

The connection of a non-shielded equipment interface cable to this equipment will invalidate the FCC Certification or Declaration of this device and may cause interference levels which exceed the limits established by the FCC for this equipment. It is the responsibility of the user to obtain and use a shielded equipment interface cable with this device. If this equipment has more than one interface connector, do not leave cables connected to unused interfaces. Changes or modifications not expressly approved by the manufacturer could void the user's authority to operate the equipment.

#### **For Canadian Users**

1. This product meets the applicable Innovation, Science and Economic Development Canada technical specifications.
2. The Ringer Equivalence Number indicates the maximum number of devices allowed to be connected to a telephone interface. The termination of an interface may consist of any combination of devices subject only to the requirement that the sum of the RENs of all the devices does not exceed five.

CAN ICES-3(B)/NMB-3(B)

Le présent produit est conforme aux spécifications techniques applicables d'Innovation, Sciences et Développement économique Canada.

L'indice d'équivalence de la sonnerie (IES) sert à indiquer le nombre maximal de dispositifs qui peuvent être raccordés à une interface téléphonique. La terminaison d'une interface peut consister en une



combinaison quelconque de dispositifs, à la seule condition que la somme des IES de tous les dispositifs n'exécède pas cinq.

CAN ICES-3(B)/NMB-3(B)

Parent topic: [Notices](#)

## Binding Arbitration and Class Waiver

### 1. DISPUTES, BINDING INDIVIDUAL ARBITRATION, AND WAIVER OF CLASS ACTIONS AND CLASS ARBITRATIONS

1.1 **Disputes.** The terms of this Section 1 shall apply to all Disputes between you and Epson. The term "Dispute" is meant to have the broadest meaning permissible under law and includes any dispute, claim, controversy or action between you and Epson arising out of or relating to this Agreement, Epson branded products (hardware and including any related software), or other transaction involving you and Epson, whether in contract, warranty, misrepresentation, fraud, tort, intentional tort, statute, regulation, ordinance, or any other legal or equitable basis. "DISPUTE" DOES NOT INCLUDE IP CLAIMS, or more specifically, a claim or cause of action for (a) trademark infringement or dilution, (b) patent infringement, (c) copyright infringement or misuse, or (d) trade secret misappropriation (an "IP Claim"). You and Epson also agree, notwithstanding Section 1.6, that a court, not an arbitrator, may decide if a claim or cause of action is for an IP Claim.

1.2 **Binding Arbitration.** You and Epson agree that all Disputes shall be resolved by binding arbitration according to this Agreement. **ARBITRATION MEANS THAT YOU WAIVE YOUR RIGHT TO A JUDGE OR JURY IN A COURT PROCEEDING AND YOUR GROUNDS FOR APPEAL ARE LIMITED.**

Pursuant to this Agreement, binding arbitration shall be administered by JAMS, a nationally recognized arbitration authority, pursuant to its code of procedures then in effect for consumer related disputes, but excluding any rules that permit joinder or class actions in arbitration (for more detail on procedure, see Section 1.6 below). You and Epson understand and agree that (a) the Federal Arbitration Act (9 U.S.C. §1, et seq.) governs the interpretation and enforcement of this Section 1, (b) this Agreement memorializes a transaction in interstate commerce, and (c) this Section 1 shall survive termination of this Agreement.

1.3 **Pre-Arbitration Steps and Notice.** Before submitting a claim for arbitration, you and Epson agree to try, for sixty (60) days, to resolve any Dispute informally. If Epson and you do not reach an agreement to resolve the Dispute within the sixty (60) days, you or Epson may commence an arbitration. Notice to Epson must be addressed to: Epson America, Inc., ATTN: Legal Department, 3131 Katella Ave., Los Alamitos, CA 90720 (the "Epson Address"). The Dispute Notice to you will be sent to the most recent address Epson has in its records for you. For this reason, it is important to notify us if your address changes by emailing us at [EAILEgal@ea.epson.com](mailto:EAILEgal@ea.epson.com) or writing us at the Epson Address above. Notice of the Dispute shall include the sender's name, address and contact information, the facts giving rise to the

Dispute, and the relief requested (the "Dispute Notice"). Following receipt of the Dispute Notice, Epson and you agree to act in good faith to resolve the Dispute before commencing arbitration.

**1.4 Small Claims Court.** Notwithstanding the foregoing, you may bring an individual action in the small claims court of your state or municipality if the action is within that court's jurisdiction and is pending only in that court.

**1.5 WAIVER OF CLASS ACTIONS AND CLASS ARBITRATIONS. YOU AND EPSON AGREE THAT EACH PARTY MAY BRING DISPUTES AGAINST THE OTHER PARTY ONLY IN AN INDIVIDUAL CAPACITY, AND NOT AS A PLAINTIFF OR CLASS MEMBER IN ANY CLASS OR REPRESENTATIVE PROCEEDING, INCLUDING WITHOUT LIMITATION FEDERAL OR STATE CLASS ACTIONS, OR CLASS ARBITRATIONS. CLASS ACTION LAWSUITS, CLASS-WIDE ARBITRATIONS, PRIVATE ATTORNEY-GENERAL ACTIONS, AND ANY OTHER PROCEEDING WHERE SOMEONE ACTS IN A REPRESENTATIVE CAPACITY ARE NOT ALLOWED. ACCORDINGLY, UNDER THE ARBITRATION PROCEDURES OUTLINED IN THIS SECTION, AN ARBITRATOR SHALL NOT COMBINE OR CONSOLIDATE MORE THAN ONE PARTY'S CLAIMS WITHOUT THE WRITTEN CONSENT OF ALL AFFECTED PARTIES TO AN ARBITRATION PROCEEDING.**

**1.6 Arbitration Procedure.** If you or Epson commences arbitration, the arbitration shall be governed by the rules of JAMS that are in effect when the arbitration is filed, excluding any rules that permit arbitration on a class or representative basis (the "JAMS Rules"), available at <http://www.jamsadr.com> or by calling 1-800-352-5267, and under the rules set forth in this Agreement. All Disputes shall be resolved by a single neutral arbitrator, and both parties shall have a reasonable opportunity to participate in the selection of the arbitrator. The arbitrator is bound by the terms of this Agreement. The arbitrator, and not any federal, state or local court or agency, shall have exclusive authority to resolve all disputes arising out of or relating to the interpretation, applicability, enforceability or formation of this Agreement, including any claim that all or any part of this Agreement is void or voidable. Notwithstanding this broad delegation of authority to the arbitrator, a court may determine the limited question of whether a claim or cause of action is for an IP Claim, which is excluded from the definition of "Disputes" in Section 1.1 above. The arbitrator shall be empowered to grant whatever relief would be available in a court under law or in equity. The arbitrator may award you the same damages as a court could, and may award declaratory or injunctive relief only in favor of the individual party seeking relief and only to the extent necessary to provide relief warranted by that party's individual claim. In some instances, the costs of arbitration can exceed the costs of litigation and the right to discovery may be more limited in arbitration than in court. The arbitrator's award is binding and may be entered as a judgment in any court of competent jurisdiction.

You may choose to engage in arbitration hearings by telephone. Arbitration hearings not conducted by telephone shall take place in a location reasonably accessible from your primary residence, or in Orange County, California, at your option.

a) Initiation of Arbitration Proceeding. If either you or Epson decides to arbitrate a Dispute, both parties agree to the following procedure:

(i) Write a Demand for Arbitration. The demand must include a description of the Dispute and the amount of damages sought to be recovered. You can find a copy of a Demand for Arbitration at <http://www.jamsadr.com> ("Demand for Arbitration").

(ii) Send three copies of the Demand for Arbitration, plus the appropriate filing fee, to: JAMS, 500 North State College Blvd., Suite 600 Orange, CA 92868, U.S.A.

(iii) Send one copy of the Demand for Arbitration to the other party (same address as the Dispute Notice), or as otherwise agreed by the parties.

b) Hearing Format. During the arbitration, the amount of any settlement offer made shall not be disclosed to the arbitrator until after the arbitrator determines the amount, if any, to which you or Epson is entitled. The discovery or exchange of non-privileged information relevant to the Dispute may be allowed during the arbitration.

c) Arbitration Fees. Epson shall pay, or (if applicable) reimburse you for, all JAMS filings and arbitrator fees for any arbitration commenced (by you or Epson) pursuant to provisions of this Agreement.

d) Award in Your Favor. For Disputes in which you or Epson seeks \$75,000 or less in damages exclusive of attorney's fees and costs, if the arbitrator's decision results in an award to you in an amount greater than Epson's last written offer, if any, to settle the Dispute, Epson will: (i) pay you \$1,000 or the amount of the award, whichever is greater; (ii) pay you twice the amount of your reasonable attorney's fees, if any; and (iii) reimburse you for any expenses (including expert witness fees and costs) that your attorney reasonably accrues for investigating, preparing, and pursuing the Dispute in arbitration. Except as agreed upon by you and Epson in writing, the arbitrator shall determine the amount of fees, costs, and expenses to be paid by Epson pursuant to this Section 1.6d).

e) Attorney's Fees. Epson will not seek its attorney's fees and expenses for any arbitration commenced involving a Dispute under this Agreement. Your right to attorney's fees and expenses under Section 1.6d) above does not limit your rights to attorney's fees and expenses under applicable law; notwithstanding the foregoing, the arbitrator may not award duplicative awards of attorney's fees and expenses.

**1.7 Opt-out. You may elect to opt-out (exclude yourself) from the final, binding, individual arbitration procedure and waiver of class and representative proceedings specified in this Agreement by sending a written letter to the Epson Address within thirty (30) days of your assent to this Agreement (including without limitation the purchase, download, installation of the Software or other applicable use of Epson Hardware, products and services) that specifies (i) your name, (ii) your mailing address, and (iii) your request to be excluded from the final, binding individual arbitration procedure and waiver of class and representative proceedings specified in this Section 1. In the event that you opt-out consistent with the procedure set forth above, all other terms shall continue to apply, including the requirement to provide notice prior to litigation.**

**1.8 Amendments to Section 1.** Notwithstanding any provision in this Agreement to the contrary, you and Epson agree that if Epson makes any future amendments to the dispute resolution procedure and

class action waiver provisions (other than a change to Epson's address) in this Agreement, Epson will obtain your affirmative assent to the applicable amendment. If you do not affirmatively assent to the applicable amendment, you are agreeing that you will arbitrate any Dispute between the parties in accordance with the language of this Section 1 (or resolve disputes as provided for in Section 1.7, if you timely elected to opt-out when you first assented to this Agreement).

**1.9 Severability.** If any provision in this Section 1 is found to be unenforceable, that provision shall be severed with the remainder of this Agreement remaining in full force and effect. **The foregoing shall not apply to the prohibition against class or representative actions as provided in Section 1.5. This means that if Section 1.5 is found to be unenforceable, the entire Section 1 (but only Section 1) shall be null and void.**

Parent topic: [Notices](#)

## Trademarks

EPSON® is a registered trademark, EPSON Exceed Your Vision is a registered logomark, and Epson Connect™, Epson iPrint™, and Remote Print™ are trademarks of Seiko Epson Corporation.

Windows is a registered trademark of Microsoft Corporation in the United States and/or other countries.

Mac, macOS, OS X, ColorSync, AirPrint, iPad, iPhone, iPod touch, are trademarks of Apple Inc., registered in the U.S. and other countries. App Store is a service mark of Apple Inc., registered in the U.S. and other countries.

Use of the Works with Apple badge means that an accessory has been designed to work specifically with the technology identified in the badge and has been certified by the developer to meet Apple performance standards.

Google® is a registered trademark and Android™, Google Chrome™, and Google Drive™ are trademarks of Google LLC.

Wi-Fi Direct® is a registered trademark of Wi-Fi Alliance®.

General Notice: Other product names used herein are for identification purposes only and may be trademarks of their respective owners. Epson disclaims any and all rights in those marks.



Parent topic: [Notices](#)

## Copyright Notice

All rights reserved. No part of this publication may be reproduced, stored in a retrieval system, or transmitted in any form or by any means, electronic, mechanical, photocopying, recording, or otherwise, without the prior written permission of Seiko Epson Corporation. The information contained herein is designed only for use with this Epson product. Epson is not responsible for any use of this information as applied to other products.

Neither Seiko Epson Corporation nor its affiliates shall be liable to the purchaser of this product or third parties for damages, losses, costs, or expenses incurred by purchaser or third parties as a result of: accident, misuse, or abuse of this product or unauthorized modifications, repairs, or alterations to this product, or (excluding the U.S.) failure to strictly comply with Seiko Epson Corporation's operating and maintenance instructions.

Seiko Epson Corporation shall not be liable for any damages or problems arising from the use of any options or any consumable products other than those designated as Original Epson Products or Epson Approved Products by Seiko Epson Corporation.

Seiko Epson Corporation shall not be held liable for any damage resulting from electromagnetic interference that occurs from the use of any interface cables other than those designated as Epson approved Products by Seiko Epson Corporation.

This information is subject to change without notice.

[libTIFF Software Acknowledgment](#)

[A Note Concerning Responsible Use of Copyrighted Materials](#)

[Default Delay Times for Power Management for Epson Products](#)

[Copyright Attribution](#)

**Parent topic:** [Notices](#)

## libTIFF Software Acknowledgment

Copyright © 1988-1997 Sam Leffler

Copyright © 1991-1997 Silicon Graphics, Inc.

Permission to use, copy, modify, distribute, and sell this software and its documentation for any purpose is hereby granted without fee, provided that (i) the above copyright notices and this permission notice appear in all copies of the software and related documentation, and (ii) the names of Sam Leffler and Silicon Graphics may not be used in any advertising or publicity relating to the software without the specific, prior written permission of Sam Leffler and Silicon Graphics.

THE SOFTWARE IS PROVIDED "AS-IS" AND WITHOUT WARRANTY OF ANY KIND, EXPRESS, IMPLIED OR OTHERWISE, INCLUDING WITHOUT LIMITATION, ANY WARRANTY OF MERCHANTABILITY OR FITNESS FOR A PARTICULAR PURPOSE.

IN NO EVENT SHALL SAM LEFFLER OR SILICON GRAPHICS BE LIABLE FOR ANY SPECIAL, INCIDENTAL, INDIRECT OR CONSEQUENTIAL DAMAGES OF ANY KIND, OR ANY DAMAGES WHATSOEVER RESULTING FROM LOSS OF USE, DATA OR PROFITS, WHETHER OR NOT ADVISED OF THE POSSIBILITY OF DAMAGE, AND ON ANY THEORY OF LIABILITY, ARISING OUT OF OR IN CONNECTION WITH THE USE OR PERFORMANCE OF THIS SOFTWARE.

**Parent topic:** [Copyright Notice](#)

## **A Note Concerning Responsible Use of Copyrighted Materials**

Epson encourages each user to be responsible and respectful of the copyright laws when using any Epson product. While some countries' laws permit limited copying or reuse of copyrighted material in certain circumstances, those circumstances may not be as broad as some people assume. Contact your legal advisor for any questions regarding copyright law.

**Parent topic:** [Copyright Notice](#)

## **Default Delay Times for Power Management for Epson Products**

This product will enter sleep mode after a period of nonuse. This is to ensure that the product meets Energy Star standards of energy efficiency. More energy savings can be achieved by setting the time to sleep to a shorter interval.

**Parent topic:** [Copyright Notice](#)

## **Copyright Attribution**

© 2021 Epson America, Inc.

4/21

CPD-59047R2

**Parent topic:** [Copyright Notice](#)