



# User Guide

HP Thin Client

© Copyright 2019 HP Development Company, L.P.

DisplayPort™, the DisplayPort™ logo, and VESA® are trademarks or registered trademarks owned by the Video Electronics Standards Association (VESA) in the United States and other countries. Linux is the registered trademark of Linus Torvalds in the U.S. and other countries. Microsoft and Windows are either registered trademarks or trademarks of Microsoft Corporation in the United States and/or other countries.

The information contained herein is subject to change without notice. The only warranties for HP products and services are set forth in the express warranty statements accompanying such products and services. Nothing herein should be construed as constituting an additional warranty. HP shall not be liable for technical or editorial errors or omissions contained herein.

Second Edition: November 2019

First Edition: July 2019

Document Part Number: L63760-002

## Product Notice

This user guide describes features that are common to most models. Some features may not be available on your computer.

Not all features are available in all editions or versions of Windows. Systems may require upgraded and/or separately purchased hardware, drivers, software or BIOS update to take full advantage of Windows functionality. Windows 10 is automatically updated, which is always enabled. ISP fees may apply and additional requirements may apply over time for updates. See <http://www.microsoft.com>.

To access the latest user guides, go to <http://www.hp.com/support>, and follow the instructions to find your product. Then select **User Guides**.





## Software terms

By installing, copying, downloading, or otherwise using any software product preinstalled on this computer, you agree to be bound by the terms of the HP End User License Agreement (EULA). If you do not accept these license terms, your sole remedy is to return the entire unused product (hardware and software) within 14 days for a full refund subject to the refund policy of your seller.

For any further information or to request a full refund of the price of the computer, please contact your seller.

## About This Guide

---

-  **WARNING!** Indicates a hazardous situation that, if not avoided, **could** result in serious injury or death.
  -  **CAUTION:** Indicates a hazardous situation that, if not avoided, **could** result in minor or moderate injury.
  -  **IMPORTANT:** Indicates information considered important but not hazard-related (for example, messages related to property damage). Warns the user that failure to follow a procedure exactly as described could result in loss of data or in damage to hardware or software. Also contains essential information to explain a concept or to complete a task.
  -  **NOTE:** Contains additional information to emphasize or supplement important points of the main text.
  -  **TIP:** Provides helpful hints for completing a task.
-



---

# Table of contents

|   |           |
|---|-----------|
| <b>1 Hardware Reference</b> .....   | <b>1</b>  |
| Product features .....  | 1         |
| Components .....  | 1         |
| Certificates, labels, and serial number location .....                      | 2         |
| Setup .....   | 3         |
| Warnings and cautions .....   | 3         |
| Installing the stand .....  | 3         |
| Installing a security cable .....   | 6         |
| Mounting and orienting the thin client .....                                | 6         |
| Supported orientation and placement .....                                   | 9         |
| Unsupported placement .....   | 11        |
| Connecting the AC adapter and power cord .....                              | 12        |
| Routine thin client care .....  | 12        |
| <b>2 Hardware Changes</b> .....   | <b>13</b> |
| Warnings and cautions .....   | 13        |
| Removing and replacing the access panel .....                               | 13        |
| Removing the access panel .....   | 14        |
| Replacing the access panel .....  | 15        |
| Locating internal components .....  | 16        |
| Removing and replacing the M.2 flash storage module .....                   | 16        |
| Removing and replacing the battery .....                                    | 18        |
| Upgrading system memory .....   | 20        |
| Removing and installing a memory module .....                               | 21        |
| Replacing a WLAN card .....   | 23        |
| <b>3 Troubleshooting</b> .....  | <b>25</b> |
| Computer Setup (F10) Utility, BIOS Settings .....                           | 25        |
| Computer Setup (F10) Utility .....  | 25        |
| Using Computer Setup (F10) Utility .....                                    | 26        |
| Computer Setup—File .....   | 27        |
| Computer Setup—Storage .....  | 28        |
| Computer Setup—Security .....   | 29        |
| Computer Setup—Power .....  | 30        |
| Computer Setup—Advanced .....   | 31        |
| Changing BIOS Settings from the HP BIOS Configuration Utility (HPBCU) ..... | 32        |

|   |           |
|---|-----------|
| Updating or restoring a BIOS .....  | 35        |
| Updating the firmware for Wake-On-Specific-Key .....  | 36        |
| Diagnostics and troubleshooting .....   | 36        |
| Lights .....  | 36        |
| Wake-on LAN .....   | 36        |
| Power-on sequence .....   | 37        |
| Resetting the setup and power-on passwords .....  | 37        |
| Power-on diagnostic tests .....   | 37        |
| Interpreting POST diagnostic front panel lights and audible codes .....                               | 38        |
| Troubleshooting .....   | 40        |
| Basic troubleshooting .....   | 40        |
| Diskless (no-flash) thin client troubleshooting .....   | 41        |
| Configuring a PXE server .....  | 42        |
| Using HP ThinUpdate to restore the image .....  | 42        |
| Device management .....   | 43        |
| Power cord set requirements .....   | 43        |
| Requirements for all countries .....  | 43        |
| Requirements for specific countries and regions .....   | 44        |
| Statement of volatility .....   | 45        |
| Available memory devices .....  | 45        |
| Specifications .....  | 47        |
| <b>4 Using HP PC Hardware Diagnostics .....</b>   | <b>48</b> |
| Using HP PC Hardware Diagnostics Windows (select products only) .....                                 | 48        |
| Downloading HP PC Hardware Diagnostics Windows .....  | 48        |
| Downloading the latest HP PC Hardware Diagnostics Windows version .....                               | 49        |
| Downloading HP Hardware Diagnostics Windows by product name or number<br>(select products only) ..... | 49        |
| Installing HP PC Hardware Diagnostics Windows .....   | 49        |
| Using HP PC Hardware Diagnostics UEFI .....   | 49        |
| Starting HP PC Hardware Diagnostics UEFI .....  | 50        |
| Downloading HP PC Hardware Diagnostics UEFI to a USB flash drive .....                                | 50        |
| Downloading the latest HP PC Hardware Diagnostics UEFI version .....                                  | 50        |
| Downloading HP PC Hardware Diagnostics UEFI by product name or number<br>(select products only) ..... | 50        |
| Using Remote HP PC Hardware Diagnostics UEFI settings (select products only) .....                    | 51        |
| Downloading Remote HP PC Hardware Diagnostics UEFI .....  | 51        |
| Downloading the latest Remote HP PC Hardware Diagnostics UEFI version .....                           | 51        |
| Downloading Remote HP PC Hardware Diagnostics UEFI by product name or<br>number .....                 | 51        |
| Customizing Remote HP PC Hardware Diagnostics UEFI settings .....                                     | 51        |

|   |           |
|---|-----------|
| <b>Appendix A Electrostatic discharge .....</b>                       | <b>53</b> |
| Preventing electrostatic damage .....                                 | 53        |
| Grounding methods .....   | 53        |
| <b>Appendix B Shipping information .....</b>                          | <b>54</b> |
| Shipping preparation .....  | 54        |
| Important service repair information .....                            | 54        |
| <b>Appendix C Accessibility .....</b>                                 | <b>55</b> |
| HP and accessibility .....  | 55        |
| Finding the technology tools you need .....                           | 55        |
| The HP commitment .....   | 55        |
| International Association of Accessibility Professionals (IAAP) ..... | 55        |
| Finding the best assistive technology .....                           | 56        |
| Assessing your needs .....  | 56        |
| Accessibility for HP products .....                                   | 56        |
| Standards and legislation .....                                       | 57        |
| Standards .....   | 57        |
| Mandate 376 – EN 301 549 .....  | 57        |
| Web Content Accessibility Guidelines (WCAG) .....                     | 57        |
| Legislation and regulations .....                                     | 57        |
| Useful accessibility resources and links .....                        | 58        |
| Organizations .....   | 58        |
| Educational institutions .....  | 58        |
| Other disability resources .....                                      | 58        |
| HP links .....  | 59        |
| Contacting support .....  | 59        |
| <b>Index .....</b>  | <b>60</b> |





# 1 Hardware Reference

## Product features



For the latest specifications or additional specifications on this product, go to <http://www.hp.com/go/quickspecs> and search for your specific model to find the model-specific QuickSpecs.

Various options are available for your thin client. For more information about some of the available options, go to <http://www.hp.com> and search for your specific model.

## Components

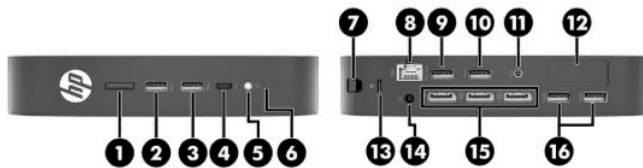

**Table 1-1 Components**

| Components   |  |
|--|--|
| <b>(1)</b> Power button                                      | <b>(9)</b> USB Type-A 2.0 port (designated for Power-on from Keyboard on select models only)<br><b>NOTE:</b> Press <b>alt + P</b> to turn on the thin client from the keyboard (select models only).   |
| <b>(2)</b> USB Type-A 3.1 Gen 1 port                         | <b>(10)</b> USB Type-A 2.0 port  |
| <b>(3)</b> USB Type-A 3.1 Gen 2 port                         | <b>(11)</b> Audio-out port   |
| <b>(4)</b> USB Type-C 3.1 Gen 2 downstream facing port (DFP) | <b>(12)</b> Optional port <ul style="list-style-type: none"><li>• Blank; no option included (shown)</li><li>• USB Type-A 3.1 Gen 1 ports (2)</li><li>• DisplayPort™ over USB Type-C with USB power delivery</li><li>• HDMI digital video output</li><li>• VGA analog video output</li><li>• External Wi-Fi antenna connector</li><li>• Fiber optic NIC connectors (SC or LC)</li></ul> |

**Table 1-1 Components (continued)**

| Components |   |      |                                |
|------------|---|------|--------------------------------|
|            | <ul style="list-style-type: none"><li>Serial port with configurable power</li><li>Serial ports via cable adapter (2); blue port is a configurable power port, and black port is a normal port</li></ul> |      |                                |
| (5)        | Headset jack  | (13) | Cable lock slot                |
| (6)        | Hard drive activity light   | (14) | Power connector                |
| (7)        | Rear I/O panel latch  | (15) | DisplayPort connectors (3)     |
| (8)        | RJ-45 (network) jack  | (16) | USB Type-A 3.1 Gen 1 ports (2) |

## Certificates, labels, and serial number location

The certificates, labels, and serial number are located under the side cover. Have the serial number available when contacting HP customer service for assistance.

**Table 1-2 Burn hazard warning**

| Burn hazard warning   |   |
|---|---|
|  | If the thin client has been in operation before you remove the side cover, the metal plate underneath the side cover can reach temperatures that may cause discomfort if directly touched. Turn the thin client off and allow 20 minutes for it to cool to room temperature before you remove the side cover. |

1. Lay the thin client down with the left side up and the front side with the HP logo facing you.
2. Insert a fingernail in the slot (1), and then lift the side cover (2) off the thin client.

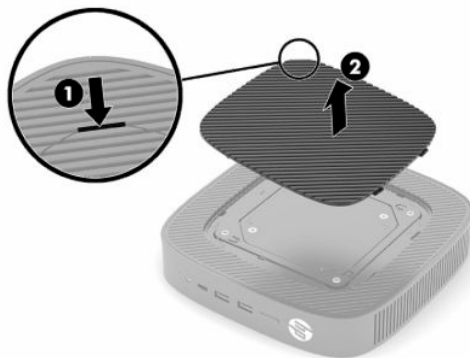

3. Locate the certificates, labels, and serial number as shown in the following illustration.

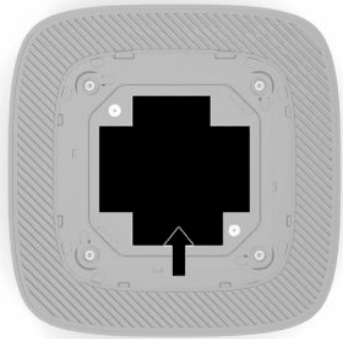

## Setup

### Warnings and cautions

Before performing upgrades be sure to carefully read all of the applicable instructions, cautions, and warnings in this guide.

- 
- ⚠ WARNING!** To reduce the risk of personal injury or equipment damage from electric shock, hot surfaces, or fire:

Install the thin client in a location where children are unlikely to be present.

Do not plug telecommunications or telephone connectors into the network interface controller (NIC) receptacles.

Do not insert objects into or through the system vents.

Plug the power cord into an AC outlet that is easily accessible at all times.

If the power cord has a 3-pin attachment plug, plug the cord into a grounded (earthed) 3-pin outlet.

Disconnect power from the computer by unplugging the power cord from the AC outlet. When unplugging the power cord from the AC outlet, grasp the cord by the plug.

- 
- ⚠ WARNING!** To reduce the risk of serious injury, read the *Safety & Comfort Guide* provided with your user guides. It describes proper workstation setup and proper posture, health, and work habits for computer users. The *Safety & Comfort Guide* also provides important electrical and mechanical safety information. The *Safety & Comfort Guide* is also available on the Web at <http://www.hp.com/ergo>.
- 

### Installing the stand

- 
- 📄 IMPORTANT:** Unless the thin client is mounted with an approved VESA® 100 mm mounting bracket, it must be operated with the system stand attached to ensure proper airflow around the system.
- 

When on a horizontal flat surface, such as a desktop, the thin client can be oriented horizontally or vertically. The stand is required in either orientation.

1. Remove any security devices that prohibit connecting the stand to the thin client.
2. Remove all removable media, such as USB flash drives, from the thin client.
3. If the thin client is turned on, turn off the thin client properly through the operating system, and then turn off any external devices.

4. If the power cord is connected, disconnect it from the AC outlet, and disconnect any external devices.
5. To attach the stand to the thin client:
  - Attach the stand to the bottom of the thin client to use the thin client in the vertical orientation.
    - a. Turn the thin client upside down and locate the two screw holes in the grid on the bottom of the thin client.
    - b. Position the stand over the bottom of the thin client (1) and install the two captive screws (2) to secure the stand to the thin client.

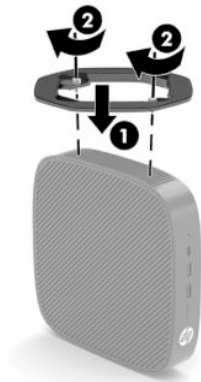

- Attach the stand to the left side of the thin client to use it in the horizontal orientation.
  - a. Lay the thin client down with the left side up and the front side with the HP logo facing you.
  - b. Insert a fingernail in the slot (1), and then lift the side cover (2) off the thin client.

---

 **NOTE:** Retain the side cover for possible future use.

 **CAUTION:** If the thin client has been in operation before removing the side cover, the metal plate underneath the side cover can reach temperatures that may cause discomfort if directly touched. Turn off the thin client and allow it to cool for 20 minutes to come to room temperature before removing the side cover.

---

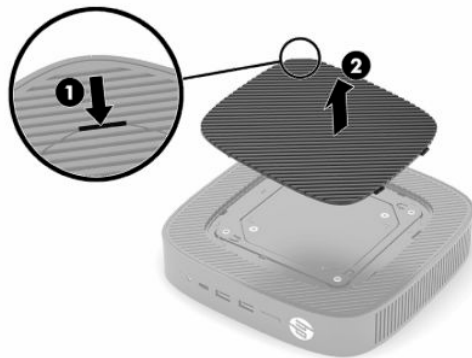

- c. If your system includes a spacer bracket, remove the spacer bracket before installing the stand.

---

 **NOTE:** Retain the spacer bracket for possible future use.

---



- d. Locate the two screw holes on the left side of the thin client.
- e. Position the stand over the side of the thin client (1) and install the captive screws (2) to secure the stand to the thin client.

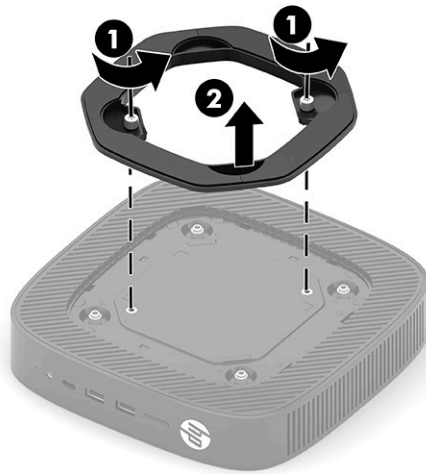

---

 **NOTE:** Be sure that at least **2.54 cm (1 in)** of space on all sides of the thin client remain clear and free of obstructions.

---

## Installing a security cable

You can secure the thin client to a fixed object with an optional security cable available from HP. Use the key provided to attach and remove the lock.

 **NOTE:** The security cable is designed to act as a deterrent, but it may not prevent the thin client from being mishandled or stolen.

---



## Mounting and orienting the thin client

This thin client incorporates four mounting points on the right side of the unit. These mounting points follow the VESA (Video Electronics Standards Association) 100 mm standard, which provides industry-standard mounting interfaces for various mounting brackets and accessories. HP offers various optional VESA-based mounting brackets to mount the thin client to a multitude of flat surfaces as well as swing arms and monitors in a variety of environments and orientations.

To attach a mounting bracket to the thin client:

1. Remove any security devices that prohibit connecting the mounting bracket to the thin client.
2. Remove all removable media, such as USB flash drives, from the thin client.
3. If the thin client is turned on, turn off the thin client properly through the operating system, and then turn off any external devices.
4. If the thin client is connected, disconnect the power cord from the AC outlet and disconnect any external devices.
5. Lay the thin client down with the left side up and the front side with the HP logo facing you.

6. Insert a fingernail in the slot (1), and then lift the side cover (2) off the thin client.

 **NOTE:** Retain the side cover for possible future use.

 **CAUTION:** If the thin client has been in operation, the metal plate underneath the side cover can reach temperatures that may cause discomfort if you directly touch it. Turn off the thin client and allow it to cool for 20 minutes to come to room temperature before removing the side cover.

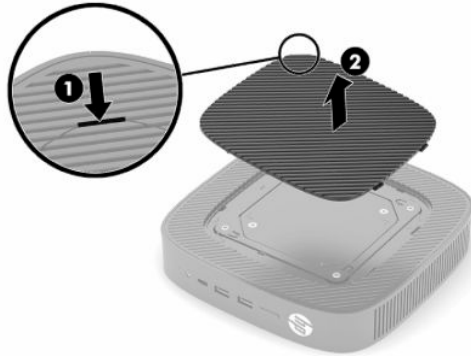

7. If a spacer bracket is required for your mounting device, set the spacer bracket into the depression on the side of the thin client.

---

 **NOTE:** The VESA 100 mm mounting holes are recessed 2 mm below the surface of the chassis side panel. Some models will include a 2 mm spacer bracket to assist with the installation of a mounting device. If your model does not include the spacer bracket, you should still be able to install your VESA 100 mounting device to the thin client.

If the system includes a 2 mm spacer bracket and is configured in the horizontal orientation, the spacer bracket may be stored on the inside of the VESA cover. Place the spacer bracket in the center of the VESA cover and twist it slightly to lock it into the VESA cover for storage.

---



8. Attach the mounting device to the thin client according to the directions included with your mounting device.



## Supported orientation and placement

**CAUTION:** If the thin client has been in operation, the metal plate underneath the side cover can reach temperatures that may cause discomfort if directly touched. The thin client should be turned off and allowed to cool for 20 minutes to come to room temperature before removing the wall mount kit.

**IMPORTANT:** You must adhere to the HP-supported orientation guidelines to ensure that your thin client functions properly.

Unless the thin client is mounted with an approved VESA 100 mm mounting bracket, you must operate it with the stand attached to ensure proper airflow around the system.

HP thin clients are uniquely designed to be set up and oriented in six different positions in order to support any possible deployment scenario.

- **Vertical Plus:** This is the typical vertical deployment orientation on a desktop or other flat surface with the system stand attached to the bottom of the thin client and the HP logo oriented right side up. You can also use Vertical Plus orientation to mount the thin client to a vertical flat surface with a mounting bracket.



- **Vertical Minus:** This orientation would typically be used to mount the thin client to a vertical flat surface with the HP logo positioned at the bottom in an upside down orientation.



- **Horizontal Plus:** This is the typical orientation for setting the thin client on a horizontal flat surface, such as a desktop, with the system stand attached to the side of the unit.



- **Horizontal Minus:** This is the typical orientation used when mounting the thin client underneath a horizontal flat surface using a mounting bracket to attach the unit to the under side of the flat surface, such as a desktop.



- **Bezel Plus:** This orientation is used to mount the thin client on a vertical flat surface, such as a wall, so that the front Input/Output ports and system power button are facing up.



- **Bezel Minus:** In this orientation, the thin client is mounted to a vertical flat surface so that the rear Input/Output ports are facing up.



## Unsupported placement

HP does not support the following placements for the thin client.

 **IMPORTANT:** Unsupported placement of thin clients could result in operation failure, damage to the devices, or both.

Thin clients require proper ventilation to maintain operating temperature. Do not block the vents.

Do not put thin clients in drawers or other sealed enclosures. Do not place a monitor or other object on top of the thin client. Do not mount a thin client between the wall and a monitor unless you are using an approved dual VESA mounting adapter specifically designed for this mounting scenario. Thin clients require proper ventilation to maintain operating temperatures.

- In a desk drawer:



- With a monitor on the thin client:



## Connecting the AC adapter and power cord

1. Connect the power cord to the AC adapter (1).
2. Connect the power cord to an AC outlet (2).
3. Connect the AC adapter to the thin client (3).



## Routine thin client care

Use the following information to properly care for your thin client:

- Never operate the thin client with the outside panel removed.
- Keep the thin client away from excessive moisture, direct sunlight, and extreme heat and cold. For information about the recommended temperature and humidity ranges for the thin client, go to <http://www.hp.com/go/quickspecs>.
- Keep liquids away from the thin client and keyboard.
- Turn off the thin client and wipe the exterior with a soft, damp cloth as needed. Using cleaning products may discolor or damage the finish.

---

## 2 Hardware Changes

### Warnings and cautions

Before performing upgrades be sure to carefully read all of the applicable instructions, cautions, and warnings in this guide.

---

 **WARNING!** To reduce the risk of personal injury or equipment damage from electric shock, hot surfaces, or fire:

Energized and moving parts are inside. Disconnect power to the equipment before removing the enclosure.

Allow the internal system components to cool before you touch them.

Replace and secure the enclosure before re-energizing the equipment.

Do not plug telecommunications or telephone connectors into the network interface controller (NIC) receptacles.

Do not disable the power cord grounding plug. The grounding plug is an important safety feature.

Plug the power cord into a grounded (earthed) AC outlet that is easily accessible at all times.

To reduce the risk of serious injury, read the *Safety & Comfort Guide* provided with your user guides. It describes proper workstation setup and proper posture, health, and work habits for computer users. The *Safety & Comfort Guide* also provides important electrical and mechanical safety information. The *Safety & Comfort Guide* is also available on the Web at <http://www.hp.com/ergo>.

 **IMPORTANT:** Static electricity can damage the electrical components of the thin client or optional equipment. Before beginning the following procedures, be sure that you are discharged of static electricity by briefly touching a grounded metal object. See [Preventing electrostatic damage on page 53](#) for more information.

When the thin client is plugged into an AC power source, voltage is always applied to the system board. You must disconnect the power cord from the power source before opening the thin client to prevent damage to internal components.

---

### Removing and replacing the access panel

**Table 2-1** Burn hazard warning

---

| Burn hazard warning   |  |
|---|--|
|  | <b>CAUTION:</b> Burn hazard! To avoid potential burns, wait 20 minutes after turning off the thin client before removing and replacing the access panel. |

---

## Removing the access panel

**⚠ WARNING!** To reduce the risk of personal injury or equipment damage from electric shock, hot surfaces, or fire, *always* operate the thin client with the access panel in place. In addition to enhancing safety, the access panel may provide important instructions and identification information, which may be lost if the access panel is not used. *Do not* use any access panel except the one that is provided by HP for use with this thin client.

Before removing the access panel, be sure that the thin client is turned off and the power cord is disconnected from the AC outlet.

To remove the access panel:

1. Remove any security devices that prohibit opening the thin client.
2. Remove all removable media, such as USB flash drives, from the thin client.
3. Turn off the thin client properly through the operating system, and then turn off any external devices.
4. Disconnect the power cord from the AC outlet, and disconnect any external devices.

**📄 IMPORTANT:** Regardless of the power-on state, voltage is always present on the system board as long as the system is plugged into an active AC outlet. You must disconnect the AC power cord to avoid damage to the internal components of the thin client.

5. Remove the stand or mounting bracket from the thin client if necessary.
6. Lay the thin client flat on a stable surface with the right side up.
7. Release the latch (1) on the left side of the rear I/O panel, rotate the I/O panel (2) to the right, and then pull it off the thin client.



8. Press the access panel latch (1) to release the access panel.

9. Rotate the rear of the access panel (2) up, and then lift the front of the access panel (3) up and off the chassis.

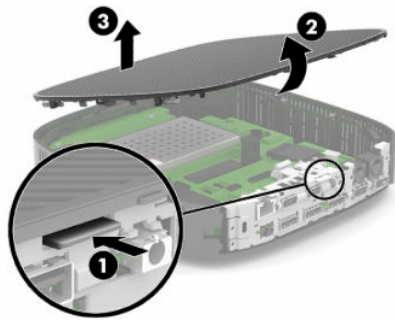

## Replacing the access panel

To replace the access panel:

1. Angle the access panel with the hinged side into the front of the system (1), and then rotate the rear of the access panel down (2) so that it snaps in place.

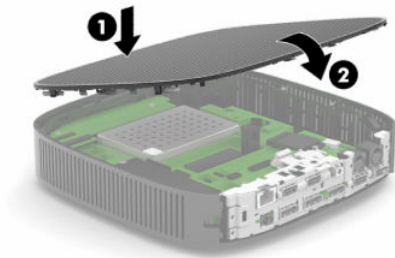

2. Insert the hooks on the right side of the rear I/O panel (1) into the right side of the back of the chassis, rotate the left side (2) to the chassis, and then press it to the chassis until it locks in place.

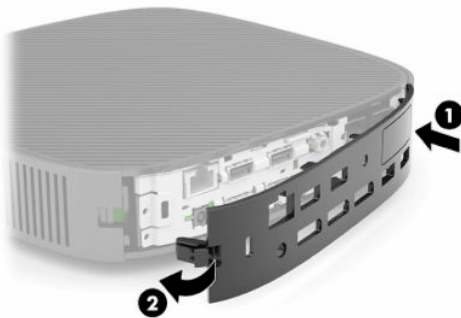

3. Replace the thin client stand or mounting bracket if removed.
4. Reconnect the power cord and turn on the thin client.
5. Lock any security devices that were disengaged when the thin client access panel was removed.

## Locating internal components

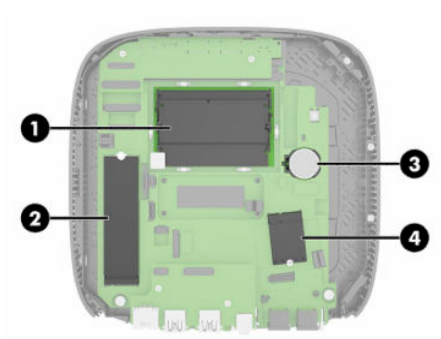

**Table 2-2 Internal components**

| Components |                                |
|------------|--------------------------------|
| (1)        | DDR4 SDRAM Memory (2 SODIMMs)  |
| (2)        | M.2 flash storage module       |
| (3)        | Battery                        |
| (4)        | WLAN card (select models only) |

## Removing and replacing the M.2 flash storage module

To remove the M.2 flash storage module:

1. Remove any security devices that prohibit opening the thin client.
2. Remove all removable media, such as USB flash drives, from the thin client.
3. Turn off the thin client properly through the operating system, and then turn off any external devices.
4. Disconnect the power cord from the AC outlet, and disconnect any external devices.

 **IMPORTANT:** Regardless of the power-on state, voltage is always present on the system board as long as the system is plugged into an active AC outlet. You must disconnect the AC power cord to avoid damage to the internal components of the thin client.

5. Remove the stand or mounting bracket from the thin client.
6. Lay the unit flat on a stable surface.
7. Remove the thin client access panel. See [Removing and replacing the access panel on page 13](#).

 **CAUTION:** To reduce risk of personal injury from hot surfaces, allow the internal system components to cool before you touch them.

8. Locate the M.2 socket for the flash storage module on the system board.
9. Loosen the screw securing the flash storage module until the end of the module can be raised.



10. Pull the flash storage module out of the socket.

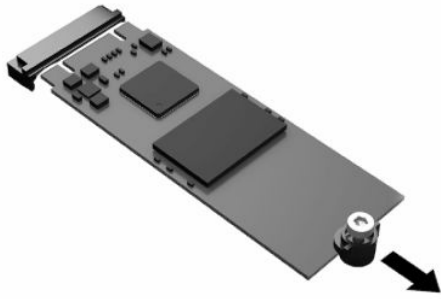

11. Pull the screw kit off of the flash storage module and attach it to the replacement flash storage module.



12. Slide the new flash storage module into the M.2 socket on the system board and press the module connectors firmly into the socket.

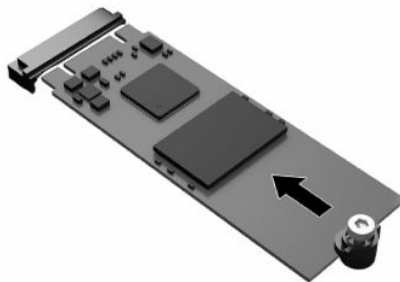

---

 **NOTE:** A flash storage module can be installed in only one way.

---

13. Press the flash storage module down, and use a screwdriver to tighten the screw and secure the module to the system board.

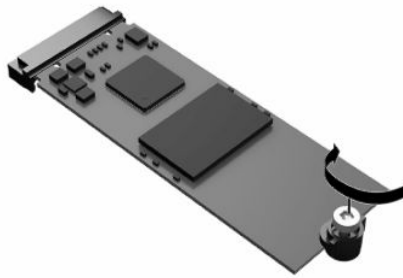

14. Replace and latch the access panel, and then reinstall the rear I/O panel. See [Removing and replacing the access panel on page 13](#).
15. Replace the thin client stand or mounting bracket.
16. Reconnect the power cord and turn on the thin client.
17. Lock any security devices that were disengaged when the thin client access panel was removed.

## Removing and replacing the battery

To remove and replace the battery:

1. Remove any security devices that prohibit opening the thin client.
2. Remove all removable media, such as USB flash drives, from the thin client.
3. Turn off the thin client properly through the operating system, and then turn off any external devices.
4. Disconnect the power cord from the AC outlet, and disconnect any external devices.

---

 **IMPORTANT:** Regardless of the power state, voltage is always present on the system board as long as the system is plugged into an active AC outlet. You must disconnect the AC power cord to avoid damage to the internal components of the thin client.

---

5. Remove the stand or mounting bracket from the thin client.
6. Lay the unit flat on a stable surface.
7. Remove the thin client access panel. See [Removing and replacing the access panel on page 13](#).

---

 **CAUTION:** To reduce risk of personal injury from hot surfaces, allow the internal system components to cool before you touch them.

---

8. Locate the battery on the system board. See [Locating internal components on page 16](#).

9. To release the battery from its holder, squeeze the metal clamp (1) that extends above one edge of the battery. When the battery pops up, lift it out (2).





10. To insert the new battery, slide one edge of the replacement battery under the holder's lip (1) with the positive side up. Push the other edge down until the clamp snaps over the other edge of the battery (2).



11. Replace and latch the access panel, and then reinstall the rear I/O panel. See [Removing and replacing the access panel on page 13](#).
12. Replace the thin client stand or mounting bracket.
13. Reconnect the power cord and turn on the thin client.
14. Lock any security devices that were disengaged when you removed the thin client access panel.

HP encourages customers to recycle used electronic hardware, HP original print cartridges, and rechargeable batteries. For more information about recycling programs, go to <http://www.hp.com> and search for “recycle.”

**Table 2-3 Battery icon definitions**

| Icon  | Definition  |
|---|---|
|  | Do not dispose of batteries, battery packs, and accumulators with the general household waste. For recycling or proper disposal, use the public collection system or return them to HP, an authorized HP partner, or their agents.  |
|  | The Taiwan EPA requires dry battery manufacturing or importing firms, in accordance with Article 15 or the Waste Disposal Act, to indicate the recovery marks on the batteries used in sales, giveaways, or promotions. Contact a qualified Taiwanese recycler for proper battery disposal. |

## Upgrading system memory

The memory sockets on the system board can be populated with up to two industry-standard SODIMMs. These memory sockets are populated with at least one preinstalled SODIMM. To achieve the maximum system performance, HP recommends the unit be configured for dual-channel memory by populating both SODIMM slots with a SODIMM memory module.

For proper system operation, the memory modules must adhere to the following specifications:

- Industry-standard 260-pin Small Outline DIMM (SODIMM)
- Unbuffered non-ECC DDR4 SDRAM
- Contain the mandatory Joint Electronic Device Engineering Council (JEDEC) specification

The thin client supports the following:

- 4 GB, 8 GB, and 16 GB non-ECC memory modules
- Single-sided and double-sided SODIMMS



**NOTE:** The system does not operate properly when an unsupported memory module is installed.

**Table 2-4 Recommended memory support for monitors**

| Windows® 10 IoT RS5                         | FHD<br>1920 × 1080 @ 60 Hz | UHD / 4K<br>3840 × 2160 @ 60 Hz |
|---|----------------------------|---------------------------------|
| <b>Memory configuration</b>                 | single/dual channel        | dual channel                    |
| <b>Maximum number of supported monitors</b> | 3                          | 3                               |
| <b>1080p video playback</b>                 | yes                        | yes                             |
| <b>4K video playback</b>                    | yes                        | yes                             |

**NOTE:** HP recommends dual-channel memory for 4K monitors for optimized performance.

## Removing and installing a memory module

 **IMPORTANT:** You must unplug the power cord and wait approximately 30 seconds for the power to drain before adding or removing the memory module. Regardless of the power state, voltage is always supplied to the memory module as long as the thin client is plugged into an active AC outlet. Adding or removing the memory module while voltage is present may cause irreparable damage to the memory module or system board.

The memory module socket has gold-plated metal contacts. When upgrading the memory, use a memory module with gold-plated metal contacts to prevent corrosion, oxidation, or both resulting from having incompatible metals in contact with each other.

Static electricity can damage the electronic components of the thin client. Before beginning the following procedures, be sure that you are discharged of static electricity by briefly touching a grounded metal object. For more information, see [Electrostatic discharge on page 53](#).

When handling a memory module, be careful not to touch any of the contacts. Doing so may damage the module.

1. Remove any security devices that prohibit opening the thin client.
2. Remove all removable media, such as USB flash drives, from the thin client.
3. Turn off the thin client properly through the operating system, and then turn off any external devices.
4. Disconnect the power cord from the AC outlet, and disconnect any external devices.

 **IMPORTANT:** Regardless of the power state, voltage is always present on the system board as long as the system is plugged into an active AC outlet. You must disconnect the AC power cord to avoid damage to the internal components of the thin client.

5. Remove the stand or mounting bracket from the thin client.
6. Lay the unit flat on a stable surface.
7. Remove the thin client access panel. See [Removing and replacing the access panel on page 13](#).

 **CAUTION:** To reduce risk of personal injury from hot surfaces, allow the internal system components to cool before you touch them.

8. Locate the memory module sockets on the system board. See [Locating internal components on page 16](#).
9. Remove the memory module shield.

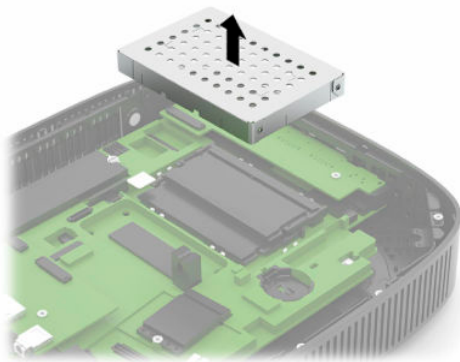

10. To remove the memory module, press outward on the latches on each side of the memory module (1), rotate the memory module up, and then pull the memory module out of the socket (2).



11. Slide the new memory module (1) into the socket at approximately a 30° angle, and then press the memory module down (2) so that the latches lock it in place.



---

 **NOTE:** A memory module can be installed in only one way. Match the notch on the module with the tab on the memory socket.

---

12. Replace the memory module shield.

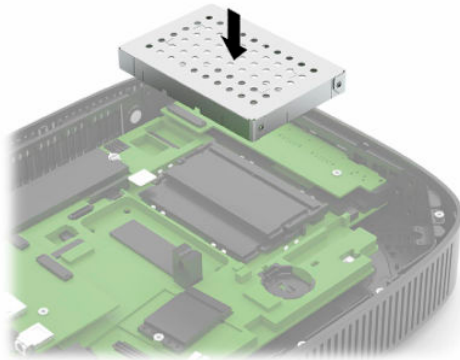

13. Replace and latch the access panel, and then reinstall the rear I/O panel. See [Removing and replacing the access panel on page 13](#).
14. Replace the thin client stand or mounting bracket.
15. Reconnect the power cord and turn on the thin client.
16. Lock any security devices that were disengaged when you removed the thin client access panel.

The thin client automatically recognizes the new memory when you turn on the thin client.

## Replacing a WLAN card

1. Remove any security devices that prohibit opening the thin client.
2. Remove all removable media, such as USB flash drives, from the thin client.
3. Turn off the thin client properly through the operating system, and then turn off any external devices.
4. Disconnect the power cord from the AC outlet, and disconnect any external devices.

 **IMPORTANT:** Regardless of the power-on state, voltage is always present on the system board as long as the system is plugged into an active AC outlet. You must disconnect the AC power cord to avoid damage to the internal components of the thin client.

5. Remove the stand or mounting bracket from the thin client.
6. Lay the unit flat on a stable surface.
7. Remove the thin client access panel. See [Removing and replacing the access panel on page 13](#).

 **CAUTION:** To reduce risk of personal injury from hot surfaces, allow the internal system components to cool before you touch them.

8. Locate the WLAN card on the system board. See [Locating internal components on page 16](#).
9. Disconnect the cables (1) from the WLAN card, remove the screw (2) that secures the WLAN card, and then pull the WLAN card out of its socket (3).

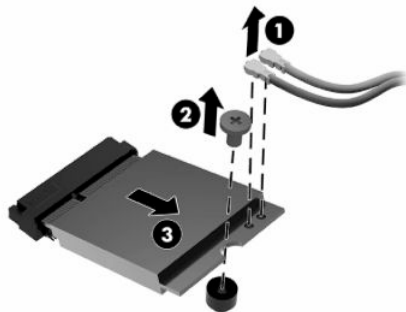

10. Insert the WLAN card into its socket (1), install the screw to secure the WLAN card (2), and then connect the cables to the WLAN card (3).

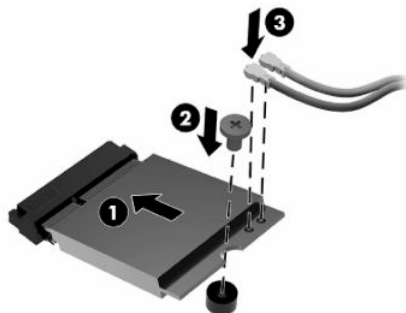

11. Replace and latch the access panel, and then reinstall the rear I/O panel. See [Removing and replacing the access panel on page 13](#).
12. Replace the thin client stand or mounting bracket.

13. Reconnect the power cord and turn on the thin client.
14. Lock any security devices that were disengaged when the thin client access panel was removed.



---

# 3 Troubleshooting

## Computer Setup (F10) Utility, BIOS Settings

### Computer Setup (F10) Utility

Use Computer Setup (F10) Utility to do the following tasks:

- Change factory default settings.
- Set the system date and time.
- Set, view, change, or verify the system configuration, including settings for processor, graphics, memory, audio, storage, communications, and input devices.
- Modify the boot order of bootable devices such as solid-state drives or USB flash drives.
- Select POST Messages Enabled or Disabled to change the display status of Power-On Self-Test (POST) messages. POST Messages Disabled suppresses most POST messages, such as memory count, product name, and other nonerror text messages. If a POST error occurs, the error is displayed regardless of the mode selected. To manually switch to POST Messages Enabled during POST, press any key (except **F1** through **F12**).
- Enter the Asset Tag or property identification number assigned by the company to this computer.
- Enable the power-on password prompt during system restarts (warm boots) as well as during power-on.
- Establish a setup password that controls access to the Computer Setup (F10) Utility and the settings described in this section.
- Secure integrated I/O functionality, including the USB, audio, or embedded NIC, so that they cannot be used until they are unsecured.

## Using Computer Setup (F10) Utility

You can access Computer Setup only by turning the computer on or restarting the system. To access the Computer Setup Utility menu, complete the following steps:

1. Turn on or restart the computer.
2. Press either **esc** or **F10** while the “Press the ESC key for Startup Menu” message is displayed at the bottom of the screen.

Pressing **esc** displays a menu that allows you to access different options available at startup.

 **NOTE:** If you do not press **esc** or **F10** at the appropriate time, you must restart the computer and again press **esc** or **F10** when the monitor light turns green to access the utility.

 **NOTE:** You can select the language for most menus, settings, and messages using the Language Selection option using the **F8** key in Computer Setup.

3. If you pressed **esc**, press **F10** to enter Computer Setup.

A choice of five headings appears in the Computer Setup Utility menu: File, Storage, Security, Power, and Advanced.

4. Use the arrow (left and right) keys to select the appropriate heading. Use the arrow (up and down) keys to select the option you want, and then press **enter**. To return to the Computer Setup Utility menu, press **esc**.
5. To apply and save changes, select **File > Save Changes and Exit**.
  - If you have made changes that you do not want applied, select **Ignore Changes and Exit**.
  - To reset to factory settings, select **Apply Defaults and Exit**. This option restores the original factory system defaults.

 **IMPORTANT:** To reduce the risk of corrupting the CMOS, do not turn the computer power off while the BIOS is saving the Computer Setup (F10) changes. It is safe to turn off the computer only after exiting the F10 Setup screen.

**Table 3-1 Computer Setup Utility menu options**

| Heading  | Table  |
|----------|--|
| File     | <a href="#">Computer Setup—File on page 27</a>     |
| Storage  | <a href="#">Computer Setup—Storage on page 28</a>  |
| Security | <a href="#">Computer Setup—Security on page 29</a> |
| Power    | <a href="#">Computer Setup—Power on page 30</a>    |
| Advanced | <a href="#">Computer Setup—Advanced on page 31</a> |

## Computer Setup—File



**NOTE:** Support for specific Computer Setup options can vary, depending on the hardware configuration.

**Table 3-2 Computer Setup—File**

| Option                      | Description   |
|-----------------------------|---|
| <b>System Information</b>   | Lists: <ul style="list-style-type: none"><li>• Product Name</li><li>• Memory Size</li><li>• PROCESSOR 1</li><li>• Processor Type</li><li>• Processor Speed</li><li>• Processor stepping</li><li>• Cache Size (L1/L2/L3)</li><li>• Processor Stepping</li><li>• Memory Speed Channel A and Channel B</li><li>• FIRMWARE</li><li>• System BIOS</li><li>• USB Type C PD FW</li><li>• Wake from Keyboard in S5 FW Version</li><li>• TPM FW Version</li><li>• SERVICE</li><li>• Chassis Serial Number</li><li>• SKU Number</li><li>• UUID</li><li>• Asset Tracking Number</li><li>• Asset Tracking Number</li><li>• Feature Byte</li><li>• Build ID</li><li>• Product Family</li><li>• System Board CT Number</li><li>• COMMUNICATION</li><li>• Integrated MAC</li></ul> |
| <b>About</b>                | Displays copyright notice.  |
| <b>BIOS Config. Utility</b> | Allows you to do the following tasks: <ul style="list-style-type: none"><li>• Save Current Setting to File in ESP</li><li>• Restore Former Setting from File in ESP</li></ul>   |
| <b>Flash System BIOS</b>    | Allows you to flash system BIOS from a USB recovery key.<br>Allows you to do the following tasks:   |

**Table 3-2 Computer Setup—File (continued)**

| Option                         | Description  |
|--------------------------------|--|
|                                | <ul style="list-style-type: none"> <li>• Update System BIOS from USB</li> <li>• Update USB Type C PD FW</li> <li>• Update TPM FW</li> <li>• Update Wake from Keyboard in S5 HOST FW</li> </ul> |
| <b>Set Time and Date</b>       | Allows you to set system time and date.  |
| <b>Default Setup</b>           | Allows you to do the following tasks: <ul style="list-style-type: none"> <li>• Save Current Settings as Default</li> <li>• Restore Factory Settings as Default</li> </ul>                      |
| <b>Apply Defaults and Exit</b> | Loads the original factory system configuration settings for use by a subsequent Apply Defaults and Exit action.   |
| <b>Ignore Changes and Exit</b> | Exits Computer Setup without applying or saving any changes.   |
| <b>Save Changes and Exit</b>   | Saves changes to system configuration or default settings and exits Computer Setup.  |

## Computer Setup—Storage

**Table 3-3 Computer Setup—Storage**

| Option                      | Description   |
|-----------------------------|---|
| <b>Device Configuration</b> | Lists all installed BIOS-controlled storage devices. When a device is selected, detailed information and options are displayed. The following options may be presented:<br><br><b>Hard Disk:</b> Size, model.   |
| <b>Storage Options</b>      | <b>External USB Storage Boot</b><br><br>Allows you to set USB storage device default boot option in CSM or Legacy mode.   |
| <b>Boot Order</b>           | Allows you to do the following tasks: <ul style="list-style-type: none"> <li>• Specify the order in which EFI boot sources (such as an internal drive, USB hard drive, or USB optical drive) are checked for a bootable operating system image. Each device on the list may be individually excluded from or included for consideration as a bootable operating system source. EFI boot sources always have precedence over legacy boot sources.</li> <li>• Specify the order in which legacy boot sources (such as a network interface card, internal drive, or USB optical drive) are checked for a bootable operating system image. Each device on the list may be individually excluded from or included for consideration as a bootable operating system source.</li> <li>• Specify the order of attached hard drives. The first hard drive in the order will have priority in the boot sequence and will be recognized as drive C (if any devices are attached).</li> </ul> <p><b>NOTE:</b> You can use <b>F5</b> to disable individual boot items, as well as disable EFI boot, legacy boot, or both. MS-DOS drive lettering assignments may not apply after a non-MS-DOS operating system has started.</p> <p><b>Shortcut to Temporarily Override Boot Order</b></p> <p>To boot <b>one time</b> from a device other than the default device specified in Boot Order, restart the computer and press <b>esc</b> (to access the boot menu) and then <b>F9</b> (Boot Order), or only <b>F9</b> (skipping the boot menu) when the monitor light turns green. After POST is completed, a list of bootable devices is displayed. Use the arrow keys to select the preferred bootable device and press <b>enter</b>. The computer then boots from the selected device for this one time.</p> |

## Computer Setup—Security



**NOTE:** Support for specific Computer Setup options can vary, depending on the hardware configuration.

**Table 3-4 Computer Setup—Security**

| Option  | Description   |
|---|---|
| <b>Setup Password</b>   | Allows you to set and enable a setup (administrator) password.<br><br><b>NOTE:</b> If the setup password is set, you must change Computer Setup options, flash the ROM, and make changes to certain Plug and Play settings under Windows.   |
| <b>Power-On Password</b>  | Allows you to set and enable a power-on password. The power-on password prompt appears after a power cycle or reboot. If the user does not enter the correct power-on password, the thin client will not boot.  |
| <b>Password Options</b><br><br>(This selection appears only if a power-on password or setup password is set.) | Allows you to enable/disable: <ul style="list-style-type: none"><li>• Stringent Password—When set, enables a mode in which there is no physical bypass of the password function. If enabled, removing the password jumper will be ignored.</li><li>• Password Prompt on F9 &amp; F12—Default is enabled.</li><li>• Setup Browse Mode—Allows viewing, but not changing, the F10 Setup Options without entering setup password. Default is enabled.</li></ul> |
| <b>Device Security</b>  | Allows you to set Device Available or Device Hidden (default is Device Available) for the following: <ul style="list-style-type: none"><li>• System Audio</li><li>• Network Controller</li><li>• M.2 Storage</li><li>• Onboard LAN DASH (Default Disabled)</li><li>• Data Execution Prevention (Default Enabled)</li><li>• Virtualization Technology VTx</li><li>• TPM Device</li><li>• TPM State</li><li>• Clear TPM</li></ul>                             |
| <b>USB Security</b>   | Allows you to set Enabled or Disabled (default is Enabled) for: <ul style="list-style-type: none"><li>• Front USB Ports<ul style="list-style-type: none"><li>– USB Port 1</li><li>– USB Port 2</li><li>– USB Port 3</li></ul></li><li>• Rear USB Ports<ul style="list-style-type: none"><li>– USB Port 4</li><li>– USB Port 5</li><li>– USB Port 6</li><li>– USB Port 7</li></ul></li></ul>   |
| <b>Slot Security</b>  | Allows you to disable the M.2 PCI Express slot. Default is Enabled. <ul style="list-style-type: none"><li>• Slot #—M.2 PCIe x1</li></ul>  |

**Table 3-4 Computer Setup—Security (continued)**

| Option                           | Description   |
|----------------------------------|---|
| <b>Network Boot</b>              | Enables or disables the computer's ability to boot from an operating system installed on a network server. (Feature available on NIC models only; the network controller must be either a PCI expansion card or embedded on the system board.) Default is Enabled.  |
| <b>System IDs</b>                | Allows you to set the following: <ul style="list-style-type: none"> <li>Asset tag (18-byte identifier)—A property identification number assigned by the company to the computer.</li> <li>Ownership tag (80-byte identifier)</li> </ul>   |
| <b>Memory Security</b>           | AMD Transparent Secure Memory Encryption (enable/disable) – Allows you to turn on or turn off the AMD Transparent Secure Memory Encryption function.  |
| <b>System Security</b>           | Provides these options: <ul style="list-style-type: none"> <li>Virtualization Technology (enable/disable)—Controls the virtualization features of the processor. Changing this setting requires turning the computer off and then back on. Default is disabled.</li> <li>TPM Device—Lets you set the Trusted Platform Module as available or hidden.</li> <li>TPM State—Select to enable the TPM.</li> <li>Clear TPM—Select to reset the TPM to an unowned state. After the TPM is cleared, it is also turned off. To temporarily suspend TPM operations, turn the TPM off instead of clearing it.</li> </ul> <p><b>IMPORTANT:</b> Clearing the TPM resets it to factory defaults and turns it off. You will lose all created keys and data protected by those keys.</p>  |
| <b>Secure Boot Configuration</b> | The options on this setup page are only for Windows 10 and other operating systems that support Secure Boot. Changing the default setting of the setup options on this page for operating systems that do not support secure boot may prevent the system from booting successfully. <p>Legacy Support (Enable or Disable)—Enable or disable the legacy operating system support (Windows 10 IoT and HP Thin-Pro).</p> <p>Secure Boot (Enable or Disable)—When the Legacy Support set to Disable, this item can be set to Enable. This item is for Secure Boot flow control. Secure boot is possible only if system is run in user mode.</p> <p>Key Management</p> <ul style="list-style-type: none"> <li>Clear Secure Boot Keys (Clear or Don't Clear). Lets you clear the Secure Boot Key.</li> <li>Key ownership (HP keys or Customer keys). Lets you change the keys of different owners.</li> </ul> <p>Fast Boot (Enable or Disable)—Enable Fast Boot causes system boot by initializing a minimal set of devices which is required to launch the active boot option. This option has no effect for BBS boot options.</p> |

## Computer Setup—Power



**NOTE:** Support for specific Computer Setup options can vary, depending on the hardware configuration.

**Table 3-5 Computer Setup—Power**

| Option                     | Description   |
|----------------------------|---|
| <b>OS Power Management</b> | Runtime Power Management (Enable or Disable)—Allows certain operating systems to reduce processor voltage and frequency when the current software load does not require the full capabilities of the processor. Default is Enabled. |

**Table 3-5 Computer Setup—Power (continued)**

| Option                           | Description  |
|----------------------------------|--|
|                                  | Idle Power Savings (Extended or Normal)—Allows certain operating systems to decrease the processor's power consumption when the processor is idle. Default is Extended.        |
| <b>Hardware Power Management</b> | S5 Maximum Power Savings—Turns off power to all nonessential hardware when system is off to meet EUP Lot 6 requirement of less than 0.5 watt power usage. Default is Disabled. |

## Computer Setup—Advanced



**NOTE:** Support for specific Computer Setup options can vary, depending on the hardware configuration.

**Table 3-6 Computer Setup—Advanced**

| Option                  | Heading   |
|-------------------------|---|
| <b>Power-On Options</b> | <p>Allows you to make the following settings:</p> <ul style="list-style-type: none"> <li>• POST messages (enable/disable)—Default is disabled.</li> <li>• Press the ESC key for Startup Menu (Displayed or Hidden).</li> <li>• After Power Loss (off/on/previous state)—Default is Power off. Set this option as follows: <ul style="list-style-type: none"> <li>• Power off—Causes the computer to remain turned off when power is restored.</li> <li>• Power on—Causes the computer to turn on automatically as soon as power is restored.</li> <li>• Previous state—Causes the computer to turn on automatically as soon as power is restored, if it was on when power was lost.</li> </ul> </li> </ul> <p><b>NOTE:</b> If you turn off power to the computer using the switch on a power strip, you cannot use the suspend/sleep feature or the Remote Management features.</p> <ul style="list-style-type: none"> <li>• POST Delay (in seconds)—Enabling this feature adds a user-specified delay to the POST process. This delay is sometimes needed for hard disks on some PCI cards that spin up so slowly that they are not ready to boot by the time POST is finished. The POST delay also gives you more time to select <b>F10</b> to enter Computer (F10) Setup. Default is None.</li> <li>• Bypass F1 Prompt on Configuration Changed—Enabling this feature turns off the requirement to press the <b>F1</b> key when rebooting the computer after a configuration change.</li> <li>• Remote Wakeup Boot Source (Local Hard Drive or Remote Server). Allows you to set the source from which the computer gets its boot files when remotely awakened.</li> <li>• Wake From Keyboard in S5—Allows you to turn on or turn off the alt-P + alt-esc hot key to wake up the system from S5 function.</li> </ul> |
| <b>BIOS Power-On</b>    | Allows you to set the computer to turn on automatically at a time you specify.  |
| <b>Bus Options</b>      | <p>On some models, allows you to enable or disable the following options:</p> <ul style="list-style-type: none"> <li>• PCI SERR# Generation. Default is enabled.</li> <li>• PCI VGA Palette Snooping, which sets the VGA palette snooping bit in PCI configuration space; only needed when more than one graphics controller is installed. Default is Disabled.</li> </ul>  |
| <b>Device Options</b>   | <ul style="list-style-type: none"> <li>• Integrated Graphics (Auto or Force)—Use this option to manage integrated (UMA) graphics memory allocation. The value you choose allocates memory permanently to graphics and is unavailable to the operating system. For example, if you set this value to 512 MB on a system with 2 GB of RAM, the system always allocates 512 MB for graphics and the other 1.5 GB for use by the BIOS and operating system. Default is Auto, which sets UMA memory by the memory installed on the platform as follows: <ul style="list-style-type: none"> <li>– 2 GB: 128 MB</li> <li>– 4 GB: 256 MB</li> </ul> </li> </ul>   |

**Table 3-6 Computer Setup—Advanced (continued)**

| Option                          | Heading   |
|---------------------------------|---|
|                                 | <p>If you select Force, the UMA Frame Buffer Size option displays, which lets you set the UMA memory size allocation between 128 MB and 512 MB.</p> <ul style="list-style-type: none"> <li>• S5 Wake on LAN (Enable or Disable)</li> <li>• Num Lock State at Power-On (Off or On)</li> <li>• Prompt for Power-On Password on Wake on LAN (Enable or Disable)</li> <li>• Internal Speaker</li> </ul> |
| <b>Option ROM Launch Policy</b> | <p>Allows you to set the following:</p> <ul style="list-style-type: none"> <li>• PXE Option ROM (UEFI, Legacy PXE, or Do Not Launch)</li> <li>• M.2 PCIe Slot Option ROM Download (Enabled or Do Not Launch)</li> </ul>   |

## Changing BIOS Settings from the HP BIOS Configuration Utility (HPBCU)

You can change some BIOS settings locally within the operating system without going through the F10 utility. This table identifies the items that you can control with this method.

For more information about the HP BIOS Configuration Utility, see the *HP BIOS Configuration Utility (BCU) User Guide* at [www.hp.com](http://www.hp.com).

**Table 3-7 BIOS settings that can be changed in the operating system**

| BIOS setting                            | Default value        | Other values  |
|---|----------------------|---|
| Language                                | English              | Francais, Espanol, Deutsch, Italiano, Dansk, Suomi, Nederlands, Norsk, Portugues, Svenska, Japanese, Simplified Chinese |
| Set Time                                | 00:00                | 00:00:23:59   |
| Set Day                                 | 01/01/2011           | 01/01/2011 to current date  |
| Update USB Type-C PD FW                 | Postpone             | Now   |
| TPM2.0 FW Tool-less Update              | Disable              | Enable  |
| TPM Physical Present Check              | Prompt               | No Prompt   |
| Update Wake from Keyboard in S5 HOST FW | Disable              | Enable  |
| Default Setup                           | None                 | Save Current Settings as Default, Restore Factory Settings as Default   |
| Apply Defaults and Exit                 | Disable              | Enable  |
| USB Storage Boot                        | Before SSD           | After SSD   |
| UEFI Boot Sources                       | Windows Boot Manager | USB Floppy/CD, USB hard drive   |
| Legacy Boot Sources                     | USB floppy/CD        | Hard drive  |
| System Audio                            | Enable               | Disable   |
| Network Controller                      | Enable               | Disable   |
| M.2 Storage                             | Enable               | Disable   |



**Table 3-7 BIOS settings that can be changed in the operating system (continued)**

| BIOS setting                             | Default value | Other values  |
|--|---------------|---|
| Onboard LAN DASH                         | Disable       | Enable  |
| Front USB Ports                          | Enable        | Disable   |
| USB Port 1, 2, 3                         | Enable        | Disable   |
| Rear USB Ports                           | Enable        | Disable   |
| USB Port 4, 5, 6, 7                      | Enable        | Disable   |
| Slot # M.2 PCIe x1                       | Enable        | Disable   |
| Power-on from Keyboard                   | Alt+P         | Disable, alt, esc   |
| Network Boot                             | Enable        | Disable   |
| Asset Tracking Number                    |               |   |
| Ownership Tag                            |               |   |
| BIOS Update                              | Disable       | Auto, Force   |
| BIOS Image File Name                     |               |   |
| Update USB Type C PD FW                  | Disable       | Enable  |
| Update TPM FW                            | Disable       | Enable  |
| Update Wake from Keyboard in S5 HOST FW  | Disable       | Enable  |
| Data Execution Prevention                | Enable        | Disable   |
| Virtualization Technology                | Disable       | Enable  |
| TPM Device                               | Available     | Hidden  |
| TPM State                                | Enable        | Disable   |
| Clear TPM                                | Do not reset  | Reset   |
| Legacy Support                           | Enable        | Disable (Note: The default value varies, depending on the OS) |
| Secure Boot                              | Disable       | Enable (Note: The default value varies, depending on the OS)  |
| Clear Secure Boot Keys                   | Don't Clear   | Clear   |
| Key Ownership                            | HP Keys       | Custom Keys   |
| Fast Boot                                | Disable       | Enable (Note: The default value varies, depending on the OS)  |
| Setup Browse Mode                        | Enable        | Disable   |
| Password Prompt on F9 & F12              | Enable        | Disable   |
| Runtime Power Management                 | Enable        | Disable   |
| AMD Transparent Secure Memory Encryption | Enable        | Disable   |
| Idle Power Savings                       | Extended      | Normal  |
| S5 Maximum Power Savings                 | Disable       | Enable  |
| S5 Wake on LAN                           | Enable        | Disable   |

**Table 3-7 BIOS settings that can be changed in the operating system (continued)**

| <b>BIOS setting</b>                         | <b>Default value</b> | <b>Other values</b>              |
|---|----------------------|----------------------------------|
| POST Messages                               | Disable              | Enable                           |
| Press the ESC key for Startup Menu          | Displayed            | Hidden                           |
| After Power Loss                            | Off                  | On, Previous State               |
| POST Delay (in seconds)                     | None                 | 5, 10, 15, 20, 60                |
| Remote Wakeup Boot Source                   | Local Hard Drive     | Remote Server                    |
| Prompt for Power-On Password on Wake on LAN | Disable              | Enable                           |
| Power on Sunday – Saturday                  | Disable              | Enable                           |
| BIOS Power on Time (hh:mm)                  | 00:00                | 00:00:23:59                      |
| PCI SERR# Generation                        | Enable               | Disable                          |
| PCI VGA Palette Snooping                    | Disable              | Enable                           |
| Integrated Graphics                         | Auto                 | Disable, Force                   |
| UMA Frame Buffer Size                       | 256M                 | 256 MB, 512 MB, 1024 MB, 2048 MB |
| Num Lock State at Power- On                 | Off                  | On                               |
| PXE Option ROMs                             | UEFI                 | Legacy, Do Not Launch            |
| M.2 PCIE Slot Option ROM Download           | Enable               | Do Not Launch                    |

# Updating or restoring a BIOS

## HP Device Manager

You can use HP Device Manager to update the BIOS of a thin client. You can use a prebuilt BIOS add-on or can use the standard BIOS upgrade package with an HP Device Manager File and Registry template. For more information about HP Device Manager File and Registry templates, review the *HP Device Manager User Guide* found at [www.hp.com/go/hpdm](http://www.hp.com/go/hpdm).

## Windows BIOS flashing

You can use the BIOS Flash Update SoftPaq to restore or upgrade the system BIOS. Several methods for changing the BIOS firmware stored on your computer are available.

The BIOS executable file is a utility designed to flash the System BIOS in a Windows environment. To display the available options for this utility, launch the executable file under the Windows environment.

You can run the BIOS executable file with or without the USB storage device. If the system does not have a USB storage device installed, the system reboots after performing a BIOS update in a Windows environment.

## Linux® BIOS flashing

All BIOS flashing under ThinPro 6.x and later uses tool-less BIOS updates, in which the BIOS updates itself.

Use the following comments to flash a Linux BIOS:

- `hptc-bios-flash ImageName`  
Prepares the system to update the BIOS during the next restart. This command automatically copies the files into the correct location and prompts you to restart the thin client. This command requires that the tool-less update option in the BIOS settings is set to Auto. You can use `hpt-bios-cfg` to set the tool-less update option in the BIOS.
- `hptc-bios-flash -h`  
Displays a list of options.

## BitLocker Drive Encryption / BIOS Measurements

If you have Windows BitLocker Drive Encryption (BDE) enabled on your system, HP recommends that you temporarily suspend BDE before updating the BIOS. You should also obtain your BDE recovery password or recovery PIN before suspending BDE. After you flash the BIOS, you can resume BDE.

To make a change to BDE, select Start > Control Panel > BitLocker Drive Encryption, select **Suspend Protection** or **Resume Protection**, and then select **Yes**.

As a general rule, updating the BIOS modifies measurement values stored in the Platform Configuration Registers (PCRs) of the system's security module. Temporarily disable technologies that use these PCR values to ascertain platform health (BDE is one such example) before flashing the BIOS. After you update the BIOS, re-enable the functions and restart the system so that you can take new measurements.

## BootBlock Emergency Recovery Mode

In the event of a failed BIOS update (for example, if power is lost during an update), the System BIOS can become corrupted. BootBlock Emergency Recovery Mode detects this condition and automatically searches the root directory of the hard drive and any USB media sources for a compatible binary image. Copy the binary (.bin) file in the DOS Flash folder to the root of the storage device, and then turn on the system. After the recovery process locates the binary image, it attempts the recovery process. The automatic recovery continues until it successfully restores or updates the BIOS. If the system has a BIOS Setup password, you might have to use the Startup Menu/Utility submenu to flash the BIOS manually after providing the password. Sometimes there are restrictions on which BIOS versions may be installed on a platform. If the BIOS that was on the system had restrictions, then only allowable BIOS versions can be used for recovery.

## Updating the firmware for Wake-On-Specific-Key

You may need to update the firmware to enable the Wake-On-Specific-Key feature. To update the firmware:

1. Open the Computer Setup (F10) Utility. See [Using Computer Setup \(F10\) Utility on page 26](#) for details.
2. In the Computer Setup (F10) Utility, select the **File** menu, and then select **Flash System BIOS**.
3. Select **Wake from Keyboard in S5 HOST FW**. The next dialog box shows the current firmware version on your computer and the latest firmware version available. The current firmware version is displayed on the first line, **Working Wake from Keyboard in S5 FW version**. The newest firmware version available is displayed on the second line, **Wake from Keyboard in S5 FW version in BIOS ROM**.
4. If a new firmware version for you computer is available, select **Update USB Keyboard Controller FW**.

## Diagnostics and troubleshooting

### Lights

**Table 3-8** Diagnostics and troubleshooting lights

| Light              | Status  |
|--------------------|---|
| Power light is off | When the thin client is plugged into the wall socket and the power light is off, the thin client is turned off. However, the network can trigger a Wake On LAN event in order to perform management functions.  |
| Power light is on  | Displays during boot sequence and while the thin client is on. During boot sequence, hardware initialization is processed, and startup tests are performed on the following initializations: <ul style="list-style-type: none"><li>• Processor initialization</li><li>• Memory detection and initialization</li><li>• Video detection and initialization</li></ul> <p><b>NOTE:</b> If one of the tests fails, the thin client stops, but the light stays on.</p> <p><b>NOTE:</b> After the video subsystem initializes, anything that fails will have an error message.</p> |

**NOTE:** Network lights are located inside the network connector on the top-rear panel of the thin client. The lights are visible when the connector is installed. Blinking green indicates network activity, and amber indicates a 100 MB speed connection.

### Wake-on LAN

Wake-on LAN (WOL) allows a computer to be turned on or resumed from the sleep or hibernation state by a network message. You can enable or disable WOL in Computer Setup using the **S5 Wake on LAN** setting.

To enable or disable WOL:

1. Turn on or restart the computer.
2. Press either **esc** or **F10** while the “Press the ESC key for Startup Menu” message is displayed at the bottom of the screen.



**NOTE:** If you do not press **esc** or **F10** at the appropriate time, you must restart the computer and again press **esc** or **F10** when the monitor light turns green.

3. If you pressed **esc**, press **F10** to enter Computer Setup.
4. Navigate to **Advanced > Device Options**.

5. Set **S5 Wake on LAN** to either enabled or disabled.
6. Press **F10** to accept any changes.
7. Select **File > Save Changes and Exit**.

 **IMPORTANT:** The **S5 Maximum Power Savings** setting can affect wake-on LAN. If you enable this setting, wake-on LAN is disabled. This setting is found in Computer Setup at **Power > Hardware Management**.

## Power-on sequence

At power-on, the flash boot block code initializes the hardware to a known state, then performs basic power-on diagnostic tests to determine the integrity of the hardware. Initialization performs the following functions:

1. Initializes CPU and memory controller.
2. Initializes and configures all PCI devices.
3. Initializes video software.
4. Initializes the video to a known state.
5. Initializes USB devices to a known state.
6. Performs power-on diagnostics. For more information, see [Power-on diagnostic tests on page 37](#).

The thin client boots the operating system.

## Resetting the setup and power-on passwords

You can reset the setup and power-on passwords as follows:

1. Turn off the computer and disconnect the power cord from the power outlet.
2. Remove the rear cover and access panel.
3. Remove the password jumper from the system board header labeled PSWD/E49.
4. Replace the access panel and rear cover.
5. Connect the computer to power, and then turn on the computer.

## Power-on diagnostic tests

The Power-on diagnostics perform basic integrity tests of the hardware to determine its functionality and configuration. If a diagnostic test fails during hardware initialization, the thin client stops. No messages are sent to video.

 **NOTE:** You can try to restart the thin client and run through the diagnostic tests a second time to confirm the first shutdown.

The following table lists the tests that are performed on the thin client.

**Table 3-9 Power-on diagnostic test**

| Test                | Description  |
|---------------------|--|
| Boot Block Checksum | Tests boot block code for proper checksum value.                       |
| DRAM                | Performs a simple write/read pattern test of the first 640k of memory. |

**Table 3-9 Power-on diagnostic test (continued)**

| Test              | Description   |
|-------------------|---|
| Serial Port       | Performs a simple verification test of the serial port to determine if ports are present. |
| Timer             | Tests timer interrupt by using polling method.  |
| RTC CMOS battery  | Tests integrity of RTC CMOS battery.  |
| NAND flash device | Tests for proper NAND flash device ID present.  |

## Interpreting POST diagnostic front panel lights and audible codes

This section covers the front panel light codes as well as the audible codes that may occur before or during POST that do not necessarily have an error code or text message associated with them.

**⚠ WARNING!** When the computer is plugged into an AC power source, voltage is always applied to the system board. To reduce the risk of personal injury from electrical shock, hot surfaces, or both, be sure to disconnect the power cord from the wall outlet and allow the internal system components to cool before touching.

**📝 NOTE:** Recommended actions in the following table are listed in the order in which they should be performed.

Not all diagnostic lights and audible codes are available on all models.

Beeps are broadcast through the chassis speaker. Blinks and beeps repeat for five cycles, after which only the blinks repeat.

**Table 3-10 Interpreting POST diagnostic front panel lights and audible codes**

| Activity  | Beeps | Possible Cause   | Recommended Action   |
|---|-------|--|--|
| White power light is off.   | None  | Computer is off (S5).  | None   |
| White power light on.   | None  | Computer on.   | None   |
| White power light flashes every 2 seconds.  | None  | Computer in Suspend to RAM mode (some models only) or normal Suspend mode.   | No action required. Press any key or move the mouse to wake the computer.  |
| Red power light flashes two times, once every second, followed by a 2 second pause. | 2     | Processor thermal protection activated by either of the following methods:<br><br>The heat sink assembly is not properly attached to the processor.<br><br>OR<br><br>The computer has vents blocked or is in a location where the ambient temperature is too high. | <b>IMPORTANT:</b> Internal components might be powered even when the computer is off. To prevent damage, disconnect the power cord before you remove a component.<br><br><b>1.</b> Make sure that the computer air vents are not blocked and the processor cooling fan is plugged in and running.<br><br><b>2.</b> Open the access panel, press the power button, and verify that the processor fan is spinning. If the processor fan is not spinning, make sure the fan cable is plugged into the system board header. Ensure the fan is fully and properly seated or installed.<br><br><b>3.</b> If the fan is plugged in and seated properly but is not spinning, the problem might be in the processor fan. Contact HP for assistance. |

**Table 3-10 Interpreting POST diagnostic front panel lights and audible codes (continued)**

| Activity  | Beeps | Possible Cause  | Recommended Action  |
|---|-------|---|---|
|   |       |   | <ol style="list-style-type: none"> <li>Verify that the fan assembly is properly attached. If problems persist, there might be a problem with the processor heatsink. Contact HP for assistance.</li> </ol>  |
| Red power light flashes four times, once every second, followed by a 2 second pause.  | 4     | Power failure (power supply is overloaded).<br><br>OR<br><br>The incorrect external power supply adapter is being used on the computer. | <ol style="list-style-type: none"> <li>Check whether a device is causing the problem by removing all attached devices. Turn on the computer. If the computer enters the POST, then turn the computer off and replace one device at a time and repeat this procedure until failure occurs. Replace the device that is causing the failure. Continue adding devices one at a time to make sure that all devices are functioning properly.</li> <li>Replace the power supply.</li> <li>Replace the system board.</li> </ol>                        |
| Red power light flashes five times, once every second, followed by a 2 second pause.  | 5     | Prevideo memory error.  | <p><b>IMPORTANT:</b> To avoid damage to the memory modules or the system board, unplug the power cord before attempting to reseal, install, or remove a memory module.</p> <ol style="list-style-type: none"> <li>Reseat memory modules.</li> <li>Replace memory modules one at a time to isolate the faulty module.</li> <li>Replace third-party memory with HP memory.</li> <li>Replace the system board.</li> </ol>  |
| Red power light flashes six times, once every second, followed by a 2 second pause.   | 6     | Prevideo graphics error.  | <p>For systems with a graphics card:</p> <ol style="list-style-type: none"> <li>Reseat the graphics card.</li> <li>Replace the graphics card.</li> <li>Replace the system board.</li> </ol> <p>For systems with integrated graphics, replace the system board.</p>  |
| Red power light flashes eight times, once every second, followed by a 2 second pause. | 8     | Invalid ROM based on bad checksum.  | <ol style="list-style-type: none"> <li>Reflash the system ROM with the latest BIOS image using the BIOS Recovery procedure.</li> <li>Replace the system board.</li> </ol>   |
| System does not turn on and lights are not flashing.                                  | None  | System unable to turn on.   | <p>Press and hold the power button for less than 4 seconds. If the hard drive light turns white, the power button is working correctly. If not, try the following solutions:</p> <ol style="list-style-type: none"> <li>Remove the power cord from the computer.</li> <li>Open the computer and press the yellow CMOS button on the system board for 4 seconds.</li> <li>Verify that the power cord is plugged into the power supply.</li> <li>Close the computer and reattach the power cord.</li> <li>Try to turn on the computer.</li> </ol> |

**Table 3-10 Interpreting POST diagnostic front panel lights and audible codes (continued)**

| Activity | Beeps | Possible Cause | Recommended Action       |
|----------|-------|----------------|--------------------------|
|          |       |                | 6. Replace the computer. |

# Troubleshooting

## Basic troubleshooting

If the thin client is experiencing operating problems or will not turn on, review the following items.

**Table 3-11 Basic troubleshooting issues and solutions**

| Issue   | Procedures  |
|---|---|
| The thin client is experiencing operating problems.   | Ensure that the following connectors are securely plugged into the thin client:<br>Power connector, keyboard, mouse, network connector, display   |
| The thin client does not turn on.   | <ol style="list-style-type: none"> <li>1. Verify that the power supply is good by installing it on a known working thin client and testing it. If the power supply does not work on the test thin client, replace the power supply.</li> <li>2. If the thin client does not work properly with the replaced power supply, have the thin client serviced.</li> </ol>   |
| The thin client turns on and displays a splash screen, but does not connect to the server.  | <ol style="list-style-type: none"> <li>1. Verify that the network is operating and the network cable is working properly.</li> <li>2. Verify that the thin client is communicating with the server by having the system administrator ping the thin client from the server: <ul style="list-style-type: none"> <li>– If the thin client pings back, the signal was accepted, and the thin client is working. This indicates a configuration issue.</li> <li>– If the thin client does not ping back and the thin client does not connect to the server, re-image the thin client.</li> </ul> </li> </ol>  |
| There is no link or activity on the network lights, or the lights do not blink after you turn on the thin client. (The network lights are located inside the network connector on the top-rear panel of the thin client. Indicator lights are visible when the connector is installed.) | <ol style="list-style-type: none"> <li>1. Verify that the network is not down.</li> <li>2. Make sure the network cable is good by installing the network cable onto a known working device. If a network signal is detected then the cable is good.</li> <li>3. Verify that the power supply is good by exchanging the power cable to the thin client with a known working power supply cable and testing it.</li> <li>4. If network lights still do not light and you know the power supply is good, re-image the thin client.</li> <li>5. If network lights still do not light, run the IP configuration procedure.</li> <li>6. If network lights still do not light, have the thin client serviced.</li> </ol> |
| A newly connected unknown USB peripheral does not respond, or USB peripherals connected before the newly connected USB peripheral do not complete their device actions.   | You can disconnect and connect a USB peripheral to a running platform as long as you do not restart the system. If problems occur, disconnect the unknown USB peripheral and restart the platform.  |
| Video does not show anything.   | <ol style="list-style-type: none"> <li>1. Verify that the monitor brightness is set to a readable level.</li> <li>2. Verify that the monitor is good by connecting it to a known working computer, and confirm that its front light turns green (assuming the monitor is Energy Star compliant). If the monitor is defective, replace it with a working monitor and repeat testing.</li> </ol>  |



**Table 3-11 Basic troubleshooting issues and solutions (continued)**

| Issue | Procedures   |
|-------|--|
|       | <ol style="list-style-type: none"> <li>3. Re-image the thin client, and turn on the monitor again.</li> <li>4. Test the thin client on a known working monitor. If the monitor does not display video, replace the thin client.</li> </ol> |

## Diskless (no-flash) thin client troubleshooting

This section is only for those thin clients that do not have ATA Flash capability. Because there is no ATA Flash in this model, the boot priority sequence is:

- USB device
  - PXE
1. When the thin client boots, the monitor should display the following information.

**Table 3-12 Diskless (no flash) model troubleshooting issues and solutions**

| Item        | Information                           | Action   |
|-------------|---------------------------------------|--|
| MAC Address | NIC portion of the system board is OK | If no MAC Address, the system board is at fault. Contact the Call Center for service.  |
| GUID        | General system board information      | If no GUID information, the system board is at fault and should be replaced. Contact the Call Center for service for the bad system board.   |
| Client ID   | Information from server               | If no Client ID information, there is no network connection. This problem could be a bad cable, the server is down, or a bad system board. Contact the Call Center for service for the bad system board. |
| MASK        | Information from server               | If no MASK information, there is no network connection. This problem could be a bad cable, the server is down, or a bad system board. Contact the Call Center for service for the bad system board.      |
| DHCP IP     | Information from server               | If no DHCP IP information, there is no network connection. This problem could be a bad cable, the server is down, or a bad system board. Contact the Call Center for service for the bad system board.   |

2. If you are running in a Microsoft® RIS PXE environment, go to step 3.  
If you are running in a Linux environment, go to step 4.
3. If you are running in a Microsoft RIS PXE environment, press the **F12** key to activate the network service boot as soon as the DHCP IP information appears on the screen.  
  
If the thin client does not boot to the network, the server is not configured to PXE.  
  
If you miss the F12 cue, the system tries to boot to the ATA flash that is not present. The message on the screen will read: **ERROR: Non-system disk or disk error. Replace and press any key when ready.**  
  
Pressing any key restarts the boot cycle.
4. If you are running in a Linux environment, an error message will appear on the screen if there is no Client IP: **ERROR: Non-system disk or disk error. Replace and press any key when ready.**

## Configuring a PXE server

 **NOTE:** All PXE software is supported by authorized service providers on a warranty or service contract basis. Customers who call the HP Customer Service Center with PXE issues and questions should be referred to their PXE provider for assistance.

Additionally, refer to the following documents:

– For Windows Server 2008 R2: <http://technet.microsoft.com/en-us/library/7d837d88-6d8e-420c-b68f-a5b4baeb5248.aspx>

– For Windows Server 2012: <http://technet.microsoft.com/en-us/library/jj648426.aspx>

The following services must be running, and they may be running on different servers:

1. Domain Name Service (DNS)
2. Remote Installation Services (RIS)

 **NOTE:** Active Directory DHCP is not required, but is recommended.

## Using HP ThinUpdate to restore the image

HP ThinUpdate allows you to download images and add-ons from HP, capture an HP thin client image, and create bootable USB flash drives for image deployment.

HP ThinUpdate is preinstalled on some HP thin clients, and it is also available as an add-on at <http://www.hp.com/support>. Search for the thin client model, and see the **Drivers & software** section of the support page for that model.

- The Image Downloads feature lets you download an image from HP to either local storage or a USB flash drive. The USB flash drive option creates a bootable USB flash drive that can be used to deploy the image to other thin clients.
- The Image Capture feature lets you capture an image from an HP thin client and save it to a USB flash drive, which can be used to deploy the image to other thin clients.
- The Add-on Downloads feature lets you download add-ons from HP to either local storage or a USB flash drive.
- The USB Drive Management feature lets you do the following tasks:
  - Create a bootable USB flash drive from an image file on local storage
  - Copy an .ibr image file from a USB flash drive to local storage
  - Restore a USB flash drive layout

You can use a bootable USB flash drive created with HP ThinUpdate to deploy an HP thin client image to another HP thin client of the same model with the same operating system.

### System requirements

To create a recovery device for the purpose of reflashing or restoring the software image on the flash, you need the following:

- One or more HP thin clients.
- USB flash drive in the following size or larger:

- ThinPro: 8 GB
- Windows 10 IoT (if using the USB format): 32 GB

 **NOTE:** Optionally, you can use the tool on a Windows computer.

**This restore method will not work with all USB flash drives.** USB flash drives that do not show up as a removable drive in Windows do not support this restore method. USB flash drives with multiple partitions generally do not support this restore method. The range of USB flash drives available on the market is constantly changing. Not all USB flash drives have been tested with the HP Thin Client Imaging Tool.

## Device management

The thin client includes a license for HP Device Manager and has a Device Manager agent preinstalled. HP Device Manager is a thin-client optimized management tool used to manage the full life cycle of HP thin clients to include Discover, Asset Management, Deployment and Configuration. For more information about HP Device Manager, please visit [www.hp.com/go/hpdm](http://www.hp.com/go/hpdm).

If you want to manage the thin client with other management tools such as SCCM or LANDesk, go to [www.hp.com/go/clientmanagement](http://www.hp.com/go/clientmanagement) for more information.

## Power cord set requirements

The wide-range input feature of the computer permits it to operate from any line voltage from 100 to 120 V ac, or from 220 to 240 V ac.

The 3-conductor power cord set included with the computer meets the requirements for use in the country or region where the equipment is purchased.

Power cord sets for use in other countries or regions must meet the requirements of the country and region where the computer is used.

## Requirements for all countries

The following requirements are applicable to all countries and regions:

- The length of the power cord set must be at least **1.0 m** (3.3 ft) and no more than **2.0 m** (6.5 ft).
- All power cord sets must be approved by an acceptable accredited agency responsible for evaluation in the country or region where the power cord set will be used.
- The power cord sets must have a minimum current capacity of 10 A and a nominal voltage rating of 125 V ac or 250 V ac, as required by the power system of each country or region.
- The appliance coupler must meet the mechanical configuration of an EN 60 320/IEC 320 Standard Sheet C13 connector for mating with the appliance inlet on the back of the computer.

## Requirements for specific countries and regions

**Table 3-13 Power cord requirements for specific countries and regions**

| Country/region                 | Accredited agency | Applicable note number |
|--------------------------------|-------------------|------------------------|
| Argentina                      | IRAM              | 1                      |
| Australia                      | SAA               | 1                      |
| Austria                        | OVE               | 1                      |
| Belgium                        | CEBEC             | 1                      |
| Brazil                         | ABNT              | 1                      |
| Canada                         | CSA               | 2                      |
| Chile                          | IMQ               | 1                      |
| Denmark                        | DEMKO             | 1                      |
| Finland                        | FIMKO             | 1                      |
| France                         | UTE               | 1                      |
| Germany                        | VDE               | 1                      |
| India                          | BIS               | 1                      |
| Israel                         | SII               | 1                      |
| Italy                          | IMQ               | 1                      |
| Japan                          | JIS               | 3                      |
| The Netherlands                | KEMA              | 1                      |
| New Zealand                    | SANZ              | 1                      |
| Norway                         | NEMKO             | 1                      |
| The People's Republic of China | CCC               | 4                      |
| Saudi Arabia                   | SASO              | 7                      |
| Singapore                      | PSB               | 1                      |
| South Africa                   | SABS              | 1                      |
| South Korea                    | KTL               | 5                      |
| Sweden                         | SEMKO             | 1                      |
| Switzerland                    | SEV               | 1                      |
| Taiwan                         | BSMI              | 6                      |
| Thailand                       | TISI              | 1                      |
| The United Kingdom             | ASTA              | 1                      |
| The United States              | UL                | 2                      |

1. The flexible cord must be Type H05VV-F, 3-conductor, 0.75 mm<sup>2</sup> conductor size. Power cord set fittings (appliance coupler and wall plug) must bear the certification mark of the agency responsible for evaluation in the country or region where it will be used.

**Table 3-13 Power cord requirements for specific countries and regions (continued)**

| Country/region | Accredited agency | Applicable note number   |
|----------------|-------------------|--|
|                |                   | 2. The flexible cord must be Type SVT/SJT or equivalent, No. 18 AWG, 3-conductor. The wall plug must be a two-pole grounding type with a NEMA 5-15P (15 A, 125 V ac) or NEMA 6-15P (15 A, 250 V ac) configuration. CSA or C-UL mark. UL file number must be on each element.   |
|                |                   | 3. The appliance coupler, flexible cord, and wall plug must bear a T mark and registration number in accordance with the Japanese Dentori Law. The flexible cord must be Type VCTF, 3-conductor, 0.75 mm <sup>2</sup> or 1.25 mm <sup>2</sup> conductor size. The wall plug must be a two-pole grounding type with a Japanese Industrial Standard C8303 (7 A, 125 V ac) configuration. |
|                |                   | 4. The flexible cord must be Type RVV, 3-conductor, 0.75 mm <sup>2</sup> conductor size. Power cord set fittings (appliance coupler and wall plug) must bear the CCC certification mark.   |
|                |                   | 5. The flexible cord must be Type H05VV-F 3-conductor, 0.75 mm <sup>2</sup> conductor size. KTL logo and individual approval number must be on each element. Corset approval number and logo must be printed on a flag label.  |
|                |                   | 6. The flexible cord must be Type HVCTF 3-conductor, 1.25 mm <sup>2</sup> conductor size. Power cord set fittings (appliance coupler, cable, and wall plug) must bear the BSMI certification mark.   |
|                |                   | 7. For 127 V ac, the flexible cord must be Type SVT or SJT 3-conductor, 18 AWG, with plug NEMA 5-15P (15 A, 125 V ac), with UL and CSA or C-UL marks. For 240 V ac, the flexible cord must be Type H05VV-F 3-conductor, 0.75 mm <sup>2</sup> or 1.0 mm <sup>2</sup> conductor size, with plug BS 1363/A with BSI or ASTA marks.  |

## Statement of volatility

Thin client products typically have three types of memory devices: RAM, ROM, and flash memory devices. Data stored in the RAM memory device will be lost when the power is removed from the device. RAM devices could be powered by main, aux, or battery power (as described in the following list). Therefore, even when the thin client is not connected to an AC outlet, some of the RAM devices could be powered by battery power. Data stored in the ROM or flash memory devices will not be lost, even if the power to the device is removed. Manufacturers of flash devices usually specify a period of time (on the order of 10 years) for data retention.

Definition of power states:

**Main Power:** Power available when the thin client is turned on.

**Aux or Standby power:** Power available when the thin client is in turned off when the power supply is connected to an active AC outlet.

**Battery Power:** Power from a coin battery present in the thin client systems.

## Available memory devices

The following table lists the available memory devices and their types per the models. Thin Client systems do not use traditional hard drives with moving parts. Instead, they use flash memory devices with an IDE/SATA front-end interface. Hence, the operating systems interface with these flash devices much as they do to a regular IDE/SATA hard drive. This IDE/SATA flash device contains the image of the operating system. The flash device can only be written to by an administrator. A special software tool is required to format the flash devices and clear the data stored in them.

Use the following steps to update BIOS and to return BIOS settings to factory default settings.

1. Download the latest BIOS for your model from the HP website.
2. Follow the instructions on the website to flash the BIOS.
3. Restart the system, and while system starts (after the HP splash screen, if displayed), press the **F10** key to enter the BIOS setup screen.
4. If the Ownership Tag or Asset Tag is set, manually clear it under **Security > System IDs**.

5. Select **File > Save Changes and Exit**.
6. To clear the Setup or Power-On passwords, if set, and clear any other settings, turn off the computer and remove the power cord and the computer hood.
7. Locate the black two-pin password jumper on header E49 (labeled PSWD) and remove it.
8. Remove AC power, wait 10 seconds until the power has drained out, and then press the Clear CMOS button. (This button is usually a yellow push button labeled CMOS). After reconnecting power, the system automatically boots to the operating system.
9. Replace the hood and power cord and turn the computer on. The passwords are now cleared and all other user-configurable, nonvolatile memory settings are reset to their factory default values.
10. Re-enter the F10 setup utility.
11. Select **File > Default Setup > Restore Factory Settings as Default**. This action sets the default settings back to the factory defaults.
12. Select **File > Apply Defaults and Exit**.
13. Shut down the computer, remove power cord, and then place the black jumper back on header E49. Replace the computer hood and power cord.

**Table 3-14 Available memory devices**

| Description            | Location/Size  | Power        | Loss of data                | Comments                                   |
|------------------------|--|--------------|-----------------------------|--|
| System Boot ROM (BIOS) | SPI ROM (128 Mb)<br>socketed, removable  |              |                             |  |
| System memory (RAM)    | SODIMM socket.<br>Removable (4 GB/8 GB/16 GB)                                  | Main power   | If main power is removed    | Only S0/S3/S5/G3 ACPI states are supported |
| RTC (CMOS) RAM         | RTC RAM is 256 byte<br>RAM Memory in Intel<br>embedded System on<br>Chip (SoC) | Main/battery | If battery power is removed |  |
| Keyboard/mouse (ROM)   | 2k bytes embedded in<br>the super I/O controller<br>(SIO18)                    | Main         |                             |  |
| Keyboard/mouse (RAM)   | 256 bytes embedded in<br>the super I/O controller<br>(SIO18)                   | Main         | If main power is removed    |  |
| LOM EEPROM             | Discrete 2 MB SPI ROM  | Aux          |                             | One Time programmable memory (OTP)         |
| TPM                    | 7206 bytes non-volatile<br>memory  | Main         |                             |  |

# Specifications

For the latest specifications or additional specifications on the thin client, go to <http://www.hp.com/go/quickspecs/> and search for your specific thin client to find the QuickSpecs.

| Item  | Metric               | U.S.          |
|---|----------------------|---------------|
| <b>Dimensions</b>   |                      |               |
| Width   | 35 mm                | 1.38 in.      |
| Depth   | 196 mm               | 7.72 in.      |
| Height  | 196 mm               | 7.72 in.      |
| <b>Weight</b>   | 995 g                | 2.2 lbs       |
| <b>Operating temperature</b>  | 10°C to 55°C         | 50°F to 131°F |
| Specifications are at sea level with altitude derating of 1°C/300 m (1.8°F/1000 ft) to a maximum of 3 km (10,000 ft), with no direct, sustained sunlight. Upper limit may be limited by the type and number of options installed. |                      |               |
| <b>Relative Humidity</b>  |                      |               |
| Condensing  | 20% to 80%           |               |
| Non-condensing  | 10% to 90%           |               |
| Specifications are at sea level with altitude derating of 1°C/300 m (1.8°F/1000 ft) to a maximum of 3 km (10,000 ft), with no direct, sustained sunlight. Upper limit may be limited by the type and number of options installed. |                      |               |
| <b>Power Supply</b>   |                      |               |
| Power output  | 45 W                 |               |
| Operating voltage range   | 100 V ac to 240 V ac |               |
| Rated line frequency  | 50 Hz to 60 Hz       |               |

---

## 4 Using HP PC Hardware Diagnostics

### Using HP PC Hardware Diagnostics Windows (select products only)

HP PC Hardware Diagnostics Windows is a Windows-based utility that allows you to run diagnostic tests to determine whether the computer hardware is functioning properly. The tool runs within the Windows operating system in order to diagnose hardware failures.

If HP PC Hardware Diagnostics Windows is not installed on your computer, first you must download and install it. To download HP PC Hardware Diagnostics Windows, see [Downloading HP PC Hardware Diagnostics Windows on page 48](#).

After HP PC Hardware Diagnostics Windows is installed, follow these steps to access it from HP Help and Support or HP Support Assistant.

1. To access HP PC Hardware Diagnostics Windows from HP Help and Support:
  - a. Select the **Start** button, and then select **HP Help and Support**.
  - b. Right-click **HP PC Hardware Diagnostics Windows**, select **More**, and then select **Run as administrator**.

– or –

To access HP PC Hardware Diagnostics Windows from HP Support Assistant:

- a. Type `support` in the taskbar search box, and then select the **HP Support Assistant** app.
    - or –
    - Select the question mark icon in the taskbar.
  - b. Select **Troubleshooting and fixes**.
  - c. Select **Diagnostics**, and then select **HP PC Hardware Diagnostics Windows**.
2. When the tool opens, select the type of diagnostic test you want to run, and then follow the on-screen instructions.



**NOTE:** If you need to stop a diagnostic test at any time, select **Cancel**.

---

When HP PC Hardware Diagnostics Windows detects a failure that requires hardware replacement, a 24-digit Failure ID code is generated. The screen displays one of the following options:

- A Failure ID link is displayed. Select the link and follow the on-screen instructions.
- A Quick Response (QR) code is displayed. With a mobile device, scan the code and then follow the on-screen instructions.
- Instructions for calling support are displayed. Follow those instructions.

### Downloading HP PC Hardware Diagnostics Windows

- The HP PC Hardware Diagnostics Windows download instructions are provided in English only.
- You must use a Windows computer to download this tool because only .exe files are provided.



## Downloading the latest HP PC Hardware Diagnostics Windows version

To download HP PC Hardware Diagnostics Windows, follow these steps:

1. Go to <http://www.hp.com/go/techcenter/pcdiags>. The HP PC Diagnostics home page is displayed.
2. Select **Download HP Diagnostics Windows**, and then select a location on your computer or a USB flash drive.

The tool is downloaded to the selected location.

## Downloading HP Hardware Diagnostics Windows by product name or number (select products only)

---

 **NOTE:** For some products, it may be necessary to download the software to a USB flash drive by using the product name or number.

---

To download HP PC Hardware Diagnostics Windows by product name or number, follow these steps:

1. Go to <http://www.hp.com/support>.
2. Select **Get software and drivers**, select your type of product, and then enter the product name or number in the search box that is displayed.
3. In the **Diagnostics** section, select **Download**, and then follow the on-screen instructions to select the specific Windows diagnostics version to be downloaded to your computer or USB flash drive.

The tool is downloaded to the selected location.

## Installing HP PC Hardware Diagnostics Windows

To install HP PC Hardware Diagnostics Windows, follow these steps:

- ▲ Navigate to the folder on your computer or the USB flash drive where the .exe file was downloaded, double-click the .exe file, and then follow the on-screen instructions.

## Using HP PC Hardware Diagnostics UEFI

---

 **NOTE:** For Windows 10 S computers, you must use a Windows computer and a USB flash drive to download and create the HP UEFI support environment because only .exe files are provided. For more information, see [Downloading HP PC Hardware Diagnostics UEFI to a USB flash drive on page 50](#).

---

HP PC Hardware Diagnostics UEFI (Unified Extensible Firmware Interface) allows you to run diagnostic tests to determine whether the computer hardware is functioning properly. The tool runs outside the operating system so that it can isolate hardware failures from issues that are caused by the operating system or other software components.

If your PC will not boot into Windows, you can use HP PC Hardware Diagnostics UEFI to diagnose hardware issues.

When HP PC Hardware Diagnostics Windows detects a failure that requires hardware replacement, a 24-digit Failure ID code is generated. For assistance in solving the problem:

- ▲ Select **Get Support**, and then use a mobile device to scan the QR code that displays on the next screen. The HP Customer Support - Service Center page displays, with your Failure ID and product number automatically filled in. Follow the on-screen instructions.

– or –

Contact support, and provide the Failure ID code.

---

 **NOTE:** To start diagnostics on a convertible computer, your computer must be in notebook mode, and you must use the attached keyboard.

 **NOTE:** If you need to stop a diagnostic test, press `esc`.

---

## Starting HP PC Hardware Diagnostics UEFI

To start HP PC Hardware Diagnostics UEFI, follow these steps:

1. Turn on or restart the computer, and quickly press `esc`.
2. Press `f2`.

The BIOS searches three places for the diagnostic tools, in the following order:

- a. Connected USB flash drive

 **NOTE:** To download the HP PC Hardware Diagnostics UEFI tool to a USB flash drive, see [Downloading the latest HP PC Hardware Diagnostics UEFI version on page 50](#).

---

- b. Hard drive

- c. BIOS

3. When the diagnostic tool opens, select a language, select the type of diagnostic test you want to run, and then follow the on-screen instructions.

## Downloading HP PC Hardware Diagnostics UEFI to a USB flash drive

Downloading HP PC Hardware Diagnostics UEFI to a USB flash drive can be useful in the following situations:

- HP PC Hardware Diagnostics UEFI is not included in the preinstall image.
- HP PC Hardware Diagnostics UEFI is not included in the HP Tool partition.
- The hard drive is damaged.

 **NOTE:** The HP PC Hardware Diagnostics UEFI download instructions are provided in English only, and you must use a Windows computer to download and create the HP UEFI support environment because only `.exe` files are provided.

---

## Downloading the latest HP PC Hardware Diagnostics UEFI version

To download the latest HP PC Hardware Diagnostics UEFI version to a USB flash drive:

1. Go to <http://www.hp.com/go/techcenter/pcdiags>. The HP PC Diagnostics home page is displayed.
2. Select **Download HP Diagnostics UEFI**, and then select **Run**.

## Downloading HP PC Hardware Diagnostics UEFI by product name or number (select products only)

 **NOTE:** For some products, it may be necessary to download the software to a USB flash drive by using the product name or number.

---

To download HP PC Hardware Diagnostics UEFI by product name or number (select products only) to a USB flash drive:

1. Go to <http://www.hp.com/support>.
2. Enter the product name or number, select your computer, and then select your operating system.
3. In the **Diagnostics** section, follow the on-screen instructions to select and download the specific UEFI Diagnostics version for your computer.

## Using Remote HP PC Hardware Diagnostics UEFI settings (select products only)

Remote HP PC Hardware Diagnostics UEFI is a firmware (BIOS) feature that downloads HP PC Hardware Diagnostics UEFI to your computer. It can then execute the diagnostics on your computer, and it may upload results to a preconfigured server. For more information about Remote HP PC Hardware Diagnostics UEFI, go to <http://www.hp.com/go/techcenter/pcdiags>, and then select **Find out more**.

### Downloading Remote HP PC Hardware Diagnostics UEFI



**NOTE:** HP Remote PC Hardware Diagnostics UEFI is also available as a Softpaq that can be downloaded to a server.

### Downloading the latest Remote HP PC Hardware Diagnostics UEFI version

To download the latest Remote HP PC Hardware Diagnostics UEFI version, follow these steps:

1. Go to <http://www.hp.com/go/techcenter/pcdiags>. The HP PC Diagnostics home page is displayed.
2. Select **Download Remote Diagnostics**, and then select **Run**.

### Downloading Remote HP PC Hardware Diagnostics UEFI by product name or number



**NOTE:** For some products, it may be necessary to download the software by using the product name or number.

To download HP Remote PC Hardware Diagnostics UEFI by product name or number, follow these steps:

1. Go to <http://www.hp.com/support>.
2. Select **Get software and drivers**, select your type of product, enter the product name or number in the search box that is displayed, select your computer, and then select your operating system.
3. In the **Diagnostics** section, follow the on-screen instructions to select and download the **Remote UEFI** version for the product.

## Customizing Remote HP PC Hardware Diagnostics UEFI settings

Using the Remote HP PC Hardware Diagnostics setting in Computer Setup (BIOS), you can perform the following customizations:

- Set a schedule for running diagnostics unattended. You can also start diagnostics immediately in interactive mode by selecting **Execute Remote HP PC Hardware Diagnostics**.
- Set the location for downloading the diagnostic tools. This feature provides access to the tools from the HP website or from a server that has been preconfigured for use. Your computer does not require the traditional local storage (such as a disk drive or USB flash drive) to run remote diagnostics.

- Set a location for storing the test results. You can also set the user name and password settings used for uploads.
- Display status information about the diagnostics run previously.

To customize Remote HP PC Hardware Diagnostics UEFI settings, follow these steps:

1. Turn on or restart the computer, and when the HP logo appears, press **f10** to enter Computer Setup.
2. Select **Advanced**, and then select **Settings**.
3. Make your customization selections.
4. Select **Main**, and then **Save Changes and Exit** to save your settings.

Your changes take effect when the computer restarts.

---

# A Electrostatic discharge

A discharge of static electricity from a finger or other conductor may damage system boards or other static-sensitive devices. This type of damage may reduce the life expectancy of the device.

## Preventing electrostatic damage

To prevent electrostatic damage, observe the following precautions:

- Avoid hand contact by transporting and storing products in static-safe containers.
- Keep electrostatic-sensitive parts in their containers until they arrive at static-free workstations.
- Place parts on a grounded surface before removing them from their containers.
- Avoid touching pins, leads, or circuitry.
- Always be properly grounded when touching a static-sensitive component or assembly.

## Grounding methods

There are several methods for grounding. Use one or more of the following methods when handling or installing electrostatic-sensitive parts:

- Use a wrist strap connected by a ground cord to a grounded Thin Client chassis. Wrist straps are flexible straps of  $1\text{ M}\Omega \pm 10\%$  resistance in the ground cords. To provide proper grounding, wear the strap snug against the skin.
- Use heelstraps, toestraps, or bootstraps at standing workstations. Wear the straps on both feet when standing on conductive floors or dissipating floor mats.
- Use conductive field service tools.
- Use a portable field service kit with a folding static-dissipating work mat.

If you do not have any of the suggested equipment for proper grounding, contact an HP authorized dealer, reseller, or service provider.



**NOTE:** For more information about static electricity, contact an HP authorized dealer, reseller, or service provider.

---

---

## B Shipping information

### Shipping preparation

Follow these suggestions when preparing to ship the thin client:

1. Turn off the thin client and external devices.
2. Disconnect the AC power cord from the AC outlet and then from the thin client.
3. Disconnect the system components and external devices from their power sources, and then from the thin client.
4. Pack the system components and external devices in their original packing boxes or similar packaging with sufficient packing material to protect them.



**NOTE:** For environmental nonoperating ranges, go to <http://www.hp.com/go/quickspecs>.

---

### Important service repair information

In all cases, remove and safeguard all external devices before returning the thin client to HP for repair or exchange.

In countries that support customer mail-in repair by returning the same unit to the customer, HP makes every effort to return the repaired unit with the same internal memory and flash modules that were sent.

In countries that do not support customer mail-in repair by returning the same unit to the customer, all internal options should be removed and safeguarded in addition to the external options. The thin client should be restored to the **original configuration** before returning it to HP for repair.

---

# C Accessibility

## HP and accessibility

Because HP works to weave diversity, inclusion, and work/life into the fabric of the company, it is reflected in everything HP does. HP strives to create an inclusive environment focused on connecting people to the power of technology throughout the world.

### Finding the technology tools you need

Technology can unleash your human potential. Assistive technology removes barriers and helps you create independence at home, at work, and in the community. Assistive technology helps increase, maintain, and improve the functional capabilities of electronic and information technology. For more information, see [Finding the best assistive technology on page 56](#).

### The HP commitment

HP is committed to providing products and services that are accessible for people with disabilities. This commitment supports the company's diversity objectives and helps ensure that the benefits of technology are available to all.

The HP accessibility goal is to design, produce, and market products and services that can be effectively used by everyone, including people with disabilities, either on a stand-alone basis or with appropriate assistive devices.

To achieve that goal, this Accessibility Policy establishes seven key objectives to guide HP actions. All HP managers and employees are expected to support these objectives and their implementation in accordance with their roles and responsibilities:

- Raise the level of awareness of accessibility issues within HP, and provide employees with the training they need to design, produce, market, and deliver accessible products and services.
- Develop accessibility guidelines for products and services, and hold product development groups accountable for implementing these guidelines where competitively, technically, and economically feasible.
- Involve people with disabilities in the development of accessibility guidelines and in the design and testing of products and services.
- Document accessibility features, and make information about HP products and services publicly available in an accessible form.
- Establish relationships with leading assistive technology and solution providers.
- Support internal and external research and development that improves assistive technology relevant to HP products and services.
- Support and contribute to industry standards and guidelines for accessibility.

### International Association of Accessibility Professionals (IAAP)

IAAP is a not-for-profit association focused on advancing the accessibility profession through networking, education, and certification. The objective is to help accessibility professionals develop and advance their careers and to better enable organizations to integrate accessibility into their products and infrastructure.

As a founding member, HP joined to participate with other organizations to advance the field of accessibility. This commitment supports HP's accessibility goal of designing, producing, and marketing products and services that people with disabilities can effectively use.

IAAP will make the profession strong by globally connecting individuals, students, and organizations to learn from one another. If you are interested in learning more, go to <http://www.accessibilityassociation.org> to join the online community, sign up for newsletters, and learn about membership options.

## Finding the best assistive technology

Everyone, including people with disabilities or age-related limitations, should be able to communicate, express themselves, and connect with the world using technology. HP is committed to increasing accessibility awareness within HP and with our customers and partners. Whether it's large fonts that are easy on the eyes, voice recognition that lets you give your hands a rest, or any other assistive technology to help with your specific situation—a variety of assistive technologies make HP products easier to use. How do you choose?

## Assessing your needs

Technology can unleash your potential. Assistive technology removes barriers and helps you create independence at home, at work, and in the community. Assistive technology (AT) helps increase, maintain, and improve the functional capabilities of electronic and information technology.

You can choose from many AT products. Your AT assessment should allow you to evaluate several products, answer your questions, and facilitate your selection of the best solution for your situation. You will find that professionals qualified to do AT assessments come from many fields, including those licensed or certified in physical therapy, occupational therapy, speech/language pathology, and other areas of expertise. Others, while not certified or licensed, can also provide evaluation information. You will want to ask about the individual's experience, expertise, and fees to determine if they are appropriate for your needs.

## Accessibility for HP products

The following links provide information about accessibility features and assistive technology, if applicable, included in various HP products. These resources will help you select the specific assistive technology features and product(s) most appropriate for your situation.

- [HP Elite x3—Accessibility Options \(Windows 10 Mobile\)](#)
- [HP PCs—Windows 7 Accessibility Options](#)
- [HP PCs—Windows 8 Accessibility Options](#)
- [HP PC's—Windows 10 Accessibility Options](#)
- [HP Slate 7 Tablets—Enabling Accessibility Features on Your HP Tablet \(Android 4.1/Jelly Bean\)](#)
- [HP SlateBook PCs—Enabling Accessibility Features \(Android 4.3, 4.2/Jelly Bean\)](#)
- [HP Chromebook PCs—Enabling Accessibility Features on Your HP Chromebook or Chromebox \(Chrome OS\)](#)
- [HP Shopping—peripherals for HP products](#)

If you need additional support with the accessibility features on your HP product, see [Contacting support on page 59](#).

Additional links to external partners and suppliers that may provide additional assistance:

- [Microsoft Accessibility information \(Windows 7, Windows 8, Windows 10, Microsoft Office\)](#)
- [Google Products accessibility information \(Android, Chrome, Google Apps\)](#)



- [Assistive Technologies sorted by impairment type](#)
- [Assistive Technologies sorted by product type](#)
- [Assistive Technology vendors with product descriptions](#)
- [Assistive Technology Industry Association \(ATIA\)](#)

## Standards and legislation

### Standards

Section 508 of the Federal Acquisition Regulation (FAR) standards was created by the US Access Board to address access to information and communication technology (ICT) for people with physical, sensory, or cognitive disabilities. The standards contain technical criteria specific to various types of technologies, as well as performance-based requirements which focus on functional capabilities of covered products. Specific criteria cover software applications and operating systems, web-based information and applications, computers, telecommunications products, video and multimedia, and self-contained closed products.

### Mandate 376 – EN 301 549

The EN 301 549 standard was created by the European Union within Mandate 376 as the basis for an online toolkit for public procurement of ICT products. The standard specifies the functional accessibility requirements applicable to ICT products and services, together with a description of the test procedures and evaluation methodology for each accessibility requirement.

### Web Content Accessibility Guidelines (WCAG)

Web Content Accessibility Guidelines (WCAG) from the W3C's Web Accessibility Initiative (WAI) helps web designers and developers create sites that better meet the needs of people with disabilities or age-related limitations. WCAG advances accessibility across the full range of web content (text, images, audio, and video) and web applications. WCAG can be precisely tested, is easy to understand and use, and allows web developers flexibility for innovation. WCAG 2.0 has also been approved as [ISO/IEC 40500:2012](#).

WCAG specifically addresses barriers to accessing the web experienced by people with visual, auditory, physical, cognitive, and neurological disabilities, and by older web users with accessibility needs. WCAG 2.0 provides characteristics of accessible content:

- **Perceivable** (for instance, by addressing text alternatives for images, captions for audio, adaptability of presentation, and color contrast)
- **Operable** (by addressing keyboard access, color contrast, timing of input, seizure avoidance, and navigability)
- **Understandable** (by addressing readability, predictability, and input assistance)
- **Robust** (for instance, by addressing compatibility with assistive technologies)

### Legislation and regulations

Accessibility of IT and information has become an area of increasing legislative importance. The links listed below provide information about key legislation, regulations, and standards.

- [United States](#)
- [Canada](#)
- [Europe](#)

- [United Kingdom](#)
- [Australia](#)
- [Worldwide](#)

## Useful accessibility resources and links

The following organizations might be good resources for information about disabilities and age-related limitations.



**NOTE:** This is not an exhaustive list. These organizations are provided for informational purposes only. HP assumes no responsibility for information or contacts you encounter on the Internet. Listing on this page does not imply endorsement by HP.

### Organizations

- American Association of People with Disabilities (AAPD)
- The Association of Assistive Technology Act Programs (ATAP)
- Hearing Loss Association of America (HLAA)
- Information Technology Technical Assistance and Training Center (ITTATC)
- Lighthouse International
- National Association of the Deaf
- National Federation of the Blind
- Rehabilitation Engineering & Assistive Technology Society of North America (RESNA)
- Telecommunications for the Deaf and Hard of Hearing, Inc. (TDI)
- W3C Web Accessibility Initiative (WAI)

### Educational institutions

- California State University, Northridge, Center on Disabilities (CSUN)
- University of Wisconsin - Madison, Trace Center
- University of Minnesota computer accommodations program

### Other disability resources

- ADA (Americans with Disabilities Act) Technical Assistance Program
- ILO Global Business and Disability network
- EnableMart
- European Disability Forum
- Job Accommodation Network
- Microsoft Enable

## HP links

[Our contact webform](#)

[HP comfort and safety guide](#)

[HP public sector sales](#)

## Contacting support

---

 **NOTE:** Support is in English only.

---

- Customers who are deaf or hard of hearing who have questions about technical support or accessibility of HP products:
  - Use TRS/VRS/WebCapTel to call (877) 656-7058 Monday through Friday, 6 a.m. to 9 p.m. Mountain Time.
- Customers with other disabilities or age-related limitations who have questions about technical support or accessibility of HP products, choose one of the following options:
  - Call (888) 259-5707 Monday through Friday, 6 a.m. to 9 p.m. Mountain Time.
  - Complete the [Contact form for people with disabilities or age-related limitations](#).

# Index

- A**
  - access panel
    - removing 14
    - replacing 15
  - accessibility 55
  - accessibility needs assessment 56
  - Advanced menu 31
  - assistive technology (AT)
    - finding 56
    - purpose 55
  - AT (assistive technology)
    - finding 56
    - purpose 55
  - audible codes 38
- B**
  - basic troubleshooting 40
  - battery, replacing 18
  - beep codes 38
  - BIOS
    - updating 35
  - BIOS Settings 25
- C**
  - cautions
    - electric shock 13, 14, 21
    - installing memory modules 21
    - removing the battery 18
    - static electricity 13
  - Certificates, labels, and serial number location 2
  - changing BIOS settings 32
  - components
    - front 1
    - internal 16
  - Computer Setup (F10) Utility 25
  - Computer Setup — Advanced menu 31
  - Computer Setup — File menu 27
  - Computer Setup — Power menu 30
  - Computer Setup — Security menu 29
  - Computer Setup — Storage menu 28
  - configuring a PXE server 42
  - customer support, accessibility 59
- D**
  - diagnostics and troubleshooting 36
  - disabling/enabling Wake-on LAN (WOL) 36
  - diskless troubleshooting 41
- E**
  - electrostatic discharge 53
  - error
    - codes 38
- F**
  - File menu 27
  - flashing lights 38
- G**
  - grounding methods 53
- H**
  - hardware specifications 47
  - HP Assistive Policy 55
  - HP BIOS Configuration Utility (HPBCU) 32
  - HP PC Hardware Diagnostics UEFI
    - downloading 50
    - starting 50
    - using 49
  - HP PC Hardware Diagnostics Windows
    - downloading 48
    - installing 49
    - using 48
  - HP ThinUpdate 42
- I**
  - installation guidelines 3, 13
  - installing
    - security cable 6
  - internal components 16
  - International Association of Accessibility Professionals 55
- L**
  - lights 36
    - blinking power 38
- M**
  - M.2 flash storage module, removing and replacing 16
  - memory devices available 45
  - memory, upgrading 20
- P**
  - passwords 37
  - power connection 12
  - power cord
    - requirements for all countries 43
    - requirements for specific countries and regions 44
  - power cord set requirements 43
  - Power menu 30
  - power-on diagnostic tests 37
  - power-on sequence 37
  - preventing electrostatic damage 53
  - PXE server 42
- R**
  - Remote HP PC Hardware Diagnostics UEFI settings
    - customizing 51
    - using 51
  - removing
    - access panel 14
    - battery 18
    - M.2 storage module 54
    - USB flash drive 54
  - replacing
    - access panel 15
    - battery 18
  - resetting passwords 37
  - resources, accessibility 58
  - routine care 12
- S**
  - Section 508 accessibility standards 57

- Security menu 29
- service repair 54
- setup 3
- shipping preparation 54
- specifications
  - hardware 47
  - thin client 47
- stand, installing 3
- standards and legislation,
  - accessibility 57
- Statement of volatility 45
- Storage menu 28
- storage module, removing 54
- supported orientation 9

## T

- troubleshooting 25, 40

## U

- unsupported placements 11
- updating a BIOS 35
- upgrading system memory 20
- USB flash drive, removing 54
- using HP ThinUpdate to restore the image 42

## V

- VESA mount 6

## W

- Wake-on LAN (WOL) 36
- warnings
  - burn 13
  - electric shock 13
  - grounding plug 13
  - NIC receptacles 13
- warnings and cautions 3
- WLAN card, replacing 23