



ST4301K/ST5501K  
LCD Monitor  
User Manual



## Disclaimer

BenQ Corporation makes no representations or warranties, either expressed or implied, with respect to the contents of this document. BenQ Corporation reserves the right to revise this publication and to make changes from time to time in the contents thereof without obligation to notify any person of such revision or changes.

## Copyright

Copyright 2021 BenQ Corporation. All rights reserved. No part of this publication may be reproduced, transmitted, transcribed, stored in a retrieval system or translated into any language or computer language, in any form or by any means, electronic, mechanical, magnetic, optical, chemical, manual or otherwise, without the prior written permission of BenQ Corporation.

## Product support

This document aims to provide the most updated and accurate information to customers, and thus all contents may be modified from time to time without prior notice. Please visit the website for the latest version of this document and other product information. Available files vary by model.

1. Make sure your computer is connected to the Internet.
2. Visit the local website from [www.BenQ.com](http://www.BenQ.com). The website layout and content may vary by region/country.
  - User manual and related document: [www.BenQ.com](http://www.BenQ.com) > **BenQ DISPLAY** > **SUPPORT** > **Downloads** > model name > **User Manual**
  - (EU only) Dismantled information: Available on the user manual download page. This document is provided based on Regulation (EU) 2019/2021 to repair or recycle your product. Always contact the local customer service for servicing within the warranty period. If you wish to repair an out-of-warranty product, you are recommended to go to a qualified service personnel and obtain repair parts from BenQ to ensure compatibility. Do not disassemble the product unless you are aware of the consequences. If you cannot find the dismantled information on your product, contact the local customer service for assistance.

# Table of Contents

Product support.....	3
Safety warnings and precautions.....	6
Important safety instructions.....	7
Notes on the LCD panel of this display .....	7
Safety notice for remote control .....	8
Battery safety notice .....	8
BenQ ecoFACTS .....	9
Package contents .....	10
Setting up the display.....	11
Mounting the display .....	11
Installing the display on a wall.....	11
Parts of the display and their functions.....	13
Rear panel.....	13
Input/output terminals.....	14
Input/output terminals.....	14
Remote control.....	15
Using the remote control .....	17
Connection .....	19
Connecting audio/video signals.....	19
Connecting power .....	20
Basic operations.....	21
Turning the display on or off.....	21
Switching input signals.....	22
Adjusting audio volume level.....	22
Operations in the OSD menu.....	23
Initial setup .....	24
<b>Setting</b> .....	24
Downloading software.....	24
Setting up the Internet connection.....	25
Updating software.....	26
Menu operations.....	27
Android Input .....	27
Other Input .....	35

Android system interface.....	38
Main interface .....	38
Multimedia files.....	39
<b>APPS</b> .....	<b>49</b>
About All Apps.....	49
<b>Browser</b> .....	<b>50</b>
<b>X-Sign</b> .....	<b>51</b>
<b>BenQ Suggests</b> .....	<b>52</b>
<b>WPS Office</b> .....	<b>53</b>
<b>Blizz</b> .....	<b>55</b>
<b>Product information</b> .....	<b>56</b>
Specifications .....	56
Dimensions .....	58
Supported input signal resolution.....	60
<b>Troubleshooting</b> .....	<b>62</b>

## Safety warnings and precautions



The lightning flash with arrowhead symbol, within an equilateral triangle, is intended to alert the user to the presence of uninsulated “dangerous voltage” within the product’s enclosure that may be of sufficient magnitude to constitute a risk of electric shock to persons.



The exclamation point within an equilateral triangle is intended to alert the user to the presence of important operating and maintenance (servicing) instructions in the literature accompanying the appliance.



### THIS EQUIPMENT MUST BE GROUNDED

To ensure safe operation, the three-pin plug must be inserted only into a standard three-pin power outlet which is effectively grounded through normal household wiring. Extension cords used with the equipment must have three cores and be correctly wired to provide connection to the ground. Wrongly wired extension cords are a major cause of fatalities.

The fact that the equipment operates satisfactorily does not imply that the power outlet is grounded or that the installation is completely safe. For your safety, if you are in any doubt about the effective grounding of the power outlet, please consult a qualified electrician.

- The mains plug of the power supply cord shall remain readily operable. The AC receptacle (mains socket outlet) shall be installed near the equipment and shall be easily accessible. To completely disconnect this equipment from the AC mains, disconnect the power cord plug from the AC receptacle.
- Do not place this display on an uneven, sloping or unstable surface (such as a trolley) where it may fall and cause damage to itself or others.
- Do not place this display near water, like a spa or pool, or in a position which will allow the splashing or spraying of water onto the display, like in front of an open window where rain water may enter.
- Do not install this display in a confined space without proper ventilation and air circulation, such as in a closed cabinet. Allow proper space around the display for dissipating heat inside. Do not block any openings and vents on the display. Overheating may result in hazards and electric shock.
- Installation of this display should only be performed by a qualified technician. Failure to install this display properly may cause injuries and damages to the personnels and the display itself. Check the installation regularly and maintain the display periodically to ensure the best working condition.
- Use only the accessories approved or recommended by the manufacturer to mount this display. Using wrong or unsuitable accessories may cause the display to fall and result in serious personal injuries. Make sure that the surface and fixing points are strong enough to sustain the weight of the display.
- To reduce the risk of electric shock, do not remove covers. No user serviceable parts inside. Refer servicing to qualified service personnel.
- To prevent personal injuries, mounting the display or installing desktop stands is required before use.

## Important safety instructions

1. Read these instructions.
2. Keep these instructions.
3. Heed all warnings.
4. Follow all instructions.
5. Do not use this apparatus near water.
6. Clean only with dry cloth.
7. Do not block any ventilation openings. Install in accordance with the manufacturer's instructions.
8. Do not install near any heat sources such as radiators, heat registers, stoves, or other apparatus (including amplifiers) that produce heat.
9. Do not defeat the safety purpose of the polarized or grounding-type plug. A polarized plug has two blades with one wider than the other. A grounding-type plug has two blades and a third grounding prong. The wide blade or the third prong are provided for your safety. If the provided plug does not fit into your outlet, consult an electrician for replacement of the obsolete outlet.
10. Protect the power cord from being walked on or pinched particularly at plugs, convenience receptacles, and the point where they exit from the apparatus.
11. Only use attachments/accessories specified by the manufacturer.
12. Use only with the cart, stand, tripod, bracket, or table specified by the manufacturer, or sold with the apparatus. When a cart is used, use caution when moving the cart/apparatus combination to avoid injury from tip-over.
13. Unplug this apparatus during lightning storms or when unused for long periods of time.
14. Refer all servicing to qualified service personnel. Servicing is required when the apparatus has been damaged in any way, such as power-supply cord or plug is damaged, liquid has been spilled or objects have fallen into the apparatus, the apparatus has been exposed to rain or moisture, does not operate normally, or has been dropped.



## Notes on the LCD panel of this display

- The Liquid Crystal Display (LCD) panel of this display has a very thin protective layer of glass which is liable to marking or scratching, and cracking if struck or pressured. The liquid crystal substrate is also liable to damage under excessive force or extreme temperatures. Please handle with care.
- The response time and brightness of the LCD panel may vary with the ambient temperature.
- Avoid placing the display in direct sun or where direct sun or spot lighting will shine onto the LCD panel, as the heat may damage the panel and the external casing of the display, and the bright light will make viewing the display more difficult than necessary.
- The LCD panel consists of individual pixels to display images and is manufactured according to the design specifications. While 99.9% of these pixels work normally, 0.01% of the pixels may remain constantly lit (in red, blue or green) or unlit. This is a technical limitation of the LCD technology and is not a defect.

- LCD screens, like plasma (PDP) and conventional CRT (Cathode Ray Tube) screens, are also susceptible to 'screen burn-in' or 'image retention' which can be found on the screen as visible fixed lines and shades. To avoid such damage to the screen, avoid displaying still images (like On-Screen Display menus, fixed/inactive text or icons) for more than 30 minutes. Change the aspect ratio from time to time. Fill the entire screen with the image and eliminate the black bars whenever possible. Avoid displaying images in 4:3 aspect ratio over a long period of time, otherwise there may be visible burn marks on the screen as two vertical lines.

Note: Under certain circumstances, condensation may occur on the inner side of the cover glass, it's a natural phenomenon and will not affect the operation of the display. This condensation will usually disappear after around 2 hours of normal operation.

- ST series does not offer image retention function, for more information, please refer to installation guide.
- For ST series, when the power goes out unexpectedly, please make sure the time zone is correctly synced via the Internet, otherwise manual adjustment is needed.

## Safety notice for remote control

- Do not put the remote control in the direct heat, humidity, and avoid fire.
- Do not drop the remote control.
- Do not expose the remote control to water or moisture. Failure to do so could result in malfunction.
- Confirm there is no object between the remote control and the remote sensor of the product.
- When the remote control will not be used for an extended period, remove the batteries.

## Battery safety notice

The use of the wrong type of batteries may cause chemical leaks or explosion. Please note the following:

- Always ensure that the batteries are inserted with the positive and negative terminals in the correct direction as shown in the battery compartment.
- Different types of batteries have different characteristics. Do not mix different types.
- Do not mix old and new batteries. Mixing old and new batteries will shorten battery life or cause chemical leaks from the old batteries.
- When batteries fail to function, replace them immediately.
- Chemicals which leak from batteries may cause skin irritation. If any chemical matter seeps out of the batteries, wipe it up immediately using a dry cloth, and replace the batteries as soon as possible.
- Due to varying storage conditions, the battery life for the batteries included with your product may be shortened. Replace them within 3 months or as soon as you can after initial use.
- There may be local restrictions on the disposal or recycling of batteries. Consult your local regulations or waste disposal provider.



## BenQ ecoFACTS

BenQ has been dedicated to the design and development of greener product as part of its aspiration to realize the ideal of the “Bringing Enjoyment 'N Quality to Life” corporate vision with the ultimate goal to achieve a low-carbon society. Besides meeting international regulatory requirement and standards pertaining to environmental management, BenQ has spared no efforts in pushing our initiatives further to incorporate life cycle design in the aspects of material selection, manufacturing, packaging, transportation, using and disposal of the products. BenQ ecoFACTS label lists key eco-friendly design highlights of each product, hoping to ensure that consumers make informed green choices at purchase. Check out BenQ's CSR Website at <http://csr.BenQ.com/> for more details on BenQ's environmental commitments and achievements.

CLASS II equipment

## Package contents

Open the sales package and check the contents. If any item is missing or damaged, please contact your dealer immediately.



LCD display

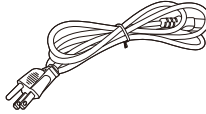

Power cord (by region)

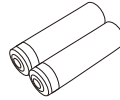

AAA battery x 2



Remote control

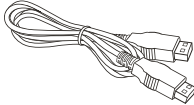

HDMI cable x 1

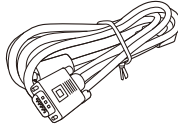

VGA cable x 1

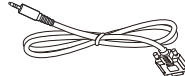

RS232 cable x 1



Quick start guide



- The type of power cord supplied may differ from that illustrated depending on your region of purchase.
- Before discarding the package, check that you haven't left any accessories inside the box.
- Dispose of packaging materials wisely. You can recycle the cardboard carton. Consider storing the package (if possible) for future transport of the display.
- Do not leave plastic bags within reach of young children or babies.

# Setting up the display

## Mounting the display

You can install the display on a vertical surface with a suitable wall mounting bracket or on a horizontal surface with the optional desktop stands. Please pay attention to the following notes during installation:

- This display should be installed by at least two adult persons. Attempting to install this display by only one person may result in danger and injuries.
- Refer the installation to qualified technicians. Improper installation may cause the display to fall or malfunction.

## Installing the display on a wall

VESA Standard:

ST4301K: 200 × 400 (4 - M6)

ST5501K: 400 × 400 (4 - M6)

1. Place a clean, dry and lint-free cloth on a flat, horizontal and object-free surface. Make sure that the size of the cloth is larger than the display.
2. Gently lay the display on the cloth with the LCD screen facing down.
3. Remove the desktop stands from the display if installed.
4. Identify the wall mounting screw holes on the back of the display as shown in the illustration.

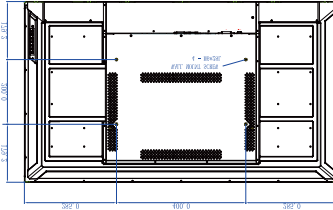

ST4301K

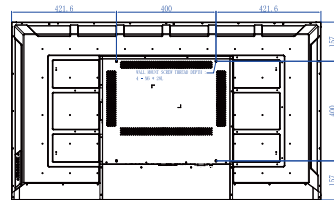

ST5501K

5. Install the wall mounting bracket on the display and attach the display to the wall according to the mounting bracket's instructions. The length of the screw should exceed the thickness of the wall mounting bracket, please refer to below chart for each model. Make sure that all screws are tightened and secured properly. (Recommended torque: 16 (+2/-2) kgf/cm). The mounting means should be strong enough to bear the weight of the display.

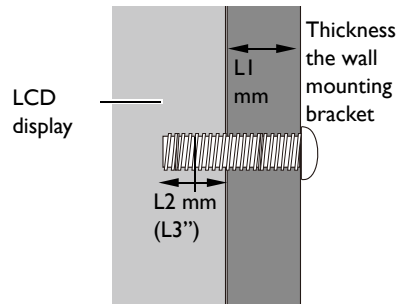



- To maintain proper ventilation, keep at least 10 mm of clear space from the back cover of the display to the wall.
- Please consult a professional technician for wall mount installations. The manufacturer accepts no liability for installations not performed by a professional technician.

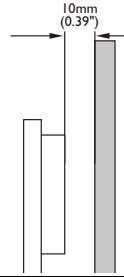

# Parts of the display and their functions

## Rear panel

ST4301K  
ST5501K

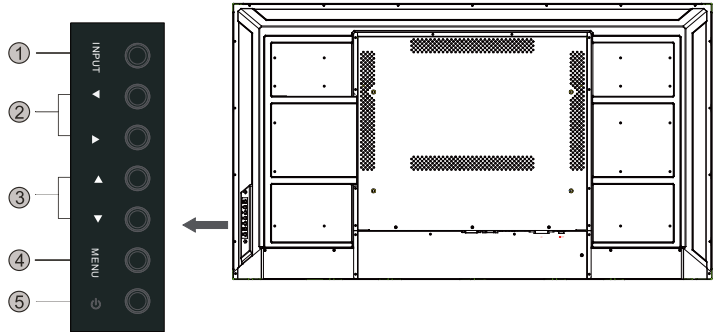

No.	Name	Description
1	<b>INPUT</b>	<ul style="list-style-type: none"> <li>Select/confirm options in On-Screen Display (OSD) menu.</li> <li>Select input sources.</li> </ul>
2	◀ / ▶	<ul style="list-style-type: none"> <li>Scroll through settings and options in the OSD menu.</li> <li>Hot keys for audio volume adjustment.</li> </ul>
3	▲ / ▼	Scroll through settings and options in the OSD menu up and down.
4	<b>MENU</b>	Open or close the OSD menu.
5	⏻	Turn the display on or off.

## Input/output terminals

ST4301K  
ST5501K

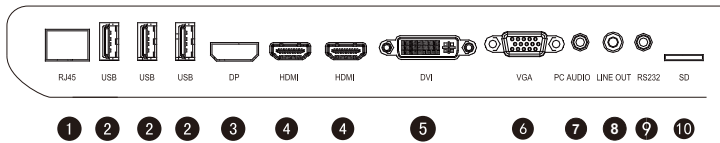
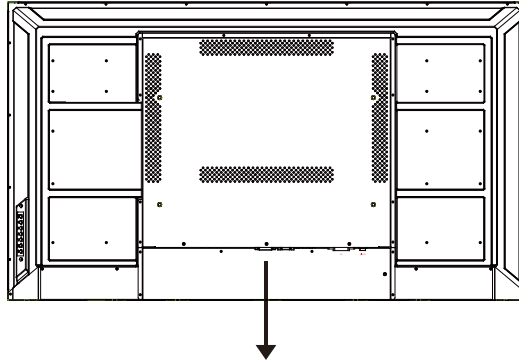

## Input/output terminals

No.	Name	Description
1	<b>RJ45</b>	Connect to a network using the Ethernet cable.
2	<b>USB</b>	Access multimedia files on USB drives directly.
3	<b>DP</b>	Connect a video source to a display device.
4	<b>HDMI</b>	Receive 4K2K 60Hz supported signals from an external device.
5	<b>DVI</b>	Connect a video source.
6	<b>VGA</b>	Receive analog RGB signals from an external device (such as a computer).
7	<b>PC AUDIO</b>	Receive audio signals from an external device.
8	<b>LINE OUT</b>	Output audio signals to an external device.
9	<b>RS232</b>	Serial interface, used for mutual transfer of data between devices.
10	<b>SD</b>	Connect with a high-capacity memory card.

## Remote control

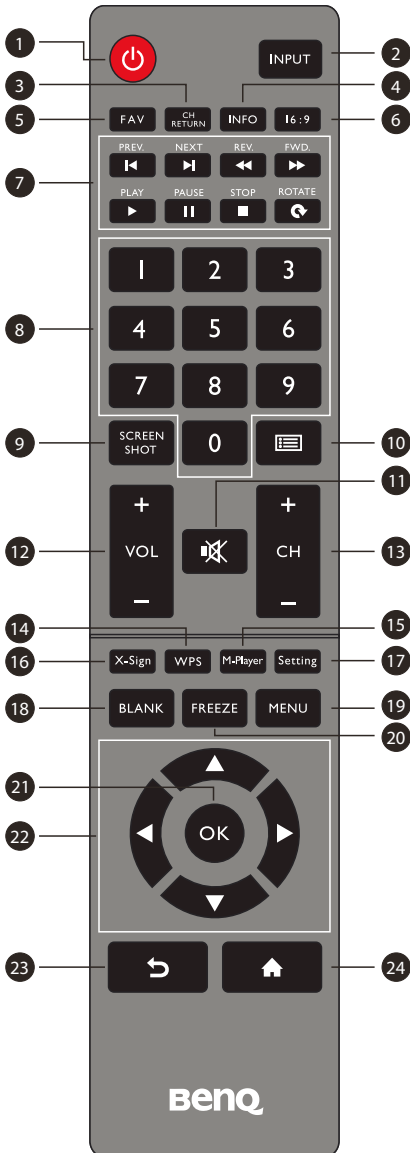

### 1 POWER

Turn the display on or off.

### 2 INPUT

Select the input source.

### 3 CH RETURN

Channel return

Note: It is only working on some specific regions.

### 4 INFO

Show the information of the current input source.

### 5 FAV

Favorite program

Note: It is only working on some specific regions.

### 6 Meeting mode

Change the display image to the different mode under non-Android system Mode: Full, 4:3, Film, Subtitle, PC mode.

### 7 MULTI-MEDIA buttons

The buttons are used to operate the media functions under Multi-Media APP.

### 8 Numeric buttons (0-9)

Press to enter numbers.

### 9 SCREEN SHOT

Capture the printed screen and save to the USB drive.

### 10 CHLIST (≡)

Delete a character / view program list.

Note: It is only working on some specific regions.

### 11 MUTE

Turn on/off the sound.

### 12 VOL- / VOL+

Turn up/down the volume.

### 13 CH+ / CH-

Change program channels.

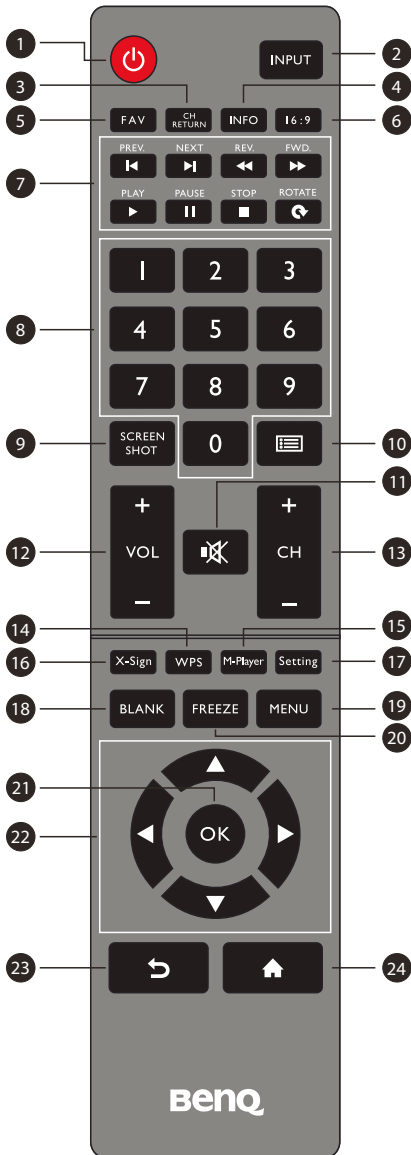

**14 WPS**

Open the WPS office app in Android

**15 M-Player**

Open the Media Player app in Android.

**16 X-Sign**

Open the X-Sign app in Android.

**17 Setting**

Open the setting function in Android.

**18 BLANK**

Blank and mute the screen (the screen will turn black) when the OSD menu is off. Press again to resume.

**19 MENU**

Activate the OSD menu.

**20 FREEZE**

Freeze the screen.

**21 OK**

Confirm the selected options or save changes.

**22 CURSOR KEYS (◀/▶/▲/▼)**

Scroll through settings and options in the OSD menu.

**23 BACK (↶)**

Press this key to return to previous page.

**24 HOME (🏠)**

Show the main screen of Android system.



## Using the remote control

### Installing remote control batteries

---

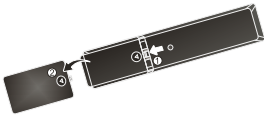

1. Open the remote control battery compartment cover.

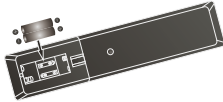

2. Insert the supplied batteries ensuring that the positive and negative marked battery terminals match the (+) and (-) marks in the battery compartment.



The supplied batteries are provided for your convenience so that you can operate the display straight away. You should replace them as soon as possible.

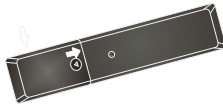

3. Refit the battery compartment cover.
-

## Remote control usage tips

- Point and aim the top front of the remote control directly at the display's remote control sensor window when you press the buttons.
- Do not let the remote control become wet or place it in humid environments (like bathrooms).
- If the display's remote control sensor window is exposed to direct sunlight or strong light, the remote control may not operate properly. In this situation, change the light source, readjust the angle of the display or operate the remote control from a location closer to the display's remote control sensor window.

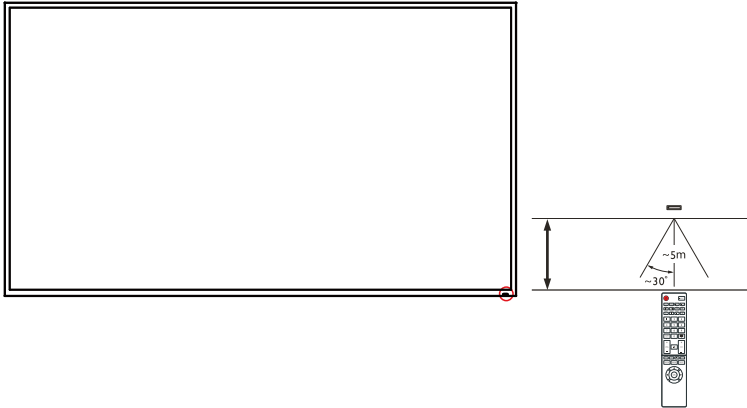

## Keypad/remote control lock SOP

- Press and hold **CH+** on remote control: Enable/Disable keypad function.
- Press and hold **CH-** on remote control: Enable/Disable remote control function.

# Connection

## Connecting audio/video signals

Pay attention to the following notes when you connect cables:

- Please turn off all devices.
- Familiarize yourself with the audio/video ports on the display and the devices you want to use. Be aware that incorrect connections may adversely affect picture quality.
- Do not remove cables from the ports by pulling the cable itself. Always grasp and pull the connectors at the end of the cable.
- Ensure that all cables are fully inserted and firmly seated.

## Connecting the digital inputs

1. Connect the **VGA** jack on the display to the VGA output jack on a computer using a D-Sub (15-pin) cable.
2. Connect the computer's audio output jack to the **PC AUDIO** jack on the display using a suitable audio cable.
3. Connect the HDMI output jack of a computer or A/V device (such as a VCR or DVD player) to the **HDMI** input jack on the display using an HDMI cable.
4. To view a video image from this input, press the **INPUT** button and choose **HDMI**.

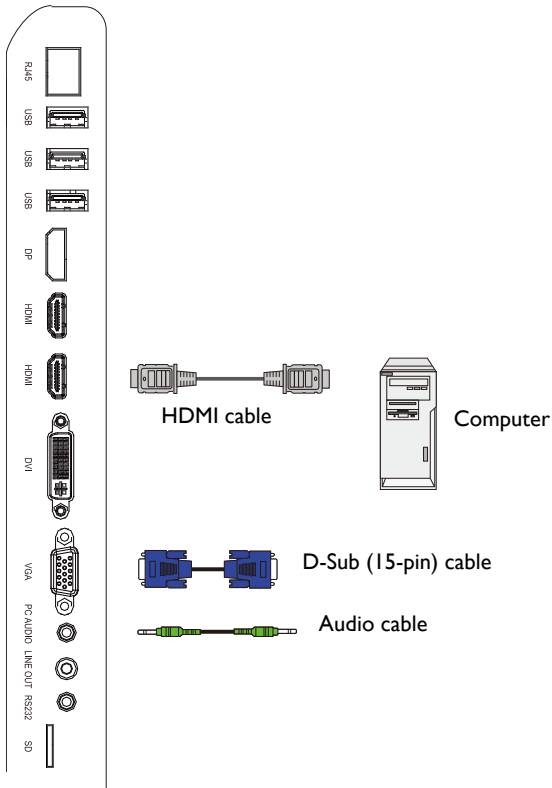

## Connecting the multimedia inputs

To view multimedia files on the USB flash drive, plug the USB flash drive in the **USB** port.

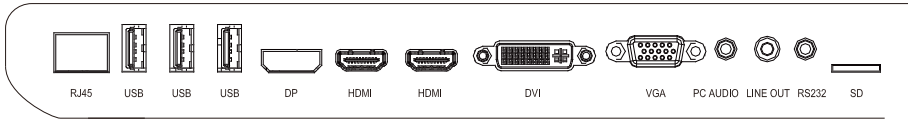

USB flash drive



The USB ports can not be connected with the devices over 0.5A.

## Connecting power

Plug one end of the power cord into the **Power** jack on the display and the other end into an appropriate power outlet (if the outlet is switched, turn on the switch).

ST4301K  
ST5501K

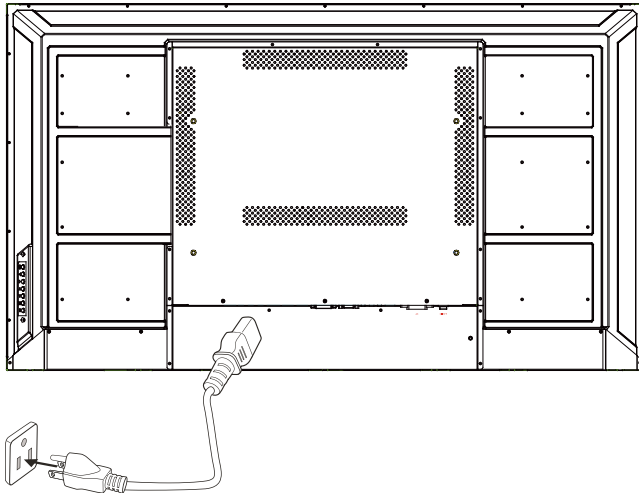

- The supplied power cord is suitable for use with 100-240V AC power only.
- The power cord and outlet illustrated may differ from the ones used in your region.
- Only use an appropriate power cord for your region. Never use a power cord which appears damaged or frayed, or change the plug type on the power cord.
- Be aware of the power loading when you use extension cords or multiple outlet power boards.
- There are no user serviceable parts in this display. Never unscrew or remove any covers. There are dangerous voltages inside the display. Turn off the power and unplug the power cord if you intend to move the display.

## Basic operations

### Turning the display on or off

1. Be sure to follow the instruction of [Connecting power on page 20](#).
2. Before turning on the display, make sure the Power switch is set to ON. The system will enter standby mode.

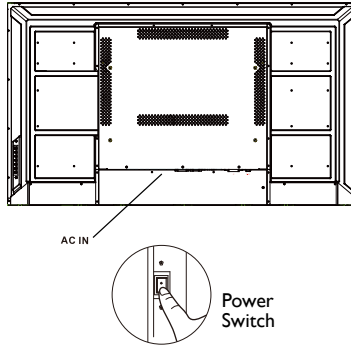

The display's standby mode still consumes power. To completely cut off power supply, set the Power switch to OFF (O) and then disconnect the power cord from the power outlet.

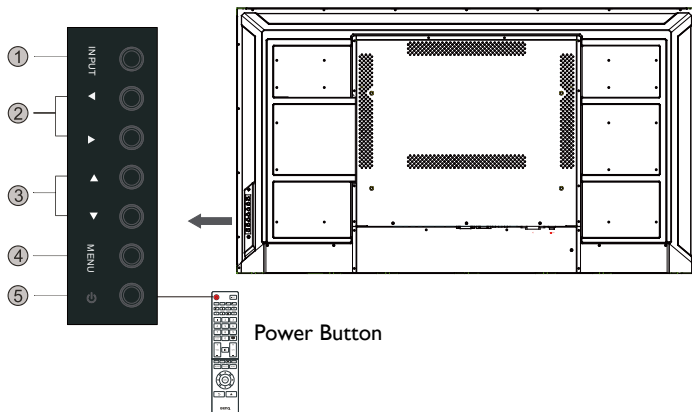

- Only by switching on the master switch will either power button work. To turn on or off the display, press the power button on the display's control panel or on the remote control.
- Turning off the power still consumes power. The users have to un-plug the plug to completely cut off the power supply.

## Switching input signals

Press the **INPUT** button and those signal selection buttons on the remote control or the **INPUT** button on the control panel to select an input signal.

## Adjusting audio volume level

- Press ◀ / ▶ on the control panel or **VOL-** / **VOL+** on the remote control to adjust the volume.
- Go to **Setting > Audio** to adjust the volume. Refer to [Audio settings on page 27](#) for more information.

## Operations in the OSD menu

### Using the control panel buttons

1. Press **MENU** to open the OSD menu.

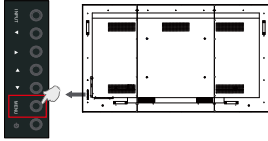

2. In the OSD menu, press **▲** or **▼** to select an item.

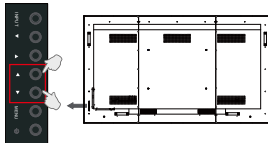

3. Press **INPUT** to confirm selections.

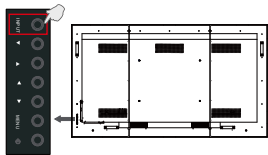

4. Press **◀** or **▶** to adjust settings and press **▲** or **▼** to select a feature. Press **INPUT** to save changes.

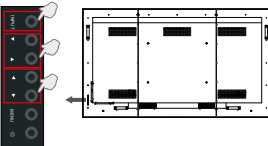

5. Press **MENU** to close the OSD menu.

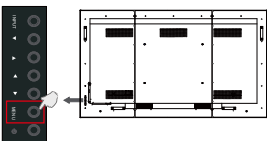

### Using the remote control

1. Press **MENU** to open the OSD menu.

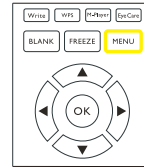

2. Press **▲** or **▼** to select an item.

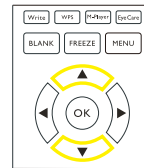

3. Press **INPUT** to confirm selections.

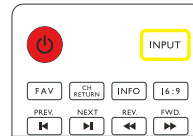

4. Press **▲** and **▼** to select a feature and press **◀** or **▶** to adjust settings. Press **OK** to confirm changes.



5. Press **BACK** to close the OSD menu.



## Initial setup

After you have connected the display to the power, you are ready to power on the display. The first time you power on the display, you will be guided through a series of setup screens. Follow the on-screen instructions or the steps below to start up your display and complete the initial setup.

1. Turn on the display. Wait for the display to boot up with the BenQ screen. This may take a moment.
2. Tap **Next** on the screen to begin. Follow the on-screen instructions to set up the language, date and time, and network. Or you can skip some of these steps and complete the setup later.

## Setting

- Press **MENU** on the remote control or **MENU** button on the front panel to enter the OSD menu. You can also select **Setting** on the home screen to go to the OSD menu.

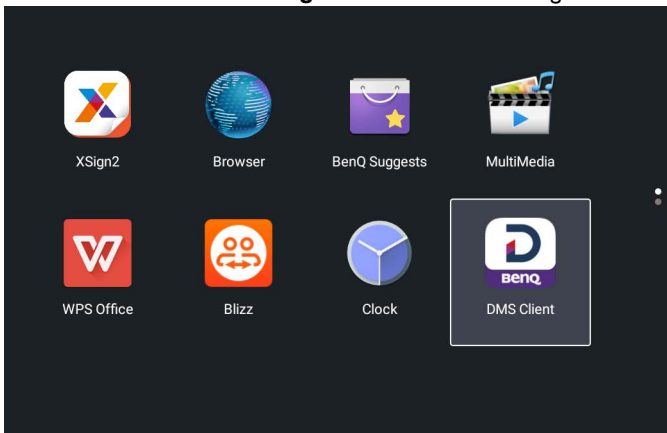

- Under **General**, you can select a desired input source and adjust backlight. Refer to [General settings on page 27](#) for more information.

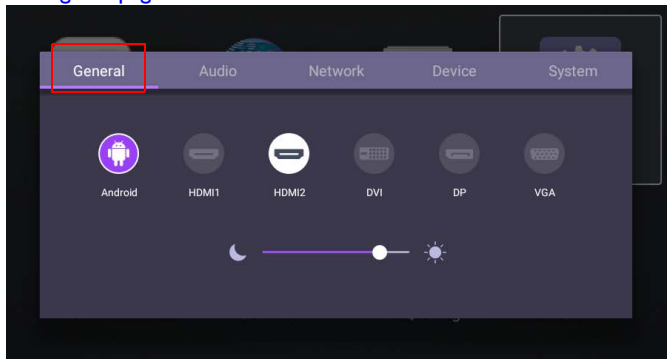

## Downloading software

BenQ may periodically release software updates that may add functions or applications associated with your display. To check if there is a software update available for your



device or to obtain the software license key, please visit <http://DSdownload.BenQ.com>. Then enter the serial number (can be found on the sticker attached on the back of the display) and click **OK** to access the Software download page.

## Setting up the Internet connection

Your display must be connected to a network to conduct OTA updates or surf the Internet.



To find the MAC address in Android OS, please go to **Setting > System > About > Status**.

## Network setting

On the home screen, go to **Setting > System > About > Status**. If there is no IP address shown, please connect the display to the ethernet cable.

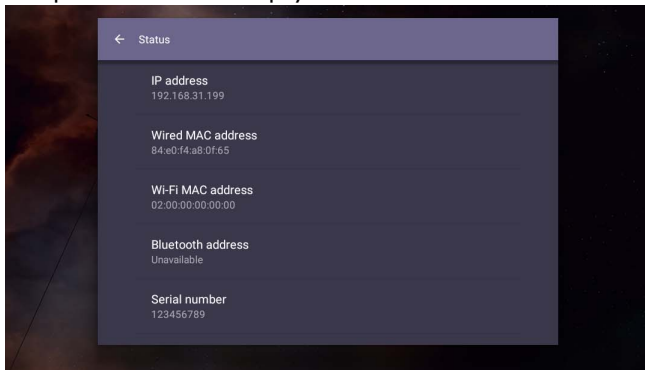

## Wireless connection

You must use a wireless adapter in order to connect the display to the Internet wirelessly. Please contact your local dealer for more information on configuring the wireless connection.

1. Press **MENU** on the remote control, or go to **Network > Wi-Fi**.

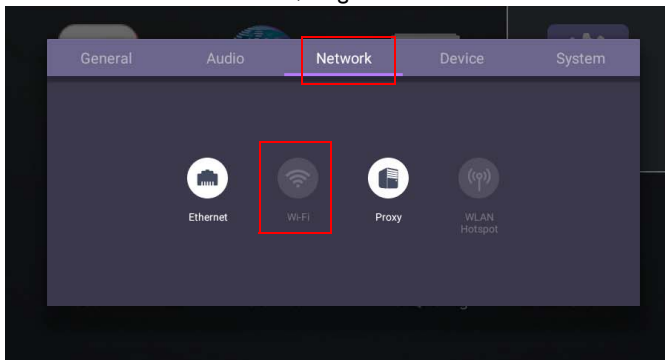

- Set the switcher to **On**. A list of available networks will show on the screen.



- Press **▲/▼/◀/▶** on the remote control to select the network's name and connect to the network. The password is needed if it is your first time to use the network. Key in the password and press **Connect**. The device is now connected to the WLAN.

## Updating software

Whenever a new version of software is available, the system will automatically detect the update and will prompt you to download it every time you turn on the display. If you want to update the software, choose **NETWORK UPDATE** or **USB UPDATE** to continue the update. Or you can skip this step and update the software later.

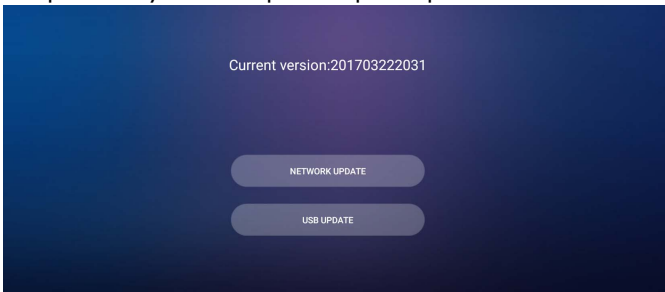

To manually update the software:

- Go to **System > About > System updates**.

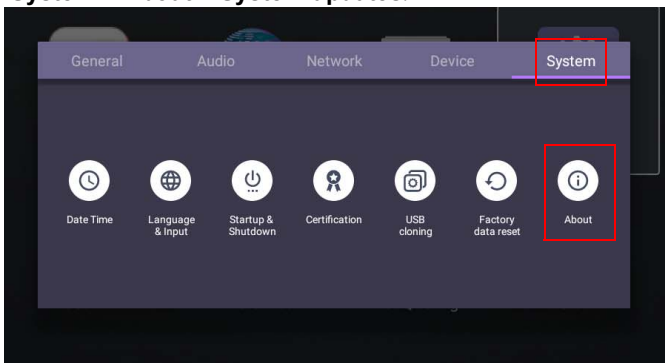

- If there is an update available, the system will begin updating.



- Software update process may take some time to complete.
- During the update process, do not turn off the device or disconnect the Internet connection. Any interruptions during the software update process may permanently damage your display.

# Menu operations

## Android Input

### General settings

Press **MENU** on the remote control or **MENU** button on the front panel to enter the OSD menu.

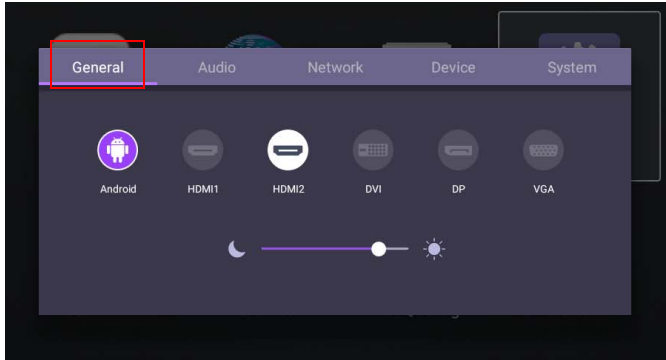

- Press **▲/▼/◀/▶** on the remote control and press **OK** to select a desired input source.
- Press **↩** on the remote control to exit the menu.
- Use the brightness bar to adjust the brightness for the display.

### Audio settings

Go to **Audio** to enter the **Audio** menu.

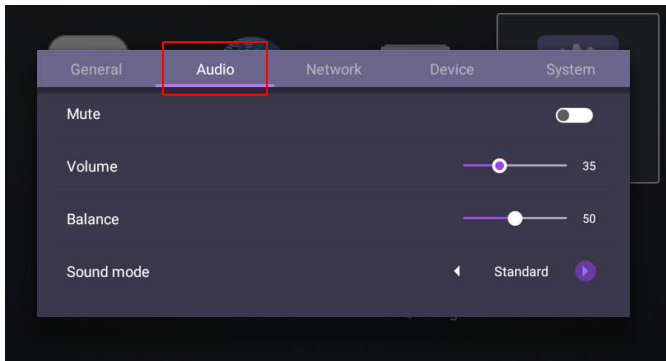

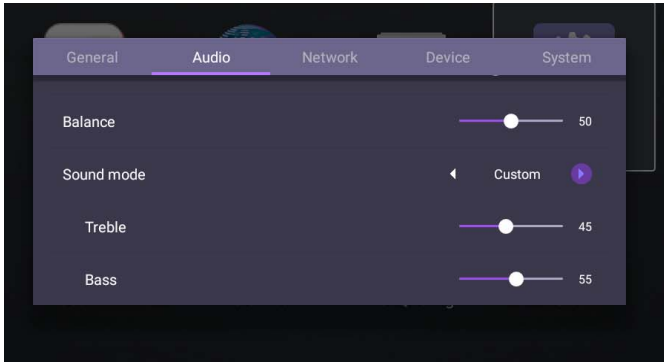

- Press **▲/▼/◀/▶** on the remote control and press **OK** to adjust the settings.
- Press **↩** on the remote control to exit the menu.
- Press **◀/▶** on the remote control to enable or disable **Mute**.

Menu	Description
<b>Volume</b>	Press <b>◀/▶</b> on the remote control to adjust the volume.
<b>Balance</b>	Press <b>◀/▶</b> on the remote control to adjust the balance.
<b>Sound mode</b>	Select a preset sound environment. Options are <b>Standard</b> , <b>Class</b> , <b>Meeting</b> , <b>Movie</b> , or <b>Custom</b> .
<b>Treble</b>	Press <b>◀/▶</b> on the remote control to adjust the treble.
<b>Bass</b>	Press <b>◀/▶</b> on the remote control to adjust the bass.

## Device settings

Go to **Device** to enter the **Device** menu.

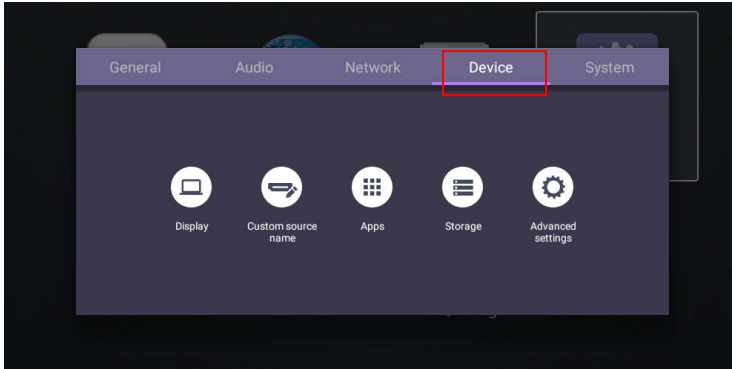

### Display

Go to **Device > Display**.

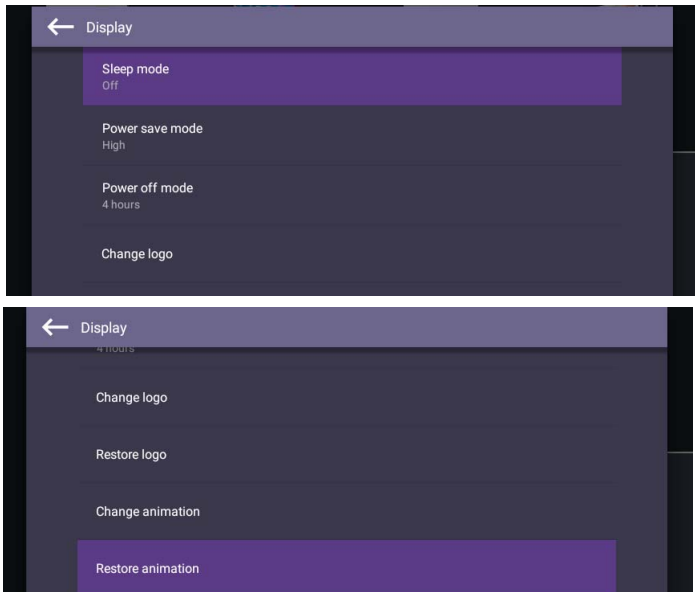

Menu	Description
<b>Sleep mode</b>	This feature only works on Android input. <ul style="list-style-type: none"> <li>• Select a time period (1, 5, 10, 20, 30, 40, 50 minutes) for the display to turn off the panel back light.</li> <li>• Set to <b>Off</b> to turn off the function.</li> </ul>

<b>Power save mode</b>	<p>This feature only works on HDMI input.</p> <ul style="list-style-type: none"> <li>• High: Power off the display five minutes later.</li> <li>• Low: Turn off the panel back light five minutes later.</li> <li>• Off: Turn off the function.</li> </ul>
<b>Change logo</b>	<ul style="list-style-type: none"> <li>• Copy the boot logo file (JPG format, *.jpg, with resolution supports the display) to USB drive under “benq” folder. Rename the image to “logo.jpg”.</li> <li>• Click <b>Change logo</b> to load the changed logo.</li> </ul>
<b>Restore logo</b>	Click <b>Restore logo</b> to restore the original logo.
<b>Change animation</b>	<ul style="list-style-type: none"> <li>• Copy animation zip file (&lt;2MB) to USB drive under “benq” folder. Rename the file to “bootanimation.zip”.</li> <li>• Click <b>Change animation</b> to load the changed animation.</li> </ul>
<b>Restore animation</b>	Click <b>Restore animation</b> to restore the original animation.

### Custom source name

You can change Custom source name. Enter a value within six characters long.

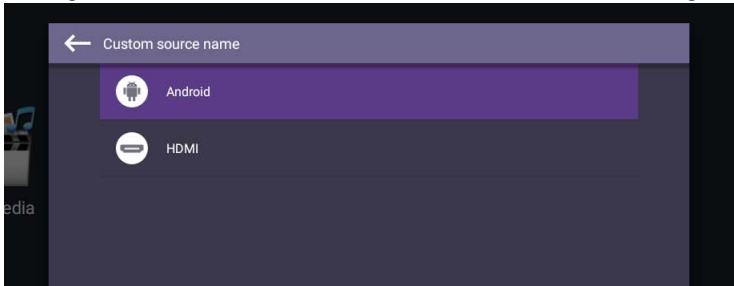

### Advanced settings

Go to **Device > Advanced settings**.

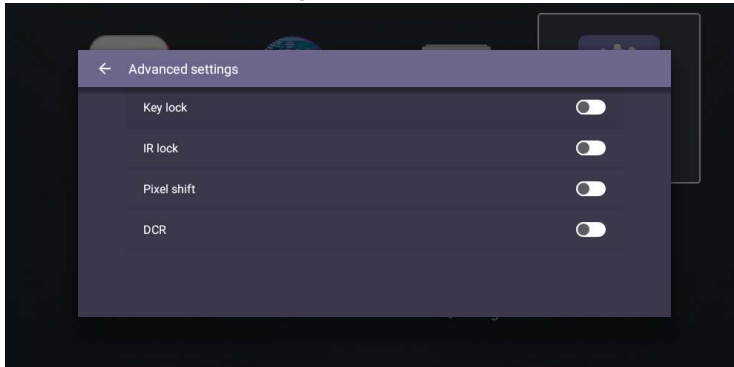

- Press **▲/▼/◀/▶** on the remote control and press **OK** to confirm.

- Press  on the remote control to exit the menu.

Menu	Description
<b>Key lock</b>	Press ◀ / ▶ and <b>OK</b> on the remote control to enable or disable <b>Key lock</b> .
<b>IR lock</b>	Press ◀ / ▶ and <b>OK</b> on the remote control to enable or disable <b>IR lock</b> .
<b>Pixel shift</b>	Press ◀ / ▶ and <b>OK</b> on the remote control to set a pixel shift preventing from image retention.
<b>DCR</b>	Press ◀ / ▶ and <b>OK</b> on the remote control to enable or disable <b>DCR</b> .



- The **Key lock** and **IR lock** functions can be enabled at the same time.
- For image retention, please see [Notes on the LCD panel of this display on page 7](#) for more information.

## Proxy setting

- Go to **Network > Proxy**.

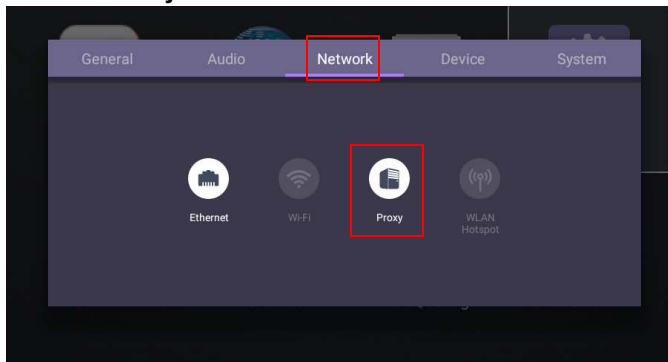

- Check the box of **Proxy Switch** to enable or disable the function.

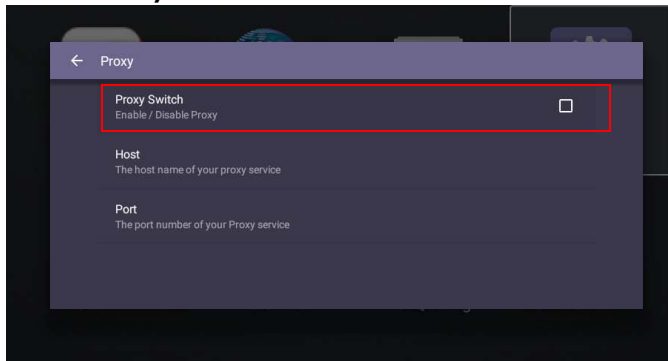

- Enter the proxy host name.

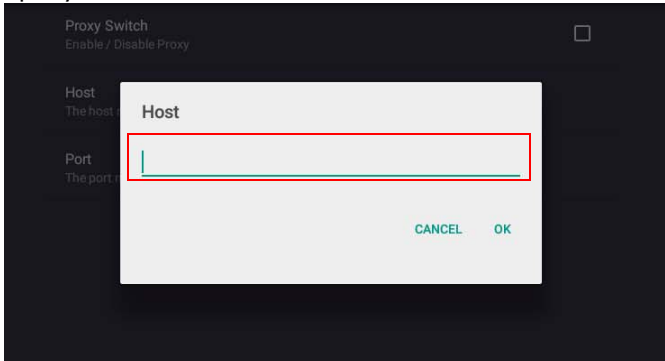

- Enter the using channel.

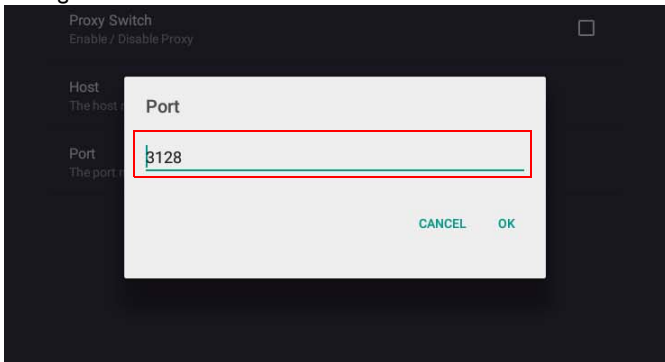



## System settings

Go to **System** to enter the **System** menu.

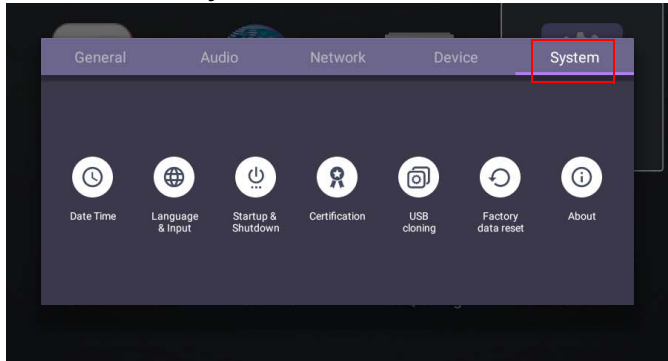

- Press **▲/▼/◀/▶** on the remote control and press **OK** to confirm.
- Press **⏪** on the remote control to exit the menu.

Options	Description
<b>Date &amp; time</b>	Select to set date, time, and their formats in Android.
<b>Language &amp; input</b>	Select to set <b>Language, Keyboard &amp; Input methods</b> in Android.
<b>Startup &amp; Shutdown</b>	Select to set <b>Startup channel, Wake on LAN, and Power off reminder</b> . Refer to <a href="#">Startup &amp; Shutdown on page 34</a> for more information.
<b>Factory data reset</b>	Select <b>Factory data reset</b> to erase all data from the display.
<b>About</b>	Select to view system information in Android.



The amount of available storage space for the user varies according to the amount of pre-installed apps and images occupying the total storage space.

## Startup & Shutdown

- Go to **System > Startup & Shutdown**.

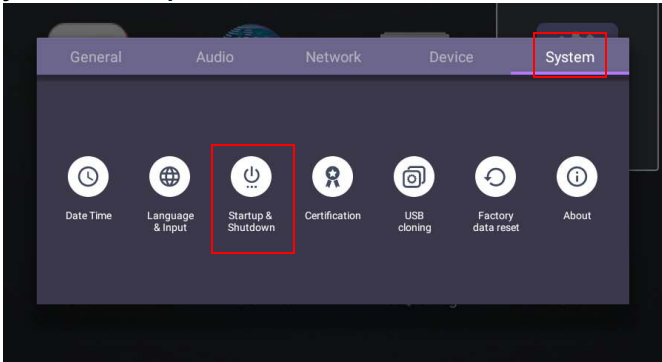

- For **Startup channel**, you can choose **Last channel** or other sources.

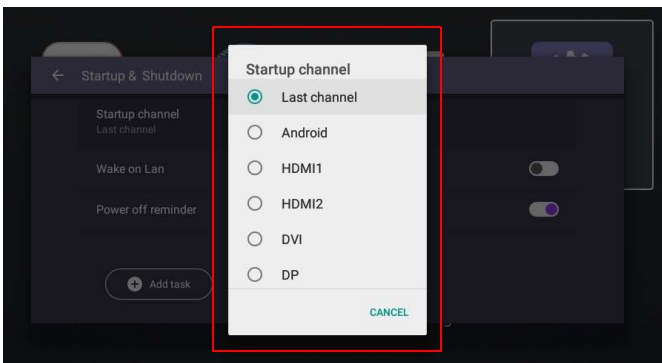
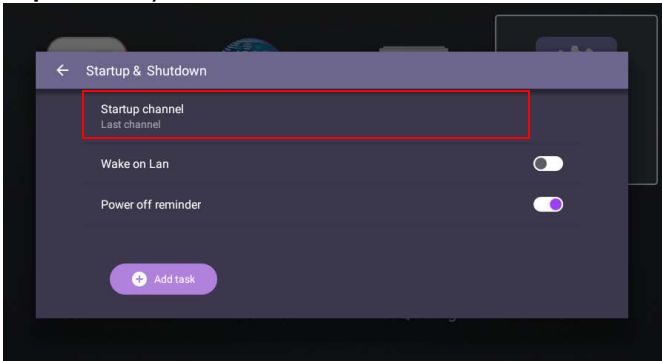

- For **Power off reminder**, you can adjust startup and shutdown time. Schedules can be made by choosing the days of the week.

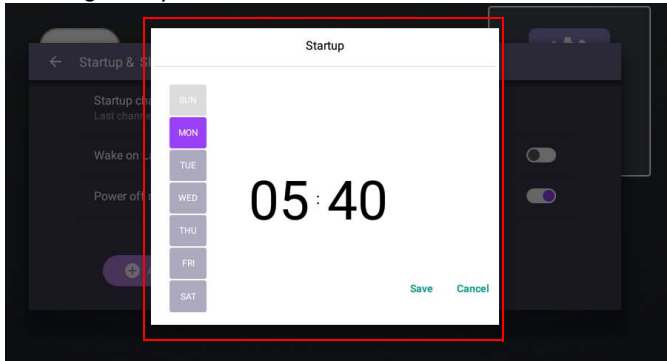

## Other Input

### Display settings

Leave the Android system and connect to other input sources like VGA or HDMI. Then go to **Display**.

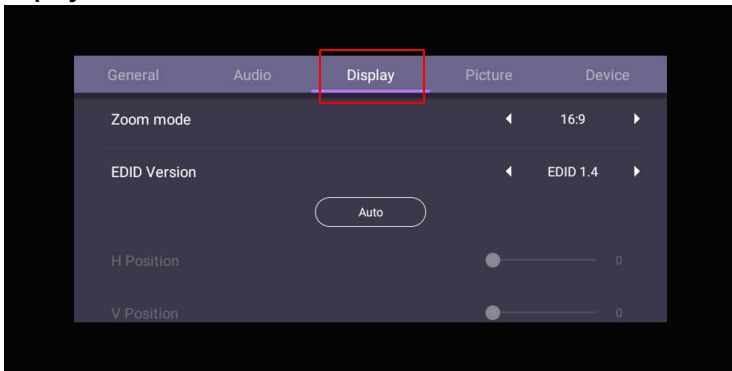

- Press **▲/▼/◀/▶** on the remote control and press **OK** to confirm.
- Press **⏪** on the remote control to exit the menu.

Menu	Description
<b>Zoom mode</b>	Press <b>◀/▶</b> on the remote control. Options are <b>16:9, 4:3, 1:1, Full</b> . You can also select <b>Auto</b> to adjust the image.
<b>EDID Version</b>	Press <b>◀/▶</b> on the remote control and press <b>OK</b> to confirm. Options are <b>EDID 1.4, EDID 2.0</b> .

- The display automatically enters energy saving mode when no one is detected within the sensor's range.
- The display automatically turns off when no one is detected within the sensor's range for a long period of time.

## Adjust settings (VGA-only)

Use the **H. Position**, **V. Position**, **Clock**, and **Phase** functions to manually adjust the image.

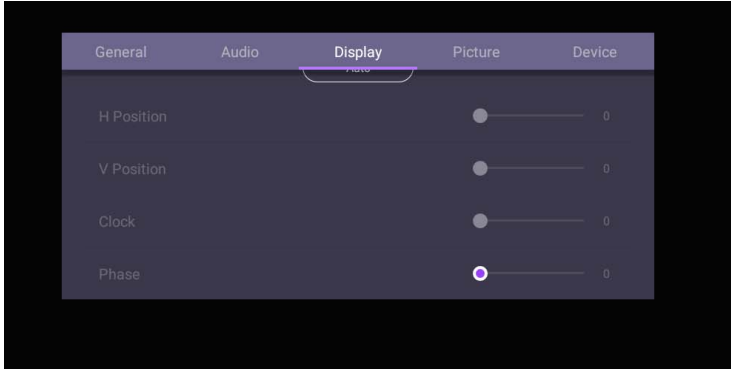



Menu	Description
<b>H. Position</b>	Press ◀ / ▶ on the remote control to move the screen to the left or right.
<b>V. Position</b>	Press <b>OK</b> on the remote control to lock or unlock the remote control IR sensor on the front panel of the display.
<b>Clock</b>	<b>Clock</b> adjusts how wide the input pixels are. Press ◀ / ▶ on the remote control to make adjustments.
<b>Phase</b>	<b>Phase</b> is in relation to frequency. Press ◀ / ▶ on the remote control to make adjustments.

## Picture settings

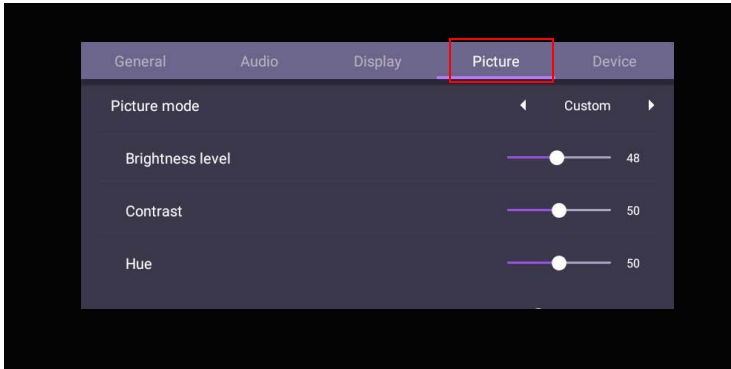
Leave the Android system and connect to other input sources like VGA or HDMI. Then go to **Picture**.

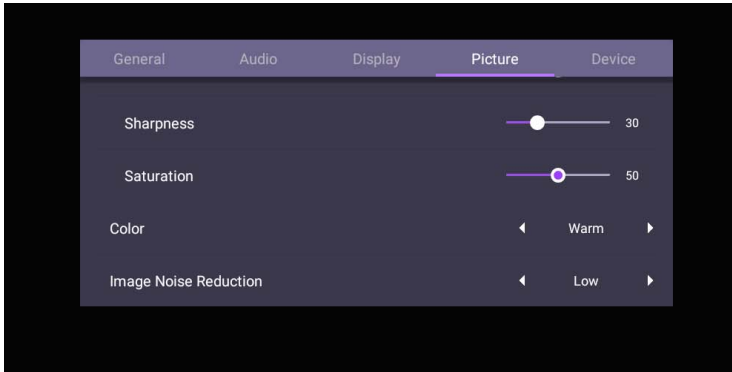



- Press  $\blacktriangle/\blacktriangledown/\blacktriangleleft/\blacktriangleright$  on the remote control and press **OK** to confirm.
- Press  on the remote control to exit the menu.

Menu	Description
<b>Picture mode</b>	Press $\blacktriangleleft/\blacktriangleright$ on the remote control. Options are <b>Custom, Standard, Bright, Soft</b> .
<b>Brightness</b>	Press $\blacktriangleleft/\blacktriangleright$ on the remote control to adjust the brightness.
<b>Contrast</b>	Press $\blacktriangleleft/\blacktriangleright$ on the remote control to adjust the contrast.
<b>Hue</b>	Press $\blacktriangleleft/\blacktriangleright$ on the remote control to adjust the hue.
<b>Sharpness</b>	Press $\blacktriangleleft/\blacktriangleright$ on the remote control to adjust the sharpness.
<b>Saturation</b>	Press $\blacktriangleleft/\blacktriangleright$ on the remote control to adjust the saturation.
<b>Color</b>	Press $\blacktriangleleft/\blacktriangleright$ on the remote control or click a preset color temperature for the image. Options are <b>Cool, Warm, Standard</b> .
<b>Image Noise Reduction</b>	Press $\blacktriangleleft/\blacktriangleright$ on the remote control. Options are <b>Off, Low, Middle, High</b> .

# Android system interface



Note that this is a closed Android OS. Download and use of unauthorized apps on this system are not available.

## Main interface

The display launches the Android main interface by default.

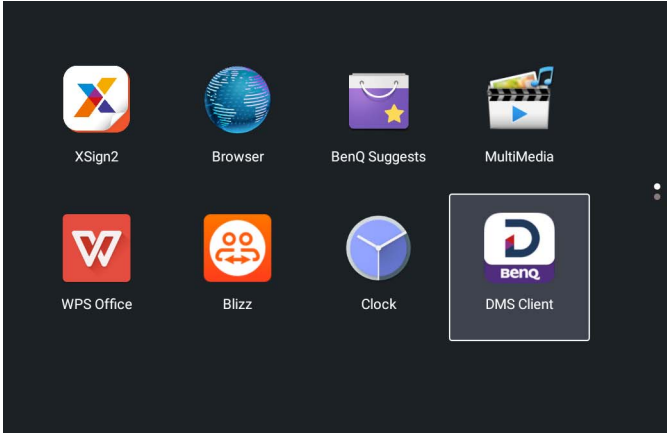

To navigate the Android main interface, press **MENU** on the remote control to enter the OSD menu to select an input.











## Multimedia files

Multimedia files such as images, audio files, and videos can be played by directly tapping on the file icon.

### Picture

Select a file you want to show on the display and perform any of the functions shown on the screen.



Icon	Function
	Play the previous image.
	Play/pause the current playback.
	Play the next image.
	Magnify the current image.
	Shrink the current image.
	Rotate the current image counter-clockwise.
	Rotate the current image clockwise.
	See the information about the file name, creation time, file size, and the file format.
	Without function.
	Playing settings. <ul style="list-style-type: none"> <li>• Animation effect is without function.</li> <li>• You can select playing interval time.</li> </ul>

**Supported image format (maximum resolution)**

Image	Photo	Resolution (width x height)
JPEG	Base-line	1920 x 1080
	Progressive	1024 x 768
PNG	Non-interlace	1920 x 1080
	Interlace	1920 x 1080
BMP		15360 x 8640

**Song**

Select an audio file you want to play and perform any of the functions shown on the screen.



Icon	Function
	Play the previous audio file.
	Play/pause the current playback.
	Play the next audio file.
	<ul style="list-style-type: none"> <li>• Repeatedly play one audio file in the playlist.</li> <li>• Repeatedly play the whole audio files in the playlist.</li> <li>• Shuffle Play. The audio files play in a random order.</li> </ul>
	Check audio files in the playlist.
	See the information about the file name, file duration, artist name, file format, audio codec, and the file path.



**Supported audio format (Codec)**

Audio Codec	Sample rate	Channel	Bit rate	Container
MPEG1/ 2 Layer1	16KHz~ 48KHz	Up to 2	32Kbps~ 448Kbps	MP3 (.mp3) AVI (.avi)
MPEG1/ 2 Layer2	16KHz~ 48KHz	Up to 2	8Kbps~ 384Kbps	ASF (.asf) DivX (.divx) Matroska (.mkv, .mka)
MPEG1/2/2.5 Layer3	8KHz~ 48KHz	Up to 2	8Kbps~ 320Kbps	3GPP (.3gpp, .3gp) MP4 (.mp4, .mov, m4a) MPEG transport stream (.ts, .trp, .tp) MPEG program stream (.DAT, .VOB, .MPG, .MPEG) FLV (.flv) WAV (.wav)
AC3	32KHz, 44.1KHz, 48KHz	Up to 5.1	32Kbps~ 640Kbps	AC3 (.ac3) AVI (.avi) DivX (.divx) Matroska (.mkv, .mka) 3GPP (.3gpp, .3gp) MP4 (.mp4, .mov, m4a) MPEG transport stream (.ts, .trp, .tp) MPEG program stream (.DAT, .VOB, .MPG, .MPEG)

Audio Codec	Sample rate	Channel	Bit rate	Container
EAC3	32KHz, 44.1KHz, 48KHz	Up to 5.1	32Kbps~ 6Mbps	EC3 (.ec3) 3GPP (.3gpp, .3gp) MP4 (.mp4, .mov, m4a) MPEG transport stream (.ts, .trp, .tp) MPEG program stream (.DAT, .VOB, .MPG, .MPEG)
AAC, HEAAC	8KHz~ 48KHz	Up to 5.1	AAC-LC: 12kbps~576kbps V1: 6kbps~288kbps V2: 3kbps~144kbps	AAC (.aac) AVI (.avi) Matroska (.mkv, .mka) DivX (.divx) 3GPP (.3gpp, .3gp) MP4 (.mp4, .mov, m4a) MPEG transport stream (.ts, .trp, .tp) MPEG program stream (.DAT, .VOB, .MPG, .MPEG) FLV (.flv) RM (.rm, .rmvb, .ra) WAV (.wav)
WMA	8KHz~ 48KHz	Up to 2	128bps~320Kbps	ASF (.wma, .wmv, .asf) AVI (.avi) Matroska (.mkv, .mka) WAV (.wav)  *WMA7, WMA8, WMA 9 Standard

Audio Codec	Sample rate	Channel	Bit rate	Container
WMA 10 Pro M0	8KHz~ 48KHz	Up to 2	< 192kbps	ASF (.wma, .wmv, .asf)
WMA 10 Pro M1	8KHz~ 48KHz	Up to 5.1	< 384kbps	AVI (.avi)
WMA 10 Pro M2	8KHz~ 96KHz	Up to 5.1	< 768kbps	Matroska (.mkv, .mka) WAV (.wav)
VORBIS	Up to 48KHz	Up to 2		Matroska (.mkv, .mka) WebM (.webm) 3GPP (.3gpp, .3gp) MP4 (.mp4, .mov, .m4a)  *Supports stereo decoding only
DTS	Up to 48KHz	Up to 5.1	< 1.5Mbps (Pure DTS core)	MPEG transport stream (.ts, .trp, .tp) MPEG program stream (.DAT, .VOB, .MPG, .MPEG) WAV (.wav) Matroska (.mkv, .mka)
LPCM	8KHz~ 48KHz	Mono, Stereo, 5.1	64Kbps~1.5Mbps	WAV (.wav) AVI (.avi) Matroska (.mkv, .mka) 3GPP (.3gpp, .3gp) MP4 (.mp4, .mov, .m4a) MPEG transport stream (.ts, .trp, .tp) MPEG program stream (.DAT, .VOB, .MPG, .MPEG)









Audio Codec	Sample rate	Channel	Bit rate	Container
IMA-ADPCM MS-ADPCM	8KHz~ 48KHz	Up to 2	32Kbps~ 384Kbps	WAV (.wav) AVI (.avi)
G711 A/mu-law	8KHz	1	64Kbps	Matroska (.mkv, .mka) 3GPP (.3gpp, .3gp) MP4 (.mp4, .mov, .m4a)
LBR (cook)	8KHz 11.025KHz? 22.05KHz?44 .1KHz	Up to 5.1	6Kbps~128Kbps	Matroska (.mkv, .mka) RM (.rm, .rmvb, .ra)
FLAC	8KHz~ 96KHz	Up to 7.1	< 1.6Mbps	Matroska (.mkv, .mka)
DRA	8KHz~ 96KHz	Up to 7.1	< 6Mbps	MPEG transport stream (.ts, .trp)

### Video

Select a video file you want to play on the display and perform any of the functions shown on the screen.



Icon	Function
	Play the previous video file.
	Fast rewind the current video.
	Play/pause the current playback.

	Fast forward the current video.
	Play the next video file.
	Playing progress.
	Check video files in the playlist.
	Without function.
	See the information about the file name, file duration, file size, file format, audio codec, and video codec.
	<ul style="list-style-type: none"> <li>• Repeatedly play one video file in the playlist.</li> <li>• Repeatedly play the whole video files in the playlist.</li> <li>• Shuffle Play. The video files play in a random order.</li> </ul>
	Adjust the volume.

### Supported video format (Codec) Up to 4K resolution:

Video Codec	Resolution	Bit rate	Profile	Container
VP9	4096x2160@60fps	100Mbps	.Profile 0, (420, 8bit) .Profile 2, (420, 10bit)	MKV (.mkv) WebM (.webm)
HEVC/ H.265	4096x2160@60fps	100Mbps	Main/Main 10 Profile, High Tier@Level 5.1	MP4 (.mp4, .mov) 3GPP (.3gpp, .3gp) MPEG transport stream (.ts, .trp, .tp) MKV (.mkv)

Video Codec	Resolution	Bit rate	Profile	Container
MPEG1/2	1080P@30fps	40Mbps	MP@HL	MPEG program stream (.DAT, .VOB, .MPG, .MPEG) MPEG transport stream (.ts, .trp, .tp) MP4 (.mp4, .mov) 3GPP (.3gpp, .3gp) AVI (.avi) MKV (.mkv)
MPEG4	1080P@30fps	40Mbps	Simple Profile Advanced Simple Profile@Level 5 GMC is not supported	MP4 (.mp4, .mov) 3GPP (.3gpp, .3gp) AVI (.avi) MKV (.mkv)
DivX 3.11, DivX 4.12, DivX 5.x, DivX 6, XviD	1080P@30fps	40Mbps		DivX (.divx) MP4 (.mp4, .mov) AVI (.avi) MKV (.mkv)
Sorenson H.263	1080P@30fps	40Mbps		FLV (.flv) AVI (.avi)
H.263	1080P@30fps	40Mbps		FLV (.flv) MP4 (.mp4, .mov) 3GPP (.3gpp, .3gp) AVI (.avi) MKV (.mkv)

Video Codec	Resolution	Bit rate	Profile	Container
H.264	1080Px2@30fps 1080P@60fps	62.5Mbps	Main Profile High Profile@Level 4.2	FLV (.flv) MP4 (.mp4, .mov) 3GPP (.3gpp, .3gp) MPEG transport stream (.ts, .trp, .tp) ASF (.asf) WMV (.wmv) AVI (.avi) MKV (.mkv)
MVC	1080P@30fps	62.5Mbps		MPEG transport stream (.ts, .trp, .tp)
AVS	1080P@60fps	50Mbps	Jizhun profile@Level 6.0	3GPP (.3gpp, .3gp) MP4 (.mp4, .mov) MPEG transport stream (.ts, .trp, .tp)
AVS+	1080P@60fps	60Mbps	Broadcasting profile@Level 6.0.1.08.60	3GPP (.3gpp, .3gp) MP4 (.mp4, .mov) MPEG transport stream (.ts, .trp, .tp)
WMV3	1080P@30fps	40Mbps		ASF (.asf) AVI (.avi) MKV (.mkv) WMV (.wmv)

Video Codec	Resolution	Bit rate	Profile	Container
VCI	1080P@30fps	40Mbps	Advanced Profile@Level 3 Simple Profile Main Profile	MPEG transport stream (.ts, .trp, .tp) ASF (.asf) WMV (.wmv) AVI (.avi) MKV (.mkv)
Motion JPEG	1280x720@30fps	40Mbps		AVI (.avi) 3GPP (.3gpp, .3gp) MP4 (.mp4, .mov) MKV (.mkv)
VP8	1920x1080@30fps	20Mbps		MKV (.mkv) WebM (.webm)
RV30/RV40	1080P@60fps	40Mbps		RM (.rm, .rmvb) MKV (.mkv)





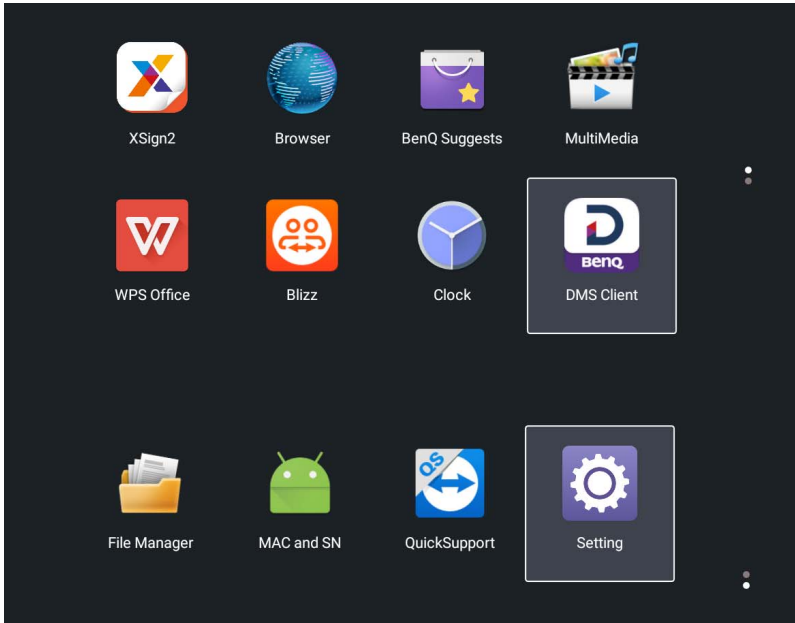





# APPS



Select the application that you want to access. Using the remote control: Press the ▲ / ▼ / ◀ / ▶ button to select your desired application and press the **OK** button to launch the application.

## About All Apps

To operate the Android OS, use the buttons on the remote control.

Application Name/Icon	Description
<b>X-Sign</b> (  )	Edit contents with X-Sign Designer. Refer to <a href="#">X-Sign on page 51</a> for more information.
<b>Browser</b> (  )	Access the web pages. Refer to <a href="#">Browser on page 50</a> for more information.
<b>BenQ Suggests</b> (  )	Show the Android apps suggested by BenQ. Refer to <a href="#">BenQ Suggests on page 52</a> for more information.
<b>MultiMedia</b> (  )	A media player for picture/ music/ video.
<b>WPS Office</b> (  )	Read and edit the files in Office formats, including, *.doc, *.txt, *.xls, and *.ppt. Refer to <a href="#">WPS Office on page 53</a> for more information.
<b>Blizz</b> (  )	Allow a video conference meeting with any other <b>Blizz</b> users. Refer to <a href="#">Blizz on page 55</a> for more information.
<b>Clock</b> (  )	Show current time in full screen.
<b>DMS Client</b> (  )	Device management solution, which allows remote configuration and monitoring.



Check file location. Please use **MultiMedia** to play content.

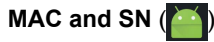

Check MAC address and serial number.



Configure the network and device settings. Refer to [Menu operations on page 27](#) for more information.

## Browser

Tap to launch **Browser**. With this application, you can view web pages.



Before launching the application, make sure your display is properly connected to the Internet.

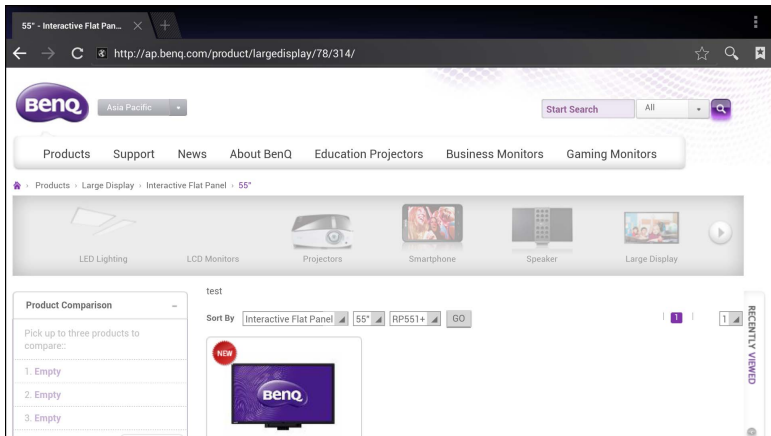

Tap the icon on the top panel to activate its function. Slide on the screen to scroll the viewed page.

Function	Description
Address Bar	Enter the web page address to view the page.
Settings (⋮)	Tap to configure the browser settings.
Back (←)	Tap to return to the previous page.
Next (→)	Tap to go to the next page.
Refresh (↻)	Tap to reload the current web page.
Favorite (☆)	Tap to save the current web page to bookmarks.
Search (🔍)	Tap to search the Internet.
Bookmarks (🔖)	Tap to select bookmarks, history, or saved favorite web pages to visit.
Close (✕)	Tap to close the current web page.

## X-Sign

Tap  to launch **X-Sign**. **X-Sign** is a content player app. Users can edit contents with X-Sign Designer by their PCs or laptops.



After editing the contents, users can import the file to the display through USB flash drive. The contents will then be played automatically.



X-Sign Designer can be downloaded from BenQ website. Please refer to the postcard in the accessory pack for the instructions.

## BenQ Suggests

Tap  to launch **BenQ Suggests**. With this application, you can view apps suggested by BenQ for download.

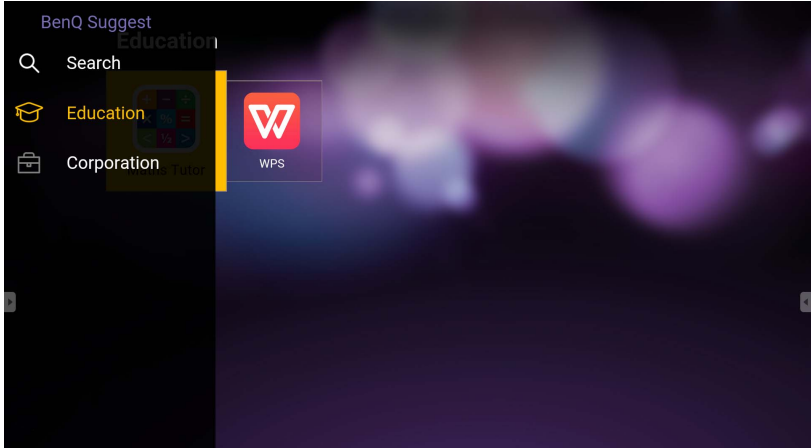

Tap the category on the left panel to browse the suggested apps. Tap an app from the selected category to view a basic description of the app.

Function	Description
<b>Search</b> (🔍)	Tap to search for an app.
<b>Education</b> (🎓)	Tap to show the suggested apps in the <b>Education</b> category.
<b>Corporation</b> (💼)	Tap to show the suggested apps in the <b>Corporation</b> category.
<b>Exit</b> (⏪)	Tap to close <b>BenQ Suggests</b> .

## WPS Office

Tap  to launch **WPS Office**. With this application, you can open document files including PDFs as well as Microsoft Word, PowerPoint and Excel documents.

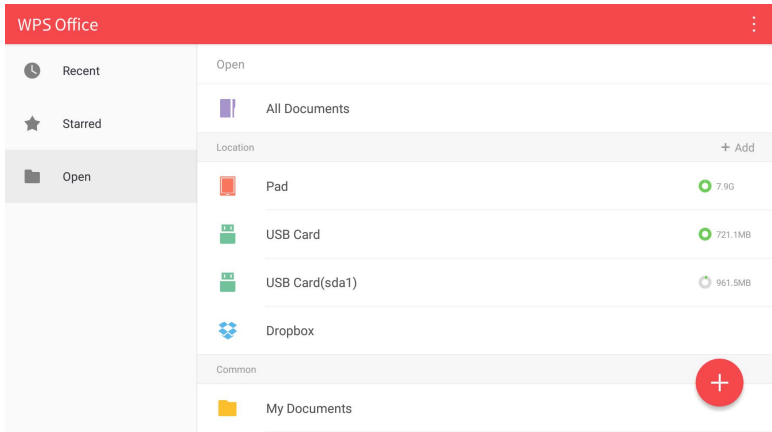

To edit a file with **WPS Office**:

Function	Description
<b>Open</b>	Tap to browse and open a file.
<b>Share</b>	Tap to share your files through email or other sharing applications.
<b>Manage</b>	Tap to edit or manage the document.

1. Tap **Open** (  ) on the left panel to browse and open a file located in either the display's internal memory, an external storage device, or cloud storage.
2. Tap the function menu on the top panel to access the file format's various functions.



The description below is for a PowerPoint file, the function menus for other file formats will vary.

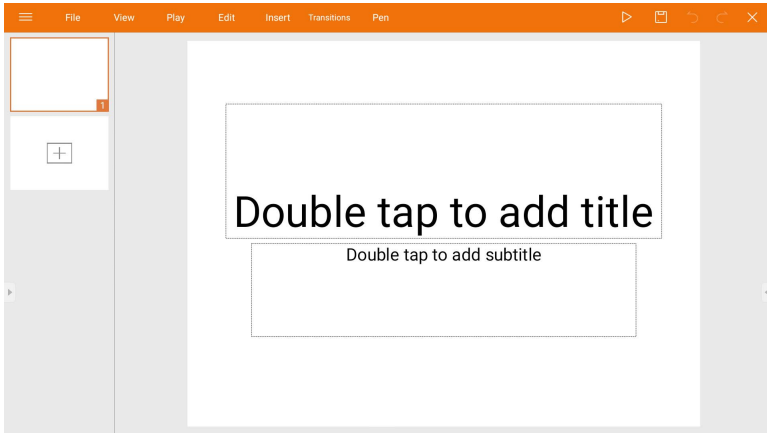

Function	Description
<b>File</b>	Tap to open, save, share, print, and manage your presentations.
<b>View</b>	Tap to change or edit the presentation views.
<b>Play</b>	Tap to start or set up a slide show.
<b>Edit</b>	Tap to edit the content or format of the slides.
<b>Insert</b>	Tap to insert tables, pictures, charts, comments, video, or audio.
<b>Transitions</b>	Tap to apply or adjust the timing of a transition.
<b>Pen</b>	Tap to write, draw, paint or sketch to the slides.
<b>Play (▷)</b>	Tap to start a slide show.
<b>Save As (📁)</b>	Tap to save the presentation file on either the display's internal memory, an external storage device, or cloud storage.
<b>Undo (↶)</b>	Tap to undo an action.
<b>Redo (↷)</b>	Tap to redo the last action.
<b>Close (✕)</b>	Tap to close the presentation file.
<b>Back (←)</b>	Tap to return to the previous page.
<b>Next (→)</b>	Tap to go to the next page.
<b>Exit (⏏)</b>	Tap to exit <b>WPS Office</b> .

## Supported Office versions and file formats

Supported Office versions: 97 / 2000 / XP / 2003 / 2007 / 2010

Supported Office software formats:

Office Software	Supported File Formats
Word	wps / wpt / doc / docx / dot / dotx / txt / log / irc / c / cpp / h / asm / s / java / asp / bat / bas / prg / cmd
Excel	et / ett / xls / xlsx / xlt / xlsx / csv / xlsx / xltm
PowerPoint	ppt / pptx

## Blizz

**Blizz** is a video-conferencing app that is installed in the display by default. It allows you to conveniently conduct video conference meetings with any other **Blizz** users.

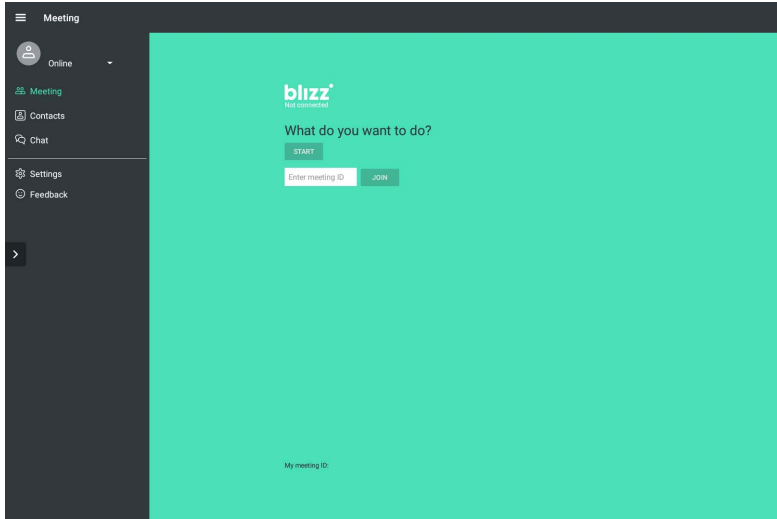

1. On the home screen, select **Apps >Blizz** ()
2. Select **Sign In** if you want to create a new meeting, select **Join a Meeting** if you want to join an already created meeting.
  - After signing in, create a meeting ID which will be the meeting ID other users will enter to join the meeting.
  - If joining a meeting, enter the meeting ID provided by the creator of the meeting in the Join a Meeting page.

# Product information

## Specifications

Item		Specifications
		ST4301K/ST5501K
LCD panel	Backlight	D-LED
	Panel size	ST4301K: 43" ST5501K: 55"
	Pixel pitch (mm)	ST4301K: 0.4902(H) x 0.4902(V) ST5501K: 0.315(H) x 0.315(V)
	Frame Rate	60 Hz
	Native resolution (pixels)	UHD 3840 x 2160
	Active Area (mm)	ST4301K: 941.2(H) × 529.4(V) ST5501K: 1209.6(H) × 680.4(V)
	Brightness (cd/m <sup>2</sup> ) (typical)	350 nits
	Contrast (typical)	ST4301K: 1100:1 ST5501K: 1200:1
	Response time (ms) (typical)	6
	Panel Bit	10 bit (1.07B)
	Aspect Ratio	16:9
Input	Video	VGA x 1, HDMI x 2 (1.4 x 2), DVI x 1, DP x 1
	Audio	Line in (3.5mm), PC Audio input
	USB (Type A)	x3 (2.0 x 3)
	Control	RS232
Output	Audio	Line out (3.5mm)
	External speaker out (L/R)	X
Audio	Audio W (Amp)	ST4301K: 5W x2 ST5501K: 5W x2
	Internal speaker	O
Power	Supply	100 - 240 V AC, 50/60 Hz
	Consumption Max.	ST4301K: 98W ST5501K: 140W
	Consumption Standby	≤0.5W



Environment	Operating Temperature	ST4301K: 0°C ~ 40°C ST5501K: 0°C ~ 40°C
	Operating Humidity	ST4301K: 20% ~ 80% RH Non-Condensing ST5501K: 20% ~ 80% RH Non-Condensing (without condensation)
	Storage Temperature	ST4301K/ST5501K: -10°C ~ 60°C
	Storage Humidity	ST4301K: 10% ~ 90% RH Non-Condensing ST5501K: 10% ~ 90% RH Non-Condensing (without condensation)
	Display Orientation	Landscape & Portrait
Mechanical	Weight (without packing / with packing) (kg)	ST4301K: 10.4kg/14.0kg ST5501K: 15kg/20.8kg
	Dimensions (W x H x D) (mm)	ST4301K: 969.9 x 558.3 x 84.8(mm) ST5501K: 1243.2 x 714.0 x 69.6(mm)
	Bezel Dimension - T/B/L/R (mm)	ST4301K: 13.0 / 13.0 / 13.0 / 13.0 ST5501K: 13.9 / 13.9 / 13.9 / 13.9
Feature	Image setting	○
	Picture mode	○
	Sharpness enhancement	○
	10-bit color processing	○
	Source / volume control	○
	HDMI-HDCP	2.0
	Internal Temperature Sensor	○
	CEC Control	○
	FW Update	USB/OTA
	<b>Power Mode</b>	○
	<b>Boot Source</b>	○



Specifications and functions are subject to change without notice.

Item		ST4301K/ST5501K
System	System Memory	2 GB
	Storage	32 GB
	OS	Android 6.0



- OS: This Android 6.0 operating system is not standard Android, so access to Google Play™ is not available. APK cannot be installed in the default location. Without management permission, installing function won't work. There is no guarantee that the self-installed APK can function normally.
- Storage: Content storage may vary by the product supplied for your region. Pre-installed system and apps may take up some space.

# Dimensions ST4301K

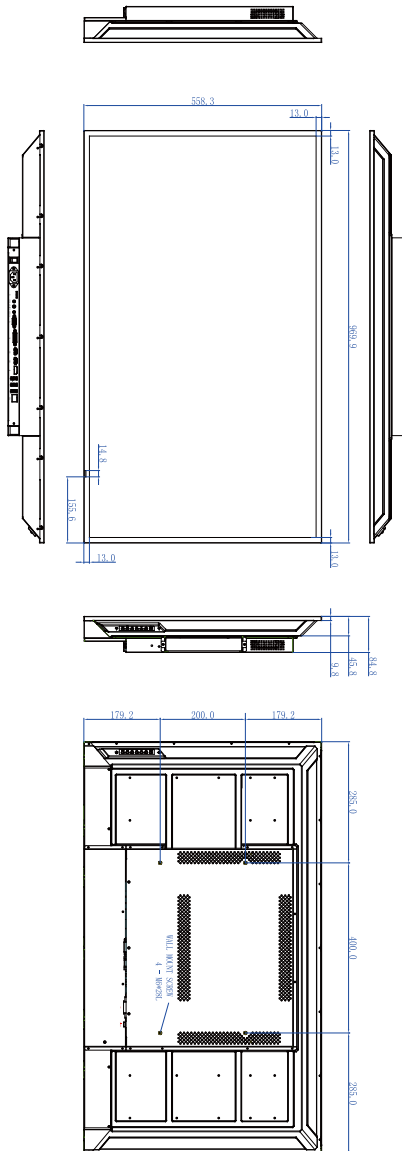

Unit: mm

# ST5501K

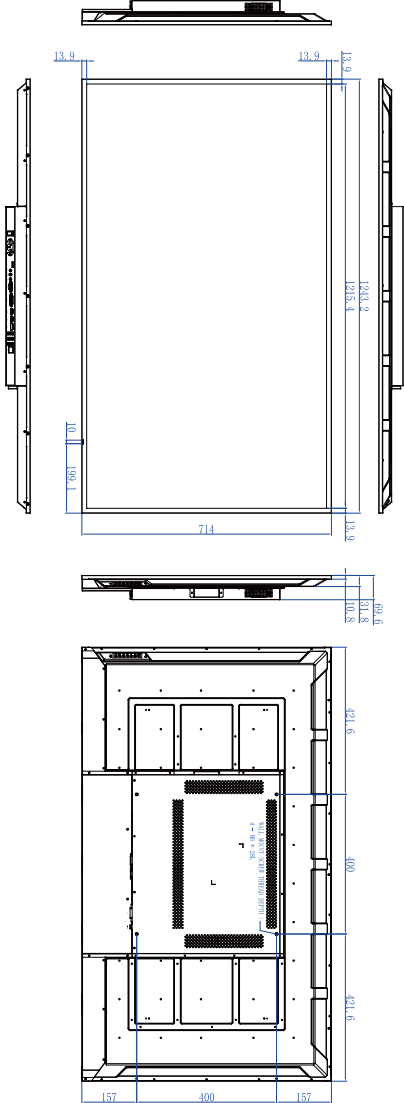

Unit: mm

## Supported input signal resolution

Resolution	Input source				
	VGA	DVI	HDMI 1.4	HDMI 2.0	DP
640 x 480 @ 60Hz	○	○		○	○
640 x 480 @ 67Hz					
640 x 480 @ 72Hz					
640 x 480 @ 75Hz					
720 x 400 @ 70Hz	○	○	○	○	○
800 x 600 @ 60Hz	○	○	○	○	○
800 x 600 @ 75Hz					
832 x 624 @ 75Hz					
1024 x 768 @ 60Hz	○	○	○	○	○
1024 x 768 @ 75Hz					
1152 x 870 @ 75Hz					
1280 x 720 @ 60Hz					
1280 x 768 @ 60Hz				○	○
1280 x 800 @ 60Hz					
1280 x 960 @ 60Hz	○	○	○	○	○
1280 x 1024 @ 60Hz	○	○	○	○	○
1360 x 768 @ 60Hz					
1366 x 768 @ 60Hz	○	○	○	○	○
1400 x 1050 @ 60Hz					
1440 x 900 @ 60Hz	○	○	○	○	○
1600 x 1200 @ 60Hz					
1680 x 1050 @ 60Hz	○	○	○	○	○
1600 x 1050 @ 60Hz					
1920 x 1080 @ 50Hz					
1920 x 1080 @ 60Hz	○	○	○	○	○
3840 x 2160 @ 30Hz			○	○	○
3840 x 2160 @ 50Hz				○	○
3840 x 2160 @ 60Hz				○	○
NTSC-M					
NTSC-J					
PAL-BDGIH					
480i (60Hz)			○	○	○

480p (60Hz)			○	○	○
576i (50Hz)			○	○	○
576p (50Hz)			○	○	○
720p (25Hz)					
720p (30Hz)					
720p (50Hz)			○	○	○
720p (60Hz)			○	○	○
1080i (50Hz)			○	○	○
1080i (60Hz)			○	○	○
1080p (24Hz)					
1080p (25Hz)					
1080p (30Hz)					
1080p (24Psf)					
1080p (25Psf)					
1080p (50Hz)			○	○	○
1080p (60Hz)			○	○	○



- ○: supported
- Blank: not supported

## Troubleshooting

Problem	Solution
No picture	<p>Check the following:</p> <ul style="list-style-type: none"> <li>• Is the display turned on? Check the power indicator of the display.</li> <li>• Is the signal source device turned on? Turn on the device and try again.</li> <li>• Are there any loose cable connections? Make sure that all cables are connected firmly.</li> <li>• Have you chosen an unsupported output resolution on the computer? Refer to <a href="#">Supported input signal resolution on page 60</a> to select a supported resolution and try again.</li> <li>• Have you chosen an unsupported output resolution on the DVD or Blu-ray disc player? Refer to <a href="#">Supported input signal resolution on page 60</a> to select a supported resolution and try again.</li> </ul>
No sound	<p>Check the following:</p> <ul style="list-style-type: none"> <li>• Have you turned on the mute function on the display or the input source device? Turn off the mute function or increase the audio volume level and try again.</li> <li>• Are there any loose cable connections? Make sure that all cables are connected firmly.</li> </ul>
The computer input image looks strange.	<ul style="list-style-type: none"> <li>• Have you chosen an unsupported output resolution on the computer? Refer to <a href="#">Supported input signal resolution on page 60</a> to select a supported resolution and try again.</li> <li>• Use the <b>Auto</b> function to let the display automatically optimize the display of computer image. Refer to <a href="#">Display settings on page 35</a> for more information.</li> <li>• If the result of the <b>Auto Tune</b> function is not satisfactory, use the <b>Phase</b>, <b>Horizontal Position</b>, and <b>Vertical Position</b> functions to manually adjust the image.</li> </ul>
The control panel buttons do not work.	<p>Have you locked the control panel buttons? Unlock the buttons and try again.</p>

---

<p>The remote control does not work.</p>	<ul style="list-style-type: none"><li>• Have you locked the remote control function? Unlock the function and try again.</li><li>• Check for incorrect battery orientation.</li><li>• Check for dead batteries.</li><li>• Check your distance and angle from the display.</li><li>• Check whether remote control is properly being pointed at the display's remote control sensor window.</li><li>• Check for any obstacle between the remote control and the remote control sensor window.</li><li>• Check that the remote control sensor window is not under strong fluorescent lighting, or in direct sunlight.</li><li>• Check for any devices (computer or personal digital assistant, PDA) nearby that transmit infrared signals which may cause interference to signal transmission between the remote control and the display. Turn off the infrared function of these devices.</li></ul>
--	--