



SL490/SL550
User Manual



Disclaimer

BenQ Corporation makes no representations or warranties, either expressed or implied, with respect to the contents of this document. BenQ Corporation reserves the right to revise this publication and to make changes from time to time in the contents thereof without obligation to notify any person of such revision or changes.

Copyright

Copyright 2016 BenQ Corporation. All rights reserved. No part of this publication may be reproduced, transmitted, transcribed, stored in a retrieval system or translated into any language or computer language, in any form or by any means, electronic, mechanical, magnetic, optical, chemical, manual or otherwise, without the prior written permission of BenQ Corporation.

Table of Contents

Safety warnings and precautions	1
Important safety instructions	2
Notes on the LCD panel of this display	2
Safety notice for remote control	3
Battery safety notice.....	3
BenQ ecoFACTS.....	4
Unpacking and Installation.....	5
Unpacking	5
Package Contents.....	5
Installation Notes	5
Mounting on a Wall	6
Mounting in Portrait Position	7
Parts and Functions.....	8
Control Panel.....	8
Input/Output Terminals.....	10
Remote control	11
Connecting External Equipment	18
Connecting External Equipment (DVD/VCR/VCD)	18
Connecting a PC.....	18
Connecting Audio Equipment.....	19
Connecting Multiple Displays in a Daisy-chain Configuration	20
IR connection.....	21
Operation	22
Watch the Connected Video Source.....	22
Change Picture Format.....	22
Android reminder page.....	22
Media Player introduction:.....	23
Browser manual.....	27
PDF reader play	34

signage display	39
Setting.....	39
Wi-Fi.....	39
Ethernet	40
Signage Display.....	41
System Tools	48
Storage	50
Apps.....	51
Date & time	52
Developer options	53
About.....	54
Supplementary.....	54
OSD Menu.....	56
Navigating the OSD Menu.....	56
OSD Menu Overview.....	57
USB device compatibility	79
Input Mode	81
Pixel Defect Policy	83
Pixels and Sub-Pixels.....	83
Types of Pixel Defects + Dot Definition.....	83
Bright Dot Defects.....	84
Dark Dot Defects	84
Proximity of Pixel Defects	85
Pixel Defect Tolerances	86
MURA.....	86
Cleaning and Troubleshooting	87
Cleaning.....	87
Troubleshooting	88
Technical Specifications.....	90

Safety warnings and precautions



The lightning flash with arrowhead symbol, within an equilateral triangle, is intended to alert the user to the presence of uninsulated "dangerous voltage" within the product's enclosure that may be of sufficient magnitude to constitute a risk of electric shock to persons.



The exclamation point within an equilateral triangle is intended to alert the user to the presence of important operating and maintenance (servicing) instructions in the literature accompanying the appliance.

THIS EQUIPMENT MUST BE GROUNDED

To ensure safe operation, the three-pin plug must be inserted only into a standard three-pin power outlet which is effectively grounded through normal household wiring. Extension cords used with the equipment must have three cores and be correctly wired to provide connection to the ground. Wrongly wired extension cords are a major cause of fatalities.

The fact that the equipment operates satisfactorily does not imply that the power outlet is grounded or that the installation is completely safe. For your safety, if you are in any doubt about the effective grounding of the power outlet, please consult a qualified electrician.

- The mains plug of the power supply cord shall remain readily operable. The AC receptacle (mains socket outlet) shall be installed near the equipment and shall be easily accessible. To completely disconnect this equipment from the AC mains, disconnect the power cord plug from the AC receptacle.
- Do not place this display on an uneven, sloping or unstable surface (such as a trolley) where it may fall and cause damage to itself or others.
- Do not place this display near water, like a spa or pool, or in a position which will allow the splashing or spraying of water onto the display, like in front of an open window where rain water may enter.
- Do not install this display in a confined space without proper ventilation and air circulation, such as in a closed cabinet. Allow proper space around the display for dissipating heat inside. Do not block any openings and vents on the display. Overheating may result in hazards and electric shock.
- Installation of this display should only be performed by a qualified technician. Failure to install this display properly may cause injuries and damages to the personnels and the display itself. Check the installation regularly and maintain the display periodically to ensure the best working condition.
- Use only the accessories approved or recommended by the manufacturer to mount this display. Using wrong or unsuitable accessories may cause the display to fall and result in serious personal injuries. Make sure that the surface and fixing points are strong enough to sustain the weight of the display.
- To reduce the risk of electric shock, do not remove covers. No user serviceable parts inside. Refer servicing to qualified service personnel.
- To prevent personal injuries, mounting the display or installing desktop stands is required before use.

Important safety instructions

1. Read these instructions.
2. Keep these instructions.
3. Heed all warnings.
4. Follow all instructions.
5. Do not use this apparatus near water.
6. Clean only with dry cloth.
7. Do not block any ventilation openings. Install in accordance with the manufacturer's instructions.
8. Do not install near any heat sources such as radiators, heat registers, stoves, or other apparatus (including amplifiers) that produce heat.
9. Do not defeat the safety purpose of the polarized or grounding-type plug. A polarized plug has two blades with one wider than the other. A grounding-type plug has two blades and a third grounding prong. The wide blade or the third prong are provided for your safety. If the provided plug does not fit into your outlet, consult an electrician for replacement of the obsolete outlet.
10. Protect the power cord from being walked on or pinched particularly at plugs, convenience receptacles, and the point where they exit from the apparatus.
11. Only use attachments/accessories specified by the manufacturer.
12. Use only with the cart, stand, tripod, bracket, or table specified by the manufacturer, or sold with the apparatus. When a cart is used, use caution when moving the cart/apparatus combination to avoid injury from tip-over.
14. Unplug this apparatus during lightning storms or when unused for long periods of time.
15. Refer all servicing to qualified service personnel. Servicing is required when the apparatus has been damaged in any way, such as power-supply cord or plug is damaged, liquid has been spilled or objects have fallen into the apparatus, the apparatus has been exposed to rain or moisture, does not operate normally, or has been dropped.



Notes on the LCD panel of this display

- The Liquid Crystal Display (LCD) panel of this display has a very thin protective layer of glass which is liable to marking or scratching, and cracking if struck or pressured. The liquid crystal substrate is also liable to damage under excessive force or extreme temperatures. Please handle with care.
- The response time and brightness of the LCD panel may vary with the ambient temperature.
- Avoid placing the display in direct sun or where direct sun or spot lighting will shine onto the LCD panel, as the heat may damage the panel and the external casing of the display, and the bright light will make viewing the display more difficult than necessary.
- The LCD panel consists of individual pixels to display images and is manufactured according to the design specifications. While 99.9% of these pixels work normally, 0.01% of the pixels may remain constantly lit (in red, blue or green) or unlit. This is a technical limitation of the LCD technology and is not a defect.

- LCD screens, like plasma (PDP) and conventional CRT (Cathode Ray Tube) screens, are also susceptible to 'screen burn-in' or 'image retention' which can be found on the screen as visible fixed lines and shades. To avoid such damage to the screen, avoid displaying still images (like On-Screen Display menus, TV station logos, fixed/inactive text or icons) for more than two hours. Change the aspect ratio from time to time. Fill the entire screen with the image and eliminate the black bars whenever possible. Avoid displaying images in 4:3 aspect ratio over a long period of time, otherwise there may be visible burn marks on the screen as two vertical lines.

Note: Under certain circumstances, condensation may occur on the inner side of the cover glass, it's a natural phenomenon and will not affect the operation of the display. This condensation will usually disappear after around 2 hours of normal operation.

Safety notice for remote control

- Do not put the remote control in the direct heat, humidity, and avoid fire.
- Do not drop the remote control.
- Do not expose the remote control to water or moisture. Failure to do so could result in malfunction.
- Confirm there is no object between the remote control and the remote sensor of the product.
- When the remote control will not be used for an extended period, remove the batteries.

Battery safety notice

The use of the wrong type of batteries may cause chemical leaks or explosion. Please note the following:

- Always ensure that the batteries are inserted with the positive and negative terminals in the correct direction as shown in the battery compartment.
- Different types of batteries have different characteristics. Do not mix different types.
- Do not mix old and new batteries. Mixing old and new batteries will shorten battery life or cause chemical leaks from the old batteries.
- When batteries fail to function, replace them immediately.
- Chemicals which leak from batteries may cause skin irritation. If any chemical matter seeps out of the batteries, wipe it up immediately using a dry cloth, and replace the batteries as soon as possible.
- Due to varying storage conditions, the battery life for the batteries included with your product may be shortened. Replace them within 3 months or as soon as you can after initial use.
- There may be local restrictions on the disposal or recycling of batteries. Consult your local regulations or waste disposal provider.

BenQ ecoFACTS

BenQ has been dedicated to the design and development of greener product as part of its aspiration to realize the ideal of the "Bringing Enjoyment 'N Quality to Life" corporate vision with the ultimate goal to achieve a low-carbon society. Besides meeting international regulatory requirement and standards pertaining to environmental management, BenQ has spared no efforts in pushing our initiatives further to incorporate life cycle design in the aspects of material selection, manufacturing, packaging, transportation, using and disposal of the products. BenQ ecoFACTS label lists key eco-friendly design highlights of each product, hoping to ensure that consumers make informed green choices at purchase. Check out BenQ's CSR Website at <http://csr.BenQ.com/> for more details on BenQ's environmental commitments and achievements.



Unpacking and Installation

Unpacking

- This product is packed in a carton, together with the standard accessories.
- Any other optional accessories will be packed separately.
- Due to the size and weight of this display it is recommended for two people to move it.
- After opening the carton, ensure that the contents are complete and in good condition.

Package Contents

Please verify that you received the following items with your package content:

- LCD display
- Remote control
- Quick start guide
- Power cord (1.8 m)
- HDMI cable (1.8 m)
- DVI to VGA cable (1.8 m)

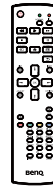

Remote Control



Quick start guide

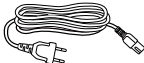

Power Cord



HDMI cable

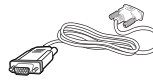

DVI to VGA cable

*The supplied power cord varies depending on destination.

* Differences according to regions.

Display design and accessories may differ from those illustrated above.



- For all other regions, apply a power cord that conforms to the AC voltage of the power socket and has been approved by and complies with the safety regulations of the particular country (Type H05VV-F, 2G or 3G, 0.75 or 1 mm² should be used).
- You might like to save the package box and packing material for shipping the display.

Installation Notes

- Due to the high power consumption, always use the plug exclusively designed for this product. If an extended line is required, please consult your service agent.
- The product should be installed on a flat surface to avoid tipping. The distance between the back of the product and the wall should be maintained for proper ventilation. Avoid installing the product in the kitchen, bathroom or any other places with high humidity so as not to shorten the service life of the electronic components.

- The product can normally operate only under 3000m in altitude. In installations at altitudes above 3000m, some abnormalities may be experienced.
- LCD screens, like plasma (PDP) and conventional CRT (Cathode Ray Tube) screens, are also susceptible to 'screen burn-in' or 'image retention' which can be found on the screen as visible fixed lines and shades. To avoid such damage to the screen, avoid displaying still images (like On-Screen Display menus, TV station logos, fixed/inactive text or icons) for more than 30 minutes. Change the aspect ratio from time to time. Fill the entire screen with the image and eliminate the black bars whenever possible. Avoid displaying images in 4:3 aspect ratio over a long period of time, otherwise there may be visible burn marks on the screen as two vertical lines.



Under certain circumstances, condensation may occur on the inner side of the cover glass, it's a natural phenomenon and will not affect the operation of the display. This condensation will usually disappear after around 2 hours of normal operation.

Mounting on a Wall

To mount this display to a wall, you will have to obtain a standard wall-mounting kit (commercially available). We recommend using a mounting interface that complies with TUV-GS and/or ULI 678 standard.

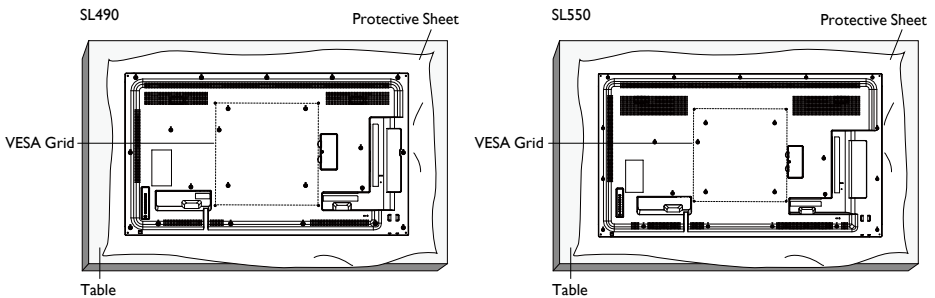

1. Lay a protective sheet on a table, which was wrapped around the display when it was packaged, beneath the screen surface so as not to scratch the screen face.
2. Ensure you have all accessories for mounting this display (wall mount, ceiling mount, table stand, etc).
3. Follow the instructions that come with the base mounting kit. Failure to follow correct mounting procedures could result in damage to the equipment or injury to the user or installer. Product warranty does not cover damage caused by improper installation.
4. For the wall-mounting kit, use M6 mounting screws (having a length 10 mm longer than the thickness of the mounting bracket) and tighten them securely.

VESA Grid

SL490/SL550	400(H) x 400(V) mm
--------------------	--------------------



To prevent the display from falling:

- For wall or ceiling installation, we recommend installing the display with metal brackets which are commercially available. For detailed installation instructions, refer to the guide received with the respective bracket.
- To lessen the probability of injury and damage resulting from fall of the display in case of earthquake or other natural disaster, be sure to consult the bracket manufacturer for installation location.

Ventilation Requirements for enclosure locating

To allow heat to disperse, leave space between surrounding objects as shown in the diagram below.

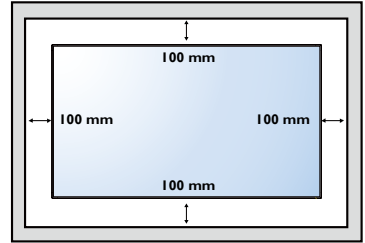

Mounting in Portrait Position

This display can be installed in portrait position.

1. Remove the table stand, if attached.
2. Rotate 90 degrees clockwise from the back side of the display. The terminals will be on the left and bottom side of the user from the back of the display.

SL490

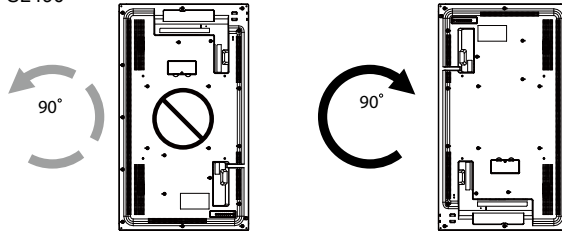

SL550

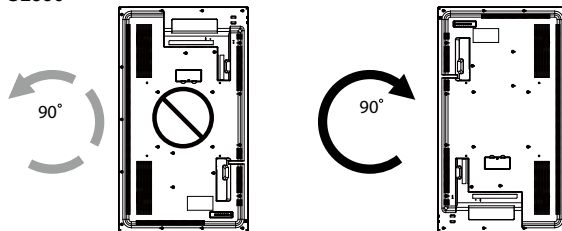

Parts and Functions

Control Panel

SL490

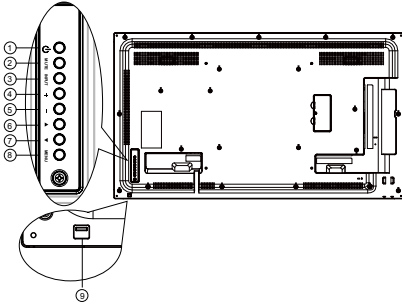

SL550

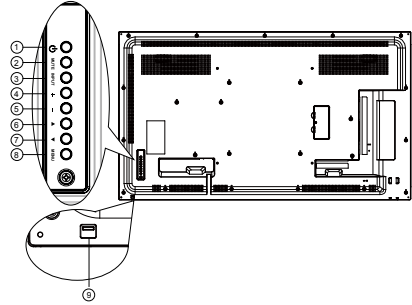

No.	Name	Description
1	 button	Use this button to turn the display on or put the display to standby.
2	MUTE button	Switch the audio mute ON/OFF.
3	INPUT button	Choose the input source.
4	+ button	Increase the adjustment while OSD menu is on, or increase the audio output level while OSD menu is off. • Used as OK button in the On-Screen-Display menu.
5	— button	Decrease the adjustment while OSD menu is on, or decrease the audio output level while OSD menu is off.
6	▲ button	Move the highlight bar up to adjust the selected item while OSD menu is on.
7	▼ button	Move the highlight bar down to adjust the selected item while OSD menu is on.
8	MENU button	Return to previous menu while OSD menu is on, or to activate the OSD menu when OSD menu is off.

9

**Remote control
sensor and power
status indicator**

- Receives command signals from the remote control.
- Indicates the operating status of the display:
 - Lights green when the display is turned on
 - Lights red when the display is in standby mode
 - Lights amber when the display enters sleep mode
 - When **SCHEDULE** is enabled, the light blinks green and red
 - If the light blinks red, it indicates that a failure has been detected
 - Lights off when the main power of the display is turned off
- Pull down the lens to have better remote control performance and easy to observe the light information of power status.
- Push up the lens before mounting the display for video wall application.
- Pull/Push the lens until hearing the click sound.

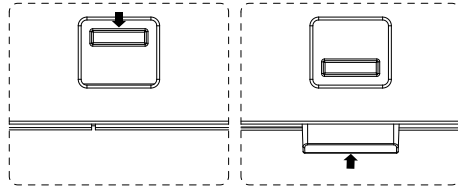

Input/Output Terminals

SL490

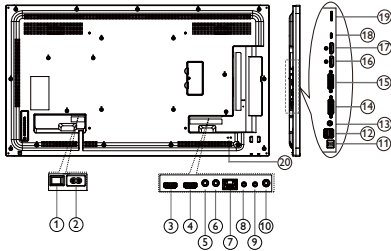

SL550

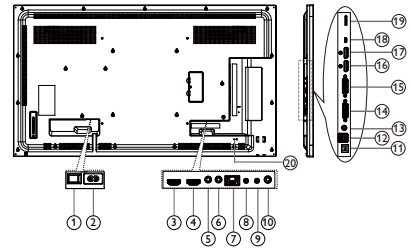

No.	Name	Description
1	AC SWITCH	Switch the AC power on/off.
2	AC IN	AC power input from the wall outlet.
3	HDMI1 IN	HDMI video/audio input.
4	HDMI2 IN	
5	IR IN	IR signal input / output for the loop-through function.
6	IR OUT	
7	RJ-45	LAN control function for the use of remote control signal from control center.
8	RS232 IN	RS232 network input / output for the loop-through function.
9	RS232 OUT	
10	Audio OUT	Audio output to external AV device.
11	USB PORT B	Service Use only.
12	USB PORT A	1. For media play 2. 5V2A for add current , example for HDD
13	PC LINE IN	Audio input for VGA source (3.5mm stereo phone).
14	DVI IN	DVI-I video input.
15	DVI OUT	DVI or VGA video output.
16	DisplayPort IN	DisplayPort video input / output.
17	DisplayPort OUT	
18	MICRO USB	For media play, transfer data between the signage and the computer via a Micro-USB cable (purchased separately).
19	MICRO SD CARD	Connect your MICRO SD CARD.
20	SECURITY LOCK	Used for security and theft prevention.

Remote control

General functions

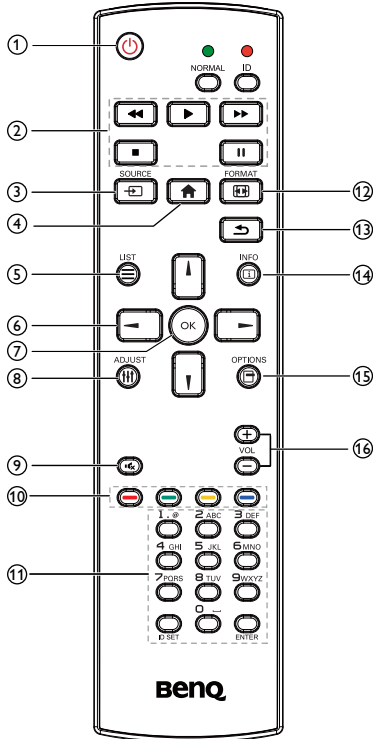

1 POWER button

Power ON/OFF.

2 PLAY buttons

Media player source only. Please refer to [Remote Control for Android usage on page 14](#).

Freeze feature

Pause: Freeze hot key for all inputs content.

Play: Unfreeze hot key for all input content.

3 SOURCE button

Pop-up source menu OSD.

4 HOME button

Pop-up setting menu OSD.

5 LIST button

Works as X-Sign Menu when at X-Sign page.

6 NAVIGATION buttons

▲
On VGA, HDMI I, HDMI2, DVI-D and Display Port source: Pop-up picture mode source OSD.
Others: Move the highlight bar up.

▼
On VGA, HDMI I, HDMI2, DVI-D and Display Port source: Pop-up Audio source OSD.
Others: Move the highlight bar down.

◀
Source menu OSD: Exit source menu OSD.
Volume menu OSD: Decrease audio volume.
Others: Move the highlight bar left..

▶
Source menu OSD: Go to selected source.
Volume menu OSD: Increase audio volume.
Others: Move the highlight bar right.

7 OK button

Confirm, submit or select.

8 ADJUST button

Go to Auto Adjust OSD for VGA only.

9 MUTE button

Toggle Audio Mute/Unmute.

10 COLOR buttons

Choose tasks or options.(for Media Input only)
 Window selection for PIP function.

11 Number / ID SET / ENTER buttons

Enter text for network setting.

Press to set the display ID. Refer to [ID Remote Control on page 13](#) for more detail.

12  **FORMAT button**

Change Image Zoom Mode Full, 4:3, 1:1, 16:9, 21:9, Custom.

13  **BACK button**

Return to the previous menu page or exit from the previous function.

14  **INFO button**

Show Information OSD.

15  **OPTIONS button**

No function.

16  **VOLUME button**

Adjust volume.

ID Remote Control

You can set the remote control ID when you want to use this remote control on one of several different displays.

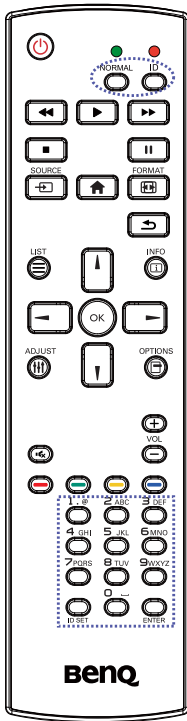

Press **ID** button. The red LED blinks twice.

1. Press **ID SET** button for more than 1 second to enter the ID Mode. The red LED lights up.
Press the ID SET button again will exit the ID Mode. The red LED lights off.

Press the digit numbers **0 ~ 9** to select the display you want to control.

For example: press **0** and **1** for display No.1, press **1** and **1** for display No.11.

The numbers available are from **01 ~ 98**.

2. Not pressing any button within 10 seconds will exit the ID Mode.
3. If an error pressing of buttons other than the digits occurred, wait 1 second after the red LED lights off and then lights up again, then press the correct digits again.
4. Press **ENTER** button to confirm. The red LED blinks twice and then lights off.



- Press **NORMAL** button. The green LED blinks twice, indicating the display is in normal operation.
- It is necessary to set up the ID number for each display before selecting its ID number.

Remote Control for Android usage

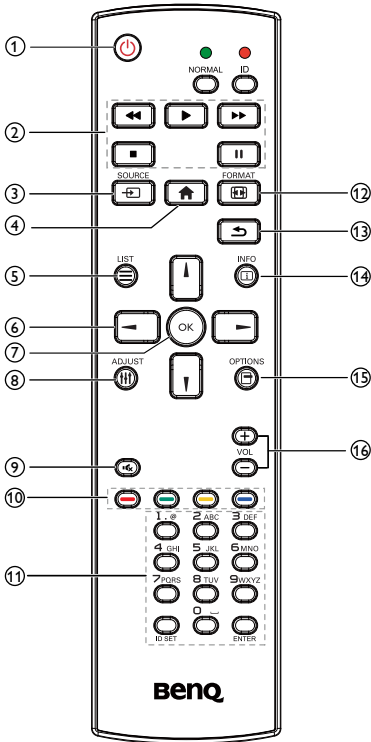

1 POWER button

Power ON/OFF.

2 PLAY buttons

I. Media playback (video/audio/picture).

There are 3 ways to play media files.

- 1) Media Player > Compose > edit or add new playlist > choose any media files > press to play the media file directly.
- 2) Media Player > Play > choose non-empty play list > press to play all the media files in the play list.
- 3) Set media playlist in Boot on Source or Schedule by OSD menu.

2. PDF playback

There are 3 ways to play PDF files.

- 1) File Manager
Select and play the PDF file from File Manager.
 - 2) PDF Player > Play > choose non-empty play list > press to play all the PDF files in the play list.
 - 3) Set PDF playlist in Boot on Source or Schedule by OSD menu.
3. When playing PDF, video or music, press to stop playing. Then if pressing again, playing will be started from the beginning of the file.
 4. When playing PDF, video or music, press button to pause playing.
 5. All media or PDF files should be put at the folder, which is named "benq" with sub-folder, under the root directory of the specified storage (internal/USB/SD Card). All sub-folders (video/photo/music/pdf) are named by media types and shouldn't be changed.

- videos: {root dir of storage}/benq/video/
- photos: {root dir of storage}/benq/photo/
- music: {root dir of storage}/benq/music/
- pdf: {root dir of storage}/benq/pdf/

Note that the root directories of three storages are

- Internal storage: /sdcard
- USB storage: /mnt/usb_storage
- SD card: /mnt/external_sd

6. Media Player: Rewind 20 seconds.
PDF Player: Go to the previous page.
7. Media Player: Forward 20 seconds.
PDF Player: Go to the next page

3 SOURCE button

Root Menu: Go to Video source OSD.

4 HOME button

Root Menu: Go to Main Menu OSD.











Others: Exit OSD.

5 LIST button

In PDF Player, zoom-in your PDF content.

When you Press  button, the PDF content will go back to the original size.

6 / / < / > NAVIGATION buttons

- Navigate through menus and choose items.
- In the content of the web page, these buttons are to control the scroll bar of the screen.
Press  or  is for moving vertical scroll bar up or down. Press  or  is for moving horizontal scroll bar left or right.
- For PDF files,
 - when zoom in/out has been performed, Press , ,  or  to adjust the position of the screen.
 - when zoom in/out has been not performed, Press  to go to the next page.
Press  to go to the previous page.

7 OK button

Confirm, submit or select.

8 ADJUST button



In PDF Player, zoom-out your PDF content.

When you Press  button, the PDF file content will go back to the original size.

9 MUTE button

Toggle Audio Mute/Unmute.

10 COLOR buttons



- : No function in Android.
- 
 - In the content of the web page, move the focus up to the next clickable items.

- Move the focus up to the next control or widget such as buttons.

3.

- In the content of the web page, move the focus down to the next clickable items.
- Move the focus down to the next control or widget such as buttons.

11 Number / ID SET / ENTER button

- No functions for ID SET  and ENTER  on Android source.
- For PDF file, enter the page number by pressing number buttons and then press  button to jump to the specific page.

12 FORMAT button

Change Image Zoom Mode Full, 4:3, 1:1, 16:9, 21:9, Custom.

13 BACK button

Return to the previous page or exit from the previous function.

14 INFO button

- Show Information OSD.
- Media Player > Compose > edit or new add playlist > choose any media files > press  to show the information of the chosen media file.

15 OPTIONS button

Open toolbox in Media Player or PDF Player.

- Media Player > Compose > Edit or new add playlist > press  to open toolbox. Toolbox will be slide from the left side of the screen.

2. PDF Player >Compose > Edit or new add playlist > press  to open toolbox. Toolbox will be slide from the left side of the screen.

16 — / + VOLUME button

Adjust volume.

Inserting the batteries in the remote control

The remote control is powered by two 1.5V AAA batteries.

To install or replace batteries:

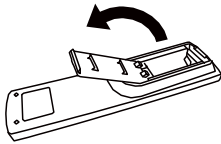

1. Buy two 1.5V AAA batteries.
2. Press and then slide the cover to open it.

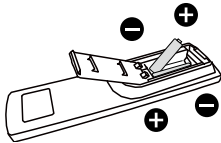

3. Align the batteries according to the (+) and (-) indications inside the battery compartment.

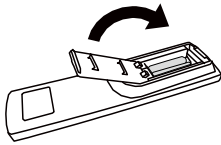

4. Replace the cover.



The incorrect use of batteries can result in leaks or bursting. Be sure to follow these instructions:

- Place “AAA” batteries matching the (+) and (-) signs on each battery to the (+) and (-) signs of the battery compartment.
- Do not mix battery types.
- Do not combine new batteries with used ones. It causes shorter life or leakage of batteries.
- Remove the dead batteries immediately to prevent them from liquid leaking in the battery compartment. Don't touch exposed battery acid, as it can damage your skin.



If you do not intend to use the remote control for a long period, remove the batteries.

Handling the remote control

- Do not subject to strong shock.
- Do not allow water or other liquid to splash the remote control. If the remote control gets wet, wipe it dry immediately.
- Avoid exposure to heat and steam.
- Other than to install the batteries, do not open the remote control.

Operating range of the remote control

Point the top of the remote control toward the display's remote control sensor when pressing a button.

Use the remote control within a distance of less than 5m/16ft from the display's sensor, and a horizontal and vertical angle of less than 30 degrees.

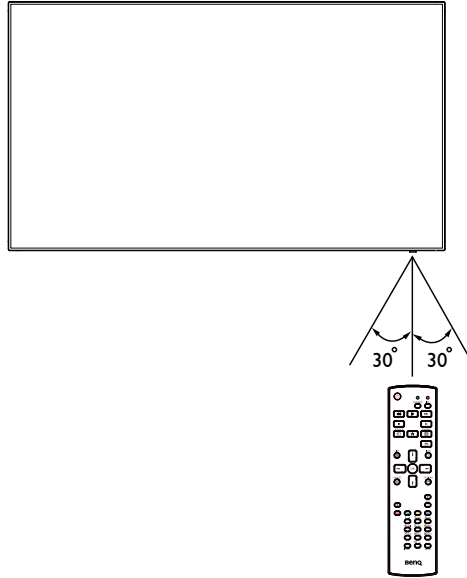

The remote control may not function properly when the remote control sensor on the display is under direct sunlight or strong illumination, or when there is an obstacle in the path of signal transmission.

Connecting External Equipment

Connecting External Equipment (DVD/VCR/VCD)

Using HDMI video input

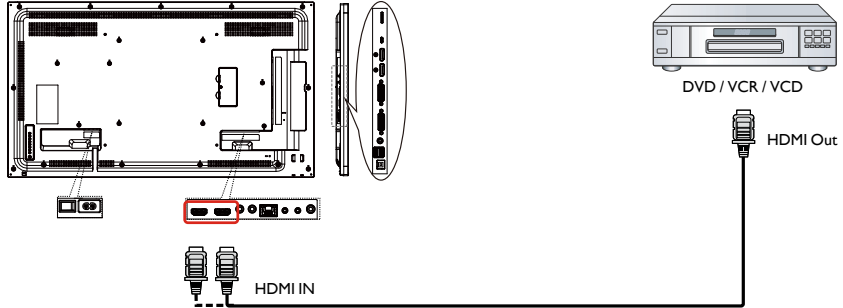

Connecting a PC

Using DVI-I input

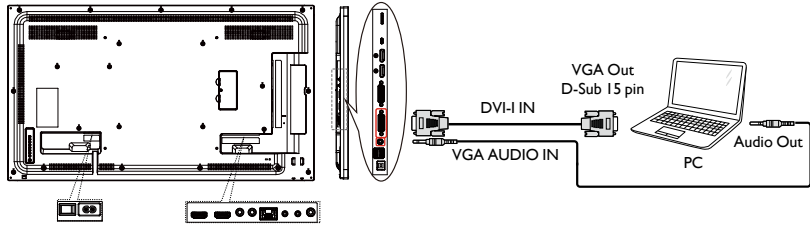

Using DVI input

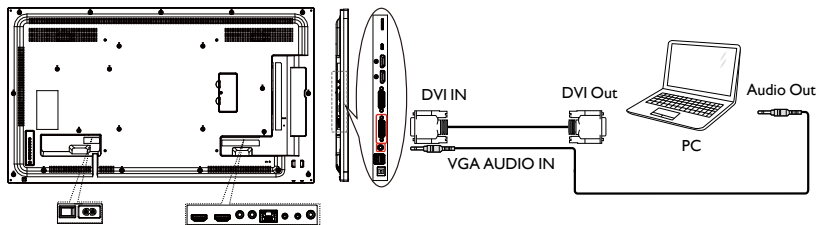

Using HDMI input

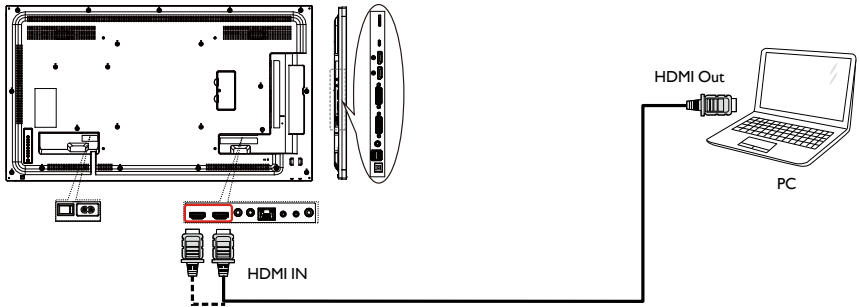

Using DisplayPort input

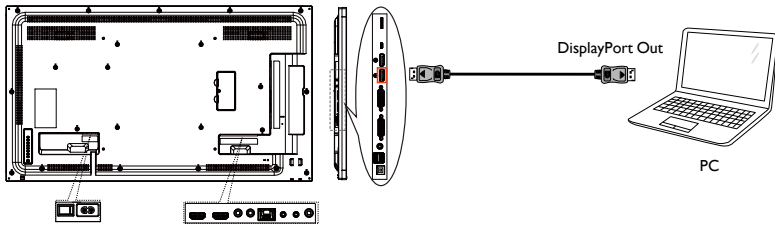

Connecting Audio Equipment

Connecting an external audio device

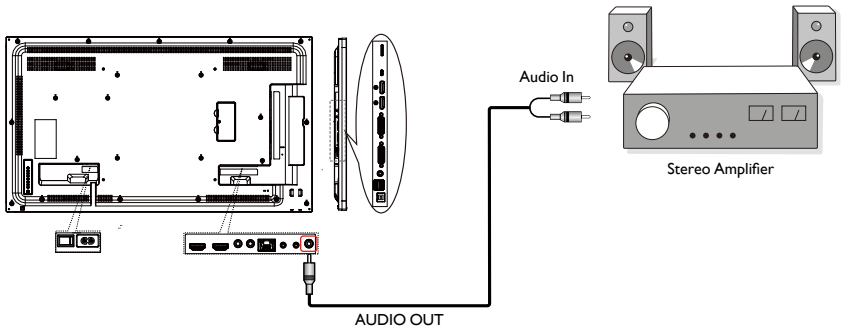

Connecting Multiple Displays in a Daisy-chain Configuration

You can interconnect multiple displays to create a daisy-chain configuration for applications such as a video wall.



Maximum 25 displays (5x5) can be used in a DVI daisy-chain configuration. For VGA daisy-chain, Maximum 9 displays can be used.

Display control connection

Connect the RS232 OUT connector of DISPLAY 1 to the RS232 IN connector of DISPLAY 2.

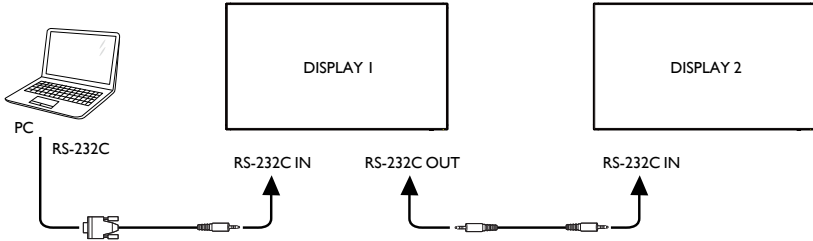

Digital video connection

Connect the DVI OUT / DVI-I OUT connector of DISPLAY 1 to the DVI IN connector of DISPLAY 2.

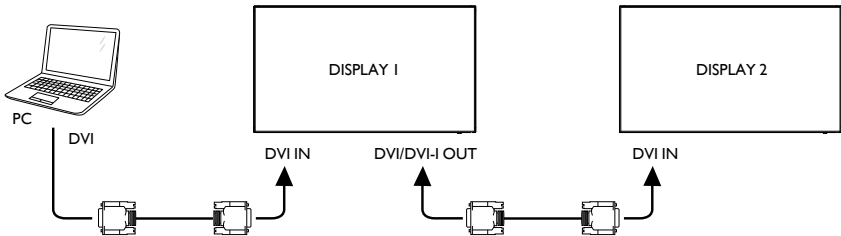

DVI Daisy chain to 5*5 without splitter, DVI with HDCP up to 7th.

Connect the DP OUT connector of DISPLAY 1 to the DP IN connector of DISPLAY 2.

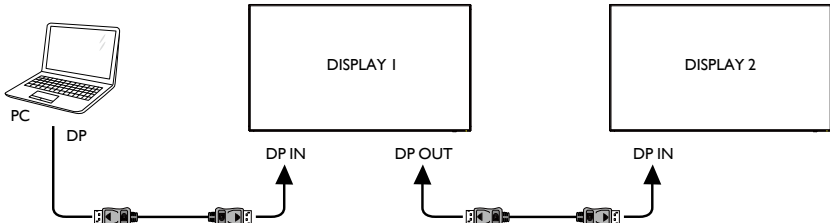

 DP Daisy chain to 15*10 without splitter. DP 1.2 up to 3840x2160@60Hz. DP with HDCP up to 7th.

Connect the HDMI OUT connector of DISPLAY 1 to the DVI IN connector of DISPLAY 2.

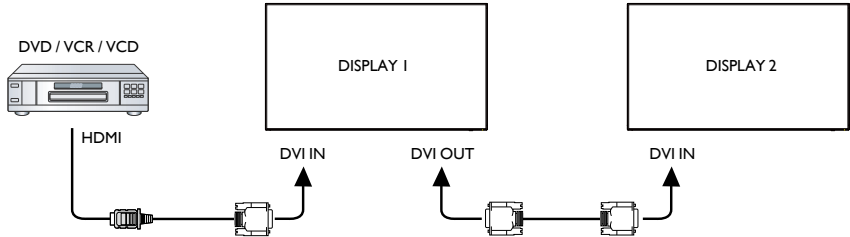

 HDMI up to 3840x2160@30Hz, HDMI with HDCP up to 7th.

Analog video connection

Connect the DVI OUT /DVI-I OUT connector of DISPLAY 1 to the DVI-I IN connector of DISPLAY 2.

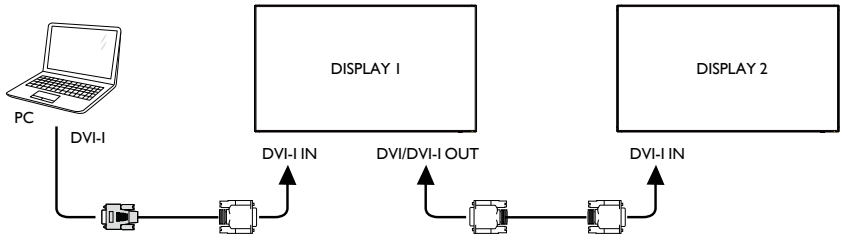

 Analog Daisy chain to 3*3 without splitter.

IR connection

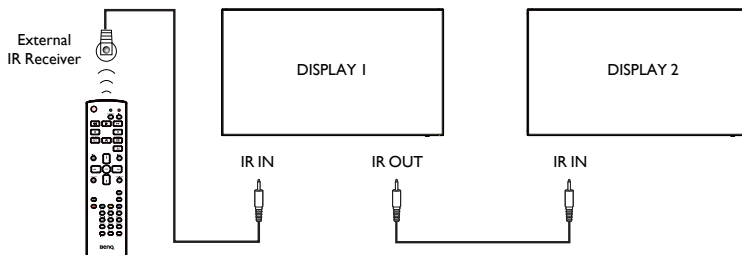

-  1. This display's remote control sensor will stop working if the **IR IN** is connected.
2. IR loop through connection can support up to 9 displays.



Operation



The control button described in this section is mainly on the remote control unless specified otherwise.

Watch the Connected Video Source



See [page 18](#) for external equipments connection.

1. Press  **SOURCE** button.
2. Press  or  button to choose a device, then press **OK** button.

Change Picture Format

You can change the picture format to suit the video source. Each video source has its available picture formats.

The available picture formats depend on the video source:

1. Press  **FORMAT** button.
2. Press  or  button to choose a picture format, then press **OK** button.
 - PC mode: Full/4:3/1:1/16:9/21:9/Custom.
 - Video mode: Full/4:3/1:1/16:9/21:9/Custom.

Android reminder page

1. Android reminder page:
 - Every app leaves by pressing the back key. The screen will go to Android reminder page.
 - When you return to Android reminder page, the screen will show hint image as below:
 - The hint image will notify you can press source key to change source.

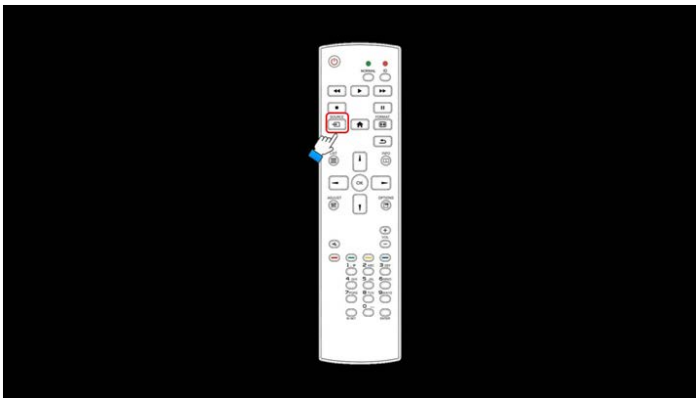

Media Player introduction:

1. Home page of Media Player, this page has three items: “Play”, “Compose” and “Settings”.

Play : select playlist to play.

Compose: edit playlist.

Settings: setting play properties.



2. Select “Play” on home page, first you should choose one playlist to play between FILE 1 and FILE 7.

The pencil icon means the playlist is non-empty.

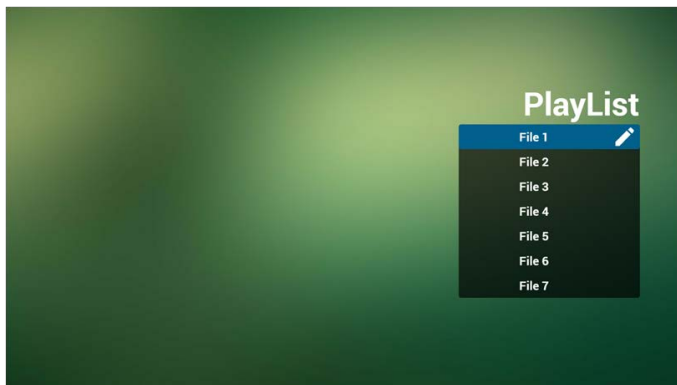

3. Select “Compose” on home page, first you should choose one playlist to edit between FILE 1 and FILE 7.

The pencil icon means the playlist is non-empty.

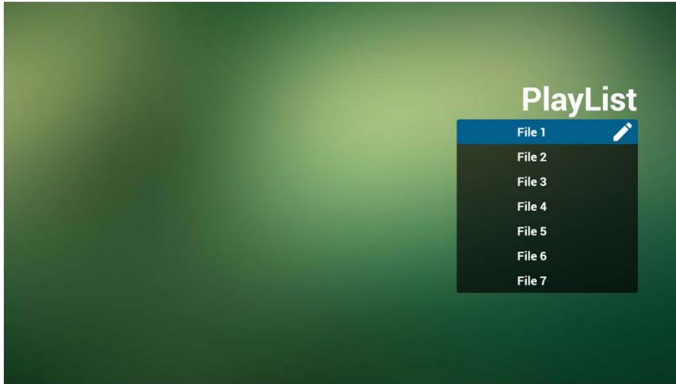

4. If an empty playlist is chosen, the app will guide you to select the media source. All media files should be placed in/benq/of root directory.

For example:

- videos in /root/benq/video/
- photos in /root/benq/photo/



The limit of resolution is 4096x4096

- music in /root/benq/music/

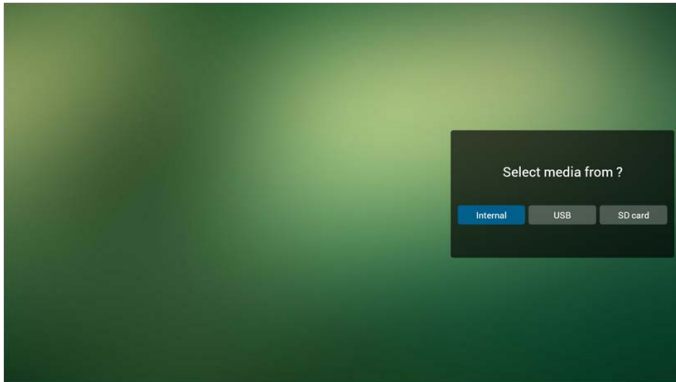

5. You could edit or delete a non-empty playlist, just choose the desired playlist which is with pencil icon.

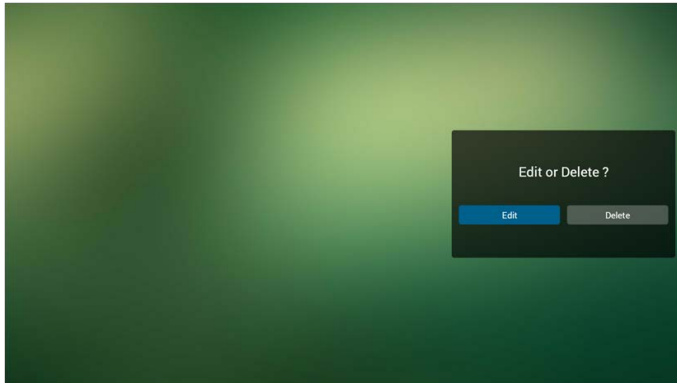

6. Once you start to edit a playlist, you will see below screen.
 Source - files in storage.
 Playlist – files in playlist.
 There are 4 icons which map to the keys of remote controller.
 Option key – launch slide bar
 Play key – play media file.
 Info key – show media info.
 Ok key – select/unselect file.

6-1 In the slide bar, it helps you to do the following:

- select all : select all storage files.
- delete all : delete all playlist files.
- add/remove : update playlist from source.
- sort : sort playlist.
- save/abort : save or abort playlist.
- back : return.

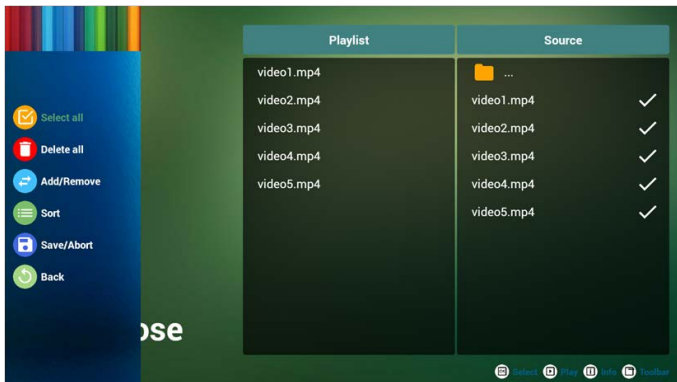

7. if you choose “Sort” in the slide bar, you can change the order of files one by one.

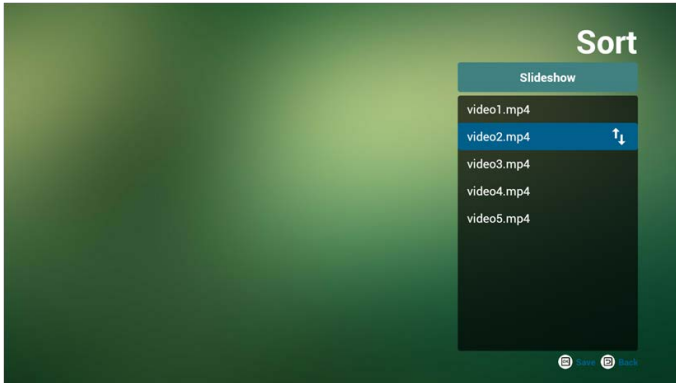

8. Press info key after you choose desired file, you will get the detail information.



9. Press play key after you choose desired file, you will play the media file directly.



10. If you make a playlist with all image files, before saving, the app will ask you if you want to have background music while playing slideshow.

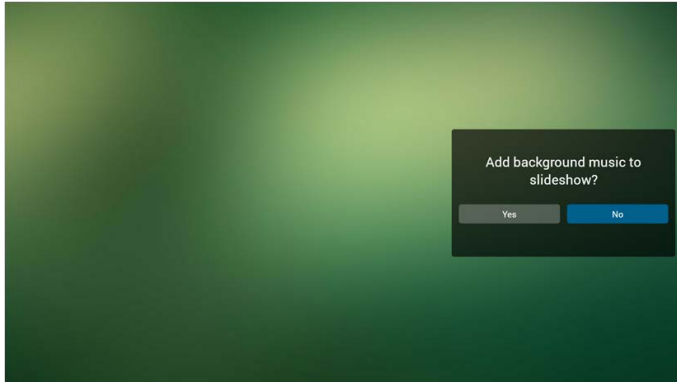

11. Select "Settings" on home page, this page has three parts, "Repeat Mode", "Slideshow Effect" and "Effect Duration".

Repeat Mode : play mode.

Slideshow Effect : photo slideshow effect.

Effect Duration : photo effect duration.

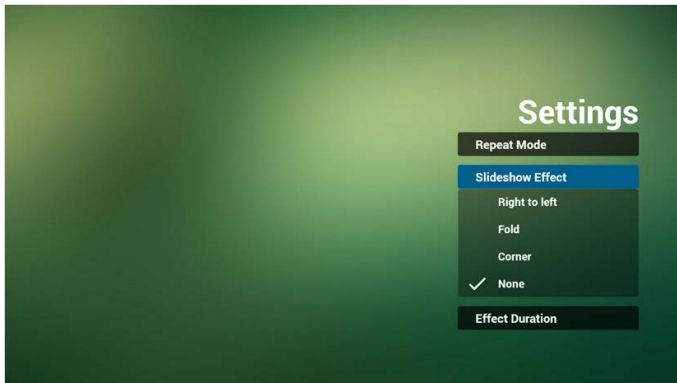

12. Media Hotkey

Play : Playback file.

Pause: Pause file.

Fast forward: forward 20 second. (photo not support).

Rewind: back 20 second. (photo not support).

Stop: Stop file and return to start. For GIF format, it will be paused.

Browser manual

1. Home page of Browser app, this page has one item: "Settings".
Press Settings then enter next page.

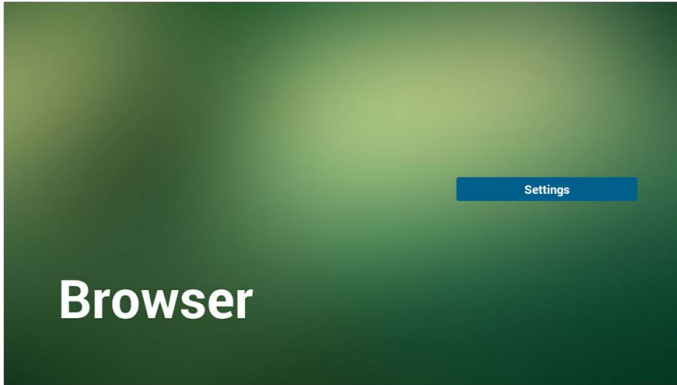

2. Users can choose 1~7.
Press any one will show a dialog.

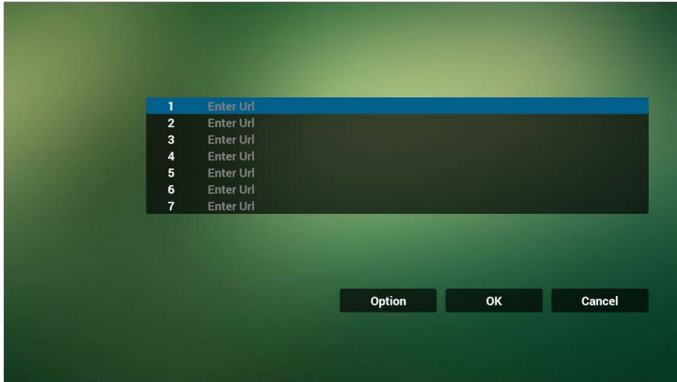

3. Enter URL and press OK then data will save on List

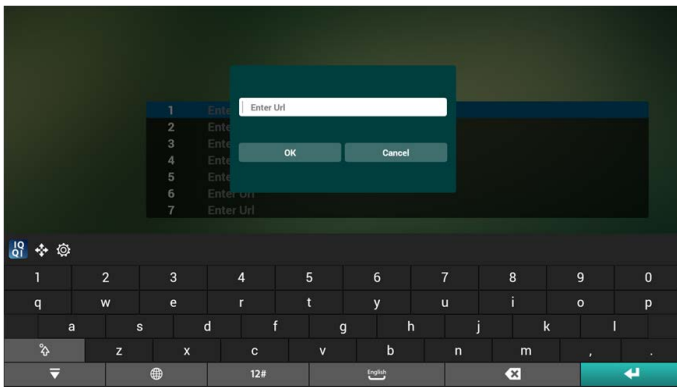

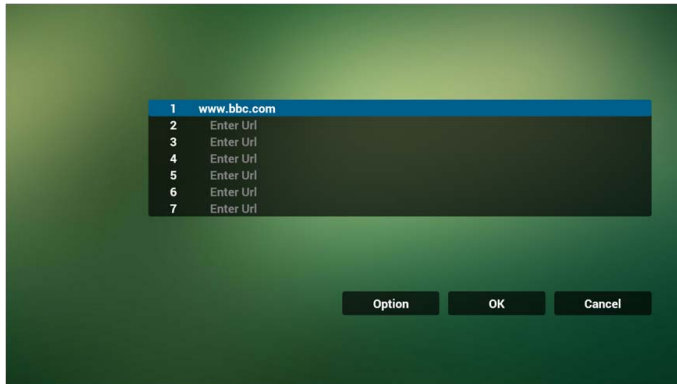

4. Press “Option” then left side will pop up a list
Import : Import URL list file
Export : Export URL list file
Delete all : Delete all URL record on right side
Back : left side list will be closed.

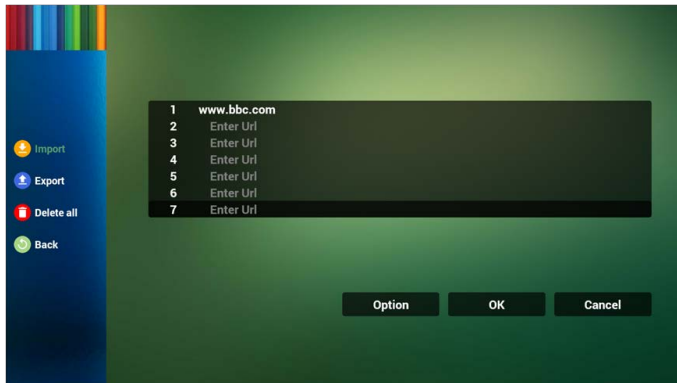

- 4.1 Import
 - Click import

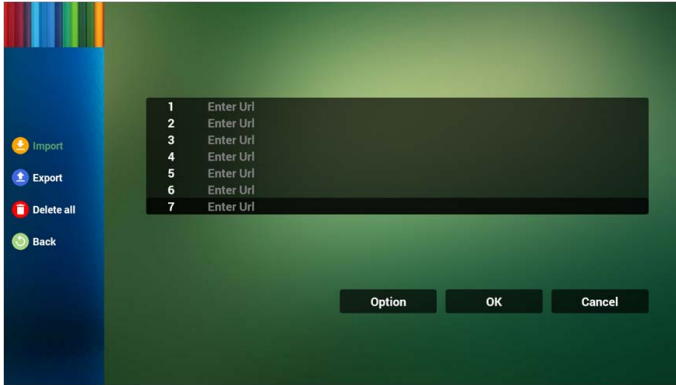

- Choose storage

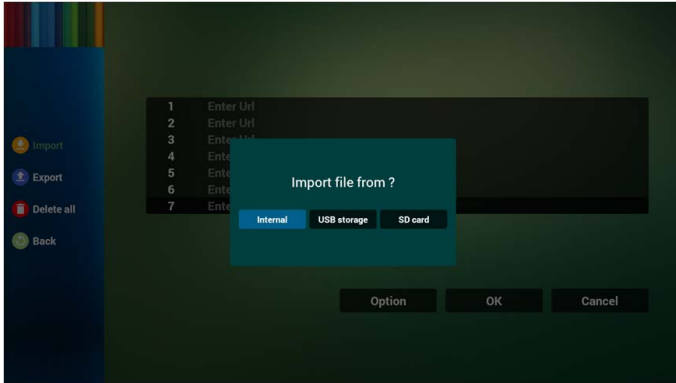

- Choose file contains URL

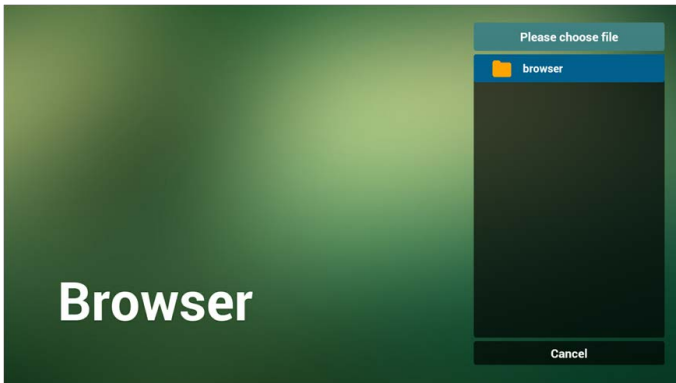

- Import file and URL will show on list

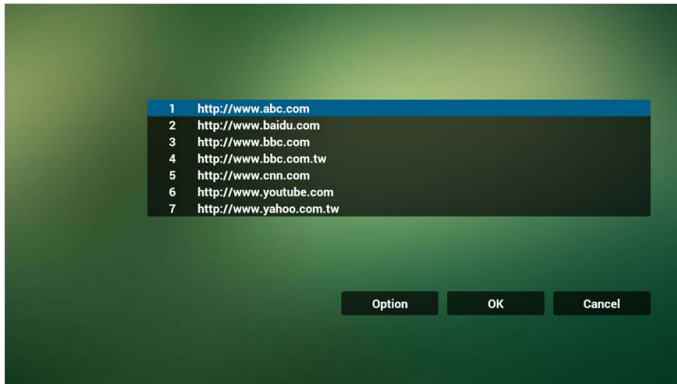

- File format for import
Format should be like below with file extension “txt”

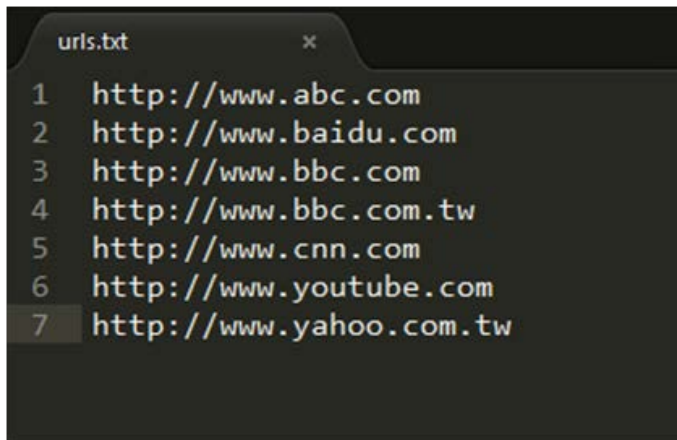

4.2 Export:

- Click export

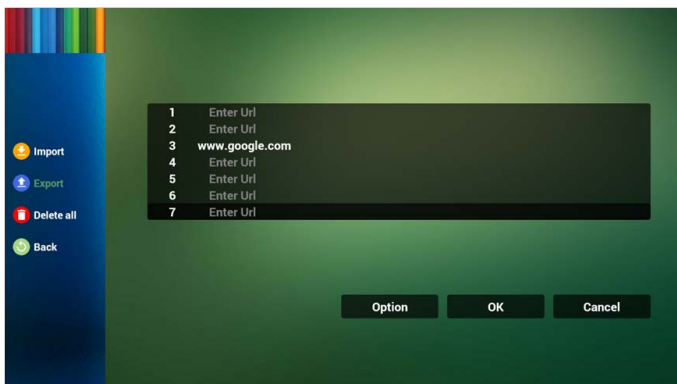

- Choose storage

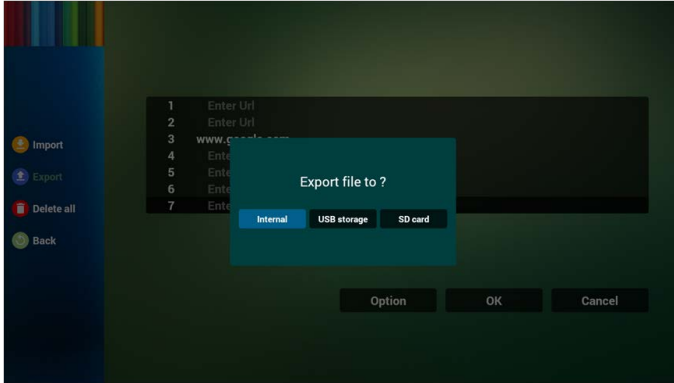

- The dialog shows file path and name.
Press "save" button then URL on list will be saved.

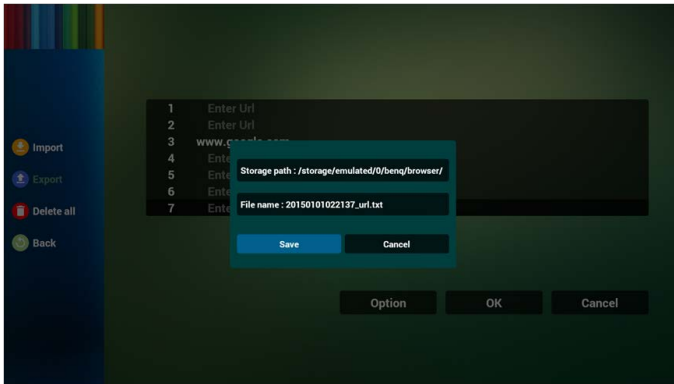

- 5. Press OK then URL records will be saved.

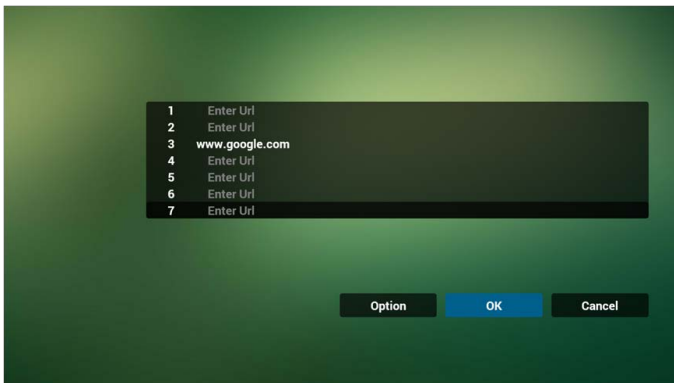

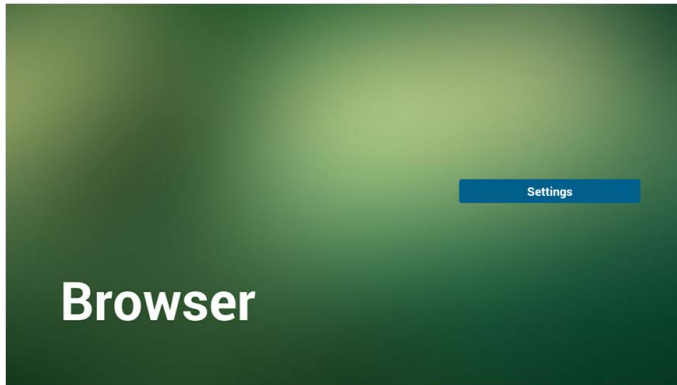

6. On URL list page, if you select non-empty item, it will show a dialog to ask edit or play URL. If press "Edit", it will show edit URL dialog, if press "Play", it will show web page of item's URL.

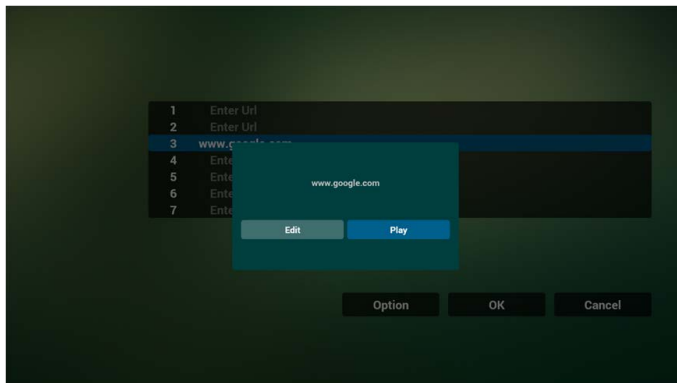
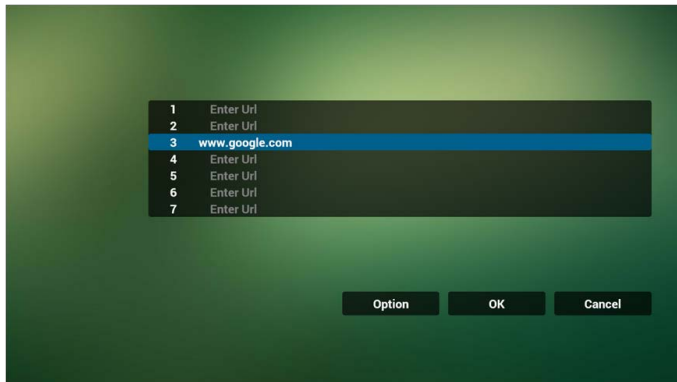

7. OSD menu interaction with Browser
- 7.1 Demonstration: Boot on source

- Set OSD menu > Configuration I > Boot on source > If Input is BROWSER and Play List is 0.
Then PD will show Browser after reboot.
- Set OSD menu > Configuration I > Boot on source > If Input is BROWSER and Play List is 1.
Then PD will show web page with 1st URL in Browser app.

7.2 Demonstration: Scheduling

Set OSD menu > Advanced option > Schedule > On time1, Off time2, Input is BROWSER, any day you want of week, and Play List.

Then PD will show web page with URL in Browser app at time1 and finish at time2.

PDF reader play

1. Home page of PDF Player, this page has three items: “Play”, “Compose” and “Settings”.

Play : select playlist to play.

Compose: edit playlist.

Settings: setting play properties.

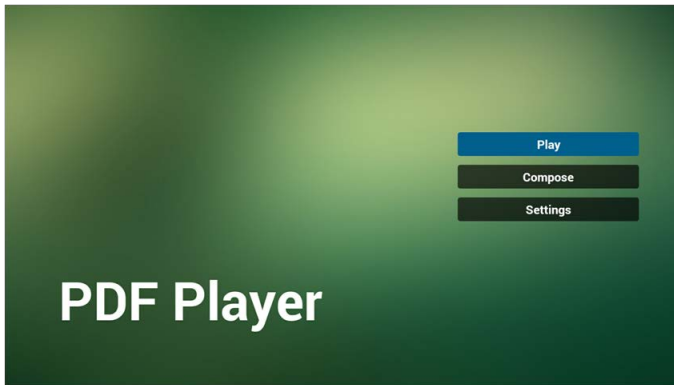

2. Select “Play” on home page, first you should choose one playlist to play between FILE 1 and FILE 7.

The pencil icon means the playlist is non-empty.

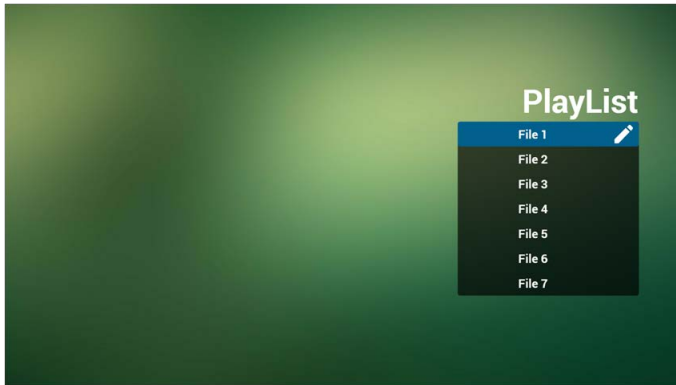

3. Select "Compose" on home page, first you should choose one playlist to edit between FILE 1 and FILE 7.

The pencil icon means the playlist is non-empty.

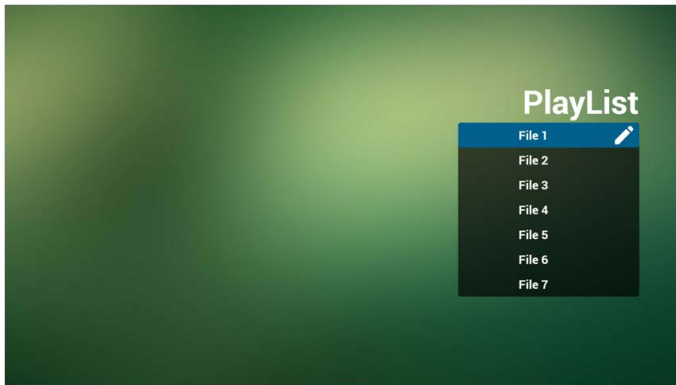

4. If an empty playlist is chosen, the app will guide you to select the media source.
All media files should be placed in /benq/ of root directory.

For example,

- pdfs in /root/benq/pdf/

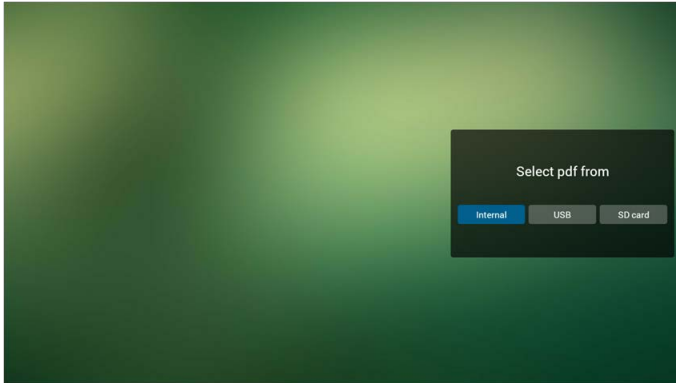

5. You could edit or delete a non-empty playlist, just choose the desired playlist with pencil icon.

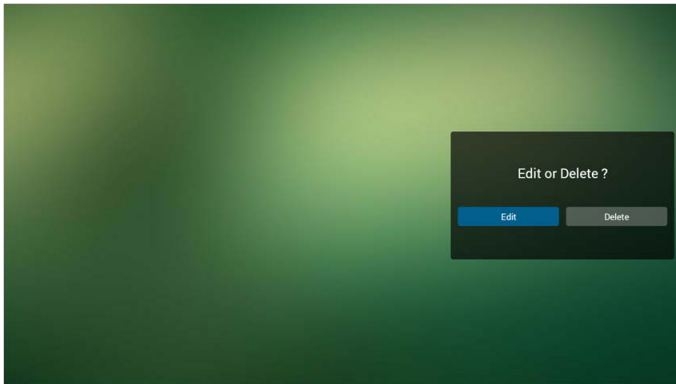

6. Once you start to edit a playlist, you will see below screen.
Source - files in storage.
Playlist – files in playlist.
There are 4 icons which map to the keys of remote controller.
Option key – launch slide bar
Play key – play media file.
Info key – show media info.
Ok key – select/unselect file.

6-1 In the slide bar, it helps you to do the following:

- select all : select all storage files.
- delete all : delete all playlist files.
- add/remove : update playlist from source.
- sort : sort playlist.
- save/abort : save or abort playlist.
- back : return.

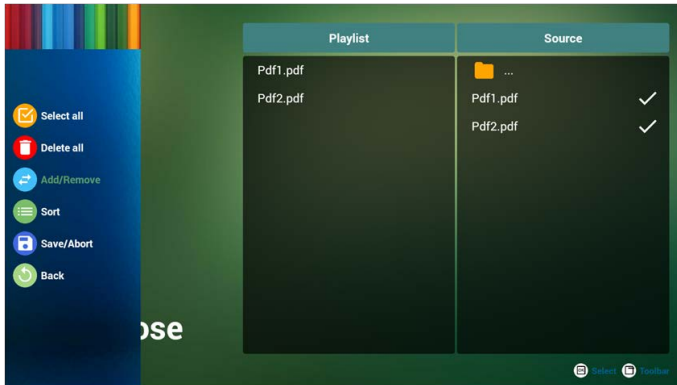

7. If you choose “Sort” in the slide bar, you can change the order of files one by one.

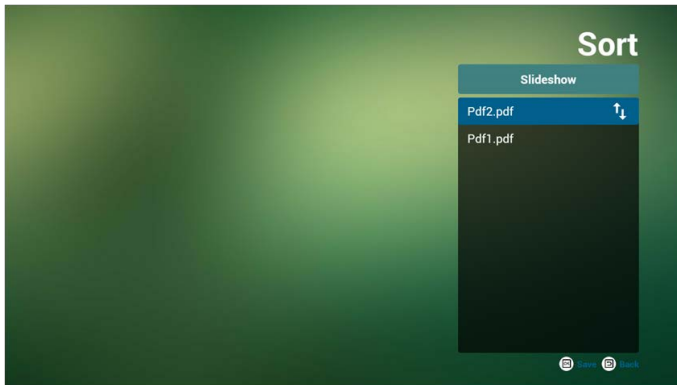

8. Select “Settings” on home page, this page has two parts, “Repeat Mode” and “Effect Duration”.
 Repeat Mode : play mode.
 Effect Duration : photo effect duration.

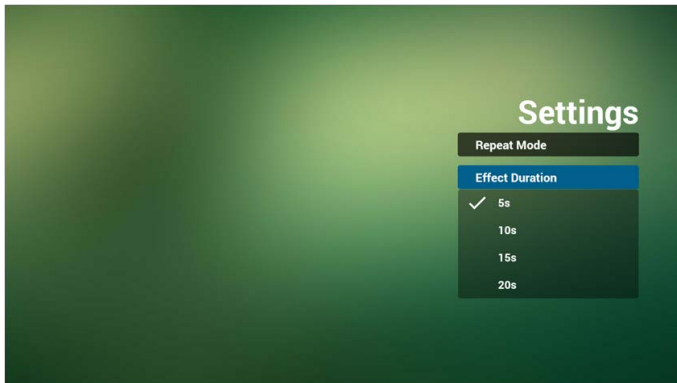

Media Hotkey:

- Play : Playback file.
- Pause: Pause page.
- Fast forward: go to next page, if the page is end of the file, it will go to next file.
- Rewind: back to last page, if the page is first of the file, it will back to last file.
- Stop: return to first page of file

Color Hotkey:

- LIST : Zoom in.(+10%)
- ADJUST : Zoom out.(-10%)
- OK : Restore zoom

Arrow keys:

- Up/Down/Left/Right : Adjust page. (When the page has zoomed in/out)
- Left : Previous Page. (When the page has not zoomed in/out)
- Right : Next Page. (When the page has not zoomed in/out)

Combination key:

- Number key + OK key : select specific page, and press ok key to change page.
- Press number key.

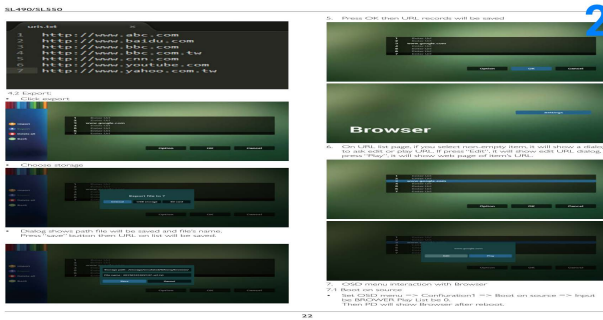

- Press OK key, the bottom of the page will show the page number, if page number over total page number, it will not change page and show current page number at the bottom of the page.

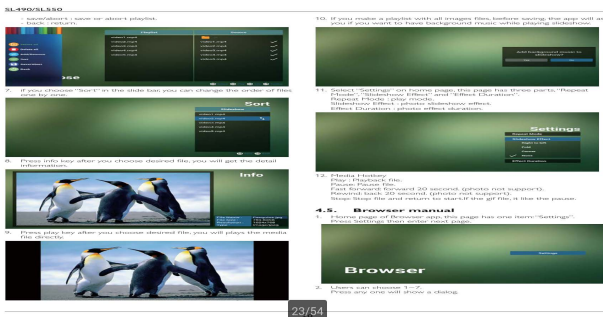

signage display

Setting

Setting main items:

1. Wi-Fi
2. Ethernet
3. Signage Display
4. System Tools
5. Storage
6. Apps
7. Security
8. Date & time
9. Developer options
10. About

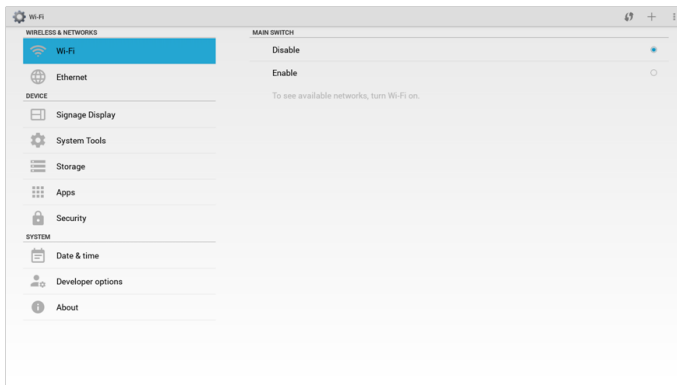

Wi-Fi

Via Enable/Disable to control Wi-Fi On/OFF. After Enable, the screen will list all available WiFi AP.



1. Please make sure your Wi-Fi dongle is approved by BenQ
2. Ethernet will be disabled automatically if Wi-Fi turns on and connects to a network.

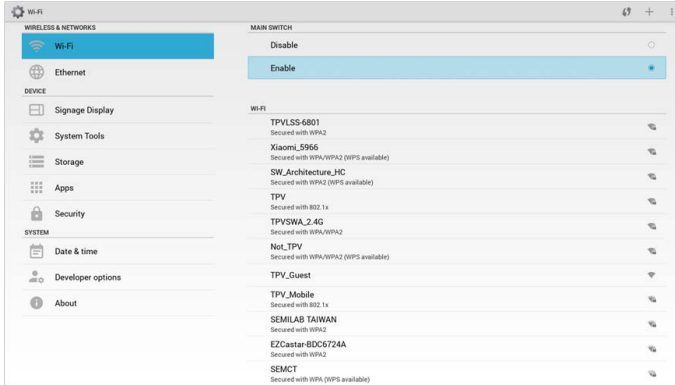

Ethernet

Via Enable/Disable to control Ethernet On/Off. After enable Ethernet, it will display:

1. Connect Type (available type is DHCP/Static IP)
 - A. DHCP
 - B. Static IP
 - C. IP Address
 - D. Netmask
 - E. DNS Address
 - F. Gateway Address
2. Mac Address



WiFi will be disabled automatically if Ethernet turns on and connects to a network.

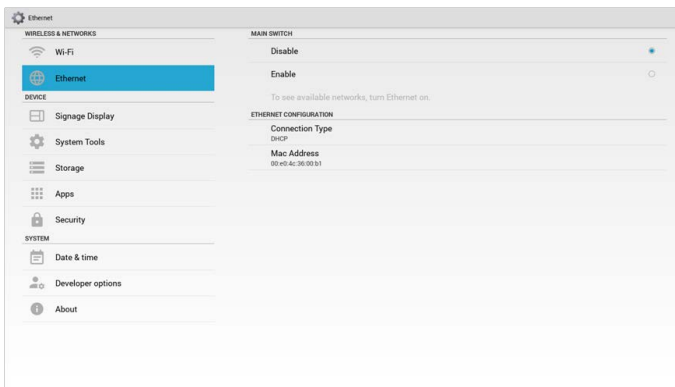

DHCP

DHCP mode:

1. Cannot modify IP Address, Netmask, DNS Address and Gateway..

2. If connect successfully, it will display current network configuration.

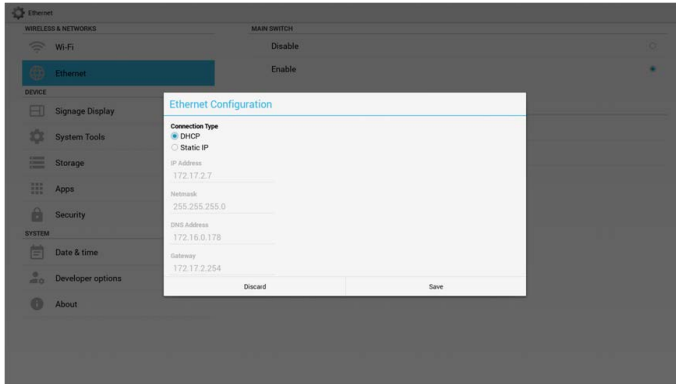

Static IP

Under Static IP. User can manually input IP Address, Netmask, DNS Address and Gateway.



IP address, netmask, DNS address and gateway address input limitation.

- I. Format:
 - I. number 0-9
 - II. decimal point “.”

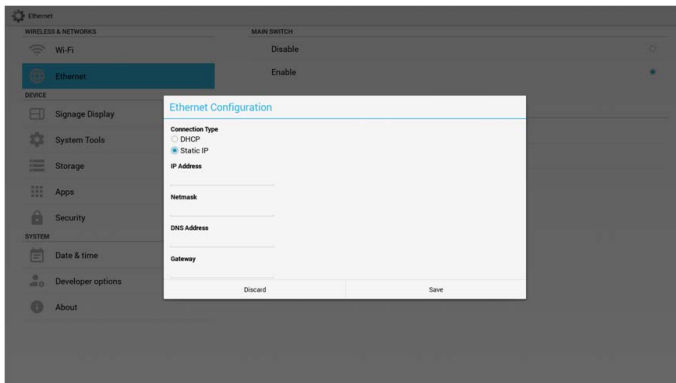

Signage Display

Divide into 2 groups: General Settings / Source Settings

1. General Settings
 - A. Signage Display Name
 - B. Boot Logo
2. Source Settings
 - A. Media Player

B. Browser

C. PDF Player

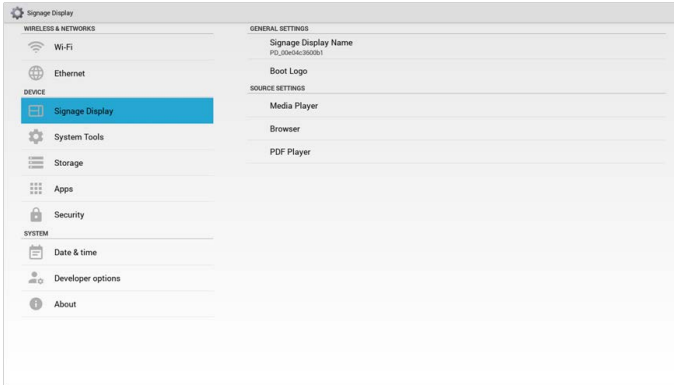

General Settings

I. Signage Display Name

Set up PD name “PD_” + Ethernet Mac Address.



- Input limitation:
- 1. length: Max 36 characters
- 2. format: no limit

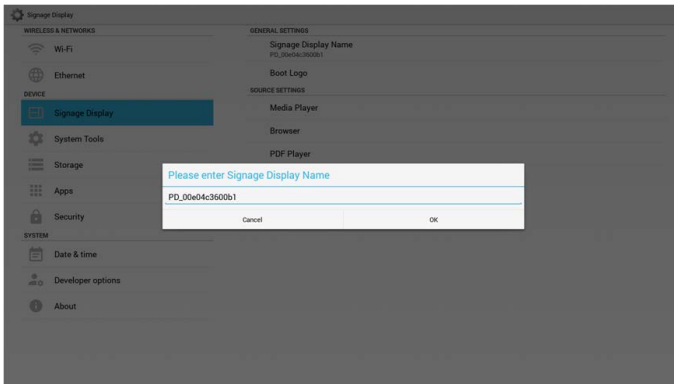

2. Boot Logo

1) Scalar OSD menu to control Android boot logo enable/disable.

Scalar OSD Menu operation:

RCU: Home > Configuration2 > Logo > On/Off/User

In User mode, user can choose their own boot logo animation file.



- 1. Boot animation file name must be: bootanimation.zip
- 2. Will pop-up a window for user to select USB and SD card. No priority issue.

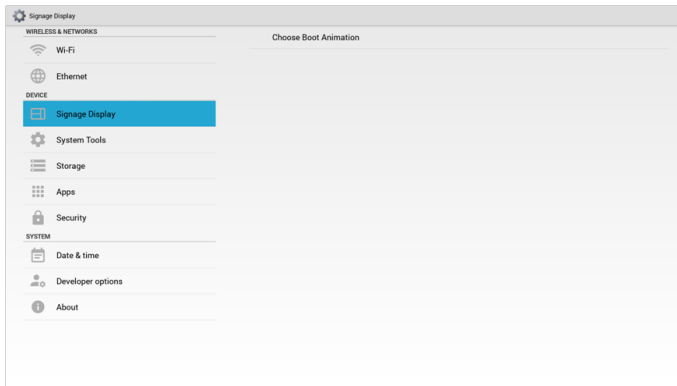

- 2) When boot logo selection, PD will check if there is bootanimation.zip under USB and SD card.

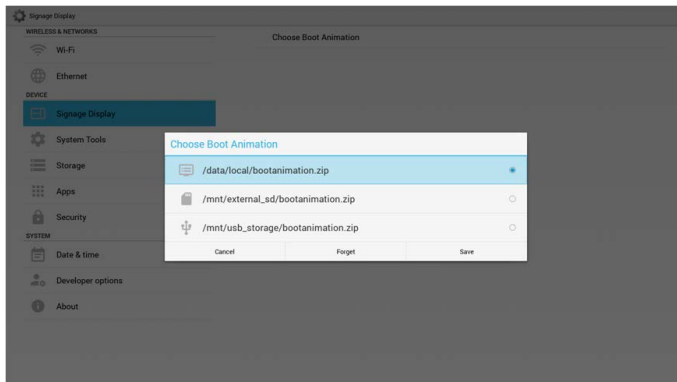

Function introduction:

a. Option description

/data/local

Use customized boot animation file which is copied from SD card or USB

/mnt/external_sd

Use boot animation file under SD card

/mnt/usb_storage

Use boot animation file under USB

b. Save

Press Save key to save SD card or USB bootanimation.zip to /data/local and set it as boot logo.

c. Forget

Press Forget key to delete /data/local bootanimation.zip and not show boot logo.

d. Cancel

Close dialogue w/o changes.

Scenario introduction:

Case 1

The users do not settle customized boot logo. PD does not find any bootanimation.zip file under SD and USB. The List will be blank. Save and Forget button will be gray and useless.

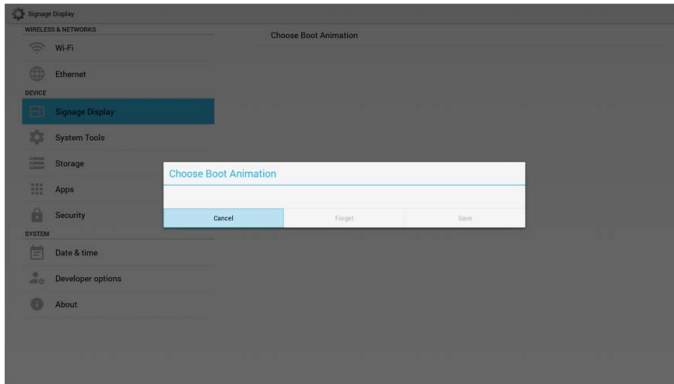

Case 2

The users do not settle customized boot log, PD find bootanimation.zip file under SD or USB. The screen will show bootanimation.zip and select the first file automatically.

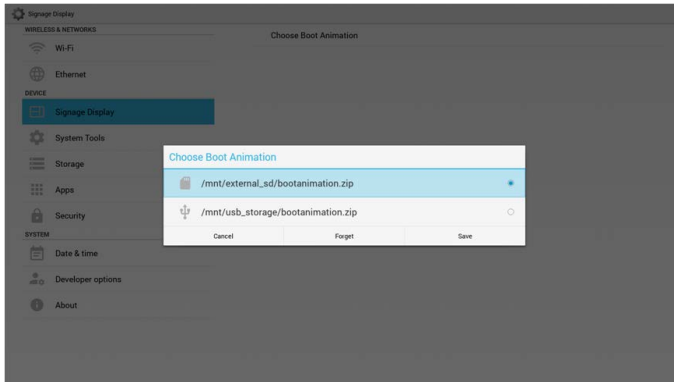

Case 3

The user settle customized boot logo, The screen will show /data/local/bootanimation.zip

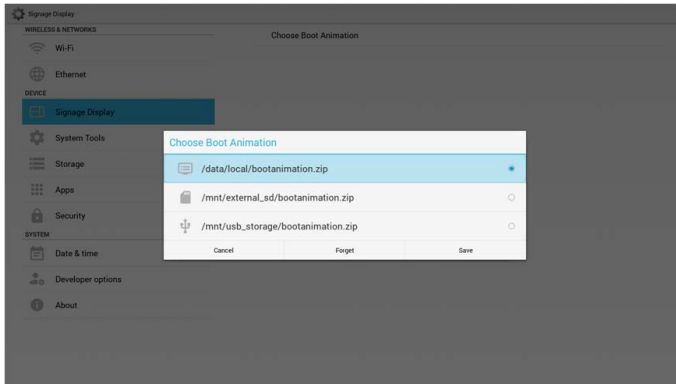

3) If OSD menu Logo item is On or Off, the users cannot choose boot animation in Android settings.

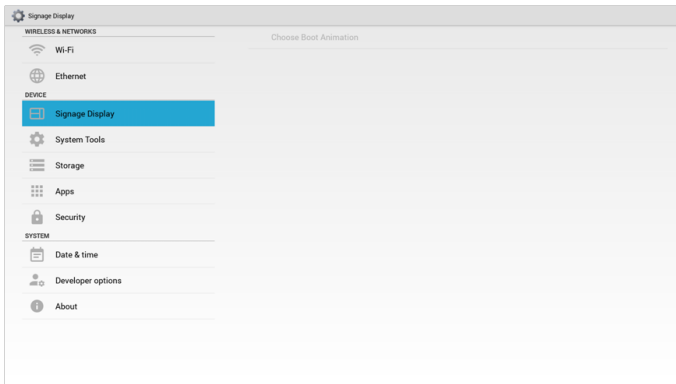

Source Settings

I. Media Player

Can Edit Media Player play list and effect settings.

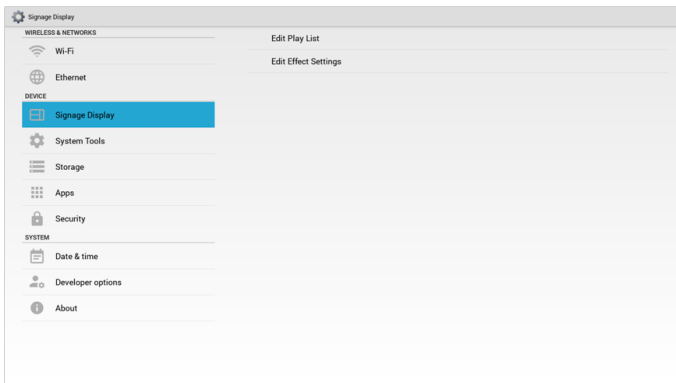

1) Open Media Player Player List edit page.



2) Open Media Player slideshow effect edit page.

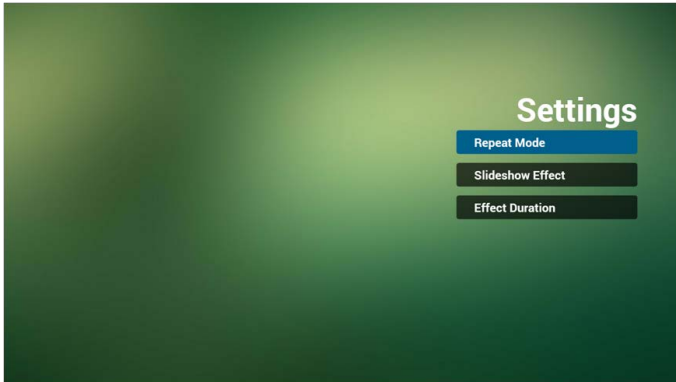

2. Browser

Can edit Bookmark configuration.

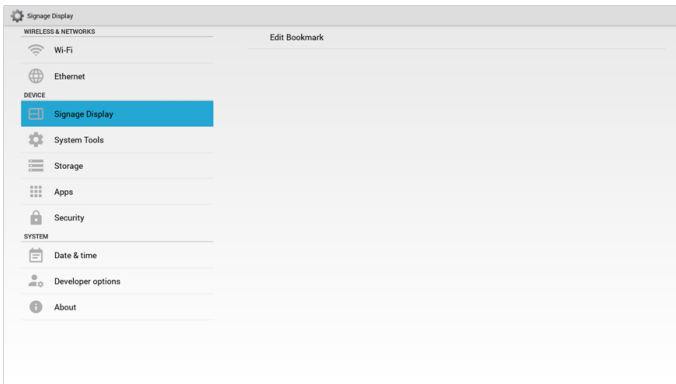

1) Open Browser setting page.

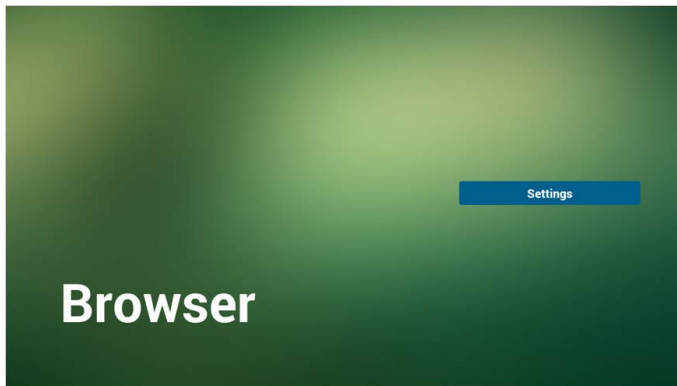

3. PDF Player

Can edit PDF Player Play List and Effect Settings.

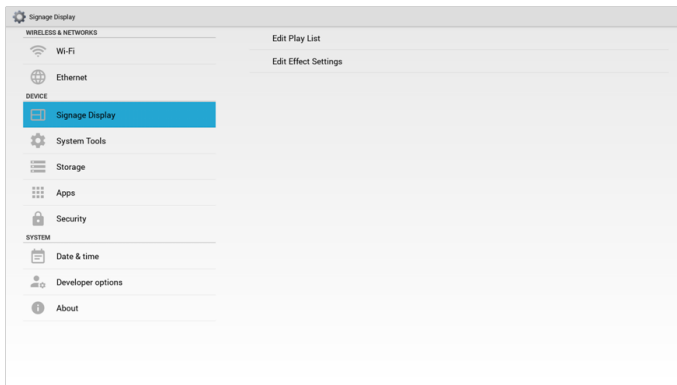

1) Open PDF Player Play List edit page.

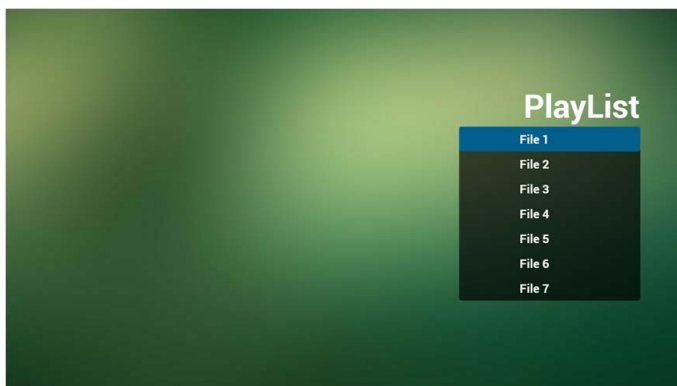

2) Open PDF Player effect edit page.

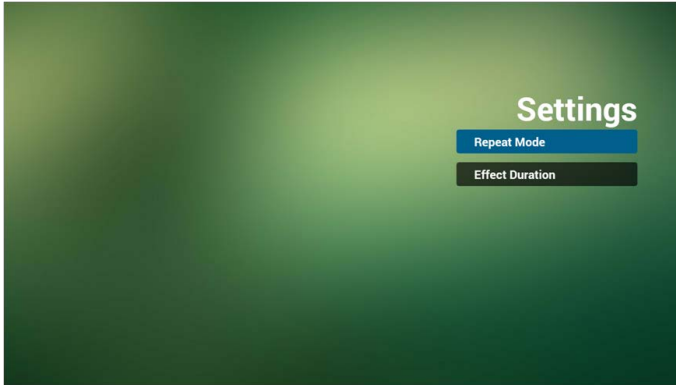

System Tools

System tools 3 main functions:

1. Clear Storage
2. Factory Reset
3. Import & Export

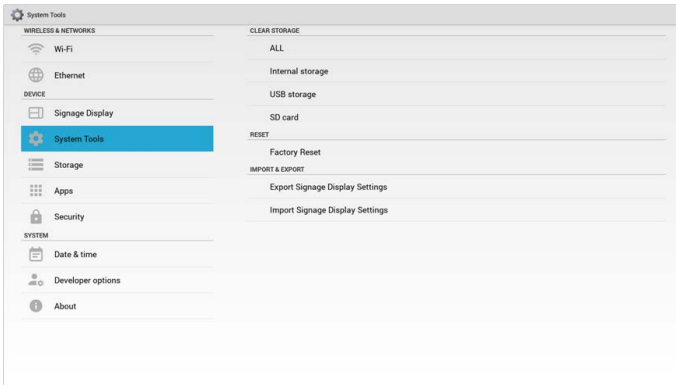

Clear Storage

The purpose is to clear all data in Benq folders.

Divided into 4 mode:

1. Clear all benq folder.
2. Only clear benq folder under Internal storage.
3. Only clear benq folder under USB storage.
4. Only clear benq folder under SD card.

Pop-up the window to display all folders which can be clear.

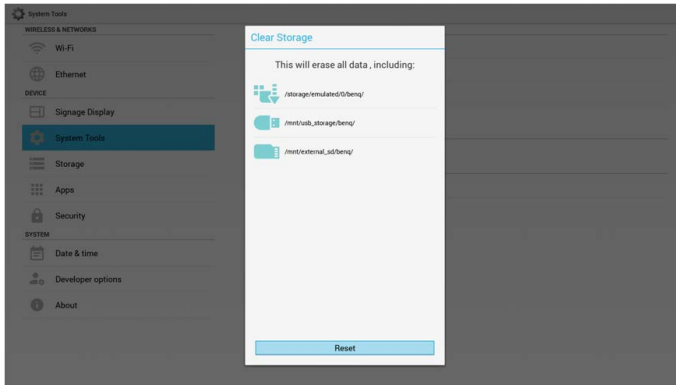

Factory Reset

Factory Reset can recover to Factory default settings.

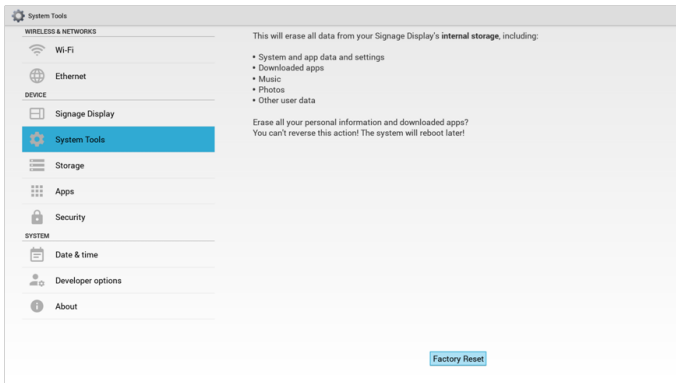

Press OK to execute Reset function automatically.

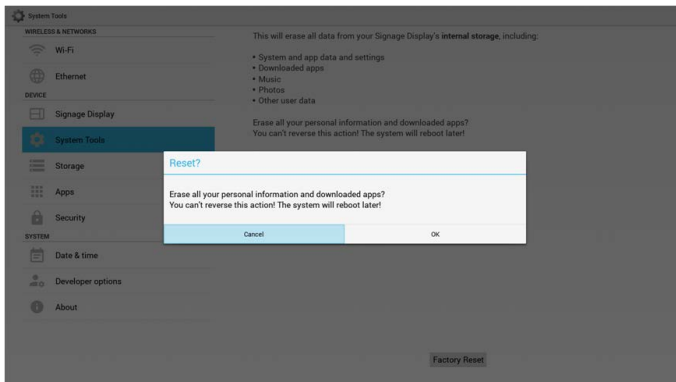

Import & Export

The function of Import & Export PD settings.



1. Saved file name: settings.db
 2. Will save to benq folder in storage.
-

1. Export

Will export settings.db to benq folder under USB or SD card.



If no benq folder exists in USB or SD card, it will be created automatically.

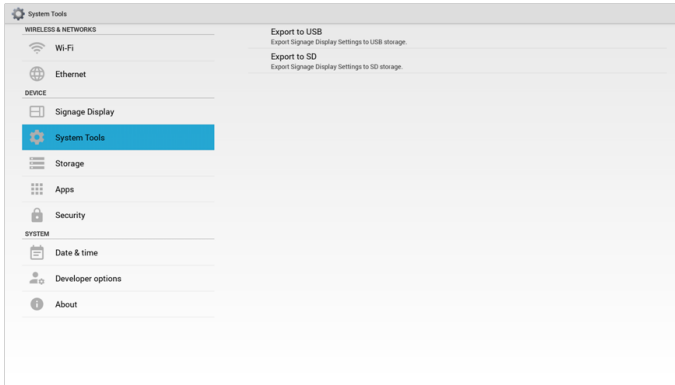

2. Import

Import settings.db from benq folder under USB or SD card.

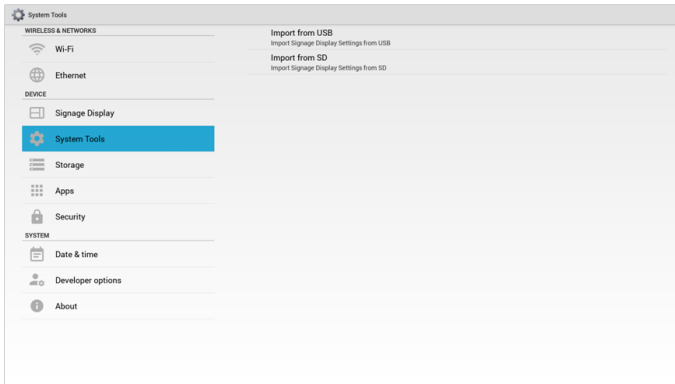

Storage

Display current PD Android storage information.

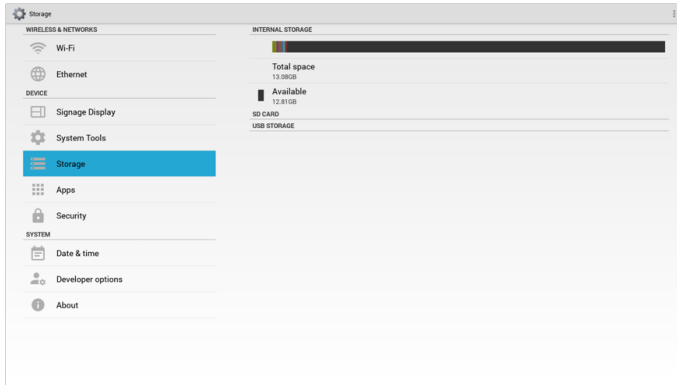

SD CARD and USB STORAGE :

Need to insert SD card or USB, the information will show up total space and available of SD card or USB storage.

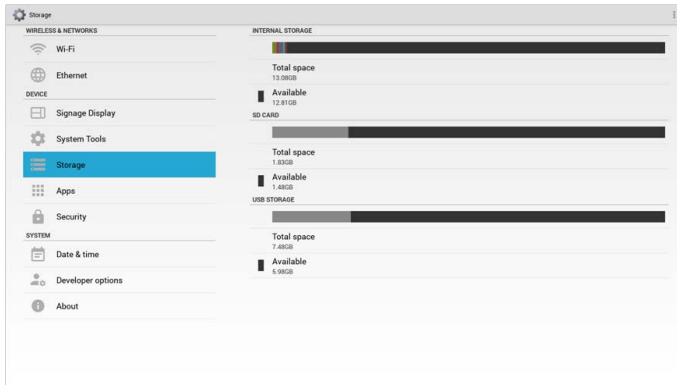

Apps

Display applications information.

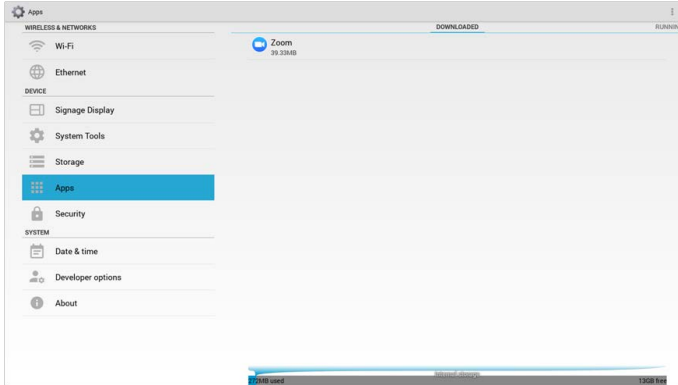

Date & time

Adjust date, time and timezone via NTP.

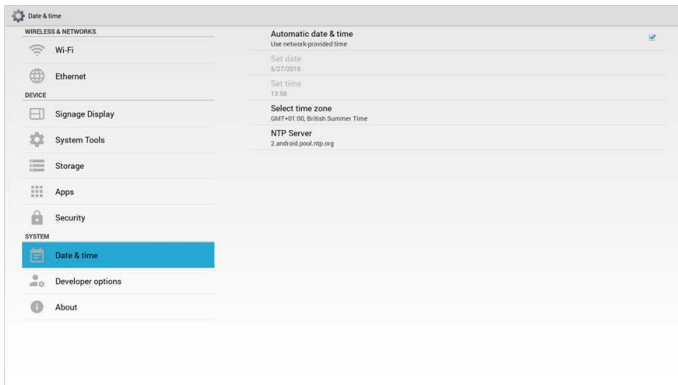

Set date and time by yourself when you disable Automatic date & time setting.

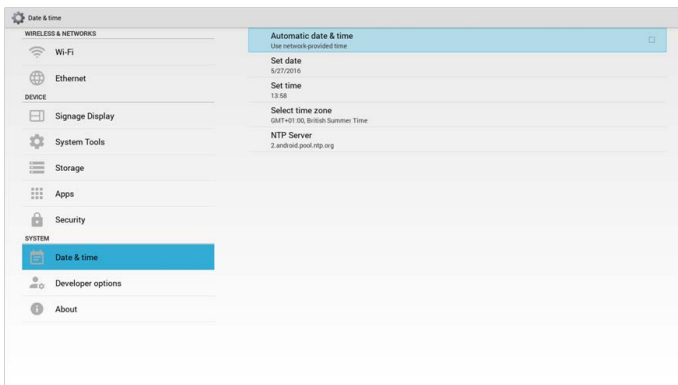

Setting date

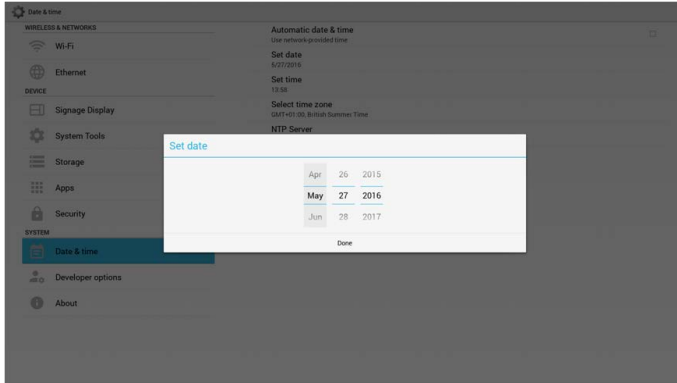

Setting time

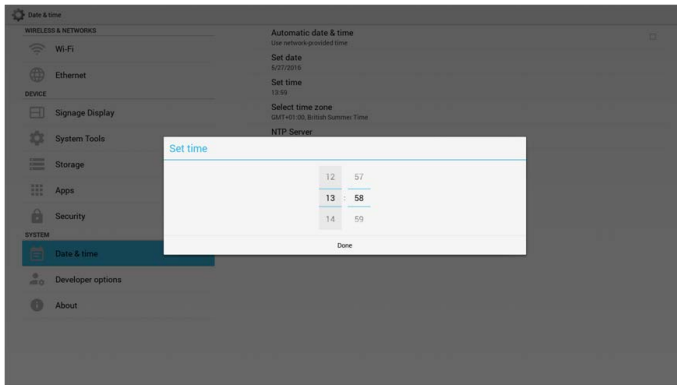

Developer options

Android developer options.

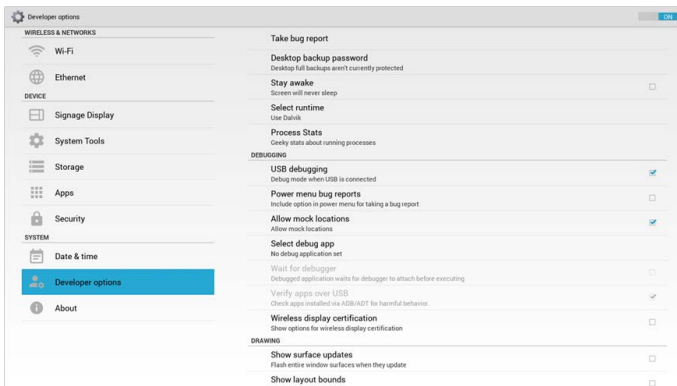

About

Main info in About:

1. BenQ Software Update
2. Android version
3. Kernel version
4. Build number

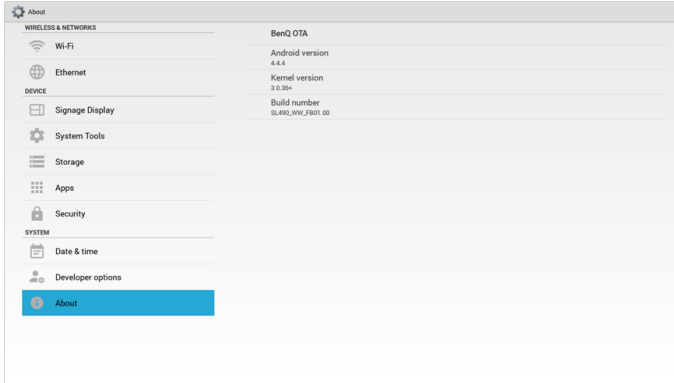

BenQ Software Update

Software upgrade via the Internet or USB device.

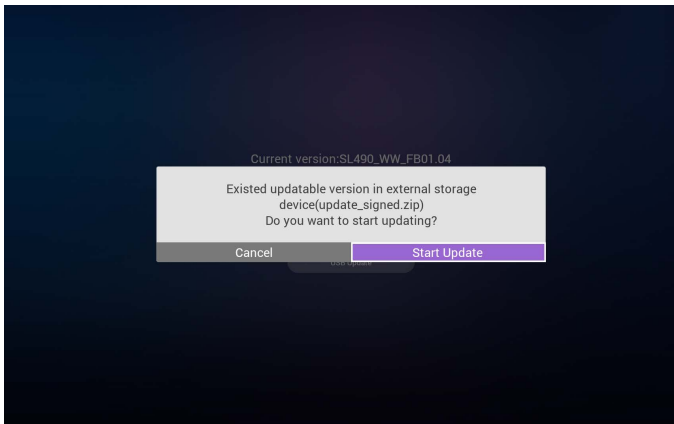

After select update.zip file, PD will restart and start to update.

Supplementary

Rotation

Via Scalar OSD menu to operate Rotation:

Home > Configuration2 > Rotation > OSD rotation

1. Landscape

After set up Landscape mode, the setting screen will divide into 2 part.
Select Left item, right side will display the sub menu.

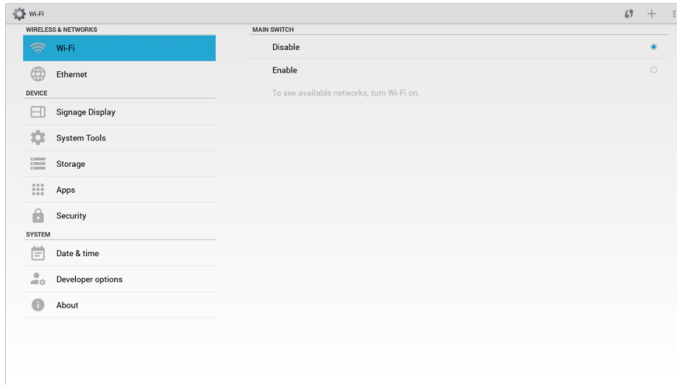

2. Portrait

After set up Portrait mode, the setting screen only display one layer.

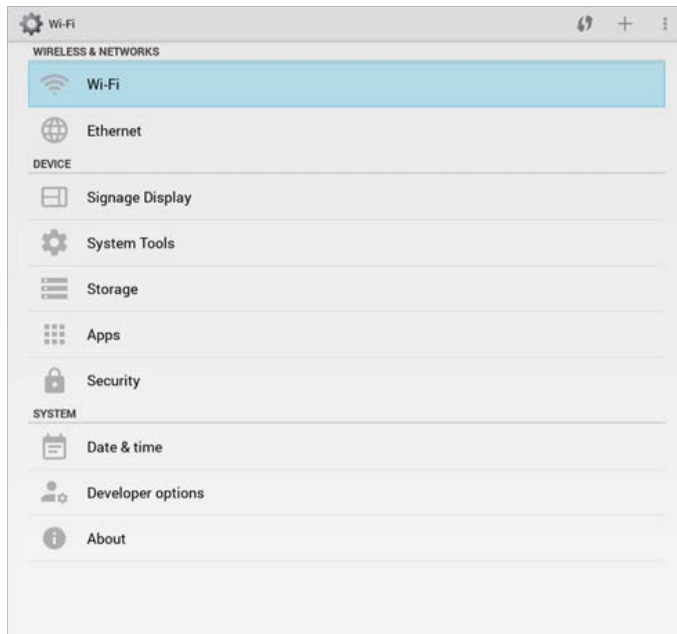

OSD Menu

An overall view of the On-Screen Display (OSD) structure is shown below. You can use it as a reference for further adjusting your display.

Navigating the OSD Menu

Navigating the OSD menu using the remote control

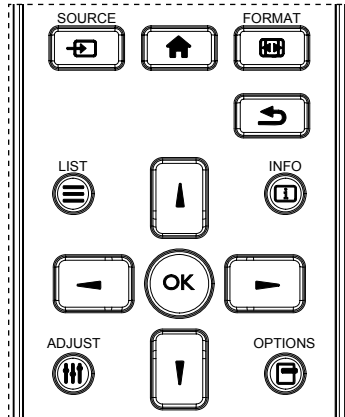

1. Press button on the remote control to display the OSD menu.
2. Press or button to choose the item you want to adjust.
3. Press OK or button to enter the submenu.
4. In the submenu, press or button to toggle among items, press or button to adjust settings. If there is a submenu, press OK or button to enter the submenu.
5. Press button to return to the previous menu, or press button to exit the OSD menu.



- When there is no OSD menu on the screen, press to display the menu of **picture mode**.
- When there is no OSD menu on the screen, press to display the menu of **Audio source**.

Navigating the OSD menu using the display's control buttons

1. Press MENU button to display the OSD menu.
2. Press or button to choose the item you want to adjust.
3. Press button to enter the submenu.
4. In the submenu, press or button to toggle among items, press or button to adjust settings. If there is a submenu, press button to enter the submenu.
5. Press MENU button to return to the previous menu, or press MENU button several times to exit the OSD menu.

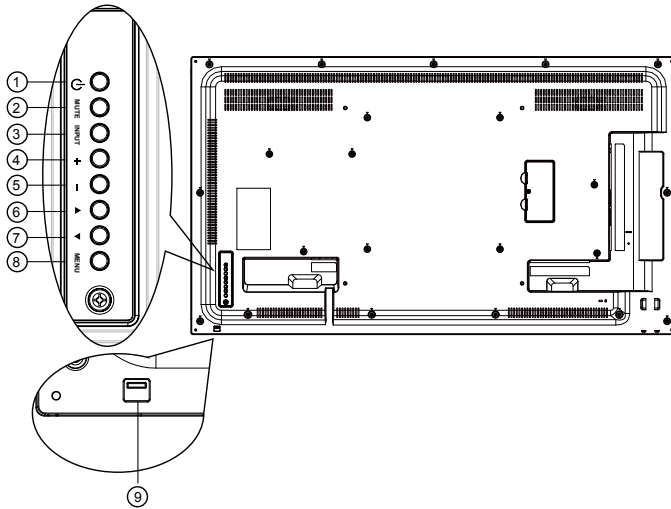





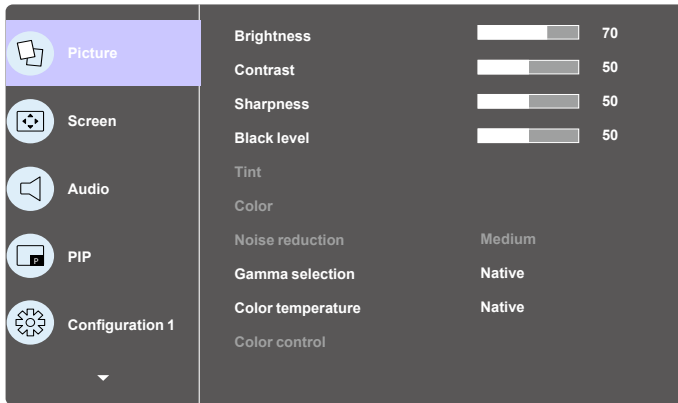

OSD Menu Overview

Picture menu



Name	Description
Brightness (Picture)	Adjust the overall image and background screen brightness(backlight).
Contrast	Adjust the image contrast ratio for the input signal.
Sharpness	This function is digitally capable to keep crisp image at any timings. It is adjustable to get a distinct image or a soft one as you prefer and set independently for each picture mode.

Black level	Adjust the image brightness for the background.  sRGB picture mode is standard and cannot be changed.
Tint (Hue)	Adjust the tint of the screen.  YUV signal only.
Color (Saturation)	Adjust the color of the screen.  YUV signal only.
Noise Reduction	Adjust the noise reduction level.  YUV signal only.
Gamma selection	Select a display gamma, It's refer to the brightness performance curve of signal input. Choose from Native / 2.2 / 2.4.  sRGB picture mode is standard and cannot be changed.
Color temperature	It is used to adjust the color temperature. The image becomes reddish as the color temperature decreases, and becomes bluish as the color.
Color control	The color levels of red, green, and blue are adjusted by the color bars. R: Red gain, G: Green gain, B: Blue gain.  Available when Color Temp. = User1 or User2 only.
Picture mode	PQ setting PC mode: Standard / Highbright / sRGB. Video mode: Standard / Highbright / Cinema.
Overscan	Change the display area of the image. ON: Set to display area about 95%. OFF: Set to display area about 100%.
Picture reset	Reset all settings in the Picture menu. Select "Yes" and press "SET" button to restore to factory preset data. Press "EXIT" button to cancel and then return to the previous menu.

Screen menu

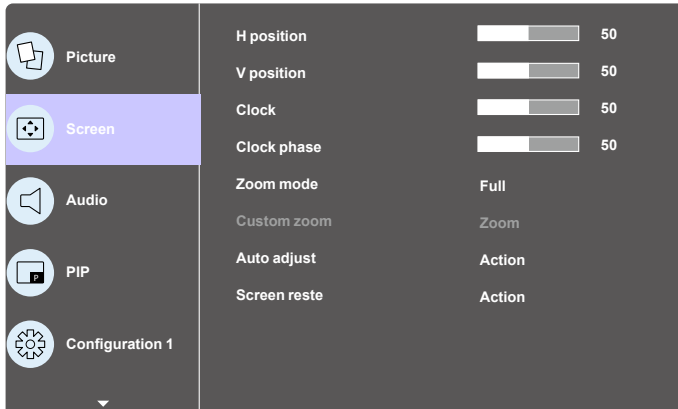

Name	Description
H position	Control Horizontal Image position within the display area of the LCD.
V position	Control Vertical Image position within the display area of the LCD.
Clock	VGA input only.
Clock phase	Improves focus, clarity and image stability by increasing or decreasing this setting.  VGA input only.



PC mode: **Full / 4:3 / 1:1 / 16:9 / 21:9 / Custom.**







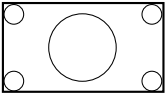
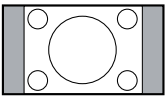
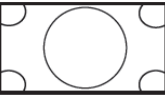
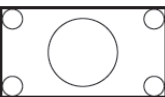

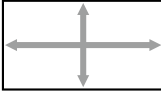
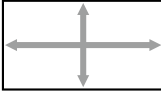
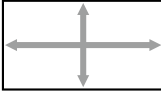
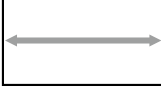
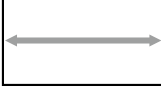
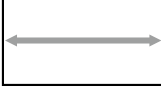

Video mode: **Full / 4:3 / 1:1 / 16:9 / 21:9 / Custom.**

* Zoom mode setting is by input. If input in multi-windows, the setting will apply for windows with the same input.

And the INFO OSD will show the latest setting.

Zoom mode

	<p>Full</p> <p>This mode restores the correct proportions of pictures transmitted in 16:9 using the full screen display.</p>
	<p>4:3</p> <p>The picture is reproduced in 4:3 format and a black band is displayed on either side of the picture..</p>
	<p>1:1</p> <p>This mode displays the image pixel-by-pixel on screen without scaling the original image size.</p>
	<p>16:9</p> <p>The picture is reproduced in 16:9 format and a black band at the top and bottom.</p>
	<p>21:9</p> <p>The picture is reproduced in 21:9 format and a black band at the top and bottom.</p>
	<p>Custom</p> <p>Choose to apply the custom zoom settings in the Custom Zoom submenu.</p>

Custom zoom	<p>You can use this function to further customize the zoom settings to suit the image you want to display.</p>		
	<p> This item is functional only when the Zoom mode is set to Custom.</p>		
	<table border="1"> <tr> <td data-bbox="404 245 594 352">  </td> <td data-bbox="594 245 1033 352"> <p>Zoom Expands the horizontal and vertical sizes of the image simultaneously.</p> </td> </tr> </table>		<p>Zoom Expands the horizontal and vertical sizes of the image simultaneously.</p>
		<p>Zoom Expands the horizontal and vertical sizes of the image simultaneously.</p>	
	<table border="1"> <tr> <td data-bbox="404 362 594 469">  </td> <td data-bbox="594 362 1033 469"> <p>H zoom Expands the horizontal size of the image only.</p> </td> </tr> </table>		<p>H zoom Expands the horizontal size of the image only.</p>
		<p>H zoom Expands the horizontal size of the image only.</p>	
<table border="1"> <tr> <td data-bbox="404 472 594 579">  </td> <td data-bbox="594 472 1033 579"> <p>V zoom Expands the vertical size of the image only.</p> </td> </tr> </table>		<p>V zoom Expands the vertical size of the image only.</p>	
	<p>V zoom Expands the vertical size of the image only.</p>		
<table border="1"> <tr> <td data-bbox="404 582 594 689">  </td> <td data-bbox="594 582 1033 689"> <p>H position Moves the horizontal position of the image left or right.</p> </td> </tr> </table>		<p>H position Moves the horizontal position of the image left or right.</p>	
	<p>H position Moves the horizontal position of the image left or right.</p>		
<table border="1"> <tr> <td data-bbox="404 692 594 799">  </td> <td data-bbox="594 692 1033 799"> <p>V position Moves the vertical position of the image up or down.</p> </td> </tr> </table>		<p>V position Moves the vertical position of the image up or down.</p>	
	<p>V position Moves the vertical position of the image up or down.</p>		
Auto adjust	<p>Press "Set" to detect and adjust H position, V position, Clock, Phase automatically.</p>		
Screen reset	<p>Reset all settings in the Screen menu to factory preset values. Select "Yes" and press "SET" button to restore the factory preset data.</p> <p>Press "EXIT" button to cancel and then return to the previous menu.</p>		

Audio menu

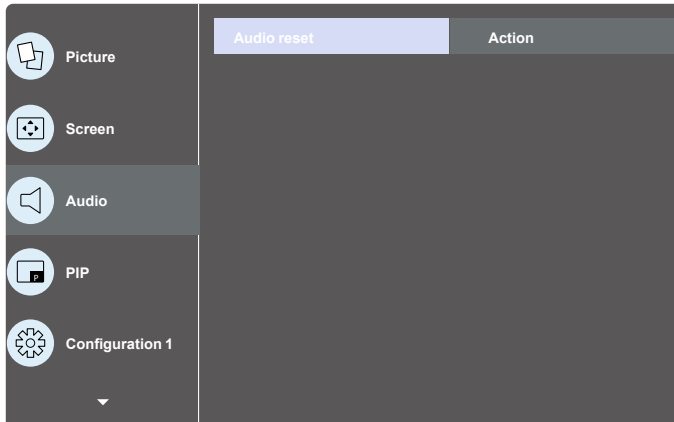
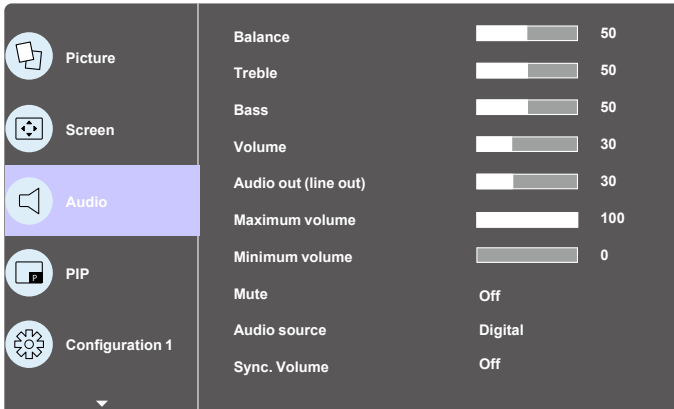



Name	Description
Balance	Adjust to emphasize left or right audio output balance.
Treble	Adjust to increase or decrease higher-pitched sounds.
Bass	Adjust to increase or decrease lower-pitched sounds.
Volume	Adjust to increase or decrease the audio output level.
Audio out (line out)	Adjust to increase or decrease line out output level.
Maximum volume	Adjust your own limitation for the maximum volume setting. This stops the volume from being played too loudly.
Minimum volume	Adjust your own limitation for the minimum volume setting.
Mute	Turn the mute function on/off.

Audio source	Select the audio input source. Analog: audio from audio input Digital : audio from HDMI/DVI audio. Displyport: audio from DP.
Sync. Volume	Enable/disable audio out (line out) volume adjustability to sync with internal speakers.
Audio reset	Reset all settings in the Audio menu to factory preset values.

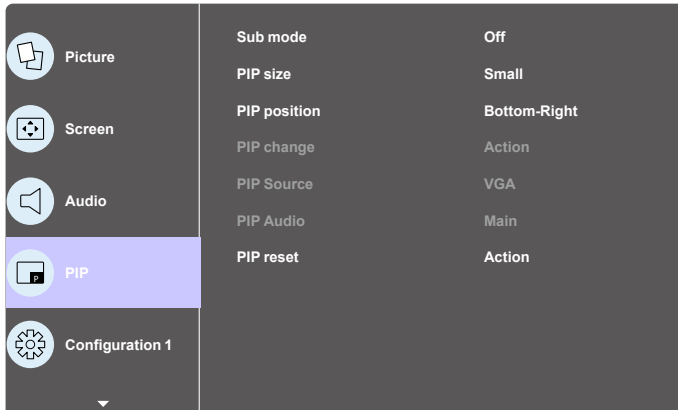
PIP menu

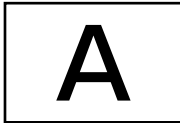

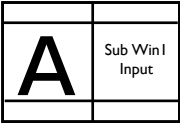
Name	Description
Sub mode	<p>Select the sub mode. Choose from: Off / PIP / POP / Quick swap / PBP.</p> <div style="display: flex; justify-content: space-around;"> <div style="border: 1px solid black; padding: 5px; text-align: center;"> <p>Off</p>  </div> <div style="border: 1px solid black; padding: 5px; text-align: center;"> <p>PIP</p>  </div> <div style="border: 1px solid black; padding: 5px; text-align: center;"> <p>PBP 2Win</p>  </div> </div> <p style="text-align: center;">Quick swap</p> <div style="display: flex; align-items: center; justify-content: center;"> <div style="border: 1px solid black; padding: 5px; text-align: center; margin-right: 10px;"> <p>A</p> </div> <div style="margin-right: 10px;"> <p>← →</p> </div> <div style="border: 1px solid black; padding: 5px; text-align: center;"> <p>B</p> </div> </div> <p>Switch main on top or sub on top.</p>
PIP size	Select the size of the sub picture in the PIP (Picture-in-Picture) mode. Choose from: Small / Medium / Large .

PIP position	Select the position of the sub picture in the PIP (Picture-in-Picture) mode. Choose from: Bottom-Right / Bottom -Left / Top-Right / Top-Left.																																																																																																																									
PIP change	Exchange Main and PIP / PBP / Quick swap input signal.																																																																																																																									
PIP source	Select the input signal for the sub picture.																																																																																																																									
PIP audio	Select the audio source in the Sub mode. <ul style="list-style-type: none"> • Main - Select audio from the main picture • Sub - Select audio from the sub picture. 																																																																																																																									
PIP reset	Reset all settings in the PIP menu to factory preset values. <ul style="list-style-type: none"> • The PIP function is available only for certain signal source combinations as shown in the table below. <table border="1" data-bbox="311 515 1015 916"> <thead> <tr> <th></th> <th>HDMI1</th> <th>HDMI2</th> <th>DVI</th> <th>DisplayPort</th> <th>VGA</th> <th>Medoa Player</th> <th>Browser</th> <th>X-Sign</th> <th>PDF Reader</th> <th>Android</th> </tr> </thead> <tbody> <tr> <td>HDMI1</td> <td>○</td> <td>×</td> <td>×</td> <td>○</td> <td>○</td> <td>×</td> <td>×</td> <td>×</td> <td>×</td> <td>×</td> </tr> <tr> <td>HDMI2</td> <td>×</td> <td>○</td> <td>×</td> <td>○</td> <td>○</td> <td>×</td> <td>×</td> <td>×</td> <td>×</td> <td>×</td> </tr> <tr> <td>DVI</td> <td>×</td> <td>×</td> <td>○</td> <td>○</td> <td>○*</td> <td>×</td> <td>×</td> <td>×</td> <td>×</td> <td>×</td> </tr> <tr> <td>DisplayPort</td> <td>○</td> <td>○</td> <td>○</td> <td>○</td> <td>○</td> <td>○</td> <td>○</td> <td>○</td> <td>○</td> <td>○</td> </tr> <tr> <td>VGA</td> <td>○</td> <td>○</td> <td>○*</td> <td>○</td> <td>○</td> <td>○</td> <td>○</td> <td>○</td> <td>○</td> <td>○</td> </tr> <tr> <td>Medoa Player</td> <td>×</td> <td>×</td> <td>×</td> <td>○</td> <td>○</td> <td>○</td> <td>×</td> <td>×</td> <td>×</td> <td>×</td> </tr> <tr> <td>Browser</td> <td>×</td> <td>×</td> <td>×</td> <td>○</td> <td>○</td> <td>×</td> <td>○</td> <td>×</td> <td>×</td> <td>×</td> </tr> <tr> <td>X-Sign</td> <td>×</td> <td>×</td> <td>×</td> <td>○</td> <td>○</td> <td>×</td> <td>×</td> <td>○</td> <td>×</td> <td>×</td> </tr> <tr> <td>PDF Reader</td> <td>×</td> <td>×</td> <td>×</td> <td>○</td> <td>○</td> <td>×</td> <td>×</td> <td>×</td> <td>○</td> <td>×</td> </tr> <tr> <td>Android</td> <td>×</td> <td>×</td> <td>×</td> <td>○</td> <td>○</td> <td>×</td> <td>×</td> <td>×</td> <td>×</td> <td>○</td> </tr> </tbody> </table> <p>(○: PIP function available, X: PIP function unavailable)</p> <ul style="list-style-type: none"> • The availability of the PIP function will also depend on the resolution of the input signal being used. 		HDMI1	HDMI2	DVI	DisplayPort	VGA	Medoa Player	Browser	X-Sign	PDF Reader	Android	HDMI1	○	×	×	○	○	×	×	×	×	×	HDMI2	×	○	×	○	○	×	×	×	×	×	DVI	×	×	○	○	○*	×	×	×	×	×	DisplayPort	○	○	○	○	○	○	○	○	○	○	VGA	○	○	○*	○	○	○	○	○	○	○	Medoa Player	×	×	×	○	○	○	×	×	×	×	Browser	×	×	×	○	○	×	○	×	×	×	X-Sign	×	×	×	○	○	×	×	○	×	×	PDF Reader	×	×	×	○	○	×	×	×	○	×	Android	×	×	×	○	○	×	×	×	×	○
	HDMI1	HDMI2	DVI	DisplayPort	VGA	Medoa Player	Browser	X-Sign	PDF Reader	Android																																																																																																																
HDMI1	○	×	×	○	○	×	×	×	×	×																																																																																																																
HDMI2	×	○	×	○	○	×	×	×	×	×																																																																																																																
DVI	×	×	○	○	○*	×	×	×	×	×																																																																																																																
DisplayPort	○	○	○	○	○	○	○	○	○	○																																																																																																																
VGA	○	○	○*	○	○	○	○	○	○	○																																																																																																																
Medoa Player	×	×	×	○	○	○	×	×	×	×																																																																																																																
Browser	×	×	×	○	○	×	○	×	×	×																																																																																																																
X-Sign	×	×	×	○	○	×	×	○	×	×																																																																																																																
PDF Reader	×	×	×	○	○	×	×	×	○	×																																																																																																																
Android	×	×	×	○	○	×	×	×	×	○																																																																																																																

Configuration I menu

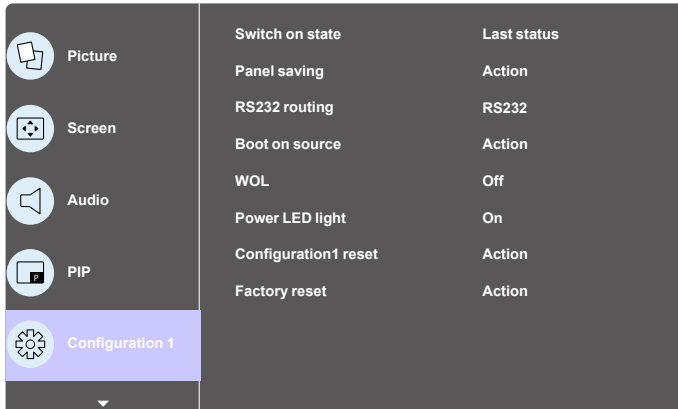

Name	Description
Switch on state	<p>Select the display status used for the next time you connect the power cord.</p> <ul style="list-style-type: none"> • Power off - The display will remain off when the power cord is connected to a wall outlet. • Forced on - The display will turn on when the power cord is connected to a wall outlet. • Last status - The display will return to the previous power status (on/off/standby) when removing and replacing the power cord.
Panel saving	<p>Choose to enable the panel saving functions and thus reduce the risk of “image persistence” or “ghost-imaging”.</p> <ul style="list-style-type: none"> • Brightness - Select On and the image brightness will be reduced to an appropriate level. The Brightness setting in the Picture menu will be unavailable when selected. • Pixel shift - Select the time interval (Auto / 10 ~ 900 Seconds / Off) for the display to slightly expand the image size and shift the position of pixels in four directions (up, down, left, or right).
RS232 routing	<p>Select the network control port.</p> <p>Choose from: RS232 / LAN > RS232.</p>
Boot on source	<p>Choose to select source when boot up.</p> <p>Input: select input source when bootup.</p> <p>Playlist: select playlist index for Media player, Browser, PDF player.</p> <p>0: no play list. Same as switch source from OSD. 1~7: playlist number.</p>
WOL	<p>Choose to turn on or off the wake on LAN function.</p> <p>Choose from : Off / On</p>

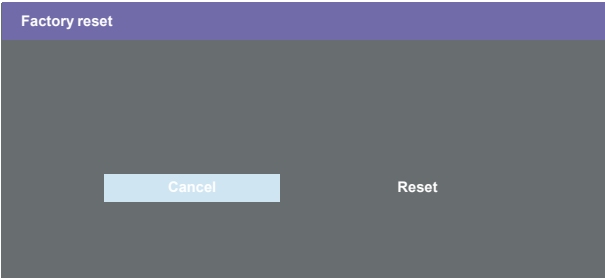

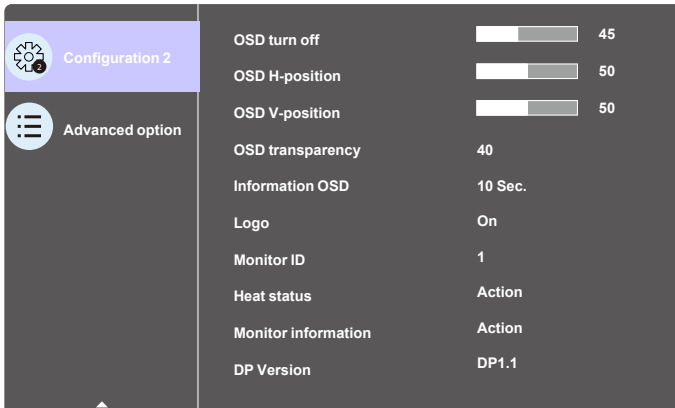

Power LED light	Choose to set power indicate LED on or off. Choose On for normal use.
Configuration I reset	Reset all settings in Configuration1 menu to the factory preset values.
Factory reset	<p>Reset all settings in the OSD menus of Picture, Screen, Audio, PIP, Configuration1, Configuration2, and Advanced option to the factory preset values.</p> <p>Android settings will also reset when factory reset.</p> <p>Press ◀ or ▶ button to select Reset, and press OK button to do the reset.</p> 

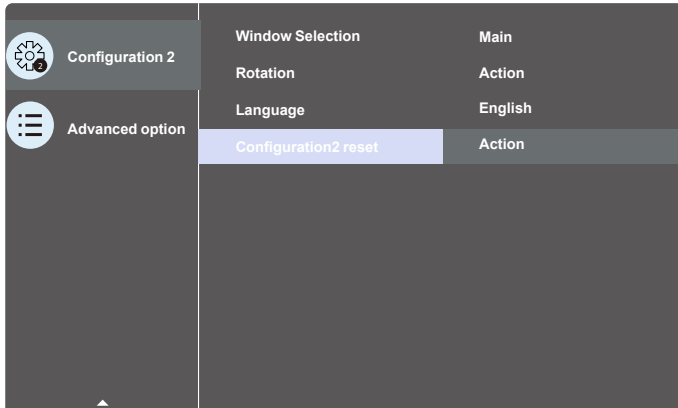
Configuration2 menu



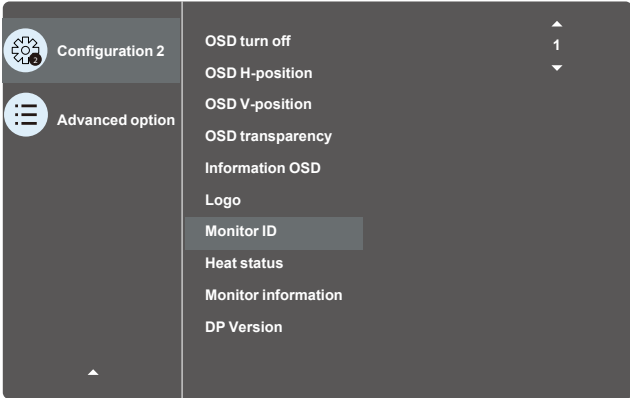

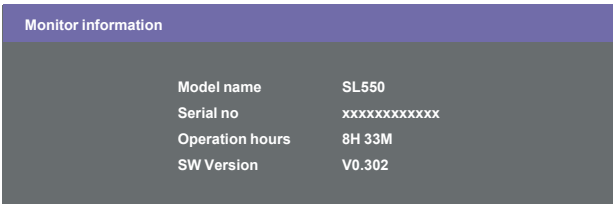

Name	Description
OSD turn off	Set the period of time the OSD (on-screen display) menu stays on the screen. The options are: 0 ~ 120 seconds. * 0 does not disappear automatically.
OSD H-position	Adjust the horizontal position of the OSD menu.
OSD V-position	Adjust the vertical position of the OSD menu.
OSD Transparency	Adjust OSD transparency. • Off - Transparency off. • 1-100 - Transparency level 1-100.
Information OSD	Set the period of time the information OSD is displayed on the upper right corner of the screen. The information OSD will display when input signal is changed. The information OSD will remain on the screen with Off selection. The options are: 1 ~ 60 seconds.
Logo	Choose to enable or disable the picture of Logo when turn on your display. The options are: • Off (Default) • On* • User** ** If Logo set to USER. User logo does NOT support rotation function.

<p>Monitor ID</p>	<p>Set the ID number for controlling the display via the RS232C connection.</p> <p>Each display must have a unique ID number when multiple sets of this display are connected. Monitor ID number range is between 1 to 98.</p> <p>Please set Monitor ID to be "1" if MDA is controlled via LAN.</p> 
<p>Heat status</p>	<p>This function allows you to check the thermal status at any time.</p> <ul style="list-style-type: none"> • A temperature-warning message will be shown on the screen if the temperature reaches 97°C (207°F). All key functions except  key will then be disabled. • Once the temperature reaches 98°C (208°F), the display power will be shut down automatically.
<p>Monitor information</p>	<p>Shows information about your display, including model number, serial number, operating hours and software version.</p> 
<p>DP version</p>	<p>DisplayPort support mode.</p> <p>The options are:</p> <ul style="list-style-type: none"> • DP 1.1 (Default) : DP 1.1 single stream(clone mode) • DP 1.2 SST: DP 1.2 Single stream(clone mode) • DP 1.2 MST: DP 1.2 Multi-Stream <p> The DP version must be set the same for all daisy chain displays.</p>

Window selection	<p>Select the window for adjusting setting. The selected window will be highlight green border.</p> <p>Window selection will set to Main after power on.</p> <p>The options are:</p> <ul style="list-style-type: none"> • Main (Default), PIP •  Hot key for Window selection function.
Rotation	<p>Set the rotation of Main/Sub/OSD</p> <p>Auto Rotate : Off/On Default : Off</p> <p>OSD Rotate : Landscape/Portrait Default : Landscape</p> <p>Image Rotate:</p> <p>All : Off/On Default : Off</p> <p>Main : Off/On Default : Off</p> <p>Sub : Off/On Default : Off</p> <p>Auto Rotate: Off, On when value is On,automatically detect whether the PD rotation, Off is set by OSD.</p> <p>OSD Rotate: Off, On when value is on, OSD rotate 90°, Off is restored.</p> <p>All: Off, On when value is on, all Window screen rotate 90°, Off the reference set individual window.</p> <p>Main: Off, On when value is onn, Main window screen rotate 90°, Off is restored.</p> <p>Sub: Off, On when value is on, SubI Window screen rotate 90°, Off is restored.</p> <p>* When the Main / Sub source is the same, rotation is given priority to with Sub.</p> <p>* Not suppoed De-Interlacing function in rotation mode.</p>
Language	<p>Select the language used in the OSD menu.</p> <p>The options are: English, Français, Español, 繁中, 简中, German, Dutch, Polish, Russia, Czech, Danish, Swedish, Italian, Romanian, Norwegian, Finnish, Greek, Arabic, Japanse, Thailand, Korean.</p>
Configuration2 reset	<p>Reset all settings in Configuration2 menu to the factory preset values.</p>

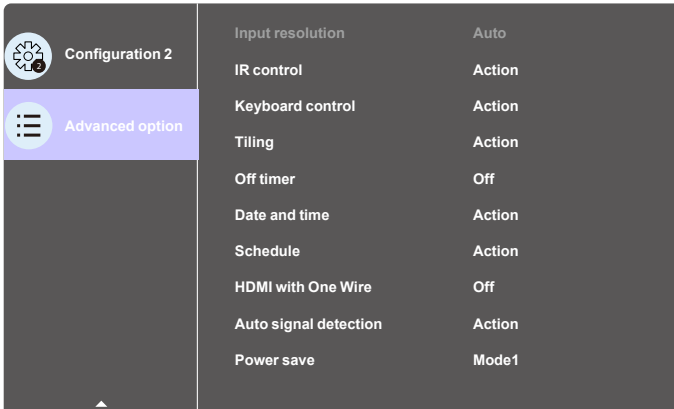
Advanced option menu



Name	Description
Input resolution	<p>Set the resolution of the VGA input. This is only required when the display is unable to detect the VGA input resolution correctly.</p> <p> This item is functional for VGA input only.</p> <p>The options are:</p> <ul style="list-style-type: none"> • 1024x768 / 1280x768 / 1360x768 / 1366x768 • 1400x1050 / 1680x1050 • 1600x1200 / 1920x1200 • Auto: Determines the resolution automatically. <p>The selected settings will become effective after turning off the power and turning it on again.</p>
IR control	<p>Select the operation mode of the remote control when multiple displays are connected via an RS232C connection.</p> <ul style="list-style-type: none"> • Normal - All displays can be operated normally by the remote control unit. • Primary - Designate this display as the primary display for remote control operation. Only this display can be operated by the remote control. (In primary mode, IR key will always be processed regardless the monitor id/group settings). • Secondary - Designate this display as the secondary display. This display can not be operated by the remote control, and will only receive the control signal from the primary display via the RS232C connection. • Lock All / Lock all but Volume / Lock all but Power / Lock all except PWR & VOL - Lock the remote control function of this display. <p>To unlock, press and hold the  INFO button on the remote control for 6 (six) seconds.</p>

Keyboard control

Choose to enable or disable the display keyboard (control buttons) function.

- **Unlock** - Enable the keyboard function.
- **Lock All / Lock all but Volume / Lock all but Power / Lock all except PWR & VOL** - Disable the keyboard function.



“Keyboard Control Lock Mode” This function completely disables the access to all Keyboard Control functions. To enable or disable the keyboard control lock, press both **+** and **▲** of remote control buttons and hold down continuously for more than 3 seconds.

Tiling

With this function you can create a single large-screen matrix (video wall) that consists of up to 100 sets of this display (**up to 10-sets on the vertical and 15-sets on the horizontal sides**). This function requires a daisy-chain connection.

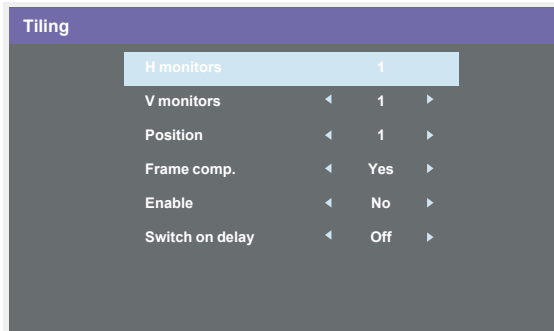

Example: 2 x 2 screen matrix (4 displays)

H monitors = 2 displays

V monitors = 2 displays

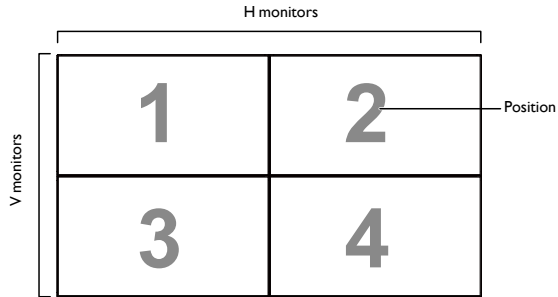

Example: 5 x 5 screen matrix (25 displays)

H monitors = 5 displays

V monitors = 5 displays

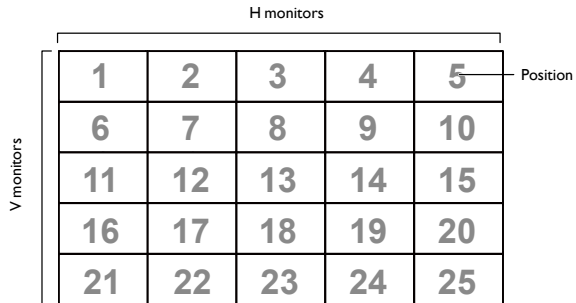

- **H monitors** - Select the number of displays on the horizontal side.
- **V monitors** - Select the number of displays on the vertical side.
- **Position** - Select the position of this display in the screen matrix.
- **Frame comp.** - Choose to turn the frame compensation function on or off. If selected **Yes**, the display will adjust the image to compensate for the width of the display bezels in order to accurately display the image.
- **Enable** - Choose to enable or disable the Tiling function. If enabled, the display will apply the settings in **H monitors**, **V monitors**, **Position**, and **Frame comp.**.
- **Switch on delay** - Set the power-on delaying time (in seconds).
The default option **Auto** allows a sequential powering-on for each display by their ID number when multiple displays are connected.
The options are: **Off/Auto/2-255**

Off Timer

Set automatically power off time (in hours).

Adjust the current date and time for the display's internal clock.

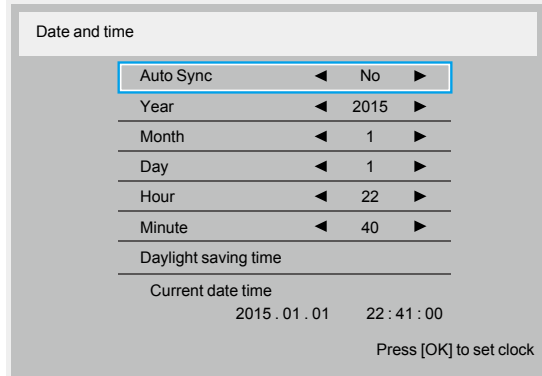
Date and time

1. Press **OK** button to enter the submenu.
2. Press **▲** or **▼** button to toggle between **Year**, **Month**, **Day**, **Hour**, **Minute**, and **Daylight saving time**.
3. Press **◀** or **▶** button to adjust all settings except **Daylight saving time**.
4. Press **OK** button to enter the **Daylight saving time** submenu.
5. Press **◀** or **▶** button to select item, press **▲** or **▼** button to adjust.

The Daylight saving time definition and behavior:

The current implementation of daylight saving is a reminder tool for the customer which doesn't know how to adjust the clock for daylight saving on and off. It does not adjust the real time clock automatically. Problem is that there are no stable rules per region, or country when to adjust the clock. To solve this the user must be able to set the daylight saving start and stop date. When daylight saving correction is on (user selectable) then the real time clock should be adjusted at the moment in time set in the daylight saving on and off date. At daylight start date the clock should be put forward 1 hour at 2 o'clock. At daylight stop date the clock should be put back 1 hour at 2 o'clock.

The existing daylight on/off menu item should be replaced with the following menu structure:

- Menu item <Daylight saving setup> opens submenu containing the following items:
 - Menu item <Daylight-saving start date> Selection item <1st, 2nd, 3rd, 4th, last> Sunday of selection item <1-12 month>
 - Menu item <Daylight-saving stop date> Selection item <1st, 2nd, 3rd, 4th, last> Sunday of selection item <1-12 month>
 - optional
 - Menu item <Correction time> Selection item <0.5, 1.0, 1.5, 2.0> hour
 - Menu item <Daylight saving correction> Selection item <on, off>

when "daylight saving" is "on" the real time clock would have been adjusted automatically for winter and summer time when passing the critical moment in time (eg march 29, 2009, 02.00 o'clock: time will be set 1 hour later or October 25, 2009, 02.00 o'clock: time will be set 1 hour earlier)

Schedule

This function allows you to program up to 7 (seven) different scheduled time intervals for the display to activate.

You can select:

- The time for the display to turn on and turn off.
- The days in a week for the display to activate.
- Which input source the display will use for each scheduled activation period.



We recommend you to set up current date and time in the **Date and time** menu before using this function.

1. Press **OK** or **▶** button to enter the submenu.

2. Press **▲** or **▼** button to select a schedule item (item number 1 ~ 7), and then press **OK** button to mark it the item number.

	<p>3. Press ◀ or ▶ button to select the schedule:</p> <ol style="list-style-type: none"> 1) Power-on schedule: Press ▲ or ▼ button to set the hour and minute for the display to turn on. 2) Power-off schedule: Press ▲ or ▼ button to set the hour and minute for the display to turn off. Select or leave an empty “_” for both the hour and minute slot if you do not want to use this power-on or power-off schedule. 3) Input-source selection: Press ▲ or ▼ button to select an input source. If no input source is selected, the input source will remain the same as last selected. 4) Date schedule: Press ▶ button to select which day in a week this schedule item will be take effect, and then press the OK button. 5) When Input-source select to USB, enable to access playlist setting: <p>4. For additional schedule settings, press ↻, then repeat the steps above. A check mark in the box next to the number of the schedule item indicates that the selected schedule is in effect.</p> <p></p> <ul style="list-style-type: none"> • If the schedules overlap, the scheduled power-on time takes priority over scheduled power-off time. • If there are two schedule items programmed for the same time, the highest numbered schedule takes priority. For example, if schedule items #1 and #2 both set the display to power on at 7:00 AM and off at 5:00 PM, then only schedule item # 2 will take effect.
HDMI with One Wire	<p>CEC control.</p> <ul style="list-style-type: none"> • Off - Disable CEC.(Default) • On - Enable CEC.
Auto signal detection	<p>Choose to let the display detect and display available signal sources automatically.</p> <ul style="list-style-type: none"> • Off - Once a signal is connected, it can only be selected manually. <p>If the selected input is no signal, set the display to display the image automatically according to the search order of each option.</p> <ul style="list-style-type: none"> • All: DP -> HDMI I -> HDMI2 -> DVI ->VGA ->Media Player -> Browser -> X-Sign.

Power Save

Power save modes

Mode 1: DC off -> Power off. LED: Red.

Power Save -> Power off, LED: Red

Mode 2: DC off -> Power off, LED: Red.

Power Save -> Power Saving. LED: Orange. Can be wake up.

Mode 3: DC off -> Back light off, LED: Red

Power Save -> Back light off, LED: Orange. Can be wake up.

Mode 4: DC off -> Back light off, LED: Red

Power Save -> Will not enter power save mode. show “no signal” only.



- When Auto FW update is not OFF, display will work under Mode3 for FW update, but OSD item will not change.
- Please set to Mode 3 / 4 to wake up the display via MDA LAN control if this function is desired.





<p>Mode 3</p> <p>DC OFF:</p> <ul style="list-style-type: none"> • Backlight off only <p>Power Save:</p> <ul style="list-style-type: none"> • Backlight off only 	<p>Mode 1 (default)</p> <p>DC OFF:</p> <ul style="list-style-type: none"> • Power Off <p>Power Save:</p> <ul style="list-style-type: none"> • Power Off
<p>Mode 4</p> <p>DC OFF:</p> <ul style="list-style-type: none"> • Backlight off only <p>Power Save:</p> <ul style="list-style-type: none"> • No signal (Backlight On) 	<p>Mode 2</p> <p>DC OFF:</p> <ul style="list-style-type: none"> • Power Off <p>Power Save:</p> <ul style="list-style-type: none"> • Power Saving

Power Save

Following table is the action for Android board with different power mode.

DC off/on : press power button by RC

Power mode in OSD	Mode 1/2	Mode 3/4
DC off	shutdown	<ol style="list-style-type: none"> 1. The current source APK(such as MediaPlayer, Browser, PDF, X-Sign or Custom) will be closed. 2. Android system will go to the default black launcher.
DC on	Boot up	Android system reboots

Scalar FW Update	Update scalar FW by USB.
USB cloning	<p>Copy PD settings from one set to another.</p> <p>Import: Copy settings from file to display</p> <p>Export: Copy PD settings into file.</p> <p>* Cloned data stores in android internal storage. User need to use APK to copy cloned data to another display.</p>
Advanced option reset	<p>Reset all settings except Date and Time in the Advanced option menu to factory preset values.</p> <ol style="list-style-type: none"> 1. Press OK or  button to enter the submenu. 2. Press  or  button to select Reset and press the OK button to restore settings to factory preset values. 3. Press the  button or select Cancel and press the OK button to cancel and then return to the previous menu.

USB device compatibility

USB Multimedia Codec formats

Video Decode

Type	Video Codec	Container	Decode	Encode	Channel	Remark
MPEG1/2	MPEG1/2	File Format: DAT, MPG, VOB, TS	V			Supported Image Size: 48x48 pixels to 1920x1080 pixels Maximum Frame Rate: 30fps Maximum Bit Rate: 80Mbps Audio Codec: MP2, MP3
MPEG-4	MPEG4	File Format: AVI, MKV, MP4, MOV, 3GP	V			Supported Image Size: 48x48 pixels to 1920x1080 pixels Maximum Frame Rate: 30fps Maximum Bit Rate: 38.4Mbps Audio Codec: MP2, MP3, AAC, PCM, (1) Not support MS MPEG4 v1/v2/v3 (2) Not support GMC (global motion compensation)
H.263	H.263	File Format: 3GP, MOV, MP4	V			Supported Image Size: SQCIF(128x96), QCIF(176x144), CIF(352x288), 4CIF(704x576) Maximum Frame Rate: 30fps Maximum Bit Rate: 38.4Mbps Audio Codec: MP3 (1) Not support H.263+
H.264	H.264	File Format: AVI, MKV, MP4, MOV, 3GP, TS, FLV	V			Supported Image Size: 48x48 pixels to 1920x1080 pixels Maximum Frame Rate: 30fps Maximum Bit Rate: 57.2Mbps Audio Codec: MP2, MP3, AAC, PCM (1) Not support MBAFF
GOOGLE VP8	VP8	File Format: WEBM	V			Supported Image Size: 48x48 pixels to 1920x1080 pixels Maximum Frame Rate: 30fps Maximum Bit Rate: 38.4Mbps Audio Codec: Ogg Vorbis
VC-1	VC1	File Format: ASF, TS, MKV, AVI	V			Supported Image Size: 48x48 pixels to 1920x1080 pixels Maximum Frame Rate: 30fps Maximum Bit Rate: 45Mbps Audio Codec: MP2, MP3, AAC, WMA
Motion JPEG	MJPEG	File Format: AVI, MOV	V			Supported Image Size: 48x48 pixels to 1920x1080 pixels Maximum Frame Rate: 30fps Maximum Bit Rate: 38.4Mbps Audio Codec: MP2, MP3, AAC, PCM

Audio Decode

Type	Audio Codec	Container	Decode	Encode	Channel	Remark
MPEG Audio	MPEG 1/2/2.5 Audio Layer 1/2/3	Decode: MPI, MP2, MP3	V		2	Bit Rate: 8kbps~320Kbps, CBR and VBR Sampling Rate: 8KHZ~48KHz
Windows Media Audio	WMA Version 4, 4.1, 7, 8, 9, wmapro	Decode: WMA	V		2	Bit Rate: 8kbps~320Kbps Sampling Rate: 8KHZ~48KHz Non-support WMA Pro, lossless and MBR
AAC Audio	MAIN, ADIF, ATDS Header AAC-LC and AAC-HE	File Format: AAC, M4A	V		5.1	Bit Rate: N/A Sampling Rate: 8KHZ~48KHz

Image Decode

Type	Image Codec	Photo	Decode	Encode	Channel	Remark
JPEG	JFIF file format 1.02	File Format: JPG, JPEG	V			Decode: Resolution 48X48 to 8176X8176 (1) Not Support Non-interleaved Scan (2) Software support SRGB JPEG (3) Software support Adobe RGB JPEG
BMP	BMP	File Format: BMP	V			Maximum Supported Image Size: 4096x4096 pixels
GIF	GIF	File Format: GIF	V			Resolution No Restriction
PNG	PNG	File Format: PNG	V			Resolution No Restriction



- Sound or video may not work if the contents have a standard bit rate/frame rate above the compatible Frame/sec listed in the table above.
- Video content with a Bit rate or Frame rate larger than the rate specified in the table above can cause choppy video during playback.

Input Mode

VGA Resolution:

Standard Resolution	Active Resolution		Refresh Rate	Pixel Rate	Aspect Ratio	Stand for Mode
	H Pixels	V Lines				
VGA	640	480	60 Hz	25.175 MHz	4:3	Video Graphic Array
			72 Hz	31.5 MHz		
			75 Hz	31.5 MHz		
WVGA	720	400	70 Hz	33.75 MHz	16:9	WideVideo Graphic Array
SVGA	800	600	60 Hz	40 MHz	4:3	SuperVGA
			75 Hz	49.5 MHz		
XGA	1024	768	60 Hz	65 MHz	4:3	Extended Graphic Array
			75 Hz	78.75 MHz		
WXGA	1280	768	60 Hz	79.5 MHz	5:3	Wide XGA
WXGA	1280	800	60 Hz	79.5 MHz	16:10	Wide XGA
SXGA	1280	960	60 Hz	108 MHz	4:3	Super XGA
SXGA	1280	1024	60 Hz	108 MHz	5:4	Super XGA
WXGA	1360	768	60 Hz	85.5 MHz	16:9	Wide XGA
WXGA	1366	768	60 Hz	85.5 MHz	16:9	Wide XGA
UXGA	1600	1200	60 Hz	162 MHz	4:3	Ultra XGA
HD 1080	1920	1080	60 Hz	148.5 MHz	16:9	HD 1080

SDTV Resolution:

Standard Resolution	Active Resolution		Refresh Rate	Pixel Rate	Aspect Ratio	Stand for Mode
	H Pixels	V Lines				
480i	720	480	29.97 Hz	13.5 MHz	4:3	Modified NTSC Standard
480p			59.94 Hz	27 MHz		
576i	720	480	25 Hz	13.5 MHz	4:3	Modified PAL Standard
576p			50 Hz	27 MHz		

HDTV Resolution:

Standard Resolution	Active Resolution		Refresh Rate	Pixel Rate	Aspect Ratio	Stand for Mode
	H Pixels	V Lines				
720p	1280	720	50 Hz	74.25 MHz	16:9	Normally DVB Mode
			60 Hz			
1080i	1920	1080	25 Hz	74.25 MHz	16:9	Normally ATSC Mode
			30 Hz			
1080p	1920	1080	50 Hz	148.5 MHz	16:9	Normally ATSC Mode
			60 Hz			

- The PC text quality is optimum in HD 1080 mode (1920 x 1080, 60Hz).
- Your PC display screen might appear different depending on the manufacturer (and your particular version of Windows).

- Check your PC instruction book for information about connecting your PC to a display.
- If a vertical and horizontal frequency-select mode exists, select 60Hz (vertical) and 31.5KHz (horizontal). In some cases, abnormal signals (such as stripes) might appear on the screen when the PC power is turned off (or if the PC is disconnected). If so, press the **INPUT** button to enter the video mode. Also, make sure that the PC is connected.
- When horizontal synchronous signals seem irregular in RGB mode, check PC power saving mode or cable connections.
- The display settings table complies to the IBM/VESA standards, and based on the analog input.
- The DVI support mode is regarded as same to the PC support mode.
- The best timing for the vertical frequency to each mode is 60Hz.

Pixel Defect Policy

We strive to deliver the highest quality products and use some of the industry's most advanced manufacturing processes whilst practicing stringent quality control. However, pixel or sub-pixel defects on the PDP / TFT panels used in Plasma- & LCD- displays are sometimes unavoidable. No manufacturer can guarantee that all panels will be free from pixel defects, but Benq guarantees that any Plasma- & LCD- displays with an unacceptable number of defects will be repaired during the warranty period in line with your local guarantee conditions.

This notice explains the different types of pixel defects and defines the acceptable defect level for the LCD screen. In order to qualify for repair under warranty, the number of pixel defects must exceed a certain level as shown in the reference table. If the LCD screen is within specification a warranty exchange / claim back will be refused.

Additionally, because some types or combinations of pixel defects are more noticeable than others, Benq sets even higher quality standards for those.

Pixels and Sub-Pixels

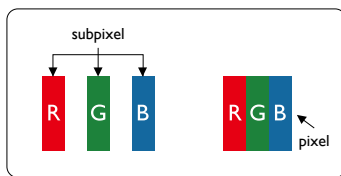

A pixel, or picture element, is composed of three sub-pixels in the primary colors of red, green and blue. Many pixels together form an image. When all sub-pixels of a pixel are lit, the three colored sub-pixels together appear as a single white pixel. When all are dark, the three colored sub-pixels together appear as a single black pixel. Other combinations of lit and dark sub-pixels appear as single pixels of other colors.

Types of Pixel Defects + Dot Definition

Pixel and sub-pixel defects appear on the screen in different ways. There are three categories of pixel defects and several types of sub-pixel defects within each category.

Dot definition = What is a defective “Dot”?

One or more defective, adjacent sub-pixel are defined as one “dot”. The no. of defective sub-pixels are not relevant to define a defective dot. This means that a defective dot can consist of one, two or three defective sub-pixels which can be dark or lit.

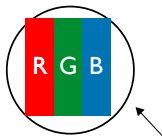

One dot = One Pixel; consists of three sub-pixels of Red, Green, and Blue.

Bright Dot Defects

Bright dot defects appear as pixels or sub-pixels that are always lit or “on”. These are the examples of bright dot defects:

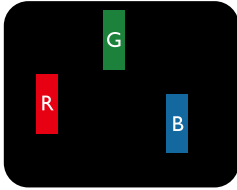

One lit red, green or blue sub pixel

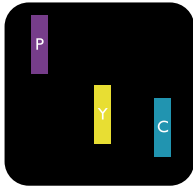

Two adjacent lit sub pixels:

Red + Blue = Purple

Red + Green = Yellow

Green + Blue = Cyan (Light Blue)

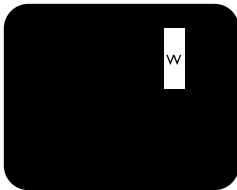

Three adjacent lit sub pixels (one white pixel)

Dark Dot Defects

Black dot defects appear as pixels or sub-pixels that are always dark or “off”. These are the examples of black dot defects:

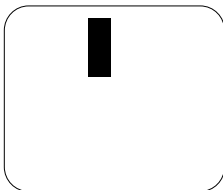

One dark dot

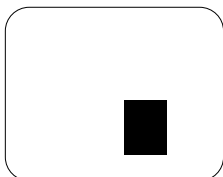

Two adjacent dark dots = 1 pair of dark dots

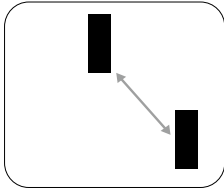

Two dark dots, specifications defines the minimum distance between dark dots

Proximity of Pixel Defects

Because pixel and sub-pixels defects of the same type that are nearby one another may be more noticeable, Benq also specifies tolerances for the proximity of pixel defects. In the table below you can find specifications about:

- Allowed amount of adjacent dark dots = (adjacent dark dots = 1 pair of dark dots)
- Minimum distance between dark dots
- Total no. of all defective dots

Pixel Defect Tolerances

In order to qualify for repair due to pixel defects during the warranty period, a PDP / TFT panel in a Benq Plasma / LCD- display must have pixel or sub-pixel defects exceeding the tolerances listed in the following table.

BRIGHT DOT EFFECT	ACCEPTABLE LEVEL
1 lit sub pixel	2
BLACK DOT EFFECT	ACCEPTABLE LEVEL
1 dark sub pixel	10
TOTAL DOT DEFECTS OF ALL TYPES	12



* 1 or 2 adjacent sub pixel defects = 1 dot defect

MURA

Dark spots or patches may occasionally appear on some liquid crystal display (LCD) panels. This is known within the industry as Mura, which is a Japanese term for “unevenness.” It is used to describe an irregular pattern or area in which uneven screen uniformity appears under certain conditions. Mura is a result of the deterioration of the liquid crystal alignment layer and is most commonly caused by long-term operation under high ambient temperatures. It is an industry- wide phenomenon and Mura is not repairable. It is also not covered by our warranty terms.

Mura has been around since the introduction of LCD technology and with screens getting bigger and in operation 24/7, many displays are running in low light conditions. This all adds to the possibility of Mura affecting displays.

HOW TO SPOT MURA

There are many symptoms of Mura and also multiple causes. Several of these are listed below:

- Impurities or foreign particles in the crystal matrix
- Uneven distribution of LCD matrix during manufacturing
- Non-uniform luminance distribution of the backlight
- Panel assembly induced stress
- Flaws within the LCD cells
- Thermal induced stress - high temperature operation over long periods of time

HOW TO AVOID MURA

Although we can not guarantee the complete eradication of Mura every time, in general the appearance of Mura can be minimized by these methods:

- Lower the backlight brightness
- Use a screen saver
- Reduce the ambient temperature around the unit

Cleaning and Troubleshooting

Cleaning

Caution When Using the Display

- Do not bring your hands, face or objects close to the ventilation holes of the display. The top of the display is usually very hot due to the high temperature of exhaust air being released through the ventilation holes. Burns or personal injuries may occur if any body parts are brought too close. Placing any object near the top of the display could also result in heat related damage to the object as well as the display itself.
- Be sure to disconnect all cables before moving the display. Moving the display with its cables attached may damage the cables and thus cause fire or electric shock.
- Disconnect the power plug from the wall outlet as a safety precaution before carrying out any type of cleaning or maintenance procedure.

Front Panel Cleaning Instructions

- The front of the display has been specially treated. Wipe the surface gently using only a cleaning cloth or a soft, lint-free cloth.
- If the surface becomes dirty, soak a soft, lint-free cloth in a mild detergent solution. Wring the cloth to remove excess liquid. Wipe the surface of the display to remove dirt. Then use a dry cloth of the same type to dry.
- Do not scratch or hit the surface of the panel with fingers or hard objects of any kind.
- Do not use volatile substances such as insert sprays, solvents and thinners.

Cabinet Cleaning Instructions

- If the cabinet becomes dirty, wipe the cabinet with a soft, dry cloth.
- If the cabinet is extremely dirty, soak a lint-free cloth in a mild detergent solution. Wring the cloth to remove as much moisture as possible. Wipe the cabinet. Use another dry cloth to wipe over until the surface is dry.
- Do not allow any water or detergent to come into contact with the surface of the display. If water or moisture gets inside the unit, operating problems, electrical and shock hazards may result.
- Do not scratch or hit the cabinet with fingers or hard objects of any kind.
- Do not use volatile substances such as insert sprays, solvents and thinners on the cabinet.
- Do not place anything made from rubber or PVC near the cabinet for any extended periods of time.

Troubleshooting

Symptom	Possible Cause	Remedy
No picture is displayed	<ol style="list-style-type: none"> 1. The power cord is disconnected. 2. The main power switch on the back of the display is not switched on. 3. The selected input has no connection. 4. The display is in standby mode. 	<ol style="list-style-type: none"> 1. Plug in the power cord. 2. Make sure the power switch is switched on. 3. Connect a signal connection to the display.
Interference displayed on the display or audible noise is heard	Caused by surrounding electrical appliances or fluorescent lights.	Move the display to another location to see if the interference is reduced.
Color is abnormal	The signal cable is not connected properly.	Make sure that the signal cable is attached firmly to the back of the display.
Picture is distorted with abnormal patterns	<ol style="list-style-type: none"> 1. The signal cable is not connected properly. 2. The input signal is beyond the capabilities of the display. 	<ol style="list-style-type: none"> 1. Make sure that the signal cable is attached firmly. 2. Check the video signal source to see if it is beyond the range of the display. Please verify its specifications with this display's specification section.
Display image doesn't fill up the full size of the screen	<ol style="list-style-type: none"> 1. The zoom mode is not set correctly. 2. Scan Mode may be set incorrectly to underscan. 3. If the image exceeds the screen size, Scan Mode may need to be set to Underscan. 	Use the Zoom mode or Custom zoom function in the Screen menu to fine tune display geometry and time frequency parameter.
Can hear sound, but no picture	Improperly connected source signal cable.	Make sure that both video inputs and sound inputs are correctly connected.
Can see picture but no sound is heard	<ol style="list-style-type: none"> 1. Improperly connected source signal cable. 2. Volume is turned all the way down. 3. Mute is turned on. 4. No external speaker connected. 	<ol style="list-style-type: none"> 1. Make sure that both video inputs and sound inputs are correctly connected. 2. Press + or - button to hear sound. 3. Switch MUTE off by using the  button. 4. Connect external speakers and adjust the volume to a suitable level.
Some picture elements do not light up	Some pixels of the display may not turn on.	This display is manufactured using an extremely high level of precision technology; however, sometimes some pixels of the display may not display. This is not a malfunction.

<p>After-Images can still be seen on the display after the display is powered off. (Examples of still pictures include logos, video games, computer images, and images displayed in 4:3 normal mode)</p>	<p>A still picture is displayed for an over extended period of time</p>	<p>Do not allow a still image to be displayed for an extended period of time as this can cause a permanent after-image to remain on the display.</p>
--	---	--

Technical Specifications

Item		Specifications		
		SL490	SL550	
Display	Screen Size (Active Area)		48.5" (123.2 cm) diagonal LCD	54.64 Inches (1387.80 mm) diagonal LCD
	Aspect Ratio		16:9	
	Number of pixels		1920 (H) x 1080 (V)	
	Pixel pitch		0.55926 (H) x 0.55926 (V) mm	0.630 (H) x 0.630 (V) mm
	Displayable colors		8bits(D), 16.7 Million colors	
	Brightness (typical)		450 cd/m ² (typ)	
	Contrast ratio (typical)		1100:1	
	Viewing angle		178 degrees	
In/Out Terminals	Speaker Output	Internal Speakers	10W (L) + 10W (R) RMS/8Ω 1 Way 1 Speaker System 82 dB / W / M / 160 Hz ~ 13 KHz	
	Audio Output	Phone Jack x 1	0.5V rms (Normal) / 2 Channel (L+R)	
	Audio Input	3.5 mm Stereo x 1	0.5V rms (Normal) / 2 Channel (L+R)	
	RS232C	2.5mm Phone jack x 2	RS232 in / RS232 out	
	RJ-45	RJ-45 Jack x 1 (8 pin)	10/100 LAN Port	
	HDMI Input	HDMI Jack x 2 (Type A) (19 pin)	Digital RGB: TMDS (Video + Audio) MAX: Video - 720p, 1080p, 1920 x 1080/60 Hz (WUXGA) Audio - 48 KHz / 2 Channel (L+R) Supports LPCM only	
	DVI-I (DVI-D & VGA) Input	DVI-I jack	Digital RGB: TMDS (Video) Analog RGB: 0.7V [p-p] (75Ω), H/CS/V: TTL (2.2kΩ), SOG: 1V [p-p] (75Ω) MAX: 720p, 1080p, 1920 x 1080/60 Hz (WUXGA)	
	DVI-I (DVI-D & VGA) Output	DVI-I Jack x 1 (29 pin)	Digital RGB: TMDS (Video) Analog RGB: 0.7V [p-p] (75Ω), H/CS/V: TTL (2.2kΩ), SOG: 1V [p-p] (75Ω) MAX: 720p, 1080p, 1920 x 1080/60 Hz (WUXGA)	
	Displayport in/out	Displayport Jack x 2 (20 pin)	Digital RGB: TMDS (Video + Audio) MAX: Video - 720p, 1080p, 1920 x 1080/60 Hz (WUXGA) Audio - 48 K-Hz / 2 Channel (L+R) Supports LPCM only	

Product Fiche	Energy Efficiency Class	A+	
	Visible Screen Size	123.2 cm / 48.5 inch	1387.80 cm / 54.64 inch
	On Mode Power Consumption (W)	65 W	77 W
	Annual Energy Consumption (kWh)	94 kWh	112 kWh
	Standby Power Consumption (W)	0.5 W	0.50 W
	Off Mode Power Consumption (W)	0.5 W	0.50 W
	Display Resolution (Pixels)	1920 x 1080p	
	Network Standby (W)	3 W	
General	Internal memory	16GB eMMC (12GB usable)	
	Power Supply	AC 100 - 240V, 50 - 60Hz	
	Power Consumption (Max)	121 W	139 W
	Power Consumption (typ.)	67 W	76 W
	Power Consumption (Standby & Off)	<0.5W (RS232 in active)	
	Dimensions (Without Stand) W x H x D	1097.6 x 633.9 x 45.5 mm	1233.4 x 710.3 x 45.5 mm
	Weight (Without Stand)	14.70 Kg	18.0 Kg
	Gross Weight (Without Stand)	19.90 Kg	24.4 Kg
Environmental Condition	Temperature	Operational	0 ~ 40°C
		Storage	-20 ~ 60°C
	Humidity	Operational	20 ~ 80% RH (No condensation)
		Storage	5 ~ 95% RH (No condensation)
	Altitude	Operational	0 ~ 3,000 m
		Storage / Shipment	0 ~ 9,000 m
Internal Speaker	Type	1 Way 1 Speaker	
	Input	10 W (RMS)	
	Impedance	8Ω	
	Output Sound Pressure	82 dB/W/M	
	Frequency Response	160 Hz ~ 13 KHz	