

# VANGUARD II 8x4H

## 8CH H.265 4K Hybrid DVR

---

### *Quick Installation Guide*



Copyright © EverFocus Electronics Corp.  
Release Date: February 2021

All the images including product pictures or screen shots in this document are for example only. The images may vary depending on the product and software version. Information contained in this document is subject to change without notice.

#### **EverFocus Taiwan:**

2F., No.12, Ln. 270, Sec. 3, Beishen Rd., Shenkeng Dist., New Taipei City 222, Taiwan

TEL: +886 2 2662 2338 FAX: +886 2 2662 3632 [www.everfocus.com.tw](http://www.everfocus.com.tw) [marketing@everfocus.com.tw](mailto:marketing@everfocus.com.tw)

---

# 1. Overview

## 1.1 Front Panel

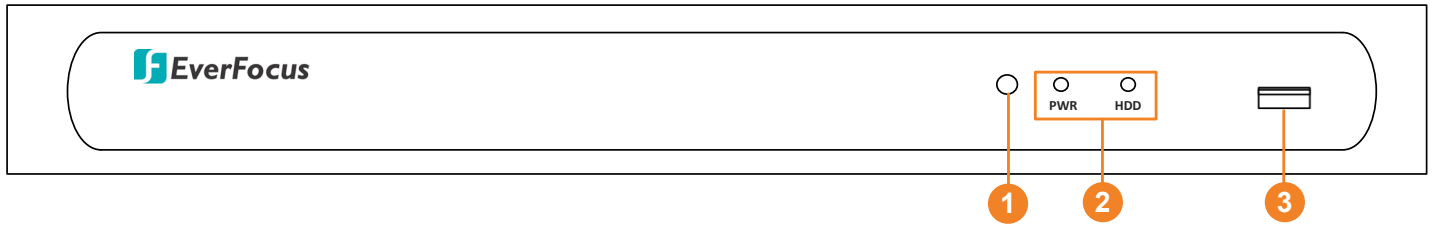

No.	Name	Description
1	<b>IR Receiver</b>	Receiver for signals from the IR remote control.
2	<b>LED Indicator</b>	<b>Power:</b> When power is on, the LED will continue lighting in green. <b>HDD:</b> When power is on, the LED will continue lighting in red. When HDD is reading/writing data, the LED will flashes red.
3	<b>USB2.0 Port</b>	USB2.0 port for connecting to a mouse or an external storage device.

## 1.2 Rear Panel

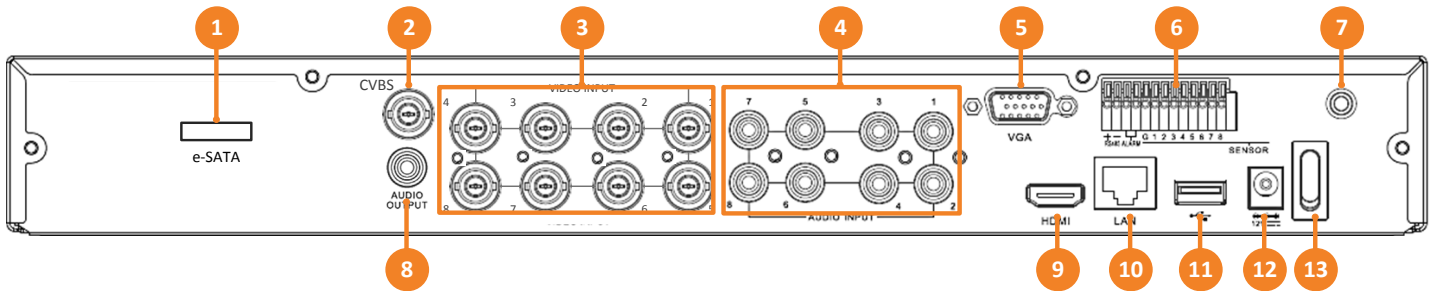

No.	Name	Description
1	<b>e-SATA</b>	Connects to an external e-SATA storage device.
2	<b>CVBS Port</b>	Connects to a monitor using a coaxial cable.
3	<b>Video Input</b>	Connects the AHD/TVI/SD cameras to the Video Input.
4	<b>Audio Input</b>	Connects to audio input devices, such as microphones. Note that the microphones with a (built-in) amplifier and external power supply are required.
5	<b>VGA Port</b>	Connects to a monitor using a VGA cable.
6	<b>Terminal Block</b>	The Terminal Block provides alarm inputs, alarm output and RS-485 connection (see 3.1 Terminal Block).
7	<b>IR Receiver Port</b>	You can optionally connect an external IR Remote Control Receiver to this port.

<b>8</b>	<b>Audio Output</b>	Connects to an audio output device, such as speakers. Note that the speakers with a (built-in) amplifier and external power supply are required.
<b>9</b>	<b>HDMI Port</b>	Connects to a monitor using a HDMI cable.
<b>10</b>	<b>LAN</b>	Connects to the Network.
<b>11</b>	<b>USB2.0 Port</b>	The USB2.0 port for connecting to a mouse or external storage device.
<b>12</b>	<b>Power Port</b>	Connects to a 12VDC power source.
<b>13</b>	<b>Power Switch</b>	Press to turn on or off the power.

### 1.3 Packing List

<ul style="list-style-type: none"> <li>• DVR x 1</li> <li>• Power Cord + Adaptor x 1</li> <li>• Mouse x 1</li> </ul>	<ul style="list-style-type: none"> <li>• HDD Screw x 8</li> <li>• Quick Installation Guide x 1</li> <li>• IR Remote Control (with 2 AAA batteries) x 1 (see Note 3)</li> </ul>
--	--

**Note:**

1. Equipment configurations and supplied accessories vary by country. Please consult your local EverFocus office or agents for more information. Please also keep the shipping carton for possible future use.
2. Contact the shipper if any items appear to have been damaged in the shipping process.
3. Risk of explosion if battery is replaced by an incorrect type. Dispose of used batteries according to the instructions.
  - a. Use only two AAA dry cell batteries.
  - b. Do not dispose of the batteries in a fire as it may explode.

### 1.4 Dimensions

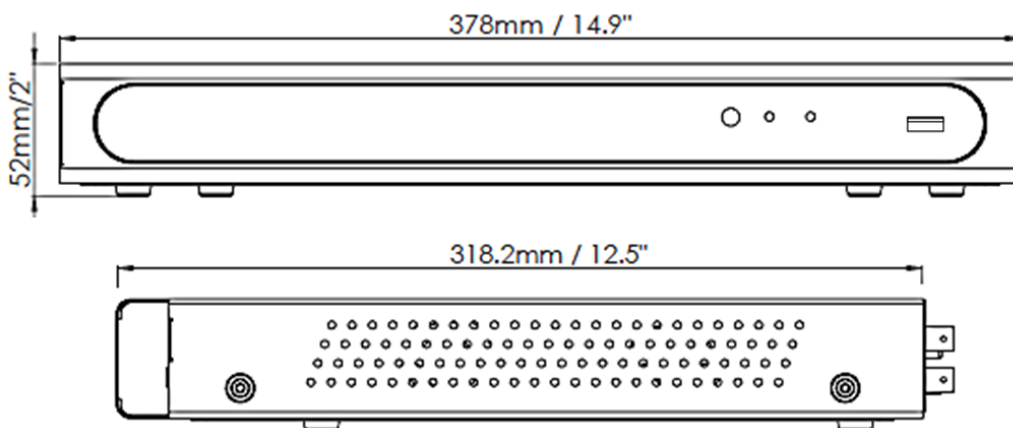

## 2. Basic Installation

### 2.1 Hard Disk Installation

You can install two 3.5" HDDs inside the DVR for recording videos. The maximum capacity of each HDD is 8TB.

1. Make sure the DVR is power-off.
2. Unscrew the eight housing screws (4 on the rear panel, 2 on the left and right side each). To remove the housing cover from the DVR, push the cover backward and then lift it.



3. Find the SATA cable and power cable inside the DVR, connect the SATA cable to the SATA port on the HDD (left image) and then connect the power cable to the HDD (right image).

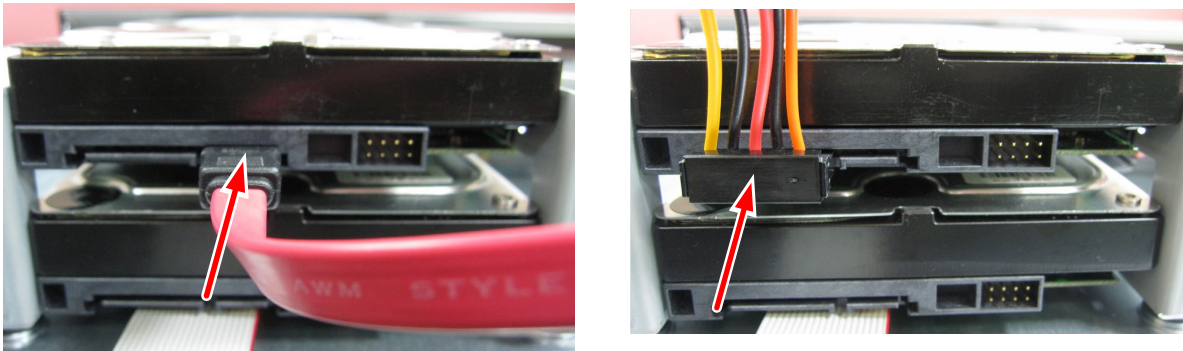

4. Place the HDDs inside the DVR, screw the HDDs from the bottom side of the DVR using the supplied Screws.

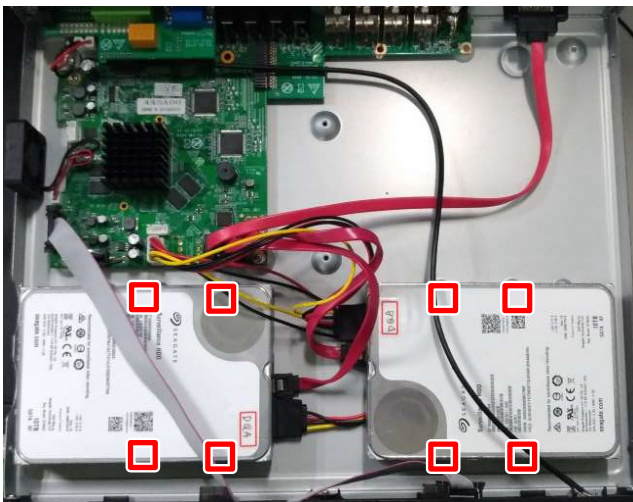

5. Screw the housing cover back to the DVR.

## 2.2 Hard Disk Compatibility List

Please go to EverFocus' Website [www.everfocus.com.tw](http://www.everfocus.com.tw), and go to Support > Product Marketing to search for and download the Storage Compatibility Table. It's recommended to use the hard disk models listed on the table to ensure your hard disks will be compatible.

**Note:** If using two or more hard disks, please choose the hard disks with the same capacity.

## 3. Basic Connection

The instructions below describe the basic connection to the DVR.

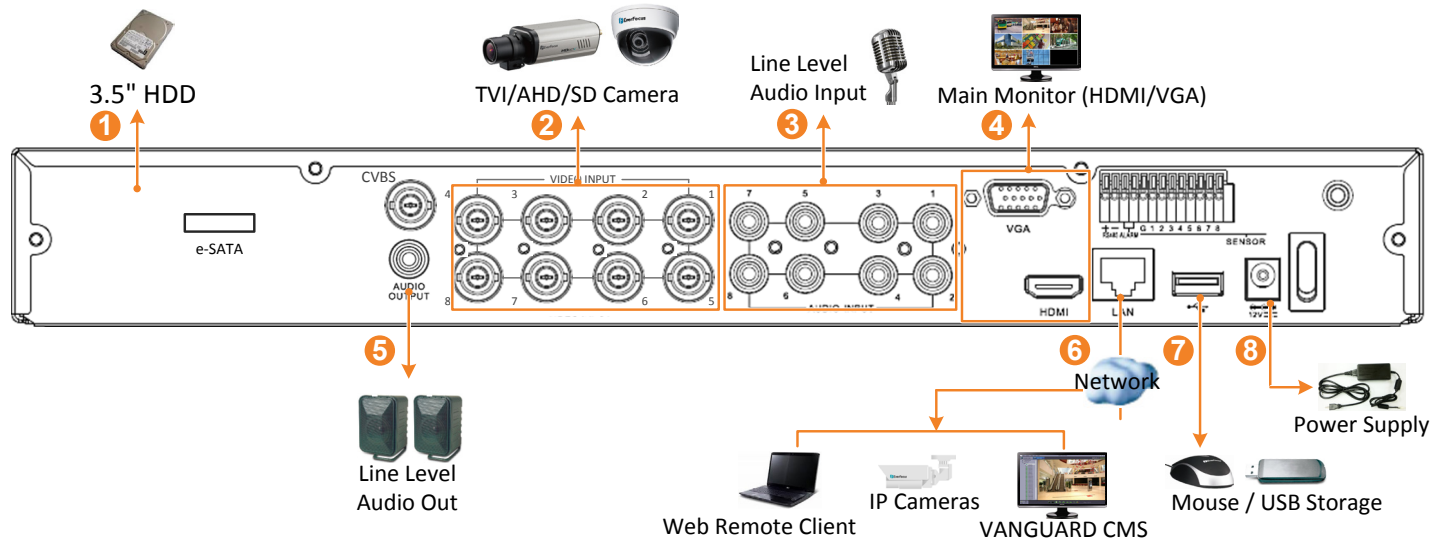

1. To record videos, install 3.5" HDD(s) to the DVR. Please refer to *2.1 Hard Disk Installation*.
2. To connect to the TVI/AHD/SD cameras, connect the cameras to the BNC ports.
3. Connect microphones to the audio input ports to transmit audio from the camera to the DVR. Note that the microphones with a (built-in) amplifier and external power supply are required.
4. To view videos at local site, connect a monitor to the HDMI or VGA port using the HDMI or VGA cable supplied by the monitor manufacturer.
5. To listen to the audio from device side, connect speakers to the audio output. Note that the speakers with a (built-in) amplifier and external power supply are required.
6. Use a standard RJ-45 CAT5 Ethernet cable to connect the DVR to the network and then optionally connect IP cameras to the DVR.
7. Optionally connect a mouse to the DVR to control the system. You can also control the system using the supplied IR Remote Control.
8. Use the supplied Power Cord and Adaptor to connect the DVR to the power outlet.

### 3.1 Terminal Block

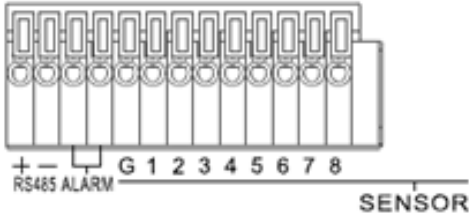

Alarm Input: 8  
Alarm Output: 1  
RS-485: 1

### 4. Turning On / Off the Power

Before powering on the DVR, please make sure the internal HDD have been installed properly. Once you have completed the basic cable connections, you are ready to turn on the DVR. Simply plug in the power source and then press the **Power Switch** on the rear panel of the DVR. The POWER LED will light up if power is normal and the DVR will enter the System Initialization process.

When the process is done, it's required to set up a password for the administrator account immediately in order to protect your privacy.

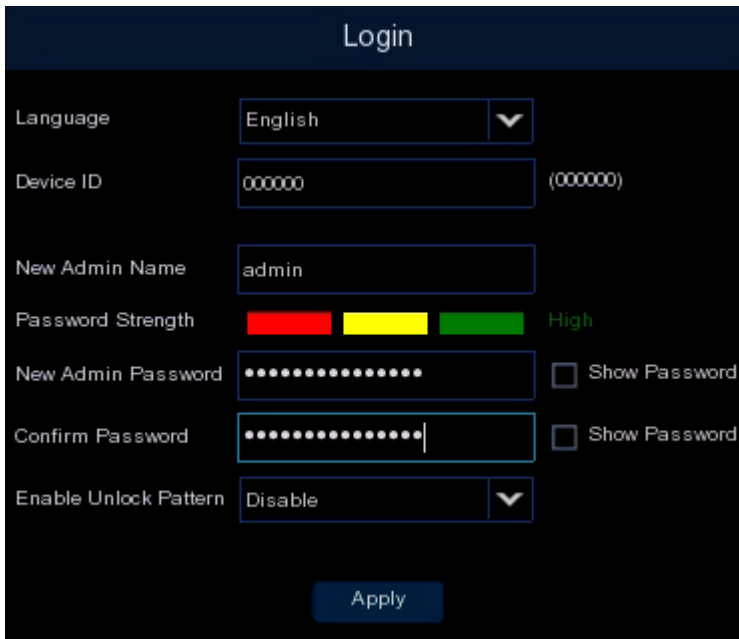

To turn off the power, click the **Shutdown** button on the Exit page (OSD menu > Exit > Shutdown) and then press the **Power Switch** on the rear panel of the DVR.

## 5. P2P Function

The **P2P** function allows users to add DVRs to EverFocus' **eFVMS App** through QR code.

1. Install **EverFocus eFVMS App**. For Android users, go to Google Play Store. For iOS users, go to Apple Store. After the installation process is complete, start **eFVMS App**.

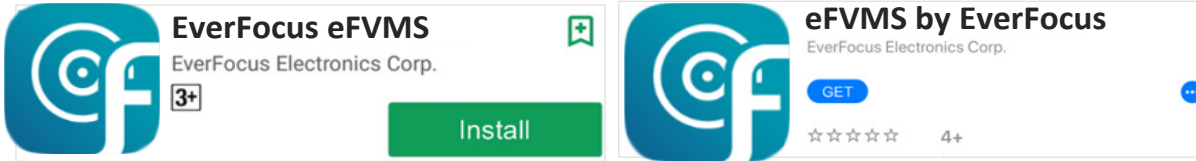

2. To add a DVR through P2P, tap **Menu > Device List**, and then tap the “+” button on the upper-right corner.

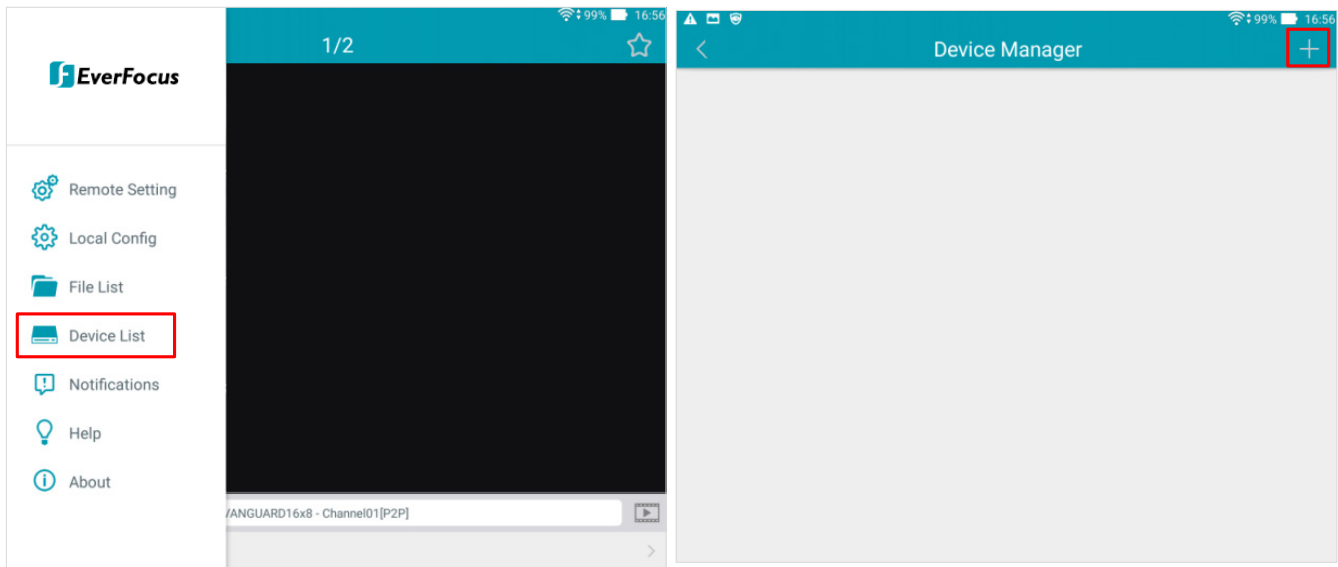

3. Scan the DVR's **QR code** on the System Info page of the DVR OSD menu. Input the DVR ID, password and Media Port 8000. Tap the **Save** button.

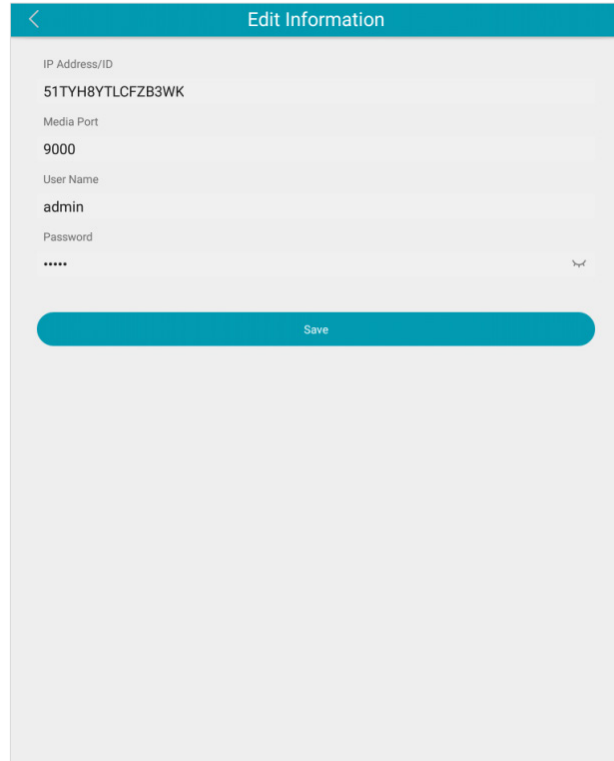
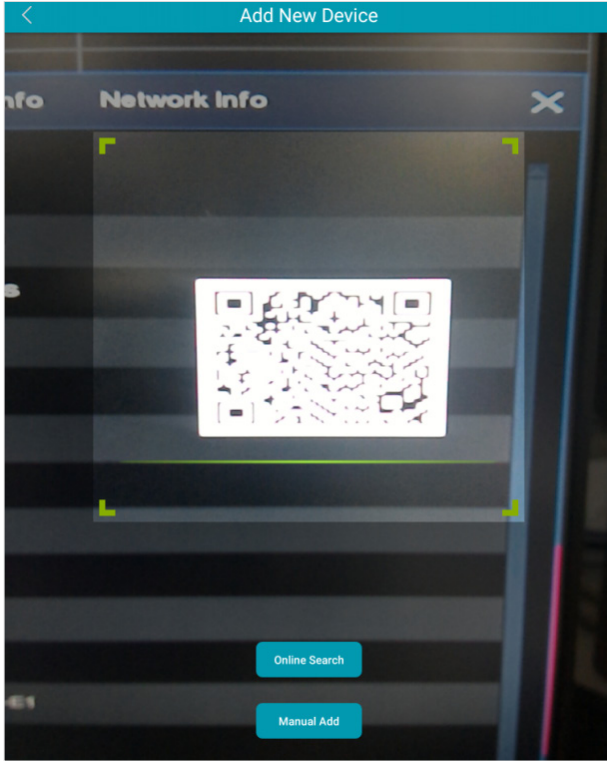

4. The DVR is now added and connected to the App. You can start accessing the DVR.

