



User Guide

SUMMARY

This guide provides information about components, network connection, power management, security, backing up, and more.

© Copyright 2021 HP Development Company, L.P.

Bluetooth is a trademark owned by its proprietor and used by HP Inc. under license. Intel, Celeron, Pentium, and Thunderbolt are trademarks of Intel Corporation or its subsidiaries in the U.S. and/or other countries. Windows is either a registered trademark or trademark of Microsoft Corporation in the United States and/or other countries. TILE and the TILE design are trademarks of Tile, Inc. USB Type-C® and USB-C® are registered trademarks of USB Implementers Forum. DisplayPort™ and the DisplayPort™ logo are trademarks owned by the Video Electronics Standards Association (VESA®) in the United States and other countries. Miracast® is a registered trademark of Wi-Fi Alliance.

The information contained herein is subject to change without notice. The only warranties for HP products and services are set forth in the express warranty statements accompanying such products and services. Nothing herein should be construed as constituting an additional warranty. HP shall not be liable for technical or editorial errors or omissions contained herein.

First Edition: January 2021

Document Part Number: M35253-001

Product notice

This user guide describes features that are common to most models. Some features might not be available on your computer.

Not all features are available in all editions or versions of Windows. Systems might require upgraded and/or separately purchased hardware, drivers, software or BIOS update to take full advantage of Windows functionality. Windows 10 is automatically updated, which is always enabled. ISP fees might apply and additional requirements might apply over time for updates. See <http://www.microsoft.com>.

To access the latest user guides, go to <http://www.hp.com/support>, and follow the instructions to find your product. Then select **Manuals**.

Software terms

By installing, copying, downloading, or otherwise using any software product preinstalled on this computer, you agree to be bound by the terms of the HP End User License Agreement (EULA). If you do not accept these license terms, your sole remedy is to return the entire unused product (hardware and software) within 14 days for a full refund subject to the refund policy of your seller.

For any further information or to request a full refund of the price of the computer, please contact your seller.

Safety warning notice

Reduce the possibility of heat-related injuries or of overheating the computer by following the practices described.

 **WARNING!** To reduce the possibility of heat-related injuries or of overheating the computer, do not place the computer directly on your lap or obstruct the computer air vents. Use the computer only on a hard, flat surface. Do not allow another hard surface, such as an adjoining optional printer, or a soft surface, such as pillows or rugs or clothing, to block airflow. Also, do not allow the AC adapter to come into contact with the skin or a soft surface, such as pillows or rugs or clothing, during operation. The computer and the AC adapter comply with the user-accessible surface temperature limits defined by applicable safety standards.

Processor configuration setting (select products only)

Important information about processor configurations.



IMPORTANT: Select computer products are configured with an Intel® Pentium® N35xx/N37xx series or a Celeron® N28xx/N29xx/N30xx/N31xx series processor and a Windows® operating system. **If your computer is configured as described, do not change the processor configuration setting in msconfig.exe from 4 or 2 processors to 1 processor.** If you do so, your computer will not restart. You will have to perform a factory reset to restore the original settings.

Table of contents

1 Getting started	1
Finding information	1
2 Components	3
Locating hardware	3
Locating software	3
Right	3
Left	4
Display	5
Keyboard area	7
Touchpad	7
Touchpad settings	7
Adjusting touchpad settings	7
Turning on the touchpad	7
Touchpad components	7
Lights	8
Speakers and fingerprint reader	9
Special keys	10
Action keys	10
Hot keys (select products only)	12
Top cover	12
Bottom	13
Rear	13
Labels	14
Using a SIM card (select products only)	15
Determining the correct SIM card size for your computer	16
Inserting a nano SIM card	16
Using Tile (select products only)	16
3 Network connections	18
Connecting to a wireless network	18
Using the wireless controls	18
Wireless button	18
Operating system controls	18
Connecting to a WLAN	19
Using HP Mobile Broadband (select products only)	19

Using eSIM (select products only)	20
Using GPS (select products only)	20
Using Bluetooth wireless devices (select products only)	20
Connecting Bluetooth devices	20
Using NFC to share information (select products only)	21
Connecting to a wired network	21
Connecting to a local area network (LAN) (select products only)	21
Using HP LAN-Wireless Protection (select products only)	22
Using HP MAC Address Pass Through (select products only)	23
4 Navigating the screen	24
Using touchpad and touch screen gestures	24
Tap	24
Two-finger pinch zoom	24
Two-finger slide (touchpad and precision touchpad)	25
Two-finger tap (touchpad and precision touchpad)	25
Three-finger tap (touchpad and precision touchpad)	25
Four-finger tap (touchpad and precision touchpad)	26
Three-finger swipe (touchpad and precision touchpad)	26
Four-finger swipe (precision touchpad)	26
One-finger slide (touch screen)	27
Using an optional keyboard or mouse	27
Using an on-screen keyboard (select products only)	27
5 Entertainment features	28
Using a camera (select products only)	28
Using audio	28
Connecting speakers	28
Connecting headphones	28
Connecting headsets	29
Using sound settings	29
Viewing or changing sound settings	29
Using the control panel to view and control audio settings	29
Using video	29
Connecting a Thunderbolt device using a USB Type-C cable	30
Connecting video devices using an HDMI cable (select products only)	30
Connecting a high-definition TV or monitor using HDMI	30
Setting up HDMI audio	31
Turning on HDMI audio	31
Turning off HDMI audio	31
Discovering and connecting wired displays using MultiStream Transport	32

Connecting displays to computers with Intel graphics (with an optional hub)	32
Connecting displays to computers with Intel graphics (with a built-in hub)	32
Discovering and connecting to Miracast-compatible wireless displays (select products only)	33
Discovering and connecting to Intel WiDi certified displays (select Intel products only)	33
Connecting to Intel WiDi certified displays	33
Opening Intel WiDi	33
Using data transfer	33
Connecting devices to a USB Type-C port (select products only)	33
6 Managing power	35
Using Sleep and Hibernation	35
Initiating and exiting Sleep	35
Initiating and exiting Hibernation (select products only)	36
Shutting down (turning off) the computer	36
Using the Power icon and Power Options	37
Running on battery power	37
Using HP Fast Charge (select products only)	37
Displaying battery charge	37
Finding battery information in HP Support Assistant (select products only)	37
Conserving battery power	38
Identifying low battery levels	38
Resolving a low battery level	38
Resolving a low battery level when external power is available	38
Resolving a low battery level when no power source is available	39
Resolving a low battery level when the computer cannot exit Hibernation	39
Factory-sealed battery	39
Running on external power	39
7 Security	41
Protecting the computer	41
Using passwords	42
Setting passwords in Windows	42
Setting passwords in Computer Setup	42
Managing a BIOS administrator password	43
Setting a new BIOS administrator password	43
Changing a BIOS administrator password	43
Deleting a BIOS administrator password	44
Entering a BIOS administrator password	45
Using DriveLock Security Options	45
Selecting Automatic DriveLock (select products only)	45
Enabling Automatic DriveLock	45



Disabling Automatic DriveLock	46
Entering an Automatic DriveLock password	46
Selecting manual DriveLock	46
Setting a DriveLock master password	47
Enabling DriveLock and setting a DriveLock user password	47
Disabling DriveLock	48
Entering a DriveLock password	48
Changing a DriveLock password	48
Windows Hello (select products only)	49
Using antivirus software	49
Using firewall software	50
Installing software updates	50
Using HP Client Security (select products only)	50
Using HP Device as a Service (select products only)	50
Using an optional security cable (select products only)	51
Using a fingerprint reader (select products only)	51
8 Maintenance	52
Improving performance	52
Using Disk Defragmenter	52
Using Disk Cleanup	52
Using HP 3D DriveGuard (select products only)	52
Identifying HP 3D DriveGuard status	53
Updating programs and drivers	53
Cleaning your computer	53
Enabling HP Easy Clean (select products only)	53
Removing dirt and debris from your computer	53
Cleaning your computer with a disinfectant	54
Caring for wood veneer (select products only)	55
Traveling with or shipping your computer	55
9 Backing up, restoring, and recovering	57
Backing up information and creating recovery media	57
Using Windows tools for backing up	57
Using the HP Cloud Recovery Download Tool to create recovery media (select products only)	57
Restoring and recovering your system	57
Creating a system restore	58
Restoring and recovery methods	58
Recovering using HP Recovery media	58
Changing the computer boot order	58
Using HP Sure Recover (select products only)	59

10 Computer Setup (BIOS), TPM, and HP Sure Start	60
Using Computer Setup	60
Navigating and selecting in Computer Setup	60
Restoring factory settings in Computer Setup	60
Updating the BIOS	61
Determining the BIOS version	61
Preparing for a BIOS update	61
Downloading a BIOS update	61
Installing a BIOS update	62
Changing the boot order using the f9 prompt	62
TPM BIOS settings (select products only)	62
Using HP Sure Start (select products only)	63
11 Using HP PC Hardware Diagnostics	64
Using HP PC Hardware Diagnostics Windows (select products only)	64
Using an HP PC Hardware Diagnostics Windows hardware failure ID code	64
Accessing HP PC Hardware Diagnostics Windows	64
Accessing HP PC Hardware Diagnostics Windows from HP Help and Support	64
Accessing HP PC Hardware Diagnostics Windows from Support Assistant	65
Downloading HP PC Hardware Diagnostics Windows	65
Downloading the latest HP PC Hardware Diagnostics Windows version from HP	65
Downloading the HP PC Hardware Diagnostics Windows from the Microsoft Store	65
Downloading HP Hardware Diagnostics Windows by product name or number (select products only)	65
Installing HP PC Hardware Diagnostics Windows	66
Using HP PC Hardware Diagnostics UEFI	66
Using an HP PC Hardware Diagnostics UEFI hardware failure ID code	66
Starting HP PC Hardware Diagnostics UEFI	66
Downloading HP PC Hardware Diagnostics UEFI to a USB flash drive	67
Downloading the latest HP PC Hardware Diagnostics UEFI version	67
Downloading HP PC Hardware Diagnostics UEFI by product name or number (select products only)	67
Using Remote HP PC Hardware Diagnostics UEFI settings (select products only)	67
Downloading Remote HP PC Hardware Diagnostics UEFI	68
Downloading the latest Remote HP PC Hardware Diagnostics UEFI version	68
Downloading Remote HP PC Hardware Diagnostics UEFI by product name or number	68
Customizing Remote HP PC Hardware Diagnostics UEFI settings	68

12 Specifications	69
Input power	69
Operating environment	70
13 Electrostatic discharge	71
14 Accessibility	72
HP and accessibility	72
Finding the technology tools you need	72
The HP commitment	72
International Association of Accessibility Professionals (IAAP)	73
Finding the best assistive technology	73
Assessing your needs	73
Accessibility for HP products	73
Standards and legislation	74
Standards	74
Mandate 376 – EN 301 549	74
Web Content Accessibility Guidelines (WCAG)	74
Legislation and regulations	75
Useful accessibility resources and links	75
Organizations	75
Educational institutions	75
Other disability resources	76
HP links	76
Contacting support	76
Index	77

1 Getting started

This computer is a powerful tool designed to enhance your work and entertainment. Read this chapter to learn about best practices after you set up your computer and where to find additional HP resources.

 **TIP:** To quickly return to the computer Start screen from an open app or the Windows desktop, press the Windows key  on your keyboard. Pressing the Windows key again returns you to the previous screen.

After you set up and register the computer, HP recommends the following steps to get the most out of your smart investment:

- **Connect to the internet**—Set up your wired or wireless network so that you can connect to the internet. For more information, see [Network connections on page 18](#).
- **Update your antivirus software**—Protect your computer from damage caused by viruses. The software is preinstalled on the computer. For more information, see [Using antivirus software on page 49](#).
- **Get to know your computer**—Learn about your computer features. See [Components on page 3](#) and [Navigating the screen on page 24](#) for additional information.
- **Find installed software**—Access a list of the software preinstalled on the computer:
Select the **Start** button.
– or –
Right-click the **Start** button, and then select **Apps and Features**.
- **Back up your hard drive**—Create recovery discs or a recovery USB flash drive to back up your hard drive. See [Backing up, restoring, and recovering on page 57](#).
- **Access HP Support Assistant app**—For quick online support, open the HP Support Assistant app (select products only). HP Support Assistant optimizes computer performance and resolves problems using the latest software updates, diagnostic tools, and guided assistance. Type `support` in the taskbar search box, and then select **HP Support Assistant**. Then select **Support**.

Finding information

To locate resources that provide product details, how-to information, and more, use this table.

Table 1-1 Additional information

Resource	Contents
<i>Setup Instructions</i>	<ul style="list-style-type: none">• Overview of computer setup and features
HP support	<ul style="list-style-type: none">• Online chat with an HP technician
For HP support, go to http://www.hp.com/support , and follow the instructions to find your product.	<ul style="list-style-type: none">• Support telephone numbers• Replacement parts videos (select products only)
– or –	<ul style="list-style-type: none">• Maintenance and service guides
Type <code>support</code> in the taskbar search box, and then select HP Support Assistant . Then select Support .	<ul style="list-style-type: none">• HP service center locations
– or –	

Table 1-1 Additional information (continued)

Resource	Contents
Select the question mark icon in the taskbar search box. Then select Support .	
<i>Safety & Comfort Guide</i>	<ul style="list-style-type: none">• Proper workstation setup• Guidelines for posture and work habits that increase your comfort and decrease your risk of injury• Electrical and mechanical safety information
To access this guide: ▲ Type HP Documentation in the taskbar search box, and then select HP Documentation . – or – ▲ Go to http://www.hp.com/ergo . IMPORTANT: You must be connected to the internet to access the latest version of the user guide.	
<i>Regulatory, Safety, and Environmental Notices</i>	<ul style="list-style-type: none">• Important regulatory notices, including information about proper battery disposal, if needed.
To access this document: ▲ Type HP Documentation in the taskbar search box, and then select HP Documentation .	
<i>Limited Warranty*</i>	<ul style="list-style-type: none">• Specific warranty information about this computer
To access this document: ▲ Type HP Documentation in the taskbar search box, and then select HP Documentation . – or – ▲ Go to http://www.hp.com/go/orderdocuments . IMPORTANT: You must be connected to the internet to access the latest version of the user guide.	
<p>*You can find your HP Limited Warranty located with the user guides on your product and/or on the CD or DVD provided in the box. In some countries or regions, HP might provide a printed warranty in the box. For countries or regions where the warranty is not provided in printed format, you can request a copy from http://www.hp.com/go/orderdocuments. For products purchased in Asia Pacific, you can write to HP at POD, PO Box 161, Kitchener Road Post Office, Singapore 912006. Include your product name, and your name, phone number, and postal address.</p>	

2 Components

Your computer features top-rated components. This chapter provides details about your components, where they are located, and how they work.

Locating hardware

Use these instructions to find out what hardware is installed on your computer.

- ▲ Type `device manager` in the taskbar search box, and then select the **Device Manager** app.

A list displays all the devices installed on your computer.

For information about system hardware components and the system BIOS version number, press `fn+esc` (select products only).

Locating software

Use these instructions to find out what software is installed on your computer:

- ▲ Right-click the **Start** button, and then select **Apps and Features**.

Right

Use the illustration and table to identify the components on the right side of the computer.

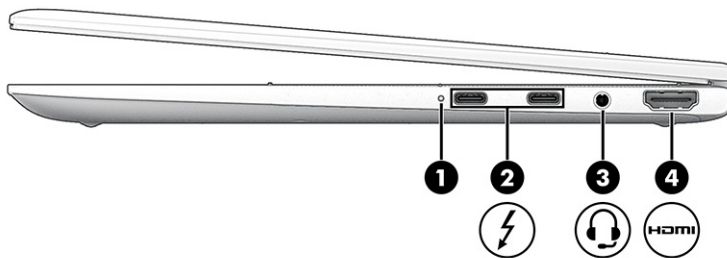





Table 2-1 Right-side components and their descriptions

Component	Description
(1) Battery light	<p>When AC power is connected:</p> <ul style="list-style-type: none">• White: The battery charge is greater than 90 percent.• Amber: The battery charge is from 0 to 90 percent.• Off: The battery is not charging. <p>When AC power is disconnected (battery not charging):</p> <ul style="list-style-type: none">• Blinking amber: The battery has reached a low battery level. When the battery has reached a critical battery level, the battery light begins blinking rapidly.• Off: The battery is not charging.

Table 2-1 Right-side components and their descriptions (continued)

Component	Description
<p>(2)  USB Type-C® power connectors and Thunderbolt™ ports with HP Sleep and Charge (2)</p>	<p>Connect an AC adapter that has a USB Type-C connector, supplying power to the computer and, if needed, charging the computer battery.</p> <p>– and –</p> <p>Connect a USB device, provide high-speed data transfer, and charge small devices, even when the computer is off.</p> <p>– and –</p> <p>Connect a display device that has a USB Type-C connector, providing DisplayPort™ output.</p> <p>NOTE: Your computer might also support a Thunderbolt docking station.</p> <p>NOTE: Cables, adapters, or both (purchased separately) might be required.</p>
<p>(3)  Audio-out (headphone)/Audio-in (microphone) combo jack</p>	<p>Connects optional powered stereo speakers, headphones, earbuds, a headset, or a television audio cable. Also connects an optional headset microphone. This jack does not support optional standalone microphones.</p> <p>WARNING! To reduce the risk of personal injury, adjust the volume before putting on headphones, earbuds, or a headset. For additional safety information, see the <i>Regulatory, Safety, and Environmental Notices</i>.</p> <p>To access this guide:</p> <ul style="list-style-type: none"> ▲ Type HP Documentation in the taskbar search box, and then select HP Documentation. <p>NOTE: When a device is connected to the jack, the computer speakers are disabled.</p>
<p>(4)  HDMI port</p>	<p>Connects an optional video or audio device, such as a high-definition television, any compatible digital or audio component, or a high-speed High Definition Multimedia Interface (HDMI) device.</p>

Left

Use the illustration and table to identify the components on the left side of the computer.

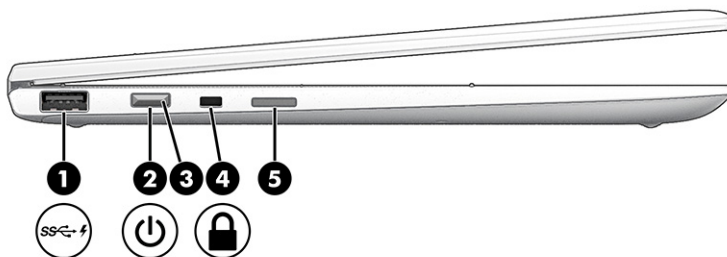





Table 2-2 Left-side components and their descriptions

Component	Description
(1)  USB SuperSpeed port with HP Sleep and Charge	Connects a USB device, provides high-speed data transfer, and charges small devices, even when the computer is off.
(2)  Power button	<ul style="list-style-type: none"> • When the computer is off, press the button briefly to turn on the computer. • When the computer is on, press the button briefly to initiate Sleep. • When the computer is in the Sleep state, press the button briefly to exit Sleep (select products only). • When the computer is in Hibernation, press the button briefly to exit Hibernation. <p>IMPORTANT: Pressing and holding down the power button results in the loss of unsaved information.</p> <p>If the computer has stopped responding and shutdown procedures are ineffective, press and hold the power button for at least 4 seconds to turn off the computer.</p> <p>To learn more about your power settings, see your power options.</p> <p>▲ Right-click the Power meter icon  and then select Power Options.</p>
(3) Power light	<ul style="list-style-type: none"> • On: The computer is on. • Blinking (select products only): The computer is in the Sleep state, a power-saving state. The computer shuts off power to the display and other unnecessary components. • Off: Depending on your computer model, the computer is off, in Hibernation, or in Sleep. Hibernation is the power-saving state that uses the least amount of power.
(4)  Security cable slot	<p>Attaches an optional security cable to the computer.</p> <p>NOTE: The security cable is designed to act as a deterrent, but it might not prevent the computer from being mishandled or stolen.</p>
(5) Nano SIM card slot (select products only)	Supports a wireless subscriber identity module (SIM) card.

Display

Use the illustration and table to identify the display components.

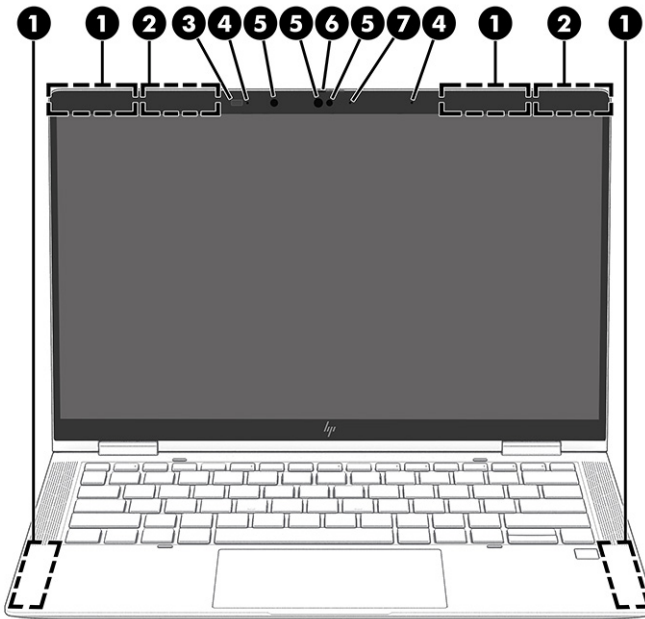

Table 2-3 Display components and their descriptions

Component	Description
(1) WWAN antennas (select products only)*	Send and receive wireless signals to communicate with wireless wide area networks (WWANs).
(2) WLAN antennas*	Send and receive wireless signals to communicate with wireless local area networks (WLANs).
(3) Ambient light sensors (2)	Adjust the brightness of the display, depending on the ambient light.
(4) Internal microphones (2)	Record sound.
(5) Camera(s)	Allow(s) you to video chat, record video, and record still images. To use your camera, see Using a camera (select products only) on page 28 . Some cameras also allow a facial recognition logon to Windows, instead of a password logon. For more information, see Windows Hello (select products only) on page 49 . NOTE: Camera functions vary depending on the camera hardware and software installed on your product.
(6) Camera privacy cover	By default, the camera lens is uncovered, but you can slide the camera privacy cover to block the camera's view. To use the camera, slide the camera privacy cover in the opposite direction to reveal the lens. NOTE: If you have both front-facing and rear-facing cameras, when one camera lens is revealed and ready to use, the other is concealed.
(7) Camera light	On: The camera is in use.

*The antennas are not visible from the outside of the computer. For optimal transmission, keep the areas immediately around the antennas free from obstructions.

For wireless regulatory notices, see the section of the *Regulatory, Safety, and Environmental Notices* that applies to your country or region.

To access this guide:

- ▲ Type `HP Documentation` in the taskbar search box, and then select **HP Documentation**.

Keyboard area

Keyboards can vary by language.

Touchpad

The touchpad settings and components are described here.

Touchpad settings

You learn how to adjust the touchpad settings and components here.

Adjusting touchpad settings

Use these steps to adjust touchpad settings and gestures.

1. Type `touchpad settings` in the taskbar search box, and then press [enter](#).
2. Choose a setting.

Turning on the touchpad

Follow these steps to turn on the touchpad.

1. Type `touchpad settings` in the taskbar search box, and then press [enter](#).
2. Using an external mouse, click the **Touchpad** button.

If you are not using an external mouse, press the [Tab](#) key repeatedly until the pointer rests on the **touchpad** button. Then press the [spacebar](#) to select the button.

Touchpad components

Use the illustration and table to identify the touchpad components.

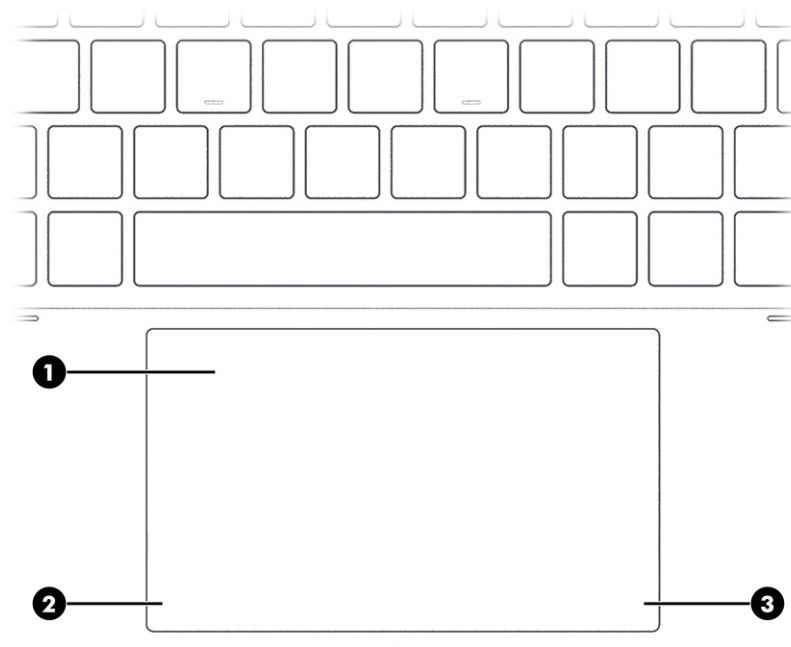
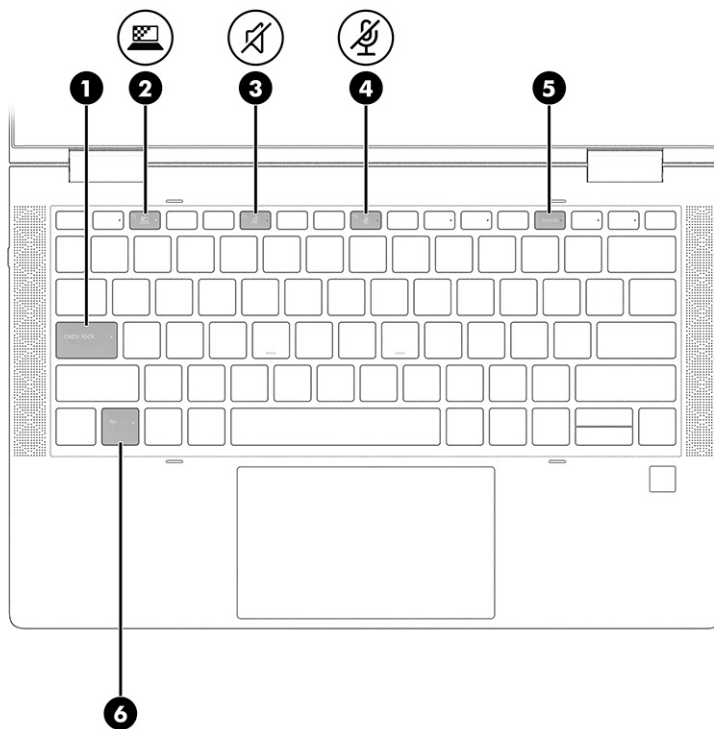

Table 2-4 Touchpad components and their descriptions

Component	Description
(1) Touchpad zone	Reads your finger gestures to move the pointer or activate items on the screen. NOTE: For more information, see Using touchpad and touch screen gestures on page 24 .
(2) Left touchpad button	Functions like the left button on an external mouse.
(3) Right touchpad button	Functions like the right button on an external mouse.

Lights

Use the illustration and table to identify the lights on the computer.

**Table 2-5 Lights and their descriptions**



Component	Description
(1) Caps lock light	On: Caps lock is on, which switches the key input to all capital letters.
(2)  Privacy key light	On: Privacy screen is on, which helps prevent side-angle viewing.
(3)  Mute light	<ul style="list-style-type: none"> On: Computer sound is off. Off: Computer sound is on.
(4)  Microphone mute light	<ul style="list-style-type: none"> On: Microphone is off. Off: Microphone is on.

Table 2-5 Lights and their descriptions (continued)

Component	Description
(5) Num Lk light numlk	On: Num Lk is on.
(6) Fn lock light	On: The fn key is locked. For more information, see Hot keys (select products only) on page 12 .

Speakers and fingerprint reader

Fingerprint readers can be located on the touchpad, on a side panel of the computer, or on the top cover below the keyboard.

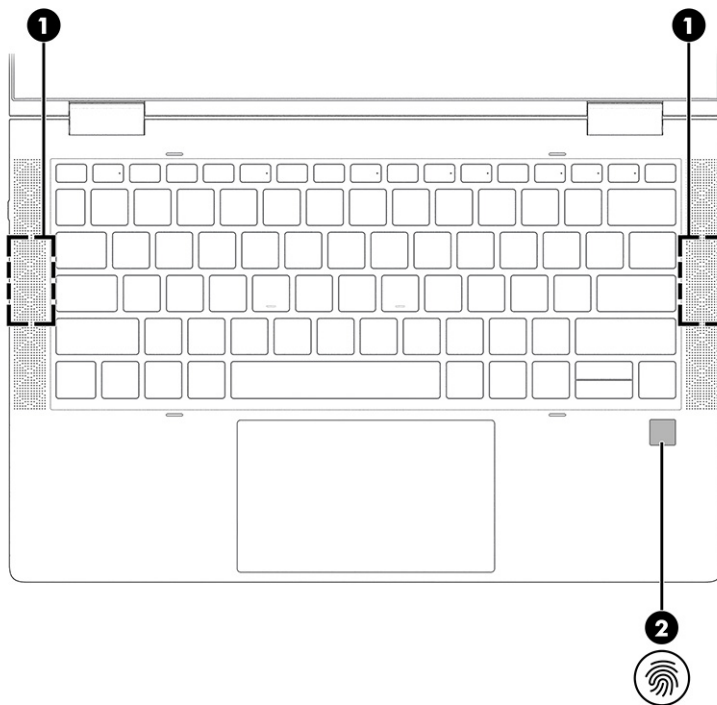



Table 2-6 Speakers and fingerprint reader and their descriptions

Component	Description
(1) Speakers (2)	Produce sound.
(2)  Fingerprint reader	Allows a fingerprint logon to Windows, instead of a password logon. ▲ Touch your finger to the fingerprint reader. See Windows Hello (select products only) on page 49 for details. IMPORTANT: To prevent fingerprint logon issues, make sure when you register your fingerprint that all sides of your finger are registered by the fingerprint reader.

Special keys

Use the illustration and table to identify the special keys.

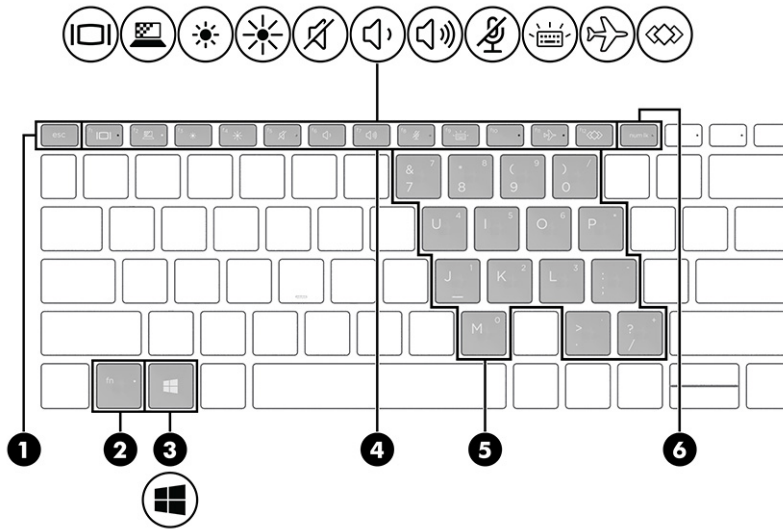



Table 2-7 Special keys and their descriptions

Component	Description
(1) <code>esc</code> key	Displays system information when pressed in combination with the <code>fn</code> key.
(2) <code>fn</code> key	Executes frequently used system functions when pressed in combination with another key. Such key combinations are called <i>hot keys</i> . See Hot keys (select products only) on page 12 .
(3)  Windows key	Opens the Start menu. NOTE: Pressing the Windows key again will close the Start menu.
(4) Action keys	Execute frequently used system functions. See Action keys on page 10 .
(5) Embedded numeric keypad	A numeric keypad superimposed over the keyboard alphabet keys. When <code>num lk</code> is pressed, the keypad can be used like an external numeric keypad. Each key on the keypad performs the function indicated by the icon in the upper-right corner of the key. NOTE: If the keypad function is active when the computer is turned off, that function is reinstated when the computer is turned back on.
(6) <code>num lk</code> key	Turns the embedded numeric keypad on and off.

Action keys

Action keys perform specific functions and vary by computer. To determine which keys are on your computer, look at the icons on your keyboard and match them to the descriptions in this table.

- ▲ To use an action key, press and hold the key.

 **NOTE:** On some products, you must press the **fn** key in combination with the action key.

Table 2-8 Action keys and their descriptions











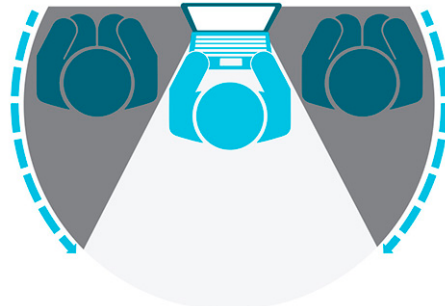

Icon	Description
	Switches the screen image among display devices connected to the system. For example, if a monitor is connected to the computer, repeatedly pressing the key alternates the screen image from computer display to monitor display to simultaneous display on both the computer and the monitor.
	Helps prevent side-angle viewing from onlookers. If needed, decrease or increase brightness for well-lit or darker environments. Press the key again to turn off the privacy screen. NOTE: To quickly turn on the highest privacy setting, press fn+p .
	
	Decreases the screen brightness incrementally as long as you hold down the key.
	Increases the screen brightness incrementally as long as you hold down the key.
	Mutes or restores speaker sound.
	Decreases speaker volume incrementally while you hold down the key.
	Increases speaker volume incrementally while you hold down the key.
	Mutes the microphone.
	Turns the keyboard backlight off or on. On select products, you can adjust the brightness of the keyboard backlight. Press the key repeatedly to adjust the brightness from high (when you first start up the computer), to low, to off. After you adjust the keyboard backlight setting, the backlight will revert to your previous setting each time you turn on the computer. The keyboard backlight will turn off after 30 seconds of inactivity. To turn the keyboard backlight back on, press any key or tap the touchpad (select products only). To conserve battery power, turn off this feature.
	Turns the wireless feature on or off. NOTE: A wireless network must be set up before a wireless connection is possible.
	Executes frequently used tasks. Some tasks might not be available on all products. <ul style="list-style-type: none">• Opens an application, file, or website• Enter frequently used text into a permanent clipboard

Table 2-8 Action keys and their descriptions (continued)

Icon	Description
	<ul style="list-style-type: none">• Ability to change system profiles• Ability to change system properties• Execute user-defined key sequences

 **NOTE:** The action key feature is enabled at the factory. You can disable this feature by pressing and holding the **fn** key and the left **shift** key. The **fn** lock light will turn on. After you have disabled the action key feature, you can still perform each function by pressing the **fn** key in combination with the appropriate action key.

Hot keys (select products only)

A hot key is the combination of the **fn** key and another key. Use the table to identify the hot keys.

To use a hot key:

- ▲ Press the **fn** key, and then press one of the keys listed in the following table.

Table 2-9 Hot keys and their descriptions

Key	Description
C	Turns on scroll lock.
E	Turns on the insert function.
R	Breaks the operation.
S	Sends a programming query.
W	Pauses the operation.

Top cover

Use the illustration and table to identify the top cover components.

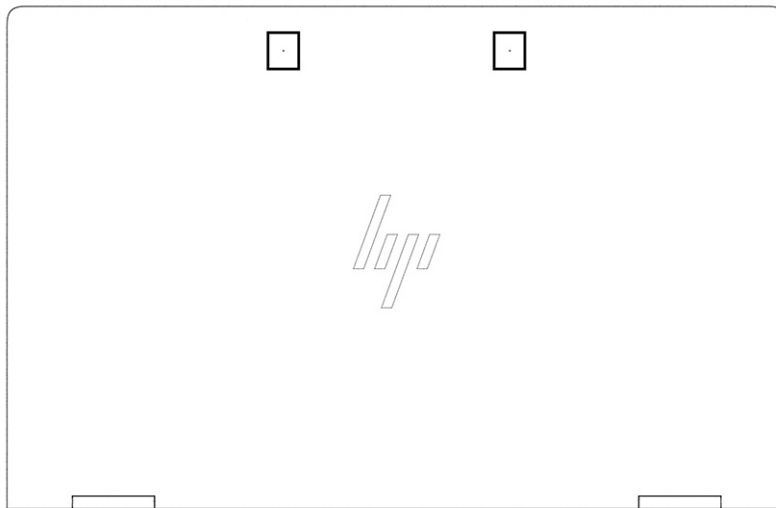

Table 2-10 Top cover component and its description

Component	Description
Internal microphones (2)	Record sound.

Bottom

Use the illustration and table to identify the bottom components.

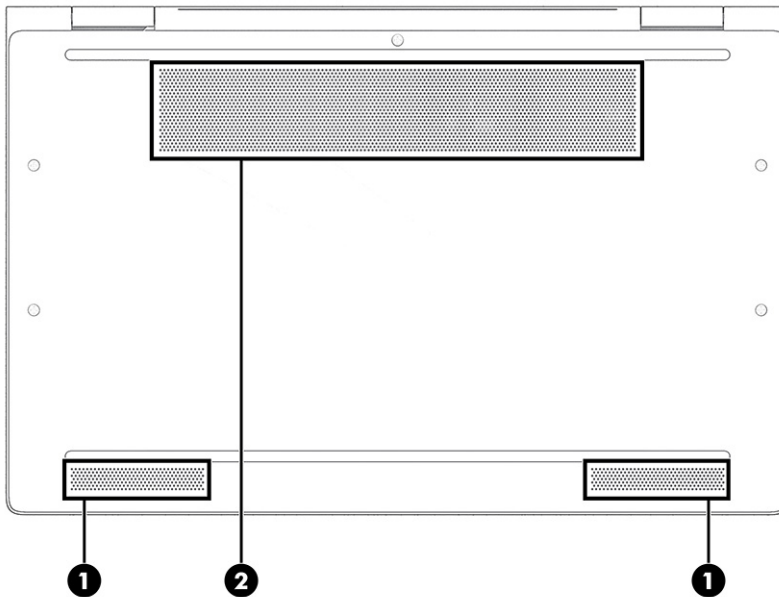

Table 2-11 Bottom components and their descriptions

Component	Description
(1) Speakers (2)	Produce sound.
(2) Vent	Enables airflow to cool internal components. NOTE: The computer fan starts up automatically to cool internal components and prevent overheating. It is normal for the internal fan to cycle on and off during routine operation.

Rear

Use the illustration and table to identify the rear component.



Table 2-12 Rear components and its description

Component	Description
Vent	Enables airflow to cool internal components.

Table 2-12 Rear components and its description

Component	Description
	NOTE: The computer fan starts up automatically to cool internal components and prevent overheating. It is normal for the internal fan to cycle on and off during routine operation.

Labels

The labels affixed to the computer provide information you might need when you troubleshoot system problems or travel internationally with the computer. Labels might be in paper form or imprinted on the product.

IMPORTANT: Check the following locations for the labels described in this section: the bottom of the computer, inside the battery bay, under the service door, on the back of the display, or on the bottom of a tablet kickstand.

- Service label—Provides important information to identify your computer. When contacting support, you might be asked for the serial number, the product number, or the model number. Locate this information before you contact support.

Your service label will resemble one of these examples. Refer to the illustration that most closely matches the service label on your computer.

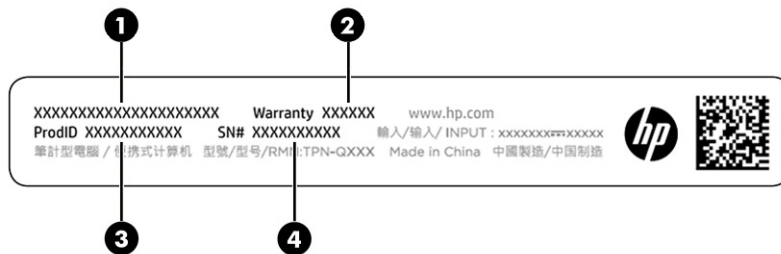

Table 2-13 Service label components

Component
(1) HP product name
(2) Warranty period
(3) Product ID
(4) Serial number

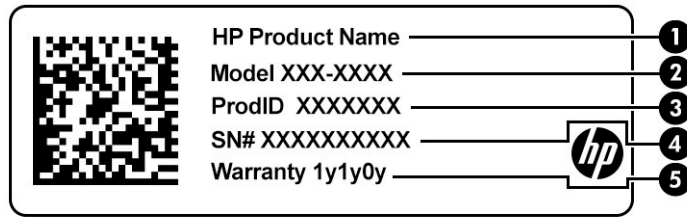

Table 2-14 Service label components

Component
(1) HP product name
(2) Model number
(3) Product ID
(4) Serial number
(5) Warranty period

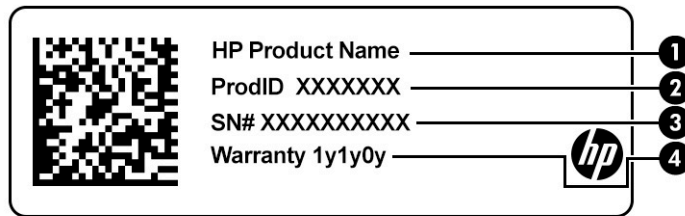

Table 2-15 Service label components

Component
(1) HP product name
(2) Product ID
(3) Serial number
(4) Warranty period

- Regulatory label(s)—Provide(s) regulatory information about the computer.
- Wireless certification label(s)—Provide(s) information about optional wireless devices and the approval markings for the countries or regions in which the devices have been approved for use.

Using a SIM card (select products only)

Use these instructions to insert a SIM card.

IMPORTANT: You can damage the SIM card if you insert the wrong size card or insert it or the SIM card tray in the wrong direction. The card might also become stuck in the slot. Do not use SIM card adapters. To prevent damage to the SIM card or connectors, use minimal force when inserting or removing a SIM card.

Determining the correct SIM card size for your computer

Before purchasing a SIM card, follow these instructions to determine the correct SIM card size for your computer.

1. Go to <http://www.hp.com/support>, and then search for your computer by product name or number.
2. Select **Product Information**.
3. Refer to the listed options to determine which card to purchase.

Inserting a nano SIM card

To insert a nano SIM card, follow these steps.

1. Position the computer display-side up on a flat surface.
2. Press in gently on the SIM card access tray to disengage the SIM lock, and the tray will pop out of the slot **(1)**.
3. Remove the tray **(2)** from the computer and insert the card **(3)**.
4. Replace the tray in the computer. Press in gently on the tray **(4)** until it is firmly seated.

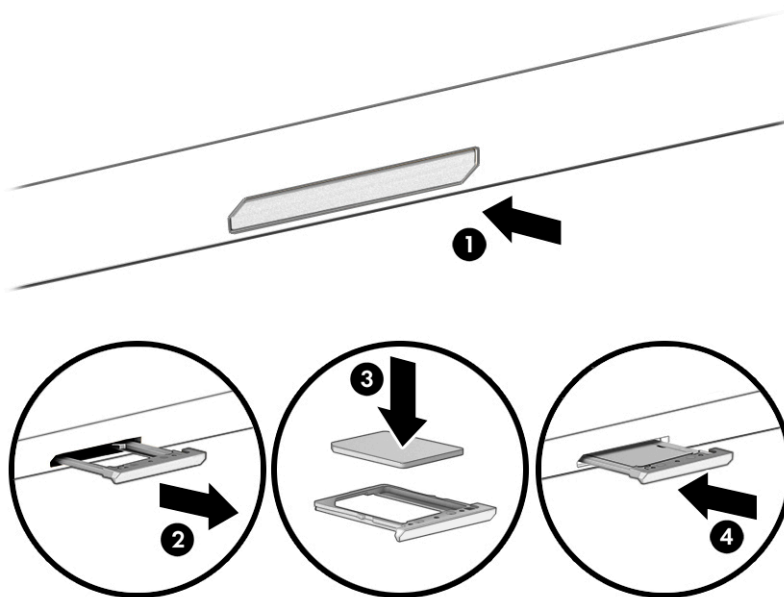

To remove the SIM card, press in gently on the SIM card access tray to disengage the SIM lock, and the tray will pop out of the slot. Remove the SIM card. Replace the tray in the computer and press in gently on the tray until it is firmly seated.

Using Tile (select products only)

Some computers include a Tile™ Bluetooth® device that can help find your computer even when it is off or in the Sleep state. The Tile device operates in combination with the Tile software on your computer.



NOTE: The limit of the Tile Bluetooth signal is approximately 76 m (250 feet).

To use the Tile features on your computer:

1. Select the **Start** menu, and then select the **Tile** app.
2. Follow the on-screen instructions to create a Tile account and activate your Tile features.

3 Network connections

Your computer can travel with you wherever you go. But even at home, you can explore the globe and access information from millions of websites by using your computer and a wired or wireless network connection. This chapter helps you get connected to that world.

Connecting to a wireless network

Your computer might be equipped with one or more wireless devices.

- **WLAN device**—Connects the computer to wireless local area networks (commonly referred to as Wi-Fi networks, wireless LANs, or WLANs) in corporate offices, your home, and public places such as airports, restaurants, coffee shops, hotels, and universities. In a WLAN, the mobile wireless device in your computer communicates with a wireless router or a wireless access point.
- **HP Mobile Broadband Module (select products only)**—A wireless wide area network (WWAN) device that gives you wireless connectivity over a much larger area. Mobile network operators install base stations (similar to cell phone towers) throughout large geographic areas, effectively providing coverage across entire states, regions, or even countries.
- **Bluetooth® device**—Creates a personal area network (PAN) to connect to other Bluetooth-enabled devices such as computers, phones, printers, headsets, speakers, and cameras. In a PAN, each device communicates directly with other devices, and devices must be relatively close together—typically within 10 m (approximately 33 ft) of each other.

Using the wireless controls

You can control the wireless devices in your computer using one or more of these features.

- **Wireless button** (also called *airplane mode key* or *wireless key*)
- **Operating system controls**

Wireless button

The computer might have a wireless button, one or more wireless devices, and one or two wireless lights. All the wireless devices on your computer are enabled at the factory.

The wireless light indicates the overall power state of your wireless devices, not the status of individual devices.

Operating system controls

The Network and Sharing Center allows you to set up a connection or network, connect to a network, and diagnose and repair network problems.

To use operating system controls:

Type `control panel` in the taskbar search box, select **Control Panel**, and then select **Network and Sharing Center**.

– or –

On the taskbar, select the network status icon, and then select **Network & Internet settings**.

Connecting to a WLAN

Before you can connect to a WLAN with this procedure, you must first set up internet access.

 **NOTE:** When you are setting up internet access in your home, you must establish an account with an internet service provider (ISP). To purchase internet service and a modem, contact a local ISP. The ISP will help set up the modem, install a network cable to connect your wireless router to the modem, and test the internet service.

1. Be sure that the WLAN device is on.
2. On the taskbar, select the network status icon, and then connect to one of the available networks.

If the WLAN is a security-enabled WLAN, you are prompted to enter a security code. Enter the code, and then select **Next** to complete the connection.

 **NOTE:** If no WLANs are listed, you might be out of range of a wireless router or access point.

 **NOTE:** If you do not see the WLAN that you want to connect to:

On the taskbar, right-click the network status icon, and then select **Open Network & Internet settings**.

– or –

On the taskbar, select the network status icon, and then select **Network & Internet settings**.

Under the **Change your network settings** section, select **Network and Sharing Center**.

Select **Set up a new connection or network**.

A list of options is displayed, which allows you to manually search for and connect to a network or to create a new network connection.

3. Follow the on-screen instructions to complete the connection.

After the connection is made, select the network status icon at the far right of the taskbar to verify the name and status of the connection.

 **NOTE:** The functional range (how far your wireless signals travel) depends on WLAN implementation, router manufacturer, and interference from other electronic devices or structural barriers such as walls and floors.

Using HP Mobile Broadband (select products only)

Your HP Mobile Broadband computer has built-in support for mobile broadband service. Your new computer, when used with a mobile operator's network, gives you the freedom to connect to the internet, send email, or connect to your corporate network without the need for Wi-Fi hotspots.

You might need the HP Mobile Broadband Module IMEI number, MEID number, or both to activate mobile broadband service. The number might be printed on a label located on the bottom of your computer, inside the battery bay, under the service door, or on the back of the display.

– or –

1. On the taskbar, select the network status icon.
2. Select **Network & Internet settings**.
3. Under the **Network & Internet** section, select **Cellular**, and then select **Advanced Options**.

Some mobile network operators require the use of a SIM card. A SIM card contains basic information about you, such as a personal identification number (PIN), as well as network information. Some computers include a SIM card that is preinstalled. If the SIM card is not preinstalled, it might be provided in the HP Mobile

Broadband information that is included with your computer or the mobile network operator might provide it separately from the computer.

For information about HP Mobile Broadband and how to activate service with a preferred mobile network operator, see the HP Mobile Broadband information included with your computer.

Using eSIM (select products only)

Your computer might be equipped with an eSIM. An eSIM is a programmable version of the commonly used SIM that you can use to download different profiles from selected carriers.

An eSIM lets you connect to the internet over a cellular data connection. With an eSIM, you do not need to get a SIM card from your mobile operator, and you can quickly switch between mobile operators and data plans. For example, you might have one cellular data plan for work and a different plan with another mobile operator for personal use. If you travel, you can connect in more places by finding mobile operators with plans in that area.

You can implement eSIMs in two ways:

- The eSIM chip can be embedded (eUICC). The notebook then operates as a dual SIM, one as eUICC and the second as standard micro or nano SIM card on a SIM card tray. Only one SIM can be active at a time.
- A removable physical eSIM is placed on a SIM card tray like a standard micro or nano SIM card, but the eSIM is not limited to a single carrier (physical blank eSIM).

You must add an eSIM profile to connect to the internet using cellular data. To add a profile, manage SIM profiles, and learn how to use an eSIM, go to <https://www.support.microsoft.com>, and type `Use an eSIM` in the search bar.

Using GPS (select products only)

Your computer might be equipped with a Global Positioning System (GPS) device. GPS satellites deliver location, speed, and direction information to GPS-equipped systems. To enable GPS, be sure that location is enabled under the Windows privacy setting.

1. Type `location` in the taskbar search box, and then select **Location privacy settings**.
2. Follow the on-screen instructions for using location settings.

Using Bluetooth wireless devices (select products only)

A Bluetooth device provides short-range wireless communications that replace the physical cable connections that traditionally link electronic devices.

- Computers (desktop, notebook)
- Phones (cellular, cordless, smartphone)
- Imaging devices (printer, camera)
- Audio devices (headset, speakers)
- Mouse
- External keyboard

Connecting Bluetooth devices

Before you can use a Bluetooth device, you must establish a Bluetooth connection.

1. Type `bluetooth` in the taskbar search box, and then select **Bluetooth and other devices settings**.
2. Turn on Bluetooth, if it is not already turned on.
3. Select **Add Bluetooth or other device**, and then in the **Add a device** dialog box, select **Bluetooth**.
4. Select your device from the list, and then follow the on-screen instructions.

 **NOTE:** If the device requires verification, a pairing code is displayed. On the device that you are adding, follow the on-screen instructions to verify that the code on your device matches the pairing code. For more information, see the documentation provided with the device.

 **NOTE:** If your device does not appear in the list, be sure that Bluetooth is turned on for that device. Some devices might have additional requirements; see the documentation provided with the device.

Using NFC to share information (select products only)

Your computer supports Near Field Communication (NFC), which allows you to wirelessly share information between two NFC-enabled devices. Information is transferred from the tapping area (antenna) of one device to another. With NFC and supported apps, you can share websites, transfer contact information, transfer payments, and print on NFC-enabled printers.

 **NOTE:** To locate the tapping area on your computer, see [Components on page 3](#).

1. Confirm that the NFC function is enabled.
 - Type `wireless` in the taskbar search box, and then select **Turn wireless devices on or off**.
 - Confirm that the selection for NFC is **On**.
2. Tap the NFC tapping area with an NFC-enabled device. You might hear a sound when the devices connect.

 **NOTE:** To find the location of the antenna on the other NFC device, see your device instructions.

3. Follow any on-screen instructions to continue.

Connecting to a wired network

Select products might allow wired connections: local area network (LAN) and modem connection. A LAN connection uses a network cable and is much faster than a modem, which uses a telephone cable. Both cables are sold separately.

 **WARNING!** To reduce the risk of electric shock, fire, or damage to the equipment, do not plug a modem cable or telephone cable into an RJ-45 (network) jack.

Connecting to a local area network (LAN) (select products only)

Use a LAN connection if you want to connect the computer directly to a router in your home (instead of working wirelessly) or if you want to connect to an existing network at your office.

To connect the network cable, follow these steps:

 **NOTE:** A feature called HP LAN-Wireless Protection might be enabled on your computer. It closes your wireless (Wi-Fi) or WWAN connection when you connect directly to a LAN. For more information about HP LAN-Wireless Protection, see [Using HP LAN-Wireless Protection \(select products only\) on page 22](#).

If there is no RJ-45 port on the computer, connecting to a LAN requires a network cable and a network jack or an optional docking device or expansion product.

1. Plug the network cable into the network jack **(1)** on the computer or on an optional docking device or expansion product.
2. Plug the other end of the network cable into a network wall jack **(2)** or router.

 **NOTE:** If the network cable contains noise suppression circuitry **(3)**, which prevents interference from TV and radio reception, orient the circuitry end of the cable toward the computer.

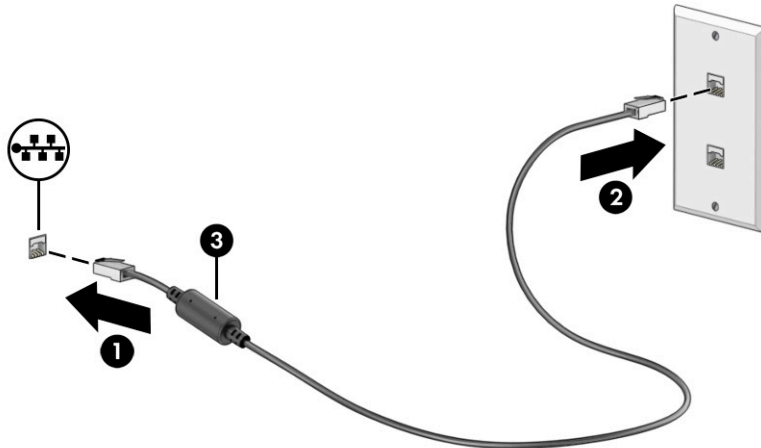

Using HP LAN-Wireless Protection (select products only)

In a LAN environment, you can set HP LAN-Wireless Protection to safeguard your LAN network from unauthorized wireless access. When HP LAN-Wireless Protection is enabled, the WLAN (Wi-Fi) or WWAN connection is turned off when the computer is connected directly to a LAN.

To turn on and customize HP LAN-Wireless Protection:

1. Start Computer Setup (BIOS).
 - Computers or tablets with keyboards:
 - ▲ Turn on or restart the computer, and before the HP logo appears, press **f10** to enter Computer Setup.
 - Tablets without keyboards:
 - ▲ Turn on or restart the tablet, and then quickly hold down the volume down button until the Startup menu is displayed. Tap **f10** to enter Computer Setup.
2. Select **Advanced**, and then select **Built-in Device Options**.
3. Select the check box for **LAN/WLAN Auto Switching**, **LAN/WWAN Auto Switching**, or both to turn off WLAN connections, WWAN connections, or both when connected to a LAN network.
4. To save your changes and exit Computer Setup, select **Main**, select **Save Changes and Exit**, and then select **Yes**.

 **NOTE:** If you are using arrow keys to highlight your choice, you must then press **enter**.

Your changes take effect when the computer restarts.

Using HP MAC Address Pass Through (select products only)

MAC Address Pass Through provides a customizable way of identifying your computer and its communications on networks. This system MAC address provides unique identification even when your computer is connected through a network adapter. This address is enabled by default.

To customize MAC Address Pass Through:

1. Start Computer Setup (BIOS).
 - Computers or tablets with keyboards:
 - ▲ Turn on or restart the computer, and when the HP logo appears, press **f10** to enter Computer Setup.
 - Tablets without keyboards:
 - ▲ Turn on or restart the tablet, and then quickly hold down the volume down button until the Startup menu is displayed. Tap **f10** to enter Computer Setup.
2. Select **Advanced**, and then select **MAC Address Pass Through**.
3. In the box to the right of **Host Based MAC Address**, select either **System Address** to enable MAC address Pass Through or **Custom Address** to customize the address.
4. If you selected Custom, select **MAC ADDRESS**, enter your customized system MAC address, and then press **enter** to save the address.
5. If the computer has an embedded LAN and you would like to use the embedded MAC address as the system MAC address, select **Reuse Embedded LAN Address**.

– or –

Select **Main**, select **Save Changes and Exit**, and then select **Yes**.



NOTE: If you are using arrow keys to highlight your choice, you must then press **enter**.

Your changes take effect when the computer restarts.

4 Navigating the screen

Depending on your computer model, you can navigate the computer screen using one or more methods.

- Use touch gestures directly on the computer screen.
- Use touch gestures on the touchpad.
- Use an optional mouse or keyboard (purchased separately).
- Use an on-screen keyboard.
- Use a pointing stick.

Using touchpad and touch screen gestures

The touchpad helps you navigate the computer screen and control the pointer using simple touch gestures. You can also use the left and right touchpad buttons as you would use the corresponding buttons on an external mouse.

To navigate a touch screen (select products only), touch the screen directly using gestures described in this chapter. To customize gestures and see videos of how they work, type `control panel` in the taskbar search box, select **Control Panel**, and then select **Hardware and Sound**. Under **Devices and Printers**, select **Mouse**.

Some products include a precision touchpad, which provides enhanced gesture functionality. To determine if you have a precision touchpad and find additional information, select **Start**, select **Settings**, select **Devices**, and then select **Touchpad**.

 **NOTE:** Unless noted, gestures can be used on both the touchpad and a touch screen.

Tap

Point to an item on the screen, and then tap one finger on the touchpad zone or touch screen to select the item. Double-tap an item to open it.



Two-finger pinch zoom

Use the two-finger pinch zoom to zoom out or in on images or text.

- Zoom out by placing two fingers apart on the touchpad zone or touch screen and then moving your fingers together.
- Zoom in by placing two fingers together on the touchpad zone or touch screen and then moving your fingers apart.

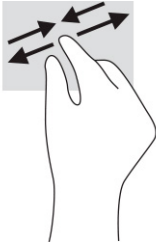

Two-finger slide (touchpad and precision touchpad)

Place two fingers slightly apart on the touchpad zone and then drag them up, down, left, or right to move up, down, or sideways on a page or image.

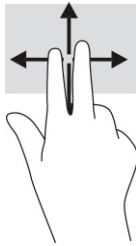

Two-finger tap (touchpad and precision touchpad)

Tap two fingers on the touchpad zone to open the options menu for the selected object.



NOTE: The two-finger tap performs the same function as right-clicking with a mouse.



Three-finger tap (touchpad and precision touchpad)

By default, the three-finger tap opens the taskbar search box. Tap three fingers on the touchpad zone to perform the gesture.

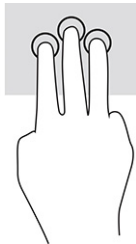

To change the function of this gesture on a precision touchpad, select **Start**, select **Settings**, select **Devices**, and then select **Touchpad**. Under **Three-finger gestures**, in the **Taps** box, select a gesture setting.

Four-finger tap (touchpad and precision touchpad)

By default, the four-finger tap opens the Action Center. Tap four fingers on the touchpad zone to perform the gesture.

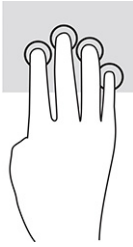

To change the function of this gesture on a precision touchpad, select **Start**, select **Settings**, select **Devices**, and then select **Touchpad**. Under **Four-finger gestures**, in the **Taps** box, select a gesture setting.

Three-finger swipe (touchpad and precision touchpad)

By default, the three-finger swipe switches between open apps and the desktop.

- Swipe three fingers away from you to see all open windows.
- Swipe three fingers toward you to show the desktop.
- Swipe three fingers left or right to switch between open windows.

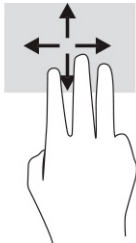

To change the function of this gesture on a precision touchpad, select **Start**, select **Settings**, select **Devices**, and then select **Touchpad**. Under **Three-finger gestures**, in the **Swipes** box, select a gesture setting.

Four-finger swipe (precision touchpad)

By default, the four-finger swipe switches between open desktops.

- Swipe four fingers away from you to see all open windows.
- Swipe four fingers toward you to show the desktop.
- Swipe four fingers left or right to switch between desktops.

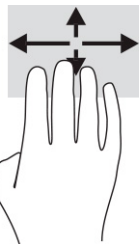

To change the function of this gesture, select **Start**, select **Settings**, select **Devices**, and then select **Touchpad**. Under **Four-finger gestures**, in the **Swipes** box, select a gesture setting.

One-finger slide (touch screen)

Use the one-finger slide to pan or scroll through lists and pages, or to move an object.

- To scroll across the screen, lightly slide one finger across the screen in the direction you want to move.
- To move an object, press and hold your finger on an object, and then drag your finger to move the object.

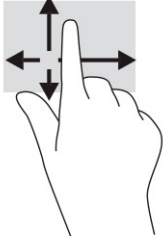

Using an optional keyboard or mouse

An optional keyboard or mouse allows you to type, select items, scroll, and perform the same functions as you do using touch gestures. The keyboard also allows you to use action keys and hot keys to perform specific functions.

Using an on-screen keyboard (select products only)

These instructions help you learn to use the on-screen keyboard.

1. To display an on-screen keyboard, tap the keyboard icon in the notification area, at the far right of the taskbar.
2. Begin typing.



NOTE: Suggested words might be displayed above the on-screen keyboard. Tap a word to select it.



NOTE: Action keys and hot keys do not display or function on the on-screen keyboard.

5 Entertainment features

Use your HP computer for business or pleasure to meet with others via the camera, mix audio and video, or connect external devices like a projector, monitor, TV, or speakers.

See [Components on page 3](#) to locate the audio, video and camera features on your computer.

Using a camera (select products only)

Your computer has one or more cameras that enable you to connect with others for work or play. Most cameras allow you to video chat, record video, and record still images. Cameras can be front facing or rear facing.

To determine which camera or cameras are on your product, see [Components on page 3](#). To use your camera, type `camera` in the taskbar search box, and then select **Camera** from the list of applications. Some cameras also feature HD (high-definition) capability, apps for gaming, or facial recognition software like Windows Hello. See [Security on page 41](#) for details about using Windows Hello.

You can enhance your computer privacy by covering the lens with the camera privacy cover. By default, the camera lens is uncovered, but you can slide the camera privacy cover to block the camera's view. To use the camera, slide the camera privacy cover in the opposite direction to reveal the lens.

Using audio

You can download and listen to music, stream audio content (including radio) from the web, record audio, or mix audio and video to create multimedia. You can also play music CDs on the computer (on select products) or attach an external optical drive to play CDs.

To enhance your listening enjoyment, attach headphones or speakers.

Connecting speakers

You can attach wired speakers to your computer by connecting them to a USB port or to the audio-out (headphone)/audio-in (microphone) combo jack on your computer or on a docking station.

To connect wireless speakers to your computer, follow the device manufacturer's instructions. To connect high-definition speakers to the computer, see [Setting up HDMI audio on page 31](#). Before connecting speakers, lower the volume setting.

Connecting headphones

You can connect wired headphones to the audio-out (headphone)/audio-in (microphone) combo jack on your computer.

 **WARNING!** To reduce the risk of personal injury, lower the volume setting before putting on headphones, earbuds, or a headset. For additional safety information, see the *Regulatory, Safety, and Environmental Notices*.

To access this guide:

▲ Type `HP Documentation` in the taskbar search box, and then select **HP Documentation**.

To connect wireless headphones to your computer, follow the device manufacturer's instructions.

Connecting headsets

You can connect a headset to the audio-out (headphone)/audio-in (microphone) combo jack on your computer.

A stand-alone microphone can be plugged into a USB port. See your manufacturer's instructions.

 **WARNING!** To reduce the risk of personal injury, lower the volume setting before putting on headphones, earbuds, or a headset. For additional safety information, see the *Regulatory, Safety, and Environmental Notices*.

To access this guide:

▲ Type `HP Documentation` in the taskbar search box, and then select **HP Documentation**.

Headphones combined with a microphone are called headsets. You can connect wired headsets to the audio-out (headphone)/audio-in (microphone) combo jack on your computer.

To connect wireless headsets to your computer, follow the device manufacturer's instructions.

Using sound settings

Use sound settings to adjust system volume, change system sounds, or manage audio devices.

Viewing or changing sound settings

Use these instructions to view or change sound settings.

▲ Type `control panel` in the taskbar search box, select **Control Panel**, select **Hardware and Sound**, and then select **Sound**.

Using the control panel to view and control audio settings

You can view or change sound settings using the audio control panel.

Your computer might include an enhanced sound system by Bang & Olufsen, DTS, Beats audio, or another provider. As a result, your computer might include advanced audio features that can be controlled through an audio control panel specific to your audio system.

Use the audio control panel to view and control audio settings.

▲ Type `control panel` in the taskbar search box, select **Control Panel**, select **Hardware and Sound**, and then select the audio control panel specific to your system.

Using video

Your computer is a powerful video device that enables you to watch streaming video from your favorite websites and download video and movies to watch on your computer when you are not connected to a network.

To enhance your viewing enjoyment, use one of the video ports on the computer to connect an external monitor, projector, or TV.

 **IMPORTANT:** Be sure that the external device is connected to the correct port on the computer, using the correct cable. Follow the device manufacturer's instructions.

For information about using your video features, refer to HP Support Assistant.

Connecting a Thunderbolt device using a USB Type-C cable

To see video or high-resolution display output on an external Thunderbolt device, follow these steps.

 **NOTE:** To connect a USB Type-C Thunderbolt device to your computer, you need a USB Type-C cable, purchased separately.

Connect the Thunderbolt device according to the following instructions:

1. Connect one end of the USB Type-C cable to the USB Type-C Thunderbolt port on the computer.

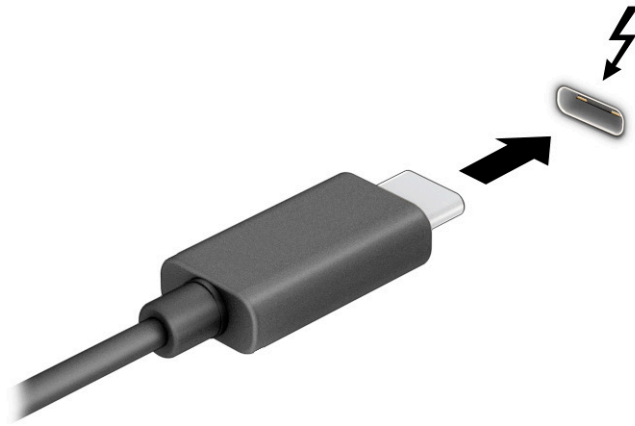

2. Connect the other end of the cable to the external Thunderbolt device.
3. Press **f1** to cycle through four display states:
 - **PC screen only:** View the screen image on the computer only.
 - **Duplicate:** View the screen image simultaneously on both the computer and external device.
 - **Extend:** View the screen image extended across both the computer and external device.
 - **Second screen only:** View the screen image on the external device only.

Each time you press **f1** the display state changes.

 **NOTE:** For best results, especially if you choose the **Extend** option, increase the screen resolution of the external device, as follows. Select the **Start** button, select **Settings**, and then select **System**. Under **Display**, select the appropriate resolution, and then select **Keep changes**.

Connecting video devices using an HDMI cable (select products only)

HDMI is the only video interface that supports high-definition video and audio.

Connecting a high-definition TV or monitor using HDMI

To see the computer screen image on a high-definition TV or monitor, connect the high-definition device according to the instructions.

 **NOTE:** To connect an HDMI device to your computer, you need an HDMI cable, purchased separately.

1. Connect one end of the HDMI cable to the HDMI port on the computer.

 **NOTE:** HDMI port shape can vary by product.

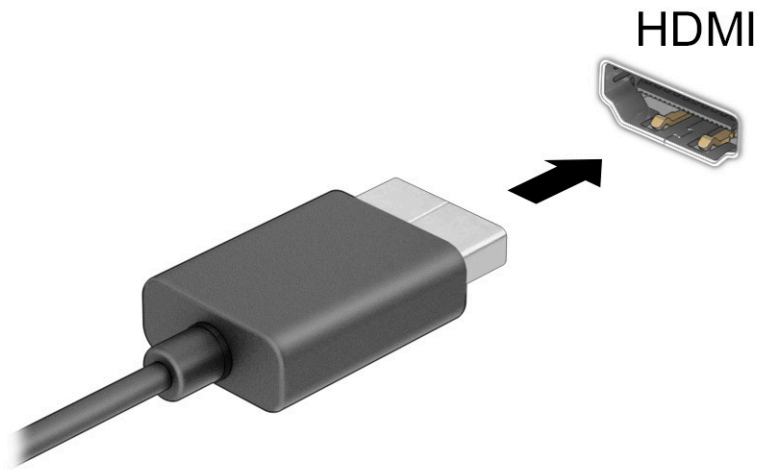

2. Connect the other end of the cable to the high-definition TV or monitor.
3. Press **f1** to cycle through one of four display states:
 - **PC screen only:** View the screen image on the computer only.
 - **Duplicate:** View the screen image simultaneously on both the computer and the external device.
 - **Extend:** View the screen image extended across both the computer and the external device.
 - **Second screen only:** View the screen image on the external device only.

Each time you press **f1**, the display state changes.

 **NOTE:** For best results, especially if you choose the **Extend** option, increase the screen resolution of the external device, as follows. Select the **Start** button, select **Settings**, and then select **System**. Under **Display**, select the appropriate resolution, and then select **Keep changes**.

Setting up HDMI audio

Use these instructions to set up HDMI audio.

Turning on HDMI audio

After you connect an HDMI TV to the computer, you can then turn on HDMI audio by following these steps.

1. Right-click the **Speakers** icon in the notification area, at the far right of the taskbar, and then select **Playback devices**.
2. On the **Playback** tab, select the name of the digital output device.
3. Select **Set Default**, and then select **OK**.

Turning off HDMI audio

Use these instructions to return the audio stream to the computer speakers.

1. Right-click the **Speakers** icon in the notification area, at the far right of the taskbar, and then select **Playback devices**.
2. On the **Playback** tab, select **Speakers**.
3. Select **Set Default**, and then select **OK**.

Discovering and connecting wired displays using MultiStream Transport

MultiStream Transport (MST) allows you to connect multiple wired display devices to your computer by connecting to the VGA port or DisplayPort connectors on your computer and also to the VGA port or DisplayPort connectors on a hub or an external docking station.

You can connect in several ways, depending on the type of graphics controller installed on your computer and whether or not your computer includes a built-in hub. Go to **Device Manager** to find out what hardware is installed on your computer.

Connecting displays to computers with Intel graphics (with an optional hub)

To set up multiple display devices, follow these steps.



NOTE: With an Intel graphics controller and optional hub, you can connect up to three display devices.

1. Connect an external hub (purchased separately) to the DisplayPort connector on your computer, using a DP-to-DP cable (purchased separately). Be sure that the hub power adapter is connected to AC power.
2. Connect your external display devices to the VGA port or DisplayPort connectors on the hub.
3. When Windows detects a monitor connected to the DisplayPort hub, the **DisplayPort Topology Notification** dialog box is displayed. Select the appropriate options to configure your displays. Multiple display choices include **Duplicate**, which mirrors your computer screen on all enabled display devices, or **Extend**, which extends the screen image across all enabled display devices.



NOTE: If this dialog box does not appear, be sure that each external display device is connected to the correct port on the hub. Select the **Start** button, select **Settings**, and then select **System**. Under **Display**, select the appropriate resolution, and then select **Keep changes**.

Connecting displays to computers with Intel graphics (with a built-in hub)

To set up multiple display devices, follow these steps.

With your internal hub and Intel graphics controller, you can connect up to three display devices in the following configurations:

- Two 1920 × 1200 DisplayPort monitors connected to the computer and one 1920 × 1200 VGA monitor connected to an optional docking station
 - One 2560 × 1600 DisplayPort monitor connected to the computer and one 1920 × 1200 VGA monitor connected to an optional docking station
1. Connect your external display devices to the VGA port or DisplayPort connectors on the computer base or the docking station.
 2. When Windows detects a monitor connected to the DisplayPort hub, the **DisplayPort Topology Notification** dialog box is displayed. Select the appropriate options to configure your displays. Multiple display choices include **Duplicate**, which mirrors your computer screen on all enabled display devices, or **Extend**, which extends the screen image across all enabled display devices.

 **NOTE:** If this dialog box does not appear, be sure that each external display device is connected to the correct port on the hub. Select the **Start** button, select **Settings**, and then select **System**. Under **Display**, select the appropriate resolution, and then select **Keep changes**.

Discovering and connecting to Miracast-compatible wireless displays (select products only)

Follow these steps to discover and connect to Miracast[®]-compatible wireless displays without leaving your current apps.

 **NOTE:** To learn what type of display you have (Miracast-compatible or Intel WiDi), refer to the documentation that came with your TV or secondary display.

To discover and connect to Miracast-compatible wireless displays without leaving your current apps, follow these steps.

- ▲ Type `project` in the taskbar search box, and then select **Project to a second screen**. Select **Connect to a wireless display**, and then follow the on-screen instructions.

Discovering and connecting to Intel WiDi certified displays (select Intel products only)

Use Intel WiDi to wirelessly project individual files such as photos, music, or videos, or to duplicate your entire computer screen to a TV or a secondary display device.

Intel WiDi, a premium Miracast solution, makes it easy and seamless to pair your secondary display device; provides for full-screen duplication; and improves speed, quality, and scaling.

Connecting to Intel WiDi certified displays

Follow these steps to connect to Intel WiDi certified displays.

- ▲ Type `project` in the taskbar search box, and then select **Project to a second screen**. Select **Connect to a wireless display**, and then follow the on-screen instructions.

Opening Intel WiDi

Follow these steps to open Intel WiDi.

- ▲ Type `Intel WiDi` in the taskbar search box, and then select **Intel WiDi**.

Using data transfer

Your computer is a powerful entertainment device that enables you to transfer photos, videos, and movies from your USB devices to view on your computer.

To enhance your viewing enjoyment, use one of the USB Type-C ports on the computer to connect a USB device, such as a cell phone, camera, activity tracker, or smartwatch, and transfer the files to your computer.

 **IMPORTANT:** Be sure that the external device is connected to the correct port on the computer, using the correct cable. Follow the device manufacturer's instructions.

For information about using your USB Type-C features, refer to HP Support Assistant.

Connecting devices to a USB Type-C port (select products only)

To connect devices to a USB Type-C port, follow these steps.

 **NOTE:** To connect a USB Type-C device to your computer, you need a USB Type-C cable, purchased separately.

1. Connect one end of the USB Type-C cable to the USB Type-C port on the computer.

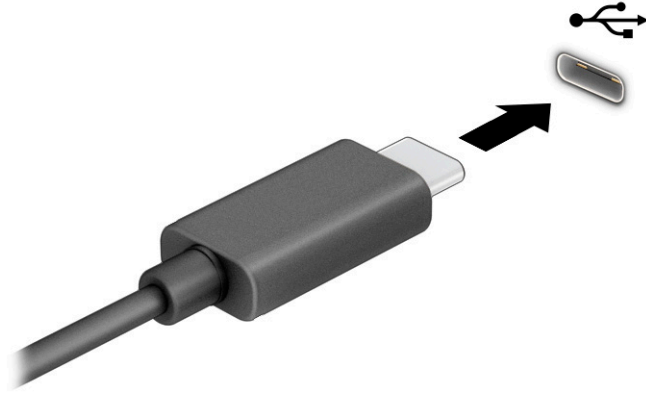

2. Connect the other end of the cable to the external device.

6 Managing power

Your computer can operate on either battery power or external power. When the computer is running on battery power and an external power source is not available to charge the battery, it is important to monitor and conserve the battery charge.

Some power management features described in this chapter might not be available on your computer.

Using Sleep and Hibernation

Windows has two power-saving states, Sleep and Hibernation.

- **Sleep**—The Sleep state automatically initiates after a period of inactivity. Your work is available in memory, allowing you to resume your work quickly. You can also initiate Sleep manually. Depending on your computer model, the Sleep state might also support Modern Standby mode. This mode keeps some internal operations awake and enables your computer to receive web notifications, such as emails, while in Sleep. For more information, see [Initiating and exiting Sleep on page 35](#).
- **Hibernation**—The Hibernation state is automatically initiated if the battery reaches a critical level or the computer has been in the Sleep state for an extended period of time. In the Hibernation state, your work is saved to a hibernation file and the computer powers down. You can also initiate Hibernation manually. For more information, see [Initiating and exiting Hibernation \(select products only\) on page 36](#).



IMPORTANT: Several well-known vulnerabilities exist when a computer is in the Sleep state. To prevent an unauthorized user from accessing data on your computer, even encrypted data, HP recommends that you always initiate Hibernation instead of Sleep anytime the computer will be out of your physical possession. This practice is particularly important when you travel with your computer.

IMPORTANT: To reduce the risk of possible audio and video degradation, loss of audio or video playback functionality, or loss of information, do not initiate Sleep while reading from or writing to a disc or an external media card.

Initiating and exiting Sleep

You can initiate Sleep in several ways.

- Select the **Start** button, select the **Power** icon, and then select **Sleep**.
- Close the display (select products only).
- Press the Sleep hot key (select products only); for example, **fn+f1** or **fn+f12**.
- Briefly press the power button (select products only).

You can exit Sleep in any of the following ways:

- Briefly press the power button.
- If the computer is closed, raise the display (select products only).
- Press a key on the keyboard (select products only).
- Tap the touchpad (select products only).

When the computer exits Sleep, your work returns to the screen.



IMPORTANT: If you have set a password to be required on exiting Sleep, you must enter your Windows password before your work returns to the screen.

Initiating and exiting Hibernation (select products only)

You can enable user-initiated Hibernation and change other power settings and timeouts using Power Options.

1. Right-click the **Power** icon , and then select **Power Options**.
2. In the left pane, select **Choose what the power buttons do** (wording might vary by product).
3. Depending on your product, you can enable Hibernation for battery power or external power in any of the following ways:
 - **Power button**—Under **Power and sleep buttons and lid settings** (wording might vary by product), select **When I press the power button**, and then select **Hibernate**.
 - **Sleep button** (select products only)—Under **Power and sleep buttons and lid settings** (wording might vary by product), select **When I press the sleep button**, and then select **Hibernate**.
 - **Lid** (select products only)—Under **Power and sleep buttons and lid settings** (wording might vary by product), select **When I close the lid**, and then select **Hibernate**.
 - **Power menu**—Select **Change Settings that are currently unavailable**, and then, under **Shutdown settings**, select the **Hibernate** check box.

The Power menu can be accessed by selecting the **Start** button.

4. Select **Save changes**.

To initiate Hibernation, use the method that you enabled in step 3.

To exit Hibernation, briefly press the power button.



IMPORTANT: If you have set a password to be required on exiting Hibernation, you must enter your Windows password before your work returns to the screen.

Shutting down (turning off) the computer

The Shut down command closes all open programs, including the operating system, and then turns off the display and the computer. Shut down the computer when it will be unused and disconnected from external power for an extended period.



IMPORTANT: Unsaved information is lost when the computer shuts down. Be sure to save your work before shutting down the computer.

The recommended procedure is to use the Windows Shut down command.



NOTE: If the computer is in the Sleep state or in Hibernation, first exit Sleep or Hibernation by briefly pressing the power button.



1. Save your work and close all open programs.
2. Select the **Start** button, select the **Power** icon, and then select **Shut down**.

If the computer is unresponsive and you are unable to use the preceding shutdown procedures, try the following emergency procedures in the sequence provided:

- Press **ctrl+alt+delete**, select the **Power** icon, and then select **Shut down**.
- Press and hold the power button for at least 4 seconds.
- If your computer has a user-replaceable battery (select products only), disconnect the computer from external power, and then remove the battery.

Using the Power icon and Power Options

The Power icon is located on the Windows taskbar. The Power icon allows you to quickly access power settings and view the remaining battery charge.

- To view the percentage of remaining battery charge, place the mouse pointer over the **Power** icon .
- To use Power Options, right-click the **Power** icon , and then select **Power Options**.

Different Power icons indicate whether the computer is running on battery or external power. Placing the mouse pointer over the icon reveals a message if the battery has reached a low or critical battery level.

Running on battery power

When the computer has a charged battery and is not plugged into external power, the computer runs on battery power. When the computer is off and unplugged from external power, the battery slowly discharges. The computer displays a message when the battery reaches a low or critical battery level.

 **WARNING!** To reduce potential safety issues, use only the battery provided with the computer, a replacement battery provided by HP, or a compatible battery purchased from HP.

Computer battery life varies, depending on power management settings, programs running on the computer, screen brightness, external devices connected to the computer, and other factors.

 **NOTE:** Select computer products can switch between graphic controllers to conserve battery charge.

Using HP Fast Charge (select products only)

The HP Fast Charge feature allows you to quickly charge your computer battery. Charging time might vary by $\pm 10\%$. When the remaining battery charge is between 0 and 50%, the battery charges to 50% of full capacity in no more than 30 to 45 minutes, depending on your computer model.

To use HP Fast Charge, shut down your computer, and then connect the AC adapter to your computer and to external power.

Displaying battery charge

To view the percentage of remaining battery charge, place the mouse pointer over the **Power** icon.

Finding battery information in HP Support Assistant (select products only)

Follow these steps to access battery information.

1. Type `support` in the taskbar search box, and then select the **HP Support Assistant** app.

– or –

Select the question mark icon in the taskbar.

2. Select **Troubleshooting and fixes**, and then in the **Diagnostics** section, select **HP Battery Check**. If HP Battery Check indicates that your battery should be replaced, contact support.

HP Support Assistant provides the following tools and information about the battery:

- HP Battery Check
- Information about battery types, specifications, life cycles, and capacity

Conserving battery power

Follow these steps to conserve battery power and maximize battery life.

- Lower the brightness of the display.
- Turn off wireless devices when you are not using them.
- Disconnect unused external devices that are not plugged into an external power source, such as an external hard drive connected to a USB port.
- Stop, disable, or remove any external media cards that you are not using.
- Before you leave your work, initiate Sleep or shut down the computer.

Identifying low battery levels

When a battery that is the sole power source for the computer reaches a low or critical battery level, the computer warns you in one of several ways.

- The battery light (select products only) indicates a low or critical battery level.

– or –

- The Power icon  shows a low or critical battery notification.



NOTE: For additional information about the Power icon, see [Using the Power icon and Power Options on page 37](#).

The computer takes the following actions for a critical battery level:

- If Hibernation is disabled and the computer is on or in the Sleep state, the computer remains briefly in the Sleep state and then shuts down and loses any unsaved information.
- If Hibernation is enabled and the computer is on or in the Sleep state, the computer initiates Hibernation.

Resolving a low battery level

You can quickly resolve low battery level conditions.

Resolving a low battery level when external power is available

Connect one of the following to the computer and to external power.

- AC adapter
- Optional docking device or expansion product
- Optional power adapter purchased as an accessory from HP

Resolving a low battery level when no power source is available

Save your work and shut down the computer.

Resolving a low battery level when the computer cannot exit Hibernation

When the battery level is low and you cannot bring the computer out of Hibernation, connect the AC adapter.

1. Connect the AC adapter to the computer and to external power.
2. Exit Hibernation by pressing the power button.

Factory-sealed battery

To monitor the status of the battery, or if the battery is no longer holding a charge, run HP Battery Check in the HP Support Assistant app (select products only).

1. Type `support` in the taskbar search box, and then select the **HP Support Assistant** app.
– or –
Select the question mark icon in the taskbar.
2. Select **Troubleshooting and fixes**, and then in the **Diagnostics** section, select **HP Battery Check**. If HP Battery Check indicates that your battery should be replaced, contact support.

The battery[ies] in this product cannot be easily replaced by users themselves. Removing or replacing the battery could affect your warranty coverage. If a battery is no longer holding a charge, contact support.

Running on external power

For information about connecting to external power, see the *Setup Instructions* poster provided in the computer box. The computer does not use battery power when the computer is connected to external power with an approved AC adapter or an optional docking device or expansion product.

 **WARNING!** To reduce potential safety issues, use only the AC adapter provided with the computer, a replacement AC adapter provided by HP, or a compatible AC adapter purchased from HP.

 **WARNING!** Do not charge the computer battery while you are aboard aircraft.

Connect the computer to external power under any of the following conditions:

- When charging or calibrating a battery
- When installing or updating system software
- When updating the system BIOS
- When writing information to a disc (select products only)
- When running Disk Defragmenter on computers with internal hard drives
- When performing a backup or recovery

When you connect the computer to external power:

- The battery begins to charge.
- The Power icon  changes appearance.

When you disconnect external power:

- The computer switches to battery power.
- The Power icon  changes appearance.

7 Security

Computer security is essential for protecting the confidentiality, integrity, and availability of your information. Standard security solutions provided by the Windows operating system, HP applications, Computer Setup (BIOS), and other third-party software can help protect your computer from a variety of risks, such as viruses, worms, and other types of malicious code.

 **NOTE:** Some security features listed in this chapter might not be available on your computer.

Protecting the computer

Standard security features provided by the Windows operating system and Computer Setup (BIOS, which runs under any operating system) can protect your personal settings and data from a variety of risks.

 **NOTE:** Security solutions are designed to act as deterrents. These deterrents may not prevent a product from being mishandled or stolen.

 **NOTE:** Before you send your computer for service, back up and delete confidential files, and remove all password settings.

 **NOTE:** Some features listed in this chapter may not be available on your computer.

 **NOTE:** Your computer supports Computrace, which is an online security-based tracking and recovery service available in select regions. If the computer is stolen, Computrace can track the computer if the unauthorized user accesses the Internet. You must purchase the software and subscribe to the service to use Computrace. For information about ordering the Computrace software, go to <http://www.hp.com>.

Table 7-1 Security solutions

Computer risk	Security feature
Unauthorized use of the computer	<ul style="list-style-type: none">• HP Client Security software, in combination with a password, smart card, contactless card, registered fingerprints, or other authentication credential• BIOS power-on password
Unauthorized access to Computer Setup (BIOS)	BIOS administrator password in Computer Setup*
Unauthorized access to the contents of a hard drive	DriveLock password (select products only) in Computer Setup*
Unauthorized startup from an optional external optical drive (select products only), optional external hard drive (select products only), or internal network adapter	Boot options feature in Computer Setup*
Unauthorized access to a Windows user account	Windows user password
Unauthorized access to data	Windows BitLocker
Unauthorized removal of the computer	Security cable slot (used with an optional security cable on select products only)

*Computer Setup is an embedded, ROM-based utility that can be used even when the operating system is not working or will not load. You can use a pointing device (touchpad, pointing stick, or USB mouse) or the keyboard to navigate and make selections in Computer Setup.

NOTE: On tablets without keyboards, you can use the touch screen.

Using passwords

A password is a group of characters that you choose to secure your computer information. You can set several types of passwords, depending on how you want to control access to your information. You can set passwords in Windows or in Computer Setup, which is preinstalled on the computer.

- BIOS administrator, power-on, and DriveLock passwords are set in Computer Setup and are managed by the system BIOS.
- Windows passwords are set only in the Windows operating system.
- If you forget both the DriveLock user password and the DriveLock master password set in Computer Setup, the hard drive that is protected by the passwords is permanently locked and can no longer be used.

You can use the same password for a Computer Setup feature and for a Windows security feature.

Use the following tips for creating and saving passwords:

- When creating passwords, follow requirements set by the program.
- Do not use the same password for multiple applications or websites, and do not reuse your Windows password for any other application or website.
- Use the Password Manager feature of HP Client Security to store your user names and passwords for your websites and applications. You can securely read them in the future if they cannot be remembered.
- Do not store passwords in a file on the computer.

The following tables list commonly used Windows and BIOS administrator passwords and describe their functions.

Setting passwords in Windows

Windows passwords can help protect your computer from unauthorized access.

Table 7-2 Types of Windows passwords and their functions

Password	Function
Administrator password*	Protects access to a Windows administrator-level account. NOTE: Setting the Windows administrator password does not set the BIOS administrator password.
User password*	Protects access to a Windows user account.

*For information about setting a Windows administrator password or a Windows user password, type `support` in the taskbar search box, and then select the **HP Support Assistant** app.

Setting passwords in Computer Setup

Computer Setup passwords provide additional layers of security for your computer.

Table 7-3 Types of Computer Setup passwords and their functions

Password	Function
BIOS administrator password*	Protects access to Computer Setup.

Table 7-3 Types of Computer Setup passwords and their functions (continued)

Password	Function
	NOTE: If features have been enabled to prevent removing the BIOS administrator password, you may not be able to remove it until those features have been disabled.
Power-on password	<ul style="list-style-type: none">• Must be entered each time you turn on or restart the computer.• If you forget your power-on password, you cannot turn on or restart the computer.
DriveLock master password*	Protects access to the internal hard drive that is protected by DriveLock, and is set under DriveLock Passwords during the enable process. This password is also used to remove DriveLock protection.
DriveLock user password*	Protects access to the internal hard drive that is protected by DriveLock, and is set under DriveLock Passwords during the enable process.

*For details about each of these passwords, see the following topics.

Managing a BIOS administrator password

To set, change, or delete this password, follow these steps.

Setting a new BIOS administrator password

A BIOS administrator password helps prevent unauthorized access to Computer Setup. Use these instructions to set a new BIOS administrator password.

1. Start Computer Setup.
 - Computers or tablets with keyboards:
 - ▲ Turn on or restart the computer, and when the HP logo appears, press **f10** to enter Computer Setup.
 - Tablets without keyboards:
 - ▲ Turn off the tablet. Press the power button in combination with the volume down button until the Startup menu is displayed, and then tap **f10** to enter Computer Setup.
2. Select **Security**, select **Create BIOS administrator password** or **Set Up BIOS administrator Password** (select products only), and then press **enter**.
3. When prompted, type a password.
4. When prompted, type the new password again to confirm.
5. To save your changes and exit Computer Setup, select **Main**, select **Save Changes and Exit**, and then select **Yes**.



NOTE: If you are using arrow keys to highlight your choice, you must then press **enter**.

Your changes go into effect when the computer restarts.

Changing a BIOS administrator password

Use these instructions to change a BIOS administrator password.

1. Start Computer Setup.
 - Computers or tablets with keyboards:
 - ▲ Turn on or restart the computer, and when the HP logo appears, press **f10** to enter Computer Setup.
 - Tablets without keyboards:
 - ▲ Turn off the tablet. Press the power button in combination with the volume down button until the Startup menu is displayed, and then tap **f10** to enter Computer Setup.
2. Enter your current BIOS administrator password.
3. Select **Security**, select **Change BIOS administrator Password** or **Change Password** (select products only), and then press **enter**.
4. When prompted, type your current password.
5. When prompted, type your new password.
6. When prompted, type your new password again to confirm.
7. To save your changes and exit Computer Setup, select **Main**, select **Save Changes and Exit**, and then select **Yes**.



NOTE: If you are using arrow keys to highlight your choice, you must then press **enter**.

Your changes go into effect when the computer restarts.

Deleting a BIOS administrator password

Use these instructions to delete a BIOS administrator password.

1. Start Computer Setup.
 - Computers or tablets with keyboards:
 - ▲ Turn on or restart the computer, and when the HP logo appears, press **f10** to enter Computer Setup.
 - Tablets without keyboards:
 - ▲ Turn off the tablet. Press the power button in combination with the volume down button until the Startup menu is displayed, and then tap **f10** to enter Computer Setup.
2. Enter your current BIOS administrator password.
3. Select **Security**, select **Change BIOS administrator Password** or **Change Password** (select products only), and then press **enter**.
4. When prompted, type your current password.
5. When prompted for the new password, leave the field empty, and then press **enter**.
6. When prompted to type your new password again, leave the field empty, and then press **enter**.
7. To save your changes and exit Computer Setup, select **Main**, select **Save Changes and Exit**, and then select **Yes**.



NOTE: If you are using arrow keys to highlight your choice, you must then press **enter**.

Your changes go into effect when the computer restarts.

Entering a BIOS administrator password

At the **BIOS administrator password** prompt, type your password (using the same keys that you used to set the password), and then press **enter**. After two unsuccessful attempts to enter the BIOS administrator password, you must restart the computer and try again.

Using DriveLock Security Options

DriveLock protection prevents unauthorized access to the contents of a hard drive.

DriveLock can be applied only to the internal hard drives of the computer. After DriveLock protection is applied to a drive, the appropriate password must be entered to access the drive. The drive must be inserted into the computer or an advanced port replicator for it to be unlocked.

DriveLock Security Options offers the following features:

- **Automatic DriveLock**—See [Selecting Automatic DriveLock \(select products only\) on page 45](#).
- **Set DriveLock Master Password**—See [Selecting manual DriveLock on page 46](#).
- **Enable DriveLock**—See [Enabling DriveLock and setting a DriveLock user password on page 47](#).

Selecting Automatic DriveLock (select products only)

You must set a BIOS administrator password before you can enable Automatic DriveLock.

When Automatic DriveLock is enabled, a random DriveLock user password and a DriveLock master password derived from the BIOS administrator password are created. When the computer is turned on, the random user password automatically unlocks the drive. If the drive is moved to another computer, you must enter the BIOS administrator password for the original computer at the DriveLock password prompt to unlock the drive.

Enabling Automatic DriveLock

To enable Automatic DriveLock, follow these steps.

1. Start Computer Setup.
 - Computers or tablets with keyboards:
 1. Turn off the computer.
 2. Press the power button, and when the HP logo appears, press **f10** to enter Computer Setup.
 - Tablets without keyboards:
 1. Turn off the tablet.
 2. Press the power button in combination with the volume down button until the Startup menu is displayed, and then tap **f10** to enter Computer Setup.
2. At the BIOS administrator password prompt, enter the BIOS administrator password, and then press **enter**.
3. Select **Security**, select **Hard Drive Utilities**, select **DriveLock/Automatic DriveLock**, and then press **enter**.
4. Use the **enter** key, left mouse click, or touch screen to select the **Automatic DriveLock** check box.
5. To save your changes and exit Computer Setup, select **Main**, select **Save Changes and Exit**, and then select **Yes**.



NOTE: If you are using arrow keys to highlight your choice, you must then press **enter**.

Disabling Automatic DriveLock

To disable Automatic DriveLock, follow these steps.

1. Start Computer Setup.
 - Computers or tablets with keyboards:
 1. Turn off the computer.
 2. Press the power button, and when the HP logo appears, press **f10** to enter Computer Setup.
 - Tablets without keyboards:
 1. Turn off the tablet.
 2. Press the power button in combination with the volume down button until the Startup menu is displayed, and then tap **f10** to enter Computer Setup.
2. At the BIOS administrator password prompt, enter the BIOS administrator password, and then press **enter**.
3. Select **Security**, select **Hard Drive Utilities**, select **DriveLock/Automatic DriveLock**, and then press **enter**.
4. Select an internal hard drive, and then press **enter**.
5. Use the **enter** key, left mouse click, or touch screen to clear the **Automatic DriveLock** check box.
6. To save your changes and exit Computer Setup, select **Main**, select **Save Changes and Exit**, and then select **Yes**.



NOTE: If you are using arrow keys to highlight your choice, you must then press **enter**.

Entering an Automatic DriveLock password

While Automatic DriveLock is enabled and the drive remains attached to the original computer, you will not be prompted to enter a DriveLock password to unlock the drive.

However, if the drive is moved to another computer, or the system board is replaced on the original computer, you will be prompted to provide the DriveLock password. If this happens, at the **DriveLock Password** prompt, type the BIOS administrator password for the original computer (using the same kind of keys you used to set the password), and then press **enter** to unlock the drive.

After three incorrect attempts to enter the password, you must shut down the computer and try again.

Selecting manual DriveLock

To manually apply DriveLock protection to an internal hard drive, you must set a master password, and DriveLock must be enabled in Computer Setup.



IMPORTANT: To prevent a DriveLock-protected hard drive from becoming permanently unusable, record the DriveLock user password and the DriveLock master password in a safe place away from your computer. If you forget both DriveLock passwords, the hard drive will be permanently locked and can no longer be used.

Note the following considerations about using DriveLock protection:

- After DriveLock protection is applied to a hard drive, you can access the hard drive only by entering either the DriveLock user password or the master password.
- The owner of the DriveLock user password should be the day-to-day user of the protected hard drive. The owner of the DriveLock master password may be either a system administrator or the day-to-day user.

- The DriveLock user password and the DriveLock master password can be identical.

Setting a DriveLock master password

To set a DriveLock master password, follow these steps.

1. Start Computer Setup.
 - Computers or tablets with keyboards:
 1. Turn off the computer.
 2. Press the power button, and when the HP logo appears, press **f10** to enter Computer Setup.
 - Tablets without keyboards:
 1. Turn off the tablet.
 2. Press the power button in combination with the volume down button until the Startup menu is displayed, and then tap **f10** to enter Computer Setup.
2. Select **Security**, make the selection for **Hard Drive Utilities**, select **DriveLock/Automatic DriveLock**, and then press **enter**.
3. Select the hard drive you want to protect, and then press **enter**.
4. Select **Set DriveLock Master Password**, and then press **enter**.
5. Carefully read the warning.
6. Follow the on-screen instructions to set a DriveLock master password.



NOTE: You can enable DriveLock and set a DriveLock user password before exiting from Computer Setup. For more information, see [Enabling DriveLock and setting a DriveLock user password on page 47](#).

7. To save your changes and exit Computer Setup, select **Main**, select **Save Changes and Exit**, and then select **Yes**.



NOTE: If you are using arrow keys to highlight your choice, you must then press **enter**.

Enabling DriveLock and setting a DriveLock user password

To enable DriveLock and set a DriveLock user password, follow these steps.

1. Start Computer Setup.
 - Computers or tablets with keyboards:
 1. Turn off the computer.
 2. Press the power button, and when the HP logo appears, press **f10** to enter Computer Setup.
 - Tablets without keyboards:
 1. Turn off the tablet.
 2. Press the power button in combination with the volume down button until the Startup menu is displayed, and then tap **f10** to enter Computer Setup.
2. Select **Security**, select **Hard Drive Utilities**, select **DriveLock/Automatic DriveLock**, and then press **enter**.
3. Select the hard drive you want to protect, and then press **enter**.

4. Select **Enable DriveLock** and then press [enter](#).
5. Carefully read the warning.
6. Follow the on-screen instructions to set a DriveLock user password and enable DriveLock.
7. To save your changes and exit Computer Setup, select **Main**, select **Save Changes and Exit**, and then select **Yes**.



NOTE: If you are using arrow keys to highlight your choice, you must then press [enter](#).

Disabling DriveLock

To disable DriveLock, follow these steps.

1. Start Computer Setup.
 - Computers or tablets with keyboards:
 1. Turn off the computer.
 2. Press the power button, and when the HP logo appears, press **f10** to enter Computer Setup.
 - Tablets without keyboards:
 1. Turn off the tablet.
 2. Press the power button in combination with the volume down button until the Startup menu is displayed, and then tap **f10** to enter Computer Setup.
2. Select **Security**, select **Hard Drive Utilities**, select **DriveLock/Automatic DriveLock**, and then press [enter](#).
3. Select the hard drive you want to manage, and then press [enter](#).
4. Select **Disable DriveLock**, and then press [enter](#).
5. Follow the on-screen instructions to disable DriveLock.
6. To save your changes and exit Computer Setup, select **Main**, select **Save Changes and Exit**, and then select **Yes**.



NOTE: If you are using arrow keys to highlight your choice, you must then press [enter](#).

Entering a DriveLock password

Be sure that the hard drive is inserted into the computer (not into an optional docking device or external MultiBay).

At the **DriveLock Password** prompt, type your DriveLock user or master password (using the same kind of keys you used to set the password), and then press [enter](#).

After three incorrect attempts to enter the password, you must shut down the computer and try again.

Changing a DriveLock password

To change a DriveLock password in Computer Setup, follow these steps.

1. Turn off the computer.
2. Press the power button.
3. At the **DriveLock Password** prompt, type the current DriveLock user password or master password that you are changing, press [enter](#), and then press or tap **f10** to enter Computer Setup.

4. Select **Security**, select **Hard Drive Utilities**, select **DriveLock/Automatic DriveLock**, and then press **enter**.
5. Select the hard drive you want to manage, and then press **enter**.
6. Make the selection for the DriveLock password that you want to change, and then follow the on-screen instructions to enter passwords.



NOTE: The **Change DriveLock Master Password** option is visible only if the DriveLock master password was provided at the DriveLock Password prompt in step 3.

7. To save your changes and exit Computer Setup, select **Main**, select **Save Changes and Exit**, and then select **Yes**.



NOTE: If you are using arrow keys to highlight your choice, you must then press **enter**.

Windows Hello (select products only)

On products equipped with a fingerprint reader or an infrared camera, Windows Hello allows you to enroll your fingerprint and your facial ID, and set up a PIN. After enrollment, you can use your fingerprint reader, facial ID, or PIN to sign in to Windows.

To set up Windows Hello:

1. Select the **Start** button, select **Settings**, select **Accounts**, and then select **Sign-in options**.
2. To add a password, select **Password**, and then select **Add**.
3. Under **Windows Hello Fingerprint** or **Windows Hello Face**, select **Set up**.
4. Select **Get Started**, and then follow the on-screen instructions to enroll your fingerprint or facial ID and set up a PIN.



IMPORTANT: To prevent fingerprint logon issues, be sure when you register your fingerprint that all sides of your finger are registered by the fingerprint reader.



NOTE: The PIN is not limited in length. The default setting is for numbers only. To include alphabetic or special characters, select the **include letters and symbols** check box.

Using antivirus software

When you use the computer to access email, a network, or the internet, you potentially expose it to computer viruses. Computer viruses can disable the operating system, programs, or utilities, or cause them to function abnormally.

Antivirus software can detect most viruses, destroy them, and, in most cases, repair any damage that they cause. To provide ongoing protection against newly discovered viruses, antivirus software must be kept up to date.

Windows Defender is preinstalled on your computer. HP strongly recommends that you continue to use an antivirus program to fully protect your computer.

For more information about computer viruses, access the HP Support Assistant.

Using firewall software

Firewalls are designed to prevent unauthorized access to a system or network. A firewall can be a software program that you install on your computer, network, or both, or it can be a solution made up of both hardware and software.

There are two types of firewalls to consider:

- **Host-based firewalls**—Software that protects only the computer it is installed on.
- **Network-based firewalls**—Installed between your DSL or cable modem and your home network to protect all the computers on the network.

When a firewall is installed on a system, all data sent to and from the system is monitored and compared with a set of user-defined security criteria. Any data that does not meet those criteria is blocked.

Your computer or networking equipment may already have a firewall installed. If not, firewall software solutions are available.

 **NOTE:** Under some circumstances a firewall can block access to internet games, interfere with printer or file sharing on a network, or block authorized email attachments. To temporarily resolve the problem, disable the firewall, perform the task that you want to perform, and then reenable the firewall. To permanently resolve the problem, reconfigure the firewall.

Installing software updates

HP, Windows, and third-party software installed on your computer should be regularly updated to correct security problems and improve software performance.

To view or change the settings:

 **IMPORTANT:** Microsoft sends out alerts regarding Windows updates, which may include security updates. To protect the computer from security breaches and computer viruses, install all updates from Microsoft as soon as you receive an alert.

You can install these updates automatically.

1. Select the **Start** button, select **Settings**, and then select **Update & Security**.
2. Select **Windows Update**, and then follow the on-screen instructions.
3. To schedule a time for installing updates, select **Advanced Options**, and then follow the on-screen instructions.

Using HP Client Security (select products only)

HP Client Security software is preinstalled on your computer. You can access this software through the HP Client Security icon at the far right of the taskbar or Windows Control Panel. It provides security features that help protect against unauthorized access to the computer, networks, and critical data.

For more information, see the HP Client Security software Help.

Using HP Device as a Service (select products only)

HP DaaS is a cloud-based IT solution that enables businesses to effectively manage and secure their company assets.

HP DaaS helps protect devices against malware and other attacks, monitors device health, and helps reduce time spent solving device and security issues. You can quickly download and install the software, which is highly cost-effective relative to traditional in-house solutions. For more information, go to <https://www.hptouchpointmanager.com/>

Using an optional security cable (select products only)

A security cable (purchased separately) is designed to act as a deterrent, but it may not prevent the computer from being mishandled or stolen. To connect a security cable to your computer, follow the device manufacturer's instructions.

Using a fingerprint reader (select products only)

Integrated fingerprint readers are available on select products. To use the fingerprint reader, you must enroll your fingerprints in HP Client Security's Credential Manager. For more information, see the HP Client Security software Help.

After you enroll your fingerprints in Credential Manager, you can use HP Client Security's Password Manager to store and fill in your user names and passwords in supported websites and applications.

The fingerprint reader is a small metallic sensor that is located in one of the following areas of your computer:

- Near the bottom of the touchpad
- On the right side of the keyboard
- On the upper-right side of the display
- On the left side of the display
- On the back of the display

Depending on your product, the reader may be oriented horizontally or vertically.

8 Maintenance

Performing regular maintenance keeps your computer in optimal condition. This chapter explains how to use tools like Disk Defragmenter and Disk Cleanup. It also provides instructions for updating programs and drivers, steps to clean the computer, and tips for traveling with (or shipping) the computer.

Improving performance

You can improve the performance of your computer by performing regular maintenance tasks with tools such as Disk Defragmenter and Disk Cleanup.

Using Disk Defragmenter

HP recommends using Disk Defragmenter to defragment your hard drive at least once a month.

To run Disk Defragmenter:



NOTE: It is not necessary to run Disk Defragmenter on solid-state drives.

1. Connect the computer to AC power.
2. Type `defragment` in the taskbar search box, and then select **Defragment and Optimize Drives**.
3. Follow the on-screen instructions.

For additional information, access the Disk Defragmenter software Help.

Using Disk Cleanup

Use Disk Cleanup to search the hard drive for unnecessary files that you can safely delete to free up disk space and help the computer run more efficiently.

To run Disk Cleanup:

1. Type `disk` in the taskbar search box, and then select **Disk Cleanup**.
2. Follow the on-screen instructions.

Using HP 3D DriveGuard (select products only)

HP 3D DriveGuard protects a hard drive by parking the drive and halting data requests under some conditions.

- You drop the computer.
- You move the computer with the display closed while the computer is running on battery power.

A short time after one of these events, HP 3D DriveGuard returns the hard drive to normal operation.



NOTE: Only internal hard drives are protected by HP 3D DriveGuard. A hard drive installed in an optional docking device or connected to a USB port is not protected by HP 3D DriveGuard.



NOTE: Because solid-state drives (SSDs) lack moving parts, HP 3D DriveGuard is unnecessary for these drives.

Identifying HP 3D DriveGuard status

The hard drive light on the computer changes color to show that the drive in a primary hard drive bay, the secondary hard drive bay (select products only), or both are parked.

Updating programs and drivers

HP recommends that you update your programs and drivers regularly. Updates can resolve issues and provide new features and options. For example, older graphics components might not work well with the most recent gaming software. Without the latest driver, you do not get the most out of your equipment.

Go to <http://www.hp.com/support> to download the latest versions of HP programs and drivers. In addition, register to receive automatic notifications when updates become available.

To update your programs and drivers, follow these instructions:

1. Type `support` in the taskbar search box, and then select the **HP Support Assistant** app.
– or –
Select the question mark icon in the taskbar.
2. Select **My notebook**, select the **Updates** tab, and then select **Check for updates and messages**.
3. Follow the on-screen instructions.

Cleaning your computer

Cleaning your computer regularly removes dirt and debris so that your device continues to operate at its best. Use the following information to safely clean the external surfaces of your computer.

Enabling HP Easy Clean (select products only)

HP Easy Clean helps you to avoid accidental input while you clean the computer surfaces. This software disables devices such as the keyboard, touch screen, and touchpad for a preset amount of time so that you can clean all computer surfaces.

1. Start HP Easy Clean in one of the following ways:
 - Select the **Start** menu, and then select **HP Easy Clean**.
– or –
 - Select the **HP Easy Clean** icon in the taskbar.
– or –
 - Select **Start**, and then select the **HP Easy Clean** tile.
2. Now that your device is disabled for a short period, see [Removing dirt and debris from your computer on page 53](#) for the recommended steps to clean the high-touch, external surfaces on your computer. After you remove the dirt and debris, you can also clean the surfaces with a disinfectant. See [Cleaning your computer with a disinfectant on page 54](#) for guidelines to help prevent the spread of harmful bacteria and viruses.

Removing dirt and debris from your computer

Here are the recommended steps to clean dirt and debris from your computer.

For computers with wood veneer, see [Caring for wood veneer \(select products only\) on page 55](#).

1. Wear disposable gloves made of latex (or nitrile gloves, if you are latex-sensitive) when cleaning the surfaces.
2. Turn off your device and unplug the power cord and other connected external devices. Remove any installed batteries from items such as wireless keyboards.

 **CAUTION:** To prevent electric shock or damage to components, never clean a product while it is turned on or plugged in.

3. Moisten a microfiber cloth with water. The cloth should be moist, but not dripping wet.

 **IMPORTANT:** To avoid damaging the surface, avoid abrasive cloths, towels, and paper towels.

4. Wipe the exterior of the product gently with the moistened cloth.

 **IMPORTANT:** Keep liquids away from the product. Avoid getting moisture in any openings. If liquid makes its way inside your HP product, it can cause damage to the product. Do not spray liquids directly on the product. Do not use aerosol sprays, solvents, abrasives, or cleaners containing hydrogen peroxide or bleach that might damage the finish.

5. Start with the display (if applicable). Wipe carefully in one direction, and move from the top of the display to the bottom. Finish with any flexible cables, like power cord, keyboard cable, and USB cables.
6. Be sure that surfaces have completely air-dried before turning the device on after cleaning.
7. Discard the gloves after each cleaning. Clean your hands immediately after you remove the gloves.

See [Cleaning your computer with a disinfectant on page 54](#) for recommended steps to clean the high-touch, external surfaces on your computer to help prevent the spread of harmful bacteria and viruses.

Cleaning your computer with a disinfectant

The World Health Organization (WHO) recommends cleaning surfaces, followed by disinfection, as a best practice for preventing the spread of viral respiratory illnesses and harmful bacteria.

After cleaning the external surfaces of your computer using the steps in [Removing dirt and debris from your computer on page 53](#), [Caring for wood veneer \(select products only\) on page 55](#), or both, you might also choose to clean the surfaces with a disinfectant. A disinfectant that is within HP's cleaning guidelines is an alcohol solution consisting of 70% isopropyl alcohol and 30% water. This solution is also known as rubbing alcohol and is sold in most stores.

Follow these steps when disinfecting high-touch, external surfaces on your computer:

1. Wear disposable gloves made of latex (or nitrile gloves, if you are latex-sensitive) when cleaning the surfaces.
2. Turn off your device and unplug the power cord and other connected external devices. Remove any installed batteries from items such as wireless keyboards.

 **CAUTION:** To prevent electric shock or damage to components, never clean a product while it is turned on or plugged in.

3. Moisten a microfiber cloth with a mixture of 70% isopropyl alcohol and 30% water. The cloth should be moist, but not dripping wet.

 **CAUTION:** Do not use any of the following chemicals or any solutions that contain them, including spray-based surface cleaners: bleach, peroxides (including hydrogen peroxide), acetone, ammonia, ethyl alcohol, methylene chloride, or any petroleum-based materials, such as gasoline, paint thinner, benzene, or toluene.

 **IMPORTANT:** To avoid damaging the surface, avoid abrasive cloths, towels, and paper towels.

4. Wipe the exterior of the product gently with the moistened cloth.

 **IMPORTANT:** Keep liquids away from the product. Avoid getting moisture in any openings. If liquid makes its way inside your HP product, it can cause damage to the product. Do not spray liquids directly on the product. Do not use aerosol sprays, solvents, abrasives, or cleaners containing hydrogen peroxide or bleach that might damage the finish.

5. Start with the display (if applicable). Wipe carefully in one direction, and move from the top of the display to the bottom. Finish with any flexible cables, like power cord, keyboard cable, and USB cables.
6. Be sure that surfaces have completely air-dried before turning the device on after cleaning.
7. Discard the gloves after each cleaning. Clean your hands immediately after you remove the gloves.

Caring for wood veneer (select products only)

Your product might feature high-quality wood veneer. As with all natural wood products, proper care is important for best results over the life of the product. Because of the nature of natural wood, you might see unique variations in the grain pattern or subtle variations in color, which are normal.

- Clean the wood with a dry, static-free microfiber cloth or chamois.
- Avoid cleaning products containing substances such as ammonia, methylene chloride, acetone, turpentine, or other petroleum-based solvents.
- Do not expose the wood to sun or moisture for long periods of time.
- If the wood becomes wet, dry it by dabbing with an absorbent, lint-free cloth.
- Avoid contact with any substance that might dye or discolor the wood.
- Avoid contact with sharp objects or rough surfaces that might scratch the wood.

See [Removing dirt and debris from your computer on page 53](#) for the recommended steps to clean the high-touch, external surfaces on your computer. After you remove the dirt and debris, you can also clean the surfaces with a disinfectant. See [Cleaning your computer with a disinfectant on page 54](#) for sanitizing guidelines to help prevent the spread of harmful bacteria and viruses.

Traveling with or shipping your computer

If you must travel with or ship your computer, follow these tips to keep your equipment safe.

- Prepare the computer for traveling or shipping:
 - Back up your information to an external drive.
 - Remove all discs and all external media cards, such as memory cards.
 - Turn off and then disconnect all external devices.
 - Shut down the computer.
- Take a backup of your information. Keep the backup separate from the computer.
- When traveling by air, carry the computer as hand luggage; do not check it in with the rest of your luggage.



IMPORTANT: Avoid exposing a drive to magnetic fields. Security devices with magnetic fields include airport walk-through devices and security wands. Airport conveyer belts and similar security devices that check carry-on baggage use X-rays instead of magnetism and do not damage drives.

- If you plan to use the computer during a flight, listen for the in-flight announcement that tells you when you can use your computer. In-flight computer use is at the discretion of the airline.
- If you are shipping the computer or a drive, use suitable protective packaging and label the package “FRAGILE.”
- The use of wireless devices might be restricted in some environments. Such restrictions might apply aboard aircraft, in hospitals, near explosives, and in hazardous locations. If you are uncertain of the policy that applies to the use of a wireless device in your computer, ask for authorization to use your computer before you turn it on.
- If you are traveling internationally, follow these suggestions:
 - Check the computer-related customs regulations for each country or region on your itinerary.
 - Check the power cord and adapter requirements for each location in which you plan to use the computer. Voltage, frequency, and plug configurations vary.



WARNING! To reduce the risk of electric shock, fire, or damage to the equipment, do not attempt to run the computer with a voltage converter kit that is sold for appliances.

9 Backing up, restoring, and recovering

You can use Windows tools or HP software to back up your information, create a restore point, reset your computer, create recovery media, or restore your computer to its factory state. Performing these standard procedures can return your computer to a working state faster.

 **IMPORTANT:** If you will be performing recovery procedures on a tablet, the tablet battery must be at least 70% charged before you start the recovery process.

IMPORTANT: For a tablet with a detachable keyboard, connect the tablet to the keyboard base before beginning any recovery process.

Backing up information and creating recovery media

These methods of creating recovery media and backups are available on select products only.

Using Windows tools for backing up

HP recommends that you back up your information immediately after initial setup. You can do this task either using Windows Backup locally with an external USB drive or using online tools.

 **IMPORTANT:** Windows is the only option that allows you to back up your personal information. Schedule regular backups to avoid information loss.

 **NOTE:** If computer storage is 32 GB or less, Microsoft System Restore is disabled by default.

Using the HP Cloud Recovery Download Tool to create recovery media (select products only)

You can use the HP Cloud Recovery Download Tool to create HP Recovery media on a bootable USB flash drive.

For details:

- ▲ Go to <http://www.hp.com/support>, search for HP Cloud Recovery, and then select the result that matches the type of computer that you have.

 **NOTE:** If you cannot create recovery media yourself, contact support to obtain recovery discs. Go to <http://www.hp.com/support>, select your country or region, and then follow the on-screen instructions.

 **IMPORTANT:** HP recommends that you follow the [Restoring and recovery methods on page 58](#) to restore your computer before you obtain and use the HP recovery discs. Using a recent backup can return your machine to a working state sooner than using the HP recovery discs. After the system is restored, reinstalling all the operating system software released since your initial purchase can be a lengthy process.

Restoring and recovering your system

You have several tools available to recover your system both within and outside of Windows if the desktop cannot load.

HP recommends that you attempt to restore your system using the [Restoring and recovery methods on page 58](#).

Creating a system restore

System Restore is available in Windows. The System Restore software can automatically or manually create restore points, or snapshots, of the system files and settings on the computer at a particular point.

When you use System Restore, it returns your computer to its state at the time you made the restore point. Your personal files and documents should not be affected.

Restoring and recovery methods

After you run the first method, test to see whether the issue still exists before you proceed to the next method, which might now be unnecessary.

1. Run a Microsoft System Restore.
2. Run Reset this PC.
3. Recover using HP Recovery media. For more information, see [Recovering using HP Recovery media on page 58](#).

For more information about the first two methods, see the Get Help app:

Select the **Start** button, select the **Get Help** app, and then enter the task you want to perform.



NOTE: You must be connected to the internet to access the Get Help app.

Recovering using HP Recovery media

You can use HP Recovery media to recover the original operating system and software programs that were installed at the factory. On select products, it can be created on a bootable USB flash drive using the HP Cloud Recovery Download Tool.

For details, see [Using the HP Cloud Recovery Download Tool to create recovery media \(select products only\) on page 57](#).



NOTE: If you cannot create recovery media yourself, contact support to obtain recovery discs. Go to <http://www.hp.com/support>, select your country or region, and then follow the on-screen instructions.

To recover your system:

- ▲ Insert the HP Recovery media, and then restart the computer.



NOTE: HP recommends that you follow the [Restoring and recovery methods on page 58](#) to restore your computer before you obtain and use the HP recovery discs. Using a recent backup can return your machine to a working state sooner than using the HP recovery discs. After the system is restored, reinstalling all the operating system software released since your initial purchase can be a lengthy process.

Changing the computer boot order

If your computer does not restart using the HP Recovery media, you can change the computer boot order, the order of devices listed in BIOS for startup information. You can select an optical drive or a USB flash drive, depending on the location of your HP Recovery media.



IMPORTANT: For a tablet with a detachable keyboard, connect the tablet to the keyboard base before beginning these steps.

To change the boot order:

1. Insert the HP Recovery media.
2. Access the system **Startup** menu.
 - For computers or tablets with keyboards attached, turn on or restart the computer or tablet, quickly press **esc**, and then press **f9** for boot options.
 - For tablets without keyboards, turn on or restart the tablet, quickly press and hold the volume up button, and then select **f9**.
– or –
Turn on or restart the tablet, quickly press and hold the volume down button, and then select **f9**.
3. Select the optical drive or USB flash drive from which you want to boot, and then follow the on-screen instructions.

Using HP Sure Recover (select products only)

Select computer models are configured with HP Sure Recover, a PC OS recovery solution built into the hardware and software. HP Sure Recover can fully restore the HP OS image without installed recovery software.

Using HP Sure Recover, an administrator or user can restore the system and install:

- Latest version of the operating system
- Platform-specific device drivers
- Software applications, in the case of a custom image

To access the latest documentation for HP Sure Recover, go to <http://www.hp.com/support>. Follow the on-screen instructions to find your product and locate your documentation.

10 Computer Setup (BIOS), TPM, and HP Sure Start

HP provides several tools to help set up and protect your computer.

Using Computer Setup

Computer Setup, or Basic Input/Output System (BIOS), controls communication between all the input and output devices on the system (such as hard drives, display, keyboard, mouse, and printer). Computer Setup includes settings for types of devices installed, the startup sequence of the computer, and amount of system and extended memory.

 **NOTE:** Use extreme care when making changes in Computer Setup. Errors can prevent the computer from operating properly.

To start Computer Setup, turn on or restart the computer, and when the HP logo appears, press **f10** to enter Computer Setup.

Navigating and selecting in Computer Setup

You can navigate and select in Computer Setup using one or more methods.

- To select a menu or a menu item, use the **tab** key and the keyboard arrow keys and then press **enter**, or use a pointing device to select the item.
- To scroll up and down, select the up arrow or the down arrow in the upper-right corner of the screen, or use the up arrow key or the down arrow key on the keyboard.
- To close open dialog boxes and return to the main Computer Setup screen, press **esc**, and then follow the on-screen instructions.

To exit Computer Setup, choose one of the following methods:

- To exit Computer Setup menus without saving your changes, select **Main**, select **Ignore Changes and Exit**, and then select **Yes**.

 **NOTE:** If you are using arrow keys to highlight your choice, you must then press **enter**.

- To save your changes and exit Computer Setup menus, select **Main**, select **Save Changes and Exit**, and then select **Yes**.

 **NOTE:** If you are using arrow keys to highlight your choice, you must then press **enter**.

Your changes go into effect when the computer restarts.

Restoring factory settings in Computer Setup

To return all settings in Computer Setup to the values that were set at the factory, follow these steps.

 **NOTE:** Restoring defaults will not change the hard drive mode.

1. Start Computer Setup. See [Using Computer Setup on page 60](#).
2. Select **Main**, select **Apply Factory Defaults and Exit**, and then select **Yes**.

 **NOTE:** If you are using arrow keys to highlight your choice, you must then press [enter](#).

 **NOTE:** On select products, the selections might display **Restore Defaults** instead of **Apply Factory Defaults and Exit**.

Your changes go into effect when the computer restarts.

 **NOTE:** Your password settings and security settings are not changed when you restore the factory settings.

Updating the BIOS

Updated versions of the BIOS might be available on the HP website. Most BIOS updates on the HP website are packaged in compressed files called *SoftPaqs*.

Some download packages contain a file named Readme.txt, which contains information regarding installing and troubleshooting the file.

Determining the BIOS version

To decide whether you need to update Computer Setup (BIOS), first determine the BIOS version on your computer.

You can access BIOS version information (also known as *ROM date* and *System BIOS*) by pressing [fn+esc](#) (if you are already in Windows) or by using Computer Setup.

1. Start Computer Setup. See [Using Computer Setup on page 60](#).
2. Select **Main**, and then select **System Information**.
3. To exit Computer Setup menus without saving your changes, select **Main**, select **Ignore Changes and Exit**, and then select **Yes**.

 **NOTE:** If you are using arrow keys to highlight your choice, you must then press [enter](#).

To check for later BIOS versions, see [Preparing for a BIOS update on page 61](#).

Preparing for a BIOS update

Be sure to follow all prerequisites before downloading and installing a BIOS update.

 **IMPORTANT:** To reduce the risk of damage to the computer or an unsuccessful installation, download and install a BIOS update only when the computer is connected to reliable external power using the AC adapter. Do not download or install a BIOS update while the computer is running on battery power, docked in an optional docking device, or connected to an optional power source. During the download and installation, follow these instructions:

Do not disconnect power on the computer by unplugging the power cord from the AC outlet.

Do not shut down the computer or initiate Sleep.

Do not insert, remove, connect, or disconnect any device, cable, or cord.

Downloading a BIOS update

After you review the prerequisites, you can check for and download BIOS updates.

1. Type `support` in the taskbar search box, and then select the HP Support Assistant app.
– or –
Select the question mark icon in the taskbar.
2. Select **Updates**, and then select **Check for updates and messages**.
3. Follow the on-screen instructions.
4. At the download area, follow these steps:
 - a. Identify the most recent BIOS update and compare it to the BIOS version currently installed on your computer. Make a note of the date, name, or other identifier. You might need this information to locate the update later, after it has been downloaded to your hard drive.
 - b. Follow the on-screen instructions to download your selection to the hard drive.

Make a note of the path to the location on your hard drive where the BIOS update is downloaded. You will need to access this path when you are ready to install the update.

 **NOTE:** If you connect your computer to a network, consult the network administrator before installing any software updates, especially system BIOS updates.

Installing a BIOS update

BIOS installation procedures vary. Follow any instructions that are displayed on the screen after the download is complete. If no instructions are displayed, follow these steps.

1. Type `file` in the taskbar search box, and then select **File Explorer**.
2. Select your hard drive designation. The hard drive designation is typically Local Disk (C:).
3. Using the hard drive path you recorded earlier, open the folder that contains the update.
4. Double-click the file that has an `.exe` extension (for example, `filename.exe`).

The BIOS installation begins.
5. Complete the installation by following the on-screen instructions.

 **NOTE:** After a message on the screen reports a successful installation, you can delete the downloaded file from your hard drive.

Changing the boot order using the f9 prompt

To dynamically choose a boot device for the current startup sequence, follow these steps.

1. Access the Boot Device Options menu:
 - Turn on or restart the computer, and when the HP logo appears, press **f9** to enter the Boot Device Options menu.
2. Select a boot device, press `enter`, and then follow the on-screen instructions.

TPM BIOS settings (select products only)

TPM provides additional security for your computer. You can modify the TPM settings in Computer Setup (BIOS).

 **IMPORTANT:** Before enabling Trusted Platform Module (TPM) functionality on this system, you must ensure that your intended use of TPM complies with relevant local laws, regulations and policies, and approvals or licenses must be obtained if applicable. For any compliance issues arising from your operation or usage of TPM that violates the previously mentioned requirement, you shall bear all the liabilities wholly and solely. HP will not be responsible for any related liabilities.

 **NOTE:** If you change the TPM setting to Hidden, TPM is not visible in the operating system.

To access TPM settings in Computer Setup:

1. Start Computer Setup. See [Using Computer Setup on page 60](#).
2. Select **Security**, select **TPM Embedded Security**, and then follow the on-screen instructions.

Using HP Sure Start (select products only)

Select computer models are configured with HP Sure Start, a technology that monitors the computer's BIOS for attacks or corruption. If the BIOS becomes corrupted or is attacked, HP Sure Start automatically restores the BIOS to its previously safe state, without user intervention.

HP Sure Start is configured and already enabled so that most users can use the HP Sure Start default configuration. Advanced users can customize the default configuration.

To access the latest documentation on HP Sure Start, go to <http://www.hp.com/support>. Select **Find your product**, and then follow the on-screen instructions.

11 Using HP PC Hardware Diagnostics

You can use the HP PC Hardware Diagnostics utility to determine whether your computer hardware is running properly. The three versions are HP PC Hardware Diagnostics Windows, HP PC Hardware Diagnostics UEFI (Unified Extensible Firmware Interface), and (for select products only) Remote HP PC Hardware Diagnostics UEFI, a firmware feature.

Using HP PC Hardware Diagnostics Windows (select products only)

HP PC Hardware Diagnostics Windows is a Windows-based utility that allows you to run diagnostic tests to determine whether the computer hardware is functioning properly. The tool runs within the Windows operating system to diagnose hardware failures.

If HP PC Hardware Diagnostics Windows is not installed on your computer, first you must download and install it. To download HP PC Hardware Diagnostics Windows, see [Downloading HP PC Hardware Diagnostics Windows on page 65](#).

Using an HP PC Hardware Diagnostics Windows hardware failure ID code

When HP PC Hardware Diagnostics Windows detects a failure that requires hardware replacement, a 24-digit Failure ID code is generated.

- ▲ Depending on the instructions on the screen, choose one of these options:
 - If failure ID link is displayed, select the link and follow the on-screen instructions.
 - If instructions for calling support are displayed. Follow those instructions.

Accessing HP PC Hardware Diagnostics Windows

After HP PC Hardware Diagnostics Windows is installed, you can access it from HP Help and Support or HP Support Assistant.

Accessing HP PC Hardware Diagnostics Windows from HP Help and Support

After HP PC Hardware Diagnostics Windows is installed, follow these steps to access it from HP Help and Support.

To access HP PC Hardware Diagnostics Windows from HP Help and Support:

1. Select the **Start** button, and then select **HP Help and Support**.
2. Select **HP PC Hardware Diagnostics Windows**.
3. When the tool opens, select the type of diagnostic test that you want to run, and then follow the on-screen instructions.



NOTE: To stop a diagnostic test, select **Cancel**.

Accessing HP PC Hardware Diagnostics Windows from Support Assistant

After HP PC Hardware Diagnostics Windows is installed, follow these steps to access it from HP Support Assistant.

To access HP PC Hardware Diagnostics Windows from HP Support Assistant:

1. Type `support` in the taskbar search box, and then select the **HP Support Assistant** app.
– or –
Select the question mark icon in the taskbar.
2. Select **Troubleshooting and fixes**.
3. Select **Diagnostics**, and then select **HP PC Hardware Diagnostics Windows**.
4. When the tool opens, select the type of diagnostic test that you want to run, and then follow the on-screen instructions.



NOTE: To stop a diagnostic test, select **Cancel**.

Downloading HP PC Hardware Diagnostics Windows

The HP PC Hardware Diagnostics Windows downloading instructions are provided in English only. You must use a Windows computer to download this tool because only .exe files are provided.

Downloading the latest HP PC Hardware Diagnostics Windows version from HP

To download HP PC Hardware Diagnostics Windows from HP, follow these steps.

1. Go to <http://www.hp.com/go/techcenter/pcdiags>. The HP PC Diagnostics home page is displayed.
2. Select **Download HP Diagnostics Windows**, and then select a location on your computer or a USB flash drive.

The tool downloads to the selected location.

Downloading the HP PC Hardware Diagnostics Windows from the Microsoft Store

You can download the HP PC Hardware Diagnostics Windows from the Microsoft Store.

1. Select the Microsoft Store app on your desktop or enter `Microsoft Store` in the taskbar search box.
2. Enter `HP PC Hardware Diagnostics Windows` in the **Microsoft Store** search box.
3. Follow the on-screen directions.

The tool downloads to the selected location.

Downloading HP Hardware Diagnostics Windows by product name or number (select products only)

You can download HP PC Hardware Diagnostics Windows by product name or number.



NOTE: For some products, you might have to download the software to a USB flash drive by using the product name or number.

1. Go to <http://www.hp.com/support>.
2. Select **Software and Drivers**, select your type of product, and then enter the product name or number in the search box that is displayed.
3. In the **Diagnostics** section, select **Download**, and then follow the on-screen instructions to select the specific Windows diagnostics version to be downloaded to your computer or USB flash drive.

The tool downloads to the selected location.

Installing HP PC Hardware Diagnostics Windows

To install HP PC Hardware Diagnostics Windows, navigate to the folder on your computer or the USB flash drive where the .exe file downloaded, double-click the .exe file, and then follow the on-screen instructions.

Using HP PC Hardware Diagnostics UEFI

HP PC Hardware Diagnostics UEFI (Unified Extensible Firmware Interface) allows you to run diagnostic tests to determine whether the computer hardware is functioning properly. The tool runs outside the operating system so that it can isolate hardware failures from issues that are caused by the operating system or other software components.



NOTE: For Windows 10 S computers, you must use a Windows computer and a USB flash drive to download and create the HP UEFI support environment because only .exe files are provided. For more information, see [Downloading HP PC Hardware Diagnostics UEFI to a USB flash drive on page 67](#).

If your PC does not start in Windows, you can use HP PC Hardware Diagnostics UEFI to diagnose hardware issues.

Using an HP PC Hardware Diagnostics UEFI hardware failure ID code

When HP PC Hardware Diagnostics UEFI detects a failure that requires hardware replacement, a 24-digit Failure ID code is generated.

For assistance in solving the problem:

- ▲ Select **Contact HP**, accept the HP privacy disclaimer, and then use a mobile device to scan the Failure ID code that appears on the next screen. The HP Customer Support - Service Center page appears with your Failure ID and product number automatically filled in. Follow the on-screen instructions.

– or –

Contact support, and provide the Failure ID code.



NOTE: To start diagnostics on a convertible computer, your computer must be in notebook mode, and you must use the attached keyboard.



NOTE: If you need to stop a diagnostic test, press `esc`.

Starting HP PC Hardware Diagnostics UEFI

To start HP PC Hardware Diagnostics UEFI, follow this procedure.

1. Turn on or restart the computer, and quickly press `esc`.
2. Press `f2`.

The BIOS searches three places for the diagnostic tools, in the following order:

- a. Connected USB flash drive
-
-  **NOTE:** To download the HP PC Hardware Diagnostics UEFI tool to a USB flash drive, see [Downloading the latest HP PC Hardware Diagnostics UEFI version on page 67](#).
-
- b. Hard drive
 - c. BIOS
3. When the diagnostic tool opens, select a language, select the type of diagnostic test you want to run, and then follow the on-screen instructions.

Downloading HP PC Hardware Diagnostics UEFI to a USB flash drive

Downloading HP PC Hardware Diagnostics UEFI to a USB flash drive can be useful in some situations.

- HP PC Hardware Diagnostics UEFI is not included in the preinstallation image.
- HP PC Hardware Diagnostics UEFI is not included in the HP Tool partition.
- The hard drive is damaged.

 **NOTE:** The HP PC Hardware Diagnostics UEFI downloading instructions are provided in English only, and you must use a Windows computer to download and create the HP UEFI support environment because only .exe files are provided.

Downloading the latest HP PC Hardware Diagnostics UEFI version

To download the latest HP PC Hardware Diagnostics UEFI version to a USB flash drive, follow this procedure.

1. Go to <http://www.hp.com/go/techcenter/pcdiags>. The HP PC Diagnostics home page is displayed.
2. Select **Download HP Diagnostics UEFI**, and then select **Run**.

Downloading HP PC Hardware Diagnostics UEFI by product name or number (select products only)

You can download HP PC Hardware Diagnostics UEFI by product name or number (select products only) to a USB flash drive.

 **NOTE:** For some products, you might have to download the software to a USB flash drive by using the product name or number.

1. Go to <http://www.hp.com/support>.
2. Enter the product name or number, select your computer, and then select your operating system.
3. In the **Diagnostics** section, follow the on-screen instructions to select and download the specific UEFI Diagnostics version for your computer.

Using Remote HP PC Hardware Diagnostics UEFI settings (select products only)

Remote HP PC Hardware Diagnostics UEFI is a firmware (BIOS) feature that downloads HP PC Hardware Diagnostics UEFI to your computer. It can then execute the diagnostics on your computer, and it might upload results to a preconfigured server.

For more information about Remote HP PC Hardware Diagnostics UEFI, go to <http://www.hp.com/go/techcenter/pcdiags>, and then select **Find out more**.

Downloading Remote HP PC Hardware Diagnostics UEFI

HP Remote PC Hardware Diagnostics UEFI is also available as a SoftPaq that you can download to a server.

Downloading the latest Remote HP PC Hardware Diagnostics UEFI version

You can download the latest HP PC Hardware Diagnostics UEFI version to a USB flash drive.

1. Go to <http://www.hp.com/go/techcenter/pcdiags>. The HP PC Diagnostics home page is displayed.
2. Select **Download Remote Diagnostics**, and then select **Run**.

Downloading Remote HP PC Hardware Diagnostics UEFI by product name or number

You can download HP Remote PC Hardware Diagnostics UEFI by product name or number.

 **NOTE:** For some products, you might have to download the software by using the product name or number.

1. Go to <http://www.hp.com/support>.
2. Select **Software and Drivers**, select your type of product, enter the product name or number in the search box that is displayed, select your computer, and then select your operating system.
3. In the **Diagnostics** section, follow the on-screen instructions to select and download the **Remote UEFI** version for the product.

Customizing Remote HP PC Hardware Diagnostics UEFI settings

Using the Remote HP PC Hardware Diagnostics setting in Computer Setup (BIOS), you can perform several customizations.

- Set a schedule for running diagnostics unattended. You can also start diagnostics immediately in interactive mode by selecting **Execute Remote HP PC Hardware Diagnostics**.
- Set the location for downloading the diagnostic tools. This feature provides access to the tools from the HP website or from a server that has been preconfigured for use. Your computer does not require the traditional local storage (such as a hard drive or USB flash drive) to run remote diagnostics.
- Set a location for storing the test results. You can also set the user name and password that you use for uploads.
- Display status information about the diagnostics run previously.

To customize Remote HP PC Hardware Diagnostics UEFI settings, follow these steps:

1. Turn on or restart the computer, and when the HP logo appears, press **f10** to enter Computer Setup.
2. Select **Advanced**, and then select **Settings**.
3. Make your customization selections.
4. Select **Main**, and then **Save Changes and Exit** to save your settings.

Your changes take effect when the computer restarts.

12 Specifications

When you travel with or store your computer, the input power ratings and operating specifications provide helpful information.

Input power

The power information in this section might be helpful if you plan to travel internationally with the computer.

The computer operates on DC power, which can be supplied by an AC or a DC power source. The AC power source must be rated at 100 V–240 V, 50 Hz–60 Hz. Although the computer can be powered from a standalone DC power source, it should be powered only with an AC adapter or a DC power source supplied and approved by HP for use with this computer.

The computer can operate on DC power within one or more of the following specifications. The voltage and current for your computer is located on the regulatory label.

Table 12-1 DC power specifications

Input Power	Rating
Operating voltage and current	5 V dc @ 2 A / 12 V dc @ 3 A / 15 V dc @ 3 A – 45 W USB-C®
	5 V dc @ 3 A / 9 V dc @ 3 A / 12 V dc @ 3.75 A / 15 V dc @ 3 A – 45 W USB-C
	5 V dc @ 3 A / 9 V dc @ 3 A / 10 V dc @ 3.75 A / 12 V dc @ 3.75 A / 15 V dc @ 3 A / 20 V dc @ 2.25 A – 45 W USB-C
	5 V dc @ 3 A / 9 V dc @ 3 A / 12 V dc @ 5 A / 15 V dc @ 4.33 A / 20 V dc @ 3.25 A – 65 W USB-C
	5 V dc @ 3 A / 9 V dc @ 3 A / 10 V dc @ 5 A / 12 V dc @ 5 A / 15 V dc @ 4.33 A / 20 V dc @ 3.25 A – 65 W USB-C
	5 V dc @ 3 A / 9 V dc @ 3 A / 10 V dc @ 5 A / 12 V dc @ 5 A / 15 V dc @ 5 A / 20 V dc @ 4.5 A – 90 W USB-C
	19.5 V dc @ 2.31 A – 45 W
	19.5 V dc @ 3.33 A – 65 W
	19.5 V dc @ 4.62 A – 90 W
	19.5 V dc @ 6.15 A – 120 W
	19.5 V dc @ 6.9 A – 135 W
	19.5 V dc @ 7.70 A – 150 W

 **NOTE:** This product is designed for IT power systems in Norway with phase-to-phase voltage not exceeding 240 V rms.

Operating environment

Use the operating specifications for helpful information when you travel with or store your computer.

Table 12-2 Operating environment specifications

Factor	Metric	U.S.
Temperature		
Operating (writing to optical disc)	5°C to 35°C	41°F to 95°F
Nonoperating	-20°C to 60°C	-4°F to 140°F
Relative humidity (noncondensing)		
Operating	10% to 90%	10% to 90%
Nonoperating	5% to 95%	5% to 95%
Maximum altitude (unpressurized)		
Operating	-15 m to 3,048 m	-50 ft to 10,000 ft
Nonoperating	-15 m to 12,192 m	-50 ft to 40,000 ft

13 Electrostatic discharge

Electrostatic discharge is the release of static electricity when two objects come into contact—for example, the shock you receive when you walk across the carpet and touch a metal door knob.

A discharge of static electricity from fingers or other electrostatic conductors may damage electronic components.



IMPORTANT: To prevent damage to the computer, damage to a drive, or loss of information, observe these precautions:

- If removal or installation instructions direct you to unplug the computer, first be sure that it is properly grounded.
 - Keep components in their electrostatic-safe containers until you are ready to install them.
 - Avoid touching pins, leads, and circuitry. Handle electronic components as little as possible.
 - Use nonmagnetic tools.
 - Before handling components, discharge static electricity by touching an unpainted metal surface.
 - If you remove a component, place it in an electrostatic-safe container.
-

14 Accessibility

HP's goal is to design, produce, and market products, services, and information that everyone everywhere can use, either on a stand-alone basis or with appropriate third-party assistive technology (AT) devices or applications.

HP and accessibility

Because HP works to weave diversity, inclusion, and work/life into the fabric of the company, it is reflected in everything HP does. HP strives to create an inclusive environment focused on connecting people to the power of technology throughout the world.

Finding the technology tools you need

Technology can unleash your human potential. Assistive technology removes barriers and helps you create independence at home, at work, and in the community. Assistive technology helps increase, maintain, and improve the functional capabilities of electronic and information technology.

For more information, see [Finding the best assistive technology on page 73](#).

The HP commitment

HP is committed to providing products and services that are accessible for people with disabilities. This commitment supports the company's diversity objectives and helps ensure that the benefits of technology are available to all.

The HP accessibility goal is to design, produce, and market products and services that can be effectively used by everyone, including people with disabilities, either on a stand-alone basis or with appropriate assistive devices.

To achieve that goal, this Accessibility Policy establishes seven key objectives to guide HP actions. All HP managers and employees are expected to support these objectives and their implementation in accordance with their roles and responsibilities:

- Raise the level of awareness of accessibility issues within HP, and provide employees with the training they need to design, produce, market, and deliver accessible products and services.
- Develop accessibility guidelines for products and services, and hold product development groups accountable for implementing these guidelines where competitively, technically, and economically feasible.
- Involve people with disabilities in the development of accessibility guidelines and in the design and testing of products and services.
- Document accessibility features, and make information about HP products and services publicly available in an accessible form.
- Establish relationships with leading assistive technology and solution providers.
- Support internal and external research and development that improves assistive technology relevant to HP products and services.
- Support and contribute to industry standards and guidelines for accessibility.

International Association of Accessibility Professionals (IAAP)

IAAP is a not-for-profit association focused on advancing the accessibility profession through networking, education, and certification. The objective is to help accessibility professionals develop and advance their careers and to better enable organizations to integrate accessibility into their products and infrastructure.

As a founding member, HP joined to participate with other organizations to advance the field of accessibility. This commitment supports HP's accessibility goal of designing, producing, and marketing products and services that people with disabilities can effectively use.

IAAP will make the profession strong by globally connecting individuals, students, and organizations to learn from one another. If you are interested in learning more, go to <http://www.accessibilityassociation.org> to join the online community, sign up for newsletters, and learn about membership options.

Finding the best assistive technology

Everyone, including people with disabilities or age-related limitations, should be able to communicate, express themselves, and connect with the world using technology. HP is committed to increasing accessibility awareness within HP and with our customers and partners.

Whether it's large fonts that are easy on the eyes, voice recognition that lets you give your hands a rest, or any other assistive technology to help with your specific situation—a variety of assistive technologies make HP products easier to use. How do you choose?

Assessing your needs

Technology can unleash your potential. Assistive technology removes barriers and helps you create independence at home, at work, and in the community. Assistive technology (AT) helps increase, maintain, and improve the functional capabilities of electronic and information technology.

You can choose from many AT products. Your AT assessment should allow you to evaluate several products, answer your questions, and facilitate your selection of the best solution for your situation. You will find that professionals qualified to do AT assessments come from many fields, including those licensed or certified in physical therapy, occupational therapy, speech/language pathology, and other areas of expertise. Others, while not certified or licensed, can also provide evaluation information. You will want to ask about the individual's experience, expertise, and fees to determine if they are appropriate for your needs.

Accessibility for HP products

These links provide information about accessibility features and assistive technology, if applicable, included in various HP products. These resources will help you select the specific assistive technology features and products most appropriate for your situation.

- [HP Elite x3–Accessibility Options \(Windows 10 Mobile\)](#)
- [HP PCs–Windows 7 Accessibility Options](#)
- [HP PCs–Windows 8 Accessibility Options](#)
- [HP PC's–Windows 10 Accessibility Options](#)
- [HP Slate 7 Tablets–Enabling Accessibility Features on Your HP Tablet \(Android 4.1/Jelly Bean\)](#)
- [HP SlateBook PCs–Enabling Accessibility Features \(Android 4.3,4.2/Jelly Bean\)](#)
- [HP Chromebook PCs–Enabling Accessibility Features on Your HP Chromebook or Chromebox \(Chrome OS\)](#)
- [HP Shopping–peripherals for HP products](#)

If you need additional support with the accessibility features on your HP product, see [Contacting support on page 76](#).

Additional links to external partners and suppliers that may provide additional assistance:

- [Microsoft Accessibility information \(Windows 7, Windows 8, Windows 10, Microsoft Office\)](#)
- [Google Products accessibility information \(Android, Chrome, Google Apps\)](#)
- [Assistive Technologies sorted by impairment type](#)
- [Assistive Technology Industry Association \(ATIA\)](#)

Standards and legislation

Countries worldwide are enacting regulations to improve access to products and services for persons with disabilities. These regulations are historically applicable to telecommunications products and services, PCs and printers with certain communications and video playback features, their associated user documentation, and their customer support.

Standards

The US Access Board created Section 508 of the Federal Acquisition Regulation (FAR) standards to address access to information and communication technology (ICT) for people with physical, sensory, or cognitive disabilities.

The standards contain technical criteria specific to various types of technologies, as well as performance-based requirements which focus on functional capabilities of covered products. Specific criteria cover software applications and operating systems, web-based information and applications, computers, telecommunications products, video and multimedia, and self-contained closed products.

Mandate 376 – EN 301 549

The European Union created the EN 301 549 standard within Mandate 376 as an online toolkit for public procurement of ICT products. The standard specifies the accessibility requirements applicable to ICT products and services, with a description of the test procedures and evaluation methodology for each requirement.

Web Content Accessibility Guidelines (WCAG)

Web Content Accessibility Guidelines (WCAG) from the W3C's Web Accessibility Initiative (WAI) helps web designers and developers create sites that better meet the needs of people with disabilities or age-related limitations.

WCAG advances accessibility across the full range of web content (text, images, audio, and video) and web applications. WCAG can be precisely tested, is easy to understand and use, and allows web developers flexibility for innovation. WCAG 2.0 has also been approved as [ISO/IEC 40500:2012](#).

WCAG specifically addresses barriers to accessing the web experienced by people with visual, auditory, physical, cognitive, and neurological disabilities, and by older web users with accessibility needs. WCAG 2.0 provides characteristics of accessible content:

- **Perceivable** (for instance, by addressing text alternatives for images, captions for audio, adaptability of presentation, and color contrast)
- **Operable** (by addressing keyboard access, color contrast, timing of input, seizure avoidance, and navigability)

- **Understandable** (by addressing readability, predictability, and input assistance)
- **Robust** (for instance, by addressing compatibility with assistive technologies)

Legislation and regulations

Accessibility of IT and information has become an area of increasing legislative importance. These links provide information about key legislation, regulations, and standards.

- [United States](#)
- [Canada](#)
- [Europe](#)
- [Australia](#)
- [Worldwide](#)

Useful accessibility resources and links

These organizations, institutions, and resources might be good sources of information about disabilities and age-related limitations.



NOTE: This is not an exhaustive list. These organizations are provided for informational purposes only. HP assumes no responsibility for information or contacts you encounter on the Internet. Listing on this page does not imply endorsement by HP.

Organizations

These organizations are a few of the many that provide information about disabilities and age-related limitations.

- American Association of People with Disabilities (AAPD)
- The Association of Assistive Technology Act Programs (ATAP)
- Hearing Loss Association of America (HLAA)
- Information Technology Technical Assistance and Training Center (ITTATC)
- Lighthouse International
- National Association of the Deaf
- National Federation of the Blind
- Rehabilitation Engineering & Assistive Technology Society of North America (RESNA)
- Telecommunications for the Deaf and Hard of Hearing, Inc. (TDI)
- W3C Web Accessibility Initiative (WAI)

Educational institutions

Many educational institutions, including these examples, provide information about disabilities and age-related limitations.

- California State University, Northridge, Center on Disabilities (CSUN)
- University of Wisconsin - Madison, Trace Center
- University of Minnesota computer accommodations program

Other disability resources

Many resources, including these examples, provide information about disabilities and age-related limitations.

- ADA (Americans with Disabilities Act) Technical Assistance Program
- ILO Global Business and Disability network
- EnableMart
- European Disability Forum
- Job Accommodation Network
- Microsoft Enable

HP links

These HP-specific links provide information that relates to disabilities and age-related limitations.

[Our contact webform](#)

[HP comfort and safety guide](#)

[HP public sector sales](#)

Contacting support

HP offers technical support and assistance with accessibility options for customers with disabilities.



NOTE: Support is in English only.

- Customers who are deaf or hard of hearing who have questions about technical support or accessibility of HP products:
 - Use TRS/VRS/WebCapTel to call (877) 656-7058 Monday through Friday, 6 a.m. to 9 p.m. Mountain Time.
- Customers with other disabilities or age-related limitations who have questions about technical support or accessibility of HP products, choose one of the following options:
 - Call (888) 259-5707 Monday through Friday, 6 a.m. to 9 p.m. Mountain Time.
 - Complete the [Contact form for people with disabilities or age-related limitations](#).

Index

A

- accessibility 72
- accessibility needs assessment 73
- action keys 10
 - HP programmable key 11
 - identifying 10
 - keyboard backlight 11
 - microphone mute 11
 - mute 11
 - privacy screen 11
 - screen brightness 11
 - speaker volume 11
 - switch screen image 11
 - using 10
 - wireless 11
- administrator password 42
- airplane mode key 18
- ambient light sensors, identifying 6
- antivirus software 49
- assistive technology (AT)
 - finding 73
 - purpose 72
- AT (assistive technology)
 - finding 73
 - purpose 72
- audio 28
 - adjusting volume 11
 - HDMI 31
 - headphones 28
 - headsets 29
 - sound settings 29
 - speakers 28
- audio-out (headphone)/audio-in (microphone) combo jack, identifying 4
- Automatic DriveLock
 - disabling 46
 - enabling 45
- Automatic Drivelock
 - selecting 45
- Automatic DriveLock password
 - entering 46

B

- backup, creating 57

- backups 57
- battery
 - conserving power 38
 - discharging 38
 - factory-sealed 39
 - finding information 37
 - low battery levels 38
 - resolving low battery level 38, 39
- battery charge 37
- battery information, finding 37
- battery light 3
- battery power 37
- BIOS
 - determining version 61
 - downloading an update 61, 62
 - updating 61
- Bluetooth device 18, 20
- Bluetooth label 14
- boot order
 - changing using the f9 prompt 62
- boot order, changing 58
- bottom 14
- buttons
 - left touchpad 8
 - power 5
 - right touchpad 8
- C**
- camera 6
 - identifying 6
 - using 28
- camera light, identifying 6
- camera privacy cover
 - identifying 6
 - using 28
- caps lock light, identifying 8
- caring for your computer 53
- cleaning your computer 53
 - caring for wood veneer 55
 - disinfecting 54
 - HP Easy Clean 53
 - removing dirt and debris 53

components

- bottom 13
- display 5
- keyboard area 7
- left side 4
- rear 13
- right side 3
- top cover 12
- Computer Setup
 - BIOS administrator password 43, 44, 45
 - navigating and selecting 60
 - restoring factory settings 60
 - starting 60
- connecting to a WLAN 19
- connector, power 4
- corporate WLAN connection 19
- critical battery level 38
- customer support, accessibility 76

D

- data transfer 33
- Disk Cleanup software 52
- Disk Defragmenter software 52
- display components 5
- display states 30
- DriveLock
 - description 46
 - disabling 48
 - enabling 47
- DriveLock master password
 - changing 48
- DriveLock password
 - changing 48
 - entering 48
 - setting 47
- DriveLock Security Options 45

E

- electrostatic discharge 71
- embedded numeric keypad, identifying 10
- esc key, identifying 10
- eSIM 20
- external power, using 39

- F**
- factory-sealed battery 39
- fingerprint reader 9, 51
- fingerprints, registering 49
- firewall software 50
- fn key, identifying 10
- fn lock light, identifying 9
- four-finger swipe touchpad gesture 26
- four-finger tap touchpad gesture 26
- G**
- gesture 26
- GPS 20
- H**
- hardware, locating 3
- HDMI audio, configuring 31
- HDMI port 4
 - connecting 30
- headphones, connecting 28
- headsets, connecting 29
- Hibernation
 - exiting 36
 - initiated during critical battery level 38
 - initiating 36
- high-definition devices, connecting 30, 33
- hot keys
 - using 12
- HP 3D DriveGuard 52
- HP Assistive Policy 72
- HP Client Security 50
- HP Device as a Service (HP DaaS) 50
- HP Fast Charge 37
- HP LAN-Wireless Protection 22
- HP MAC Address Pass Through 23
- HP PC Hardware Diagnostics UEFI
 - downloading 67
 - starting 66
 - using 66
- HP PC Hardware Diagnostics Windows
 - accessing 64, 65
 - downloading 65
 - installing 66
 - using 64
- HP programmable key 11
- HP Recovery media
 - recovery 58
- HP resources 1
- HP Sure Recover 59
- HP Touchpoint Manager 50
- I**
- initiating Sleep and Hibernation 35
- input power 69
- internal microphones, identifying 6, 13
- International Association of Accessibility Professionals 73
- J**
- jacks
 - audio-out (headphone)/audio-in (microphone) combo 4
- K**
- keyboard and optional mouse using 27
- keyboard backlight action key 11
- keypad, embedded numeric 10
- keys
 - action 10
 - esc 10
 - fn 10
 - num lk 10
 - Windows 10
- L**
- labels
 - Bluetooth 14
 - regulatory 14
 - serial number 14
 - service 14
 - wireless certification 14
 - WLAN 14
- left side components 4
- lights
 - AC adapter and battery 3
 - battery 3
 - camera 6
 - caps lock 8
 - fn lock 9
 - microphone mute 8
 - mute 8
 - num lk 9
 - power 5
 - privacy key 8
- low battery level 38
- M**
- maintenance
 - Disk Cleanup 52
 - Disk Defragmenter 52
 - updating programs and drivers 53
- managing power 35
- microphone mute key, identifying 11
- microphone mute light, identifying 8
- Miracast 33
- mute light, identifying 8
- mute volume action key 11
- N**
- nano SIM card slot, identifying 5
- nano SIM card, inserting 16
- NFC 21
- num lk light, identifying 9
- O**
- one-finger slide touch screen gesture 27
- operating environment 70
- P**
- passwords
 - administrator 42
 - BIOS administrator 43, 44, 45
 - user 42
- ports
 - HDMI 4, 30
 - USB SuperSpeed port with HP Sleep and Charge 5
 - USB Type-C 33
 - USB Type-C power connector and Thunderbolt port with HP Sleep and Charge 4
 - USB Type-C Thunderbolt 30
- power
 - battery 37
 - external 39
- power button, identifying 5
- power connector
 - identifying USB Type-C 4
- power icon, using 37
- power lights 5
- power settings, using 37

- precision touchpad
 - using 24
- precision touchpad gestures
 - four-finger swipe 26
 - four-finger tap 26
 - three-finger swipe 26
 - three-finger tap 25
 - two-finger slide 25
 - two-finger tap 25
- privacy key light 8
- privacy screen action key,
 - identifying 11
- product name and number,
 - computer 14
- public WLAN connection 19
- R**
- recovery 57
 - discs 58
 - media 58
 - USB flash drive 58
- recovery media 57
 - creating using HP Cloud Recovery Download Tool 57
 - creating using Windows tools 57
- regulatory information
 - regulatory label 14
 - wireless certification labels 14
- Remote HP PC Hardware Diagnostics
 - UEFI settings
 - customizing 68
 - using 67
- resources, accessibility 75
- restoring 57
- right side components 3
- S**
- screen brightness action keys 11
- Section 508 accessibility standards 74
- security cable 51
- security cable slot, identifying 5
- serial number, computer 14
- service labels, locating 14
- setup utility
 - navigating and selecting 60
 - restoring factory settings 60
- shipping the computer 55
- shutdown 36
- SIM card slot, identifying 5
- SIM card, correct size 16
- SIM card, inserting 15
- Sleep
 - exiting 35
 - initiating 35
- Sleep and Hibernation, initiating 35
- slots
 - nano SIM card 5
 - security cable 5
- software
 - antivirus 49
 - Disk Cleanup 52
 - Disk Defragmenter 52
 - firewall 50
- software installed, locating 3
- software updates, installing 50
- sound. *See* audio
- sound settings, using 29
- speaker volume action keys 11
- speakers
 - connecting 28
 - identifying 9, 13
- special keys, using 10
- standards and legislation,
 - accessibility 74
- Sure Start
 - using 63
- switch screen image action key 11
- system restore 58
- system restore point, creating 57
- T**
- tap touchpad and touch screen
 - gesture 24
- three-finger swipe touchpad
 - gesture 26
- three-finger tap touchpad gesture 25
- Thunderbolt, connecting USB Type-C 30
- Tile 16
- touch screen gestures
 - one-finger slide 27
- touchpad
 - settings 7
 - using 24
- touchpad and touch screen gestures
 - tap 24
 - two-finger pinch zoom 24
- touchpad buttons, identifying 8
- touchpad gestures
 - four-finger swipe 26
 - four-finger tap 26
 - three-finger swipe 26
 - three-finger tap 25
 - two-finger slide 25
 - two-finger tap 25
- touchpad zone, identifying 8
- TPM settings 62
- transfer data 33
- traveling with the computer 14, 55
- turning off the computer 36
- two-finger pinch zoom touchpad and
 - touch screen gesture 24
- two-finger slide touchpad gesture 25
- two-finger tap touchpad gesture 25
- U**
- unresponsive system 36
- updating programs and drivers 53
- USB SuperSpeed port with HP Sleep and Charge, identifying 5
- USB Type-C port, connecting 30, 33
- USB Type-C power connector and
 - Thunderbolt port with HP Sleep and Charge, identifying 4
- user password 42
- using passwords 42
- using the keyboard and optional
 - mouse 27
- using the touchpad 24
- V**
- vents, identifying 13
- video 29
 - HDMI port 30
 - Thunderbolt Port device 30
 - USB Type-C 30
 - wireless displays 33
- volume
 - adjusting 11
 - mute 11
- W**
- Windows
 - backup 57
 - recovery media 57
 - system restore point 57
- Windows Hello
 - using 49

- Windows key, identifying 10
- Windows tools, using 57
- wireless action key 11
- wireless antennas, identifying 6
- wireless button 18
- wireless certification label 14
- wireless controls
 - button 18
 - operating system 18
- wireless key 18
- wireless light 18
- wireless network (WLAN)
 - connecting 19
 - corporate WLAN connection 19
 - functional range 19
 - public WLAN connection 19
- WLAN antennas, identifying 6
- WLAN device 14
- WLAN label 14
- WWAN antennas, identifying 6
- WWAN device 18, 19