

802.11ah
Wi-Fi HaLow™
Wireless Bridge
BR-100AH

User's Manual



Index

I. Introduction	1
1-1. Introduction	1
Disclaimers	1
Trademarks	1
1-2. Safety Instructions	2
1-3. Product Information and Customer Services	5
Product Information	5
Customer Support Center	5
2. About BR-100AH	6
2-1. Features	7
2-2. Parts and Functions	9
2-3. Hardware Specification	11
2-4. Software Specification	14
2-5. Use of Radio Waves	15
Notes on Usage	15
2-6. Notes on Security	16
3. Before You Begin	17
3-1. Device Connection Topology	17
3-2. Configuration Method	19
Configuration using BR-100AH's web page	20
Configuration using AMC Manager®	21
3-3. Necessary Wireless Setting Information	22
4. How to Configure BR-100AH	27
4-1. Configuration Using BR-100AH's Web Page	28
Connecting BR-100AH to a computer	28
Configuration	29
Connecting Non-wireless Devices	33
4-2. Configuration Using AMC Manager®	35
Connecting BR-100AH to a computer	35
Configuration	36
Connecting Non-wireless Devices	40
5. List of Functions	42
5-1. Device Filter	42
5-2. IP Access Control	43
5-3. Web (HTTP/HTTPS)	44
5-4. Maintenance	45
Restarting	45

Factory Default Configuration	48
Firmware Update	51
A. Appendix	54
A-1. List of All Settings.....	54
A-2. Troubleshooting.....	62



1. Introduction

Thank you for purchasing the Wireless Bridge BR-100AH (hereinafter the "BR-100AH").

1-1. Introduction

This manual provides information on how to configure and use the BR-100AH. Please read the Safety Instructions carefully before you begin.

Disclaimers

- The unauthorized transfer or copying of the content of this manual, in whole or in part, without prior written consent is expressly prohibited by law.
- The content of this manual is subject to change without notice.
- This manual was prepared to accurately match the content of each OS, but the actual information shown on the computer monitor may differ from the content of this manual due to future OS version upgrades, modifications, and other changes.
- Although every effort was made to prepare this manual with the utmost accuracy, Silex Technology will not be held liable for any damages as a result of errors, setting examples, or other content.

Trademarks



- Microsoft and Windows are registered trademarks of Microsoft Corporation in the United States and/or other countries.
- Wi-Fi, Wi-Fi Protected Setup (WPS), Wi-Fi Protected Access (WPA), WPA2, WPA3 are trademarks or registered trademarks of Wi-Fi Alliance.
- Other company names and product names contained in this manual are trademarks or registered trademarks of their respective companies.

1-2. Safety Instructions







This page provides the safety instructions for safe use of BR-100AH.

To ensure safe and proper use, please read the following information carefully before using BR-100AH. The safety instructions include important information on safe handling of BR-100AH and on general safety issues.

< Meaning of the warnings >





	Warning	"Warning" indicates the existence of a hazard that could result in death or serious injury if the safety instruction is not observed.
	Caution	"Caution" indicates the existence of a hazard that could result in serious injury or material damage if the safety instruction is not observed.

< Meaning of the symbols >

	This symbol indicates the warning and caution. (Example:  "Danger of the electric shock")
	This symbol indicates the prohibited actions. (Example:  "Disassembly is prohibited")
	This symbol indicates the actions users are required to observe. (Example:  "Remove the AC plug from an outlet")



Warning

 	<p>* Do not allow physical impact. When damaged, turn off the connected devices, unplug the AC plug of BR-100AH from a power outlet and contact your point of purchase. Failure to take this action could cause fire or an electrical shock.</p> <p>* In the following cases, turn off the connected devices and unplug the AC plug of BR-100AH from a power outlet and contact your point of purchase. Failure to take this action could cause fire or an electrical shock.</p> <ul style="list-style-type: none"> * When BR-100AH emits a strange smell, smoke or sound or becomes too hot to touch. * When foreign objects (metal, liquid, etc.) gets into BR-100AH.
	<p>* Keep the cords and cables away from children. It may cause an electrical shock or serious injury.</p>
	<p>* If a ground wire is supplied with your device to use with, connect it to the ground terminal in order to prevent an electrical shock. Do not connect the ground wire to gas pipe, water pipe, lighting rod or telephone ground wire. It may cause malfunction.</p>
	<p>* Do not disassemble or modify BR-100AH. It may cause fire, electrical shock or malfunction.</p> <p>* Do not disassemble or modify the AC adaptor that came with BR-100AH. It may cause fire, electrical shock or malfunction.</p>



Caution

	<p>* Do not pull on the cord to disconnect the plug from the power supply. The cord may be broken, which could result in fire or an electrical shock.</p>
	<p>* When removing BR-100AH, disconnect the AC plugs of both BR-100AH and the other devices you are using with.</p> <p>* Use the AC adaptor supplied with BR-100AH. Other AC adaptors may cause malfunction.</p> <p>* Verify all codes or cables are plugged correctly before using BR-100AH.</p> <p>* When BR-100AH will not be used for a long time, unplug the power cables of BR-100AH and the other devices you are using with.</p>
	<p>* Do not use or store BR-100AH under the following conditions. It may cause malfunction.</p> <ul style="list-style-type: none"> - Locations subject to vibration or shock - Shaky, uneven or tilted surfaces - Locations exposed to direct sunlight - Humid or dusty places - Wet places (kitchen, bathroom, etc.) - Near a heater or stove - Locations subject to extreme changes in temperature - Near strong electromagnetic sources (magnet, radio, wireless device, etc.)

1-3. Product Information and Customer Services

Product Information

The services below are available from the Silex Technology website. For details, please visit the Silex Technology website.

URL	
USA / Europe	https://www.silextechnology.com/

- Latest firmware download
- Latest software download
- Latest manual download

Customer Support Center

Customer Support is available by e-mail or telephone for any problems that you may encounter. If you cannot find the relevant problem in this manual or on our website, or if the corrective procedure does not resolve the problem, please contact Silex Technology Customer Support.

Contact Information		
USA	+1-657-218-5199	support@silexamerica.com
Europe	+49-2154-88967-0	support@silexeurope.com



Note

- Visit the Silex Technology website (<https://www.silextechnology.com/>) for the product information.

2. About BR-100AH

BR-100AH is the wireless bridge connecting a non-wireless device (10BASE-T/100BASE-TX network device) to 802.11ah wireless network. With sub-GHz radio, various non-wireless devices can easily be connected to a wide-range 802.11ah wireless network.

The BR-100AH employs WPA3 Wi-Fi authentication to ensure safe and secure use of wireless communication at an office, factory, etc. where higher security is required. The BR-100AH is firmware upgradable to enhance its feature.

2-1. Features

BR-100AH has the following features:

Giving unlimited locations for your non-wireless devices

As you do not have to care about wiring conditions to establish your environment, the BR-100AH provides flexibility in the installation location. A network coverage greatly expands in any scene, such as healthcare facilities, offices, factories, schools, commercial facilities, etc. The radio interference with the existing 2.4GHz/5GHz Wi-Fi network is avoided by its sub-GHz radio while the devices are easily deployed into the existing IP network. Also, considerable installation cost reduction is expected as you will no longer have to pay for wiring construction.

IEEE 802.11ah

BR-100AH supports communications at sub-GHz. 802.11ah provides a much longer range than 2.4GHz/5GHz, much more device connections per access point, radio interference avoidance with 2.4GHz/5GHz radios, and much better radio coverage due to better wall penetration and diffraction around obstacles.

Advanced security

The following security features are supported:

- Enhanced Open (OWE, AES-128)
- WPA2-Personal (PSK, AES-128)
- WPA3-Personal (SAE, AES-128)

Multiple Client Devices Support

- The BR-100AH bridges one non-wireless device to 802.11ah wireless network through its Ethernet port.
- Up to 16 non-wireless devices can be bridged when connected to the BR-100AH through an Ethernet HUB.
- The BR-100AH uses its MAC address in the wireless network.

Firmware upgradable device

- The BR-100AH support the firmware update to enhance its features. The firmware update is easy through its configuration web page or AMC Manager®.

Easy access to the Web configuration interface

Without changing the PC setup, the Web configuration interface of BR-100AH can easily be accessed.

AMC Manager (non-free program)

BR-100AH supports the total management software, AMC Manager® version 4.0.0 and later. The AMC Manager® provides useful features, as follows:

- Remote device control and monitoring
- Bulk configuration and firmware updates
- System time synchronization (version 4.0.0 or later)



Note

- To use the functions above, your Access Point or wireless router needs to support the same functions.
- For details on the "AMC Manager", please visit our homepage.
- To use the "AMC Manager", an IP address needs to be configured to the BR-100AH.
- BR-100AH can be used in Infrastructure mode only. Ad hoc mode is not supported.

2-2. Parts and Functions

The parts name and functions are as follows:

Top

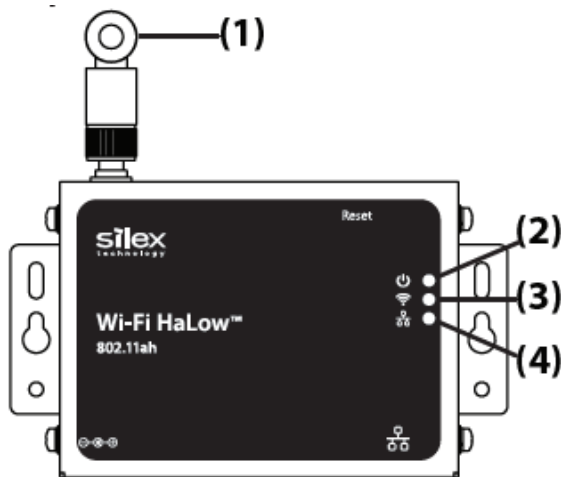

(1)	Wireless LAN Antenna	Antenna for wireless communication	
(2)	Power LED (Orange)*	ON	Powered on
(3)	Wireless LED (Yellow)*	ON	The BR-100AH has connected to an access point.
		BLINK	Data communication is occurring.
(4)	Wired LED (Green)*	ON	The BR-100AH has connected to a wired LAN.

* All 3 LEDs (Power/Wireless/Wired LEDs) turn on when BR-100AH is started.

Then, Wireless/Wired LEDs turn off in 1 second, and start to turn on/blink as described in the table.

Front and Back

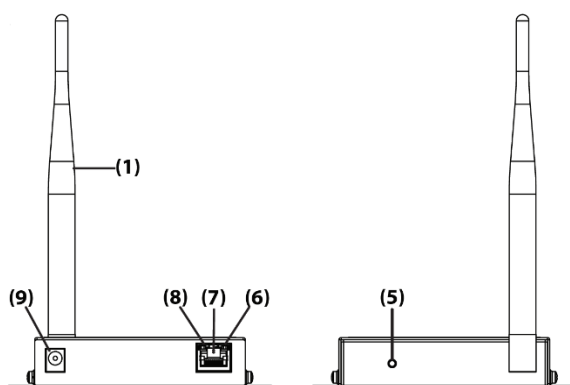

(5)	Push Switch	Press this switch for the following operations when BR-100AH is on.	
		Initialization	Press and hold, and release the switch in 5 sec or longer.
		Restart	Press and hold, and release the switch in 5 sec or shorter
(6)	STATUS LED (Yellow)	Blinks while communicating with (an) Ethernet device(s)	
(7)	Network Port	Connect a network cable.	
(8)	Link LED (Green)	Turns on when connected to (an) Ethernet device(s)	
(9)	DC Connector	Connect an AC adaptor	

Bottom

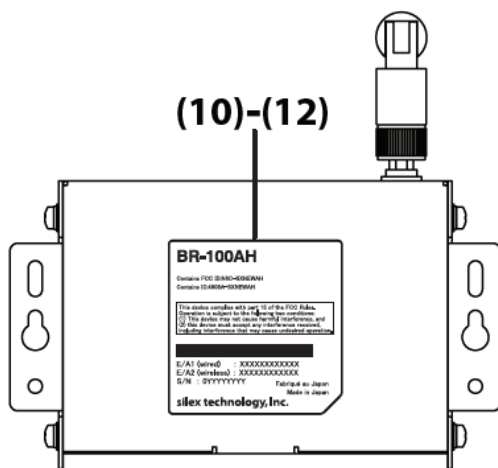

(10)	E/A1 (wired)	Ethernet Address of the wired LAN
(11)	E/A2 (wireless)	Ethernet Address of the wireless LAN
(12)	S/A	Serial Number

2-3. Hardware Specification

Operating environment	Temperature : 0 degrees to +40 degrees
	Humidity : 20% to 80%RH (Non-condensing)
Storage environment	Temperature : -20 degrees to +80 degrees
	Humidity : 20% to 90%RH (Non-condensing)
EMI	FCC Class B
	ICES Class B
Wired network interface	10BASE-T/100BASE-TX (Auto-sensing) :1 port Auto MDI/MDIX
Wireless network interface	IEEE 802.11ah
Channel	(US/CA): Unit MHz
	1MHz Bandwidth: 903.5, 904.5, 905.5, 906.5, 907.5, 908.5, 909.5, 910.5, 911.5, 912.5, 913.5, 914.5, 915.5, 916.5, 917.5, 918.5, 919.5, 920.5, 921.5, 922.5, 923.5, 924.5, 925.5, 926.5
	2MHz Bandwidth: 905, 907, 909, 911, 913, 915, 917, 919, 921, 923, 925
	4MHz Bandwidth: 910, 914, 918, 922
Push Switch	1
LED	Top POWER (Orange) Wireless (Yellow) Wired (Green)
	LAN Port Status (Orange) Link (Yellow)
Compatible devices	Network devices with LAN port (RJ-45)
Maximum number of connectable devices	16 devices

FCC / ISED Notice

FCC Notice

BR-100AH

This device complies with Part 15 of FCC Rules. Operation is subject to the following two conditions: (1) this device may not cause harmful interference, and (2) this device must accept any interference received, including interference that may cause undesired operation.

silex technology america, Inc.
201 East Sandpointe, #245
Santa Ana, CA 92707
USA
Phone: 657-218-5199

FCC CAUTION

Changes or modifications not expressly approved by the party responsible for compliance could void the user's authority to operate the equipment.

Contains FCC ID : N6C-SXNEWAH

FCC Rules Part 15 Subpart B

Note: This equipment has been tested and found to comply with the limits for a Class B digital device, pursuant to part 15 of the FCC Rules. These limits are designed to provide reasonable protection against harmful interference in a residential installation. This equipment generates, uses and can radiate radio frequency energy and, if not installed and used in accordance with the instructions, may cause harmful interference to radio communications. However, there is no guarantee that interference will not occur in a particular installation. If this equipment does cause harmful interference to radio or television reception, which can be determined by turning the equipment off and on, the user is encouraged to try to correct the interference by one or more of the following measures:

- Reorient or relocate the receiving antenna.
- Increase the separation between the equipment and receiver.
- Connect the equipment into an outlet on a circuit different from that to which the receiver is connected.
- Consult the dealer or an experienced radio/TV technician for help.

RF exposure compliance

This equipment complies with FCC radiation exposure limits set forth for an uncontrolled environment and meets the FCC radio frequency (RF) Exposure Guidelines. This equipment should be installed and operated keeping the radiator at least 20cm or more away from person's body.

Co-Location Rule

This transmitter must not be co-located or operated in conjunction with any other antenna or transmitter.

Antennas

To prevent violation of the law, do not use antennas other than those provided or specified by Silex Technology.

ISED Notice

This device contains license-exempt transmitter(s)/receiver(s) that comply with Innovation, Science and Economic Development Canada's license-exempt RSS(s). Operation is subject to the following two conditions:

1. This device may not cause interference.
2. This device must accept any interference, including interference that may cause undesired operation of the device.

L'émetteur/récepteur exempt de licence contenu dans le présent appareil est conforme aux CNR d'Innovation, Sciences et Développement économique Canada applicables aux appareils radio exempts de licence. L'exploitation est autorisée aux deux conditions suivantes :

1. L'appareil ne doit pas produire de brouillage;
2. L'appareil doit accepter tout brouillage radioélectrique subi, même si le brouillage est susceptible d'en compromettre le fonctionnement.

Contains IC: 4908A-SXNEWAH**RF exposure considerations**

This equipment complies with ISED radiation exposure limits set forth for an uncontrolled environment and meets RSS-102 of the ISED radio frequency (RF) Exposure rules.

This equipment should be installed and operated keeping the radiator at least 20cm or more away from person's body.

Cet équipement est conforme aux limites d'exposition aux rayonnements énoncées pour un environnement non contrôlé et respecte les règles d'exposition aux fréquences

radioélectriques (RF) CNR-102 de l'ISDE. Cet équipement doit être installé et utilisé en gardant une distance de 20 cm ou plus entre le radiateur et le corps humain.

Antenna Type

This radio transmitter (4908A-SXNEWAH) has been approved by Innovation, Science and Economic Development Canada to operate with the antenna types listed below, with the maximum permissible gain indicated. Antenna types not included in this list that have a gain greater than the maximum gain indicated for any type listed are strictly prohibited for use with this device.

Antenna type	Gain	Impedance
Rod Antenna	3.4dBi	50ohms

Le présent émetteur radio (4908A-SXNEWAH) a été approuvé par Innovation, Sciences et Développement économique Canada pour fonctionner avec les types d'antenne énumérés ci-dessous et ayant un gain admissible maximal. Les types d'antenne non inclus dans cette liste, et dont le gain est supérieur au gain maximal indiqué pour tout type figurant sur la liste, sont strictement interdits pour l'exploitation de l'émetteur.

Type d'antenne	Gain	l'impédance
Antenne à tige	3.4dBi	50ohms

2-4. Software Specification

TCP/IP	Network layer	ARP, IP
	Transport layer	TCP, UDP
	Application layer	HTTP/HTTPS, TFTP, SNMP, DHCP (simple server function only), and SX_SMP* * SX_SMP are the silex proprietary protocols.

- This bridges TCP/IP (IPv4, IPv6) only.

2-5. Use of Radio Waves

Notes on Usage

If there is reinforced metal between wireless devices, they may not connect.

BR-100AH can connect through wood or glass, but may have troubles connecting through reinforced metal.

BR-100AH complies with the certification of conformance to technical standards. Please pay attention to the following points:

- Please do not disassemble or remodel the product. Such action is prohibited by law.
- Please do not remove the certificate label. Using the product without a label is prohibited.

Wireless devices using sub-GHz band

- Before you use BR-100AH, check that it does not interfere with other devices.
- If interference occurs, stop using BR-100AH or change the wireless band. Please consider to create a wall between these devices to avoid interference. Contact us for possible solution.

2-6. Notes on Security

Because a wireless LAN uses electromagnetic signals instead of a network cable to establish communication with network devices, it has the advantage of allowing devices to connect to the network easily. However, a disadvantage of this is that within a certain range, the electromagnetic signals can pass through barriers such as walls, and if security countermeasures are not implemented in some way, problems such as the following may occur.

- Communication is intercepted by a third party
- Unauthorized access to the network
- Leakage of personal information (ID and Card information)
- Spoofing and the falsification of intercepted data
- System crashes and data corruption

Nowadays, wireless LAN cards or access points are equipped with security measures that address such security problems, so that you can enable security-related settings for wireless LAN products in order to reduce the likelihood of problems occurring.

We recommend that you make yourself fully acquainted with the possible implications of what might happen if you use a wireless product without enabling security features, and that you configure security-related settings and use wireless products at your own responsibility.

3. Before You Begin

This chapter explains two device connection topologies and available configuration methods for BR-100AH as well as the wireless setting information you need to check out before the configuration.

3-1. Device Connection Topology

BR-100AH supports two device connection topologies, one is direct connection with an Ethernet device and the other is connections with multiple Ethernet devices through Ethernet hub.



TIP

- The devices with multiple MAC addresses cannot be used (e.g. PC with a load balancing feature, etc).
- BR-100AH bridges TCP/IP (IPv4 and IPv6).
- BR-100AH does not support bridging the following IPv6 packets.
 - Inverse Neighbor Advertisement
 - Fragment Header
 - Authentication Header
 - Encapsulating Security Payload

Single Client Connection

Connect a single non-wireless device to the BR-100AH through the Ethernet port directly. The IP packet is bridged from the Ethernet device to the wireless network.

Non-wireless device
(Printer)

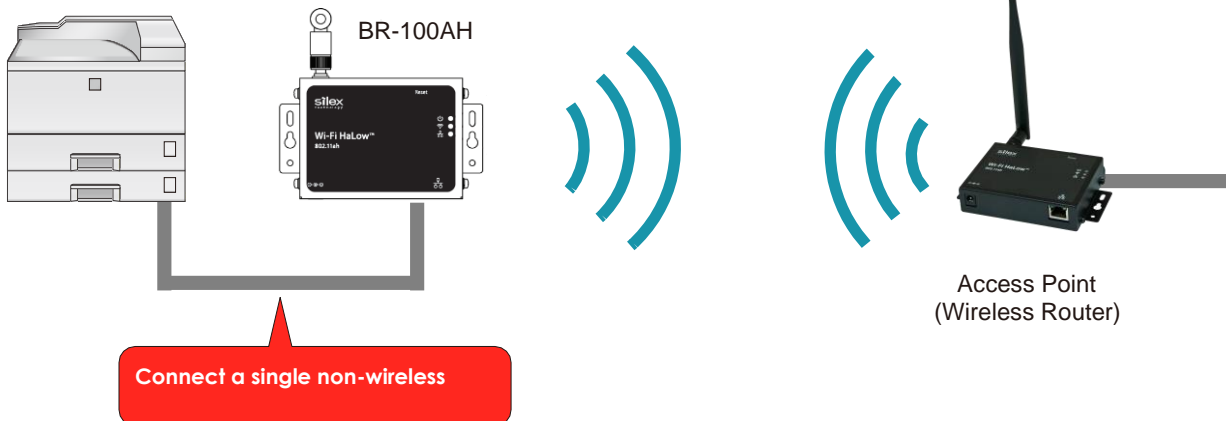

Multi-Client Connection

Use this mode when you connect multiple non-wireless devices to BR-100AH. By using a HUB on the LAN port, up to 16 devices can be connected.

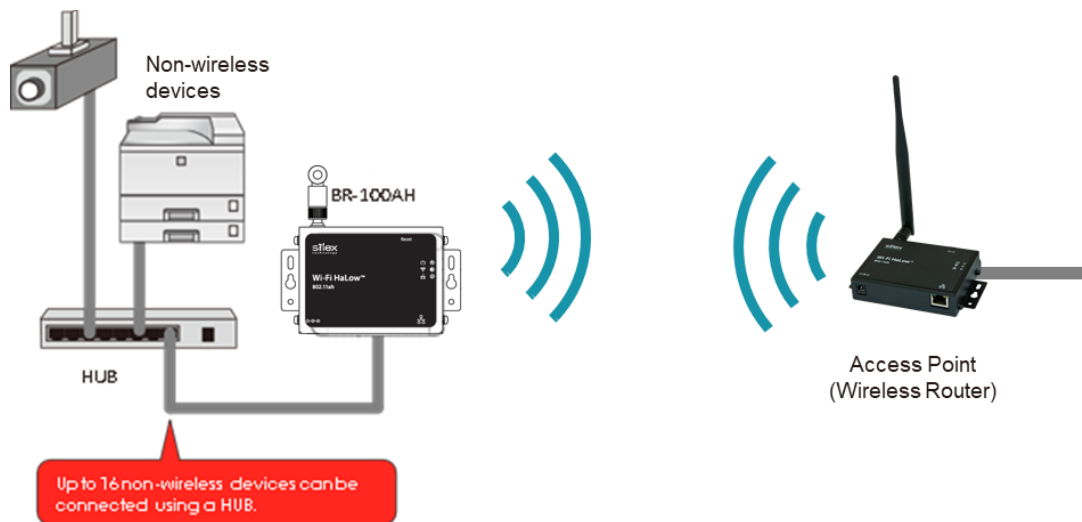

3-2. Configuration Method

There are two configuration methods as follows.

Please select the one appropriate for your environment.

- Configuration using BR-100AH's configuration web page
- Configuration using AMC Manage®

Configuration using BR-100AH's web page

In this configuration method, you connect the BR-100AH to a PC using a network cable to configure the BR-100AH from the PC.

By connecting the BR-100AH to the PC, the Web configuration interface can be accessed.

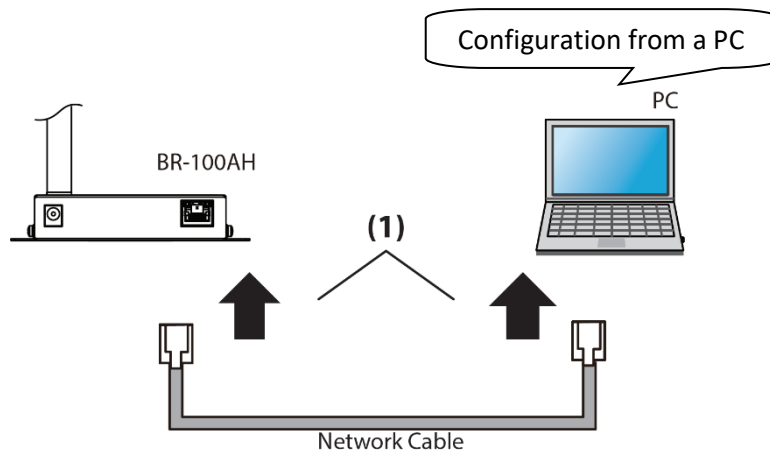

Note

In this configuration method, only "SSID" and "Network Key" are needed to connect to a wireless LAN, however, further configuration is required in the following cases.

- Access Point is operating in a stealth mode.

Configuration using AMC Manager®

The configuration by AMC Manager® is recommended when multiple BR-100AH units use the same configuration parameters, such as setting the same SSID and Pre-Shared Key (PSK) of an access point. In this configuration method, you connect the BR-100AH to a PC using a network cable to configure the BR-100AH from the PC.

The AMC Manager® running on the PC automatically find the connected BR-100AH. The AMC Manager® allows users to generate a configuration file from the BR-100AH's template and load it to the BR-100AH units.

Depending on your environment, you may need to check the wireless LAN information beforehand.

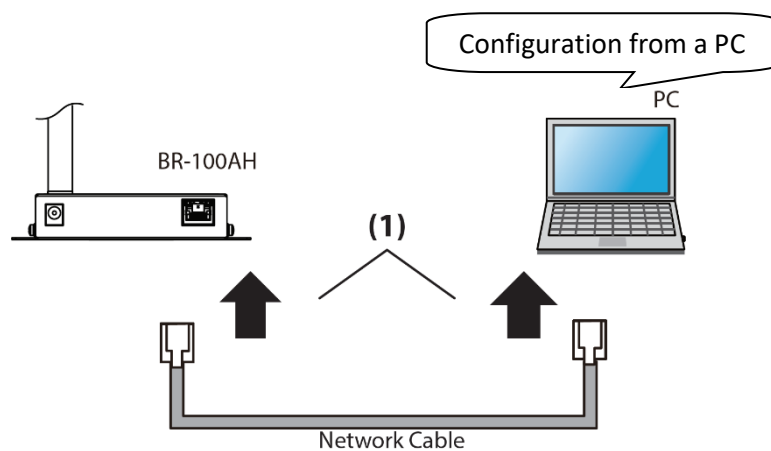
**Note**

In this configuration method, only "**SSID**" and "**Network Key**" are needed to connect to a wireless LAN, however, further configuration is required in the following cases.

- Access Point is operating in a stealth mode.

3-3. Necessary Wireless Setting Information

When you configure BR-100AH, the wireless settings need to be configured appropriately for your environment. As the same wireless settings must be configured for both BR-100AH and your Access Point, you need to get the necessary setting information of your Access Point beforehand.



TIP

- The wireless setting information explained in this page is specific to your network and cannot be provided by Silex technical support. For how to confirm each setting, please refer to the operation manual that came with your router or contact the manufacturer.
- If a security feature such as MAC Address filtering is enabled on your Access Point, change the setting so that BR-100AH can communicate with your Access Point. For details, refer to the operation manual that came with your Access Point.

SSID	The SSID is an ID that distinguishes a wireless LAN network from others. For wireless devices to communicate with each other on a wireless network, they must share the same SSID. (The SSID is also referred to as "ESSID".) Depending on your Access Point, it may have several SSIDs. If there are different SSIDs for a game console and computer, use the one for the computer.	
Encryption Mode	No Encryption	Uses no encryption for wireless communication. (In this case, you do not have to get any of your settings beforehand.)
	WPA / WPA2 / WPA3	Uses PSK for network authentication. The encryption key will be generated by communicating with the Access Point using a Pre-Shared key. Set the same "Pre-Shared key" and "Encryption Mode"(AES/AUTO) as the wireless device you wish to connect. The Pre-Shared key is also referred to as "Network Key" or "Password".

4. How to Configure BR-100AH

This chapter explains how to configure BR-100AH.

Following configuration methods are available:

- 1) Configuration using BR-100AH's web page
- 2) Configuration using AMC Manager®



Note

- For details on each configuration method, refer to **3-2. Configuration Method**.

4-1. Configuration Using BR-100AH's Web Page

How to configure BR-100AH using the Configuration Mode is explained.

Connecting BR-100AH to a computer

1. Connect BR-100AH and the PC (to use for setup) using a network cable.

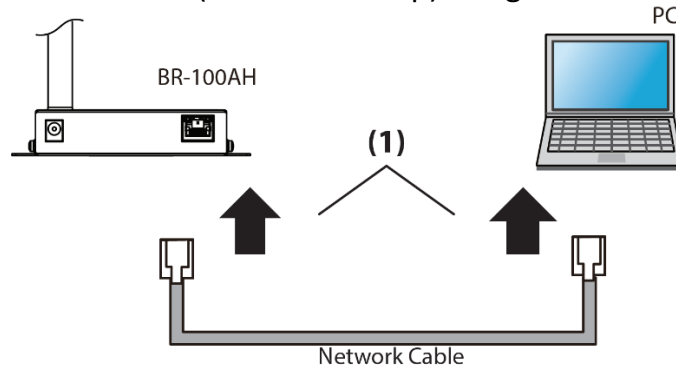

2. Connect the AC adaptor to BR-100AH, and the AC adaptor's plug to an electrical outlet.

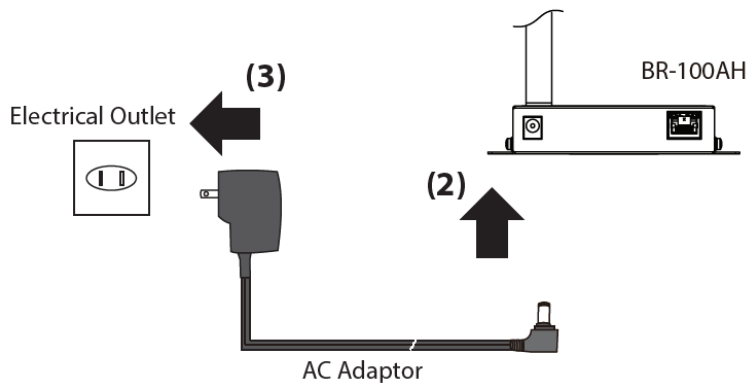

3. Confirm that the Power LED (orange: (2)) and the wired LED (green: (4)) are turned on.

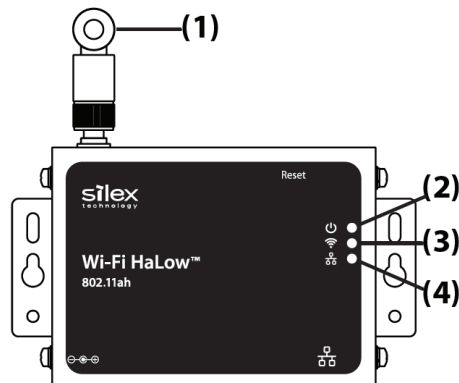

Configuration

1. Access to BR-100AH's web page. Launch a web browser on the PC and enter the IP address of BR-100AH in the address bar. The IP address of the BR-100AH's Ethernet port is "169.254.111.111".

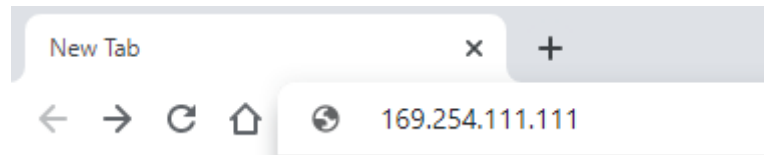
**TIP**

- To start the configuration, the PC and BR-100AH need to communicate each other properly.
- Confirm that an IP Address is correctly configured to the PC.
- If a static IP address is set to the Ethernet adapter of the PC, the Web configuration interface cannot be displayed in the following cases:
 - An IP address of the Ethernet adapter is set for a different subnet.
- If the BR-100AH configuration web page does not appear, set the IP address of the Ethernet adapter of the PC connected with the BR-100AH as following:
 - IP Address: 169.254.111.1
 - Subnet Mask: 255.255.0.0

- The login password configuration page appears for the first time web page access. Enter the password to configure for the BR-100AH and click **Submit**. Note that the BR-100AH accepts up to eight letters for the password.

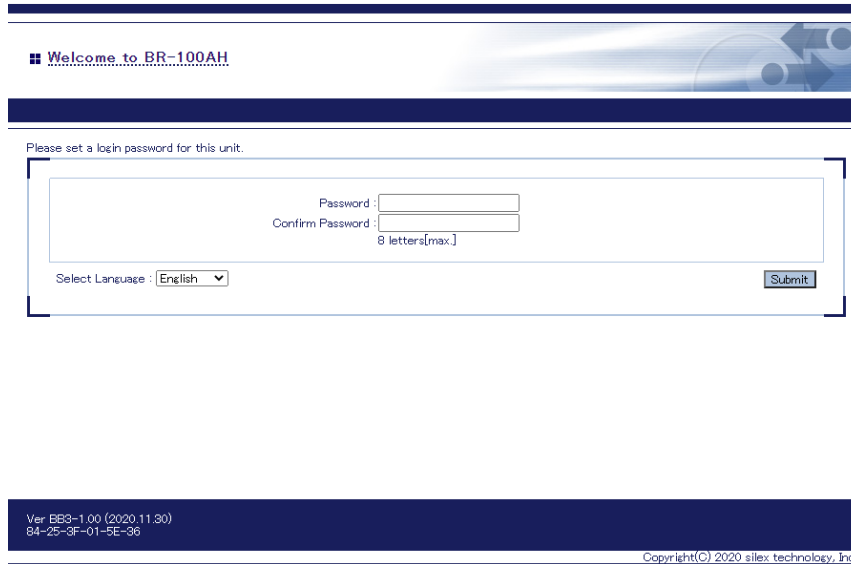

- Click **Login** from the left menu and enter the password. Then, click **Login**.

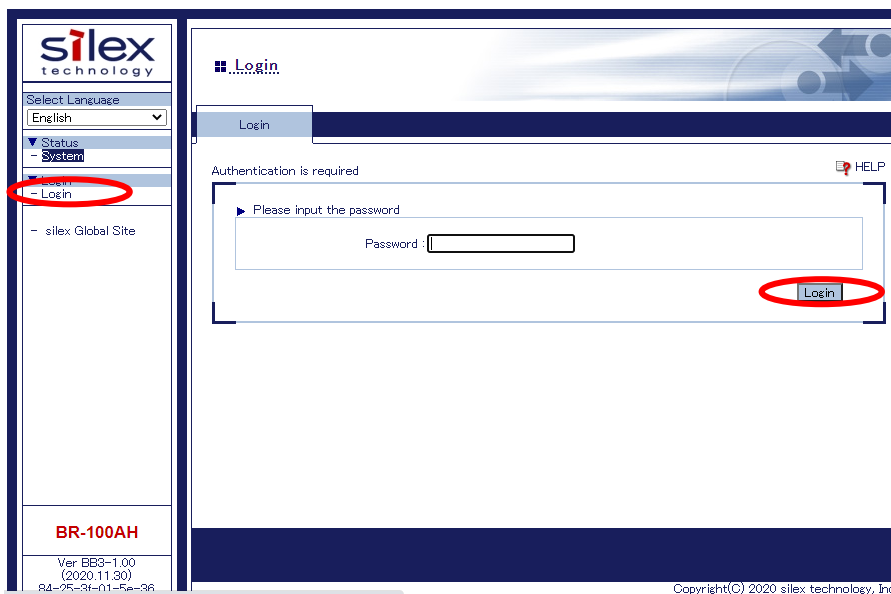

4. In the Web configuration interface, click **Wireless LAN** from the left menu. Then, enter SSID of the access point and the network authentication method. When WPA2-Personal or WPA3-Personal is selected, **WPA/WPA2 Configuration** section appears. Enter the Pre-Shared Key of the access point and click **Submit** when finished.

The screenshot shows the Silex Technology Web Configuration Interface. On the left sidebar, the 'Wireless LAN' option is highlighted with a red circle. The main content area is titled 'Wireless LAN Configuration'. Under the 'Wireless LAN Basic Configuration' section, there is a table with two columns: 'Name' and 'Value'. The first row is 'SSID' with the value 'SilexAH'. The second row is 'Network Authentication' with a dropdown menu set to 'Open'. A 'Submit' button is located at the bottom right of this section.

The screenshot shows the Silex Technology Web Configuration Interface. The 'Wireless LAN' option in the left sidebar is highlighted. The main content area is titled 'Wireless LAN Configuration'. Under the 'Wireless LAN Basic Configuration' section, the 'Network Authentication' dropdown is now set to 'WPA3-Personal'. A new section titled 'WPA/WPA2 Configuration' has appeared, containing a 'Pre-Shared Key' field with masked characters (****) and a 'Submit' button.



Note

- For network key, usable characters will differ depending on the AP to connect.
- For Pre-Shared key, enter 8-63 characters or 64 hexadecimal value. For details, refer to **Pre-Shared Key** at **A-1. List of All Settings**.

5. Click **Restart** and **Yes** to restart the BR-100AH. The configuration set in the step 4 takes effect only after the BR-100AH is restarted.

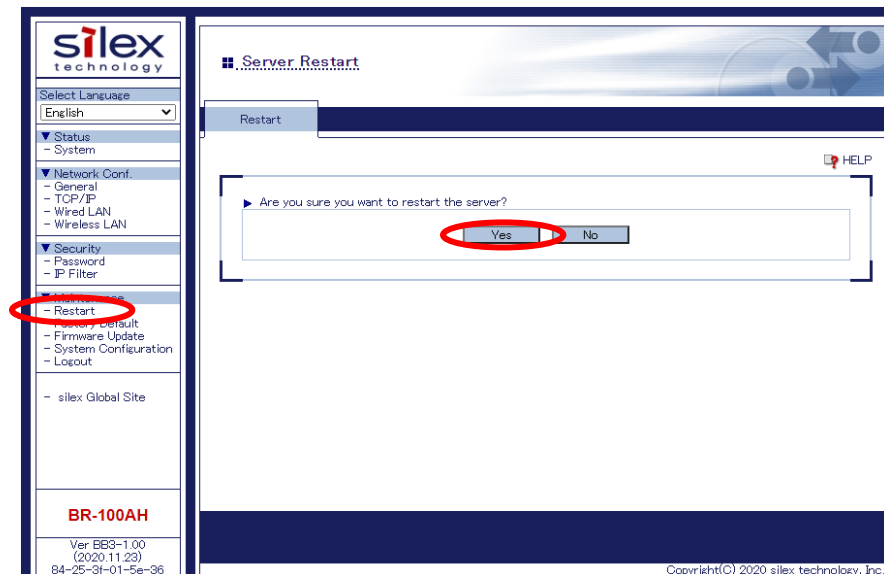

When you wish to bridge the PC used for this configuration wirelessly, restart the PC.

To bridge another device wirelessly, turn off both BR-100AH and PC, remove the BR-100AH from the PC and connect the BR-100AH to the device you wish to use wirelessly using a network cable. For details, refer to **Connecting Non-wireless Devices** in the next page.

Connecting Non-wireless Devices

1. Turn off the non-wireless device that you wish to use wirelessly and connect the BR-100AH to it using a network cable. The connection method will vary depending on each operating mode.

Single Client Connection

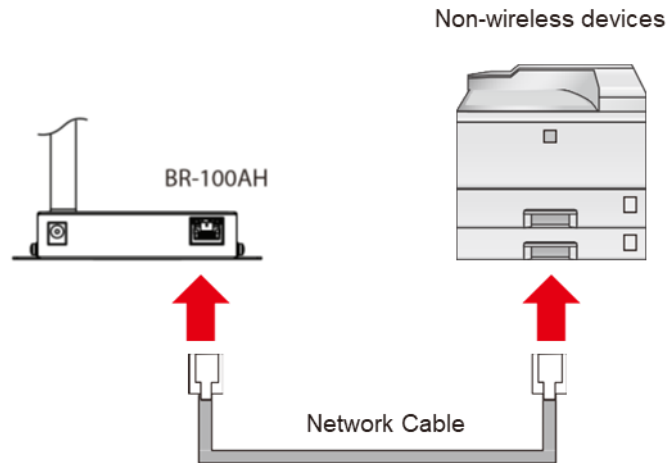

Multi-Client Connection

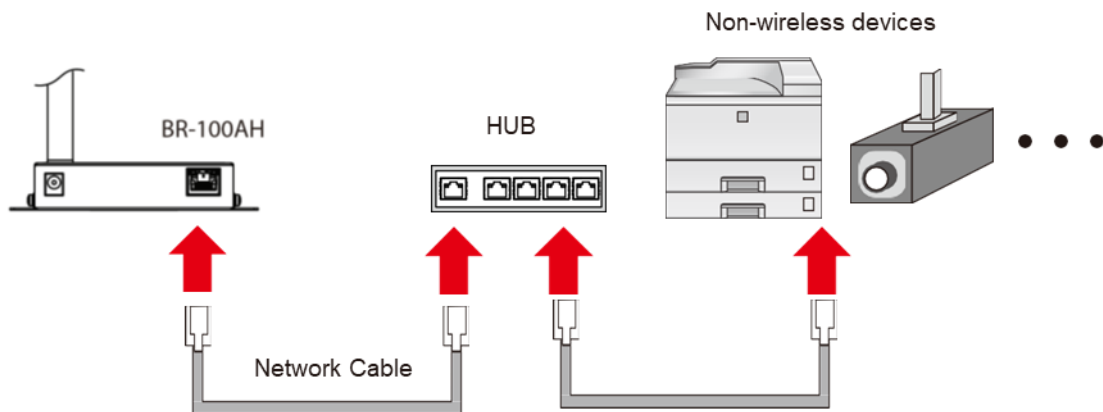

2. Connect the AC adaptor to the BR-100AH and the AC plug to the outlet.

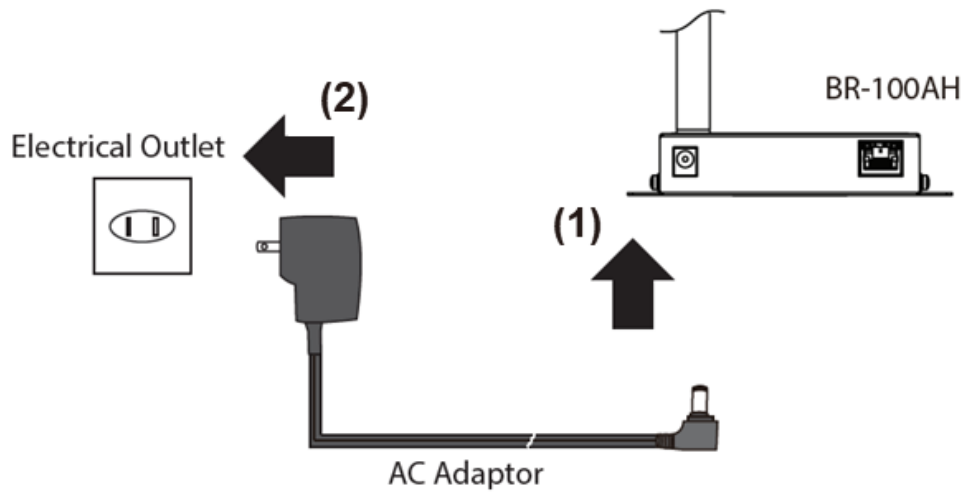

3. Turn on the non-wireless device connected to the BR-100AH. When the wireless network is established, all LEDs turn on. The BR-100AH will be ready to use. You can use the non-wireless device over a wireless network.

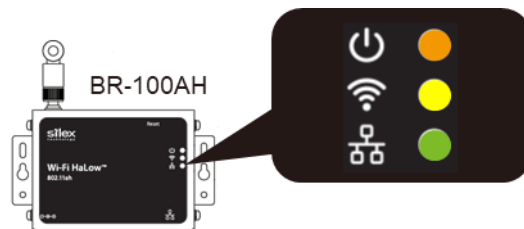

Note

- Depending on the non-wireless device you have connected, further network settings may need to be configured to that device. In such a case, please configure it according to the operating manual that came with your device.
- When you turn on the BR-100AH and your non-wireless device, be sure to turn on the BR-100AH first. Do not press the push switch then.

4-2. Configuration Using AMC Manager[®]

How to configure BR-100AH using AMC Manager[®] is explained.

Connecting BR-100AH to a computer

1. Connect BR-100AH and the PC (to use for setup) using a network cable.

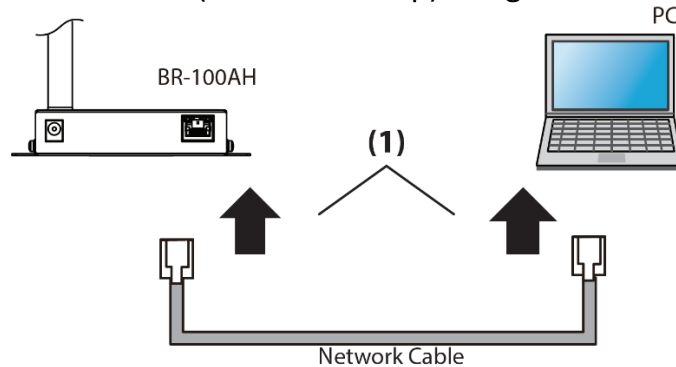

2. Connect the AC adaptor to BR-100AH, and the AC adaptor's plug to an electrical outlet.

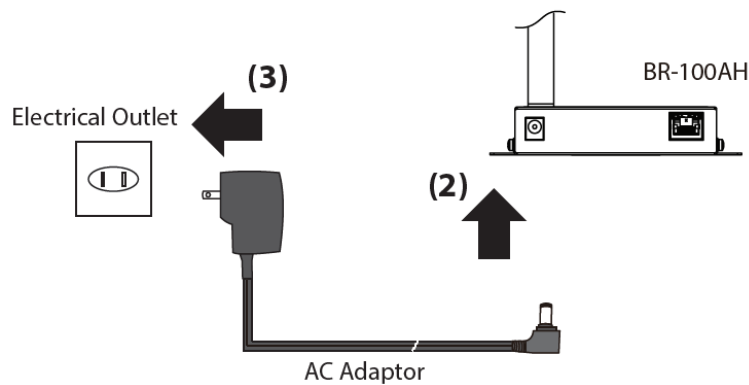

3. Confirm that the Power LED (orange: (2)) and the wired LED (green: (4)) are turned on.

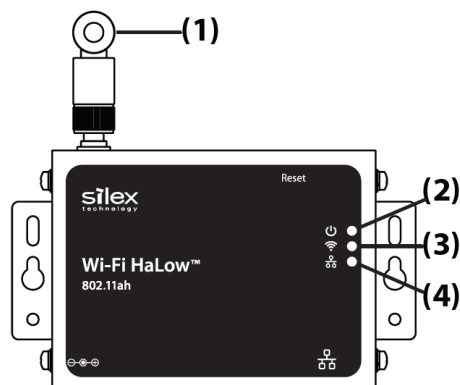

Configuration

1. Download AMC Manager® from the Silex Technology's website and install it to your computer. Launch AMC Manager® and confirm BR-100AH is found.

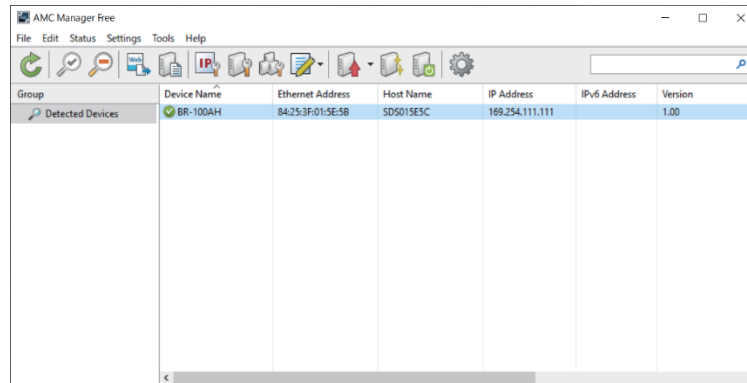

TIP

- To start the configuration, the PC and BR-100AH need to communicate each other properly.
- Confirm that an IP Address is correctly configured to the PC.
- If a static IP address is set to the Ethernet adapter of the PC, the Web configuration interface cannot be displayed in the following cases:
 - An IP address of the Ethernet adapter is set for a different subnet.
- If the BR-100AH configuration web page does not appear, set the IP address of the Ethernet adapter of the PC connected with the BR-100AH as following:
 - IP Address: 169.254.111.1
 - Subnet Mask: 255.255.0.0

2. Create a configuration file using the template. Click the icon **Create the configuration file** and click **Create from Template** from the toolbar (1). In the **Select Template** window, select the device to configure and click **OK** (2).

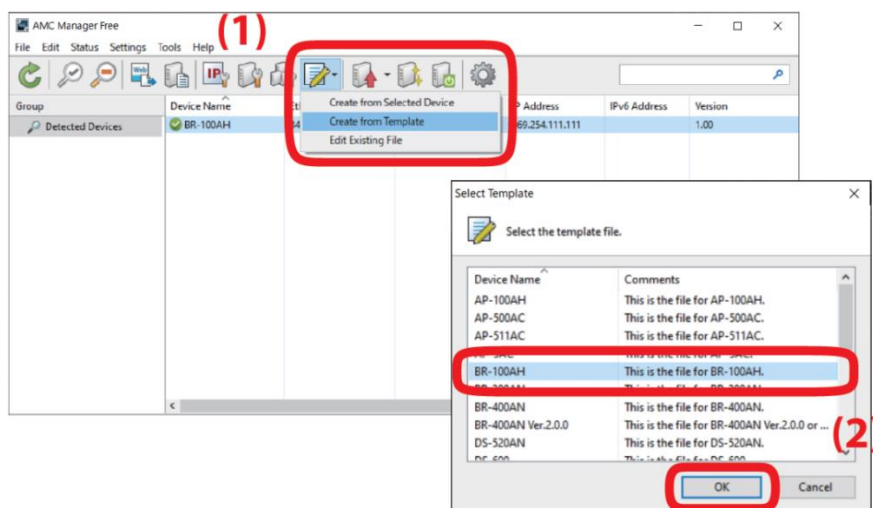

- 3.** In the **Create Configuration File** window, check the check box of the items you want to use for the configuration file, edit the settings, and click **Save**. In the dialog to save the configuration file, specify the file name and click **Save**.

The password shall be set for the first time configuration.

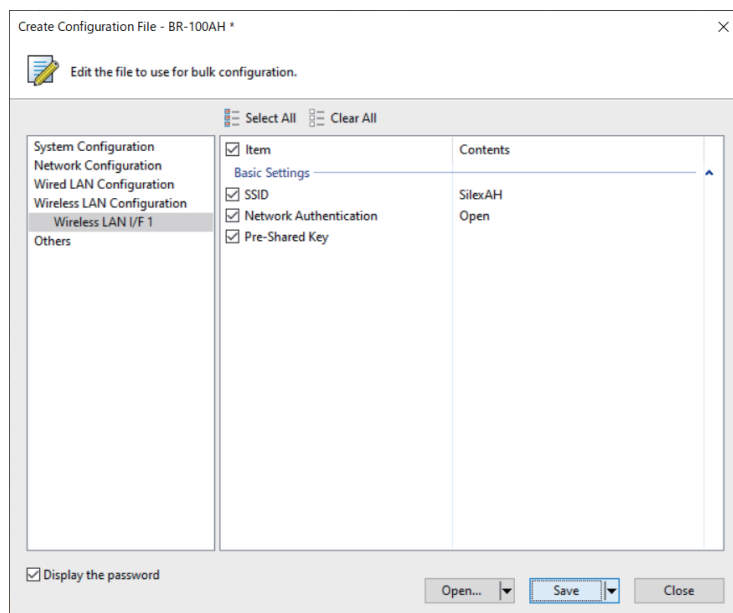
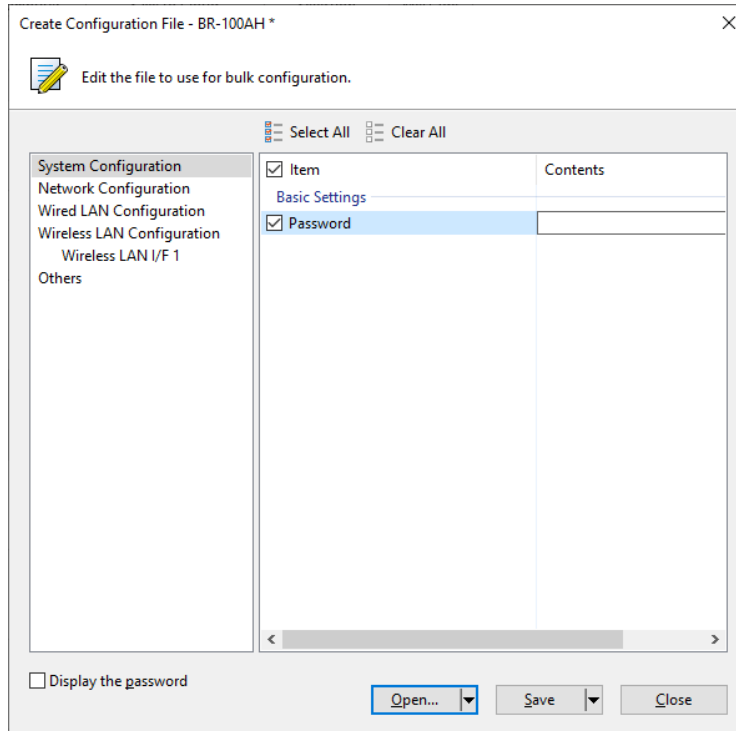

4. Select the BR-100AH unit to configure from the device list of AMC Manager®, and click the icon **Configure multiple devices in bulk**.

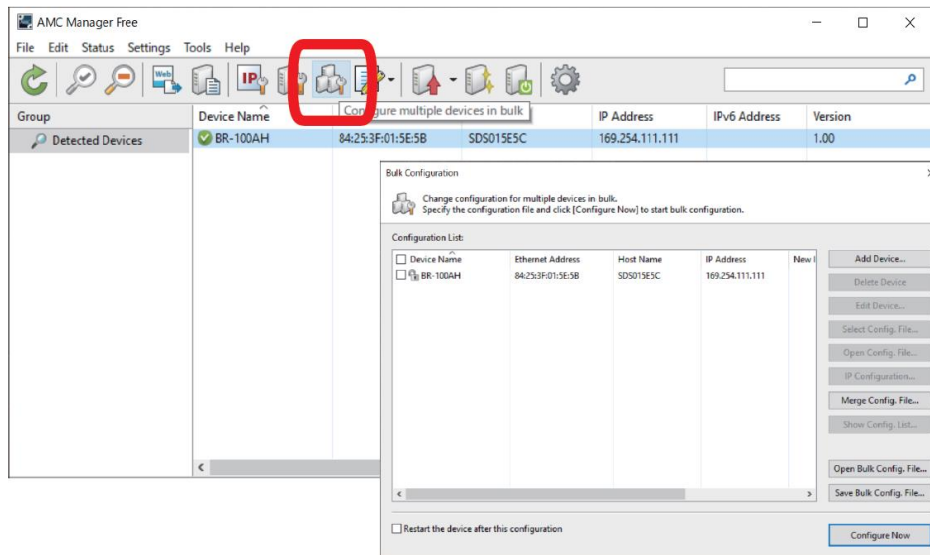

5. Select the BR-100AH unit to configure from the **Configuration List** (1) and click the **Select Config. File** button (2) in the **Bulk Configuration** window. When a file selection dialog appears, select the created configuration file and click **Open**.

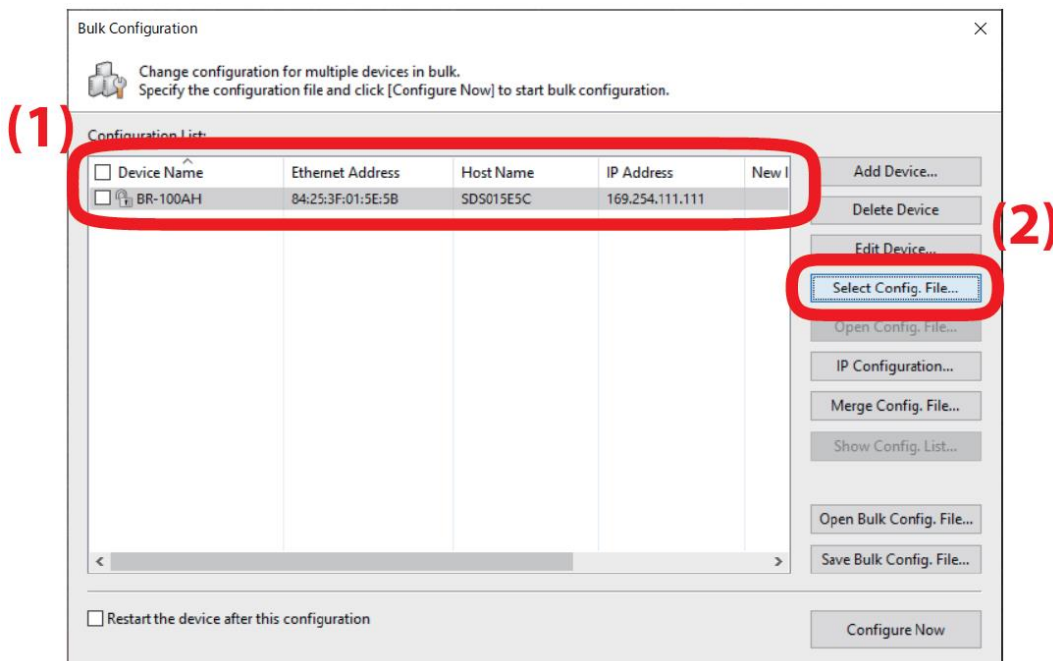

6. Check the check box of the BR-100AH unit to configure (1) and click **Configure Now** (2).

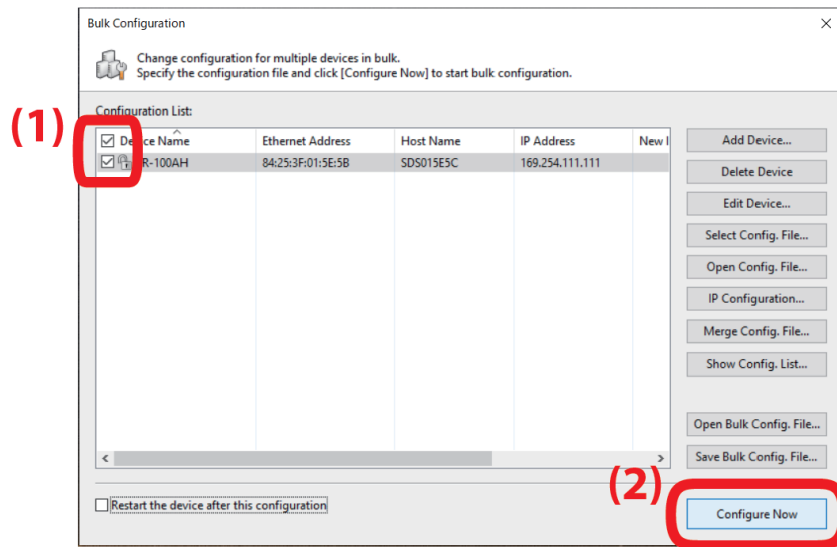

7. The configuration performs and the result is displayed. Click **Close**.

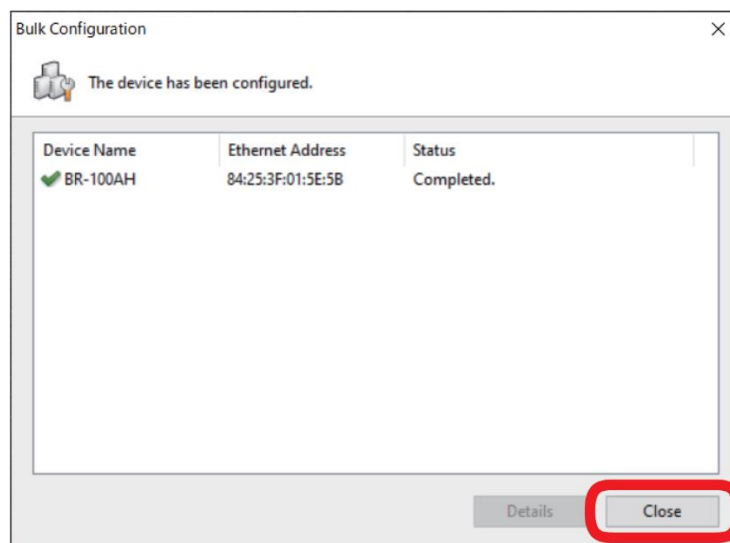

8. **Restart** the BR-100AH for your new configuration to take effect.

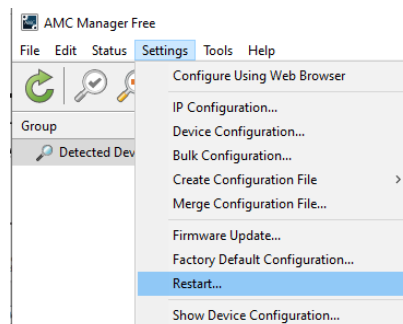

Connecting Non-wireless Devices

1. Turn off the non-wireless device(s) that you wish to use wirelessly and connect the BR-100AH to it using a network cable. The connection method will vary for each operating mode.

Single Client Connection

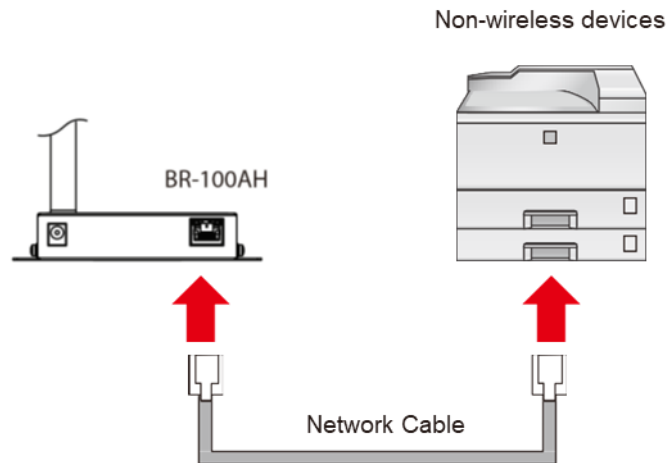

Multi-Client Connection

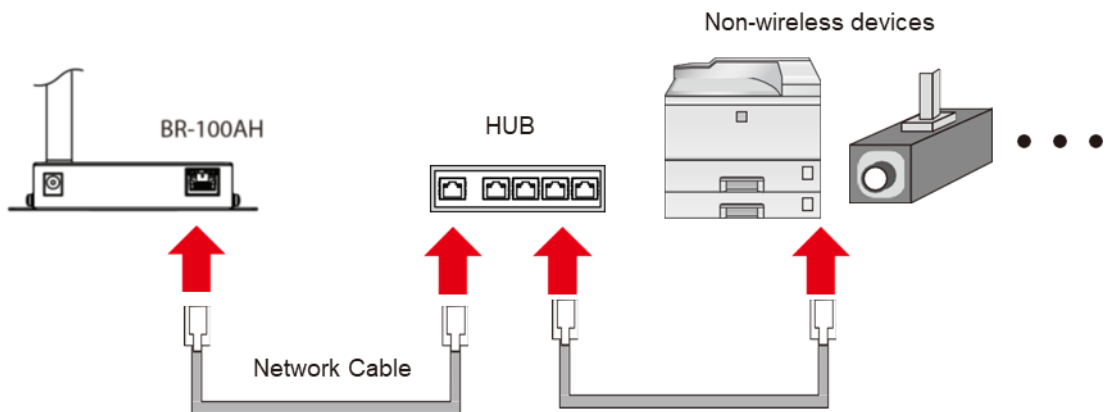

- 2.** Connect the AC adaptor to the BR-100AH and the AC plug to the outlet.

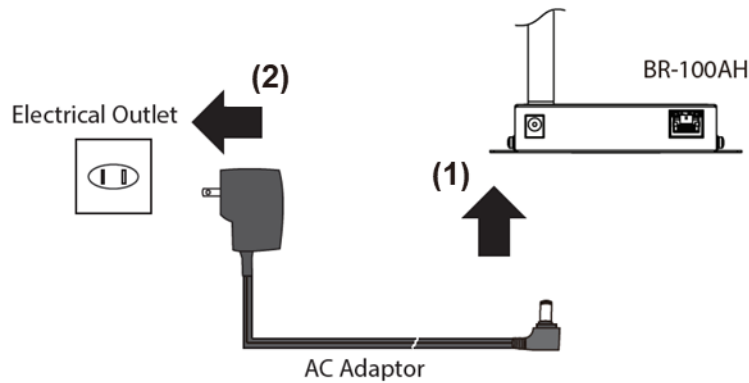

- 3.** Turn on the non-wireless device connected to the BR-100AH. When the wireless network is established, all LEDs turn on. The BR-100AH will be ready to use. You can use the non-wireless device over a wireless network.

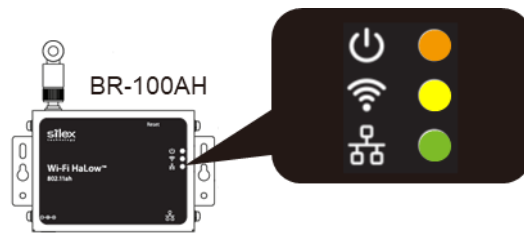

Note

- Depending on the non-wireless device you have connected, other network settings may need to be configured to that device. In such a case, please configure it according to the operating manual that came with your device.
- When you turn on the BR-100AH and your non-wireless device, be sure to turn on the BR-100AH first. Do not press the push switch then.

5. List of Functions

This chapter explains the BR-100AH functions.

5-1. Device Filter

The BR-100AH can allow only specific devices to bridge between the Ethernet port and the wireless network by “Device Filter” function. The function is enabled or disabled through the web configuration page or AMC Manager®. When it is disabled, any Ethernet devices connected to the BR-100AH are bridged to the wireless network. When it is enabled, only Ethernet device(s), of which MAC address(es) is/are registered in the BR-100AH, is/are bridged to the wireless network.

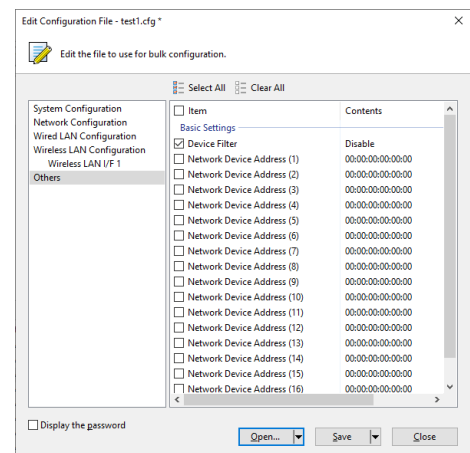
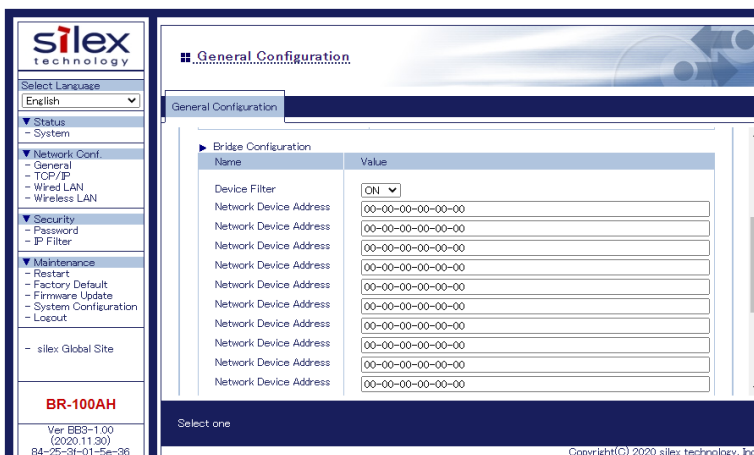

5-2. IP Access Control

The BR-100AH can allow only specific devices to access it for the device configuration by “IP Access Control” function. The IP address range, which can access the BR-100AH for the configuration, can be set through the web configuration page or AMC Manager®.

For example, when the range is specified from 169.254.111.109 to 169.254.111.110, only devices with the IP address of 169.254.111.109 and 169.254.111.110 can access the BR-100AH through web configuration page or AMC Manager®. The IP address range can be removed when it is not necessary.

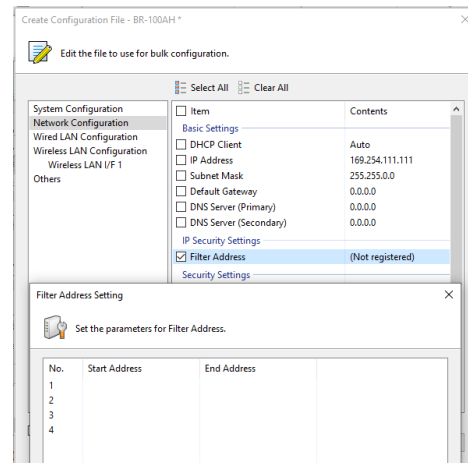
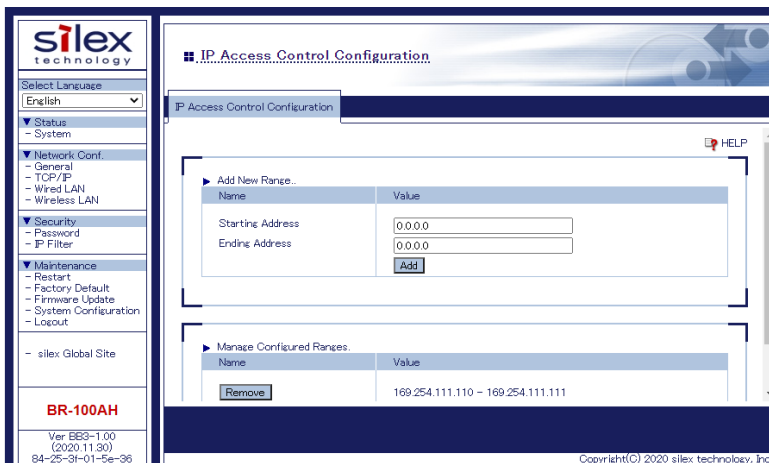

5-3. Web (HTTP/HTTPS)

The BR-100AH has web pages for settings. Various settings can be made from the web page. The BR-100AH can also be restarted or reset to the factory setting through the web page. Enter `http://169.254.111.111` (the IP address of BR-100AH's Ethernet port) on your web browser when the computer is connected to the BR-100AH through the Ethernet port. The scheme "https://" is available when HTTPS is enabled. If HTTP is disabled, `http://` accesses are redirected to `https://` URLs.

The BR-100AH supports TLS version 1.0/1.1/1.2. A self-signed certificate is alternatively applied if a server certificate is not set. CA certificate, local certificate and local private key can be loaded to secure HTTPS connection for the device configuration.

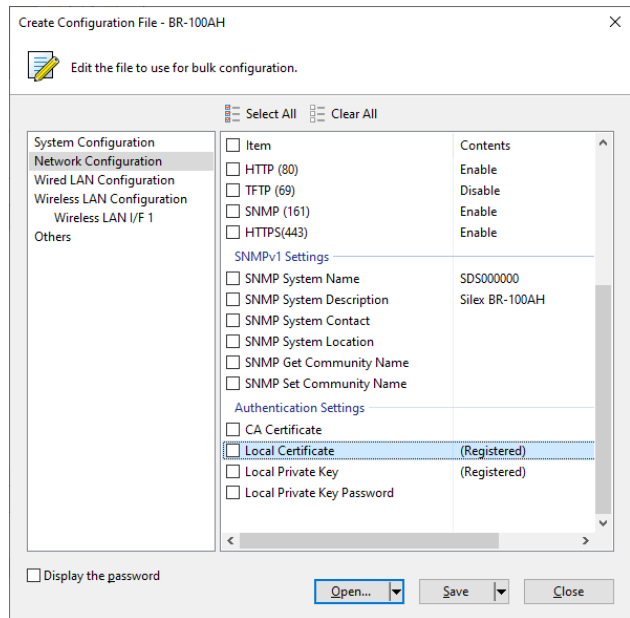

5-4. Maintenance

Restarting

How to restart BR-100AH by unplugging the AC adaptor:

1. Unplug the AC adaptor of BR-100AH from the outlet.

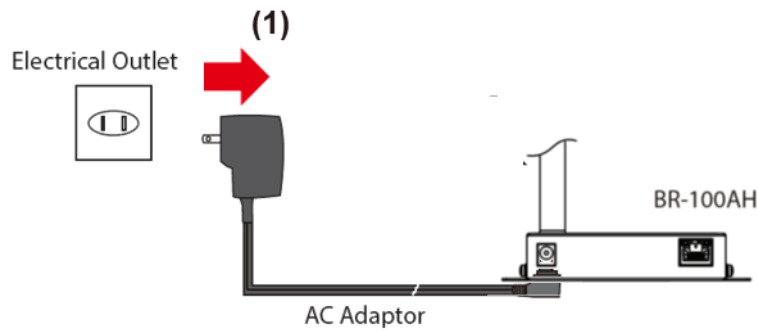

2. Plug the AC adaptor back into the outlet.

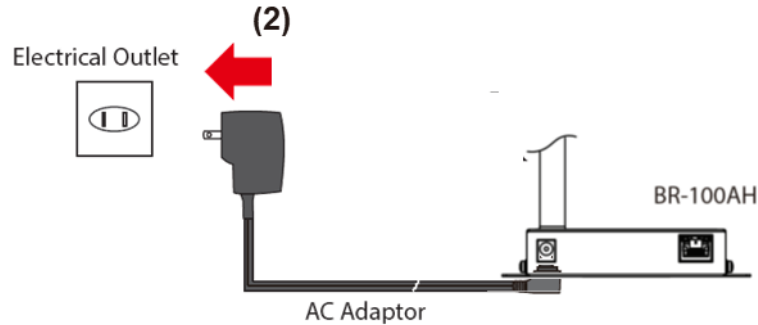

3. When the POWER LED turns on, the restart is completed.

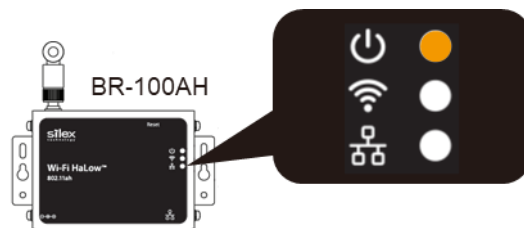

How to restart BR-100AH using the Web configuration interface:

1. Login to the Web configuration interface using your web browser.

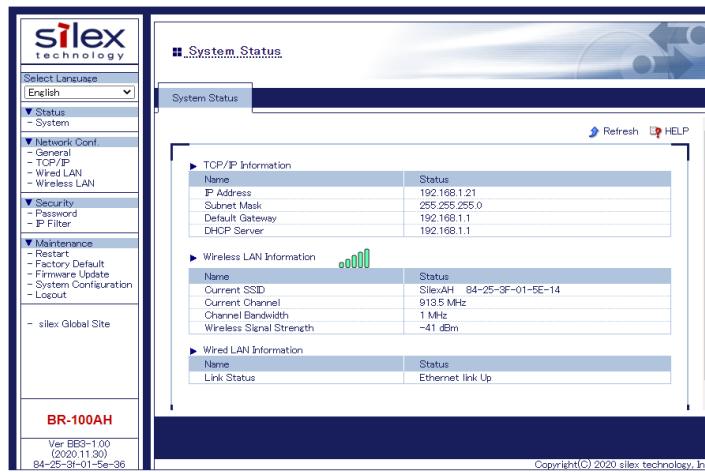

2. From the left menu on the Web configuration interface, click **Maintenance - Restart**. In the page displayed, click **Yes**.

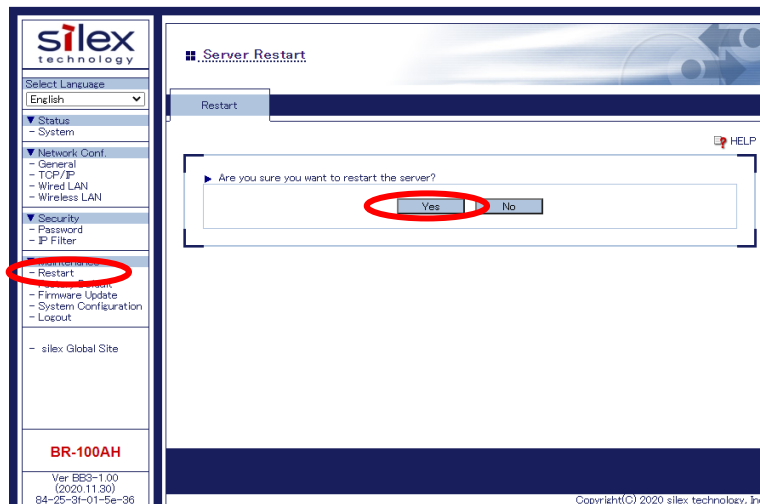

How to restart BR-100AH using AMC Manager®:

1. Right click the BR-100AH to restart and click **Restart**.

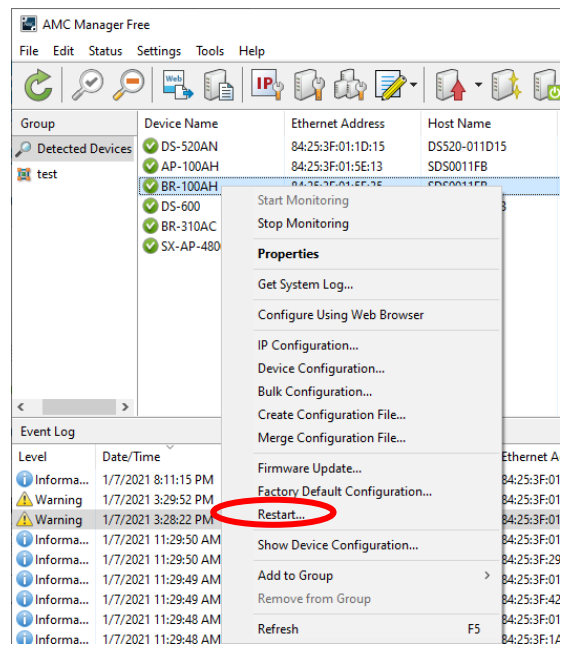

2. Click **Restart**. The pop-up window appears, then click **Yes**.

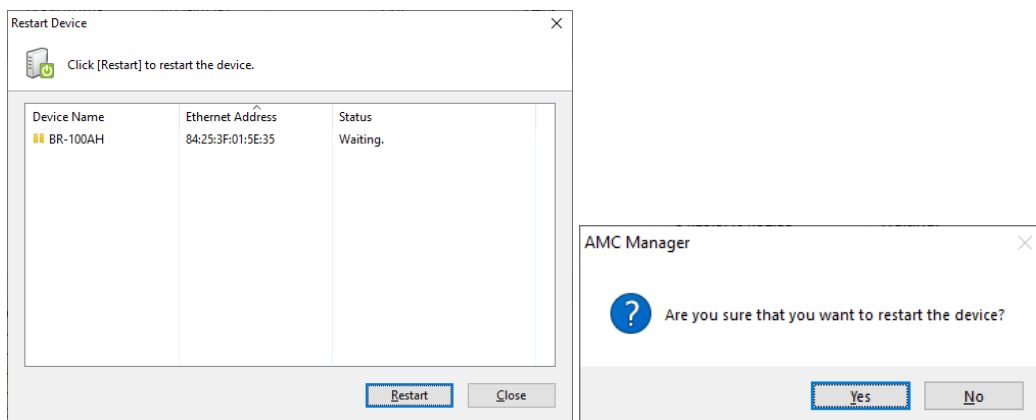

3. Enter the password for the BR-100AH and click **OK**. When the restart finishes, **Status** changes to **Completed**. (Password window appears only when the password is set.)

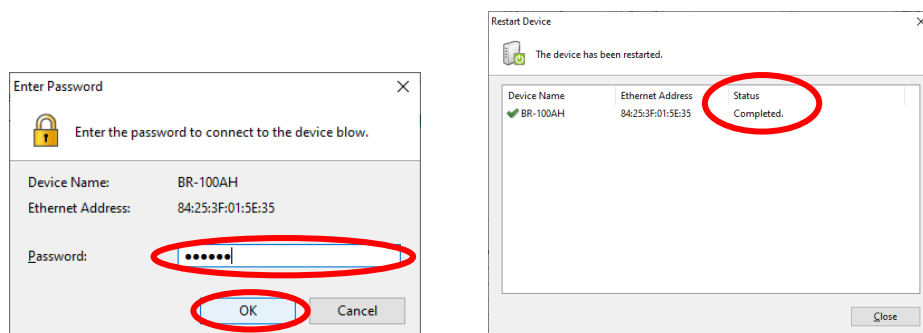

Factory Default Configuration

The BR-100AH can be reset to the factory default configuration except for the parameters listed in the table below:

Item name	Default value
General - General Settings	
System description	“Silex AP-100AH” or “Silex BR-100AH”
TCP/IP - CA Certificate	
Certificate File	None
TCP/IP - Local Certificate	
Certificate File	Self-signed Certificate
TCP/IP - Local Private Key	
Private Key File	Automatically generated
Password	None
Maintenance	
Firmware	Ver BB3-1.00 (2020.11.30)

How to reset BR-100AH to factory defaults using the Push Switch:

1. Press and hold the push switch on the back side of the BR-100AH for more than 5 seconds, and release it while the BR-100AH is powered on.
Confirm that LEDs except for the power LED turns off after releasing the push switch.

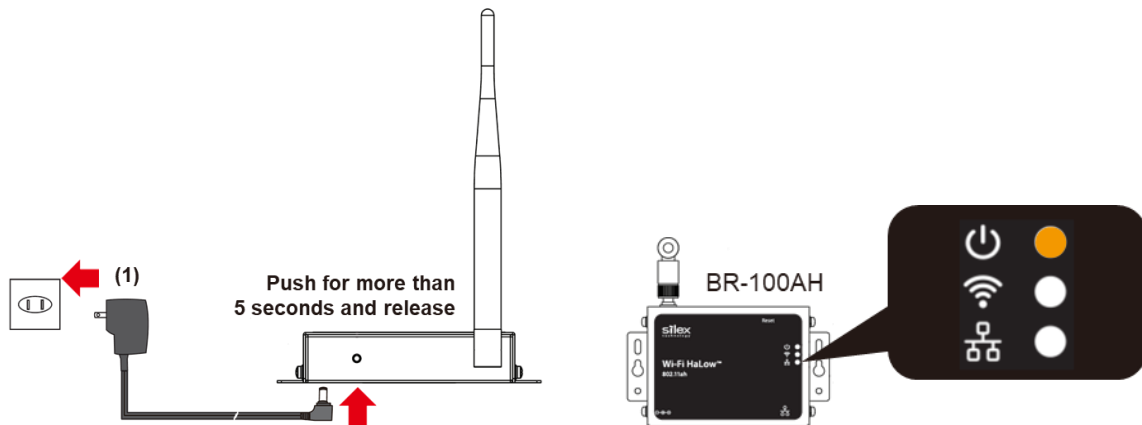

How to reset BR-100AH to factory defaults using the Web configuration interface:

1. Login to the Web configuration interface using your web browser.

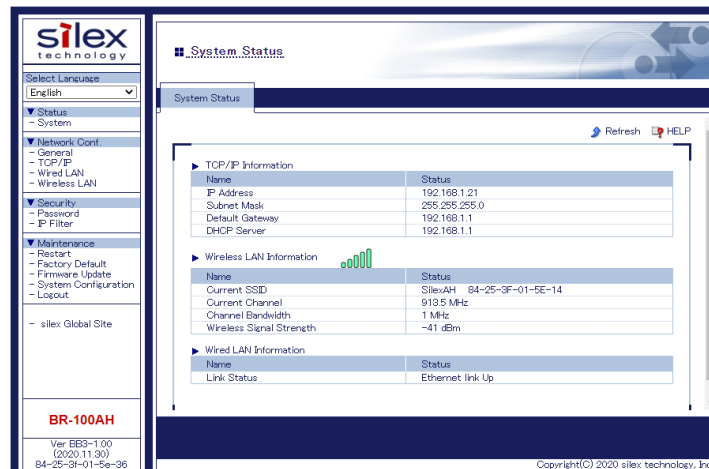

2. From the left menu on the Web configuration interface, click **Maintenance – Factory Default**. In the page displayed, click **Yes**.

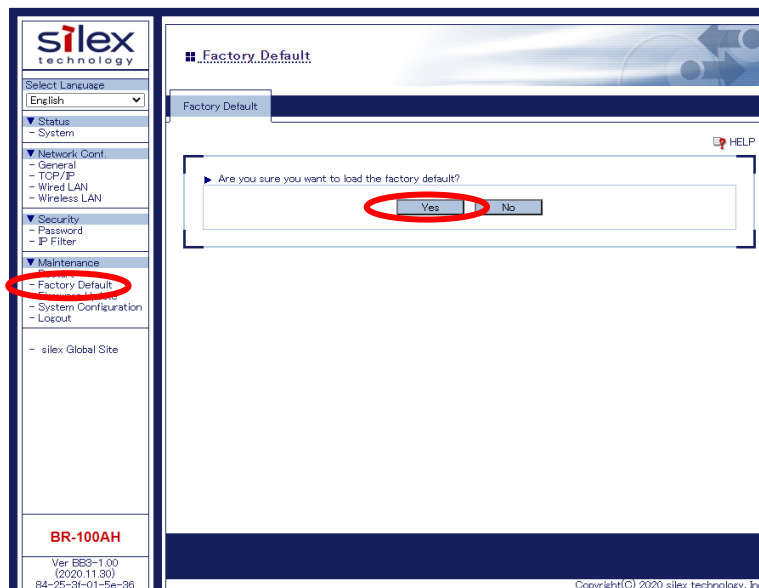

3. After the factory default configuration is completed, the BR-100AH will automatically restart. The web configuration page can be accessible again through the Ethernet port by 169.254.111.111.

How to reset BR-100AH to factory defaults using AMC Manager®:

1. Right click the BR-100AH to restart and click **Factory Default Configuration**.

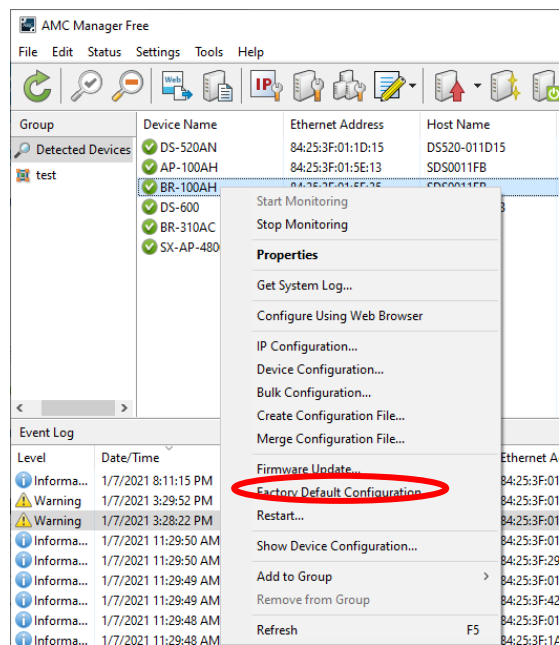

2. Check the check box of **Restart the device after the factory default configuration**, and click **Reset**. The pop-up window appears, then click **Yes**.

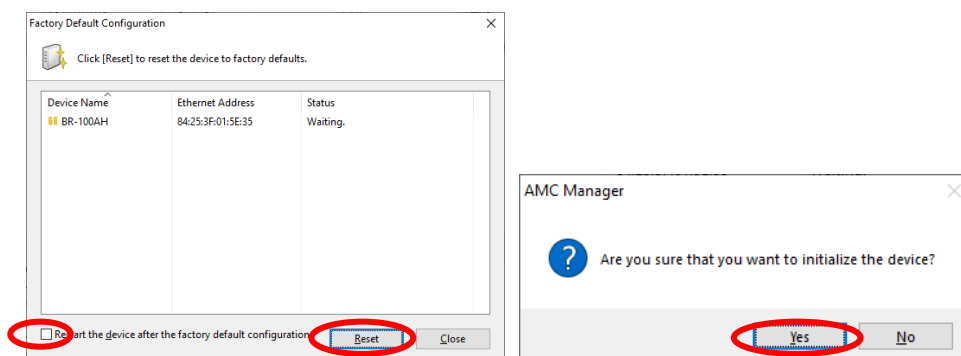

3. Enter the password for the BR-100AH and click **OK**. When the restart finishes, **Status** changes to **Completed**.

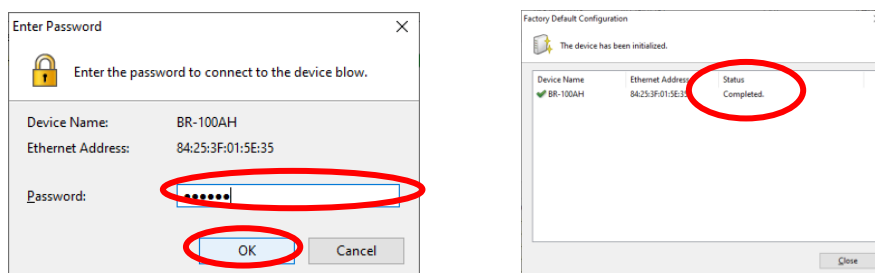

Firmware Update

The latest firmware file can be downloaded from our website when it is available.

See the instructions below to download the firmware file. For how to upload the firmware file to BR-100AH, refer to the firmware update procedure sheet file contained in the firmware file you download.



Note

- The current firmware version can be identified at the bottom left of the Web configuration interface.

Firmware Update Procedure:

1. Access our website below.

URL	
USA / Europe	https://www.silextechnology.com/connectivity-solutions/device-connectivity/br-100ah

2. Go to the support section and download the firmware file.
3. Extract the downloaded file to your folder. XXXX.bin (binary file) will be found.
4. Access the BR-100AH's web configuration page. IP address of the BR-100AH is one of the following:
 - If the BR-100AH can be connected to your computer with the Ethernet cable directly, you can access the BR-100AH with 169.254.111.111
 - If you don't know the IP address of the BR-100AH's wireless interface, AMC Manager® should find the IP address of BR-100AH's wireless interface.

Group	Device Name	Ethernet Address	Host Name	IP Address	IPv6 Address	Version	Status
Detected Devi	DS-320AN	84.25.3F.01.1D.15	D5520-011D15	192.168.0.163		1.4.0	Active
	AP-100AH	84.25.3F.01.5E.13	S050011F8	192.168.0.4		1.2.0	Active
	BR-100AH	84.25.3F.01.5E.35	S050011F8	192.168.0.37		1.2.0	Active
	DS-600	84.25.3F.1A.25.E3	D5600-1A25E3	192.168.0.3		1.4.1	Active
	BR-310AC	84.25.3F.29.A6.64	SX29A664	192.168.0.227		1.2.0	Active
	SV-AP-4800AN2	84.25.3F.42.9B.81	SX429B81	192.168.0.12		1.1.1	Active

Level	Date/Time	Event	Device Name	Ethernet Address	Host Name	Details
Informa...	1/29/2021 2:59:29 PM	Device detection	BR-100AH	84.25.3F.01.5E.35	S050011F8	Device was found.
Informa...	1/29/2021 2:59:08 PM	Device detection	BR-310AC	84.25.3F.29.A6.64	SX29A664	Device was found.
Informa...	1/29/2021 2:59:07 PM	Device detection	SV-AP-4800AN2	84.25.3F.42.9B.81	SX429B81	Device was found.
Informa...	1/29/2021 2:59:07 PM	Device detection	AP-100AH	84.25.3F.01.5E.13	S050011F8	Device was found.
Informa...	1/29/2021 2:59:06 PM	Device detection	DS-600	84.25.3F.1A.25.E3	D5600-1A25E3	Device was found.
Informa...	1/29/2021 2:59:06 PM	Device detection	DS-320AN	84.25.3F.01.1D.15	D5520-011D15	Device was found.

5. Login to the BR-100AH device configuration page.

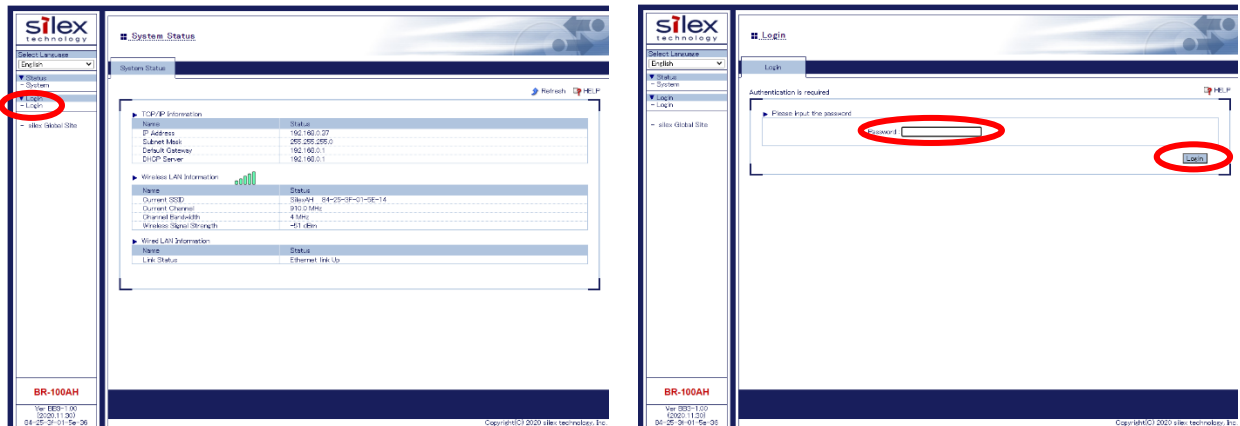

6. Click **Firmware Update** and click **Choose File**. A pop-up window appears to select the firmware image. Please select the binary file found in step 3.

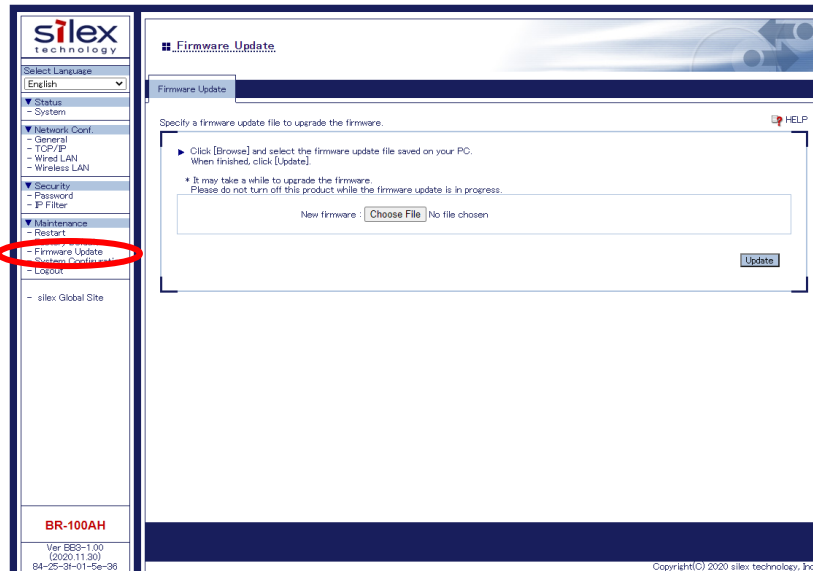

7. Click **Update** once the firmware binary file is selected.

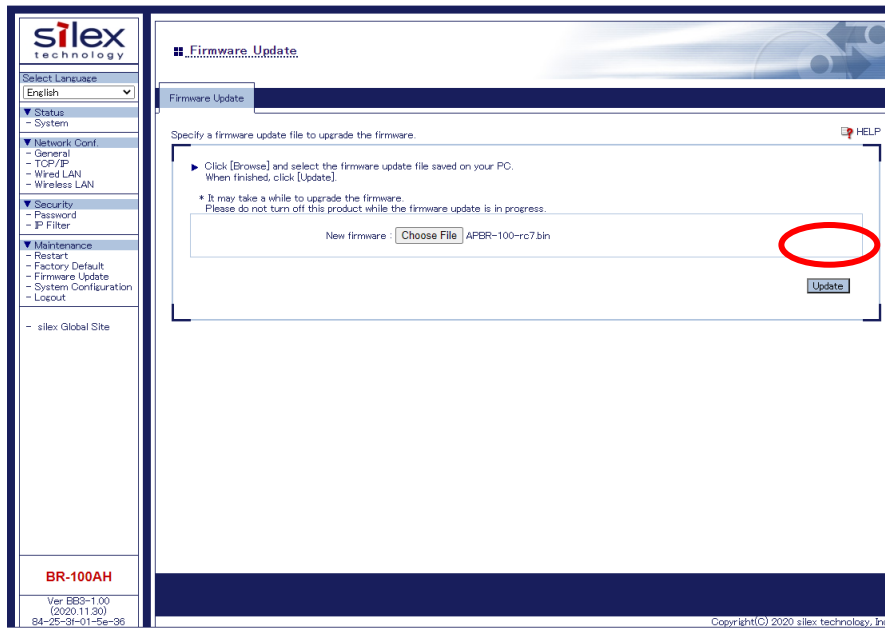

8. Click **OK**.

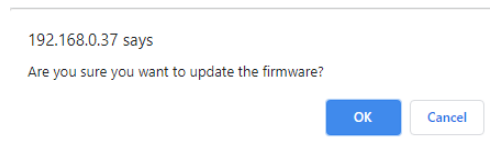

9. Please wait until the firmware update completes. Once it completes, the default page of the web configuration will appear.

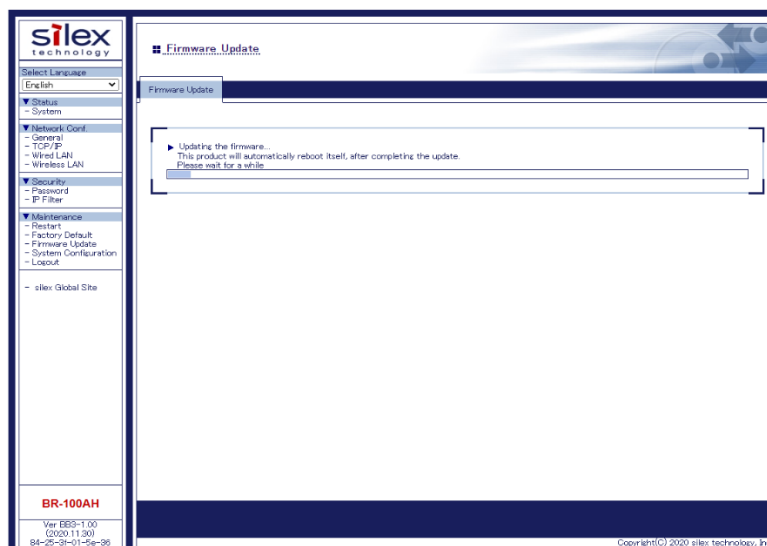

A. Appendix

A-1. List of All Settings

The BR-100AH has the following configuration items:

General Configuration – General Settings	
System Name	
Details	A name of the BR-100AH
Range	Maximum of 32 characters
Default Value	SDSxxxxxx
Note	“xxxxxx” is 3 bytes of the MAC address
System Description	
Details	Description of the BR-100AH
Range	Maximum of 64 characters
Default Value	Silex BR-100AH
System Contact	
Details	A contact to manage the system.
Range	Maximum of 63 characters
Default Value	<blank>
System Location	
Details	A location where the BR-100AH is installed
Range	Maximum of 16 characters
Default Value	<blank>
SNMP Get Community Name	
Details	A community name to be used to get SNMP information from the BR-100AH
Range	Maximum of 16 characters
Default Value	<blank>
Note	The value does not appear on the web page
SNMP Set Community Name	
Details	A community name to be used to set SNMP items of the BR-100AH
Range	Maximum of 16 characters
Default Value	<blank>
Note	The value does not appear on the web page

General Configuration – Bridge Configuration

Device Filter

Details	Enable/Disable the device filter function
Range	OFF/ON
Default Value	OFF

Network Device Address

Details	Mac address of devices that the BR-100AH allows to bridge to a wireless network
Range	Max 17 characters
Default Value	00-00-00-00-00-00
Note	Up to 16 MAC addresses can be registered. When the filter function is disabled, the communication is bridged to wireless network even when it is an access from the devices not registered to the Network Device Address.

TCP/IP Configuration – TCP/IP Configuration

DHCP

Details	IP address setting method To assign an IP address using DHCP, the DHCP server must be running in your subnetwork.
Range	AUTO/DHCP/STATIC
Default Value	AUTO

IP Address

Details	Set the IP address of the wireless interface. If the DHCP is enabled on your network, the IP Address obtained from it will be applied.
Range	0.0.0.0 - 255.255.255.255
Default Value	169.254.111.111

Subnet Mask

Details	Set the subnet mask of the wireless interface. If the DHCP is enabled on your network, the IP Address obtained from it will be applied.
Range	0.0.0.0 - 255.255.255.255
Default Value	255.255.0.0

Default Gateway

Details	Set the default gateway IP address of the wireless interface. If the DHCP is enabled on your network, the IP Address obtained from it will be applied.
Range	0.0.0.0 - 255.255.255.255
Default Value	0.0.0.0

DNS Server (Primary)

Details	Set the DNS primary server
Range	0.0.0.0 - 255.255.255.255
Default Value	0.0.0.0

DNS Server (Secondary)

Details	Set the DNS primary server
Range	0.0.0.0 - 255.255.255.255
Default Value	0.0.0.0

TCP/IP Configuration – IP Protocol Configuration	
HTTP(80)	
Details	Enable/Disable HTTP protocol
Range	ON/OFF
Default Value	ON
Note	Disabling HTTP will prevent access to the BR-100AH web server via the browser interface
HTTPS(443)	
Details	Enable/Disable HTTP protocol
Range	ON/OFF
Default Value	ON
Note	Disabling HTTPS will prevent access to the BR-100AH web server via the browser interface
TFTP(69)	
Details	Enable/Disable TFTP protocol
Range	ON/OFF
Default Value	OFF
SNMP(161)	
Details	Enable/Disable SNMP protocol
Range	ON/OFF
Default Value	ON

TCP/IP Configuration - CA Certificate

Current Setting

Details	Information of a CA certificate imported to the BR-100AH. This certificate can be deleted.
Range	PEM Encoded X509 file
Default Value	Note installed

Certificate File

Details	Upload a CA certificate
Range	PEM Encoded X509 file
Default Value	Note installed

The certificate file must support the followings:

- File format
 - PEM format(*.pem)
- Public key algorithm
 - RSA
- Public key size
 - 2048bit
- Signature algorithm
 - SHA-256 with RSA
 - SHA-384 with RSA
 - SHA-512 with RSA

TCP/IP Configuration - Local Certificate

Current Setting

Details	Information of a server certificate imported to the BR-100AH. This certificate can be deleted.	
Range	PEM Encoded X509 file	
Default Value	Self-signed certificate	
	Item	Description
	X.509 Certificate Version	v1
	Public Key Algorithm	RSA
	Public Key Length [bits]	2048
	Signature Algorithm	SHA256withRSA
	Common Name (CN)	SDSxxxxxx (from the System Name setting)
	Organization (O)	silex technology, Inc.
	Locality (L)	Seika
	State or Province Name (ST)	Kyoto
	Country Name (C)	JP
	Not Before	May 1 01:00:00 2017 GMT
	Not After	May 1 01:00:00 2117 GMT

Certificate File

Details	Upload a server certificate
Range	PEM Encoded X509 file
Default Value	Self-signed certificate
Note	<p>The certificate file must support the followings:</p> <ul style="list-style-type: none"> - File format PEM format(*.pem) - Public keyalgorithm RSA - Public key size 2048bit - Signature algorithm SHA-256 with RSA SHA-384 with RSA SHA-512 with RSA

TCP/IP Configuration – Local Private Key

Current Setting

Details	Information of a private key imported to the BR-100AH. This certificate can be deleted.
Range	PEM Encoded X509 file
Default Value	Automatically generated

Private Key File

Details	Upload a private key
Range	PEM Encoded X509 file
Default Value	Automatically generated

Password

Details	A password which protects the private key
Range	8 – 63 alphanumeric
Default Value	<blank>

Wired LAN Configuration – Wired LAN Basic Configuration

LAN Interface

Details	Configure the physical network type. Usually, " AUTO " is used.
Range	AUTO / 10 Half / 10 Full / 100 Half / 100 Full
Default Value	AUTO
Note	If a LINK LED on the connected device does not light on when BR-100AH is powered on, change the network type to that of the connected device.

Wireless LAN Configuration – Wireless LAN Basic Configuration

SSID

Details	SSID of wireless LAN that the BR-100AH connects
Range	1 – 32 characters (alphanumeric, hyphen, underscore)
Default Value	SilexAH

Network Authentication

Details	An authentication method for connection with a wireless access point.
Range	Open/Enhanced Open/WPA2-Personal/WPA3-Personal
Default Value	Open

Wireless LAN Configuration – WPA/WPA2 Configuration

Pre-Shared Key

Details	A Pre-Shared Key for AES-128
Range	WPA2: 8 – 63 characters password or 64 characters hexadecimal PSK WPA3: 8 – 63 characters password
Default Value	Device Server

Password Configuration

Password

Details	Configure the password to manage the BR-100AH. This password is used for authentication to login to the Web configuration interface of BR-100AH.
Range	Up to 8 characters
Default Value	(None)

IP Access Control Configuration – Add New Range

Starting Address/Ending Address

Details	An address range of the remote host IP to access the BR-100AH for its configuration.
Range	0.0.0.0 – 255.255.255.255
Default Value	0.0.0.0

A-2. Troubleshooting

This section provides the solutions for possible troubles you may experience when you are configuring or using the BR-100AH.

I cannot access the BR-100AH through a web browser and/or AMC Manager®

A computer may belong to a different network from the BR-100AH

Solution	Please check the IP addresses of the BR-100AH and the computer. If they are in the different network, please change the IP address of one of the BR-100AH and the computer.
----------	---

The IP address of the PC may be blocked by IP Filter function

Solution	Please try to change PC's IP address to be in the range of allowed IP addresses. If it is not practical to identify the IP address, please reset the product to the factory configuration with the push switch and reconfigure the BR-100AH.
----------	--

HTTP/HTTPS protocol may be disabled

Solution	If you cannot access the web configuration page, HTTP/HTTPS protocols may be disabled. Please access the BR-100AH with AMC Manager®.
----------	--

I cannot access the non-wireless device connected to a LAN port of the BR-100AH.

The bridge feature may be aborted as the non-wireless device is unplugged and changed to the other device on the LAN port.

Solution	Restart the BR-100AH. If the non-wireless device is unplugged and changed to the other device, BR-100AH will abort bridging of that device, taking such occurrence as an error. Also, when the MAC address filtering is used to restrict the devices to bridge, you will need to change the setting registered to Network Device Address .
----------	--

The BR-100AH or non-wireless device may not be operating correctly.

Solution	Please check the LED status on BR-100AH. Please also check that the non-wireless device is properly powered on.
----------	---

The connection may be restricted by the MAC address filtering on BR-100AH.

Solution	See the setting at Network Device Address to check that access of the connected device is not restricted by the MAC address filtering.
----------	---

I cannot connect to BR-100AH in Ad hoc mode.

BR-100AH does not support Ad hoc mode.	
Solution	Only Infrastructure mode can be used.