

INSTALLATION INSTRUCTIONS

Lock

①

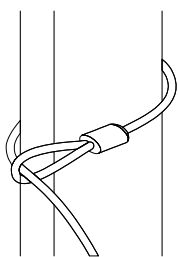

Wrap your cable around an immovable object by feeding the lock body through the loop on the opposite end of the cable.

②

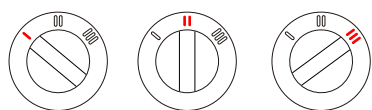

Noble Nano Standard

You must adjust the locking tip before inserting the lock into your device.

Adjust the locking tip according to the lock slot specification of your device.

③

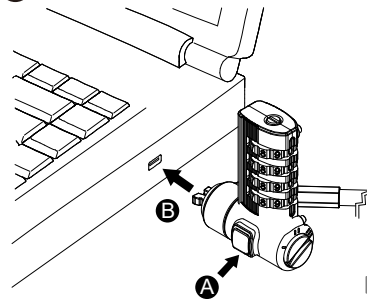

Press the release button and insert the locking tip into the slot.

④

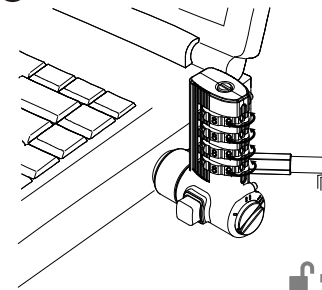

Scramble the dials to lock the device.

✓

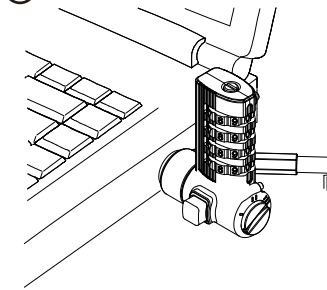

Unlock

①

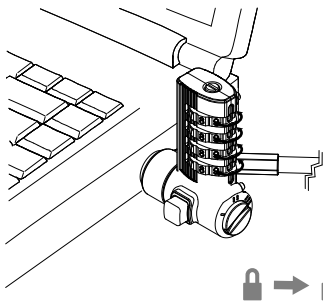

Turn the dials to the correct combination to unlock the device.

②

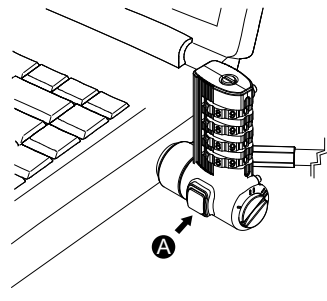

Press the release button to release the lock.

✓

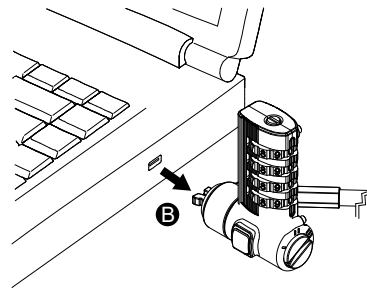

Record Your Combination

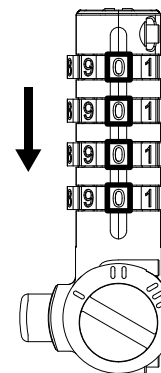

Keep your combination in a safe and accessible place for future reference.

Locking Tip Adjustment

Use a small flathead screwdriver or similar tool to switch the knob. Adjust the locking tip according to the lock slot specification of your device.

Noble Slot

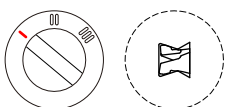

Nano Slot

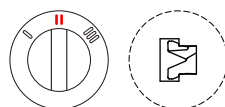

Standard Slot

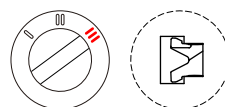

⚠ The Knob can only be switched when the lock is unlocked.

Removable Rubber Grommet

For computers that have a tighter security lock fit it is necessary to remove the grommet on the cable lock.

①

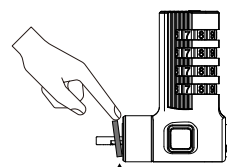

Removable Grommet

②

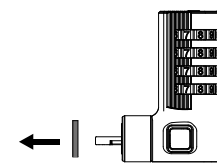

③

