

GV-SNVR System

User's Manual

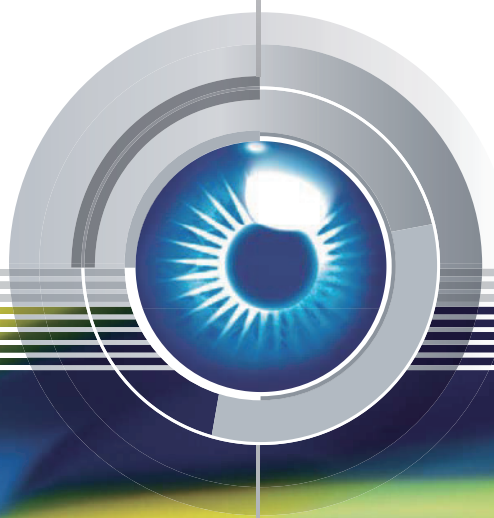



© 2021 GeoVision, Inc. All rights reserved.

Under the copyright laws, this manual may not be copied, in whole or in part, without the written consent of GeoVision.

Every effort has been made to ensure that the information in this manual is accurate. GeoVision, Inc. makes no expressed or implied warranty of any kind and assumes no responsibility for errors or omissions. No liability is assumed for incidental or consequential damages arising from the use of the information or products contained herein. Features and specifications are subject to change without notice.

Note: No memory card slot or local storage function for Argentina.

GeoVision, Inc.
9F, No. 246, Sec. 1, Neihu Rd.,
Neihu District, Taipei, Taiwan
Tel: +886-2-8797-8377
Fax: +886-2-8797-8335
<http://www.geovision.com.tw>

Trademarks used in this manual: *GeoVision*, the *GeoVision* logo and GV series products are trademarks of GeoVision, Inc. *Windows* is the registered trademark of Microsoft Corporation.

March 2021

Preface

Welcome to the *GV-SNVR System User's Manual*.

The GV-SNVR System has a series of models designed to meet different needs. This manual is designed for the following models:

Models
GV-SNVR0400F
GV-SNVR0411
GV-SNVR0412
GV-SNVR0811
GV-SNVR0812
GV-SNVR1600
GV-SNVR1611

Caution

- The GV-SNVR System is designed for indoor use only.

Contents

Chapter 1 Introduction.....	1
1.1 Features.....	2
1.2 Models	3
1.3 Packing List and Package.....	3
1.3.1 GV-SNVR Single Package	4
GV-SNVR0400F.....	4
GV-SNVR0411	4
GV-SNVR0412.....	5
GV-SNVR0811	5
GV-SNVR0812.....	6
GV-SNVR1600.....	6
GV-SNVR1611	7
1.3.2 GV-SNVR Bundled Package	7
GV-SNVR0400F.....	7
1.4 Compatible Products and System Requirements.....	8
1.4.1 Supported GV-IP Cameras.....	8
1.4.2 Supported GeoVision Applications	9
1.4.3 System Requirements	10
1.5 Optional Accessories	11
1.6 Overview	12
1.6.1 Front View	12
1.6.2 Rear View.....	18
Chapter 2 Getting Started.....	25
2.1 Installation.....	25
2.1.1 GV-SNVR0411	25
2.1.2 GV-SNVR0811	27
2.1.3 GV-SNVR0400F	29
2.1.4 GV-SNVR1600	31
2.1.5 GV-SNVR1611	33
2.1.6 GV-SNVR0412 / 0812.....	35
2.2 Connecting the GV-SNVR.....	37
2.2.1 Network Connection for GV-SNVR1600.....	41
2.2.2 Accessing the GV-SNVR	42

2.3	Setting Up IP Cameras	43
2.3.1	Automatically Setting Up IP Cameras	43
2.3.2	Manually Connecting GV-IP Cameras.....	45
2.3.3	Manually Connecting Third-Party IP Cameras	46
2.3.4	Changing Camera IP Address and Assigning Channels.....	48
2.4	Formatting Hard Drive.....	49
2.5	Main Screen.....	51
2.6	Enabling Recording.....	53
2.7	Playing Back Video	53
2.8	Live Monitoring.....	54
2.8.1	Snapshot.....	54
2.8.2	Audio	55
2.8.3	PTZ Control.....	57
2.8.4	Digital PTZ Function.....	58
2.8.5	Fisheye Dewarping	59
2.8.6	Image Orientation.....	60
Chapter 3	System Configuration	61
3.1	Camera	61
3.1.1	GV-IP Camera Settings	61
3.1.2	Third-Party IP Camera Settings (ONVIF)	64
3.2	Recording.....	66
3.3	Network.....	67
3.3.1	WAN / LAN.....	67
3.3.2	WiFi.....	70
3.3.3	DDNS	71
3.3.4	E-Mail.....	72
3.3.5	Web Server	73
3.4	Storage	74
3.5	Display	74
3.6	Service.....	76
3.6.1	Connecting GV-SNVR with GV-Center V2 and GV-Vital Sign Monitor.....	76
3.6.2	Regulating People Flow with GV-IP Cameras	78
3.6.3	Connecting GV-Eye to GV-SNVR.....	78
3.6.4	Connecting GV-Cloud Center to GV-SNVR.....	79
3.7	Event.....	80
3.8	System.....	82

3.9 Account.....	85
Chapter 4 Video Playback	87
4.1 Timeline Player	87
4.2 Recording Backup.....	89
Chapter 5 Remote Access to the GV-SNVR	90
5.1 Accessing through Web browser	91
5.1.1 Live View Screen.....	92
5.1.2 Camera Settings via Web.....	94
5.1.3 Snapshot of Live Video	95
5.1.4 Picture-in-Picture View	96
5.1.5 Picture-and-Picture View	97
5.1.6 Digital PTZ Control.....	98
5.1.7 Fisheye View	99
5.2 Accessing through SNVR Viewer.....	102
5.2.1 Live View through SNVR Viewer	103
5.2.2 Playback through SNVR Viewer.....	105
5.2.3 Snapshot & Video Export through SNVR Viewer	107
5.3 Accessing through Mobile Device	108
5.4 Accessing through GV-Edge Recording Manager.....	108
5.5 Accessing through GV-Control Center	109
5.6 Accessing through RTSP	109
Chapter 6 Advanced Applications	110
6.1 Upgrading System Firmware	110
6.1.1 Safe Mode of GV-SNVR1611	111
6.2 Using the GV-IP Device Utility.....	112
6.2.1 Looking Up the IP Address.....	112
6.2.2 Accessing the Live View.....	112
6.2.3 Upgrading System Firmware.....	113
6.2.4 Backing Up and Restoring Settings.....	114
6.2.5 Restoring to Factory Default Settings.....	116
Appendix	117
A. Tested and Supported Hard Disk Drives.....	117
B. Live View Streaming	119
C. Supported Resolution by GV-SNVR	121

Chapter 1 Introduction

GV-SNVR is an H.264/H.265 Linux-embedded Standalone Network Video Recorder that records video files directly to the internal hard drive, supporting up to 4 / 8 / 16 channels of IP cameras for network surveillance. With the feature of a Full HD HDMI video output, the GV-SNVR eliminates the need of a separate PC to view and play back video images from the unit. Its USB ports allow you to connect a USB flash drive to import or export system settings, update firmware, save snapshot files and back up videos in AVI format.

Optionally, you can connect a GV-Joystick V2 to control connected PTZ cameras. In addition, you can remotely access the live view and recorded videos through mobile devices, SNVR Viewer or Web browsers with advanced video features.

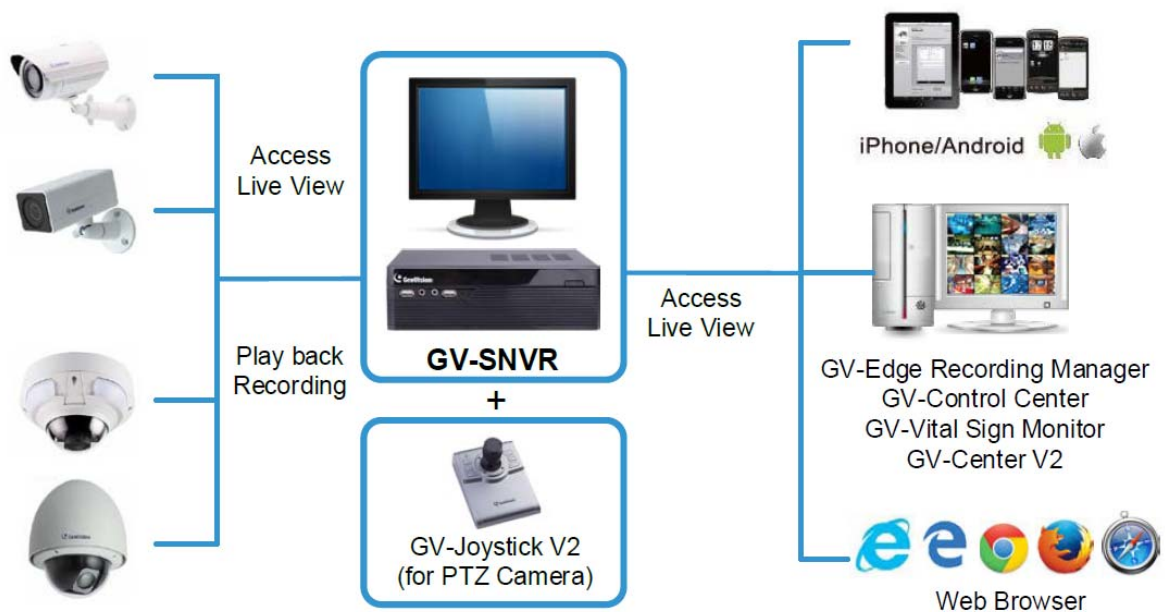

Figure 1-1

1.1 Features

- 4-Channel video recording (for GV-SNVR0400F / 0411 / 0412)
- 8-Channel video recording (for GV-SNVR0811 / 0812)
- 16-Channel video recording (for GV-SNVR1600 / 1611)
- Automatic search and setup of IP cameras
- Support for third-party IP cameras through ONVIF and RTSP (for GV-SNVR0411 / 0412 / 0811 / 0812 / 1611)
- 4-Port PoE (IEEE 802.3af) for camera connection (for GV-SNVR0411)
- 4-Port PoE+ (IEEE 802.3at) for camera connection (for GV-SNVR0412)
- 8-Port PoE+ (IEEE 802.3at) for camera connection (for GV-SNVR0811 / 0812)
- 16-Port PoE+ (IEEE 802.3at) for camera connection (for GV-SNVR1611)
- Video Resolution

Model	Resolution
GV-SNVR0411 / 0412 / 0811 / 0812	Up to 3840 x 2160 per channel *
GV-SNVR1611	Up to 4000 x 3000 per channel *
GV-SNVR0400F	Up to 1920 x 1080 per channel *
GV-SNVR1600	Up to 2592 x 1944 for the first channel * Up to 1920 x 1080 per channel *

- Dual stream support
- Continuous, motion and scheduled recording
- Alarm-triggered recording for GV-SNVR0412 / 0812 / 1611
- Timeline playback
- Multi-channel playback
- Display of HDD status and system temperature
- DST (Daylight Saving Time) support
- NTP (Network Time Protocol) support
- GeoVision DDNS server support
- E-mail notification for recording error and password retrieval
- Recording export
- Remote live view through Web browser
- PTZ control using GV-Joystick V2 or on-screen panel

- HDD Storage

Model	Storage
GV-SNVR0411 / 0811	1 SATA HDD drawer (3.5") for up to 8 TB storage
GV-SNVR0412 / 0812	1 SATA HDD drawer (3.5") for up to 10 TB storage
GV-SNVR0400F	1 SATA HDD drawer (3.5") for up to 4 TB storage
GV-SNVR1600	4 SATA HDD drawer (3.5") for up to 16 TB storage
GV-SNVR1611	2 SATA HDD drawer (3.5") for up to 20 TB storage

- Smart device access (iOS and Android)
- Support for 13 languages (14 languages for GV-SNVR0411 / 0412 / 0811 / 0812 / 1611)

*The resolutions of streams 1 and 2 both must meet the requirements noted in Appendix C.

1.2 Models

The GV-SNVR has the following models:

GV-SNVR0400F	- Supports 1 SATA HDD (3.5")
GV-SNVR0411	- Records up to 4 IP channels
GV-SNVR0412	
GV-SNVR0811	- Supports 1 SATA HDD (3.5")
GV-SNVR0812	- Records up to 8 IP channels
GV-SNVR1600	- Supports 4 SATA HDD (3.5") - Records up to 16 IP channels
GV-SNVR1611	- Supports 2 SATA HDD (3.5") - Records up to 16 IP channels

1.3 Packing List and Package

You can choose to purchase a GV-SNVR0400F / 0411 / 0412 / 0811 / 0812 / 1600 / 1611 package or a GV-SNVR0400F bundled package, which includes 4 GV-Target IP Cameras of your choice, and with or without a GV-PoE switch.

1.3.1 GV-SNVR Single Package

GV-SNVR0400F



1. GV-SNVR0400F
2. AC power cord
3. AC/DC adapter
(DC 19V, 3.42A, 65 W)
4. Screw x 6 (for HDD)
5. SATA cable
6. Download Guide
7. Quick Start Guide
8. Warranty card

GV-SNVR0411



1. GV-SNVR0411
2. AC power cord
3. AC/DC adapter
(DC 52V, 1.38 A, 72 W)
4. SATA cable
5. HDD power cable
6. Screw x 4 (for HDD)
7. Rubber foot x 4 (for HDD)
8. USB mouse
9. Download Guide
10. Warranty card

GV-SNVR0412



1. GV-SNVR0412
2. AC Power cord
3. AC/DC adapter
(DC 48 V, 1.35 A, 65 W)
4. SATA cable
5. HDD power cable
6. Screw x 4 (for HDD)
7. USB mouse
8. Foam foot
9. Rack mount kit (2 L-shaped brackets + 4 screws)
10. Download Guide
11. Warranty card

GV-SNVR0811



1. GV-SNVR0811
2. AC Power cord
3. AC/DC adapter
(DC 56V, 2.32 A, 130 W)
4. SATA cable
5. HDD power cable
6. Screw x 4 (for HDD)
7. USB mouse
8. Download Guide
9. Warranty card

GV-SNVR0812



1. GV-SNVR0812
2. AC power cord
3. AC/DC adapter (DC 52V, 1.8A, 100W)
4. SATA cable
5. HDD power cable
6. Screw x 4 (for HDD)
7. Foam foot
8. USB mouse
9. Rack mount kit (2 L-shaped brackets + 4 screws)
10. Download Guide
11. Warranty card

GV-SNVR1600



1. GV-SNVR1600
2. AC power cord
3. SATA cable x 4
4. HDD mounting bracket kit (4 pairs and 32 screws included)
5. Rack mount kit (2 L-shaped brackets and 6 screws included)
6. Rubber foot x 4
7. USB mouse
8. Download Guide
9. Quick Start Guide
10. Warranty card

GV-SNVR1611



1. GV-SNVR1611
2. AC power cord
3. SATA cable x 2
4. HDD power cable x 2
5. Screw x 8 (for HDD)
6. Foam foot
7. USB mouse
8. Download Guide
9. Warranty card

1.3.2 GV-SNVR Bundled Package

GV-SNVR0400F



1. GV-SNVR0400F package x 1
2. Target IP Camera x 4
3. GV-POE0400 x 1

Note: For the Target IP Camera, select any 4 models from GV-EBL1100 / 2100, GV-EBX1100 / 2100, GV-EDR1100 / 2100, GV-EFD1100 / 2100. Contact your dealer for more information.

1.4 Compatible Products and System Requirements

1.4.1 Supported GV-IP Cameras

The GV-SNVR is compatible with the following GV-IP Cameras:

- GV-Target Series IP Cameras (Firmware V1.0 or later)
- GV-SD220/220-S (Firmware V1.04 or later)
- GV-UNFE2503 / UNP2500 (Firmware V2.11 or later)
- All other GV-IP Cameras **EXCEPT** for the models below:

GV-SNVR System	Not Supported Models
SNVR0400F	<ul style="list-style-type: none"> • GV-ABD1300 • GV-ABL Series / ADR Series / AVD Series / EBD Series / TBL Series / TDR Series / TVD Series • GV-BX110/12201 • GV-BL110 • GV-EBL2101 / 2111 / 3101 (conditionally supported) (*Note4) • GV-FD8700-FR
SNVR1600	<ul style="list-style-type: none"> • GV-FER12203 / 12700 • GV-Fisheye Cameras (conditionally supported) (*Note3) • GV-MFD110 • GV-PT110 • GV-PTZ010D • GV-SD010 / 200 / 200-S / 2301 / 2322-IR / 2411 / 2722-IR / 3732-IR • GV-VD8700 • GV-VR360
SNVR0411	<ul style="list-style-type: none"> • GV-BX110 • GV-BL110 • GV-FE520 / 521 • GV-FER12203 / 12700 • GV-MFD110 • GV-PT110 • GV-PTZ010D • GV-SD010
SNVR0412	
SNVR0811	
SNVR0812	
SNVR1611	

Note: The live view of GV-SD200 / 200-S / 2411 / 2322-IR / 3732-IR can be accessed through GV-SNVR0411 / 0811, but their PTZ control functions are only available on GV-SNVR0411 firmware V2.61 or later and GV-SNVR0811 firmware V2.50 or later.

IMPORTANT:

1. GV-SNVR supports a recording frame rate of up to 30 fps.
 2. GV-SNVR supports a total bandwidth of up to 50 Mbps for GV-SNVR0400F, 40 Mbps for GV-SNVR0411, 24 Mbps for GV-SNVR0412, 80 Mbps for GV-SNVR0811, 48 Mbps for GV-SNVR0812, 100 Mbps for GV-SNVR1600 and 320 Mbps for GV-SNVR1611.
 3. GV-SNVR1600 can only connect to GV-Fisheye Cameras, except for GV-FER12203 / 12700, via **channel 1** and does not support fisheye dewarping(*).
 4. GV-EBL2101 / 2111 / 3101 is only supported on **channel 1** of GV-SNVR0400F (*).
 5. Fisheye dewarping is only supported by GV-SNVR0411 / 0412 / 0811 / 0812. For details, see *2.8.5 Fisheye Dewarping*. **GV-SNVR1611 V3.11** only supports fisheye dewarping on GV-SNVR Viewer (V1.5.0001).
 6. For supported IP cameras, the resolutions of stream 1 and 2 both must meet the requirements noted in *Appendix C*.
-

1.4.2 Supported GeoVision Applications

GV-SNVR is compatible with the following applications:

For GV-SNVR0411 / 0811

- GV-Edge Recording Manager (Windows Version V1.2.0.0 or later)
- GV-Control Center (V3.4.0.0 or later)
- GV-Center V2 (V15.10 or later)
- GV-Vital Sign Monitor (V15.10 or later)
- GV-Eye (V2.3 or later)
- GV-Cloud Center (V1.0 or later)

For GV-SNVR0412 / 0812

- GV-Edge Recording Manager (Windows Version V1.4.0.3 / V1.4.0.0 or later for GV-SNVR0412 / 0812)
- GV-Control Center (V3.6.0 or later)
- GV-Center V2 (V18.2 + [patch](#) or later)
- GV-Vital Sign Monitor (V17.1 or later)

1 Introduction

- GV-Eye (for iOS / Android V2.7.2 or later)
- GV-Cloud Center (V1.0 or later)

For GV-SNVR1611

- GV-Center V2 (V18.2 + [patch](#) or later)
- GV-Vital Sign Monitor (V16.11 or later)
- GV-Eye (V2.5.1 or later)
- GV-Cloud Center (V1.0 or later)

For GV-SNVR0400F / 1600

- GV-Edge Recording Manager (Windows Version V1.1.0.0 or later)
- GV-Control Center (V3.3.0.0 or later)
- GV-Center V2 (V15.10 or later)
- GV-Vital Sign Monitor (V15.10 or later)
- GV-Eye (V2.0 or later)

1.4.3 System Requirements

Recommended Hard Disks

For system efficiency, it is recommended to use enterprise-level hard disk drives instead of desktop-level or green HDD. For tested hard disk drives, see *Appendix*.

Note: GV-SNVR does not support 2.5" SATA HDD.

Supported Web Browsers

- Internet Explorer 8 or later (10 or later for GV-SNVR0412 / 0812)
- Google Chrome
- Mozilla Firefox
- Safari (Only for GV-SNVR0411 / 0412 / 0811 / 0812 / 1611)
- Microsoft Edge (Only for GV-SNVR0411 / 0412 / 0811 / 0812 / 1611)

1.5 Optional Accessories

Optional devices can expand your GV-SNVR's capabilities and versatility. Contact your dealer for more information.

GV-Joystick V2	GV-Joystick V2 facilitates PTZ camera control. It can be plugged into the GV-SNVR for independent use to empower the operation of PTZ cameras.
GV-POE Switch	GV-POE Switch is designed to provide power along with network connection for IP devices. GV-POE Switch is available in various models with different numbers and types of ports.
GV-WiFi Adaptor V2	For GV-SNVR0411 / 0811 / 1611 only, GV-WiFi Adaptor V2 is designed to connect GV-IP devices to a wireless network. This product supports 2.4 GHz and 5 GHz wireless connection.
Slide Rail Kit	The Slide Rail Kit is used to mount a rail for the GV-SNVR1600 in a 19" cabinet.

1.6 Overview

1.6.1 Front View

1.6.1.1 GV-SNVR0411

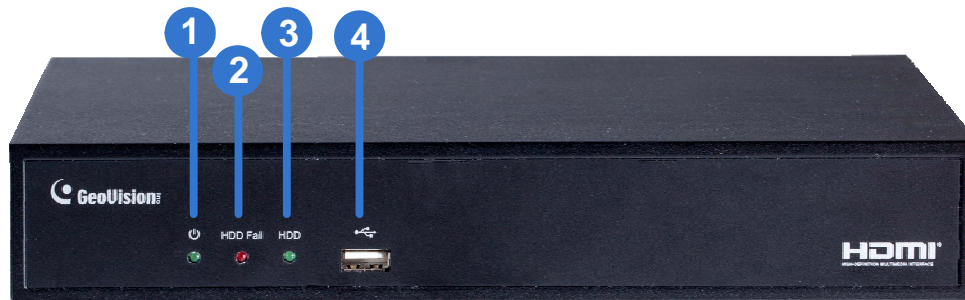

Figure 1-2

No.	Name	Function
1	Power LED	Shows constant green when power is supplied.
2	HDD Error LED	Shows constant red when: <ul style="list-style-type: none">• No hard drive is installed.• The hard drive is not formatted.• The hard drive fails.
3	HDD LED	Blinks green when the HDD is writing or reading data.
4	USB 2.0 Port	Connects to a keyboard, mouse, USB flash drive, GV-WiFi Adaptor V2 or GV-Joystick V2.

1.6.1.2 GV-SNVR0400F

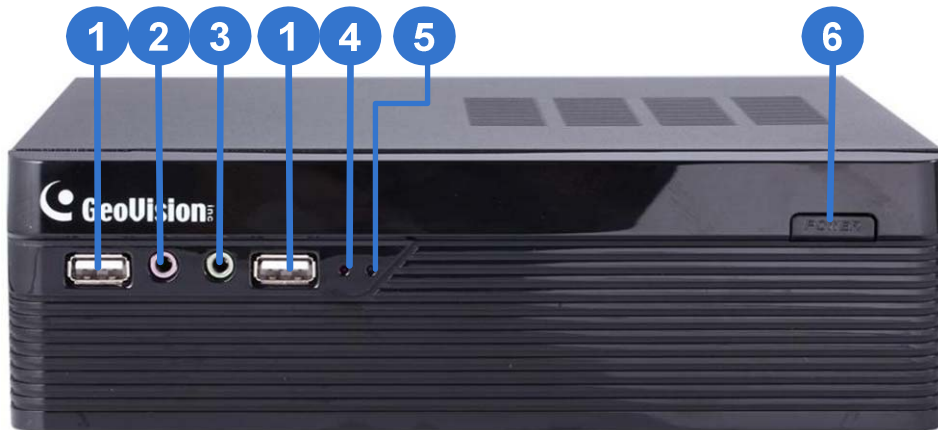

Figure 1-3

No.	Name	Function
1	USB 2.0 Port	Connects to a keyboard, mouse, USB flash drive or GV-Joystick V2.
2	Audio In	Not functional.
3	Audio Out	Connects to a speaker.
4	Power LED	Shows constant blue when power is supplied.
5	HDD Error LED	Shows constant red when: <ul style="list-style-type: none"> No hard drive is installed. The hard drive is not formatted. The hard drive fails.
6	Power Button	Turns on/off the power.

1 Introduction

1.6.1.3 GV-SNVR0811



Figure 1-4

No.	Name	Function
1	Power LED	Shows constant green when power is supplied.
2	HDD Error LED	Shows constant red when: <ul style="list-style-type: none">• No hard drive is installed.• The hard drive is not formatted.• The hard drive fails.
3	HDD LED	Blinks green when the HDD is writing or reading data.
4	PoE LED	Indicates the PoE port in use.

1.6.1.4 GV-SNVR1600



Figure 1-5

No.	Name	Function
1	Power Button	Turns on/off the power.
2	Power LED	Shows constant blue when power is supplied.
3	HDD Status LED	Flashes blue when the hard drive is writing or reading data.
4	HDD Error LED	Shows constant red when: <ul style="list-style-type: none"> No hard drive is installed. The hard drive is not formatted. The hard drive fails.
5	WAN LED	Flashes blue when the WAN port is receiving activity.
6	LAN LED	Flashes blue when the LAN port is receiving activity.
7	USB 2.0 Port	Connects to a keyboard, mouse, USB flash drive or GV-Joystick V2.

1 Introduction

1.6.1.5 GV-SNVR1611



Figure 1-6

No.	Name	Function
1	HDD1 LED	Constant blue when HDD1 is writing or reading data.
2	HDD2 LED	Constant blue when HDD2 is writing or reading data.
3	HDD Fail LED	Shows constant red when one or both of the hard drives is: <ul style="list-style-type: none">• Not formatted.• Fails to read or write.
4	Power LED	Shows constant blue when power is supplied.
5	USB 2.0 Port	Connects to a keyboard, mouse, USB flash drive, GV-WiFi Adaptor V2 or GV-Joystick V2.

1.6.1.6 GV-SNVR0812

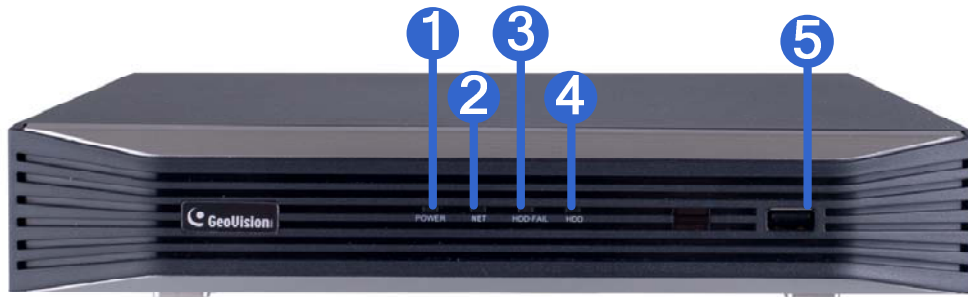

Figure 1-7

No.	Name	Function
1	Power LED	Shows constant blue when power is supplied.
2	Network LED	Shows constant blue when connected to a network.
3	HDD Fail LED	Shows constant red when the hard drive is either: <ul style="list-style-type: none"> • Not formatted. • Fails to read or write.
4	HDD LED	Shows constant blue when the hard drive is writing or reading data.
5	USB 2.0 Port	Connects to a keyboard, mouse, USB flash drive or GV-Joystick V2.

1.6.1.7 GV-SNVR0412

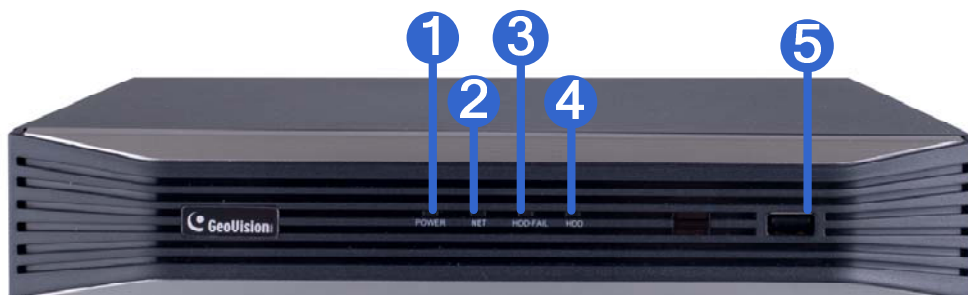

Figure 1-8

No.	Name	Function
1	Power LED	Shows constant blue when power is supplied.
2	Network LED	Shows constant blue when connected to a network.
3	HDD Fail LED	Shows constant red when the hard drive is either: <ul style="list-style-type: none"> • Not formatted. • Fails to read or write.
4	HDD LED	Shows constant blue when the hard drive is writing or reading data.
5	USB 2.0 Port	Connects to a keyboard, mouse, USB flash drive or GV-Joystick V2.

1.6.2 Rear View

1.6.2.1 GV-SNVR0411



Figure 1-9

No.	Name	Function
1	DC 52 V (Power Input)	Connects to power supply.
2	Megabit PoE Ports	Connects to cameras, delivering power and network connection to the cameras.
3	WAN	Connects to the network.
4	USB 2.0 Port	Connects to a keyboard, mouse, USB flash drive, GV-WiFi Adaptor V2 or GV-Joystick V2.
5	Default Button	Restores the device to its default settings. Press the button for 15 seconds to load default.
6	HDMI Output	Connects to a HD TV.

IMPORTANT: Only connect GV-SNVR0411 to the Internet through its **WAN Port** (No. 3, Figure 1-9) as opposed to any of the 4 PoE ports (No. 2, Figure 1-9), as they are only for connecting to IP cameras and have limited network connection.

1.6.2.2 GV-SNVR0400F



Figure 1-10

No.	Name	Function
1	Gigabit Ethernet Port	Connects to the network.
2	HDMI Output	Connects to a HD TV.
3	USB 2.0 Port	Connects to a keyboard, mouse, USB flash drive or GV-Joystick V2.
4	Default Button	Restores the device to default settings. Press the button for 15 seconds to load default.
5	Power Input	Connects to power supply.

1 Introduction

1.6.2.3 GV-SNVR0811

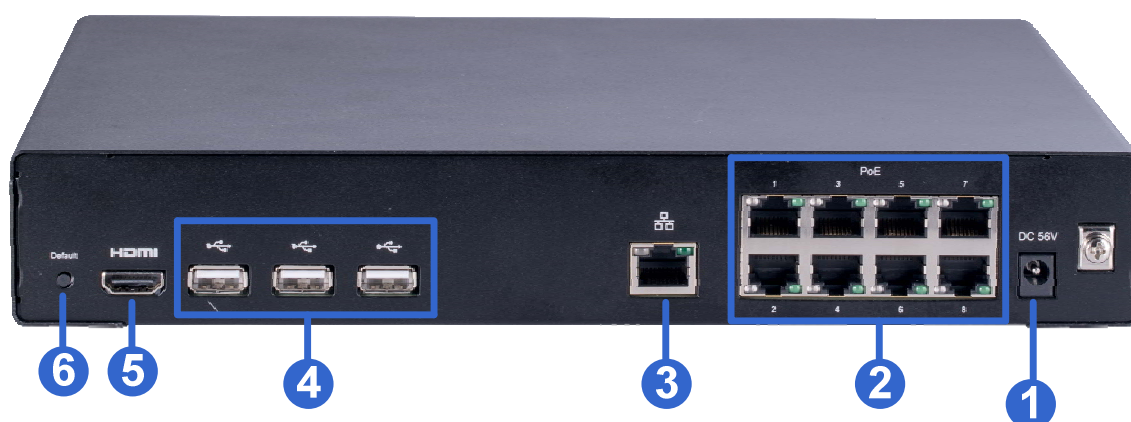

Figure 1-11

No.	Name	Function
1	DC 52 V (Power Input)	Connects to power supply.
2	Megabit PoE Ports	Connects to cameras, delivering power and network connection to the cameras.
3	Network	Connects to the network. The light on the left turns orange when connecting to Ethernet of 10 /100 Mbps.
4	USB 2.0 Port	Connects to a keyboard, mouse, USB flash drive, GV-WiFi Adaptor V2 or GV-Joystick V2.
5	HDMI Output	Connects to a HD TV.
6	Default Button	Restores the device to its default settings. Press the button for 15 seconds to load default.

IMPORTANT: Only connect GV-SNVR0811 to the Internet through its **WAN Port** (No. 3, Figure 1-11) as opposed to any of the 8 PoE ports (No. 2, Figure 1-11), as they are only for connecting to IP cameras and have limited network connection.

1.6.2.4 GV-SNVR1600



Figure 1-12

No.	Name	Function
1	Audio Microphone In Port	Not functional.
2	VGA Monitor Output	Connects to a VGA monitor.
3	HDMI Port	Connects to a HD TV.
4	USB 2.0 Port x 4	Connects to a keyboard, mouse, USB flash drive or GV-Joystick V2.
5	Power Input	Connects to power supply.
6	Gigabit Ethernet Port (LAN)	Connects to the network.
7	Gigabit Ethernet Port (WAN)	Connects to the network.
8	Audio Line Out Port	Connects to a headphone.
9	Audio Line Out Port	Connects to a speaker.

Note: When the two Ethernet ports (No. 6 and No. 7) are used together, one is LAN port and the other is WAN port.

1.6.2.5 GV-SNVR1611

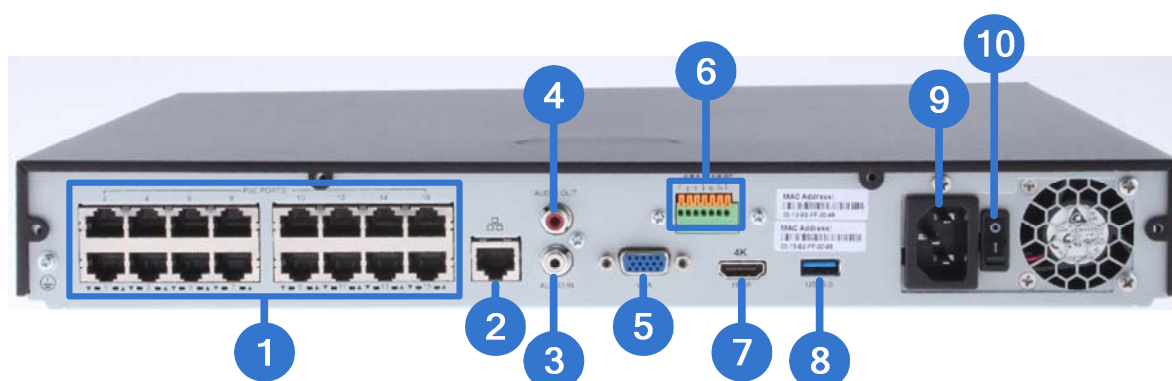

Figure 1-13

No.	Name	Function
1	Megabit PoE Ports	Connects to cameras, delivering power and network connection to the cameras.
2	Megabit Ethernet Port (WAN)	Connects to the network.
3	Audio Line In Port	Connects to a microphone.
4	Audio Line Out Port	Connects to a speaker.
5	VGA Output	Connects to a VGA monitor.
6	I/O Panel	Connects to 4 input and 1 output devices
7	HDMI Output	Connects to a HD TV.
8	USB 3.0 Port	Connects to a keyboard, mouse, USB flash drive or GV-Joystick V2.
9	Power Input	Connects to power supply.
10	Power Button	Turns the system on or off.

IMPORTANT: Only connect GV-SNVR1611 to the Internet through its **WAN Port** (No. 2, Figure 1-13) as opposed to any of the 16 PoE ports (No. 1, Figure 1-13), as they are only for connecting to IP cameras and have limited network connection.

Note: GV-SNVR1611 does not have a load default button. To restore factory settings manually for:

- Firmware V3.09 or earlier, right-click the mouse five times during the startup screen.
- Firmware V3.10 or later, click both the left- and right-click of the mouse 10 times within 3 seconds during the startup screen.

Or see 6.2.5 Restoring to Factory Default Settings for loading default via GV-IP Device Utility.

1.6.2.6 GV-SNVR0812

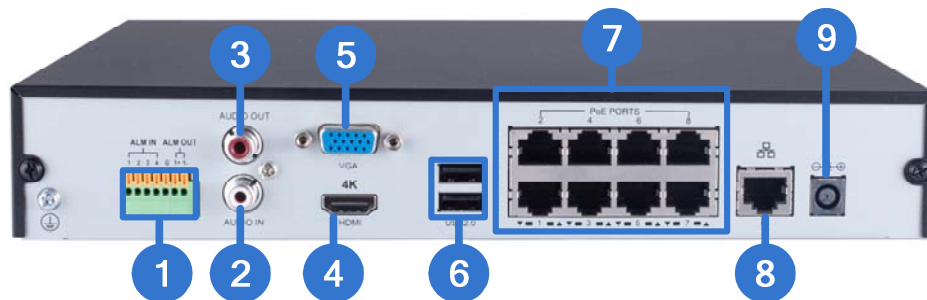

Figure 1-14

No.	Name	Function
1	I/O Panel	Connects to 4 input and 1 output devices
2	Audio Line Out Port	Connects to a speaker.
3	Audio Line In Port	Connects to a microphone.
4	HDMI Output	Connects to a HD TV.
5	VGA Output	Connects to a VGA monitor.
6	USB 2.0 Port	Connects to a keyboard, mouse, USB flash drive or GV-Joystick V2.
7	Megabit PoE Ports	Connects to cameras, delivering power and network connection to the cameras.
8	Megabit Ethernet Port (WAN)	Connects to the network. The light at the bottom flashes green when connecting to Ethernet of 10 /100 Mbps.
9	DC 52 V (Power Input)	Connects to power supply.

IMPORTANT: Only connect GV-SNVR0812 to the Internet through its **WAN Port** (No. 8, Figure 1-14) as opposed to any of the 8 PoE ports (No. 7, Figure 1-14), as they are only for connecting to IP cameras and have limited network connection.

Note:

1. IP cameras connected to the PoE ports are provided network connection via an isolated network that is not bridged to, or inaccessible by, the WAN.
2. IP cameras connected to the PoE ports are assigned a channel number in accordance to the PoE port number.
3. GV-SNVR0812 does not have a load default button. To restore factory settings manually for firmware V1.10 or later, click both the left- and right-click of the mouse 10 times within 3 seconds during the startup screen, or see *3.8 System* or *6.2.5 Restoring to Factory Default Settings* for loading default through its UI or GV-IP Device Utility, respectively.

1.6.2.7 GV-SNVR0412

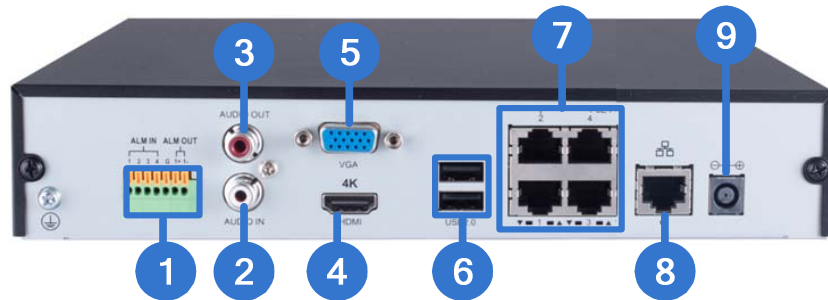

Figure 1-15

No.	Name	Function
1	I/O Panel	Connects to 4 input and 1 output devices
2	Audio Line Out Port	Connects to a speaker.
3	Audio Line In Port	Connects to a microphone.
4	HDMI Output	Connects to a HD TV.
5	VGA Output	Connects to a VGA monitor.
6	USB 2.0 Port	Connects to a keyboard, mouse, USB flash drive or GV-Joystick V2.
7	Megabit PoE Ports	Connects to cameras, delivering power and network connection to the cameras.
8	Megabit Ethernet Port (WAN)	Connects to the network. The light at the bottom flashes green when connecting to Ethernet of 10 /100 Mbps.
9	DC 52 V (Power Input)	Connects to power supply.

IMPORTANT: Only connect GV-SNVR0412 to the Internet through its **WAN Port** (No. 8, Figure 1-15) as opposed to any of the 4 PoE ports (No. 7, Figure 1-15), as they are only for connecting to IP cameras and have limited network connection.

Note:

- IP cameras connected to the PoE ports are provided network connection via an isolated network that is not bridged to, or inaccessible by, the WAN.
- IP cameras connected to the PoE ports are assigned a channel number in accordance to the PoE port number.
- GV-SNVR0412 does not have a load default button. To restore factory settings manually for firmware V1.05 or later, click both the left- and right-click of the mouse 10 times within 3 seconds during the startup screen, or see *3.8 System* or *6.2.5 Restoring to Factory Default Settings* for loading default through its UI or GV-IP Device Utility, respectively.

Chapter 2 Getting Started

2.1 Installation

The GV-SNVR uses SATA hard drive(s) for video data storage. Before recording, be sure to install the hard drive.

2.1.1 GV-SNVR0411

Installing the Hard Drive

Follow the steps below to install the hard drive to GV-SNVR0411.

1. Unscrew three screws on the bottom and two screws on the sides; then remove the cover.

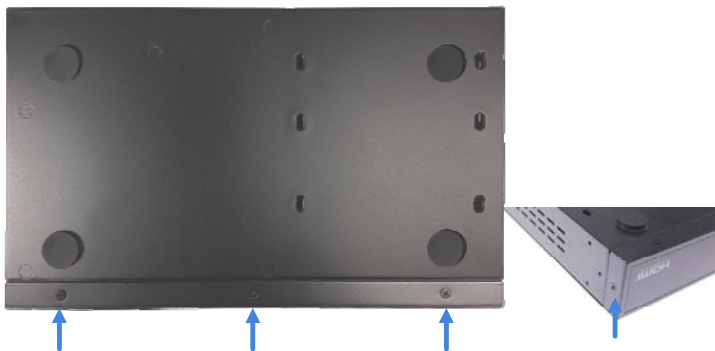

Figure 2-1

2. Place the supplied rubber feet on four of the six oval holes and place the hard drive in the drive drawer as below by aligning the four holes.

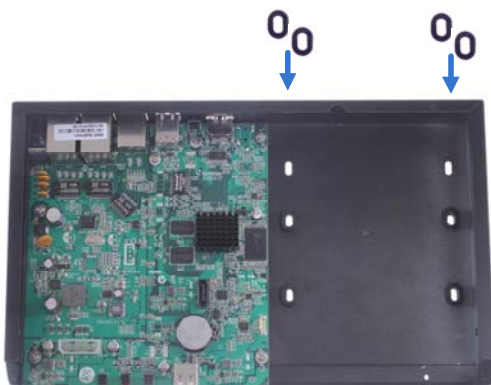

Figure 2-2



Figure 2-3

2 Getting Started

3. Secure the hard drive from the back of the drawer using the 4 supplied screws.

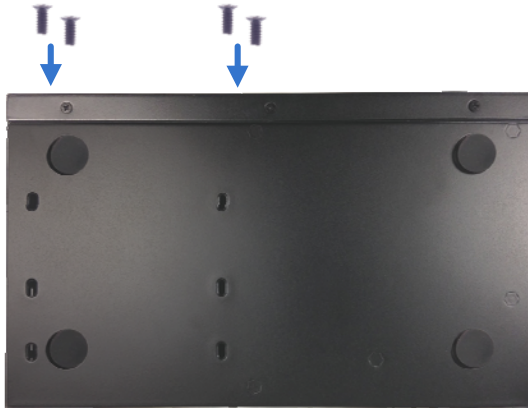

Figure 2-4

4. Connect the SATA Power Cable and Data Cable to the hard drive.

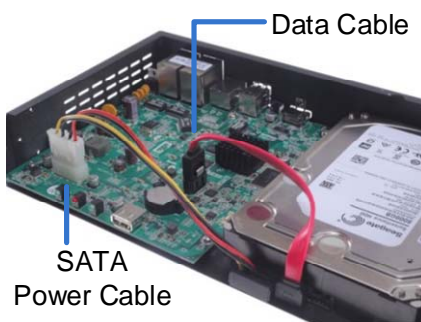

Figure 2-5

5. Assemble the cover with the device by tightening the screws on the bottom and sides. (Figure 2-1).

The hard drive is now ready for use.

2.1.2 GV-SNVR0811

Installing the Hard Drive

Follow the steps below to install the hard drive to GV-SNVR0811.

1. Unscrew the two screws on both sides and remove the cover.



Figure 2-6

2. Place the hard drive in the driver drawer.

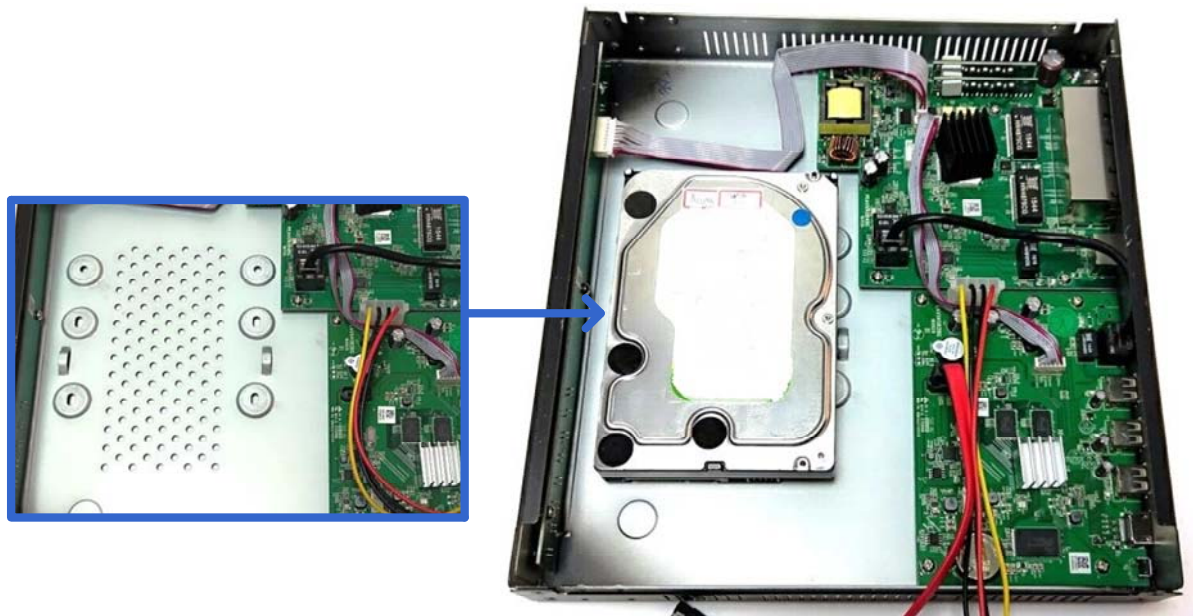

Figure 2-7

2 Getting Started

- Secure the hard drive from the back of the drawer using the 4 supplied screws.

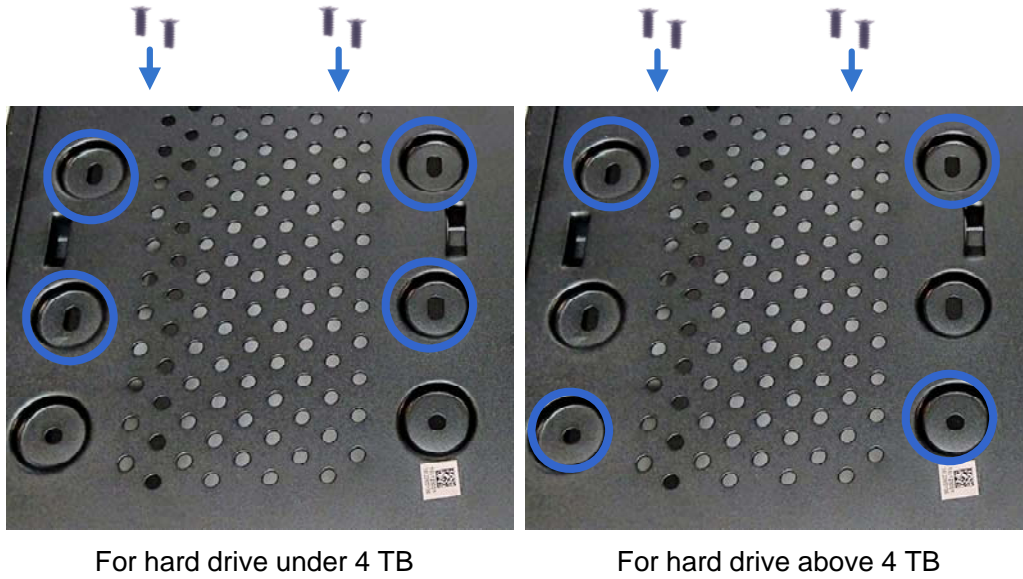

Figure 2-8

- Connect the SATA Power Cable and Data Cable to the hard drive.

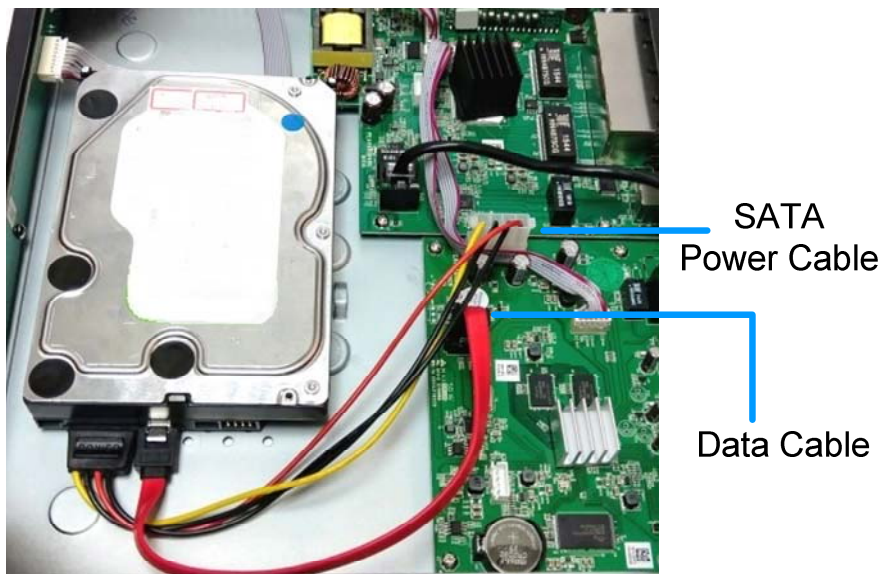

Figure 2-9

- Assemble the cover with the device by tightening the screws on both sides.

The hard drive is now ready for use.

2.1.3 GV-SNVR0400F

Installing the Hard Drive

Follow the steps below to install the hard drive to GV-SNVR0400F.

1. Unscrew the two screws on the rear panel and remove the cover.



Figure 2-10

2. Unscrew the drive drawer and take it out from the device.



Figure 2-11

2 Getting Started

3. Place the hard drive in the drive drawer as below by aligning the three holes.

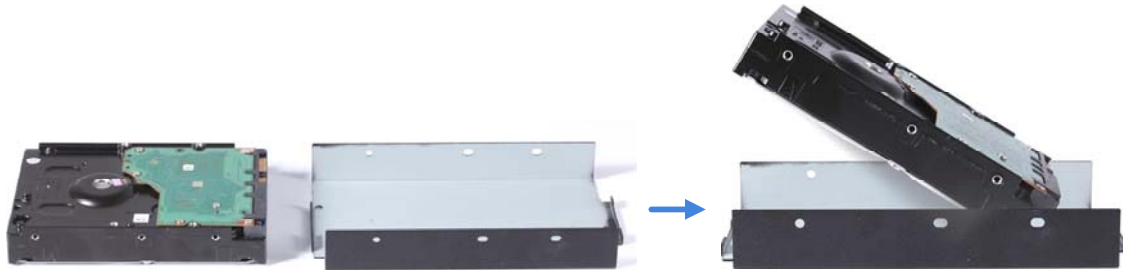

Figure 2-12

4. Secure the hard drive with the drive drawer using the 6 supplied screws (3 screws on each side).

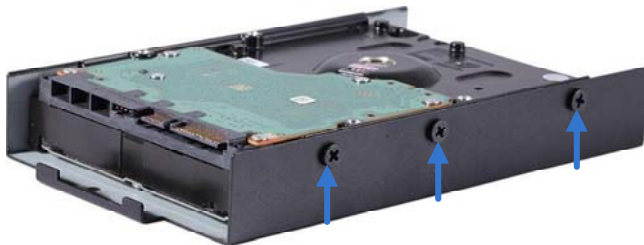

Figure 2-13

5. Connect the SATA Power Cable and Data Cable to the hard drive.

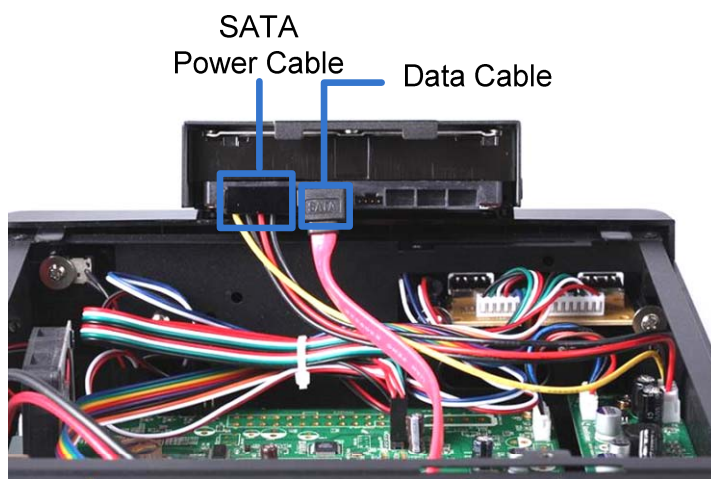

Figure 2-14

6. Put the drive drawer back in the device and secure the two screws on the drive drawer (Figure 2-11).
7. Assemble the cover with the device by tightening the screws on rear panel (Figure 2-10).

The hard drive is now ready for use.

2.1.4 GV-SNVR1600

Installing the Hard Drive

Follow the steps below to install the hard drive to the GV-SNVR1600.

1. Loosen the 6 screws and remove the cover.



Figure 2-15

2. Assemble the mounting brackets with the hard drive and tighten the screws on both sides.

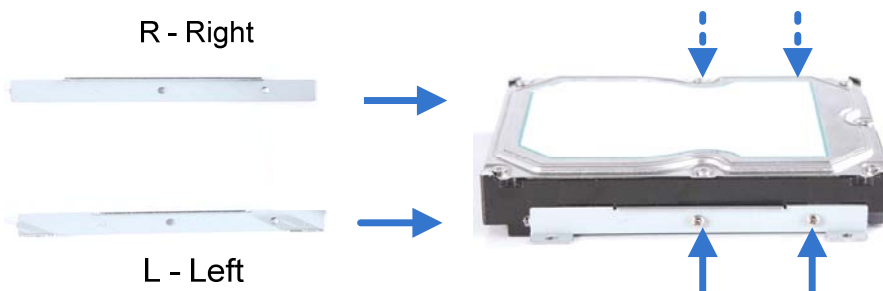

Figure 2-16

Note: Each mounting bracket is labeled **L** or **R** for recognition. Align the mounting bracket with the holes on the hard drive and make sure it is secured to the correct side.

2 Getting Started

3. Align the mounting bracket with the holes inside the unit.

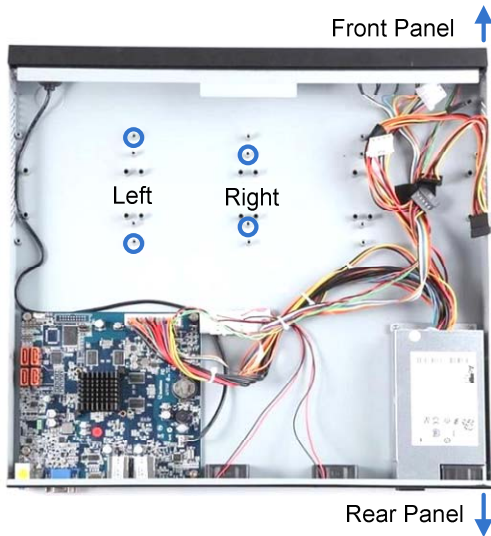
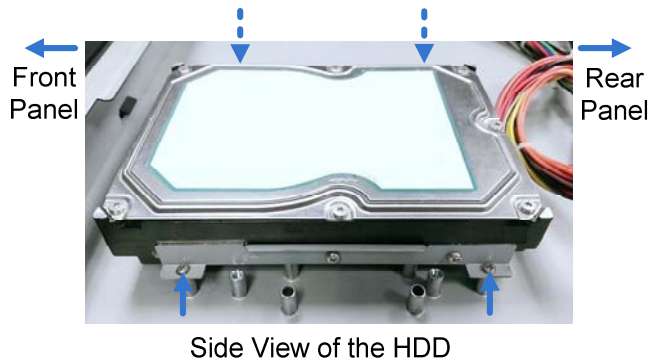

Figure 2-17

4. Tighten the 4 screws on the side of the hard drive.



Side View of the HDD

Figure 2-18

5. Connect the SATA Power Cable and Data Cable to the hard drive.

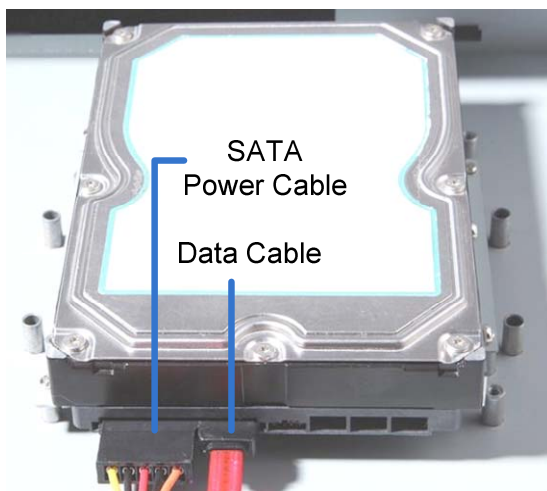

Figure 2-19

6. To install more HDDs, repeat the steps above.
7. Place the cover back and tighten the screws.

The hard drive is now ready for use.

Installing the L-Shaped Brackets

Tighten the 6 screws to secure and attach the 2 L-shaped brackets to each side of GV-SNVR1600.



Figure 2-20

2.1.5 GV-SNVR1611

Installing the Hard Drive

Follow the steps below to install the hard drive to GV-SNVR1611.

1. Unscrew the two screws on both sides and the four screws on the rear to remove the cover.



Figure 2-21

2 Getting Started

2. Place the hard drive in the driver drawer.



Figure 2-22

3. Secure the hard drive from the back of the drawer using the 4 supplied screws.

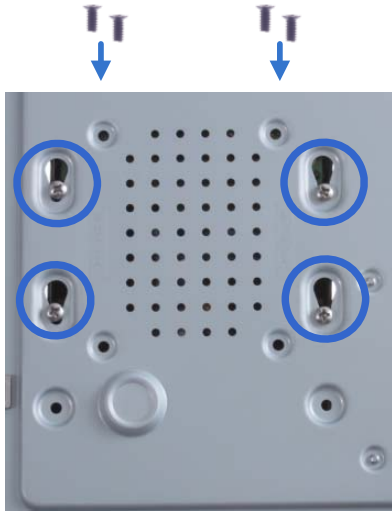

Figure 2-23

4. Connect the SATA Power Cable and Data Cable to the hard drive.



Figure 2-24

5. Assemble the cover with the device by tightening the screws on both sides and the rear side.

The hard drive is now ready for use.

2.1.6 GV-SNVR0412 / 0812

Installing the Hard Drive

Follow the steps below to install the hard drive to GV-SNVR0412 / 0812.

1. Unscrew the two screws on both sides and the two screws on the rear to remove the cover.



Figure 2-25

2. Place the hard drive in the driver drawer.

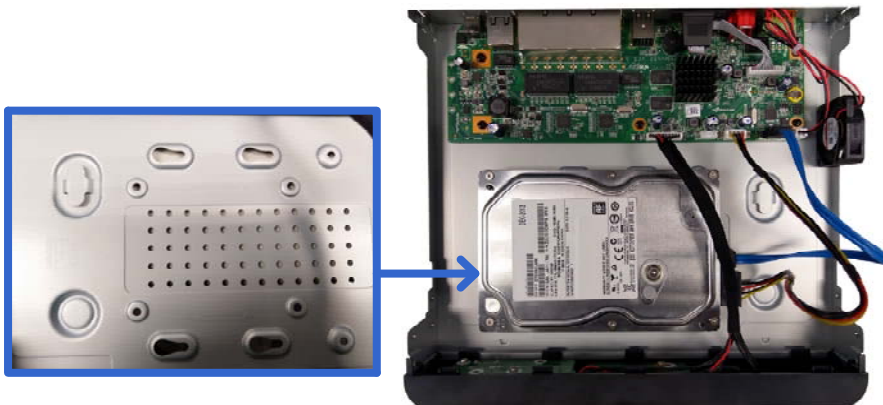

Figure 2-26

2 Getting Started

- Secure the hard drive from the back of the drawer using the 4 supplied screws.

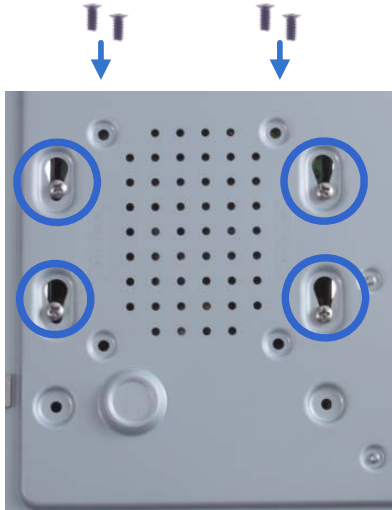

Figure 2-27

- Connect the SATA Power Cable and Data Cable to the hard drive.

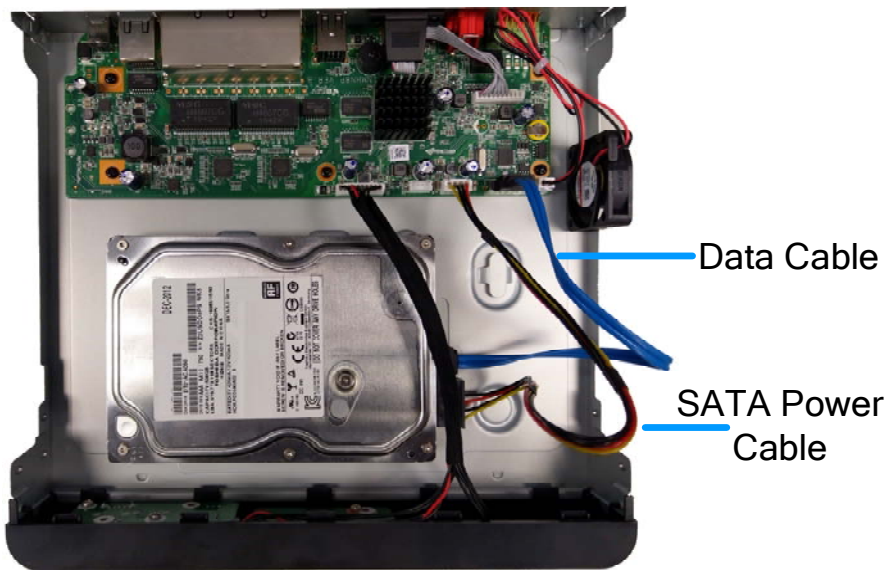

Figure 2-28

- Assemble the cover with the device by tightening the screws on both sides and the rear side.

The hard drive is now ready for use.

2.2 Connecting the GV-SNVR

Follow the steps below to connect the GV-SNVR.



GV-SNVR0411

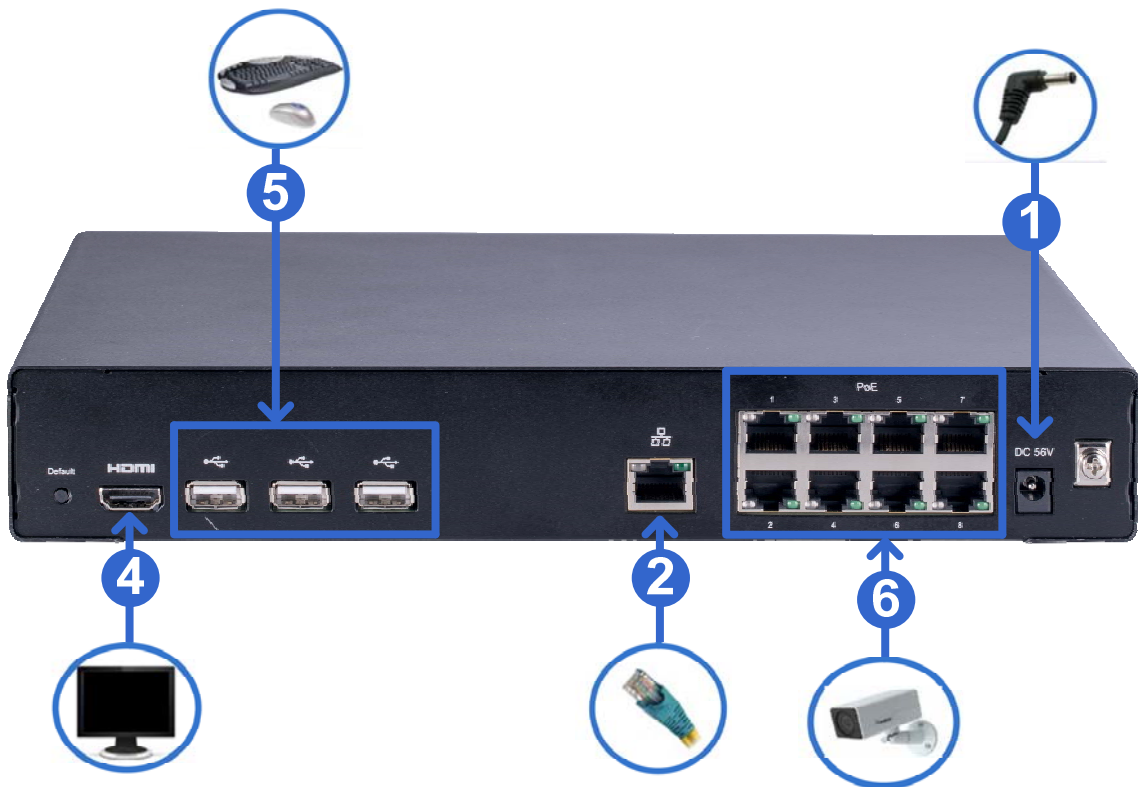

GV-SNVR0811

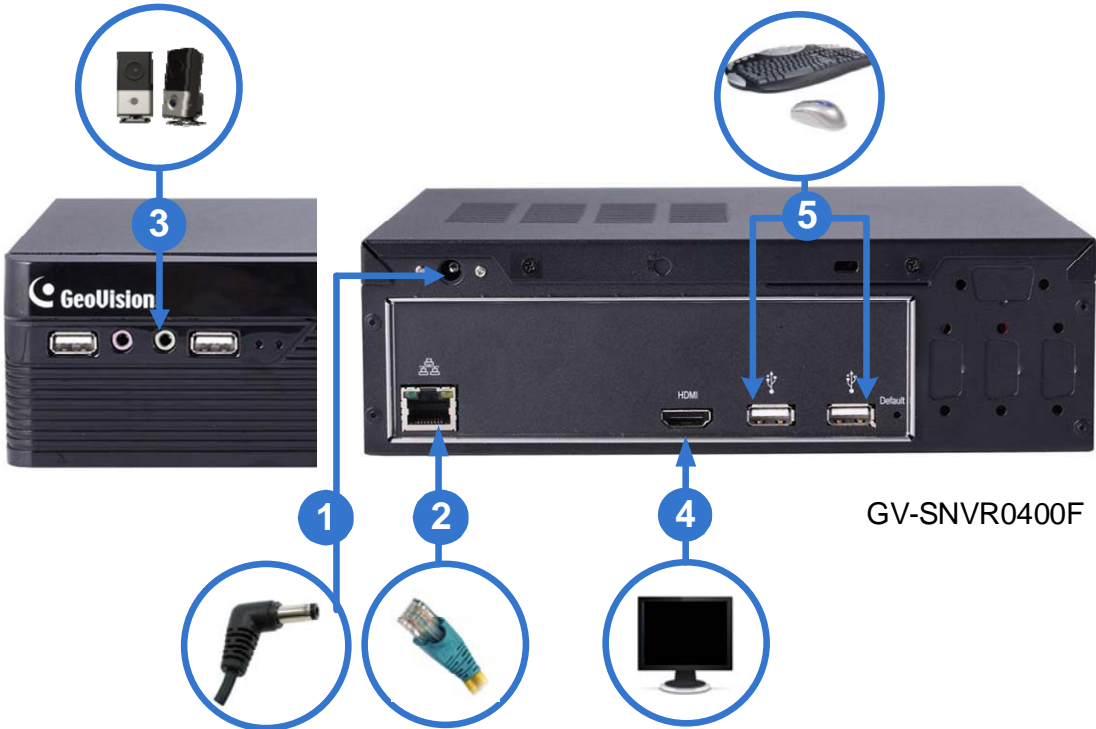

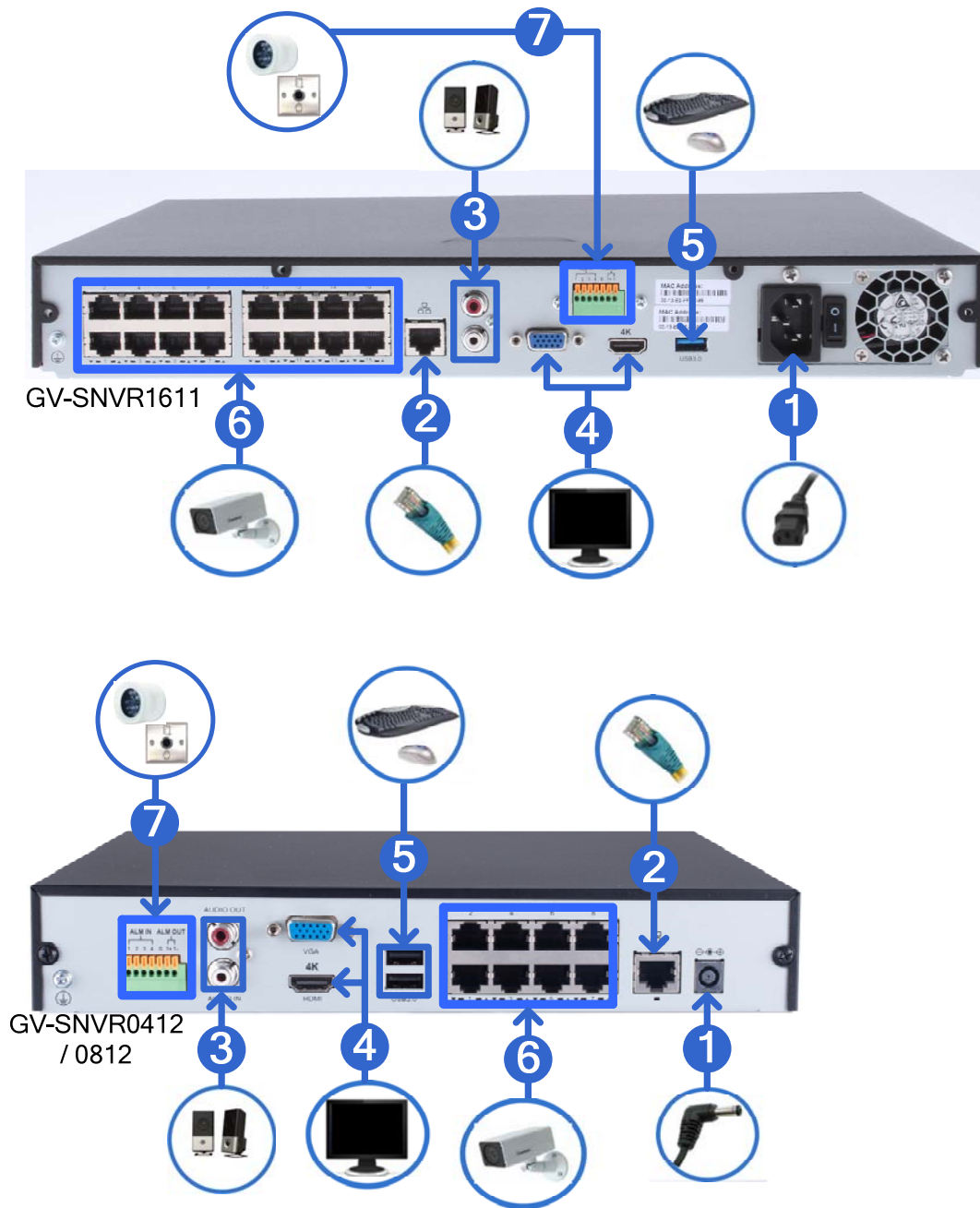

Figure 2-29

1. Connect the GV-SNVR to power.
2. Connect the GV-SNVR to the network using the Ethernet cable. For **GV-SNVR0411 / 0412 / 0811 / 0812 / 1611**, only connect to the network via its specified LAN / WAN port as illustrated.
3. Connect a speaker to the Audio Line Out port. Only for **GV-SNVR0412 / 0812 / 1611**, connect a microphone to the Audio Line In port.
4. Connect an HDTV to HDMI connector for video/audio output. Only for **GV-SNVR0412 / 0812 / 1600 / 1611**, optionally connect a VGA monitor to the D-Sub connector for dual-monitor display.

2 Getting Started

5. Connect a mouse and/or keyboard to the USB port(s).
6. Only for **GV-SNVR0411 / 0412 / 0811 / 0812 / 1611**, connect cameras to the GV-SNVR using Ethernet cables.
7. Only for **GV-SNVR0412 / 0812 / 1611**, connect up to 4 input and 1 output devices to the GV-SNVR.

Press or switch on the power button to start the GV-SNVR.

IMPORTANT: For all models except GV-SNVR0400F / 1600, only connect GV-SNVR to the Internet through its WAN Port as opposed to any of the PoE ports, as they are only for connecting to **IP cameras** and have limited network connection.

Note:

1. The GV-SNVR is DHCP enabled. When it is connected to the network, it will be automatically assigned an IP address.
 2. For GV-SNVR1600, the monitor used for VGA output must be capable of having a screen resolution of 1080p. For GV-SNVR0411 / 0412 / 0811 / 0812 / 1611, when configuring the camera's video resolution to 4K, make sure your monitor is a 4K-capable monitor.
 3. It is recommended to use HDMI-certified cables. Be aware that signal instabilities may occur if the HDMI cable used exceeds a length of 10 m.
-

2.2.1 Network Connection for GV-SNVR1600

There are two network ports, LAN and WAN, for the GV-SNVR1600. If both network ports are used simultaneously, only the WAN port can be connected to the Internet. Therefore, it is recommended to connect the devices as below.

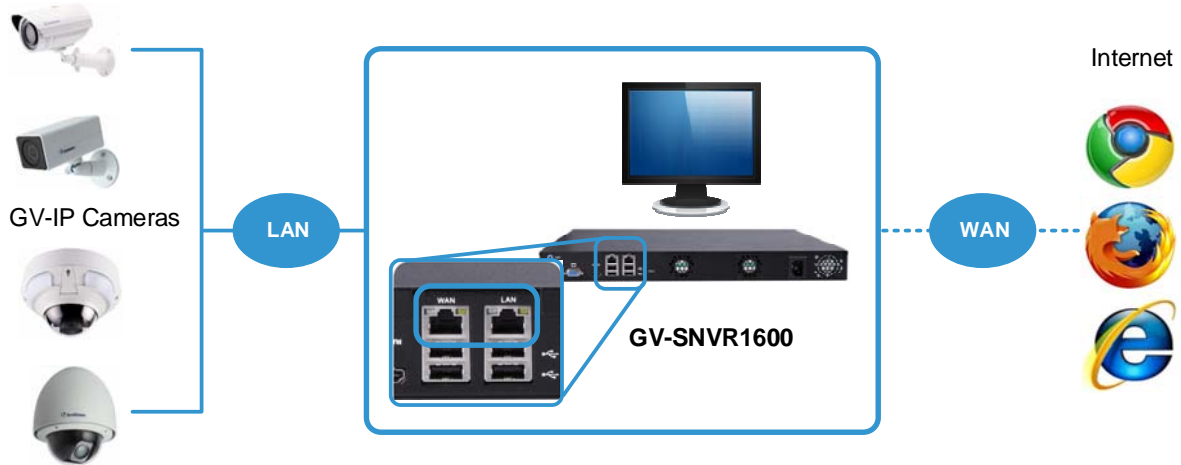

Figure 2-30

1. Connect GV-IP Cameras to the GV-SNVR1600 through the LAN port.
2. Connect GV-SNVR1600 to the Internet through the WAN port.

Note: When the LAN and WAN ports are used together, the Auto Search function is only supported by the LAN port. To connect to GV-IP Cameras under the WAN, you can add the cameras manually.

IMPORTANT: It is required to divide LAN and WAN networks into different subnets or segments; otherwise, your network will fail. For details, see [3.3 Network](#).

2.2.2 Accessing the GV-SNVR

This function is only for **GV-SNVR0411 / 0412 / 0811 / 0812 / 1611**.

When turning on the GV-SNVR for the first time or loading default settings, a login window appears. Follow the steps below to access the GV-SNVR.

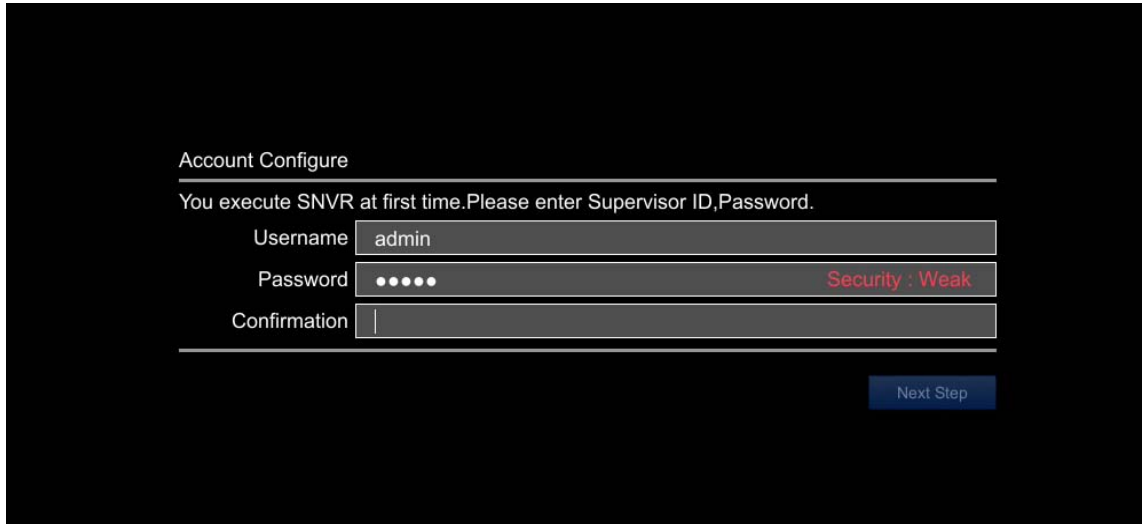

Figure 2-31

1. Type the default Username and Password: *admin* and click **Apply** to log in. You can choose to redefine the Username and Password for the GV-SNVR by typing in the desired values. Retype your new password again and click **Next Step** to log in.
2. For **GV-SNVR0411 / 0811 / 1611**, enable **DHCP Server** to automatically assign IP addresses for IP cameras connecting to the GV-SNVR. Click **Next Step** to continue.

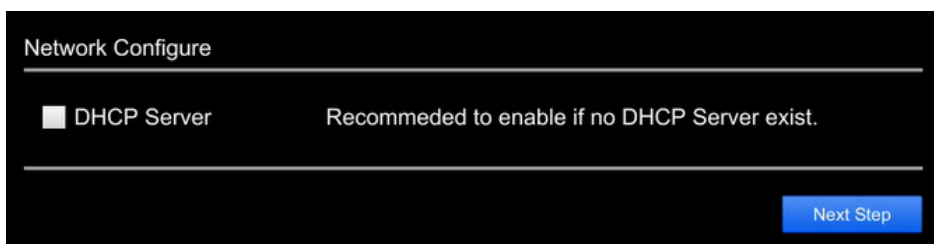

Figure 2-32

Note:

1. For GV-SNVR0412 / 0812, any IP device connected to its 4 / 8 PoE ports is automatically assigned an IP address by its internal, isolated DHCP server, and communicates with the network only via the SNVR.
 2. GV-SNVR0412 / 0812 only, for any IP device powered by one of its 4 / 8 PoE ports, a Reboot button is available next to the Camera Edit button for you to disconnect and reconnect the IP device from power.
-

2.3 Setting Up IP Cameras

After installing the IP cameras under the same LAN as the GV-SNVR, you can now add the cameras to GV-SNVR.

2.3.1 Automatically Setting Up IP Cameras

To automatically set up the IP cameras, follow the steps below.

1. Upon login, the GV-SNVR automatically searches and lists the IP cameras under the same LAN.
2. For **GV-SNVR0411 / 0811 / 1611** only, you are prompted with a dialog box asking if you want to automatically assign IP address. The automatic assignment only applies to cameras with IP address **192.168.0.10**.

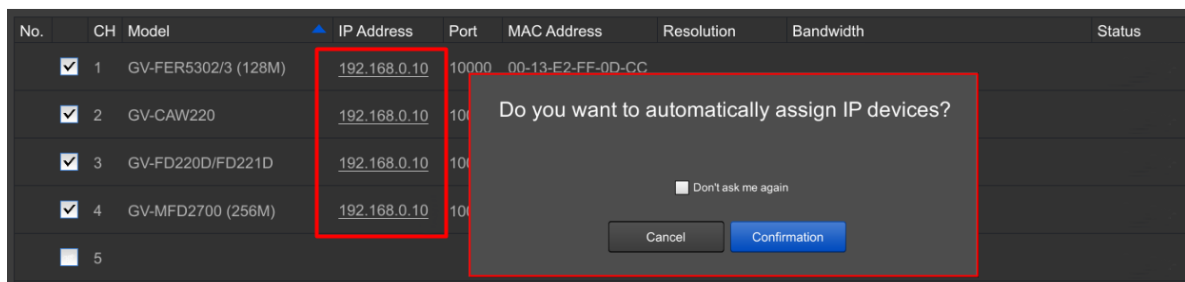
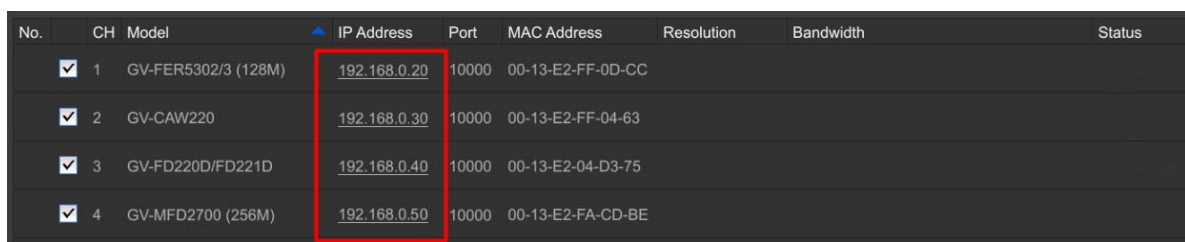

Figure 2-33

3. Click **Apply**. The GV-SNVR assigns unused IP addresses to the cameras in an ascending numerical order and enables the connection.



The screenshot shows the same table of cameras after the IP addresses have been assigned. The IP Address column for the first four cameras is highlighted with a red box and contains the values 192.168.0.20, 192.168.0.30, 192.168.0.40, and 192.168.0.50 respectively. The Status column is now populated with "Connected".

No.	CH	Model	IP Address	Port	MAC Address	Resolution	Bandwidth	Status
<input checked="" type="checkbox"/>	1	GV-FER5302/3 (128M)	192.168.0.20	10000	00-13-E2-FF-0D-CC			Connected
<input checked="" type="checkbox"/>	2	GV-CAW220	192.168.0.30	10000	00-13-E2-FF-04-63			Connected
<input checked="" type="checkbox"/>	3	GV-FD220D/FD221D	192.168.0.40	10000	00-13-E2-04-D3-75			Connected
<input checked="" type="checkbox"/>	4	GV-MFD2700 (256M)	192.168.0.50	10000	00-13-E2-FA-CD-BE			Connected

Figure 2-34

Upon successful connection, the status displays "Connected", with the resolution and bandwidth being displayed in the corresponding columns. Close the Camera page to access the live view.

Note: For GV-SNVR1611, IP cameras detected under the same LAN are listed starting from the second page of the camera list, while the first page only displays the cameras that are connected to the SNVR.

IMPORTANT:

1. By default, GV-IP Cameras use the IP address **192.168.0.10**. The GV-SNVR will automatically assign unused IP addresses to these cameras to avoid IP address conflict with others under the same LAN.
2. For GV-SNVR0411 / 0811 / 1611, to connect to GV-ABL Series / ADR Series / AVD Series / EBD Series / TBL Series / TDR Series / TVD Series / SD2322-IR / 2722-IR / 3732-IR, UVS-ABD1300 / ABL1300 / ADR1300 and EVS-ABD1300 / ABL1300 / ADR1300, your network environment must have a DHCP server. Or, you can enable the **DHCP Server** function of GV-SNVR0411 / 0811 / 1611 to automatically assign a dynamic IP address to the cameras. For details, refer to *3.3 Network*.
3. The GV-SNVR connects to IP cameras with the default ID and password **admin**. If the IP camera uses a different ID and password, click the **Edit** icon  and type the correct login information. For GV-IP cameras without default ID and password, see *3.1.1.1 Configuring GV-IP Cameras without Default ID and Password*.

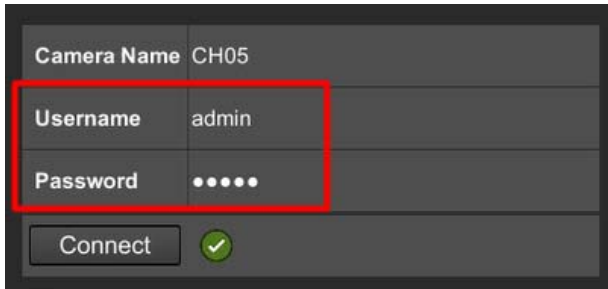

4. The total bandwidth supported varies among GV-SNVR models. For detailed specifications, refer to GV-SNVR datasheets. The total bandwidth can be found on the top-right corner of the camera list.

No.	CH	Model	IP Address	Port	MAC Address	Resolution	Bandwidth	Status	Brand	
<input checked="" type="checkbox"/>	1	GV-CS1320 (128M)	192.168.0.110	10000	00-13-E2-FF-1D-BA	H264-1920x1080 H264-640x360	3.6 Mbps	Connecting	GeoVision	
<input checked="" type="checkbox"/>	2	GV-CR1320 (128M)	192.168.0.113	10000	00-13-E2-12-84-7A	H264-1920x1080 H264-448x252	2.3 Mbps	Connecting	GeoVision	
<input checked="" type="checkbox"/>	3	GV-FD3410 (128M)	192.168.0.135	10000	00-13-E2-0A-FE-04	H264-2048x1536 H264-320x240	4.3 Mbps	Connecting	GeoVision	
<input checked="" type="checkbox"/>	4	GV-EBD4711	192.168.6.236	ONVIF	00-13-E2-FA-CD-BE			Connecting	GeoVision_2	

Camera Selected: 7, **Total Bandwidth: 10.2 Mbps** Page 1/14 < >

2.3.2 Manually Connecting GV-IP Cameras

You can manually add GV- IP cameras to the camera list.

Note: For GV-SNVR0411 / 0811 / 1611, to connect to GV-ABL Series / ADR Series / AVD Series / EBD Series / TBL Series / TDR Series / TVD Series / SD2322-IR / 2722-IR / 3732-IR, UVS-ABD1300 / ABL1300 / ADR1300 and EVS-ABD1300 / ABL1300 / ADR1300, your network environment must have a DHCP server. Or, you can enable the **DHCP Server** function of GV-SNVR0411 / 0811 / 1611 to automatically assign a dynamic IP address to the cameras. For details, refer to [3.3 Network](#).

1. On the Camera page, click the **Add Cameras**  button.
2. Select **GeoVision** or **GeoVision_2** protocol. GeoVision_2 protocol is for connecting to any of the IP devices listed within the *Note* before Step 1.
3. Type the Username, Password, IP Address and Port of the desired IP camera. The default port value of GV-IP Camera is 10000.

Protocol	GeoVision	
Username		
Password		
Add Camera	1	(1/256 max)
IP Address		<input type="checkbox"/> Duplicate
Port		<input type="checkbox"/> Duplicate
		<input type="button" value="Close"/> <input type="button" value="Apply"/>

Figure 2-35

4. Click **Apply** to add the IP camera.
5. To add multiple cameras, repeat step 2. Type the number of cameras you want to create in the **Add Camera** column.
 - A. To duplicate cameras with the same IP address but different ports, type the IP address and select **Duplicate** for Port.
 - B. To duplicate cameras with the same port number but different IP addresses, type the port number and select **Duplicate** for IP Address.

2 Getting Started

- To connect the GV-SNVR with the added cameras, click the box next to the **CH** column on the Camera page.

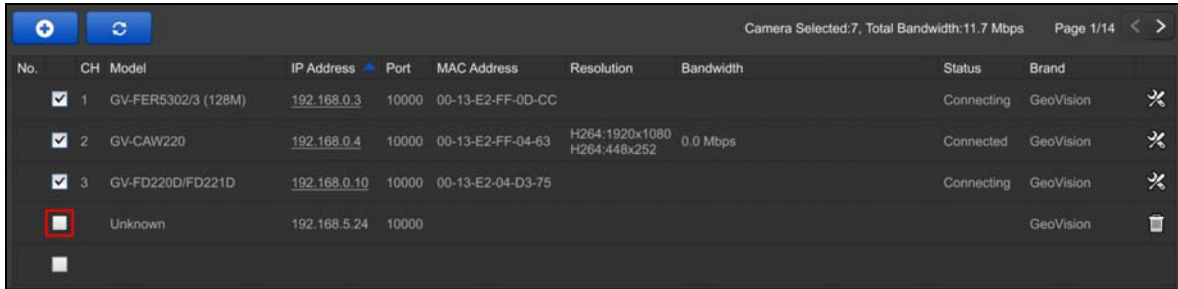

No.	CH	Model	IP Address	Port	MAC Address	Resolution	Bandwidth	Status	Brand
1	<input checked="" type="checkbox"/>	GV-FER5302/3 (128M)	192.168.0.3	10000	00-13-E2-FF-0D-CC			Connecting	GeoVision
2	<input checked="" type="checkbox"/>	GV-CAW220	192.168.0.4	10000	00-13-E2-FF-04-63	H264:1920x1080 H264:448x252	0.0 Mbps	Connected	GeoVision
3	<input checked="" type="checkbox"/>	GV-FD220D/ID221D	192.168.0.10	10000	00-13-E2-04-D3-75			Connecting	GeoVision
	<input type="checkbox"/>	Unknown	192.168.5.24	10000					GeoVision

Figure 2-36

2.3.3 Manually Connecting Third-Party IP Cameras

Note this section only applies to **GV-SNVR0411 / 0412 / 0811 / 0812 / 1611**. You can connect H.264 / H.265 third-party cameras through ONVIF or RTSP protocol.

- On the Camera page, click the **Add Cameras**  button.
- Select the type of **Protocol** that is supported by your IP camera, **ONVIF** or **RTSP**.
- Type the necessary information of the desired IP camera according to the protocol.

For ONVIF Protocol

- Type the IP address, Username, and Password of the desired IP camera.



Protocol	ONVIF
Username	
Password	
Add Camera	1 (1/256 max)
IP Address	

Close Apply

Figure 2-37

For RTSP Protocol

- A. Type the Username and Password of the desired IP camera.
- B. Select TCP or UDP under **Type of Connection**.
- C. Type the RTSP URL to enable Stream1 and Stream2. For the RTSP command, consult the documentation of the third-party IP camera.

Protocol	RTSP
Username	
Password	
Add Camera	1 (1/256 max)
Connection Type	TCP
Stream1 URL	rtsp://
Stream2 URL	rtsp://

Figure 2-38

4. Click **Apply** to add the IP camera.
5. To connect the GV-SNVR with the added cameras, click the box next to the **CH** column on the Camera page.

No.	CH	Model	IP Address	Port	MAC Address	Resolution	Bandwidth	Status	Brand
<input checked="" type="checkbox"/>	1	GV-FER5302/3 (128M)	192.168.0.3	10000	00-13-E2-FF-0D-CC			Connecting	GeoVision
<input checked="" type="checkbox"/>	2	GV-CAW220	192.168.0.4	10000	00-13-E2-FF-04-63	H264:1920x1080 H264:448x252	0.0 Mbps	Connected	GeoVision
<input checked="" type="checkbox"/>	3	GV-FD220D/FD221D	192.168.0.10	10000	00-13-E2-04-D3-75			Connecting	GeoVision
<input type="checkbox"/>		Unknown	192.168.5.24	10000					GeoVision

Figure 2-39

2 Getting Started

2.3.4 Changing Camera IP Address and Assigning Channels

On the Camera page, you can change the IP address of the connected cameras by clicking on the IP address.

You can also re-assign the camera to another channel. For example, to change the camera on Channel 1, deselect the connected camera on Channel 1 and select another camera for connection. The selected camera is now assigned to Channel 1.

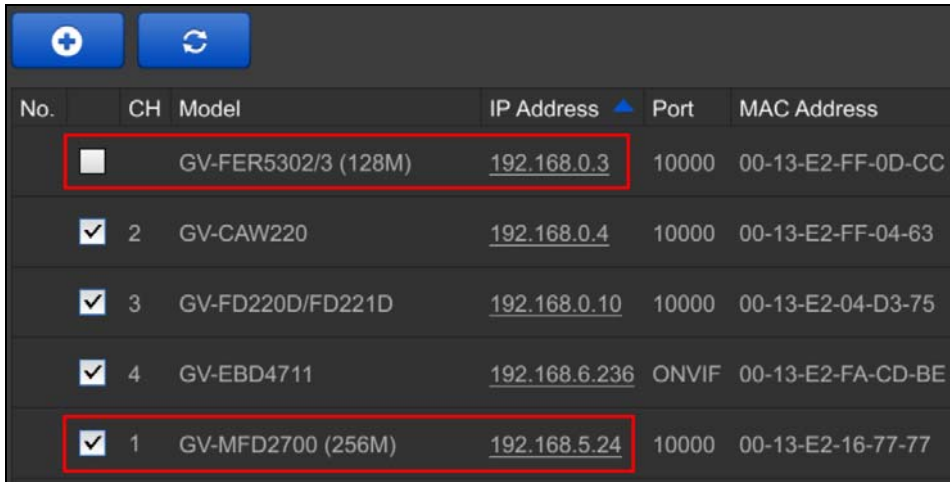

No.	CH	Model	IP Address	Port	MAC Address
<input type="checkbox"/>		GV-FER5302/3 (128M)	192.168.0.3	10000	00-13-E2-FF-0D-CC
<input checked="" type="checkbox"/>	2	GV-CAW220	192.168.0.4	10000	00-13-E2-FF-04-63
<input checked="" type="checkbox"/>	3	GV-FD220D/FD221D	192.168.0.10	10000	00-13-E2-04-D3-75
<input checked="" type="checkbox"/>	4	GV-EBD4711	192.168.6.236	ONVIF	00-13-E2-FA-CD-BE
<input checked="" type="checkbox"/>	1	GV-MFD2700 (256M)	192.168.5.24	10000	00-13-E2-16-77-77

Figure 2-40

2.4 Formatting Hard Drive

After installing the hard drive to GV-SNVR, you need to format the hard drive before enabling monitoring.

1. On the main screen, click the **Setting** button.



Figure 2-41

2. Select **Storage**.

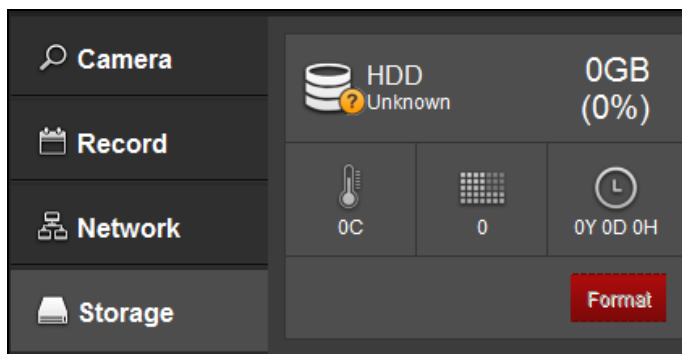

Figure 2-42

3. Click **Format**. This dialog box appears.

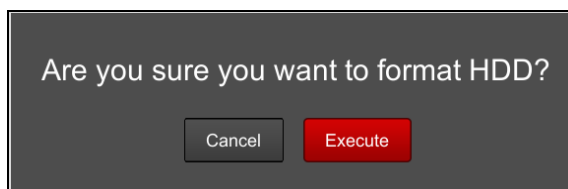

Figure 2-43

4. Click **Execute** to format the hard drive.

2 Getting Started

When the hard drive is successfully formatted, its icon should be marked with a green tick, and the word “Normal” appears. The information of operating temperature, hard drive status and total time in use is also displayed.



Figure 2-44

Note: When the hard drive status displays a value other than **0**, replace the hard drive with a new one to ensure proper video recording.

2.5 Main Screen

Close the Camera page to see the connected channels on the main screen. Here we use GV-SNVR0811 for illustration.

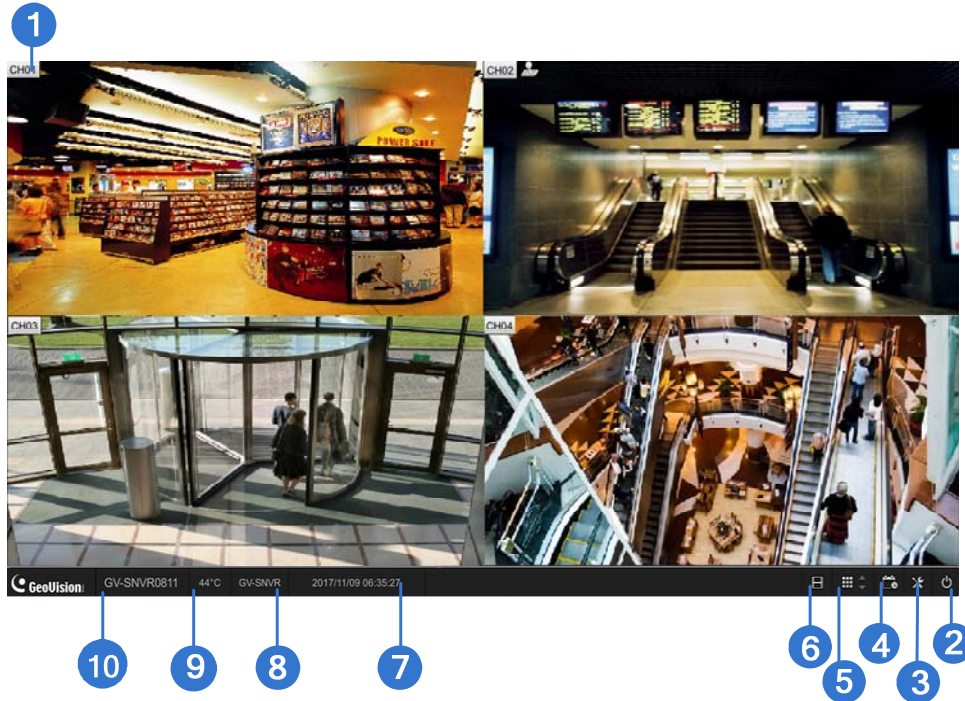

Figure 2-45

No.	Name	Description
1	Camera Name	Indicates the camera name. The column changes from gray to red when the recording is enabled. See <i>Camera Name</i> in 3.1 <i>Camera</i> .
2	System	Brings up the following options: <ul style="list-style-type: none"> Log Out Reboot (for GV-SNVR0411 / 0412 / 0811 / 0812 / 1611 only) Shutdown (for GV-SNVR0400F / 1600 only)
3	Setting	Accesses the following setting pages: <ul style="list-style-type: none"> Camera (see 3.1 <i>Camera</i>) Recording (see 3.2 <i>Recording</i>) Network (see 3.3 <i>Network</i>) Storage (see 2.4 <i>Formatting Hard Drive</i>) Display (see 3.5 <i>Display</i>) Service (see 3.6 <i>Service</i>) Event (see 3.7 <i>Event</i> for GV-SNVR0412 / 0812 / 1611 only) System (see 3.8 <i>System</i>) Account (see 3.9 <i>Account</i>)

2 Getting Started

No.	Name	Description
4	Record	Starts/Stops monitoring.
5	Division & Page Up / Down	Selects screen divisions and switch between cameras in single division.
6	Playback	Displays the playback panel.
7	Date / Time	Displays the current date and time.
8	Device Name	Displays the device name of GV-SNVR. See <i>Device Name</i> in 3.8 <i>System</i> .
9	Temperature	Displays the current temperature. This function is not applicable to GV-SNVR1611. For GV-SNVR0411 / 0412 / 0811 / 0812, when the system temperature reaches 55°C (131°F) or higher, the temperature value is displayed in red.
10	Model Name	Displays the model name of the GV-SNVR.

Note: For GV-SNVR0411 / 0412 / 0811 / 0812, when the system temperature reaches above 55°C (131°F), the GV-SNVR records an entry under the system log and records an additional entry for every 3°C (°F) of increment in temperature above 55°C (131°F).

2.6 Enabling Recording

To start recording, click the **Record** button (No. 4, Figure 2-45) and select a camera. To enable recording for all of the connected cameras, select **Start All Monitoring**.

By default, the GV-SNVR records with **Round-the-clock** mode. The default recording resolution and codec depend on the settings of each camera.

- To change recording mode, see *3.2 Recording*.
- To change video resolution, see *3.1 Camera*.

2.7 Playing Back Video

You can instantly play back the recorded videos without interrupting monitoring and recording.

- To instantly play back the recording of one single channel, click the **Camera Name** (No. 1, Figure 2-45) and select **Instant Playback**.
- To instantly play back the recording of all channels, click the **Playback** button (No. 6, Figure 2-45).

For detailed instructions on playing back recorded videos, refer to *4.1 Timeline Player*

2.8 Live Monitoring

On the main screen, you can click the **Division** button  (No. 5, Figure 2-45) and select **1, 4, 6, 8, 9** or **16 Division**. Alternatively, click on the live view of a desired camera to switch to full screen.

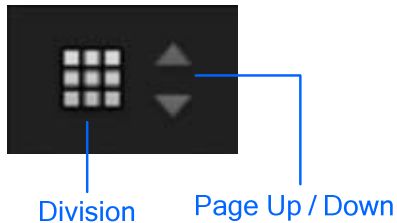

Figure 2-46

Note:

1. The 6 and 8 Division modes are recommended to be used in conjunction with fisheye dewarping for displaying Quad view in channel 1. See [2.8.5 Fisheye Dewarping](#).
 2. In 8 Division, clicking the live view of a camera displayed on one of the small subdivisions switches the live view to be displayed on the large subdivision.
-

2.8.1 Snapshot

To take a snapshot of a live or playback video, follow the steps below.

1. Connect an USB flash drive of FAT32 format to the GV-SNVR.
2. Click the camera name of a desired camera and select **Snapshot**. The message “Snapshot success” pops up when the image is successfully captured and saved to the USB flash drive.

Each image is automatically saved in JPEG format with a file name indicating the date and time of the snapshot taken.

2.8.2 Audio

To enable the audio function on live video, follow the steps below.

Note: To listen to the audio of any camera, make sure the **Enable Audio** function is applied. For details, see [3.1 Camera](#).

1. Click the camera name of the desired camera and select **Speaker**. The audio icon  appears next to the camera name, and the audio is now accessible.
2. To access the audio of a different camera, repeat step 1. The audio of the previous camera is turned off automatically.

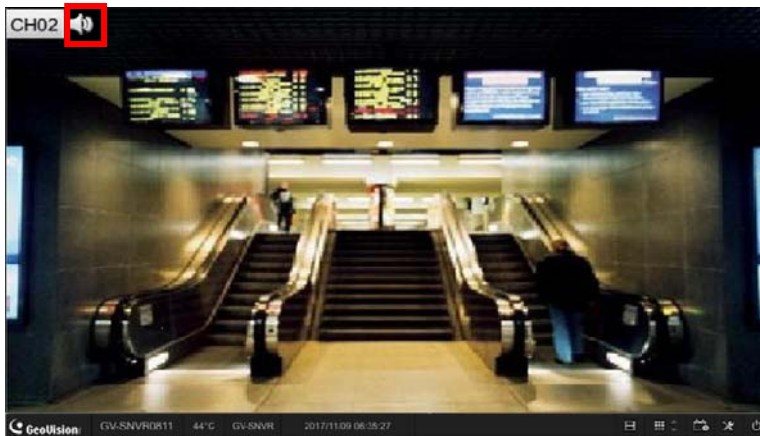

Figure 2-47

2 Getting Started

2.8.2.1 Using Microphone on GV-SNVR0412 / 0812 / 1611

To use the microphone function of GV-SNVR0412 / 0812 / 1611, follow the steps below.

Note: To transmit audio to the speakers of any camera, using the microphone of GV-SNVR, make sure of the following

- The camera specified supports speaker function and is connected to a speaker.
 - A microphone is connected to the Audio In port of GV-SNVR0412 / 0812 / 1611. See [2.2 Connecting the GV-SNVR](#).
 - The **Enable Audio** function is applied. For details, see [3.1 Camera](#).
-

1. Click the camera name of the desired camera and select **Microphone**. The microphone icon  appears next to the camera name, and the audio is now accessible.
2. To transmit audio to a different camera, repeat step 1. The microphone function of the previous camera is turned off automatically.

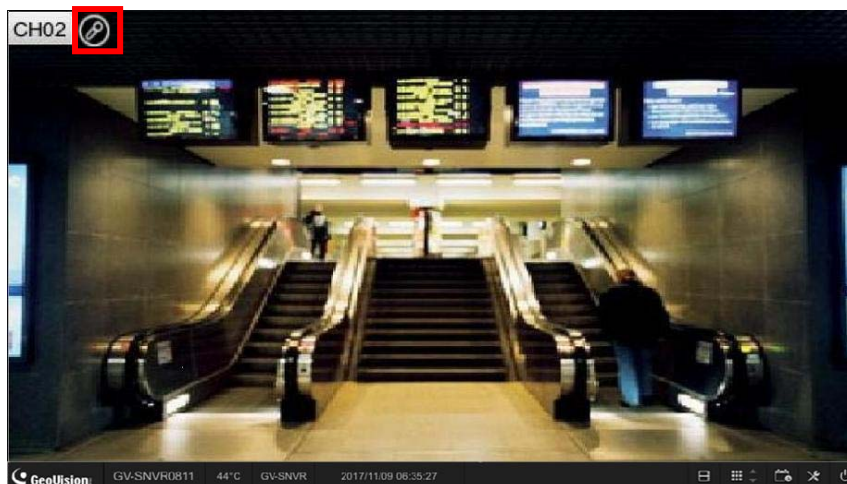

Figure 2-48

2.8.3 PTZ Control

To enable the PTZ function on live video, click the camera name of the desired camera and select **Enable PTZ**. The PTZ control panel appears at the lower-right corner of the live view.

Note:

1. This is only available for cameras supporting PTZ functions.
2. The live view of GV-SD200 / 200-S / 2411 / 2322-IR / 3732-IR can be accessed through all versions of GV-SNVR0411 / 0811, but their PTZ control functions are only available on GV-SNVR0411 firmware V2.61 or later and GV-SNVR0811 firmware V2.50 or later.



Figure 2-49

- **Home:** Brings the PTZ live view back to the Home position.
- **Pan/Tilt Control:** Allows the camera to pan and tilt to any angle.
- **Zoom Control:** Allows the camera to zoom in or out.
- **Focus Control:** Adjusts the camera to focus in or out.
- **Preset Option:** Moves the camera to a preset point by entering a preset number using the onscreen keypad.

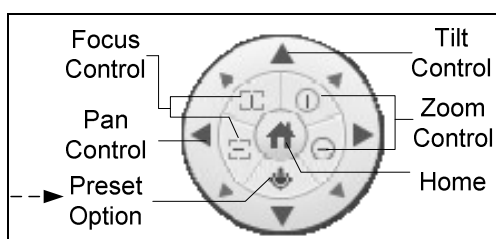

Figure 2-50

2 Getting Started

To enable PTZ control, you can also use the GV-Joystick V2, a plug-and-play device used to pan, tilt, zoom and focus a PTZ camera. When the GV-Joystick V2 is connected to the USB port on the GV-SNVR, the Joystick icon  will appear beside the camera name.



Figure 2-51

For details on the GV-Joystick V2, see *GV-Joystick V2 User's Manual*.

Note: The GV-SNVR does not support GV-Keyboard.

2.8.4 Digital PTZ Function

Note this section is only applicable to **GV-SNVR1600**.

To enable the DPTZ function on live video, click the camera name of the desired camera and select **Enable Digital PTZ**. The PTZ control panel appears at the lower-right corner of the live view.

Click the **Zoom In** button first and then click **Tilt** and **Pan** buttons to move the camera view.



Figure 2-52

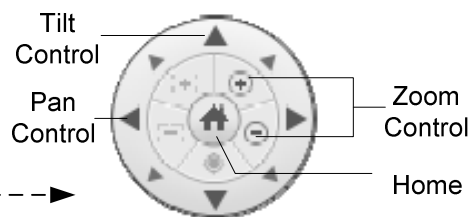

Figure 2-53

- **Home:** Brings the DPTZ live view back to the Home position.
- **Pan/Tilt Control:** Allows you to pan and tilt on the live view.
- **Zoom Control:** Allows you to zoom in or out on the live view.

Note:

1. The Focus Control and Preset functions are not supported.
 2. The DPTZ function is only available for non-PTZ cameras.
-

2.8.5 Fisheye Dewarping

Only for **GV-SNVR0411 / 0412 / 0811 / 0812** that connects to GeoVision IP Fisheye cameras. A fisheye camera allows you to cover all angles of a location with just one camera. Using different fisheye view modes, the distorted hemispherical image produced by the fisheye camera can be converted to a conventional rectilinear projection.

Note:

1. Fisheye Dewarping is not supported when the channel resolution is configured to 4K.
 2. Only one fisheye camera can be dewarped by the GV-SNVR at a time.
-

To enable fisheye dewarping on live video, click the camera name of a fisheye camera and select **Enable fisheye dewarping**. Click the camera name again to see the following options.

- **Camera Modes:** You can choose among four view modes: **Quad view** (Default), **Single view**, **360 degree**, **180 degree**. For details, see *5.1.6 Fisheye View*.

2 Getting Started



- **Image Alignment:** On the upper-right square of the Quad view, click any button from , and the red circle appears. Use the  to align the red circle with the edge of the camera image. For details, see 5.1.6 Fisheye View.



Figure 2-54

- **Camera Position:** Select **Ceiling**, **Wall**, or **Floor** according to where the camera is mounted.
- **Reset:** Restore to Quad view setting.

Use the  to zoom in, zoom out or adjust the direction of the camera image.

2.8.6 Image Orientation

Note this section is only applicable to **GV-SNVR0411 / 0412 / 0811 / 0812 / 1611**.

To rotate the image of a live or recorded video with the image orientation function, click the camera name of a desired camera, select **Image Orientation** and choose from one of the following options: **Normal** (Default), **Horizontal Mirror**, **Vertical Flip** or **Rotate 180**.

Chapter 3 System Configuration

This section introduces the following settings: Camera, Record, Network, Storage, Display, Service, System, and Account.

3.1 Camera

To access the camera settings, click the **Edit** button  of the camera on the Camera page.





No.	CH	Model	IP Address	Port	MAC Address	Resolution	Bandwidth	Status	Brand	
<input checked="" type="checkbox"/>	1	GV-FER5302/3 (128M)	192.168.0.3	10000	00-13-E2-FF-0D-CC	H264:2560x1920 H264:640x480	1.2 Mbps	Connected	GeoVision	
<input checked="" type="checkbox"/>	2	GV-CAW220	192.168.0.4	10000	00-13-E2-FF-04-63	H264:1920x1080 H264:448x252	0.0 Mbps	Connected	GeoVision	
<input type="checkbox"/>	3	GV-FD220D/FD221D	192.168.0.10	10000	00-13-E2-04-D3-75				GeoVision	
<input type="checkbox"/>	4	GV-EBD4711	192.168.6.238	ONVIF	00-13-E2-FA-CD-BE				GeoVision_2	

Figure 3-1

The Camera Settings page appears.

3.1.1 GV-IP Camera Settings

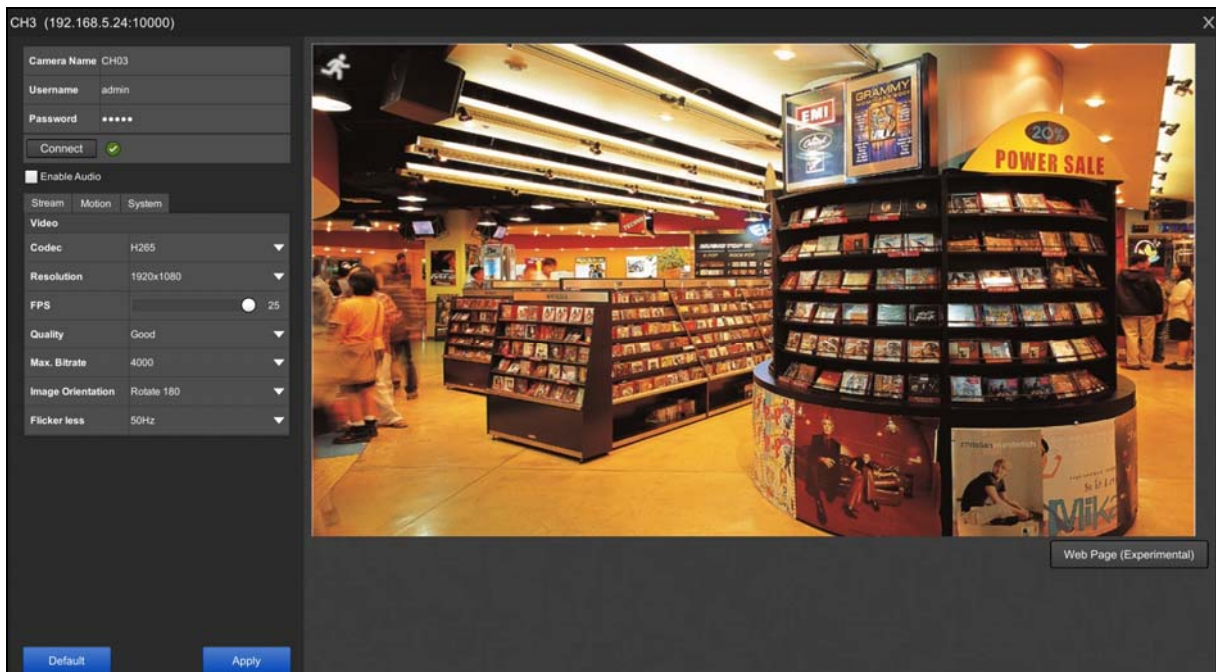

Figure 3-2

- **Camera Name:** Type a desired name for the camera.
- **Username:** Type the username of the camera. The default is **admin**.
- **Password:** Type the password of the camera. The default is **admin**.
- **Enable Audio:** Click to enable audio streaming.

3 System Configuration

[Stream]

- **Codec:** For GV-SNVR0411 / 0412 / 0811 / 0812 / 1611, select video codec between H.264 and H.265. For GV-SNVR0400F / 1600, the video codec is H.264.
- **Resolution:** Select the video resolution for the camera.
- **FPS:** Set up recording frame rate for the camera.
- **Quality:** Select the level of video quality.
- **Max. Bit Rate:** Set up the maximum bit rate of video stream.
- **Image Orientation:** Adjust the image orientation by selecting **Normal**, **Horizontal Mirror**, **Vertical Flip** or **Rotate 180**.
- **Flicker less:** The frequency of your camera's image is automatically matched with the frequency of indoor light sources, e.g. fluorescent lighting. You can also select 50 Hz or 60 Hz manually. If the frequencies don't match, faint light or dark bars may appear in your images. Check the power utility to determine which frequency is used.

[Motion]

- **Motion Area:** Draw up to 8 areas with different sensitivity values on the image for motion detection.
- **Motion Sensitivity:** Configure the sensitivity value from 1 to 10 for the motion detection. The higher the value, the more sensitive the camera is to motion.

[System]

- **Password:** Only for GV-SNVR0411 / 0412 / 0811 / 0812 / 1611. Change the password of the camera by typing in a desired password.

To enable adjusted settings, click **Apply**.

Only for GV-SNVR0411 / 0412 / 0811 / 0812 / 1611. To load the camera's default settings, click **Default**.

Note:

1. For the **FPS** function, the GV-SNVR supports up to 30 fps.
 2. After loading default, the IP camera will restart and may take some time to reconnect.
 3. The **Web Page** button is intended for configuring the login info of GV-IP cameras without default ID and password and accessing of third-party camera's web address. See *3.1.1.1 Configuring GV-IP Cameras without Default ID and Password*.
-

3.1.1.1 Configuring GV-IP Cameras without Default ID and Password

Only for **GV-SNVR0411 / 0412 / 0811 / 0812 / 1611**. For GV-IP cameras without default ID and password, follow the steps below to configure the cameras from the GV-SNVR.

1. Once connected, click the **Edit** button  next to the GV-IP camera you want to configure and click **Web Page**.

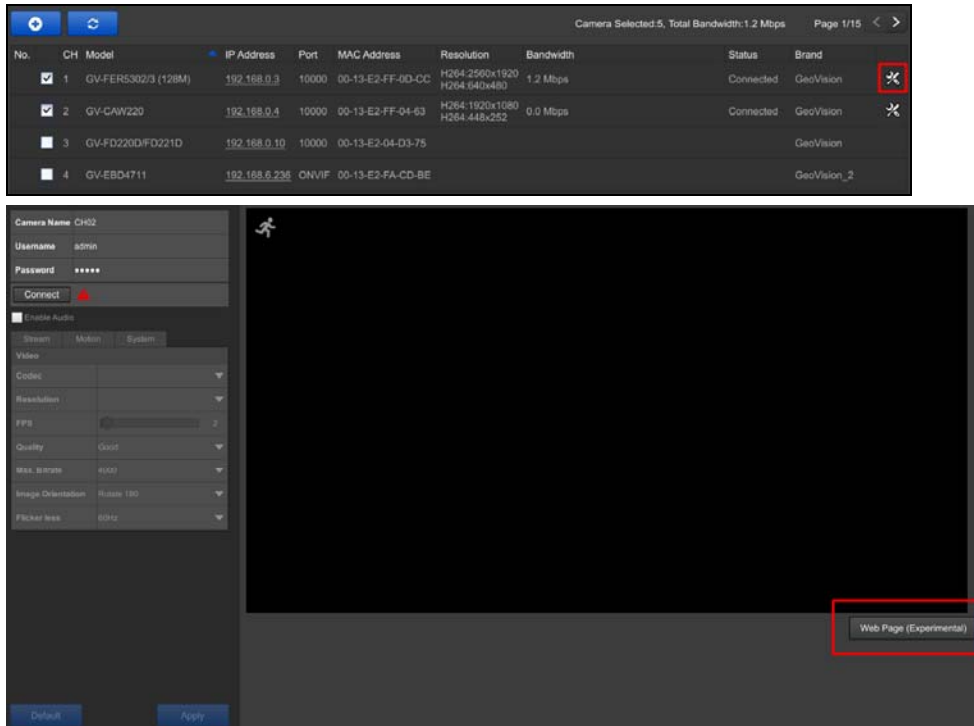

Figure 3-3

2. Fill in the required information in the account setup page of the GV-IP camera and click **Create**.

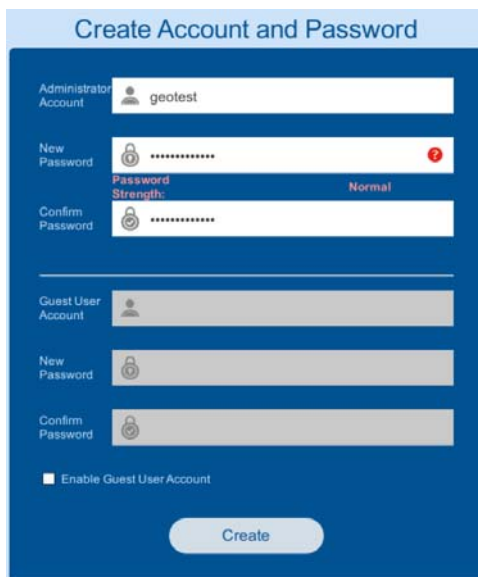
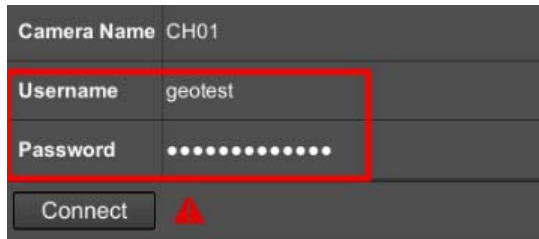

Figure 3-4

3 System Configuration

3. Close the account setup page, type the **Username** and **Password** set and click **Connect**.



The screenshot shows a configuration form with the following fields:

Camera Name	CH01
Username	geotest
Password	••••••••••

Below the fields is a **Connect** button and a red warning triangle icon.

Figure 3-5

3.1.2 Third-Party IP Camera Settings (ONVIF)



Figure 3-6

- **Camera Name:** Type a desired name for the camera.
- **Username:** Type the username of the camera. The default is **admin**.
- **Password:** Type the password of the camera. The default is **admin**.
- **Enable Audio:** Click to enable audio streaming.

[Stream]

- **Stream:** Select a video stream to configure.

Video

- **Source Configuration:** The Source Configuration displays type of video source of the camera connected.

- **Encoder Configuration:** The Encoder Configuration displays the type of video encoding of the camera connected.
- **Codec:** For GV-SNVR0411 / 0412 / 0811 / 0812 / 1611, select video codec between H.264 and H.265. For GV-SNVR0400F / 1600, the video codec is H.264.
- **Resolution:** Select the video resolution for the camera.
- **FPS:** Set up recording frame rate for the camera.
- **GOP:** Set the maximum number of seconds, from 5 to 250, between every key frame. The higher the value, the lower number of key frames within a time interval.
- **Quality:** Select the level of video quality.
- **Max. Bit Rate:** Set up the maximum bit rate of video stream.

Audio

- **Source Configuration:** The Source Configuration displays type of audio source of the camera connected.
- **Encoder Configuration:** The Encoder Configuration displays the type of audio encoding of the camera connected.
- **Codec:** The audio codec supported by the GV-SNVR is G.711.

[Motion]

- **Motion Area:** Draw a specified area on the image for motion detection.
- **Motion Sensitivity:** Configure the sensitivity value for the motion detection.

[System]

- **Password:** Only for GV-SNVR0411 / 0412 / 0811 / 0812 / 1611. Change the password of the camera by typing in a desired password.

To enable adjusted settings, click **Apply**.

Only for GV-SNVR0411 / 0412 / 0811 / 0812 / 1611. To load the camera's default settings, click **Default**.

Note:

1. For the **FPS** function, the GV-SNVR supports up to 30 fps.
 2. After loading default, the IP camera will restart and may take some time to reconnect.
 3. Camera settings that can be configured through the GV-SNVR may vary with different camera models.
-

3 System Configuration

4. When the camera does not support motion detection, the message “Not supported by camera” is shown.
5. The **Web Page** button is intended for configuring the login info of GV-IP cameras without default ID and password and accessing of third-party camera’s web address. See 3.1.1.1 *Configuring GV-IP Cameras without Default ID and Password*.

3.2 Record

You can set up desired recording modes for specific periods on specific days for each connected camera. The default recording mode is Round-the-clock.

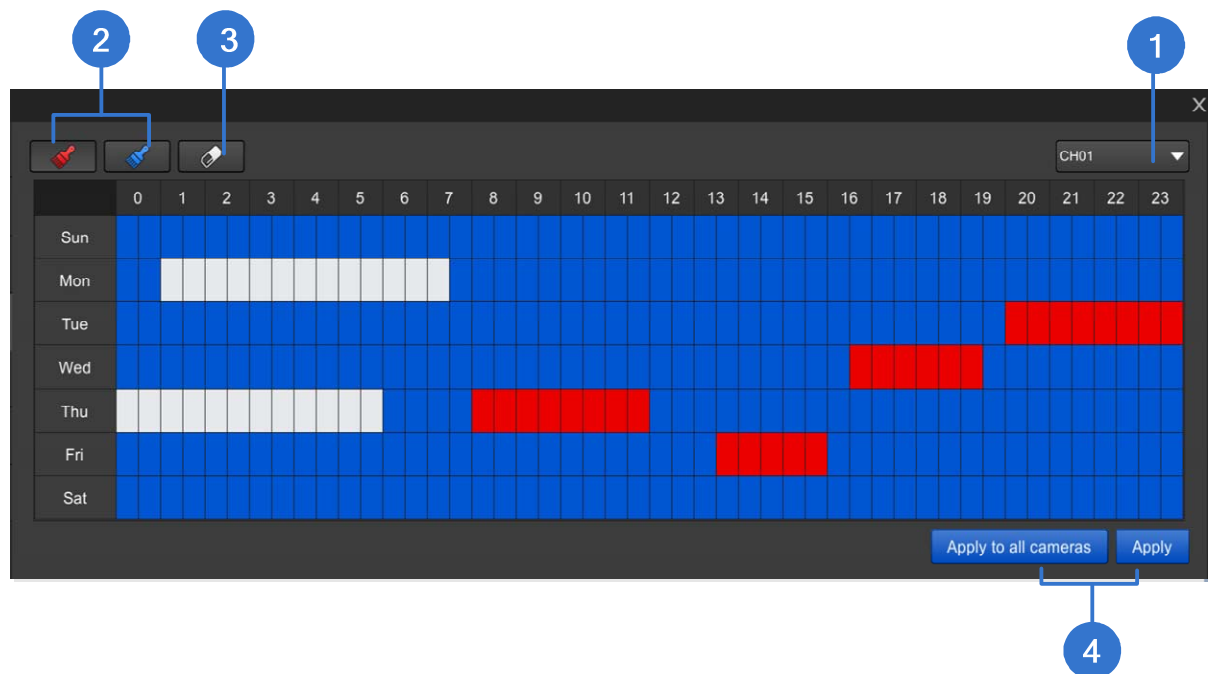





Figure 3-7

1. Select a camera from the drop-down list at the upper-right corner.
2. To set up a recording mode, click the **Motion Recording** icon  or **Round-the-clock** icon  and drag the cursor on the desired period.
3. To clear the settings, click the **Clear** icon  and drag the cursor on the desired period.
4. Click **Apply** or **Apply to all cameras** as needed to enable the settings.

3.3 Network

The Network section includes basic network configurations that enable the GV-SNVR to be connected to the network. By default, the GV-SNVR is assigned with a dynamic IP address when connecting to the network.

3.3.1 WAN / LAN

[LAN / WAN] The Settings can be found under the **LAN** or **WAN** tab depending on the model of your GV-SNVR. The following is exemplified using GV-SNVR0812.

WAN	DDNS	E-Mail	Web Server
IP Configuration		DHCP	
MAC Address	00:13:e2:20:24:c9		
IP Address	192.168.0.99		
Subnet Mask	255.255.248.0		
Gateway	192.168.0.1		
Primary DNS	192.168.0.1		
Second DNS	192.168.0.2		
<input type="button" value="Apply"/>			

Figure 3-8

- **IP Configuration:** Select **DHCP** or **Static** according to your network environment.
- **MAC Address:** Displays the MAC Address of the GV-SNVR.
- **DHCP Server:** (Only for GV-SNVR0411 / 0811 / 1611) Select **Enable** or **Active** to automatically assign a dynamic IP address to the connected cameras.

Note:

1. The **DHCP Server** function cannot be used in a network environment with DHCP servers.
 2. After enabling the **DHCP Server** function, the IP Configuration setting of your GV-SNVR's LAN will be changed to **Static IP** automatically and the IP Address will be fixed. The default static IP address is 192.168.0.100 or 192.168.100.100.
-

3 System Configuration

To assign a static IP address, select **Static** and fill out the required settings below.

- **IP Address:** Type a static IP address for the GV-SNVR. The default is **192.168.0.100** (or **192.168.100.100** for GV-SNVR1611).
- **Subnet Mask:** Type a subnet mask. The default is **255.255.255.0**.
- **Gateway:** Type a gateway. The default is **192.168.0.1**.
- **Primary DNS:** Type a primary DNS. The default is **192.168.0.1** (or **192.168.100.101** for GV-SNVR1611).
- **Second DNS:** Type a second DNS. The default is **192.168.0.2** (or **192.168.100.250** for GV-SNVR1611).

Only for **GV-SNVR1600**, to enable the PPPoE connection, select **PPPoE** and fill out the required settings below.

- **Primary DNS:** Type a primary DNS. The default is **192.168.100.1**.
- **Second DNS:** Type a second DNS. The default is **192.168.100.2**.
- **PPPoE Username:** Type the username you have registered for PPPoE.
- **PPPoE Password:** Type the password you have registered for PPPoE.

IMPORTANT: For GV-SNVR1600, when both LAN and WAN are applied simultaneously, note the following:

- Only WAN can be connected to the Internet.
 - Only the IP Cameras under the same LAN can be searched by GV-SNVR1600. To connect with the IP cameras under WAN, you must add the cameras manually. For details, see [2.3.2 Manually Connecting IP Camera](#).
-

Click **Apply**. The GV-SNVR is now accessible by entering the assigned IP address on Web browser.

[Bridge] only for GV-SNVR1611

WAN	LAN	Bridge	DDNS	E-Mail	Web Server
Enable	<input checked="" type="checkbox"/> Active				
IP Configuration	DHCP				
MAC Address	00-13-e2-#30-9d				
IP Address	192.168.4.135				
Subnet Mask	255.255.248.0				
Gateway	192.168.0.1				
Primary DNS	8.8.8.8				
Second DNS	168.95.1.1				
DHCP Server	<input type="checkbox"/> Active				
Start IP address					
End IP address					
<input type="button" value="Apply"/>					

Figure 3-9

- **Enable:** Select **Active** to establish a bridge connection between the WAN and LAN of the GV-SNVR.
- **IP Configuration:** Select **DHCP** or **Static** according to your network environment.
- **MAC Address:** Displays the MAC Address of the GV-SNVR.
- **DHCP Server:** Select **Active** to automatically assign a dynamic IP address to the connected cameras.
 - Set the range of the IP addresses for the connected cameras by defining the **Start IP Address** and **End IP Address**. The default of each is **192.168.0.101** and **192.168.0.250**.

To assign a static IP address, select **Static** IP for **IP Configuration** and fill out the required settings below.

- **IP Address:** Type a static IP address. The default is **192.168.0.100**.
- **Subnet Mask:** Type a subnet mask. The default is **255.255.255.0**.
- **Gateway:** Type a gateway. The default is **192.168.0.1**.
- **Primary DNS:** Type a primary DNS.
- **Second DNS:** Type a second DNS.

3 System Configuration

3.3.2 WiFi

Note this function is only applicable to **GV-SNVR0411 / 0811 / 1611**.

LAN	Wi-Fi	DDNS	E-Mail	Web Server
Enable	<input checked="" type="checkbox"/> Active			
SSID				<input type="button" value="Search"/>
Encryption	None			
Password				
IP Configuration	DHCP			
MAC Address				
IP Address				
Subnet Mask				
Gateway				
Primary DNS				
Second DNS				
<input type="button" value="WPS"/>	<input type="button" value="Disconnect"/>		<input type="button" value="Clear"/>	<input type="button" value="Apply"/>

Figure 3-10

Before using the WiFi function, make sure to insert a GV-WiFi Adapter.

To enable WiFi, click **Active**.

- **SSID:** Click **Search** to detect WiFi networks within range of the GV-SNVR.
- **Encryption:** Select the type of encryption of the selected network.
- **Password:** Type the login password for the network selected.
- **IP Configuration:** Select **DHCP** for the network to assign an IP address for the WiFi adapter, or select **Static** to type the IP information, including **IP address**, **Subnet Mask**, **Gateway** and/or **Primary** and **Secondary DNS**.
- **WPS:** Alternatively, you can connect GV-SNVR to your router through WPS. To do this, enable WPS on your router, click the **WPS** button and type the required information.

IMPORTANT: Do not set the WiFi Subnet to be the same as the LAN, or it will result in a conflict of the system's network.

3.3.3 DDNS

DDNS (Dynamic Domain Name System) provides a convenient way of accessing the GV-SNVR when using a dynamic IP address. DDNS assigns a domain name to the GV-SNVR, so you do not need to go through the trouble of checking if the IP address assigned by DHCP Server or ISP (in xDSL connection) has changed. Before enabling the following DDNS function, you should have applied for a Host Name from the DDNS service provider's website. The provider is GeoVision DDNS Server:

<http://ns.gvdip.com/register.aspx>.

LAN	Wi-Fi	DDNS	E-Mail	Web Server	
Enable		<input checked="" type="checkbox"/> Active			
DDNS Server		GeoVision DDNS Server			
DDNS Name		snvr.gvdip.com			
DDNS Password		••••••			
Last Update Time					
<input type="button" value="Apply"/>					

Figure 3-11

To enable the DDNS function, click **Active**, type the Name and Password you have registered with GeoVision DDNS Server and click **Apply**.

3 System Configuration

3.3.4 E-Mail

Configure your mail server to allow e-mail notification upon:

- error of writing recording data to the hard disk drive
- request for the retrieval of username and password for system login

LAN	Wi-Fi	DDNS	E-Mail	Web Server
Sender	admin@geovision.com.tw			
Receiver	security@geovision.com.tw			
SMTP Server	geovision.com.tw			
SMTP Port	25			
Authentication	Disable ▼			
SMTP Username				
SMTP Password				
				Apply

Figure 3-12

- **Sender:** Type the sender's e-mail address.
- **Receiver:** Type the recipients' e-mail address.
- **SMTP Sever:** Type the mail server's URL or IP address.
- **SMTP Port:** Type the mail server's port value.
- **Authentication:** Select **Enable** if the SMTP Server requires authentication, and type a valid username and password to log in the SMTP server in the next two columns. Select **Enable SSL** if the e-mail server requires SSL authentication for connection.

Click **Apply** to save the e-mail settings configured.

3.3.5 Web Server

LAN	Wi-Fi	DDNS	E-Mail	Web Server
Web Port		80		
Stream port (VSS)		10000		
				Apply

Figure 3-13

- **Web Port:** The Web Port is used for connection with compatible GeoVision software and allows users to access GV-SNVR through the Web interface. The default port is 80.
- **Streaming port (VSS):** The VSS streaming port is used for connection with GV-Eye mobile application and compatible GeoVision software. The default port is 10000.

3 System Configuration

3.4 Storage

You must format the hard drive before enabling video recording. For details, see 2.4 *Formatting Hard Drive*.

3.5 Display

You can adjust how you want GV-SNVR to be displayed.

Language	English	▼
Show Style	Default	▼
Date Format Setup	YYYY-MM-DD	▼
Temperature	°C	▼
Auto Scan(sec.)	<input type="range" value="15"/>	15
Resolution	1080P	▼
<input type="button" value="Apply"/>		

GV-SNVR0400F / 1600

Language	English	▼
Date Format Setup	YYYY/MM/DD	▼
Temperature	°C	▼
Auto Scan(sec.)	<input type="range" value="Disable"/>	Disable
Resolution	1080p	▼
Preserve aspect ratio (video)	<input checked="" type="checkbox"/> Active	
<input type="button" value="Apply"/>		

GV-SNVR0411 / 0412 / 0811 / 0812 / 1611

Figure 3-14

- **Language:** Select a language for the OSD interface.
- **Show Style:** Only for GV-SNVR0400F / 1600. Select a color scheme for GV-SNVR interface. Default scheme is black.

- **Date Format Setup:** Select a display format for the date.
- **Temperature:** Select to display the operating temperature in Celsius or Fahrenheit.
- **Auto Scan (sec.):** Set a scan interval in seconds to enable the Auto Scan function. If the number of cameras added exceeds the number of live view grids available, the cameras will be shown in sequence for the selected time interval. In the example of a 15-second scan interval with 16 cameras in 9-ch division, GV-SNVR will alternate between 15 seconds of showing cameras 1 - 9 and another 15 seconds for cameras 10 - 16.
- **Resolution:** Select the video output resolution.

Model	Video Output
GV-SNVR0411 / 0412 / 0811 / 0812 / 1611	1080p, 4K
GV-SNVR0400F	720p, 1080p, 1080i
GV-SNVR1600	1080p

- **Preserve Aspect Ratio (Video):** Only for GV-SNVR0411 / 0412 / 0811 / 0812 / 1611. Click **Active** to preserve the aspect ratio of your camera. Once applied, restart the GV-SNVR for the change to take effect.

IMPORTANT: For GV-SNVR0411 / 0412 / 0811 / 0812 / 1611, when you configure the channel resolution to 4K, be sure your monitor is a 4K-capable monitor; otherwise flickering / no image will be displayed on the screen. If it occurs, load factory default, and the resolution will be reset to 1080p.

3.6 Service

3.6.1 Connecting GV-SNVR with GV-Center V2 and GV-Vital Sign Monitor

In the Service page, you can connect GV-SNVR with GV-Center V2 and GV-Vital Sign Monitor.

1. Click **Active** to enable connection with GV-Center V2 or GV-Vital Sign Monitor.

Center V2	VSM	Mobile APP	Cloud Center
State	<input checked="" type="checkbox"/> Active		
IP Address	192.168.0.101		
Port	5551		
Username	a		
Password	•		
Event:Motion	<input type="checkbox"/> CH01	<input type="checkbox"/> CH02	<input type="checkbox"/> CH03
	<input type="checkbox"/> CH05	<input type="checkbox"/> CH06	<input type="checkbox"/> CH07
Event:Video Lost	<input type="checkbox"/> CH01	<input type="checkbox"/> CH02	<input type="checkbox"/> CH03
	<input type="checkbox"/> CH05	<input type="checkbox"/> CH06	<input type="checkbox"/> CH07
Event:I/O Trigger	<input checked="" type="checkbox"/> Alarm01	<input checked="" type="checkbox"/> Alarm02	<input checked="" type="checkbox"/> Alarm03
Schedule Setting			
Index	1 ▼		
Enable	<input type="checkbox"/> Active	0 : 0 - 0 : 0 ▶ Cross Day	
weekend	Disable ▼		
Apply			

Figure 3-15

2. Type the **IP Address** or the domain name of the GV-Center V2 or GV-Vital Sign Monitor.
3. Modify the **Port** if needed.
4. Type the **Username** and **Password** of the GV-Center V2 or GV-Vital Sign Monitor.
5. Only for connecting GV-SNVR0411 / 0412 / 0811 / 0812 / 1600 / 1611, select camera channels. When Motion or Video Lost Event occurs on the selected cameras, the GV-SNVR will send a notification or a video to GV-Center V2 or GV-Vital Sign Monitor.

6. Only for connecting GV-SNVR0412 / 0812,
 - Select the desired input alarms. The GV-SNVR will send a notification to GV-Center V2 upon the input triggers.
 - In **Schedule Setting**, configure the schedules for sending notifications to GV-Center V2. You can configure up to 3 schedules by selecting a **Index** and then defining a specified period of time for weekdays or for weekend.
7. Click **Apply**. A green icon will appear if the connection is established successfully.

Note:

1. For compatible version of GV-Center V2 and GV-Vital Sign Monitor, see [1.4.2 Supported GeoVision Applications](#) for details.
 2. For GV-Center V2, audio function of live view is only supported in Single Live View Window, and the IP device must be connected through stream 1.
 3. For GV-Vital Sign Monitor, the Video Log Storage function is not supported when viewing subscriber status.
-

3.6.2 Regulating People Flow with GV-IP Cameras

For GV-SNVR0412 / 0812 with firmware version V1.05 / V1.10 or later only, by integrating GV-TDR2700 series, of firmware version V1.03 or later, the **PPL** tab on the Service page can monitor the total people count at a vicinity and trigger output alarms and/or send out e-mail alerts accordingly when the predefined limit is reached for effective people flow control. See [here](#) for the detailed setup and related settings.

3.6.3 Connecting GV-Eye to GV-SNVR

You can connect GV-Eye to GV-SNVR using the QR-code scan.

Note:

1. For the versions of GV-Eye compatible with your GV-SNVR, see *1.4.2 Supported GeoVision Applications*.
 2. To use this function, the GV-SNVR must be connected to the Internet.
 3. Up to 2 GV-Eye / Remote ViewLog / SNVR Viewer can be connected to a GV-SNVR at a time.
-

Click **Mobile APP**. This interface appears. To connect GV-Eye to GV-SNVR using the QR-code scan, refer to *5. GV-Relay QR Code* in [GV-Eye Installation Guide](#).



Figure 3-16

3.6.4 Connecting GV-Cloud Center to GV-SNVR

Note this function is only applicable to **GV-SNVR0411 / 0412 / 0811 / 1611** and **GV-SNVR0812 V1.05** or later.

You can connect GV-Cloud Center to GV-SNVR using the Cloud Center account registered at <https://dashboard.vsm.mygvcloud.com/>.

1. Click **Cloud Center**. This interface appears.

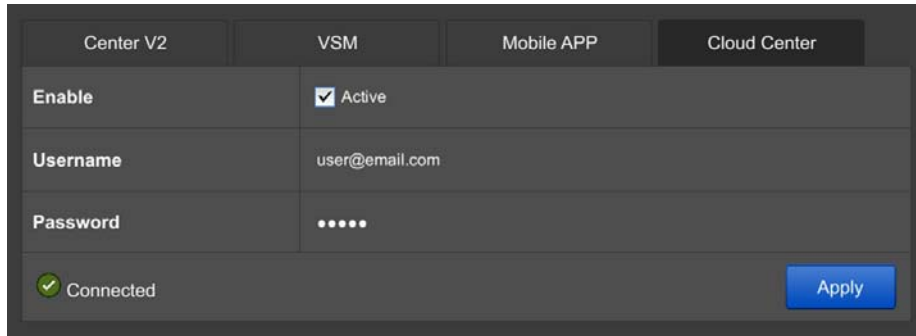

Center V2	VSM	Mobile APP	Cloud Center
Enable	<input checked="" type="checkbox"/> Active		
Username	user@email.com		
Password	•••••		
<input checked="" type="checkbox"/> Connected			<input type="button" value="Apply"/>

Figure 3-17

2. Select **Active** to enable.
3. Type the **Username** and **Password** of your Cloud Center account.
4. Click **Apply**. A green icon will appear if the connection is established successfully.
5. Go to <https://dashboard.vsm.mygvcloud.com/> and fill in the required information to view GV-SNVR on GV-Cloud Center.



Figure 3-18

Note:

1. To use this function, the GV-SNVR must be connected to the Internet.
 2. Only the system log of GV-SNVR are accessible through GV-Cloud Center. See [System Log](#) in 3.8 System and refer to [GV-Cloud Center User's Manual](#) [here](#).
-

3.7 Event

Note this function is only applicable to **GV-SNVR0412 / 0812 / 1611**.

In Event settings, you can configure the GV-SNVR to trigger output alarms, start video recording, send e-mail alerts and/or trigger buzzer upon motion detection and input trigger events.

Type	Alarm In ▼
Alarm In	1 ▼
State	<input checked="" type="checkbox"/> Active
Normal State	Open circuit ▼
Trigger	
Alarm Out	1
Alarm Out Duration	0 (0-600 sec.)
Record	1 2 3 4 5 6 7 8
Center V2	1 2 3 4 5 6 7 8
E-Mail	<input type="checkbox"/> Active
State: ○○○○ ○	
<input type="button" value="Apply"/>	

Figure 3-19

- **Type:** Select the type of events you wish to configure, between **Alarm In** or **Motion**.
 - **Alarm In:** When the Type of events is selected as Alarm In, select the desired input module from **1 ~ 4**.
 - **Motion:** When the Type of events is selected as Motion, select the desired camera channel from **1 ~ 4 / 1 ~ 8 / 1 ~ 16** respectively for GV-SNVR0412 / 0812 / 1611.
 - **State:** When the Type of events is selected as Alarm In, select **Active** to enable the input module.
 - **Normal State:** When the Type of events is selected as Alarm In, select between **Open circuit** or **Closed circuit** to define the module as normally open or normally closed, respectively.
 - **People counter:** For GV-SNVR0412 / 0812 with firmware version V1.05 / 1.10 or later only, please see *3.6.2 Regulating People Flow with GV-IP Cameras*.

[Trigger]

- **Alarm Out:** Select the output to be triggered upon input trigger or motion detection events.
- **Alarm Out Duration:** Specify the time in which the output is triggered for, from 0 to 600 seconds.
- **Record:** Select the desired camera channel(s) to start recording upon input trigger or motion detection events.
- **Center V2:** Select the desired camera channel(s) to start recording upon input trigger or motion detection events.
- **E-Mail:** Select **Active** to send e-mail alerts upon input trigger or motion detection events. See 3.3.4 *E-Mail*.
- **Buzzer:** Only for GV-SNVR1611, select **Active** to sound the buzzer on the GV-SNVR upon input trigger or motion detection events.
- **State:** The State icons indicate the status of the 4 inputs and 1 output by turning red upon trigger.

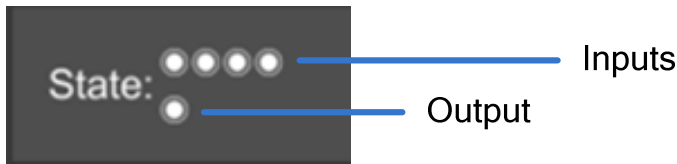

Figure 3-20

3 System Configuration

3.8 System

In System settings, you can change the device name and login information of the GV-SNVR. You can also access the Time settings and System Log.

System	Time	System Log	Licenses
Device Name	GV-SNVR		
Default Camera Account	admin		
Default Camera Password	•••••		
Keep Days	<input type="checkbox"/> <input type="text" value=""/>		Disable
Auto Reboot			
Active	<input checked="" type="checkbox"/> Active	11 : 30	
	<input checked="" type="checkbox"/> Select All	<input checked="" type="checkbox"/> Sun	<input checked="" type="checkbox"/> Mon
	<input checked="" type="checkbox"/> Wed	<input checked="" type="checkbox"/> Thu	<input checked="" type="checkbox"/> Fri
		<input checked="" type="checkbox"/> Tue	<input checked="" type="checkbox"/> Sat
<input type="button" value="Load Default"/>		<input type="button" value="Firmware Upgrade"/>	
			<input type="button" value="Apply"/>

Figure 3-21

- **Device Name:** Type a desired name for the GV-SNVR.
- **Default Camera Account:** Set up the default username for cameras connecting to the GV-SNVR. The default is **admin**.
- **Default Camera Password:** Set up the default password for cameras connecting to the GV-SNVR. The default is **admin**.
- **Keep Days:** Only for GV-SNVR0411 / 0412 / 0811 / 0812 / 1600 / 1611, drag the slider to specify from 1 to 31 days to keep the video files in storage.
- **Auto Reboot:** Only for GV-SNVR0412 / 0812, select **Active**, then select the desired time and day to automatically reboot.

To restore the GV-SNVR to its default settings, click **Load Default** and follow the on-screen instructions. Alternatively, press the **Load Default** button on the device for 15 seconds.

Alternatively, you can import / export system settings or update firmware through the GV-IP Device Utility. For details, see 6.2 *Using the GV-IP Device Utility*.

[Time]

System	Time	System Log	Licenses
Time Zone	(UTC+08:00) Taipei		
Daylight Saving Time	<input type="checkbox"/> Enable		
Enable NTP	<input checked="" type="checkbox"/> Enable		
NTP Server	pool.ntp.org		
Date Setup	<input type="text" value="2020/10/28"/>		
Time Setup	<input type="text" value="11"/> : <input type="text" value="17"/> : <input type="text" value="17"/>		
			<input type="button" value="Apply"/>

Figure 3-22

- **Time Zone:** Select the time zone of your location.
- **Daylight Saving Time:** Click **Enable** and type the start time and end time for the system to automatically adjust to Daylight Saving Time.
- **Enable NTP:** Click **Enable** to enable NTP and type the URL of a network time server to synchronize the time of the GV-SNVR accordingly. Otherwise, manually set up the date and time by filling out the corresponding fields.

To enable the adjusted settings, click **Apply**.

Note: You can also use the [GV-IP Device Utility](#) to synchronize the date and time of the GV-SNVR with a computer. For details, see [GV-IP Device Utility Installation Guide](#)

3 System Configuration

[System Log]

This page lists all the changes made to the system.





System		Time	System Log		Licenses	Page 1/133			
No.	Time	Channel	Type	Event	Note				
1	2020/10/28 11:16:59		User	Login	Web (192.168.0.168)				
2	2020/10/28 10:40:15		User	Log Out	Web (192.168.0.168)				
3	2020/10/28 10:29:51		User	Login	Web (192.168.0.168)				
4	2020/10/27 23:00:07		System	NTP Time Sync	2020/10/27 23:00:00				
5	2020/10/27 18:56:50		User	Modify Time	eth0				
6	2020/10/27 18:56:49		System	Network Resume	eth0				
7	2020/10/27 18:56:27		User	Modify Time	eth0				
8	2020/10/27 18:56:21		User	Modify Time	eth0				
9	2020/10/27 18:56:18		System	Network Failure	eth0				
10	2020/10/27 18:56:15		User	Modify Time	eth0				
11	2020/10/27 18:56:13		System	Network Resume	eth0				
12	2020/10/27 18:56:10		User	Modify Time	eth0				
13	2020/10/27 18:56:03		User	Modify Time	eth0				
14	2020/10/27 18:55:57		User	Modify Time	eth0				
15	2020/10/27 18:55:51		System	Network Failure	eth0				
16	2020/10/27 18:55:51		User	Modify Time	eth0				
17	2020/10/27 18:55:49		System	Network Resume	eth0				
18	2020/10/27 18:55:49		System	Network Failure	eth0				
19	2020/10/27 18:55:46		System	Network Resume	eth0				
20	2020/10/27 18:55:45		User	Modify Time	eth0				

Figure 3-23

To export the system log, click the **Export** button  at the upper-right corner and click **Apply**. A USB flash drive needs to be inserted to the GV-SNVR prior to exporting.

To search for specific events, click the **Filter** button  at the upper-right corner to limit the search results using the following options.

- **Start / End Time:** Set up the desired time period.
- **Channel:** Select a channel.
- **Type:** Select **User** or **System**.
- **Event:** Select a type of event.

3.9 Account

In the Account settings, you can manage up to 8 users, including admin, operator, and guest, of the GV-SNVR, and grant different permissions to operators.

Note:

1. The Admin account has full access to the functions of GV-SNVR. Make sure to use the username and password of the Admin account if you are connecting to a GV-Software.
 2. The Guest account only has access to the live view and playback of GV-SNVR.
-

Adding an operator

1. Click . Select the desired **User Type** and type the necessary information for **Username**, **Password**, and **Confirmation**.

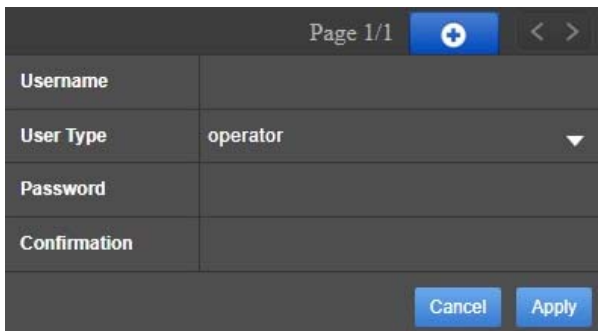



Figure 3-24

2. Click **Apply** to finish adding the new account.
3. To configure permissions, click  of the desired account. This page appears.

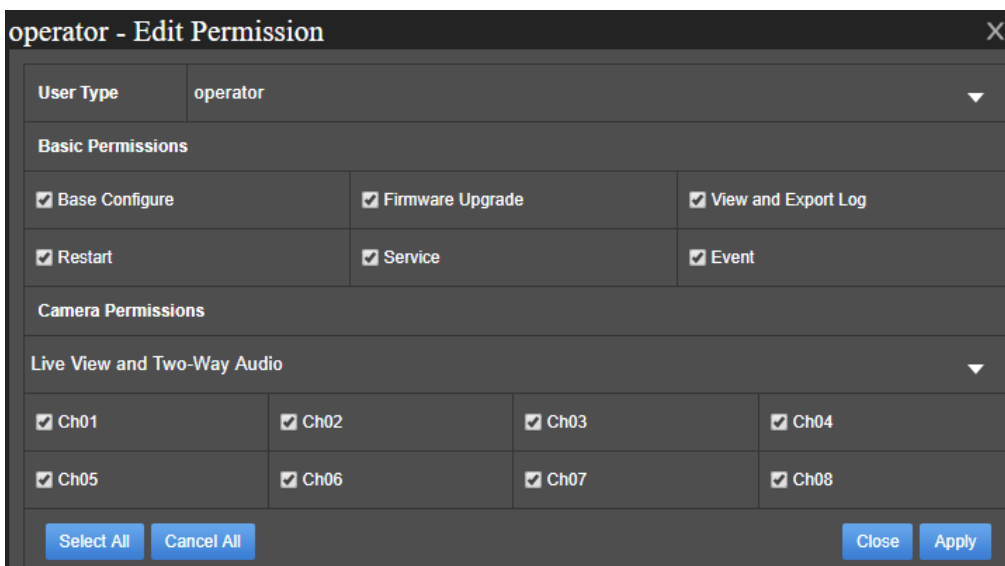

Figure 3-25

3 System Configuration

4. On the Edit Permission page, you can configure the **User Type**, **Basic Permissions** and **Camera Permissions** of the selected account.
 - **User Type:** You can change Operator to Guest which only has access to live view and playback functions.
 - **Basic Permissions:** Configure the permissions you wish to grant or deny access to.
 - ⊙ **Base Configure:** Access to **Network** and **System** settings.
 - ⊙ **Firmware Upgrade:** Access to Firmware Upgrade in System settings.
 - ⊙ **View and Export Log:** Access to System Log in System settings.
 - ⊙ **Restart:** Access to **Reboot**. See details in *2.5 Main Screen*.
 - ⊙ **Service:** Access to Service settings.
 - ⊙ **Event:** Access to Event settings.
 - **Camera Permissions:** Select through each option in the drop-down list and configure specific channels you wish to grant or deny access to.

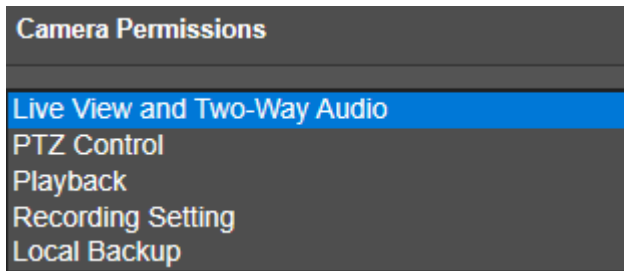

Figure 3-26

Chapter 4 Video Playback

The timeline player plays back recorded video without affecting recording. There are two ways to launch the timeline player:

- On the main screen, click the **Playback** button (No. 6, Figure 2-28).
- On the camera live view, click the desired camera name and select **Instant Playback**.

On the timeline player screen, the system automatically plays back video recording from 3 minutes before the playback function is enabled.

4.1 Timeline Player

Without further settings, you can play back the video recording by selecting a time and clicking the **Play** button on Playback Panel. To switch the current view mode, click the **Division** button. Here we use GV-SNVR0811 for illustration.

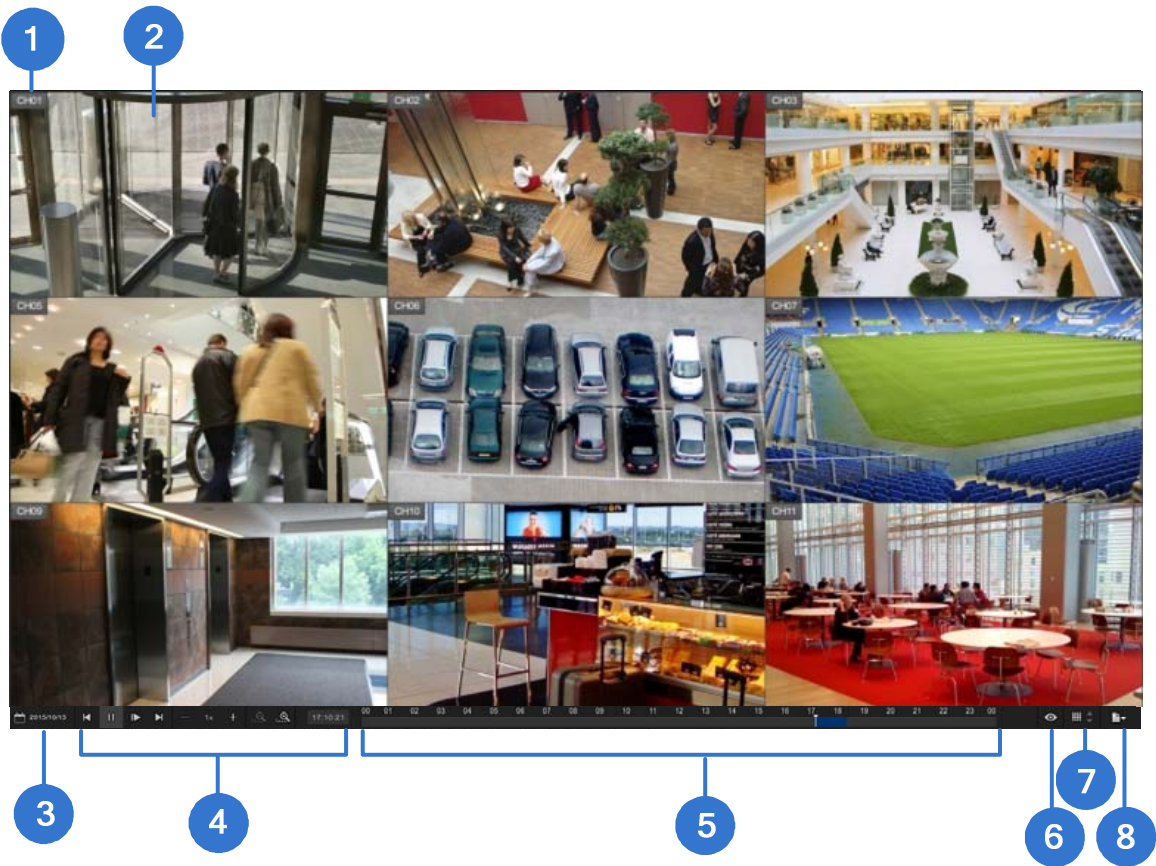

Figure 4-1

4 Video Playback

Use controls on the Playback Panel to view the event in the way you want. Move the Slider forward or backward to navigate through video frames.

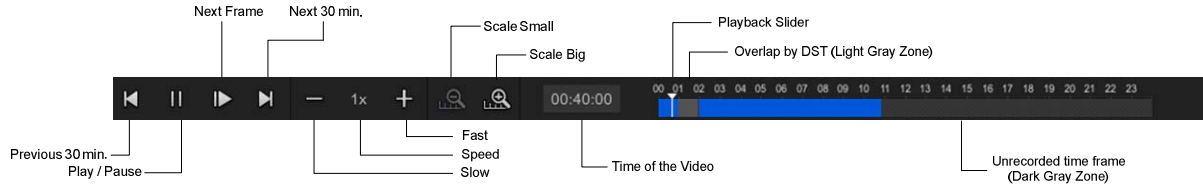



Figure 4-2

The controls in the timeline player screen:

No.	Name	Description
1	Camera Name	Indicates the camera name.
2	Camera View	Displays the playback video.
3	Date Display	Allows you to specify a date to play back the recorded video. The date with video recording is highlighted in blue.
4	Playback Panel	Contains typical playback control buttons.
5	Timeline	<p>The time with video recording is highlighted in blue.</p> <ul style="list-style-type: none"> For GV-SNVR0411 / 0412 / 0811 / 0812 / 1600 / 1611, <ol style="list-style-type: none"> With the Scale Big button  clicked, displays a 60-minute timeline consisting of 12 grids with each specifying five minutes. With the Scale Small button  clicked, displays a 24-hour timeline consisting of 24 grids with each specifying an hour. For GV-SNVR0400F, displays a 24-hour timeline consisting of 48 grids, with each specifying half an hour.
6	Live	Closes the timeline player and returns to live view window.
7	Division	Click to change the screen division, which varies among different GV-SNVR models.
8	Export	Exports the video recording as AVI files to a USB flash drive.

Note:

The light gray zone in between the blue recording zones, as indicated in *Figure 4-2*, is a one-hour overlap of 2 separate recordings caused by the Daylight Saving Time (DST). Note the following to distinguish the recordings.

- To play back the last hour of the recording with DST enabled, click the Next 30 min. button when the Playback Slider is placed before the gray zone.



- To play back the first hour of the recording with DST disabled, click the Previous 30 min. button when the Playback Slider is placed after the gray zone.



4.2 Recording Backup

Using the timeline player, you can back up recordings to the USB flash drive. To back up recordings, follow the steps below.

1. Connect a USB flash drive of FAT32 format to the USB port on the unit.
2. On the timeline player screen, click **Export** (No.8, Figure 4-1).

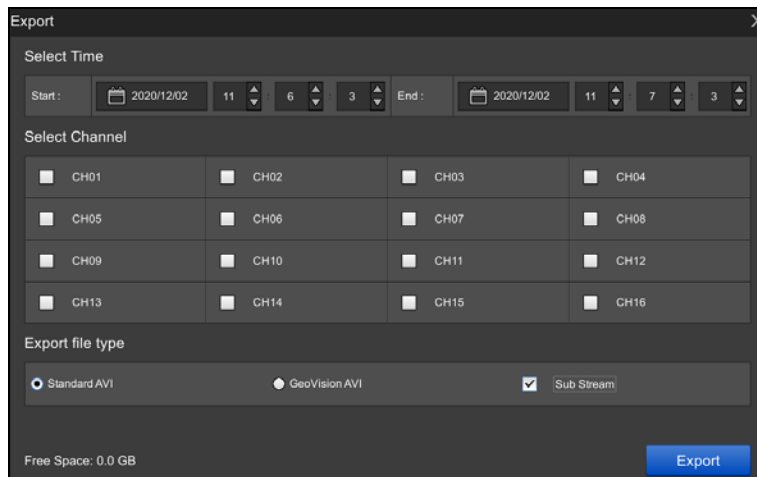

Figure 4-3

For GV-SNVR0411 / 0412 / 0811 / 0812 / 1611:

- Select **GeoVision AVI** to export video without audio.
- Select **Standard AVI** to export video with audio. Note the Standard AVI file is not supported by GeoVision applications.
- Only for GV-SNVR1611, select **Sub Stream** to export sub-stream recording if the host recorded in dual streams.

For GV-SNVR0400F / 1600, the backup recordings are in GeoVision AVI format.

3. Select the date and time period for the desired video recording.
4. Select the channel of desired camera and click **Export**.

For backup recordings in GeoVision AVI or Standard AVI format, you need to install GeoVision codec in the dedicated PC to play back the recordings using Windows Media Player. For GeoVision AVI format only, you can install the GV-ViewLog player for playback.

Note:

1. For GV-SNVR0400F / 1600, the recording backup only supports video. The audio will not be included in the backup recordings.
 2. If the GV-SNVR is connected with more than one USB flash drive, the video recordings will be backed up to the first USB flash drive connected.
-

Chapter 5 Remote Access to the GV-SNVR

Users can remotely access the GV-SNVR through the following methods:

- Web browser for **IE** users only
- SNVR Viewer
- GV-Eye mobile app
- GV-Edge Recording Manager
- GV-Control Center
- RTSP

For a comparison of functions provided by different remote accesses, see the [table](#).

Note:

1. For supported Web browsers and compatible GeoVision applications, see [1.4 Compatible Products and System Requirements](#) for details.
 2. The maximum number of remote network connection is **10** in total for GV-SNVR0411 / 0400F / 0412, **18** in total for GV-SNVR0811 / 0812, **34** in total for GV-SNVR1600 and **51** in total for GV-SNVR1611. Every connected channel will be counted as 1 connection.
 3. GV-Edge Recording Manager / GV-Control Center can remotely play back recordings stored on GV-SNVR. GV-SNVR1611 supports remote playback from **2** GV-Edge Recording Manager / GV-Control Center at a time, while GV-SNVR0411 / 0412 / 0811 / 0812 only supports **1** at a time.
 4. Up to 2 GV-Eye / Remote ViewLog / SNVR Viewer can be connected to a GV-SNVR at a time.
 5. For SNVR0412 V1.04 and SNVR0812 V1.09, or later versions, if you want to create an account through Web browser or SNVR Viewer, the password of the account must contain at least 6 characters and 4 character categories among the following: uppercase letters, lowercase letters, digits and special characters. While creating an account on the device, the password only requires 3 character categories.
-

5.1 Accessing through Web browser

To access the live view through Web interface, follow the steps below.

For Internet Explorer:

1. Open your Web browser and type the IP address of the GV-SNVR.

Note: To look up the IP address of GV-SNVR, see [3.3 Network](#). Alternatively, run the GV-IP Device Utility to search for your GV-SNVR. For details, see [6.2 Using the GV-IP Device Utility](#).

2. In both Username and Password fields, type the default value **admin**.

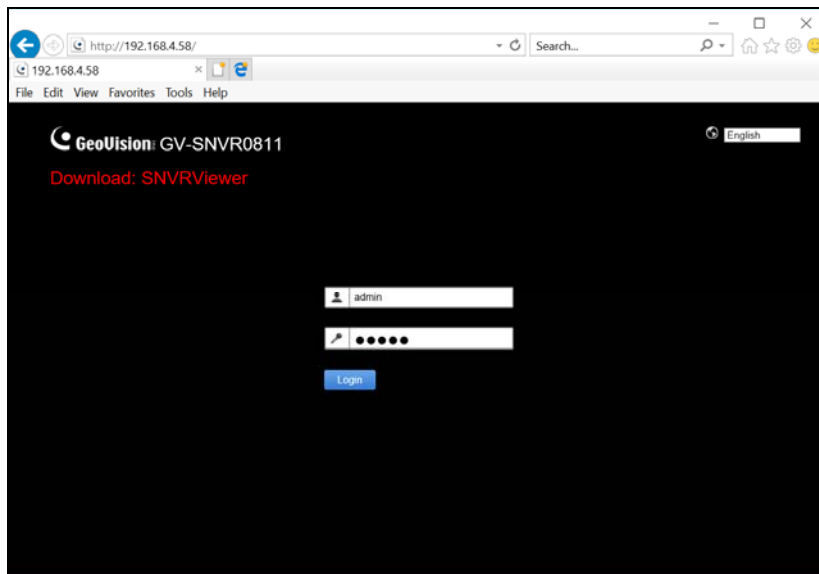

Figure 5-1

3. Select a desired language from the drop-down list at the upper-right corner of the Web interface and click **Login**.

Note: To enable the update of live view on your Web browser, you must set the Web browser to allow ActiveX controls and perform a one-time installation of GeoVision's ActiveX components on your computer.

For Mozilla Firefox, Google Chrome, Safari or Microsoft Edge:

Open your Web browser, type the IP address of the GV-SNVR and download **SNVR Viewer**. For detailed instructions, refer to [5.2 Accessing through SNVR Viewer](#).

5 Remote Access to the GV-SNVR

5.1.1 Live View Screen

After successfully logging in the Web interface, you can access the live view of connected IP cameras.

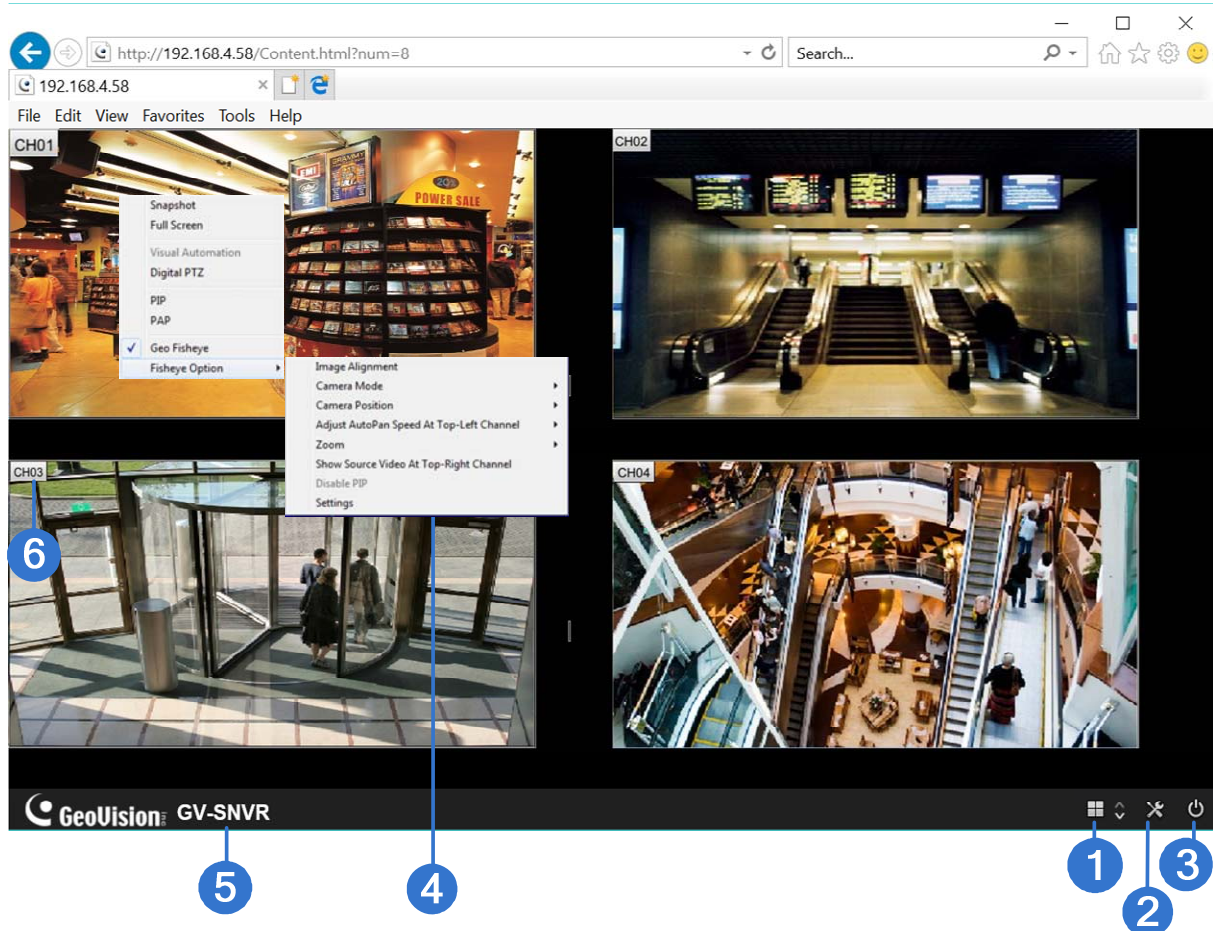

Figure 5-2

No.	Name	Description
1	Division & Page Up / Down	Select screen divisions and switch between cameras in single division.
2	Setting	Access the following system configuration pages of GV-SNVR: Camera, Record, Network, Storage, Service, Event, System, and Account. See <i>Chapter 3 System Configuration</i> for more information on these settings.

Note:

1. For SNVR0400F / 1600, the System Log is not accessible via the Web interface.
2. Configurations of camera settings through the Web interface is only supported by GV-SNVR0812 V1.05 or later, see 5.1.2 *Camera Settings via Web.*

No.	Name	Description
3	Exit	Log out the Web interface.
		<p>Right-click the live view of desired camera to access the functions below.</p> <p>Snapshot: Take a snapshot of live video. For details, see 5.1.2 Snapshot of Live Video.</p> <p>Full Screen: Switch the live view to full screen.</p> <p>Resolution: Display the resolution at the lower-right corner of the live view.</p>
4	Advanced Options	<p>Digital PTZ: Simulate the PTZ movement on the screen. For details, See 5.1.5 Digital PTZ Control.</p> <p>PIP: Enable the PIP function. For details, See 5.1.3 Picture-in-Picture View.</p> <p>PAP: Enable the PAP function. For details, See 5.1.4 Picture-and-Picture View.</p> <p>Geo Fisheye: Only for GV-SNVR0411 / 0412 / 0811 / 0812 / 1611, select to enable the fisheye settings. For details, See 5.1.6 Fisheye View.</p>
5	Device Name	Shows the device name of GV-SNVR. See Device Name in 3.8 System .
6	Camera Name	Click the camera name to capture snapshots or enable speaker.

Note:

1. The Web interface of GV-SNVR only connects to the main stream of GV-IP Cameras when using single division and 4-division display. For details, see [Appendix B Live View Streaming](#).
2. The Visual Automation function is not supported.

5 Remote Access to the GV-SNVR

5.1.2 Camera Settings via Web

For GV-SNVR0812 V1.05 or later only, to configure the settings of cameras connected to GV-SNVR via its Web interface and/or GV-SNVR Viewer, click the **Setting** button (No. 2, Figure 5-2) on the live view screen, select **Camera** and click the **Edit** button  next to the desired camera. The following dialog box appears.

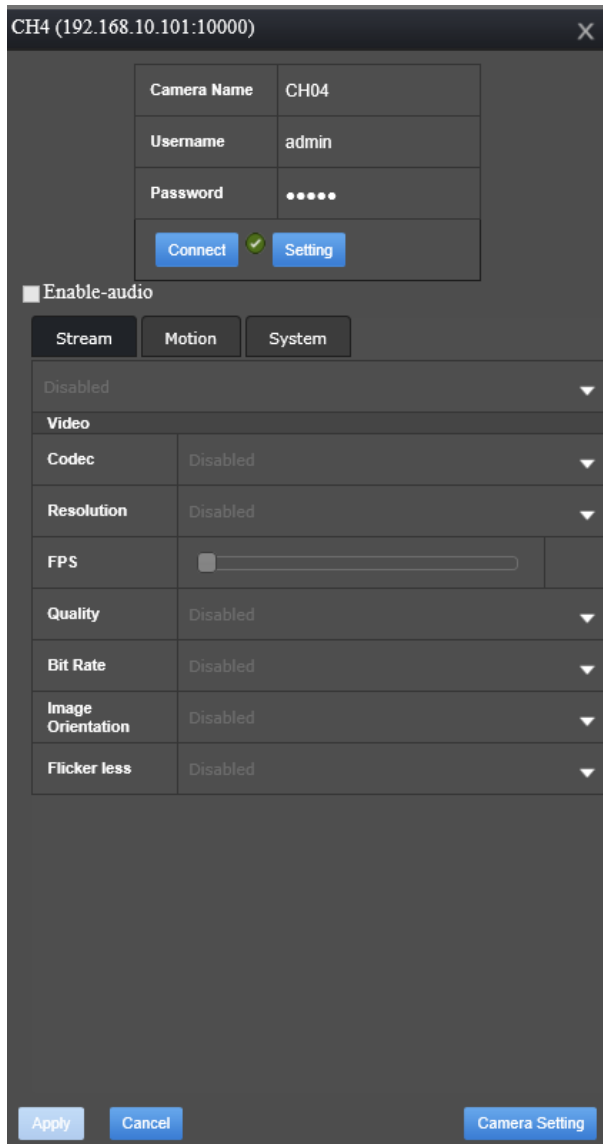



Figure 5-3

As illustrated, all settings are first grayed out upon access. To configure camera settings, which are detailed in 3.1.1 *GV-IP Camera Settings* and 3.1.2 *Third-Party IP Camera Settings (ONVIF)*, click the **Setting** button .

Note: The **Camera Setting** button at the bottom-right corner is currently nonfunctional.

5.1.3 Snapshot of Live Video

To take a snapshot of live video, follow the steps below.

1. Right click on the live view of desired camera and select **Snapshot**. This dialog box appears.

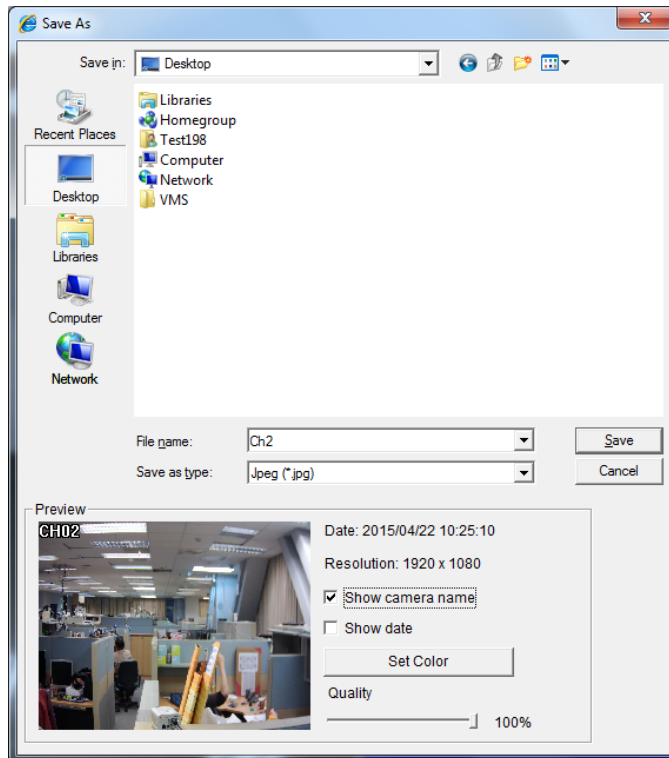

Figure 5-4

2. Select a desired saving path, type the file name and select an image format from **JPEG** or **BMP** under Save as Type.
3. In the Preview field, you can choose whether to tag the snapshot with camera name, time and date, select **Set Color** for the text color and adjust the image quality.
4. Click **Save** to save the captured image.

5.1.4 Picture-in-Picture View

With the Picture in Picture (PIP) view, you can crop the video to get a close-up view or zoom in on the video. This function is useful for detailed images of the surveillance area.

1. Right click on the live view of a desired camera and select **PIP**. An inset window of the camera view appears in the bottom right corner.



Figure 5-5

2. Double-click the inset window. A hand icon appears.
3. Click the inset window. A navigation box appears.



Figure 5-6

4. Move the navigation box around in the inset window to have a close-up view of the selected area.
5. To adjust the navigation box size, move the cursor to any of the box corners to enlarge or diminish the box.
6. To change the frame color of the navigation box, right click the image, select **Mega Pixel Setting** and then **Set Color of Focus Area**.
7. To hide the navigation box on the image, right click the image, select **Mega Pixel Setting** and click **Hide Focus Area of PIP Mode**
8. To exit the PIP view, right click the camera view and click **PIP** again.

5.1.5 Picture-and-Picture View

With the Picture and Picture (PAP) view, you can create a split video effect with multiple close-up views on the image. Up to 7 close-up views can be defined for clear and detailed images of the surveillance area.

1. Right click on the live view of a desired camera and select **PAP**. A row of three inset windows appears on the bottom of the live view image.



Figure 5-7

2. Draw a navigation box by clicking and dragging on the image. This selected area is immediately displayed in one of the inset windows. Up to seven navigation boxes can be drawn on a live view image.
3. To adjust the size of a navigation box, move the cursor to any of the box corners to enlarge or diminish the box.
4. To move a navigation box to another area on the image, drag it to that area.
5. To change the frame color of the navigation box, right click the image, select **Mega Pixel Setting** and click **Set Color of Focus Area**.
6. To hide the navigation box on the image, right click the image, select **Mega Pixel Setting** and click **Display Focus Area of PAP Mode**.
7. To delete a navigation box, right click the desired box, select **Focus Area of PAP Mode** and select **Delete**.
8. To exit the PAP view, right click the live view and select **PAP** again.
9. To add another navigation box when less than seven navigation boxes are drawn, right click the camera view, select **Mega Pixel Setting** and **Enable Add-Focus-Area-Mode**.

5.1.6 Digital PTZ Control

In non-PTZ cameras, the Digital PTZ (DPTZ) function allows you to simulate the PTZ movement on the screen. This function is also supported in PT / PTZ cameras.

Note: The Digital PTZ function is not supported in the 16-division and 9-division display on GV-SNVR1600.

1. Right click the live view of a desired camera and select **Digital PTZ**. The DPTZ control panel appears at the lower-right corner of the camera view.

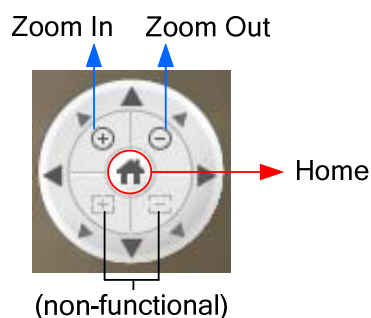

Figure 5-8

2. To zoom in or zoom out, click the corresponding buttons or use the mouse scroll. To bring the digital PTZ view back to its default image, click **Home**.
3. To pan and tilt the digital PTZ view, zoom in on the image first, and click and hold one of the eight directional arrows.
4. To adjust the transparency level of the DPTZ control panel, right click the camera view, find **Digital PTZ** and select **Transparency**. Ten levels range from 10% (fully transparent) to 100% (fully opaque).
5. To close the DPTZ control panel, right click the camera view and select **Exit**.

5.1.7 Fisheye View

Only for GV-SNVR0411 / 0412 / 0811 / 0812 / 1611 that connects to GeoVision IP Fisheye cameras. A fisheye camera allows you to cover all angles of a location with just one camera. Using different fisheye view modes, the distorted hemispherical image produced by the fisheye camera can be converted to a conventional rectilinear projection.

To enable fisheye options, right click the live view of a desired fisheye camera and select **Geo Fisheye**. Right click the image again and select **Fisheye Option** to see the following options.

- **Image Alignment:** By default, the image should be properly aligned already. If not, follow the steps below to align the image for each model:
 - **GV-FE3402 / 3403 / 5302 / 5303 and GV-FER3402 / 3403 / 5302 / 5303 / 5700 / 12203:** Align the red circle with the outer edge of the camera image, and then align it with the inner edge of the image frame to achieve optimal results.



Figure 5-9

- **GV-FE2301 / 4301:** Align the red circle with the edge of the camera image. You can eliminate the darker areas toward the edge of the image by making the red circle smaller, but the field of view will be slightly reduced.



Figure 5-10 Once the image of GV-FE2301 / 4301 is aligned, all four edges of the image will be cropped slightly.

5 Remote Access to the GV-SNVR

■ Camera Modes: You can choose among four view modes.

- **Quad view:** Composed of four PTZ views.
- **360 degree:** Composed of two PTZ view and one 360° panoramic view.
- **Dual 180 degree:** Composed of two 180° views.
- **Single view:** Composed of one PTZ view.



Quad view: four PTZ views



360 degree: two PTZ views & one 360° view

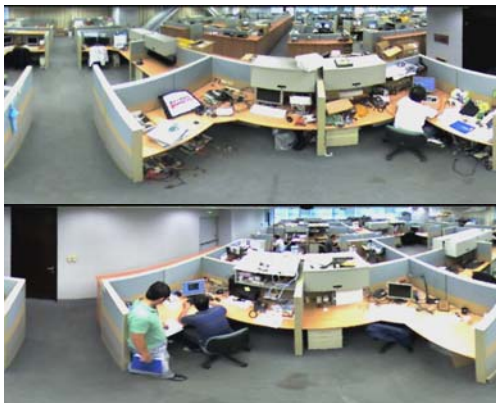

Dual 180 degree: two 180° views

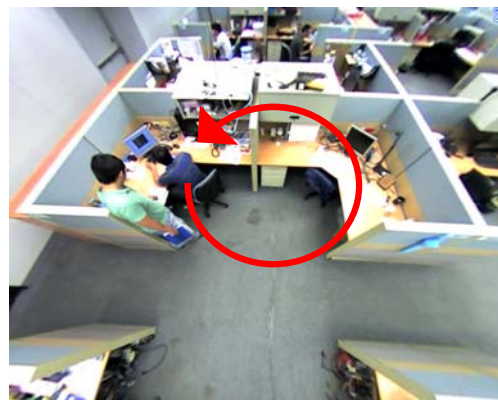

Single view: one PTZ view

Figure 5-11

Note:

1. Fisheye Dewarping is not supported when the channel resolution is configured to 4K.
 2. Only one fisheye camera can be dewarped by the GV-SNVR at a time.
-

- **Camera Position:** Select **Ceiling**, **Wall** or **Ground** according to where the camera is mounted.
- **Adjust AutoPan Speed At Top-Left Channel:** Select low, medium, or high speed to enable Auto Pan for one PTZ view at the rotation speed of your choice. This option applies to **Quad view**, **360° degree** and **Single view**.
- **Zoom:** Select **Zoom In** or **Zoom Out** and then click on the image.
- **Show Source Video at Top-Right Channel:** Shows the circular source image in the top-right quadrant when **Quad view** is selected.
- **Settings:** The following settings are available.
 - **Wide View:** Increase the height of the 180 degree view when camera position is set to wall mount.
 - **Frame Rate Control:** You can set the frame rate of the live view image.

Note: When **Camera Position** is selected as wall mount, only one 180° view will be displayed.

5.2 Accessing through SNVR Viewer

Note SNVR Viewer only supports **GV-SNVR0411 / 0412 / 0811 / 0812 / 1600 / 1611**.

Through SNVR Viewer, you can connect to GV-SNVR to access live view, play back recordings, export image and configure the settings of the GV-SNVR on your PC.

1. Open your Web browser and type the IP address of the GV-SNVR.

Note: To look up the IP address of GV-SNVR, see [3.3 Network](#). Alternatively, run the [GV-IP Device Utility](#) to search for your GV-SNVR. For details, see [6.2 Using the GV-IP Device Utility](#).

2. Click **Download SNVR Viewer** at the upper-left of the webpage to download and install SNVR Viewer.

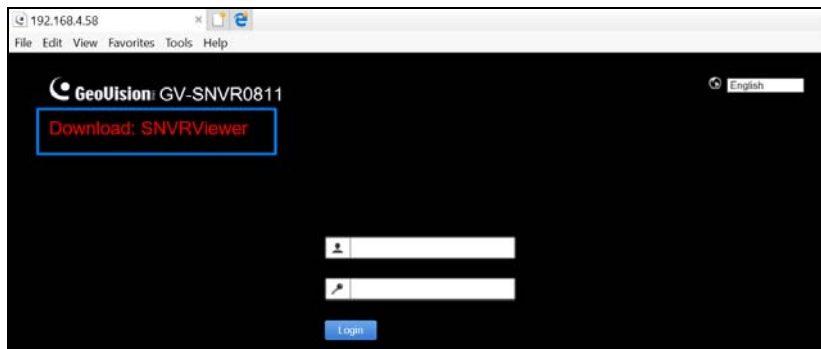

Figure 5-12

3. Once installed, open **SNVR Viewer**. Type the IP address of GV-SNVR and modify the Port value if needed. Click **Connect**. Then modify the Account and Password of GV-SNVR if needed and click **Login**. The default value for both is **admin**.

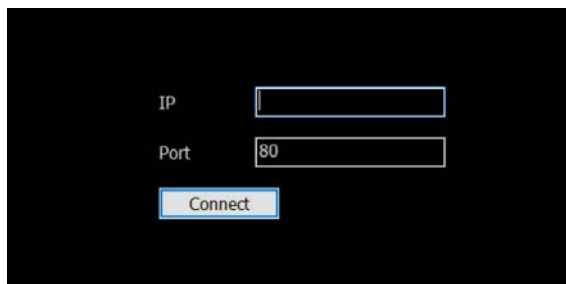

Figure 5-13

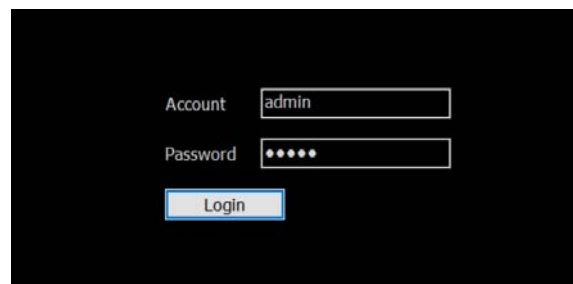

Figure 5-14

Note: Up to two SNVR Viewers can access the same GV-SNVR at a time.

5.2.1 Live View through SNVR Viewer

After successfully logging in SNVR Viewer, you can access the live view of IP cameras connected to the GV-SNVR.

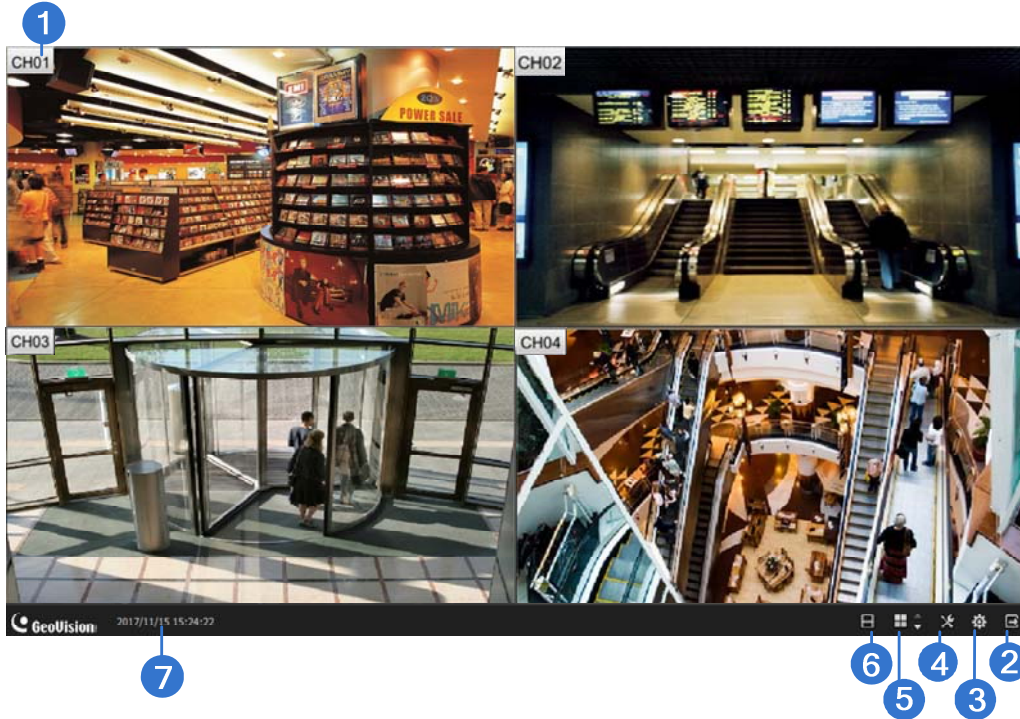

Figure 5-15

No.	Name	Description
1	Camera Name	Click the camera name to capture snapshots, play back videos or enable speaker.
2	Logout	Logs out of the GV-SNVR.
3	System	Brings up the following information / options: <ul style="list-style-type: none"> The software version of the SNVR Viewer The Snapshot Path in which to save captured snapshots. The Export Path in which to save exported data.
4	Setting	Accesses the following setting pages: <ul style="list-style-type: none"> Camera (see 5.1.2 Camera Settings via Web) Record (see 3.2 Record) Network (see 3.3 Network) Storage (see 2.4 Formatting Hard Drive) Service (see 3.6 Service) Event (see 3.7 Event for GV-SNVR0412 / 0812 / 1611 only) System (see 3.8 System) Account (see 3.9 Account)

5 Remote Access to the GV-SNVR

No.	Name	Description
5	Division & Page Up / Down	Selects screen divisions and switch between cameras in single division.
6	Playback	Displays the playback panel.
7	Date / Time	Displays the current date and time.

Note:

1. The SNVR Viewer only connects to the main stream of GV-IP Cameras when using single division display. For details, see *Appendix B Live View Streaming*.
 2. Configurations of camera settings through GV-SNVR Viewer is only supported by GV-SNVR0812 V1.05 or later, see *5.1.2 Camera Settings via Web*.
 3. The Visual Automation and Fisheye Dewarping functions are not supported.
-

5.2.2 Playback through SNVR Viewer

Using SNVR Viewer, you can view videos recorded by the GV-SNVR by clicking the **Playback** button (No. 6, Figure 5-15). To play the recordings, select a time and click the **Play** button on the Playback Panel. To switch the current view mode, click the **Division** button.

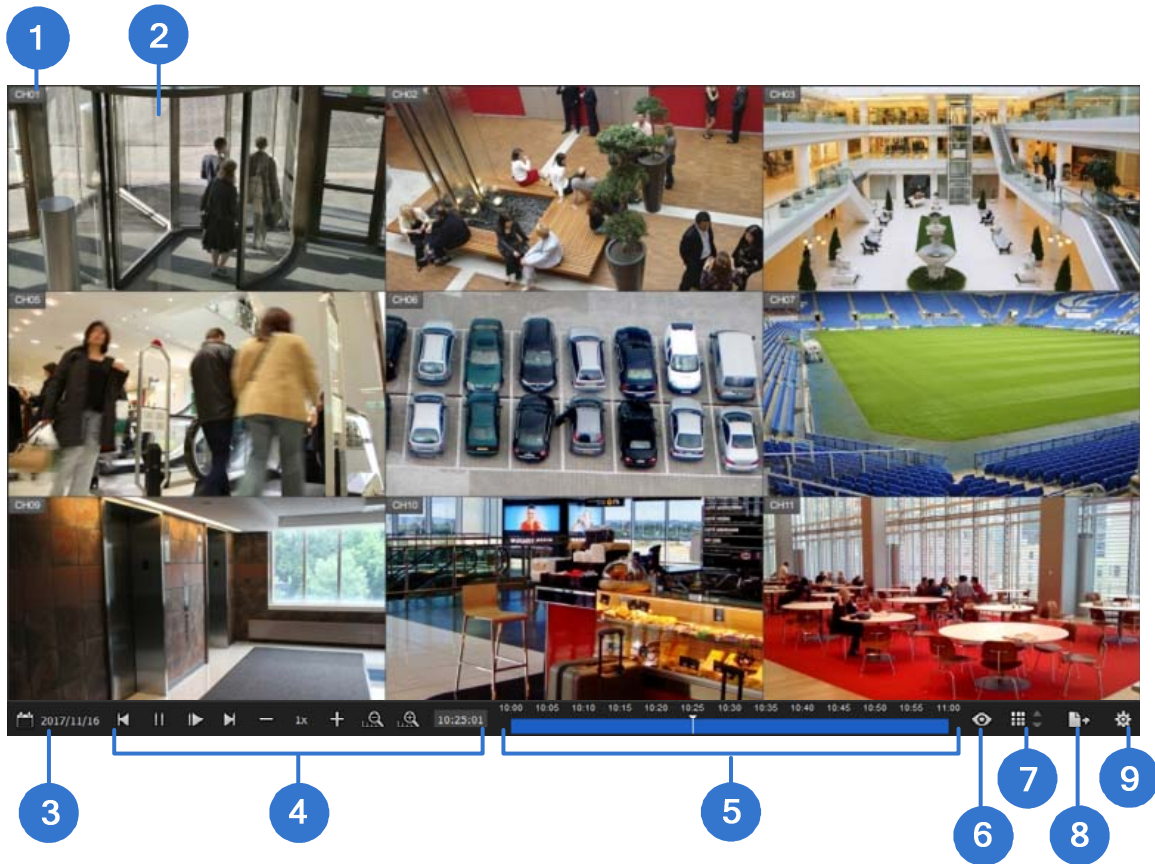

Figure 5-16

Use controls on the Playback Panel to view the event in the way you want. Move the Slider forward or backward to navigate through video frames.

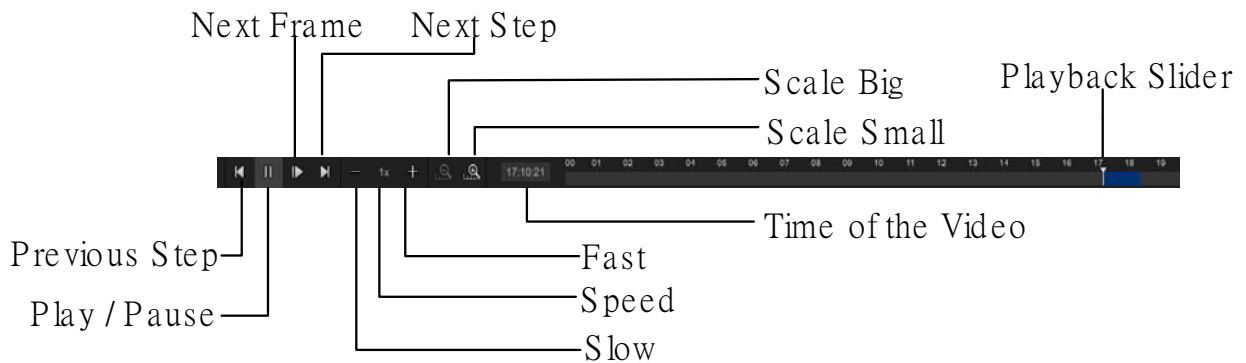



Figure 5-17

5 Remote Access to the GV-SNVR

The controls in the timeline player of SNVR Viewer:

No.	Name	Description
1	Camera Name	Indicates the camera name.
2	Camera View	Displays the playback video.
3	Date Display	Allows you to specify a date to play back the recorded video. The date with video recording is highlighted in blue.
4	Playback Panel	Contains typical playback control buttons. The time with video recording is highlighted in blue.
5	Timeline	<ul style="list-style-type: none">• With the Scale Big button  clicked, displays a 60-minute timeline consisting of 12 grids with each specifying five minutes.• With the Scale Small button  clicked, displays a 24-hour timeline consisting of 24 grids with each specifying an hour.
6	Live View	Closes the timeline player and returns to live view.
7	Division	Click to change the screen division, which varies among different GV-SNVR models.
8	Export	Exports the video recording as AVI files to a USB flash drive. Brings up the following options:
9	System	<ul style="list-style-type: none">• The Snapshot Path in which to save captured snapshots.• The Export Path in which to save exported data.

5.2.3 Snapshot & Video Export through SNVR Viewer

Through SNVR Viewer, you can capture snapshots and export recordings from the GV-SNVR to your local computer. To capture snapshots or export recordings, follow the steps below.

Snapshot:

1. Click the **System** button in live view or playback mode (respectively No. 3, Figure 5-15 and No. 9 Figure 5-16) to change the Snapshot Path in which to save captured snapshots.
2. Under live view or playback mode, click the camera name of a desired camera and select **Snapshot**. The captured snapshot is saved to the specified directory.

Video Export:

1. Click the **Export** button the Playback Panel (No. 8, Figure 5-15).

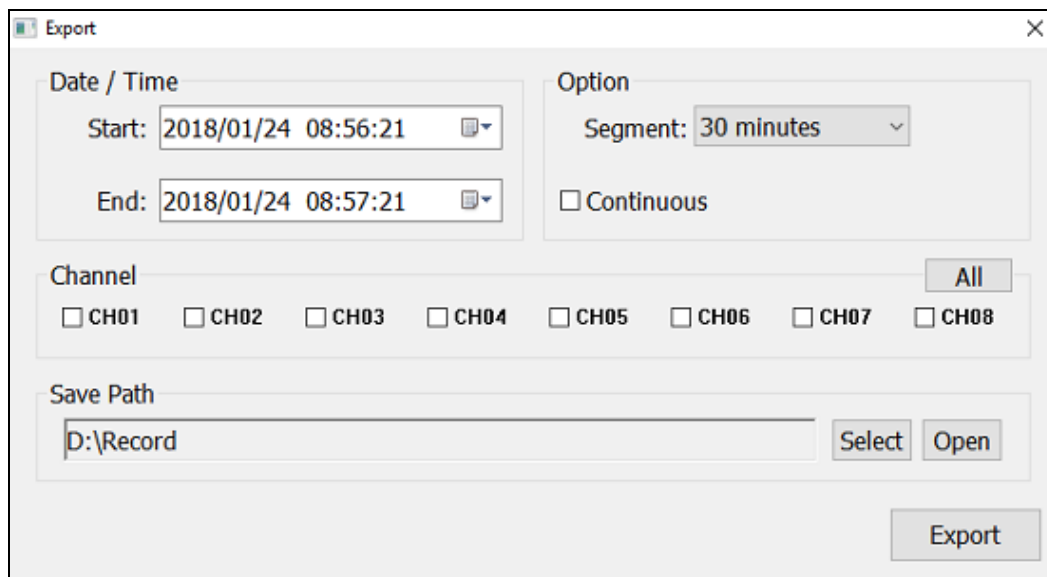

Figure 5-18

2. Select the date and time period for the desired video recording.
3. Under **Option**, select the desired length / size of each individual video file between **10**, **20**, **30 minutes** or **2 GBs** in the **Segment** drop-down list. Alternatively, select **Continuous** to export the recordings as one video clip.
4. Select the **Channel(s)** of the desired camera, or click **All** for all channels, and specify the **Save Path** in which to save the exported recordings.
5. Click **Export**.

5.3 Accessing through Mobile Device

To access the live view of GV-SNVR through iOS or Android devices, you must install GV-Eye app on your mobile device. With GV-Eye, you can watch multiple live views in dual streams, use Picture in Picture (PIP) function and take snapshots from your mobile device. For details, see [GV-Eye Installation Guide](#).

Note: Audio function is only supported when IP devices are connected through stream 1.

5.4 Accessing through GV-Edge Recording Manager

You can connect to GV-SNVR from GV-Edge Recording Manager to access live view and play back recordings. For details, refer to *GV-Edge Recording Manager User's Manual*.

Note:

1. For the versions of GV-Edge Recording Manager compatible with your GV-SNVR, see [1.4.2 Supported GeoVision Applications](#).
 2. Audio function of live view is only supported in Single Live View Window, and the IP device must be connected through stream 1.
-

5.5 Accessing through GV-Control Center

You can connect to GV-SNVR from GV-Control Center to access live view and play back recordings. For details, refer to *GV-Control Center User's Manual*.

Note:

1. For the versions of GV-Control Center compatible with your GV-SNVR, see [1.4.2 Supported GeoVision Applications](#).
 2. Audio function of live view is only supported in Single Live View Window and Matrix View, and the IP device must be connected through stream 1.
-

5.6 Accessing through RTSP

Note this section is only applicable to SNVR0411 / 0412 / 0811 / 0812 / 1611.

You can access the live view of the GV-SNVR through RTSP protocol using the following address:

- `rtsp://snvr_ipaddress:554/ch1 ~ 8` for GV-SNVR0411 / 0412. 1 ~ 4 and 5 ~ 8 are respectively the main streams and sub streams of camera channels 1 ~ 4.
- `rtsp://snvr_ipaddress:554/ch1 ~ 16` for GV-SNVR0811 / 0812. 1 ~ 8 and 9 ~ 16 are respectively the main streams and sub streams of camera channels 1 ~ 8.
- `rtsp://snvr_ipaddress:554/ch1 ~ 32` for GV-SNVR1611. 1 ~ 16 and 16 ~ 32 are respectively the main streams and sub streams of camera channels 1 ~ 16.

Note: Through RTSP, a GV-SNVR0411 / 0811 can be connected by a maximum **20** hosts at a time, a GV-SNVR0412 / 0812 can be connected by a maximum of **10** hosts at a time, and a GV-SNVR1611 can be connected by a maximum of **50** hosts at a time.

Chapter 6 Advanced Applications

6.1 Upgrading System Firmware

GeoVision periodically release the updated firmware on the Website. You can upgrade the firmware using a USB flash drive of FAT32 format.

To upgrade the firmware, follow the steps below.

1. Download the firmware file to a USB flash drive.
2. Connect the USB drive to the GV-SNVR.
3. On the main screen, click the **Setting** button  and select **System**.
4. Click the **Advanced Option** button and select **Firmware Upgrade**.
5. Find the firmware file and click **Apply**. The system starts upgrading firmware and automatically reboots after completing the process.

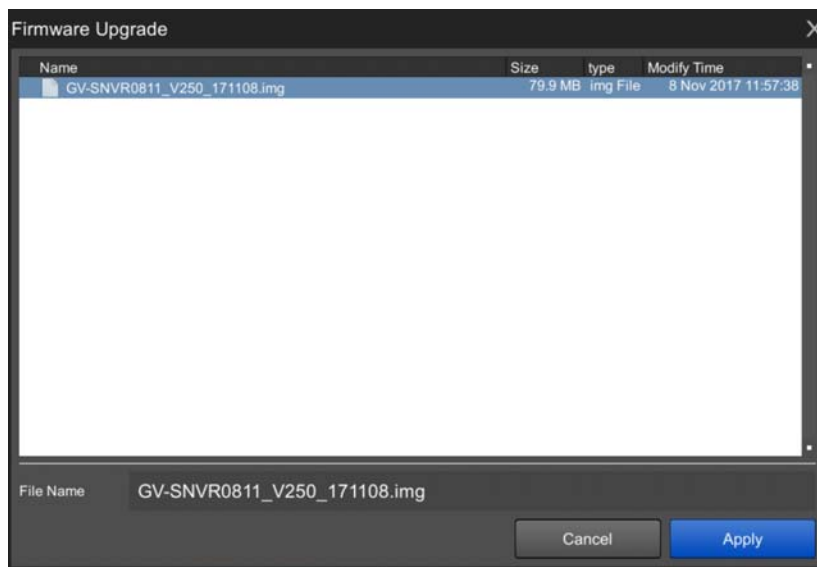

Figure 6-1

After the system reboot, the main screen will be displayed automatically.

Note: Alternatively, you can use the GV-IP Device Utility to upgrade system firmware, especially for multiple GV-SNVR. For details, see the *Upgrading System Firmware* section in *6.2 Using the GV-IP Device Utility*.

6.1.1 Safe Mode of GV-SNVR1611

In the event of a firmware update failure, such as an accidental power outage while updating, the GV-SNVR automatically switches to Safe Mode upon startup.

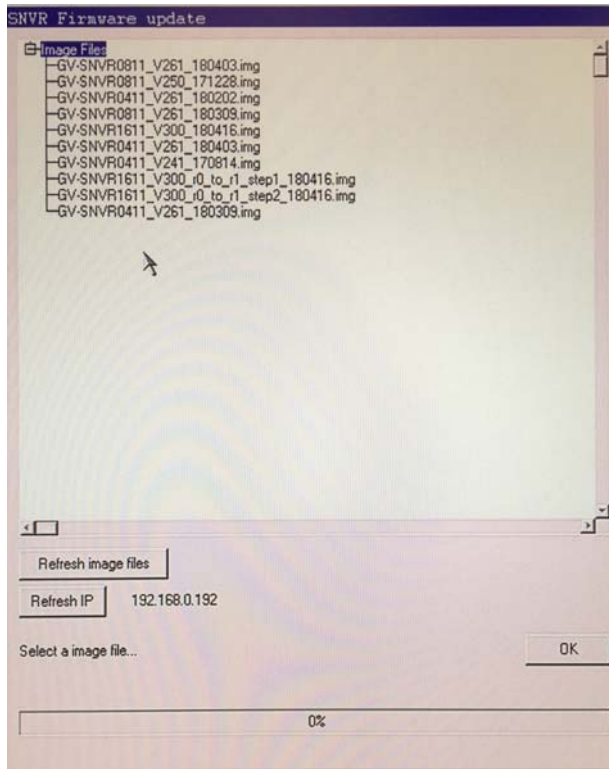

Figure 6-2

Select the firmware file of the GV-SNVR and click **OK**.

6.2 Using the GV-IP Device Utility

The GV-IP Device Utility detects all the GV-IP Devices in the LAN and allows you to quickly set up the IP address of the device, upgrade firmware and export/import device settings.

6.2.1 Looking Up the IP Address

You can use the GV-IP Device Utility to look up the IP address of your GV-SNVR and GV-IP Camera.

1. Install the GV-IP Device Utility from the [download page](#).
2. Double-click the GV-IP Device Utility icon created on your desktop. This window appears and IP devices under the LAN are automatically detected.

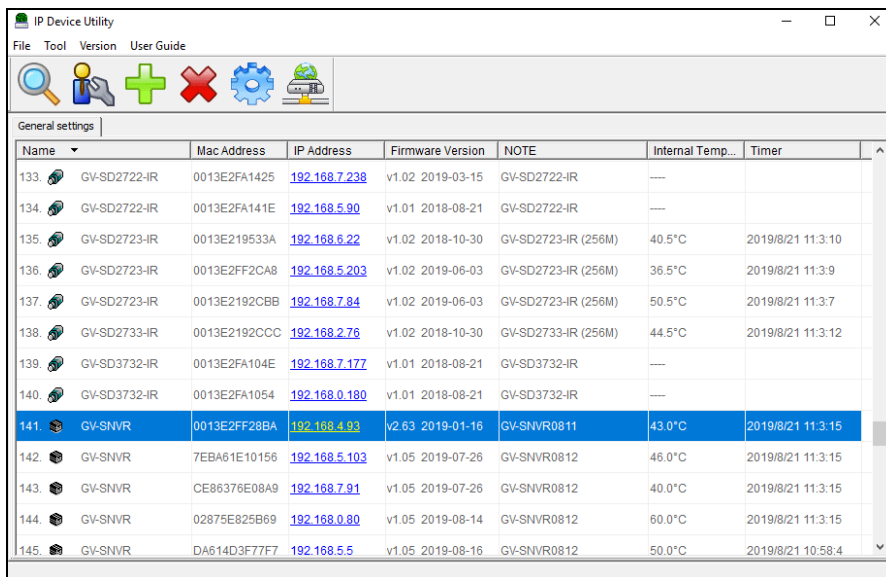

The screenshot shows the 'IP Device Utility' application window. The window title is 'IP Device Utility' and it has a menu bar with 'File', 'Tool', 'Version', and 'User Guide'. Below the menu bar is a toolbar with icons for search, help, add, delete, settings, and refresh. The main area is titled 'General settings' and contains a table of detected devices. The table has columns for Name, Mac Address, IP Address, Firmware Version, NOTE, Internal Temp..., and Timer. The device at row 141 is highlighted in blue.

Name	Mac Address	IP Address	Firmware Version	NOTE	Internal Temp...	Timer
133. GV-SD2722-IR	0013E2FA1425	192.168.7.238	v1.02 2019-03-15	GV-SD2722-IR	---	
134. GV-SD2722-IR	0013E2FA141E	192.168.5.90	v1.01 2018-08-21	GV-SD2722-IR	---	
135. GV-SD2723-IR	0013E219533A	192.168.6.22	v1.02 2018-10-30	GV-SD2723-IR (256M)	40.5°C	2019/8/21 11:3:10
136. GV-SD2723-IR	0013E2FF2CA8	192.168.5.203	v1.02 2019-06-03	GV-SD2723-IR (256M)	36.5°C	2019/8/21 11:3:9
137. GV-SD2723-IR	0013E2192CBB	192.168.7.84	v1.02 2019-06-03	GV-SD2723-IR (256M)	50.5°C	2019/8/21 11:3:7
138. GV-SD2733-IR	0013E2192CCC	192.168.2.76	v1.02 2018-10-30	GV-SD2733-IR (256M)	44.5°C	2019/8/21 11:3:12
139. GV-SD3732-IR	0013E2FA104E	192.168.7.177	v1.01 2018-08-21	GV-SD3732-IR	---	
140. GV-SD3732-IR	0013E2FA1054	192.168.0.180	v1.01 2018-08-21	GV-SD3732-IR	---	
141. GV-SNVR	0013E2FF28BA	192.168.4.93	v2.63 2019-01-16	GV-SNVR0811	43.0°C	2019/8/21 11:3:15
142. GV-SNVR	7EBA61E10156	192.168.5.103	v1.05 2019-07-26	GV-SNVR0812	46.0°C	2019/8/21 11:3:15
143. GV-SNVR	CE86376E08A9	192.168.7.91	v1.05 2019-07-26	GV-SNVR0812	40.0°C	2019/8/21 11:3:15
144. GV-SNVR	02875E825B69	192.168.0.80	v1.05 2019-08-14	GV-SNVR0812	60.0°C	2019/8/21 11:3:15
145. GV-SNVR	DA614D3F77F7	192.168.5.5	v1.05 2019-08-16	GV-SNVR0812	50.0°C	2019/8/21 10:58:4

Figure 6-3

3. Double-click the IP device and select **Web Page** to access its Web interface.

6.2.2 Accessing the Live View

You can use the GV-IP Device Utility for quick access to the live view of IP cameras connected with SNVR.

1. Double-click the GV-SNVR in the list and select **Live View**.
2. Select a camera and type the username and password of the camera to access the live view.

6.2.3 Upgrading System Firmware

You can also use the GV-IP Device Utility to upgrade firmware of multiple GV-SNVR at a time. Note the computer used to upgrade firmware must be under the same LAN as the GV-SNVR.

1. Double-click the GV-SNVR in the list and select **Configure**. This dialog box appears.

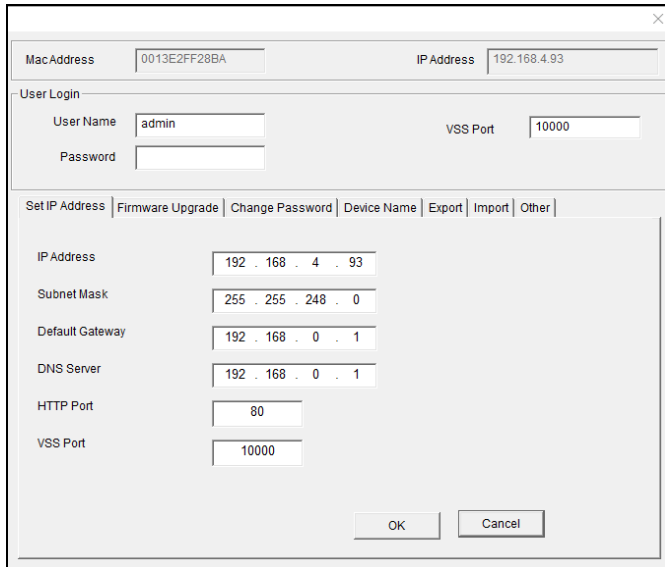

Figure 6-4

2. Click the **Firmware Upgrade** tab. This page appears.

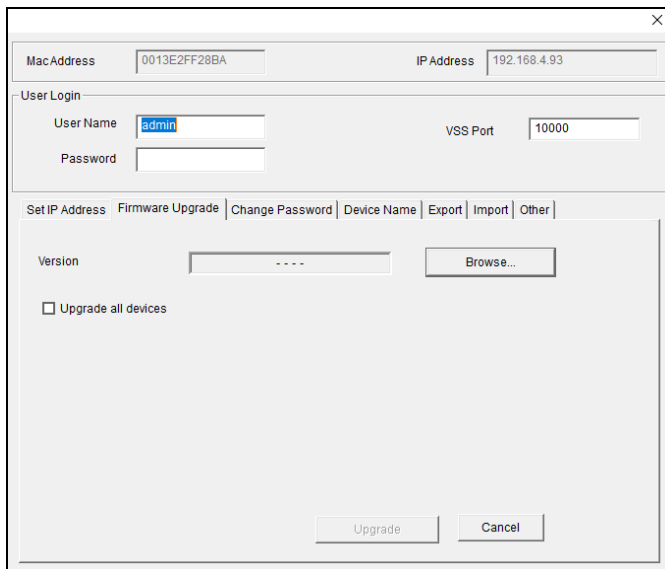

Figure 6-5

3. Click the **Browse** button to locate the firmware file (.img) saved at your local computer.
4. To upgrade all the GV-SNVR in the list, select **Upgrade all devices**.
5. Type **Password**, and click **Upgrade** to start the upgrade.

6.2.4 Backing Up and Restoring Settings

With the GV-IP Device Utility, you can back up the configurations of the GV-SNVR and restore the backup data to the current GV-SNVR or import it to another one.

To back up the settings:

1. Run GV-IP Device Utility and locate the desired GV-SNVR.
2. Double-click the GV-SNVR in the list and select **Configure**.
3. Click the **Export** tab. This window appears.

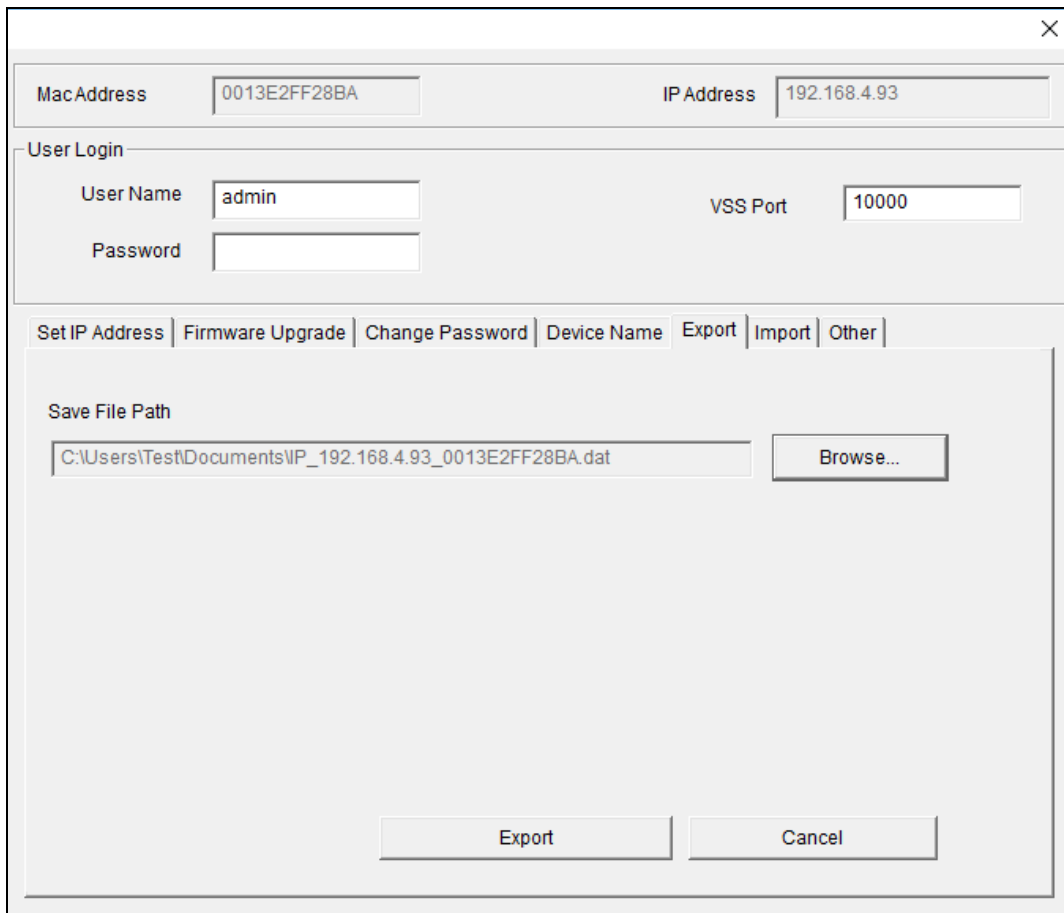

Figure 6-6

4. Click the **Browse** button to assign a file path.
5. Type the **Password** of the GV-SNVR, and click the **Export** button to save the backup file.

To restore the settings:

1. In Figure 6-5, click the **Import** tab. This dialog box appears.

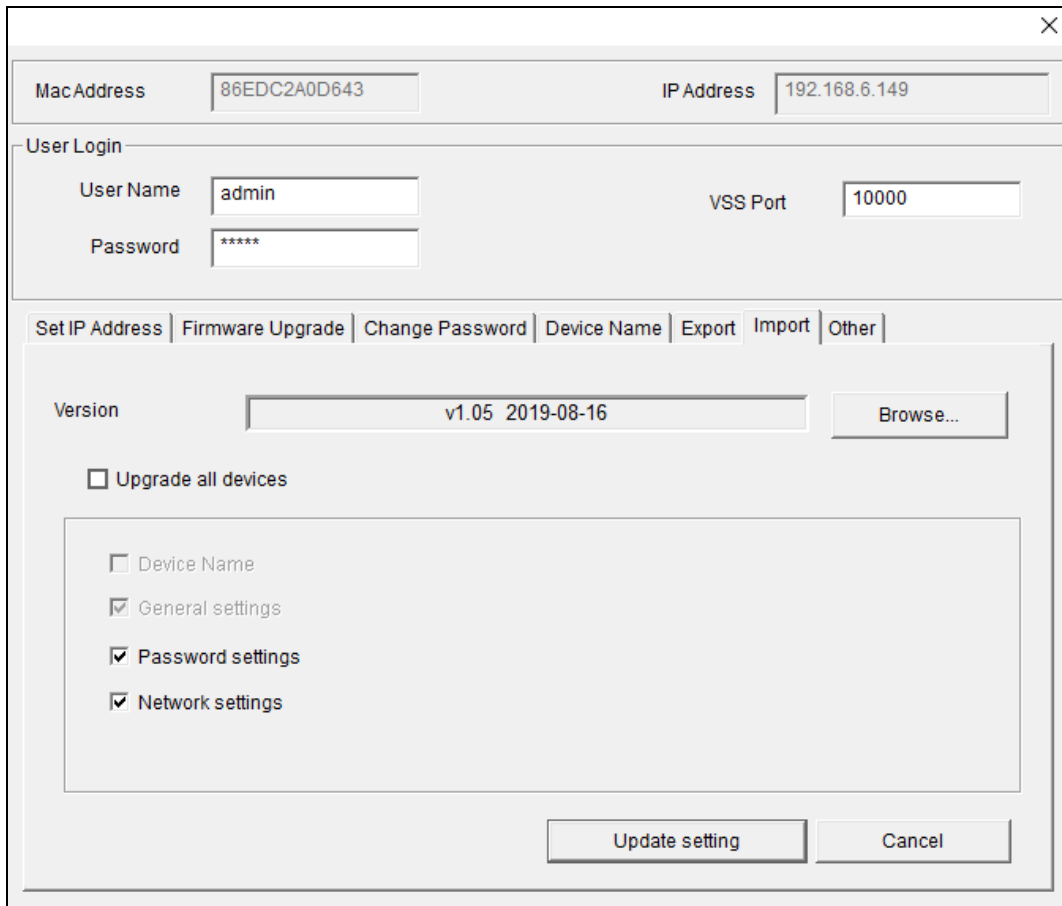

Figure 6-7

2. Click the **Browse** button to locate the backup file (.dat).
3. Select **Upgrade all devices** to import the settings into all GV-SNVR under the same LAN. To import password settings and/or network settings, select **Password Settings** and/or **Network settings**.
4. Click the **Update Settings** button to start restoring.

6.2.5 Restoring to Factory Default Settings

With the GV-IP Device Utility, you can also restore all configurations of your GV-SNVR back to its default settings.

1. In Figure 6-5, click the **Other** tab. This dialog box appears.

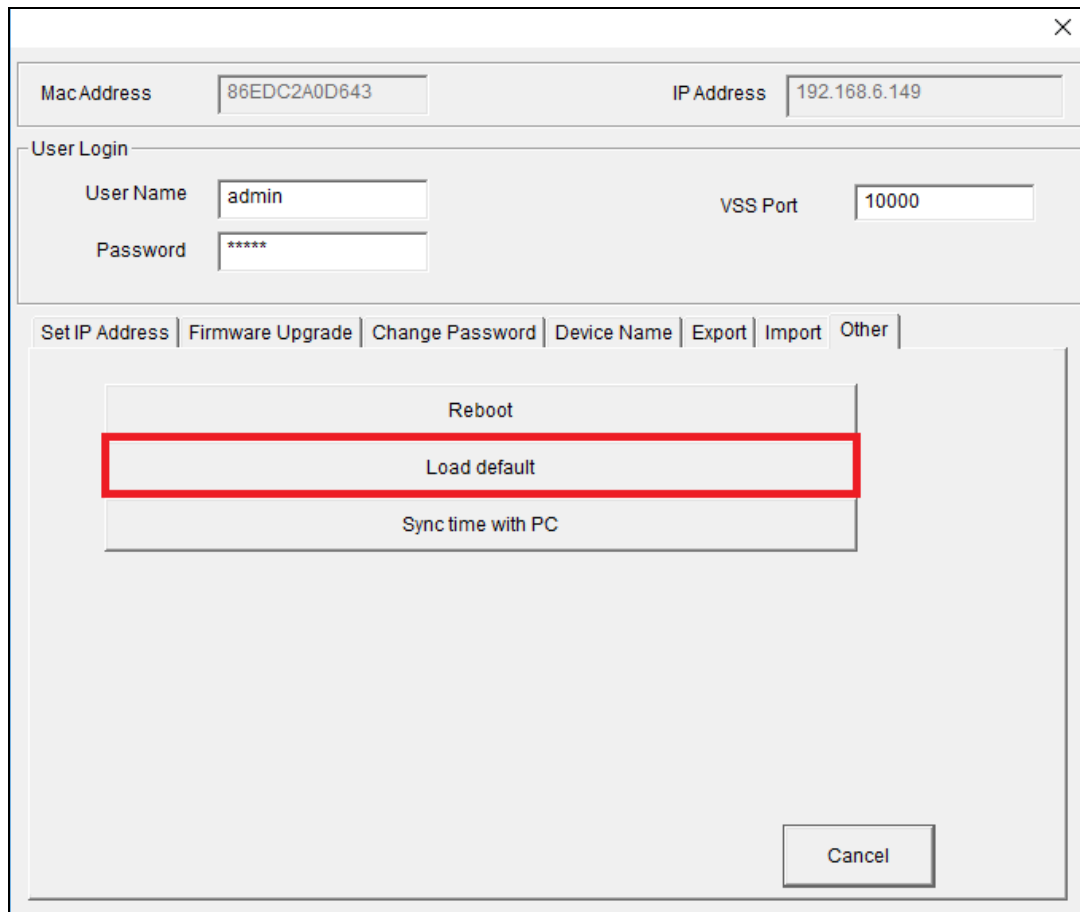

Figure 6-8

2. Click the **Load default** button to restore the GV-SNVR back to its factory default settings.

Appendix

A. Tested and Supported Hard Disk Drives

For system efficiency, it is recommended to use the enterprise-level hard disk drives instead of desktop-level or green HDD. The HDD listed below are tested by GeoVision.

Model	Capacity
WD	
WD101PURZ	10 TB
WD82PURZ	8 TB
WD4000F9YZ	4 TB
WD4000FYYZ	4 TB
WD4001FAEX	4 TB
WD40EFRX	4 TB
WD3000F9YZ	3 TB
WD3000FYYZ	3 TB
WD30EFRX	3 TB
WD30EURS	3 TB
WD30EURX	3 TB
WD2000F9YZ	2 TB
WD2000FYYZ	2 TB
WD20EURS	2 TB
WD20EZR	2 TB
WD1003FBYZ	1 TB
WD1005FBYZ	1 TB
WD10EURX	1 TB
WD10PURZ	1 TB
WD Ultrastar series	
HUH721010ALE604	10 TB
HUS728T8TALE6L4	8 TB
HUS726T6TALE6L4	6 TB
HUS726T4TALE6L4	4 TB
HUS722T2TALA604	2 TB
HUS722T1TALA604	1 TB

Appendix

Model	Capacity
Seagate	
ST8000VE000	8 TB
ST8000VX0002	8 TB
ST8000VX004	8 TB
ST4000NC000	4 TB
ST4000NM0033	4 TB
ST4000VX005	4 TB
ST4000VX013	4 TB
ST3000NM0033	3 TB
ST3000VX000	3 TB
ST2000NC000	2 TB
ST2000VX000	2 TB
ST1000DM003	1 TB
ST1000VX000	1 TB
ST1000VX005	1 TB
Toshiba	
MG07ACA10TE	10 TB
MG03ACA400	4 TB
DT01ABA300V	3 TB
MG03ACA300	3 TB
DT01ABA200V	2 TB
DT01ACA200	2 TB
Hitachi	
HUA723030ALA640	3 TB
HUS724040ALA640	4 TB
HUS724020ALA640	2 TB

B. Live View Streaming

The default streaming for local display and Web browser access are listed below.

Screen Display	GV-SNVR0411		
	Default	One Camera >2M	All Camera <=2M
1 Division	Stream 1	Stream 1	Stream 1
4 Divisions	Stream 2	Channel 1: Stream 2 Other channels: Stream 1	Stream 1
Screen Display	GV-SNVR0412		
	Default	All Camera <= 2M	
1 Division	Stream 1	Stream 1	
4 Divisions	Stream 2	Stream 1	
Screen Display	GV-SNVR0811 / 0812		
	Default	All Camera <=2M	
1 Division	Stream 1	Stream 1	
4 Divisions	Stream 2	Stream 1	
6 Divisions	Stream 2	Stream 2	
8 Divisions	Stream 2	Stream 2	
9 Divisions	Stream 2	Stream 2	

Screen Display	GV-SNVR0400F
1 Division	Stream 1
4 Divisions	Stream 1
Screen Display	GV-SNVR1600
1 Division	Stream 1
4 Divisions	Stream 1
9 Divisions	Stream 2
16 Divisions	Stream 2
Screen Display	GV-SNVR1611
	Default
1 Division	Stream 1
4 Divisions	Stream 1
6 Divisions	Channel 1 / 7 / 13: Stream 1 Other channels: Stream 2

Appendix

8 Divisions	Channel 1 / 9: Stream 1 Other channels: Stream 2
9 Divisions	Stream 2
16 Divisions	Stream 2
<p>Note: The resolution of each channel can be adjusted as necessary, with the following limits:</p> <ul style="list-style-type: none">• Up to 16 channels for 1080p at 30 fps.• Up to 16 channels for 4M at 15 fps.• Up to 4 channels for 4K at 30 fps.	

C. Supported Resolution by GV-SNVR

To see the live view, make sure the resolutions of stream 1 and 2 both meet the specifications listed below.

Model	GV-SNVR0411 / 0412 / 0811 / 0812	
Stream	Main Stream	Sub Stream
4:3	2592 x 1944 (not available on GV-SNVR0812)	1024 x 768, 960 x 720, 640 x 480, 320 x 240
	2560 x 2048 (not available on GV-SNVR0411)	
	2560 x 1920	
	2048 x 1536	
	2048 x 1520	
	1600 x 1200	
	1280 x 960	
	640 x 480	
	320 x 240	320 x 240
16 : 9 (Default)	3840 x 2160	1280 x 720, 640 x 360, 448 x 252
	2592 x 1520	
	2560 x 1440	
	2304 x 1296	
	1920 x 1080	
	1280 x 720	
	640 x 360	640 x 360, 448 x 252
	448 x 252	448 x 252
5:4	1280 x 1024	1280 x 1024, 640 x 512, 320 x 256
	640 x 512	640 x 512, 320 x 256
	320 x 256	320 x 256
20 : 19 (Fisheye Camera Only)	2176 x 2048	640 x 608
	2048 x 1944	
	1792 x 1696	
	1440 x 1376	
	1280 x 1200	

Appendix

Model		GV-SNVR0400F	
Stream		Main Stream	Sub Stream
4:3	CH1	1600 x 1200	640 x 480, 320 x 240
		1280 x 960	
		640 x 480	
		320 x 240	
	CH2 ~ CH4	1600 x 1200	320 x 240
		1280 x 960	
		640 x 480	
		320 x 240	
16 : 9 (Default)	CH1	1920 x 1080	640 x 360, 448 x 252
		1280 x 720	
		640 x 360	
		448 x 252	
	CH2 ~ CH4	1920 x 1080	448 x 252
		1280 x 720	
		640 x 360	
		448 x 252	
5:4	CH1	1280 x 1024	640 x 512, 320 x 256
		640 x 512	
		320 x 256	
	CH2 ~ CH4	1280 x 1024	320 x 256
		640 x 512	
		320 x 256	

Model		GV-SNVR1600	
Stream		Main Stream	Sub Stream
4:3	CH1	2560 x 1920	640 x 480, 320 x 240
		2048 x 1536	
		2048 x 1520	
		1600 x 1200	
		1280 x 960	
		640 x 480	
		320 x 240	
	CH2~CH16	1600 x 1200	640 x 480, 320 x 240
		1280 x 960	
		640 x 480	
320 x 240		320 x 240	
16 : 9 (Default)	CH1	2592 x 1520	640 x 360, 448 x 252
		2560 x 1440	
		2304 x 1296	
		1920 x 1080	
		1280 x 720	
		640 x 360	
		448 x 252	
	CH2~CH16	1920 x 1080	640 x 360, 448 x 252
		1280 x 720	
		640 x 360	
448 x 252		448 x 252	
5:4	CH1~CH16	1280 x 1024	640 x 512, 320 x 256
		640 x 512	
		320 x 256	
20 : 19 (Fisheye Camera Only)	CH1	2048 x 1944	640 x 608
		1792 x 1696	
		1440 x 1376	
		1280 x 1200	

Appendix

Model	GV-SNVR1611	
Stream	Main Stream	Sub Stream
4:3	4000 x 3000	1280 x 1200, 1024 x 768, 960 x 720, 640 x 480, 320 x 240
	2560 x 1920	
	2048 x 1536	
	1600 x 1200	
	1280 x 960	
	640 x 480	
16 : 9 (Default)	3840 x 2160	1280 x 720, 640 x 360, 448 x 256
	2592 x 1520	
	2560 x 1440	
	2304 x 1296	
	1920 x 1080	
	1280 x 720	
	640 x 360	
5:4	1280 x 1024	1280 x 1024, 640 x 512, 320 x 256
	640 x 512	
20 : 19 (Fisheye Camera Only)	2896 x 2768	960 x 912, 640 x 608
	2176 x 2048	
	2048 x 1944	
	1792 x 1696	
	1440 x 1376	