

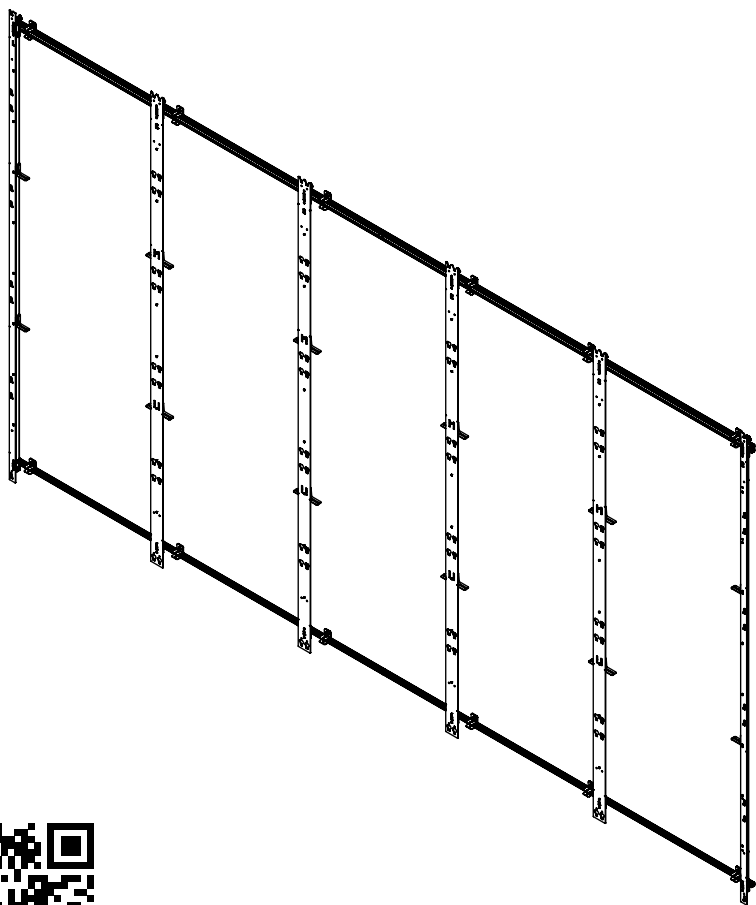

## DS-LEDIER Series

\*Actual configuration may vary



**ENG** Installation video for reference only.  
Read and follow instruction manual for full installation.



## ⚠ WARNING

ENG - This product is designed to be installed on plywood walls. Hardware is included for plywood installation. This product is designed to be installed on flat, unobstructed, vertical walls. Do not install on curved or angled walls. Before installing make sure the supporting surface will support the combined load of the equipment and hardware. Screws must be tightly secured. Do not overtighten screws or damage can occur and product may fail. Never exceed the Maximum Load Capacity. Always use an assistant or mechanical lifting equipment to safely lift and position equipment. This product is intended for indoor use only. Use of this product outdoors could lead to product failure or personal injury. Be careful not to pinch fingers when operating the mount. For support please call customer care at 1-800-865-2112.

ENG Symbols



ENG WARNING



ENG Screws must get at least three full turns and fit snug.



ENG Wear anti-static gloves.

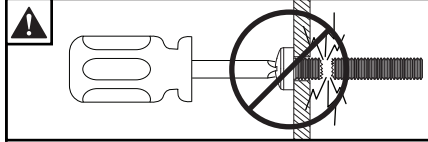

ENG Do not overtighten screws.

**ENG** Tools Needed for Assembly.

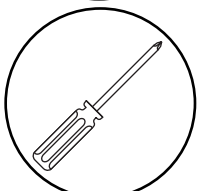
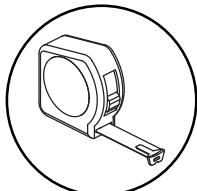
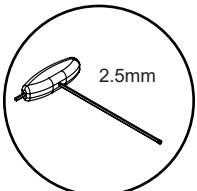
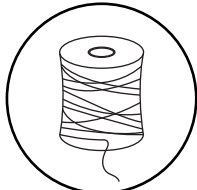
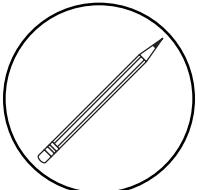
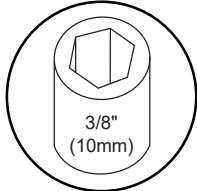
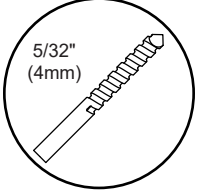
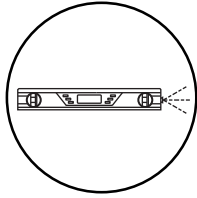
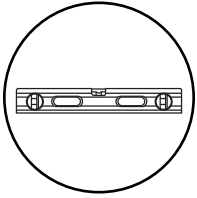

**ENG** To properly tighten screws: Tighten until screw head makes contact, then tighten another 1/2 turn. Do not overtighten screws.

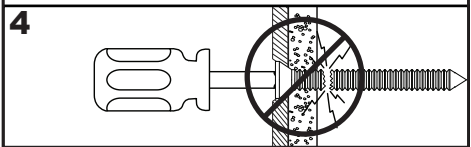
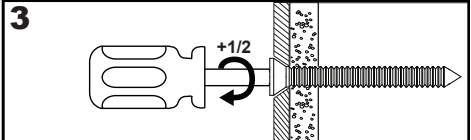
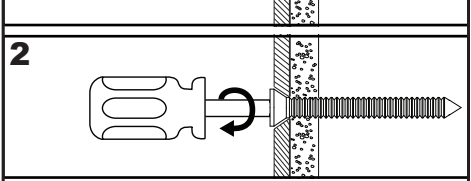
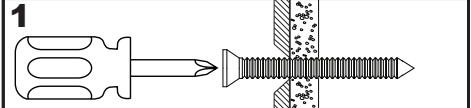

**ENG** Parts (Before beginning, make sure you have all parts shown below).  
Refer to parts list included with your model.

Parts List	
Description	
<b>A</b>	left column
<b>B</b>	right column
<b>C</b>	inside column
<b>D</b>	vertical spacer
<b>E</b>	horizontal spacer
<b>F</b>	top left horizontal asy
<b>G</b>	top right horizontal asy
<b>H</b>	bottom left horizontal asy
<b>I</b>	bottom right horizontal asy
<b>J</b>	extrusion connector
<b>K</b>	wall plate shim
<b>L</b>	M5 x 8mm
<b>M</b>	M5 x 5mm set screw
<b>N</b>	#14 x 1.75" wood screw
<b>O</b>	3mm allen wrench two-tip T-handle

**A**  
left column

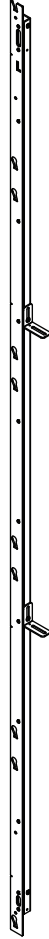

**B**  
right column



**C**  
inside column



**D**  
vertical spacer

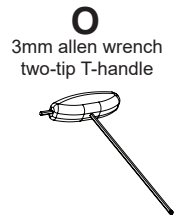
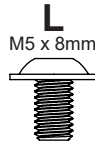
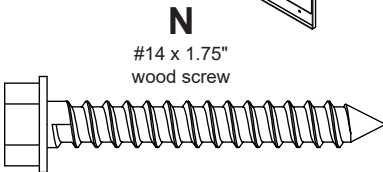
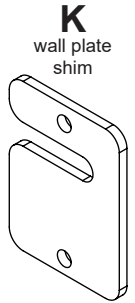
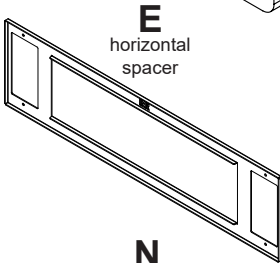
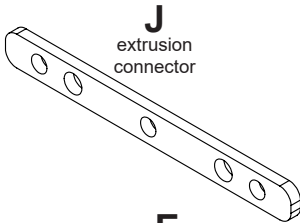
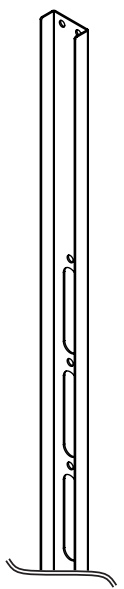

**F**  
top left  
horizontal asy



**G**  
top right  
horizontal asy



**H**  
bottom left  
horizontal asy



**I**  
bottom right  
horizontal asy



# 1-1

**ENG** Optional: If connecting two top horizontal extrusions, first remove inner hook-on brackets.

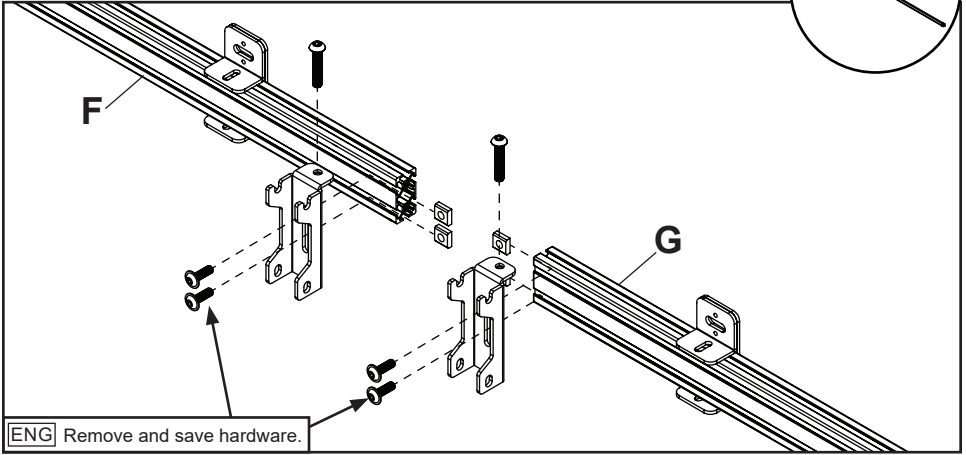

# 1-2

**ENG** Use extrusion connectors to connect top horizontal extrusions.

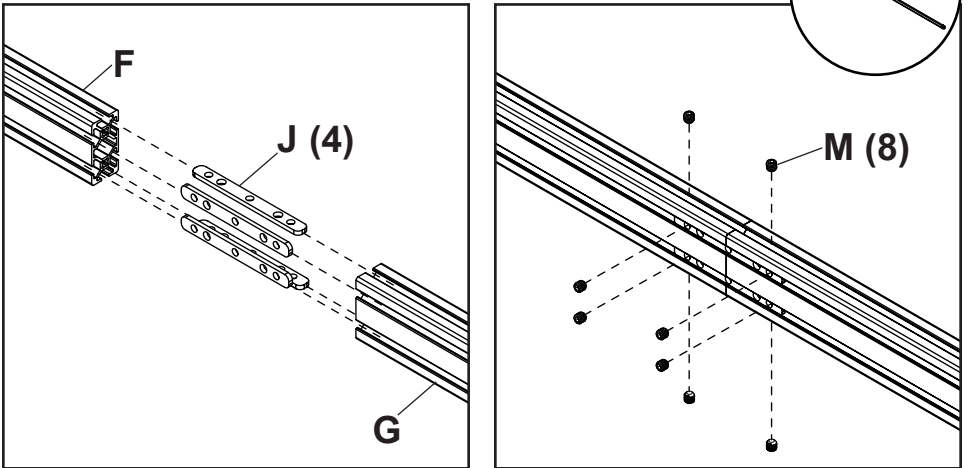

# 1-3

**ENG** Replace one hook-on bracket in between connected extrusions.

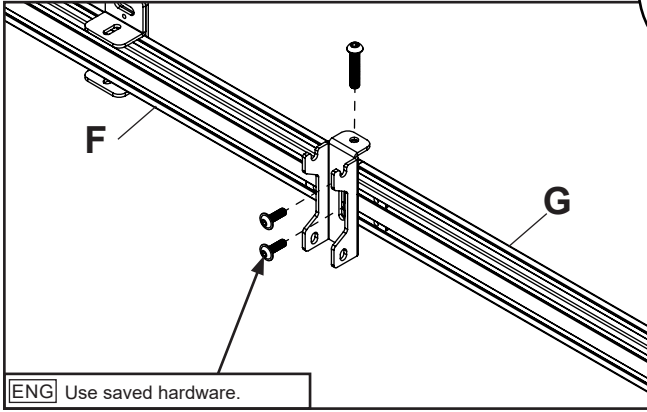

# 2-1

**ENG** Optional: If connecting two bottom horizontal extrusions, first remove inner hook-on brackets

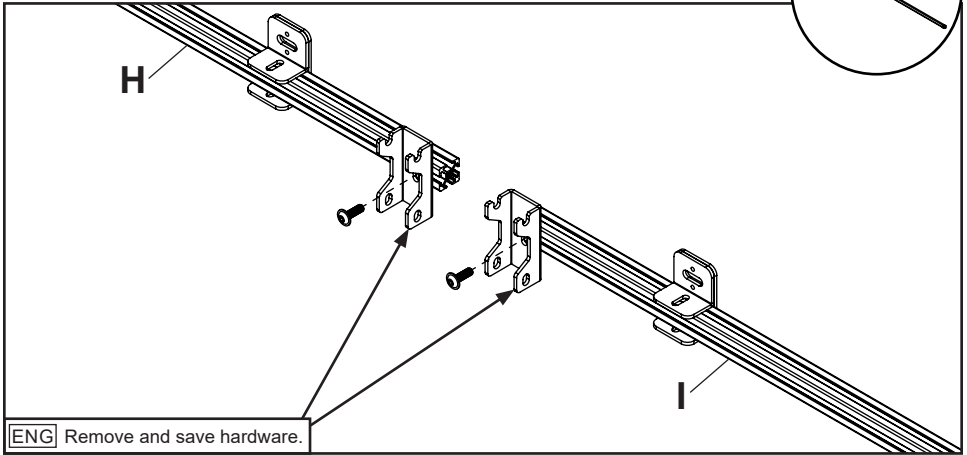

## 2-2

**ENG** Use extrusion connectors to connect bottom horizontal extrusions.

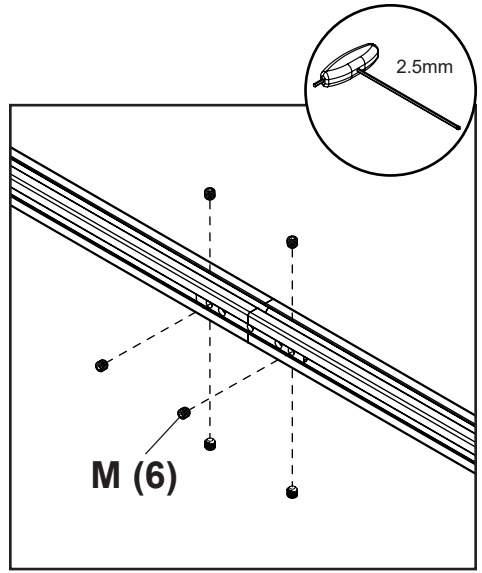
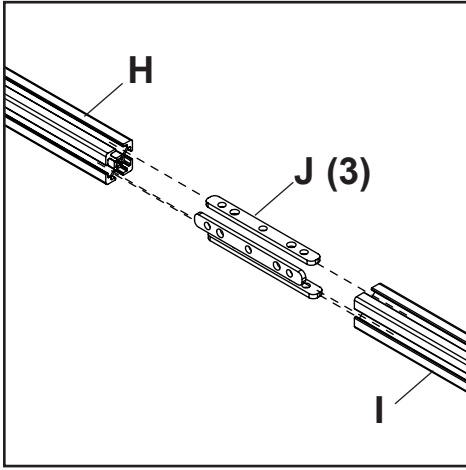

## 2-3

**ENG** Replace one hook-on bracket in between connected extrusions.

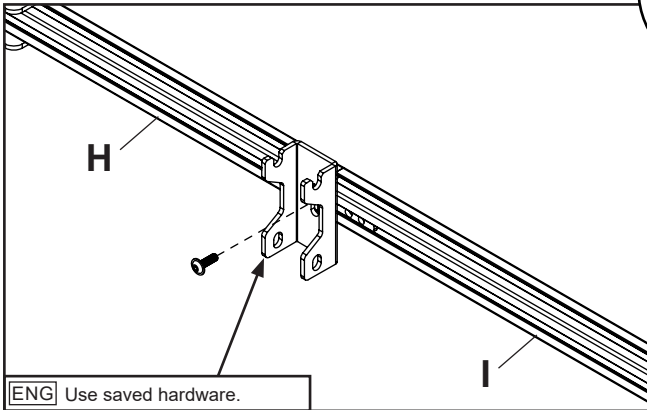

**ENG** Use saved hardware.



**ENG** This page intentionally left blank.

### 3

#### ▲ WARNING

ENG - When installing Peerless wall mounts on a wood stud wall covered with plywood, verify that the wood studs are a minimum of 2" x 4" nominal size and plywood is a minimum Grade BC, 1/2" (13 mm) thick. Plywood may be covered by gypsum board (drywall) up to 5/8" thick.

### 3-1

ENG When installing more than one display to a wood stud wall reinforced with plywood (minimum Grade BC, 1/2" thick) that may be covered in gypsum board (drywall) up to 5/8" thick, the mounting surface must be plumb (+/- .50") across the height of the video wall and straight (+/- .50") across the width of the video wall.

### 3-2

ENG Use a laser level to keep mounting holes level.

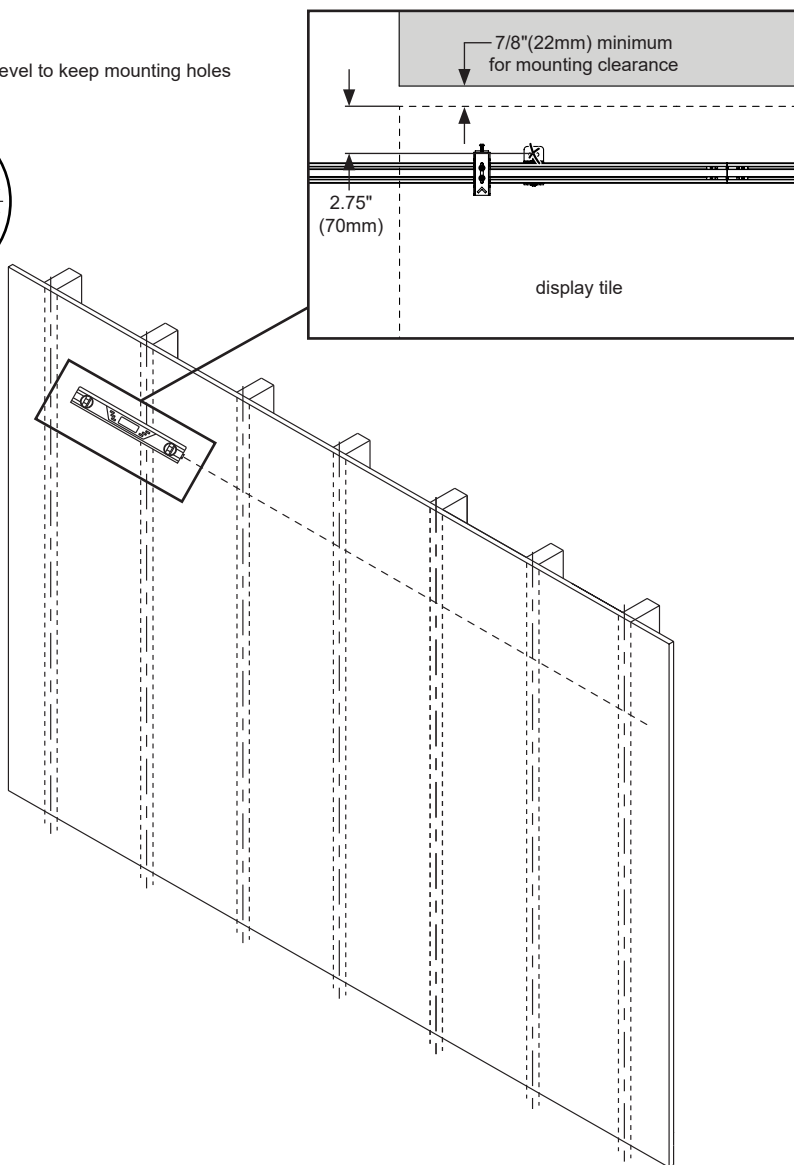
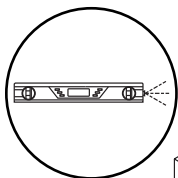

### 3-3

**ENG** Level top horizontal extrusion and mark mounting holes on plywood (must be minimum Grade BC, 1/2" (13mm) thick.)

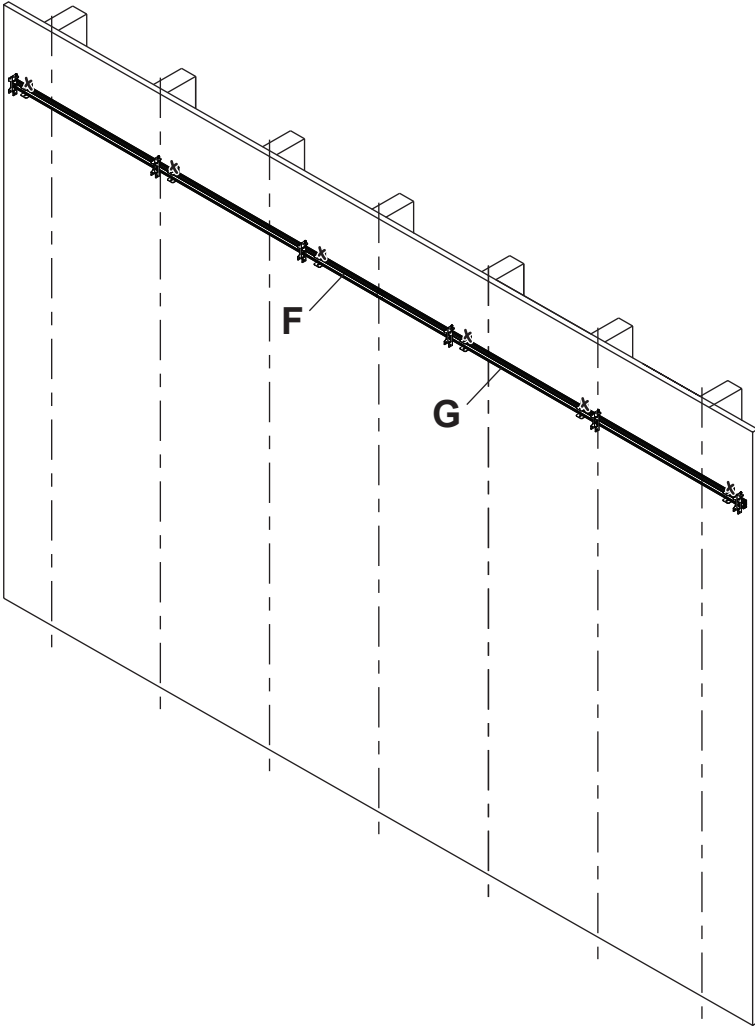
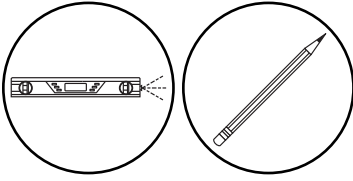

### 3-4

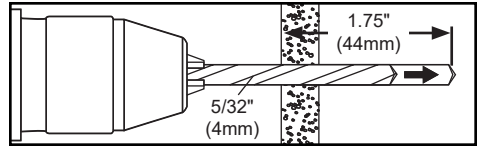
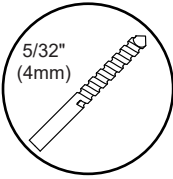

**ENG** Drill mounting holes into supporting surface (1.75" (44mm) minimum depth required).

### 3-5

**ENG** Level extrusion. Install using wood screws provided.

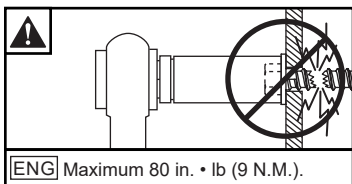
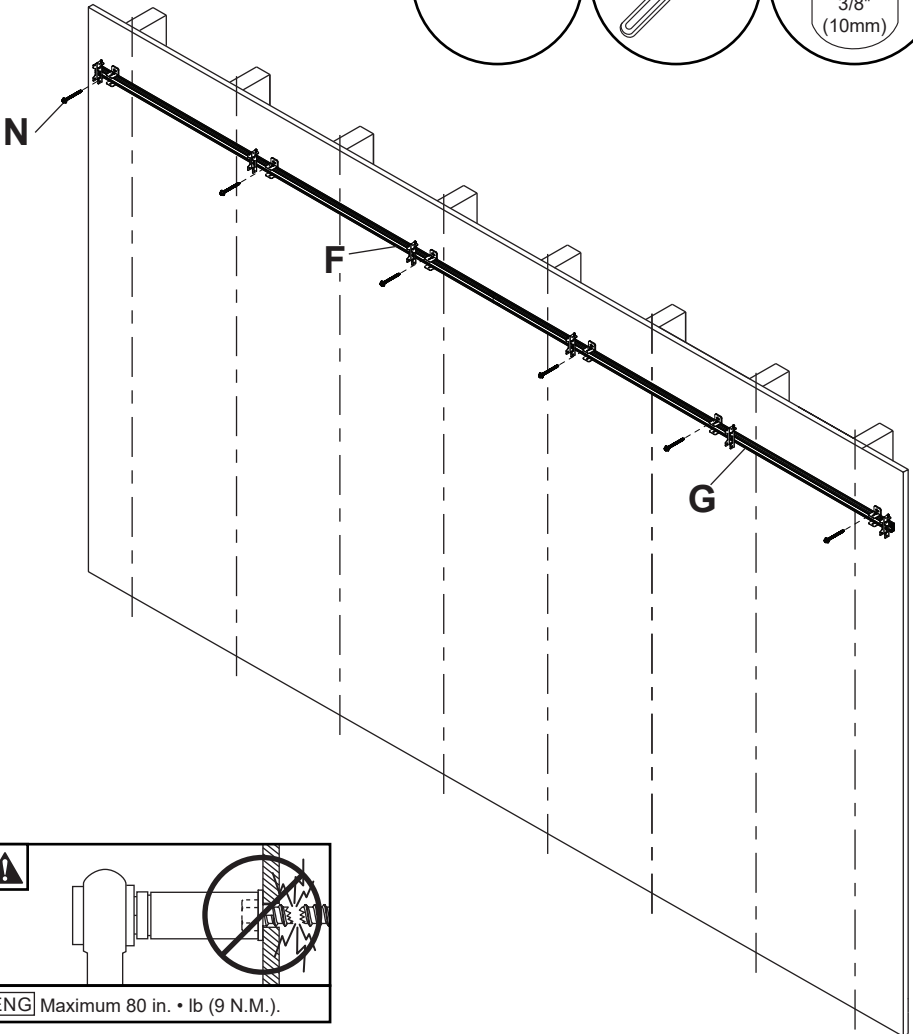
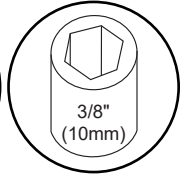
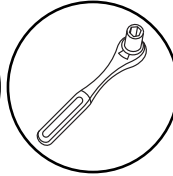
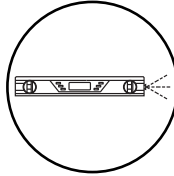

# 3-6

**ENG** Secure vertical spacers to the wall flush with the horizontal extrusion.

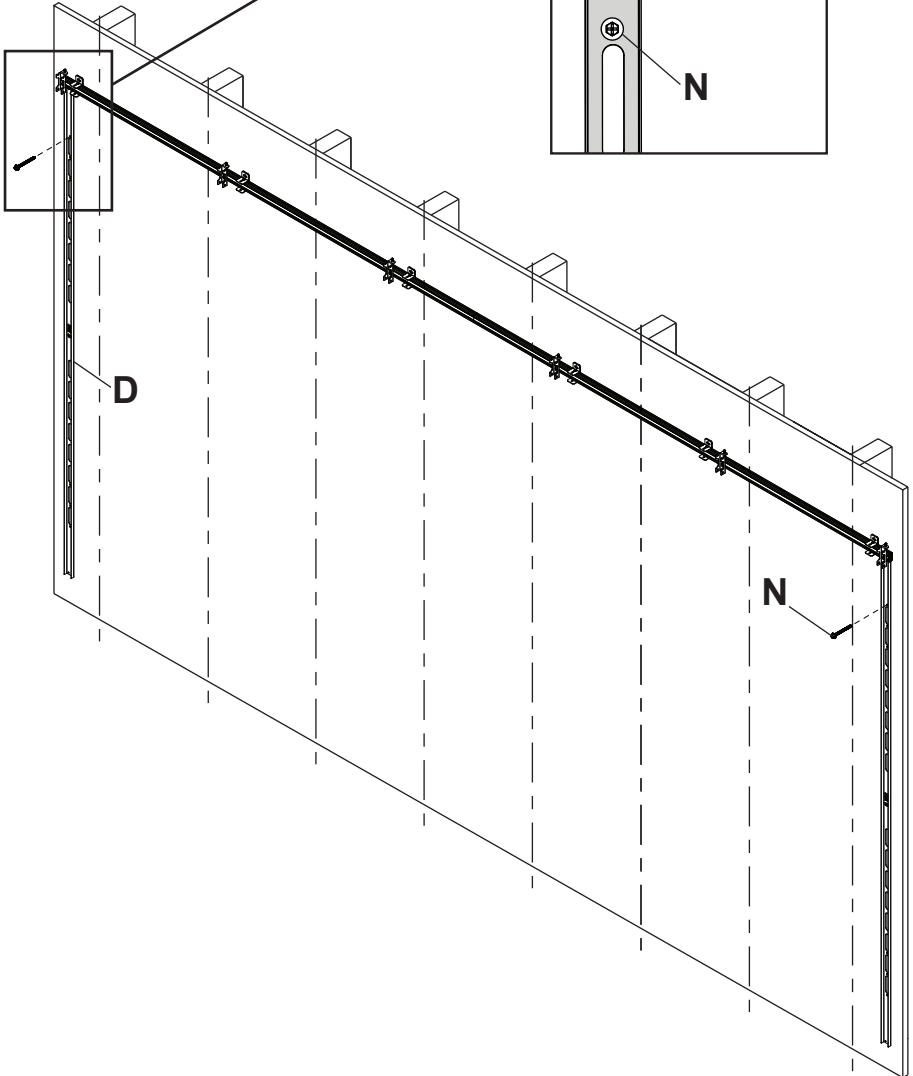
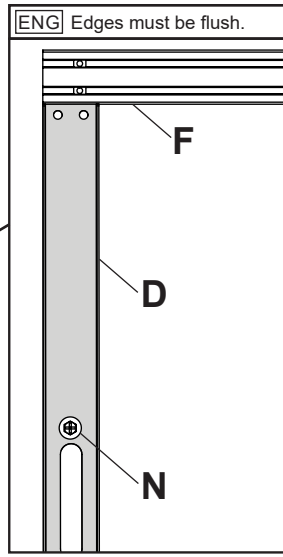
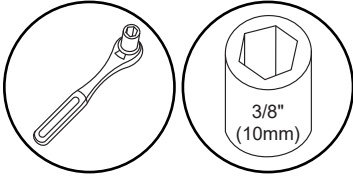

### 3-7

**ENG** Use third vertical spacer to align bottom horizontal extrusion flush with vertical spacer, then mark mounting holes on plywood (must be minimum Grade BC, 1/2" (13mm) thick.)

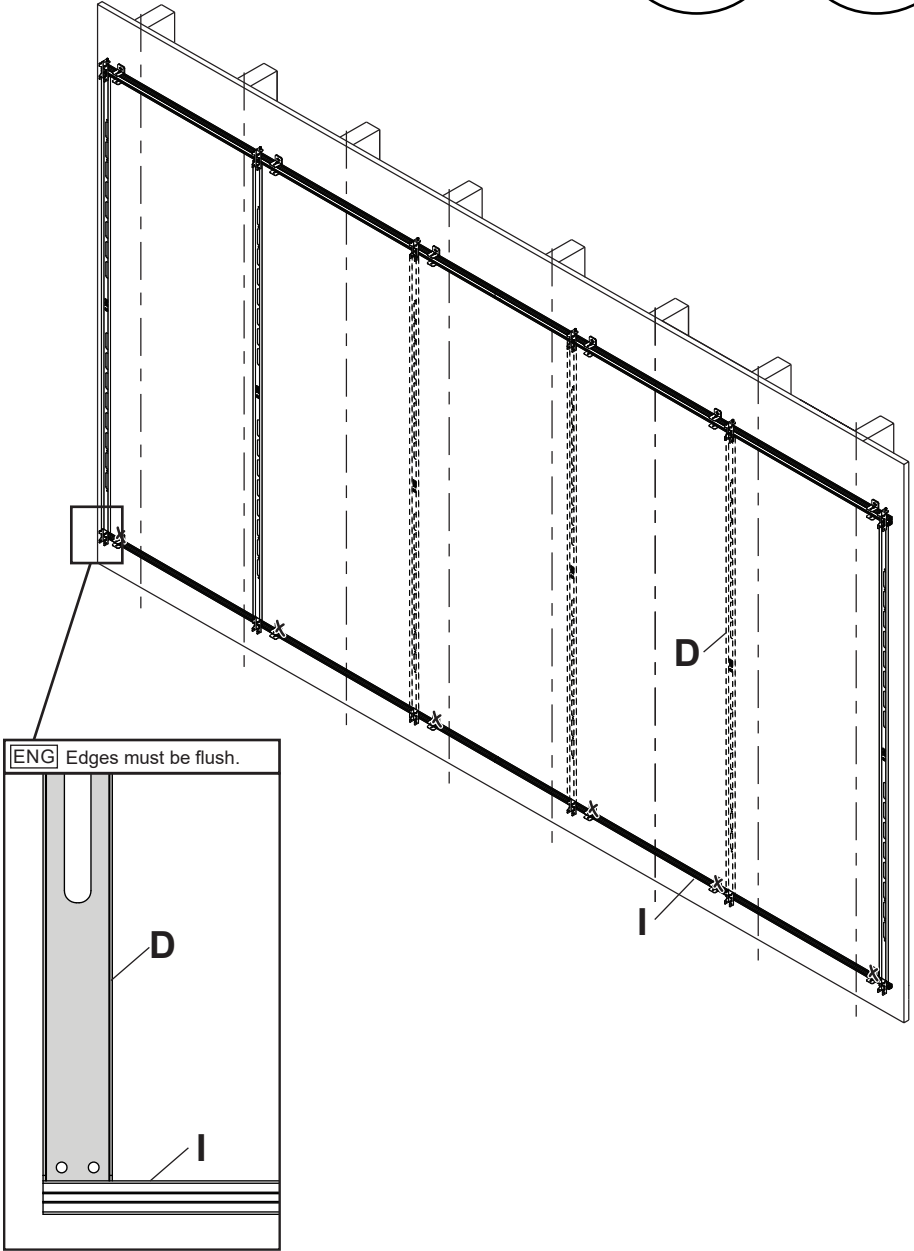
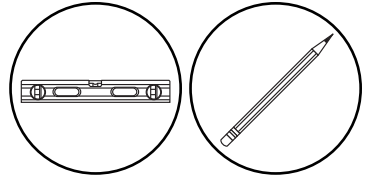

### 3-8

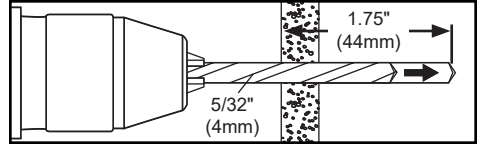
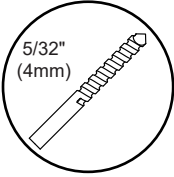

**ENG** Drill mounting holes into supporting surface (1.75" (44mm) minimum depth required).

### 3-9

**ENG** Use third vertical spacer to align bottom horizontal extrusion flush with vertical spacer, then install using wood screws provided.

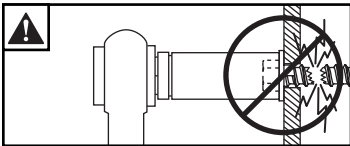
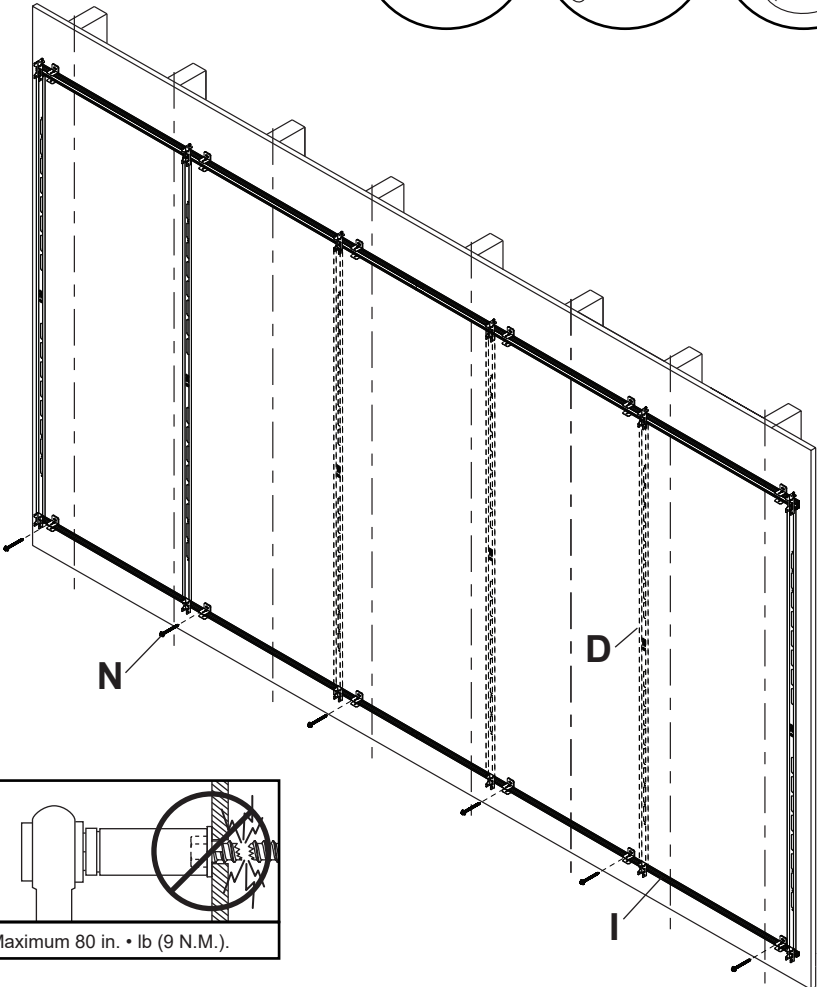
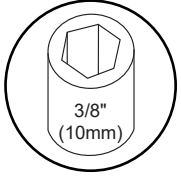
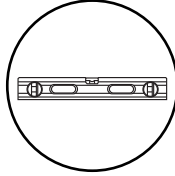

**ENG** Maximum 80 in. • lb (9 N.M.).

# 3-10

ENG Remove vertical spacer.

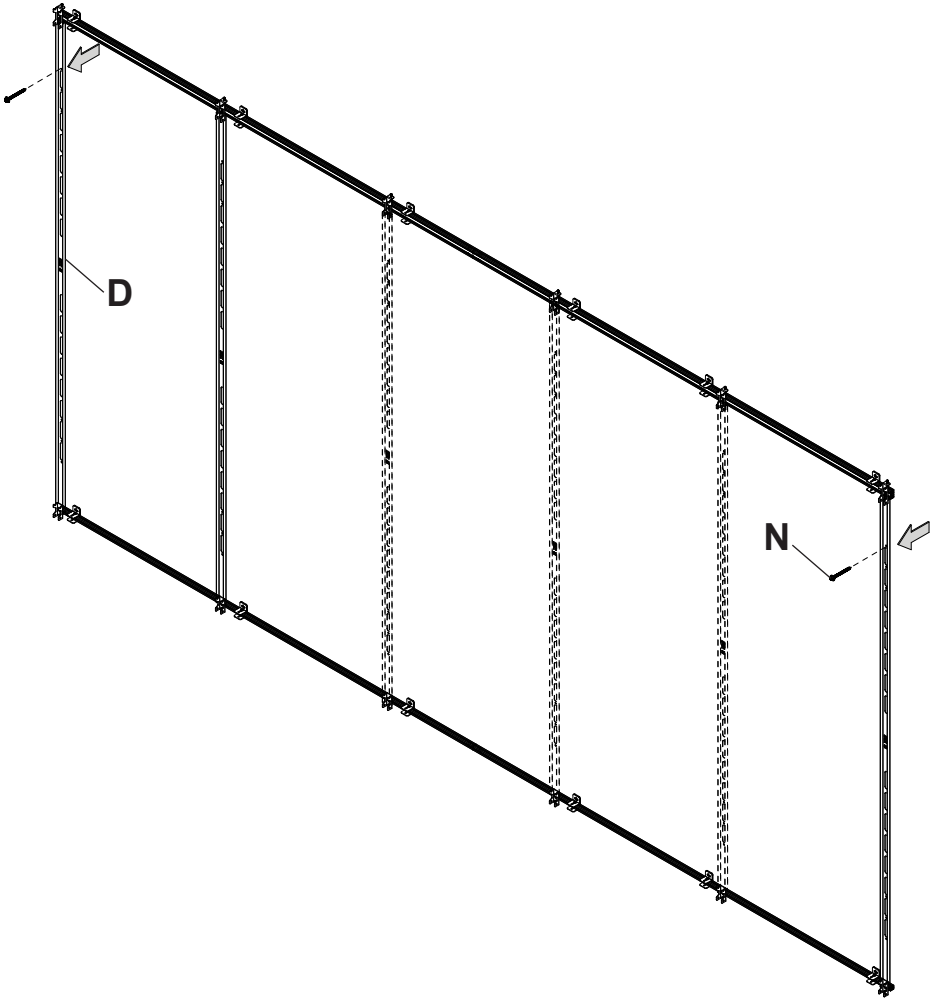
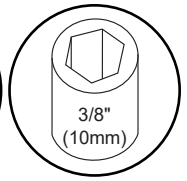
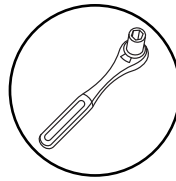



# 4-1

**ENG** Hook on and secure outer vertical columns. "L" and "R" markings designate left and right column.

**ENG** Tighten hardware.

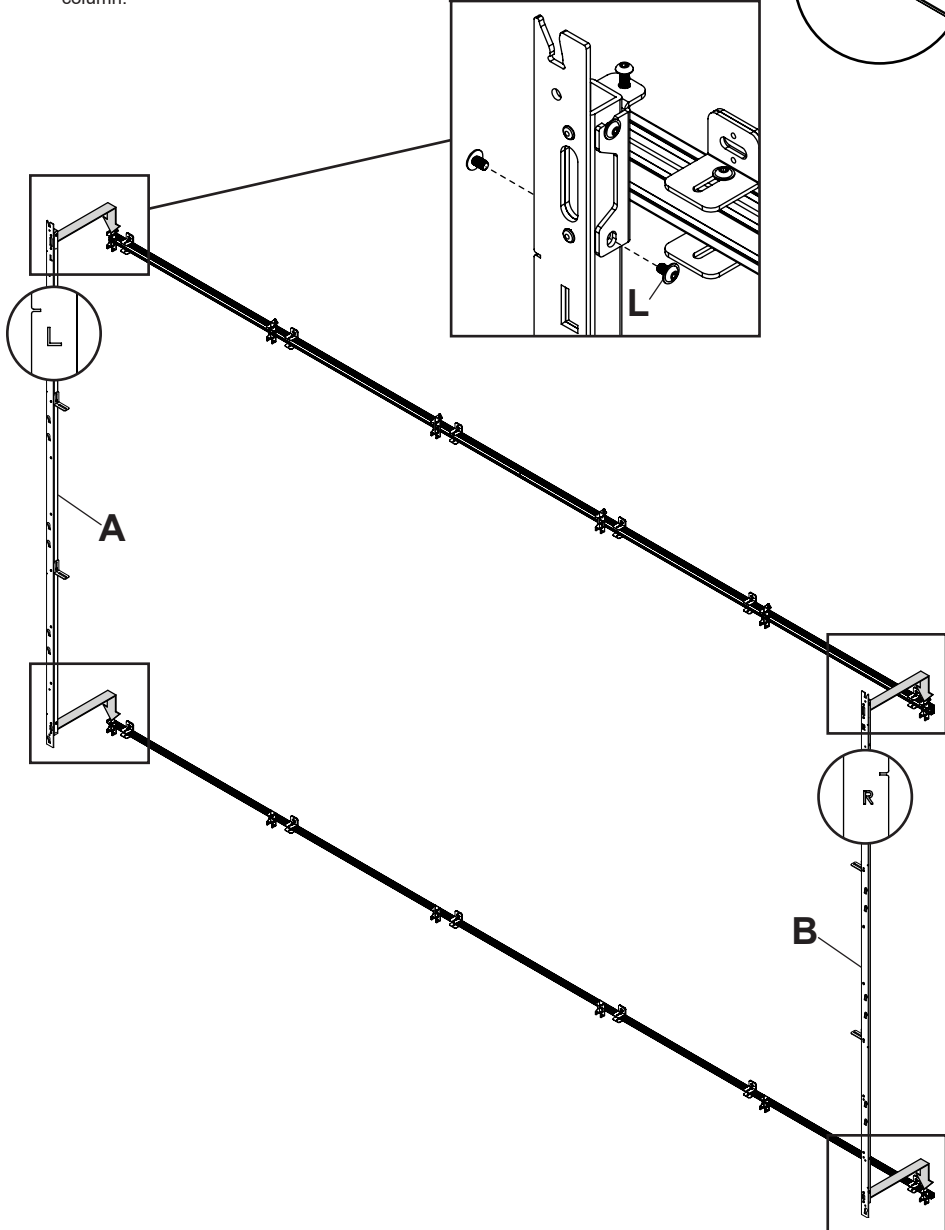
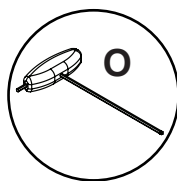

# 4-2

ENG Hook on and secure all inside vertical columns.

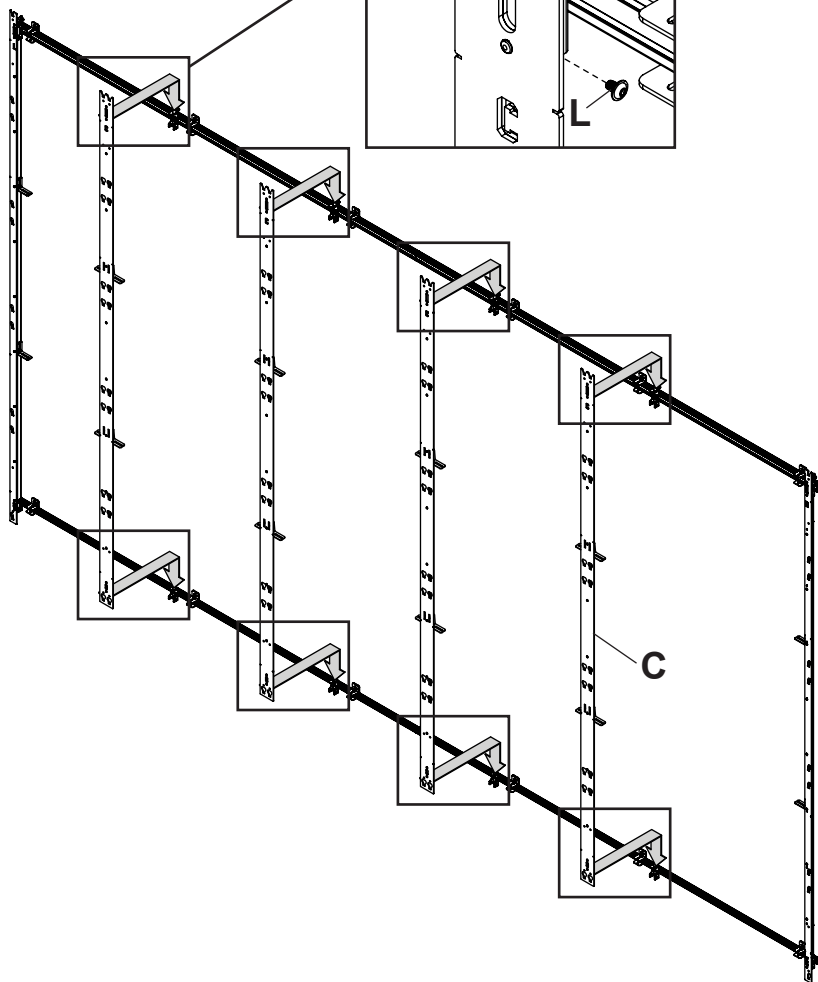
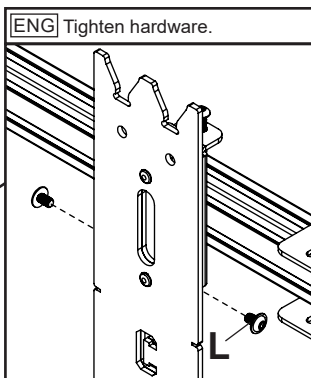
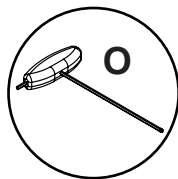

# 5-1

ENG Loosen hardware on vertical columns.

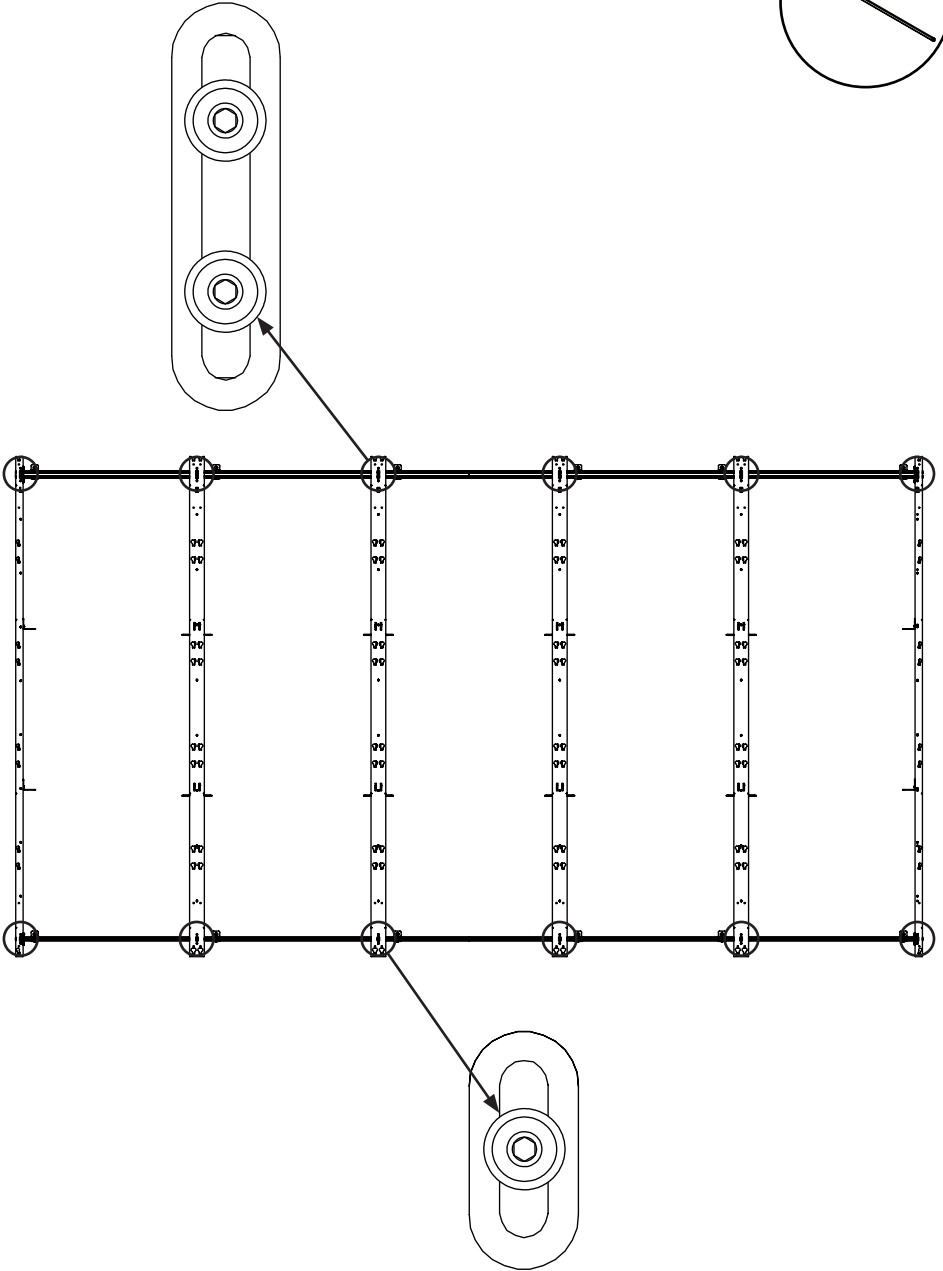
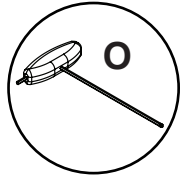

# 5-2

**ENG** Plumb and level outer columns, then tighten hardware. Tighten hardware on four corner wall plates.

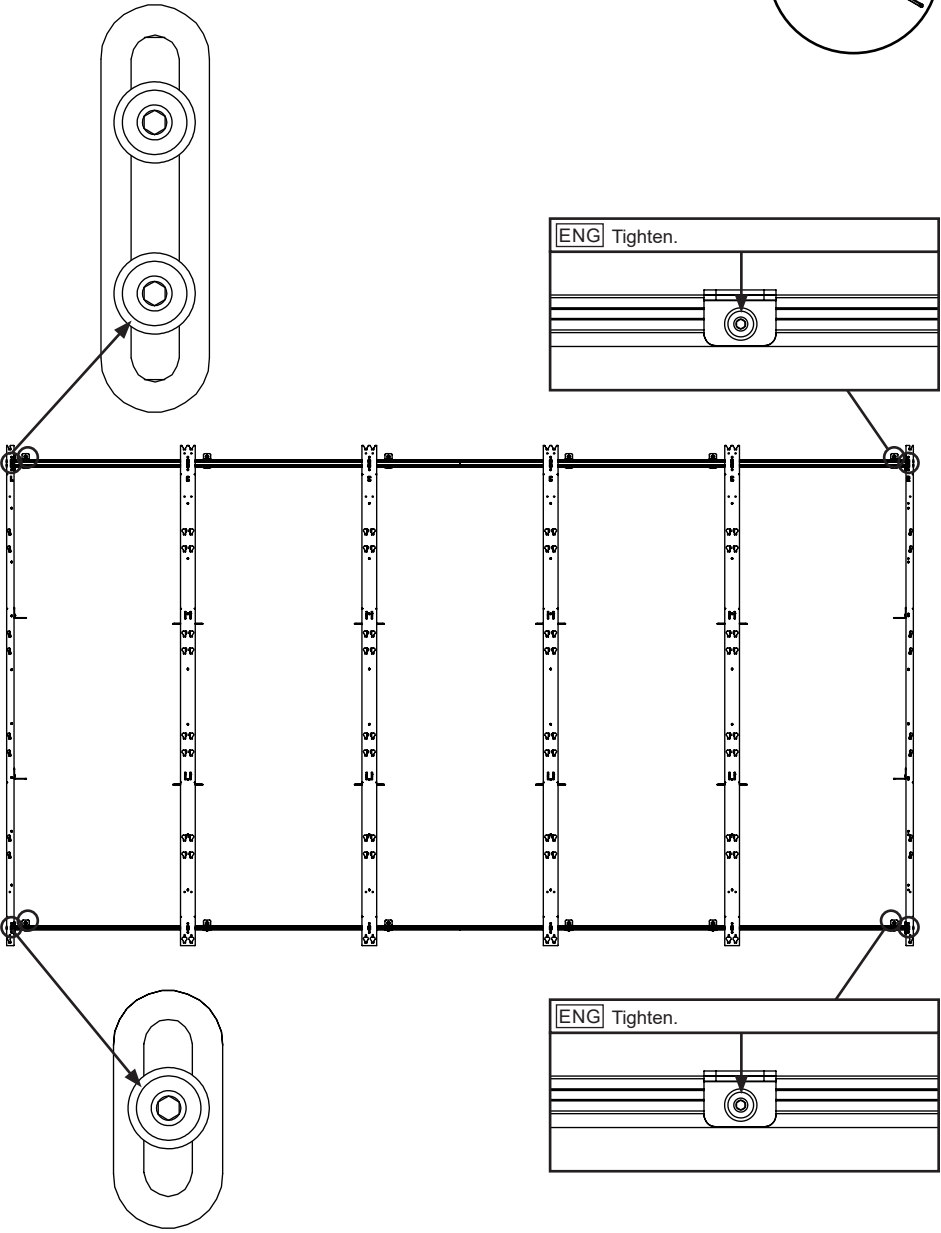
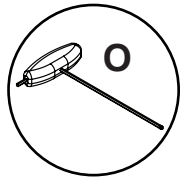

# 5-3

**ENG** Tie a string between top slots on outer columns in order to level the depth of each vertical column.

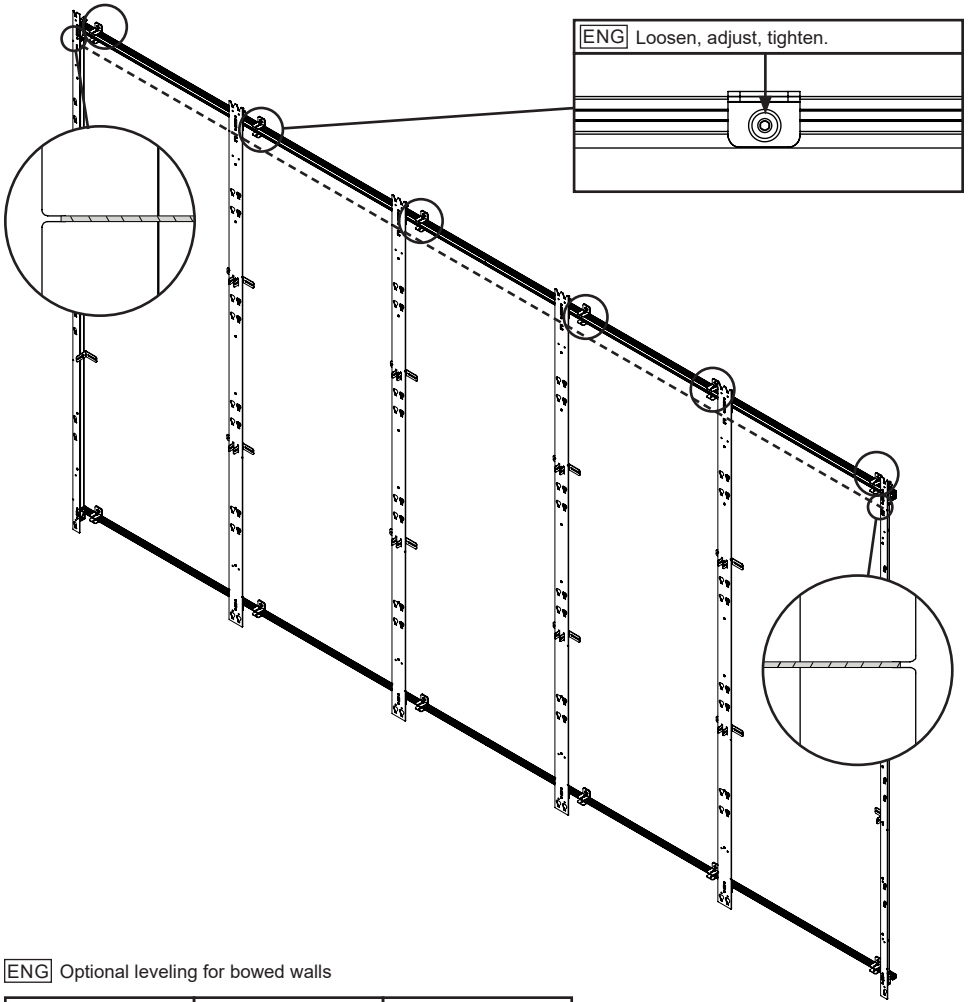
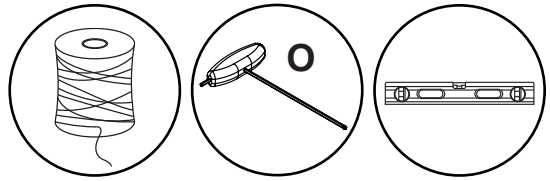

**ENG** Loosen, adjust, tighten.

**ENG** Optional leveling for bowed walls

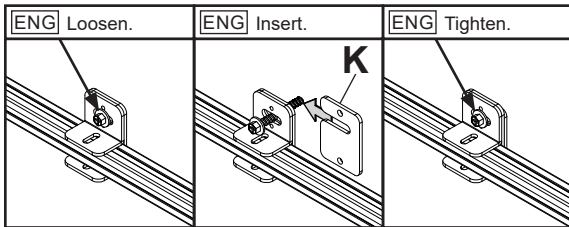

# 5-4

**ENG** Tie a string between bottom slots on outer columns in order to level the depth of each vertical column.

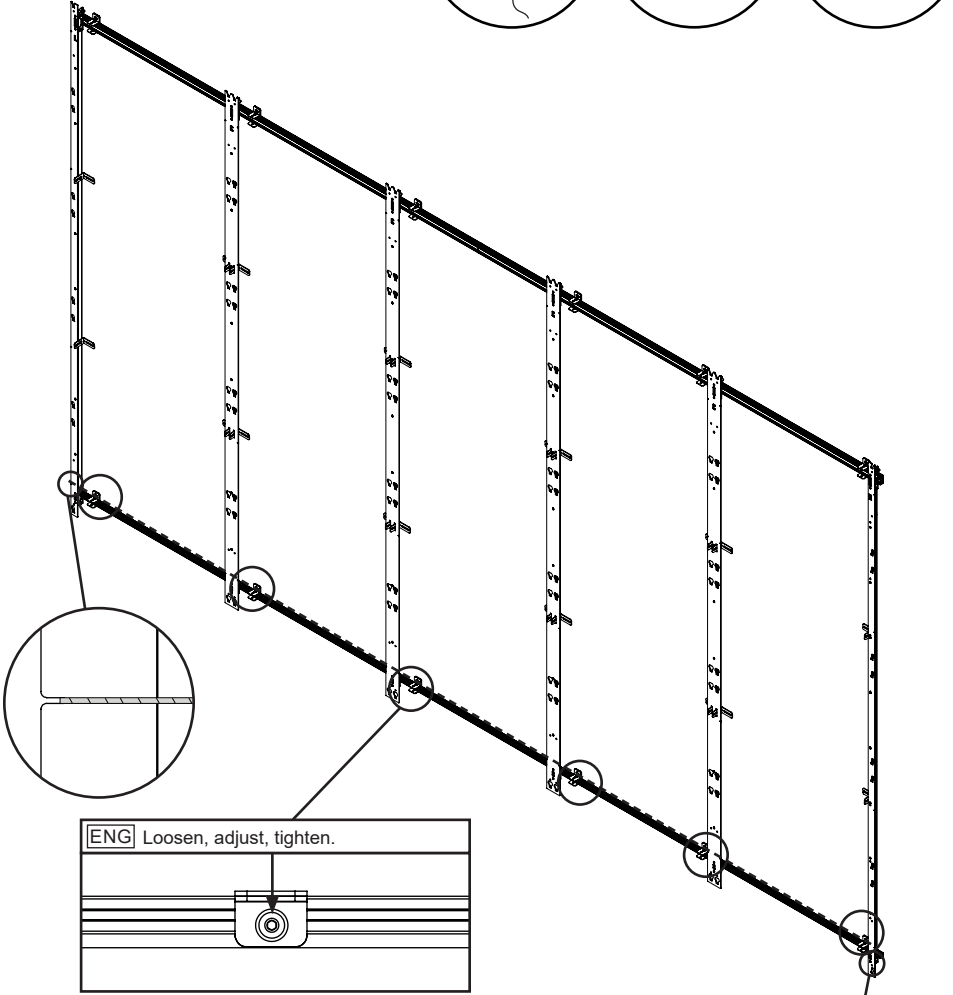
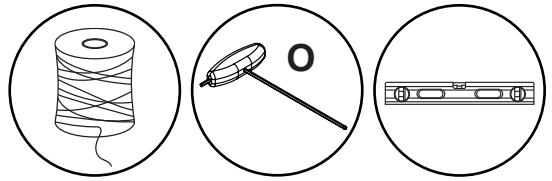

**ENG** Loosen, adjust, tighten.

**ENG** Optional leveling for bowed walls

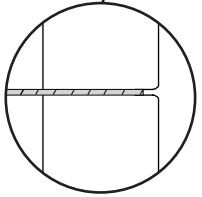
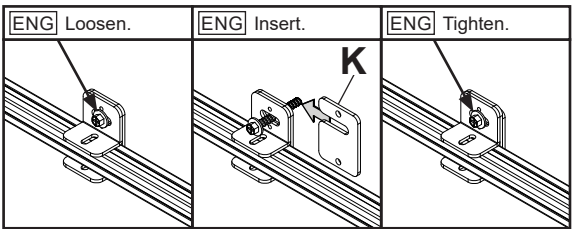

# 5-5

ENG With the string still attached, level the height of each column

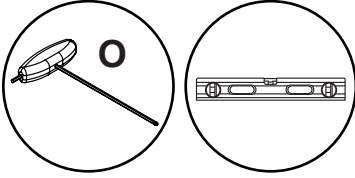

ENG Tighten or loosen to adjust height.

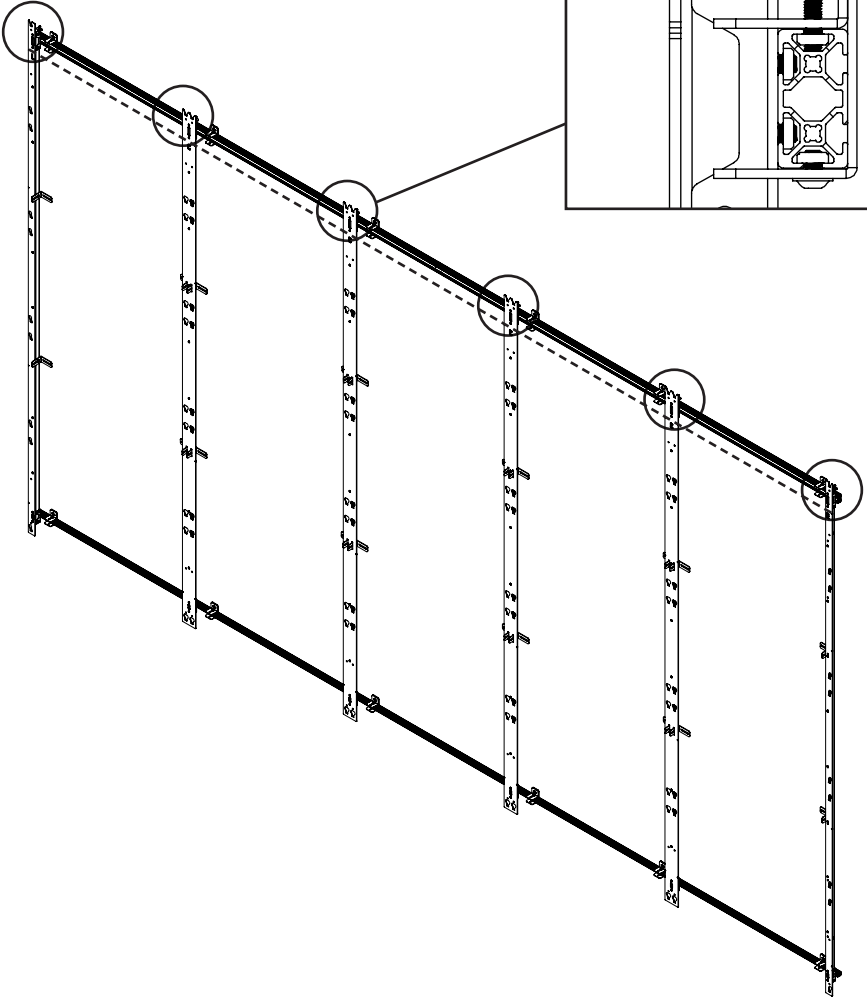
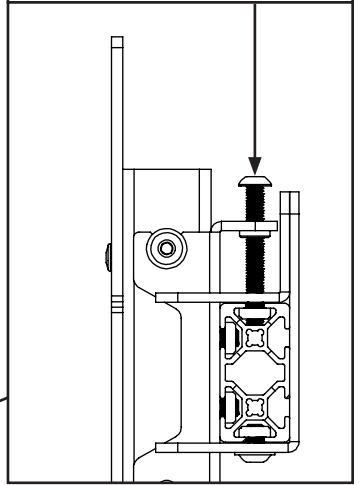

# 5-6

**ENG** Adjust inner columns to fit horizontal spacers.  
Tighten column hardware after spacing. Start from the left column.

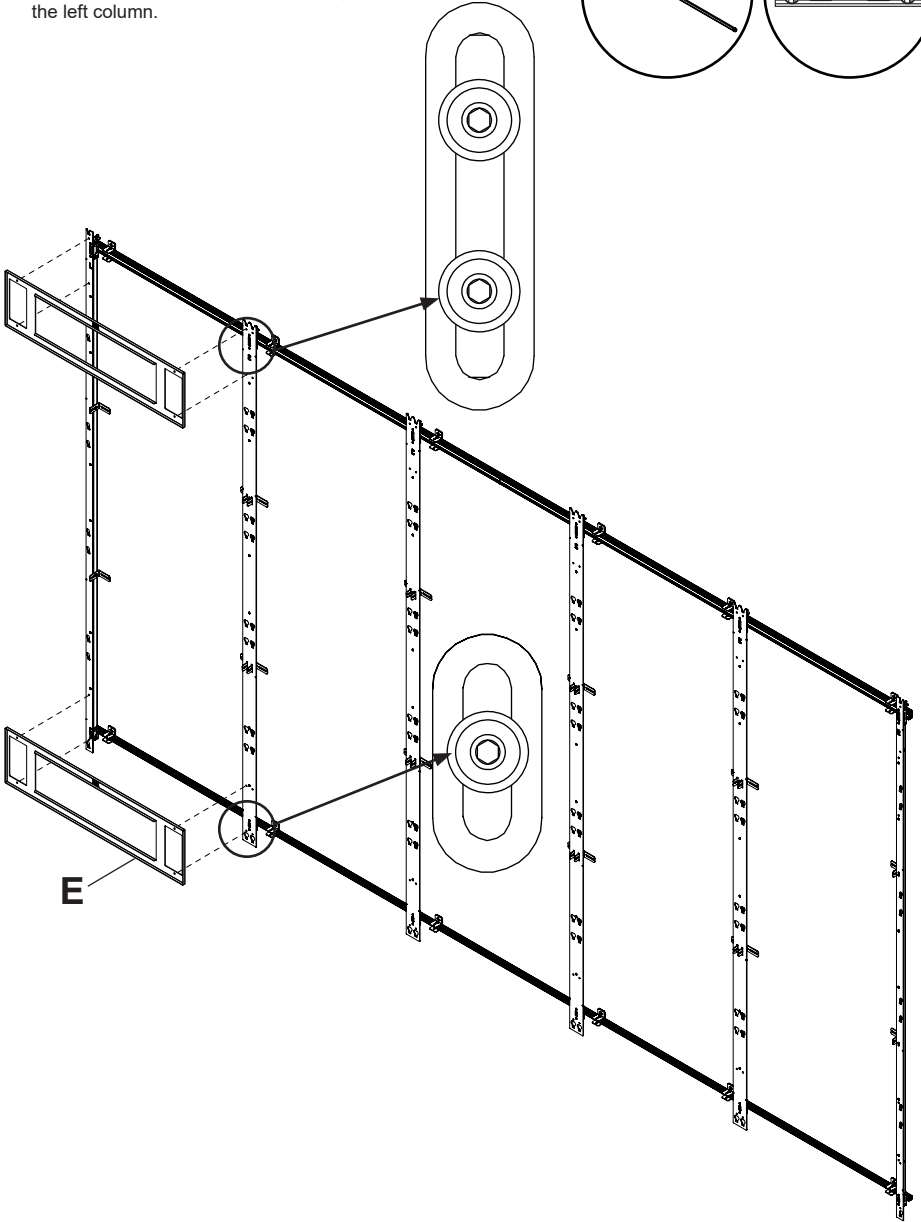
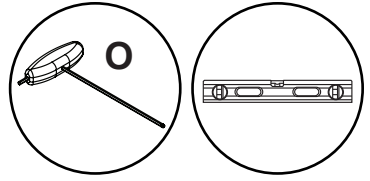



# 5-7

**ENG** Continue adjusting inner columns to fit horizontal spacers until all are level. Tighten column hardware after spacing

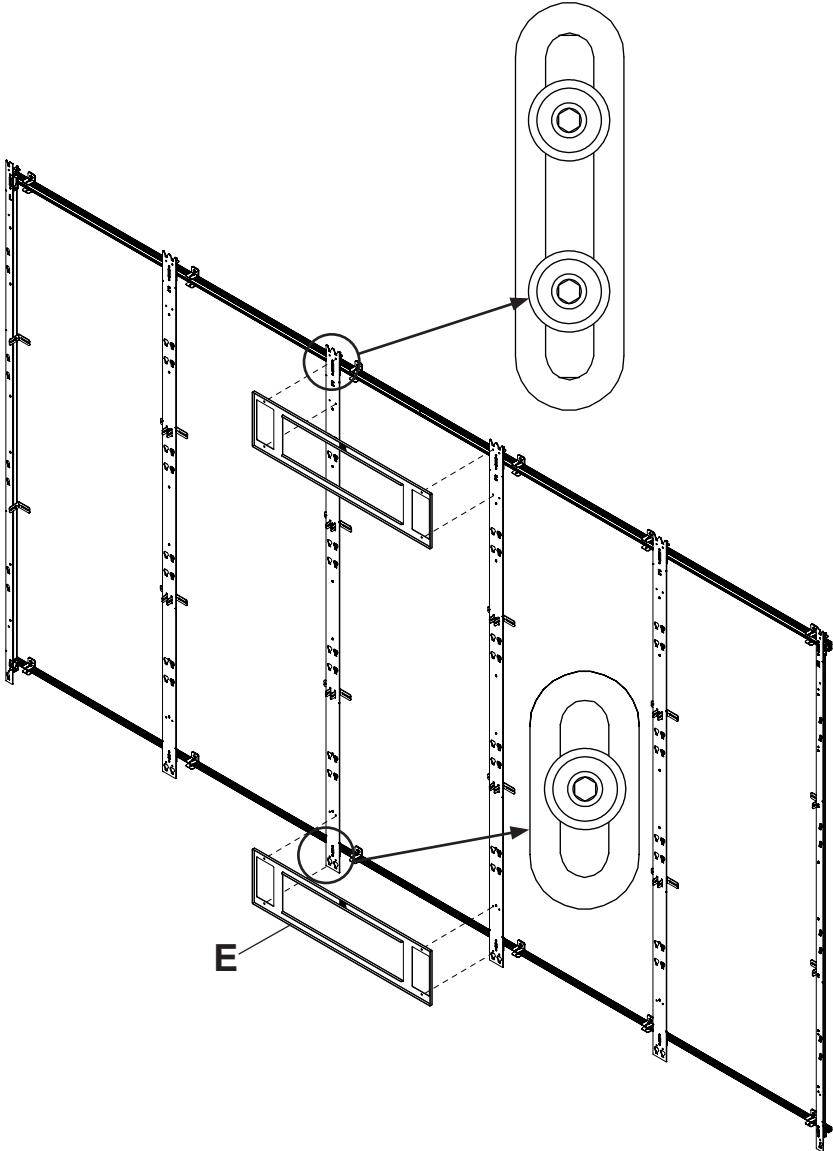
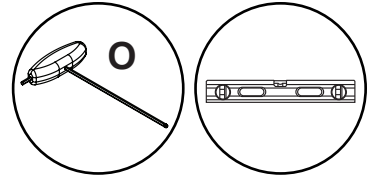

# 5-8

ENG Remove all spacers.

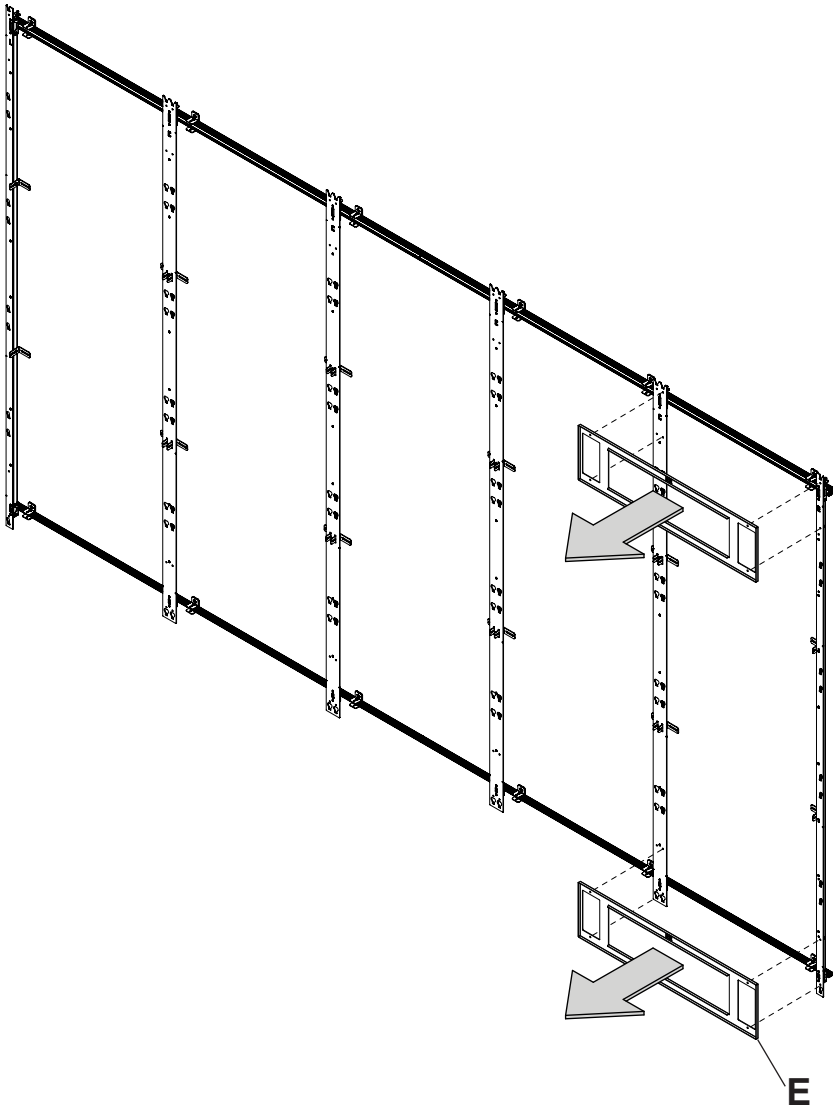

# 6-1

**ENG** Optional: For shallow depth installations, flip wall bracket orientation as shown.

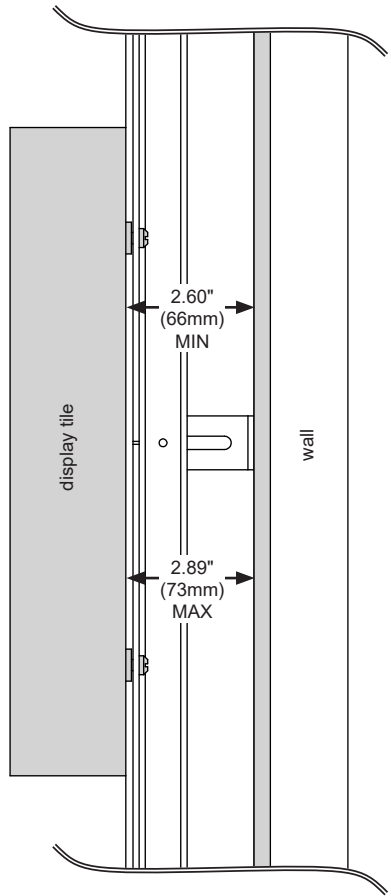
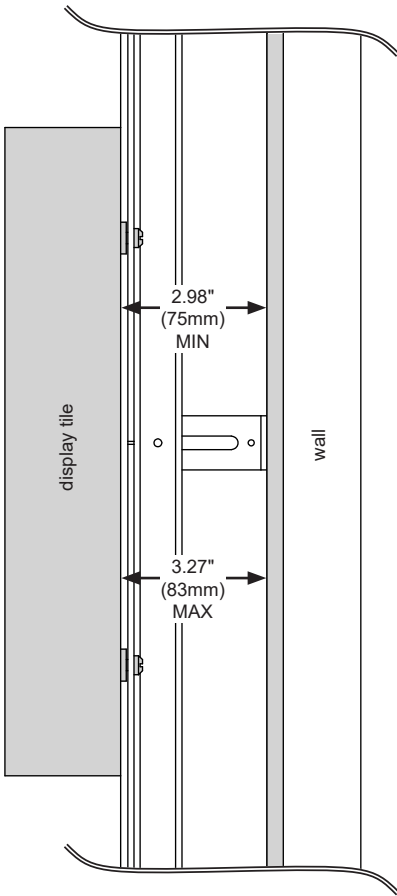
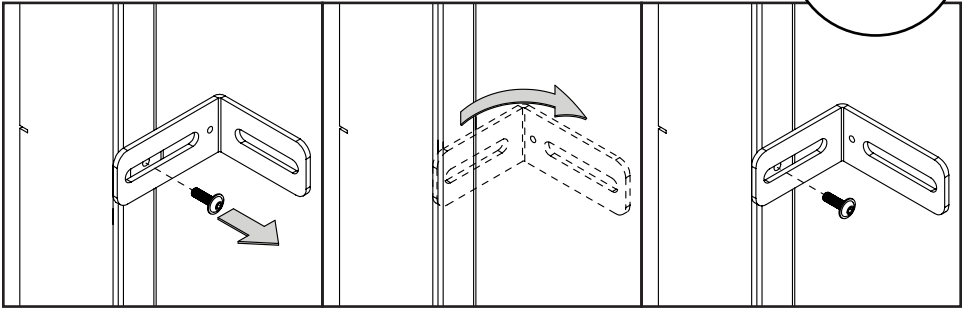
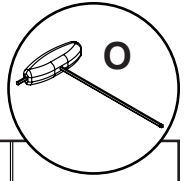

## 6-2

**ENG** Level L brackets and mark mounting holes on plywood (must be minimum Grade BC, 1/2" (13mm) thick.)

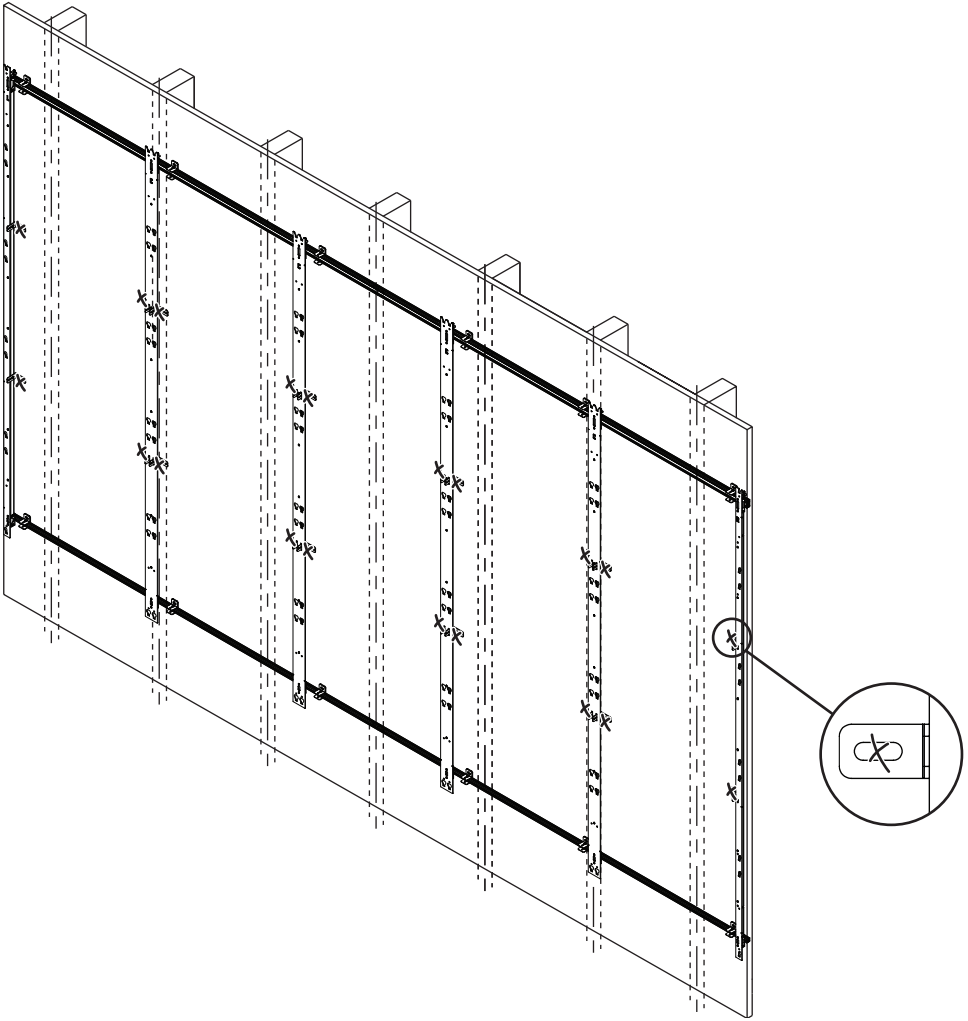
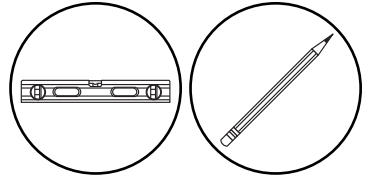

## 6-3

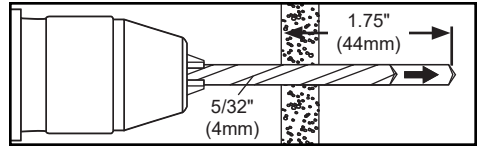
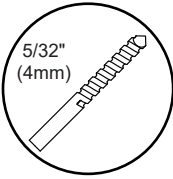

**ENG** Drill mounting holes into supporting surface (1.75" (44mm) minimum depth required).

## 6-4

**ENG** Level L brackets. Install using wood screws provided.

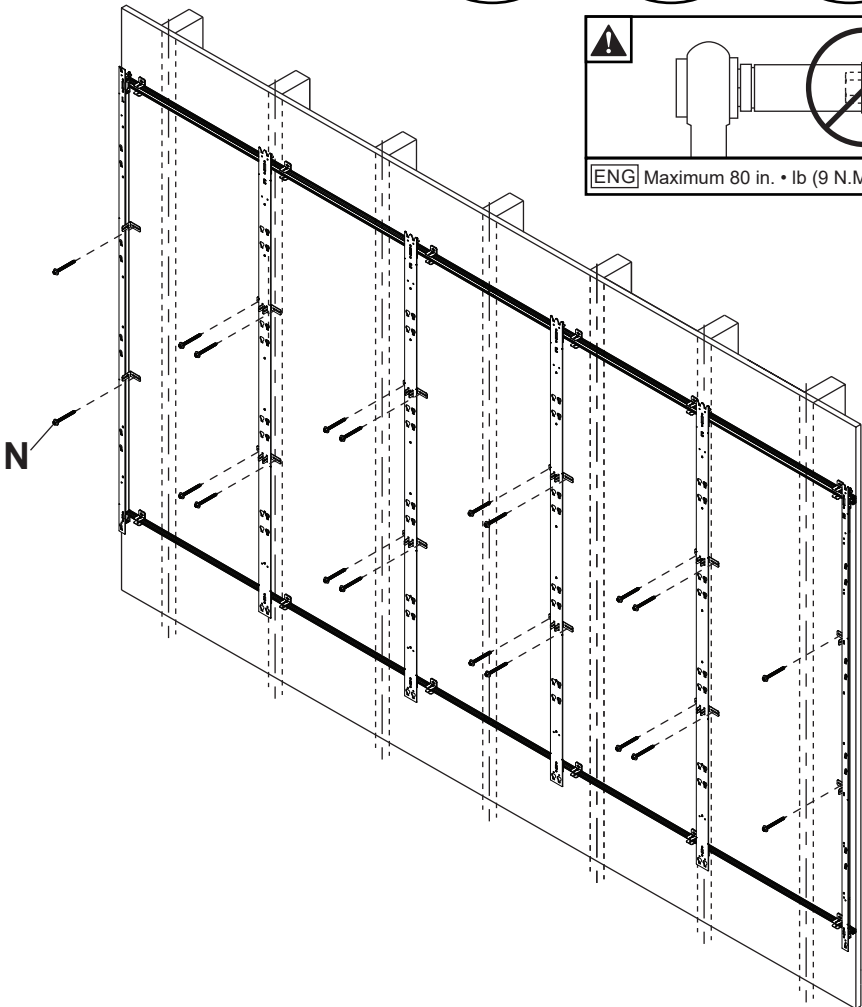
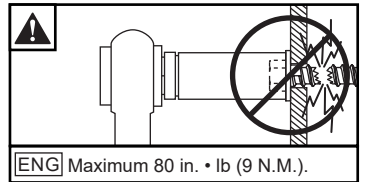
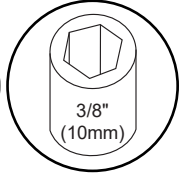
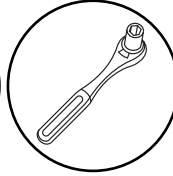
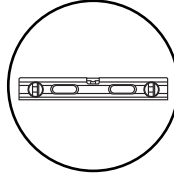

## 6-5

**ENG** Tie a string between center slots on outer column in order to level the depth of each vertical column.

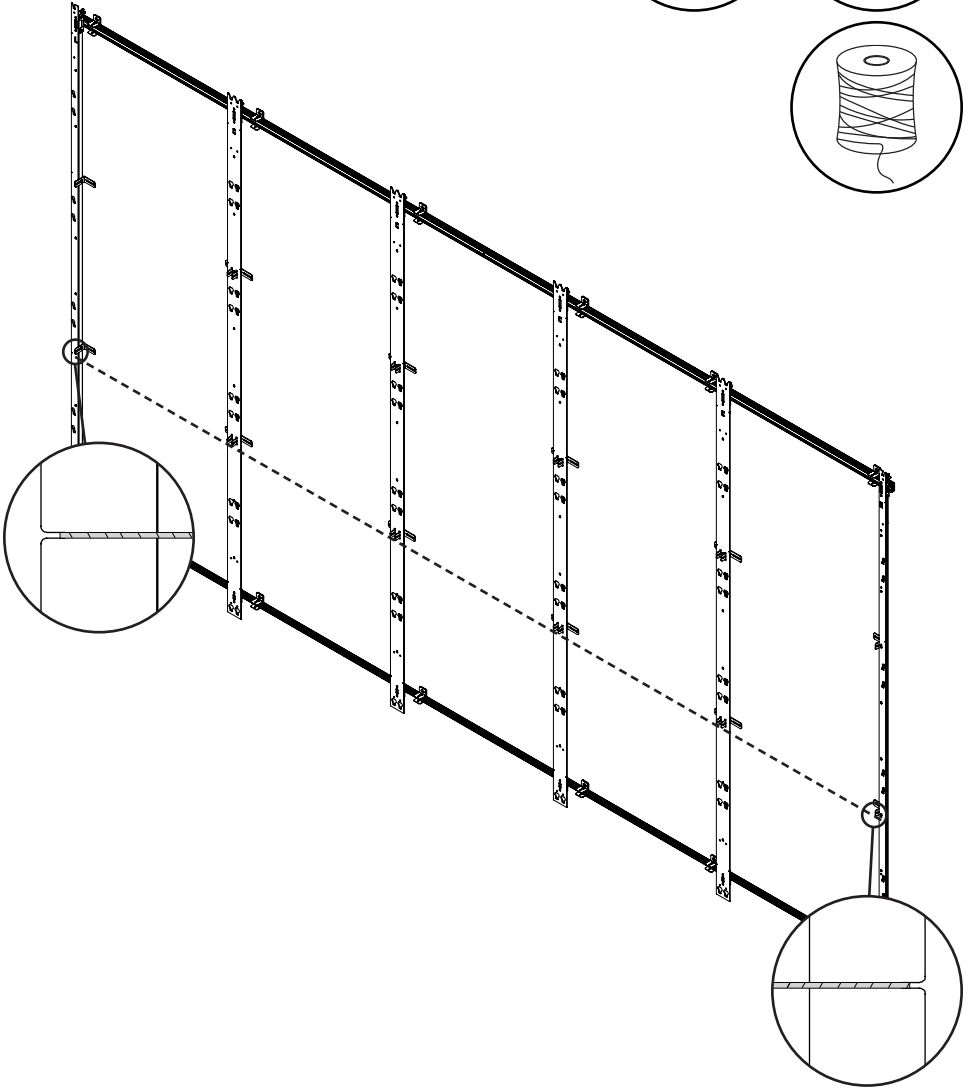
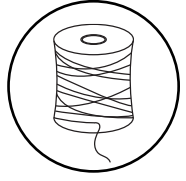
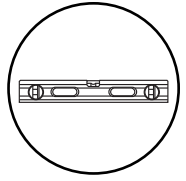
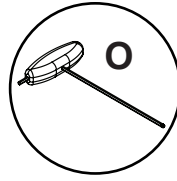

# 6-6

ENG Adjust depth, then remove string.

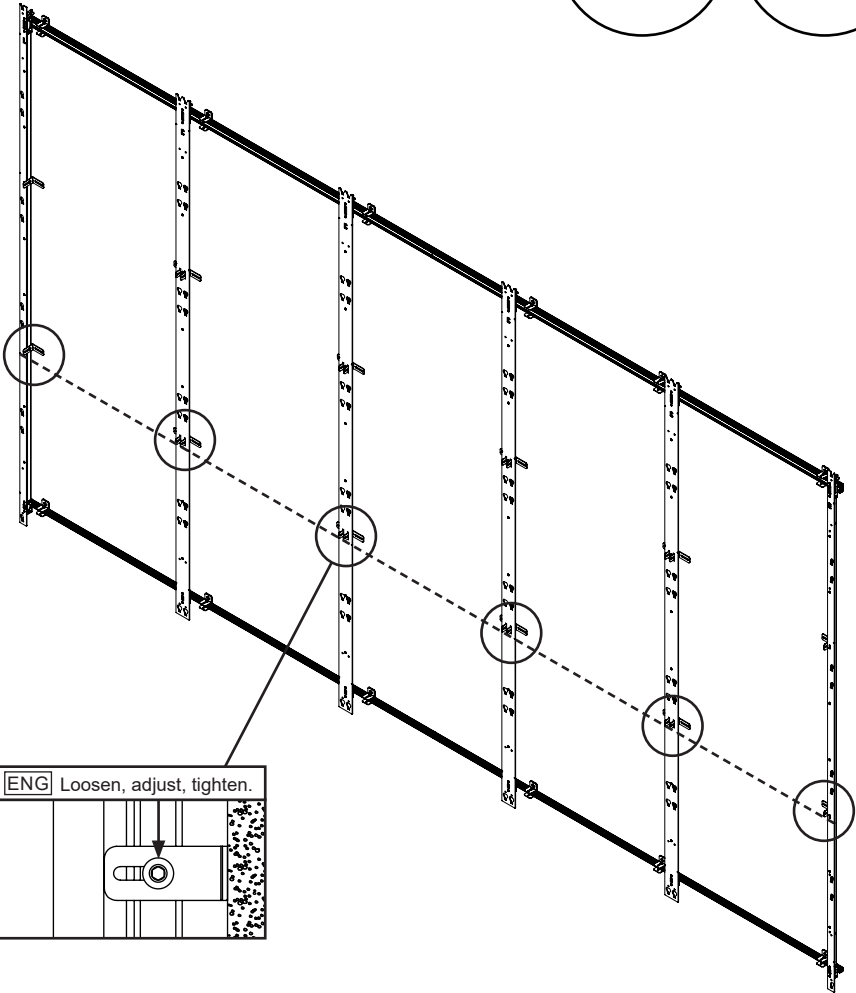
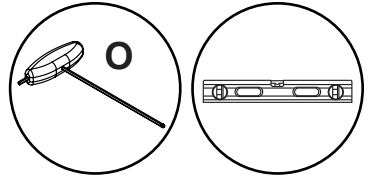

ENG Loosen, adjust, tighten.

7-1

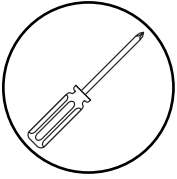

ENG Display not included.

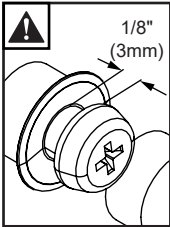
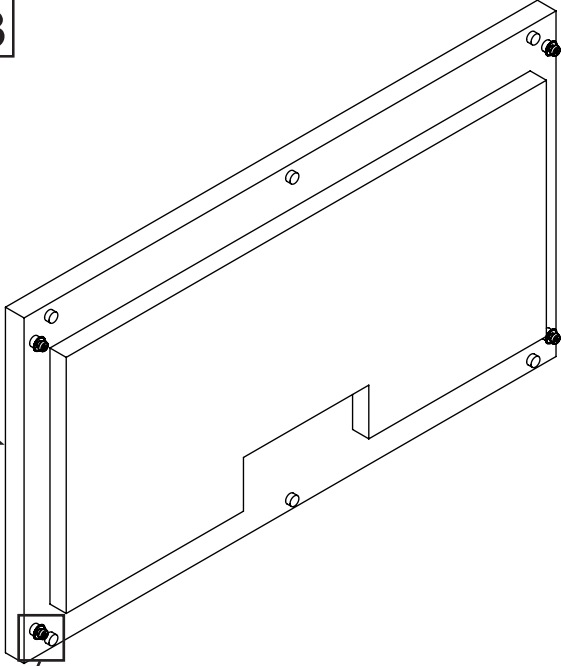



## 7-2

**ENG** Attach display, tighten connecting hardware, and run cables one at a time starting from the bottom left.

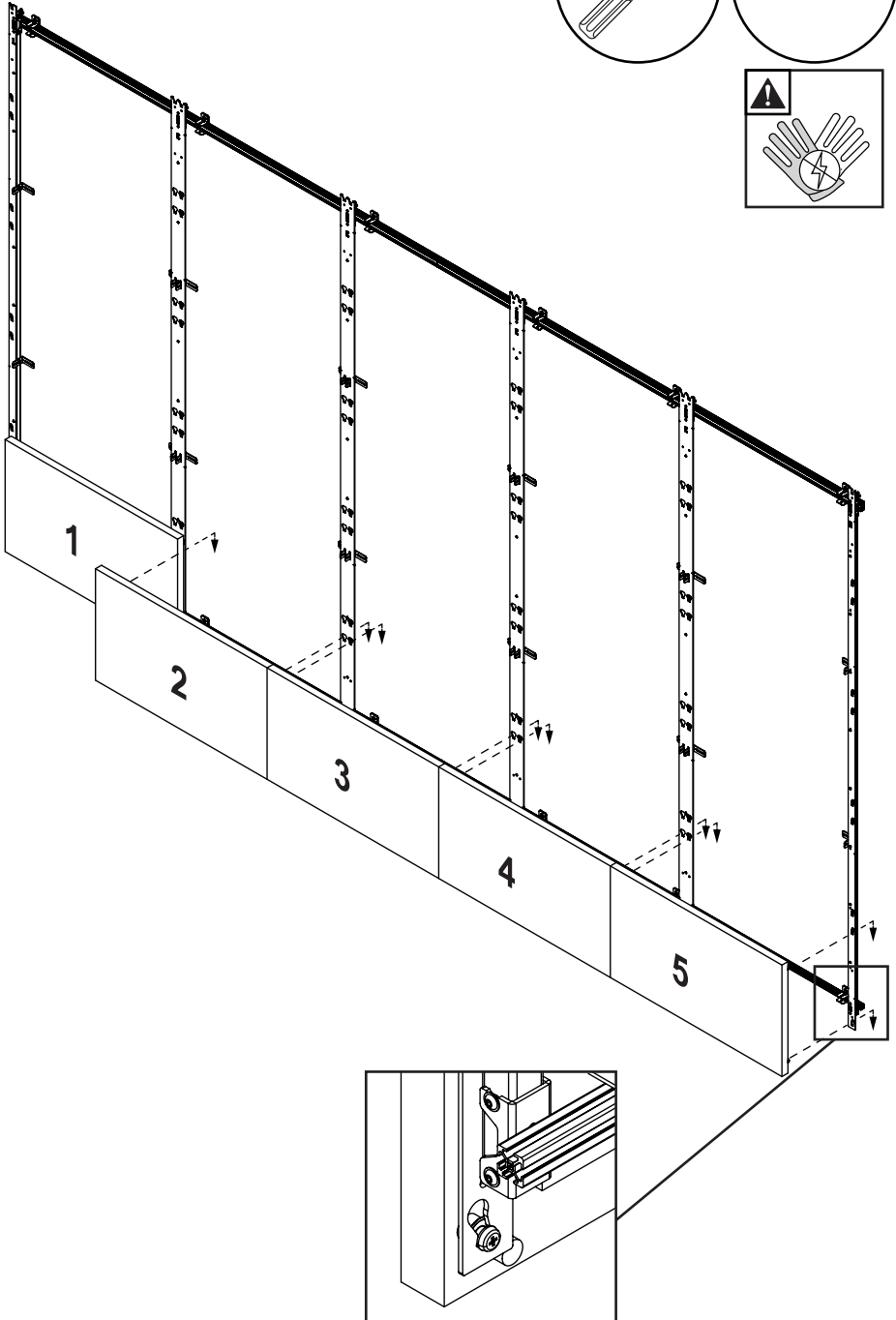
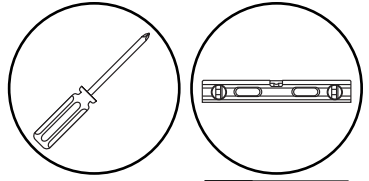

7-3

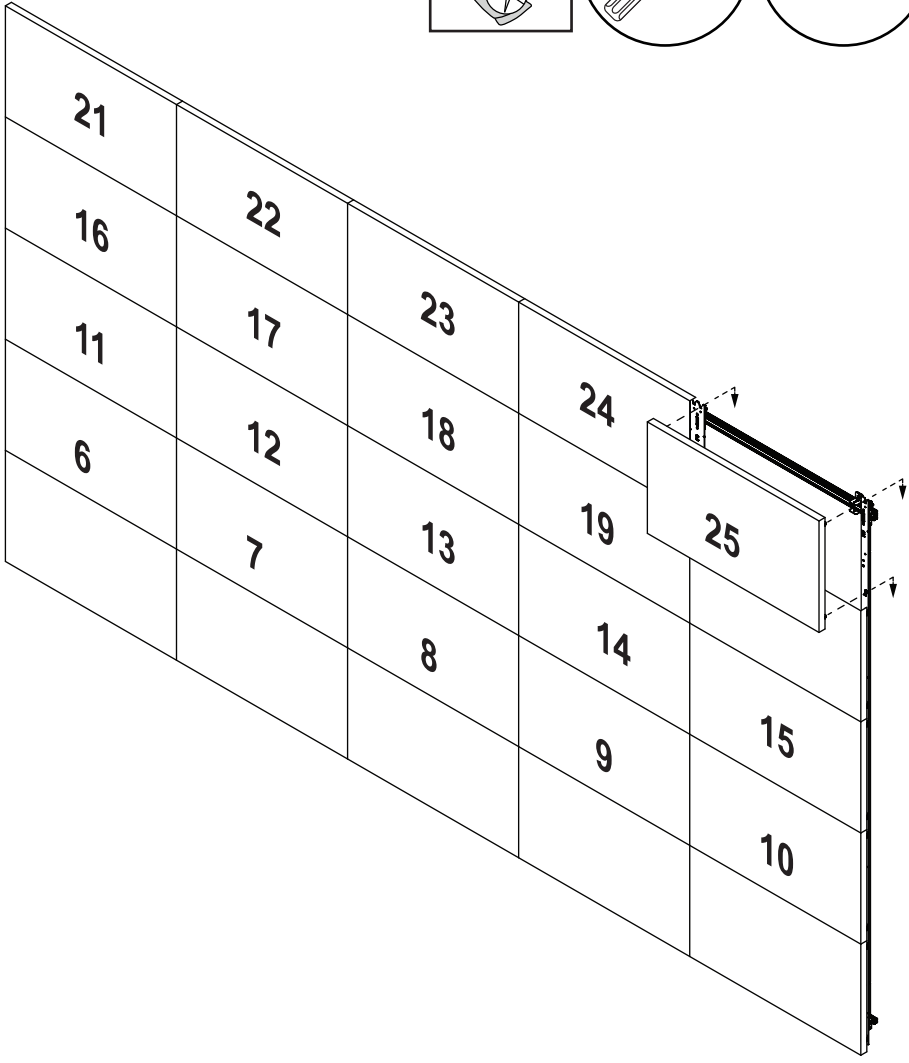
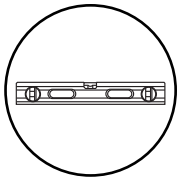
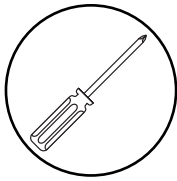
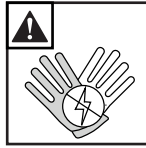

# 8

**ENG** To remove, start from the top right.

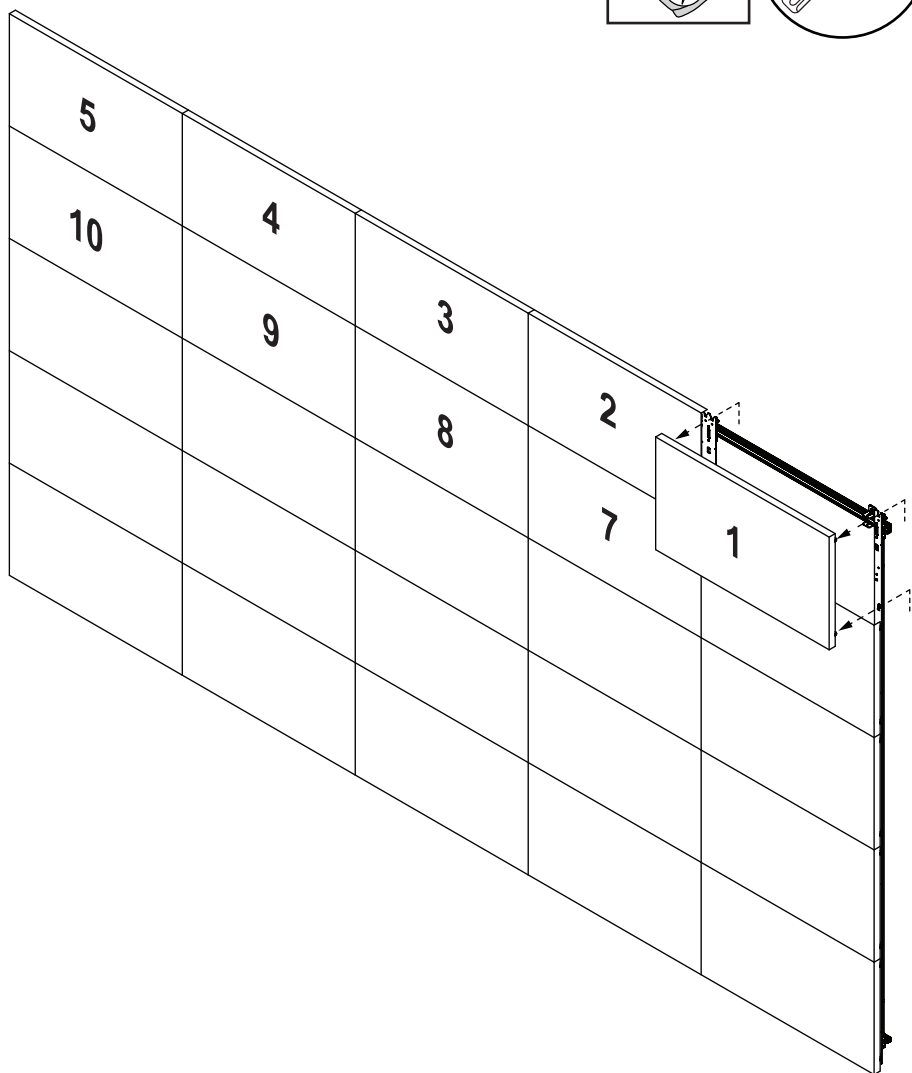
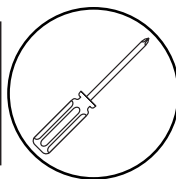
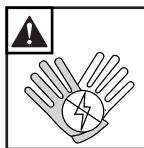

ENG Warranty  
ITL Garanzia

ESP Garantía  
ČES Záruka

FRN Garantie  
SLK Záruka

DEU Garantie  
POR Garantia

NEL Garantie  
TÜR Garanti

[www.peerless-av.com/warranty](http://www.peerless-av.com/warranty)

**peerless-AV<sup>®</sup>**

**Peerless-AV**

2300 White Oak Circle  
Aurora, IL 60502  
Email: [tech@peerlessmounts.com](mailto:tech@peerlessmounts.com)  
Ph: (800) 865-2112  
Fax: (800) 359-6500  
[www.peerless-av.com](http://www.peerless-av.com)

© 2020, Peerless Industries, Inc.

**Peerless-AV Europe**

Unit 3 Watford Interchange,  
Colonial Way, Watford, Herts,  
WD24 4WP, United Kingdom  
Customer Care  
44 (0) 1923 200 100  
[www.peerless-av.com](http://www.peerless-av.com)

© 2020, Peerless Industries, Inc.

**Peerless-AV América Latina**

Av. de las Industrias 413  
Parque Industrial Escobedo  
General Escobedo N.L., México 66062  
Servicio al Cliente  
01-800-849-65-77  
[www.peerless-av.com](http://www.peerless-av.com)

© 2020, Peerless Industries, Inc.