

Vess A7600 (VES0603)
Vess A7800 (VES0604)
Storage Appliance for Video Surveillance
Product Manual

Version 1.0

Also included are four levels of notices:



Warning

A Warning notifies you of probable equipment damage or loss of data, or the possibility of physical injury, and how to avoid them.



Caution

A Caution informs you of possible equipment damage or loss of data and how to avoid them.



Important

An Important message calls attention to an essential step or point required to complete a task, including things often missed.



Note

A Note provides helpful information such as hints or alternative ways of doing a task.



Warning

Turn off the power and disconnect the power cord before servicing this device.

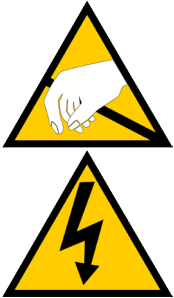

Warning

The electronic components within the Vess A7000 Series enclosure is sensitive to damage from Electro-Static Discharge (ESD). Observe appropriate precautions at all times when handling the Vess A7000 or its subassemblies.



Warning

- Use an approved power cord. If you have questions about the type of power cord to use, contact your PROMISE Technology, Inc. authorized service provider.
- If you have not been provided with a power cord for your product or for any AC-powered option intended for your product, purchase a power cord that is approved for use in your country.
- You must use a power cord rated for your product and for the voltage and current marked on the electrical ratings label of the product. The voltage and current rating of the cord must be greater than the voltage and current rating marked on the product.
- Do not pull on a cord or cable. When unplugging from the electrical outlet, grasp the cord by the plug.
- Make sure that the total ampere rating of all products plugged into an extension cord or power strip does not exceed 80 percent of the ampere ratings limit for the extension cord or power strip.
- Do not disable the power cord grounding plug. The grounding plug is an important safety feature.
- Plug the power cord into a grounded (earthed) electrical outlet that is easily accessible at all times.
- Only a qualified technician who is familiar with fix up service procedure should install and service the equipment.
- Verify that the external power source connected to your product matches the type of power source indicated on the electrical ratings label. If you are not sure of the type of power source required, consult your PROMISE Technology, Inc. authorized service provider or local power company.



為減少電擊或設備損壞的危險：

- 使用認可的電源線。如果您對使用的電源線類型有疑問，請聯繫喬鼎資訊授權的服務提供商。
- 如果沒有為您的產品或任何預期的交流電供電選項提供電源線對於您的產品，請購買經批准在您所在國家使用的電源線。
- 您必須使用適用於您的產品的電源線以及電氣上標註的電壓和電流產品的評級標籤。 電源線的電壓和電流額定值必須大於電壓和產品上標明的電流額定值。
- 請勿拉扯電線或電纜。 從電源插座上拔下插頭時，請抓住電源線。
- 確保所有插入延長線或配電盤的產品的總額定電流值不超過延長線或電源插座的安培額定值的80%。
- 請勿禁用電源線接地插頭。 接地插頭是一個重要的安全功能。
- 將電源線插入隨時可輕鬆接地的接地（接地）電源插座。
- 只有熟悉維修程序的合格技術人員才能安裝和維修設備。

如果您不確定所需的電源類型，請諮詢喬鼎資訊授權的服務提供商或當地的電力公司。

Federal Communications Commission notice

Class A equipment

This equipment has been tested and found to comply with the limits for a Class A digital device, pursuant to Part 15 of the FCC rules. These limits are designed to provide reasonable protection against harmful interference when the equipment is operated in a commercial environment. This equipment generates, uses, and can radiate radio frequency energy and, if not installed and used in accordance with the instructions, may cause harmful interference to radio communications. Operation of this equipment in a residential area is likely to cause harmful interference, in which case the user will be required to correct the interference at personal expense

Modification

This device complies with Part 15 of the FCC Rules. Operation is subject to the following two conditions: (1) this device may not cause harmful interference, and (2) this device must accept any interference received, including interference that may cause undesired operation.

Industry Canada Regulatory Compliance Notices

Avis de conformité à la réglementation d'Industrie Canada

This Class A digital apparatus complies with Canadian ICES-003.

Cet appareil numérique de la classe A est conforme à la norme NMB-003 du Canada.

Notices for New Zealand and Australia

Class A equipment

This is a Class A product. In a domestic environment this product may cause radio interference in which case the user may be required to take adequate measures.

Notices for European Union

This product is in conformity with the protection requirements of EU Council Directive 2014/30/EU on the approximation of the laws of the Member States relating to electromagnetic compatibility. PROMSIE Technology, INC. cannot accept responsibility for any failure to satisfy the protection requirements resulting from a non-recommended modification of the product, including the fitting of non-PROMISE option cards.

This product has been tested and found to comply with the limits for Class A Information Technology Equipment according to CISPR 32/European Standard EN 55032. The limits for Class A equipment were derived for commercial and industrial environments to provide reasonable protection against interference with licensed communication equipment.

This is a Class A product. In a domestic environment this product may cause radio interference in which case the user may be required to take adequate measures.

The point of contact for regulatory matters is PROMISE TECHNOLOGY EMEA, Science Park Eindhoven 5228, 5692 EG Son, The Netherlands.

Office Hours

8:30 am - 5:00 pm (The Netherlands)

A급기기
(업무용 방송통신기기)

이 기기는 업무용 환경에서 사용할 목적으로 적합성평가를 받은 기기로서 가정용 환경에서 사용하는 경우 전파간섭의 우려가 있습니다.

この装置は、クラスA機器です。この装置を住宅環境で使用すると電波妨害を引き起こすことがあります。この場合には使用者が適切な対策を講ずるよう要求されることがあります。

VCCI - A

製品には、同梱された電源コードをお使い下さい。
同梱された電源コードは、他の製品では使用出来ません。

警告使用者：

這是甲類的資訊產品，在居住的環境中使用時，可能會造成射頻干擾，在這種情況下，使用者會被要求採取某些適當的對策。

設備名稱：磁碟陣列儲存系統 Equipment name		型號（型式）： VES0603、VES0604 Type designation (Type)				
單元 Unit	限用物質及其化學符號 Restricted substances and its chemical symbols					
	鉛Lead (Pb)	汞 Mercury (Hg)	鎘 Cadmium (Cd)	六價鉻 Hexavalent chromium (Cr+6)	多溴聯苯 Polybrominated biphenyls (PBB)	多溴二苯醚 Polybrominated diphenyl ethers (PBDE)
電路板	—	○	○	○	○	○
外殼	—	○	○	○	○	○
線材	○	○	○	○	○	○
電源供應器	—	○	○	○	○	○
電池	—	○	○	○	○	○
備考1. “超出0.1 wt %” 及 “超出0.01 wt %” 係指限用物質之百分比含量超出百分比含量基準值。 Note 1: “Exceeding 0.1 wt %” and “exceeding 0.01 wt %” indicate that the percentage content of the restricted substance exceeds the reference percentage value of presence condition.						
備考2. “○” 係指該項限用物質之百分比含量未超出百分比含量基準值。 Note 2: “○” indicates that the percentage content of the restricted substance does not exceed the percentage of reference value of presence.						
備考3. “—” 係指該項限用物質為排除項目。 Note 3: The “—” indicates that the restricted substance corresponds to the exemption.						

INTRODUCTION	1
SPECIFICATIONS	2
HARDWARE.....	4
FRONT PANEL HARDWARE	4
FRONT OF VESS A7600	5
FRONT OF VESS A7800	6
FRONT PANEL LEDs	7
REAR PANEL HARDWARE	9
VESS A7000 REAR PANEL COMPONENTS.....	9
VESS A7000 REAR PANEL LED INDICATORS	11
VESS A7000 REAR PANEL CONNECTIONS.....	11
HARDWARE SETUP	12
UNPACKING	13
PACKING LIST.....	13
MOUNTING THE ENCLOSURE IN A RACK.....	14
MOUNTING ENCLOSURE IN A RACK	15
INSTALLING OR REMOVING THE SECURITY COVER	18
INSTALLING DISK DRIVES	19
NUMBER OF DRIVES REQUIRED	19
DRIVE SLOT NUMBERING	20
REMOVING THE DRIVE CARRIER	21
INSTALLING 3.5" DISK DRIVE IN THE CARRIER	22
INSTALLING 2.5" DISK DRIVE IN THE CARRIER	23
MANAGEMENT PATH CONNECTION	24
CONNECT THE POWER	25
POWER ON ENCLOSURE.....	26
FRONT PANEL LED BEHAVIOR.....	27

PROMISE MANAGEMENT GUI	28
LOGGING INTO PROMISE MANAGEMENT GUI	28
LOGGING IN AT THE ENCLOSURE.....	28
LOGGING IN OVER THE NETWORK	29
LOGIN SCREEN	31
USING THE PROMISE MANAGEMENT GUI INTERFACE	32
USING THE HEADER	33
USING TREE VIEW.....	33
USING MANAGEMENT VIEW	34
CHOOSING A DISPLAY LANGUAGE.....	34
VIEWING THE EVENT FRAME.....	35
LOGGING OUT OF PROMISE MANAGEMENT GUI	36
SUBSYSTEM MANAGEMENT	37
BACKGROUND ACTIVITIES	38
VIEW CURRENT BACKGROUND ACTIVITIES.....	38
VIEW BACKGROUND ACTIVITIES PARAMETERS SETTINGS	38
MANAGE BACKGROUND ACTIVITIES SETTINGS	39
REBUILD SETTINGS	40
BACKGROUND SYNCHRONIZATION	40
LOGICAL DRIVE INITIALIZATION	41
REDUNDANCY CHECK.....	42
PDM	43
TRANSITION	43
MEDIA PATROL.....	44
MANAGING ACTIVITY SCHEDULES	45
ADD OR DELETE AN ACTIVITY SCHEDULE.....	45
VIEW OR MODIFY AN EXISTING ACTIVITY SCHEDULE	45
EVENT LOGS	46
ADMINISTRATIVE TOOLS	47
RESTORE FACTORY DEFAULT SETTINGS.....	47
CLEAR STATISTICS.....	47

USER MANAGEMENT	48
VIEWING USER INFORMATION	48
MAKING USER SETTINGS	48
MAKING YOUR OWN USER SETTINGS	49
CHANGING YOUR OWN PASSWORD	49
CREATING A USER	50
LIST OF USER PRIVILEGES	51
DELETING A USER	51
VIEW NETWORK SETTINGS	52
SOFTWARE MANAGEMENT	52
IMPORTING A CONFIGURATION SCRIPT	53
EXPORTING A CONFIGURATION SCRIPT	54
SAVING A SERVICE REPORT	55
EMAIL SERVICE	57
STOP EMAIL SERVICE	57
RESTARTING EMAIL SERVICE	57
EMAIL SETTINGS	58
SENDING A TEST EMAIL MESSAGE	58
PERFORMANCE MONITORING	59
CONTROLLERS	61
VIEW CONTROLLER INFORMATION	61
VIEWING CONTROLLER STATISTICS	63
CONTROLLER SETTINGS	64
ENCLOSURES	65
LOCATE AN ENCLOSURE	65
ENCLOSURE INFORMATION	65
ENCLOSURE TEMPERATURE SENSOR SETTINGS	66
BUZZER SETTINGS	66
PHYSICAL DRIVES	67
DISK ARRAYS AND LOGICAL DRIVES	69
LOGICAL DRIVE MANAGEMENT	71
SPARE DRIVES	72
RUNNING SPARE CHECK	72
LOGICAL DRIVE SUMMARY	73

MAINTENANCE 74

REPLACING A POWER SUPPLY 75

REMOVING THE POWER SUPPLY UNIT 75

FAQ..... 76

TROUBLESHOOTING..... 77

HOW DO I KNOW WHEN A DRIVE IS FAILING? 78

CHECK DRIVE STATUS LEDs 78

 CHECK DRIVE STATUS IN MANAGEMENT GUI..... 80

ANTICIPATING HARD DRIVE PROBLEMS..... 81

REBUILDING A DISK ARRAY 83

HOW TO REBUILD A DISK ARRAY 84

HOW TO SAVE A SERVICE REPORT..... 86

THE ALARM BUZZER IS SOUNDING, WHAT DOES THIS MEAN? 88

 HOW TO DISABLE THE ALARM BUZZER 89

APPENDIX: GRAPHICS CARD INSTALLATION..... 90

APPENDIX: DRIVER INSTALLATION AND UPDATE 95

UPDATE/INSTALLATION REQUIREMENTS 95

 USB FLASH DRIVE 95

UPDATE/INSTALL THE DRIVER 95

INTRODUCTION

The Vess A7000 Series Storage Appliance for Video Surveillance is specially engineered for medium to large scale IP video surveillance deployment. The Vess A7000 Series is ideally suited for continuous surveillance in banks, malls, casinos, factories, warehouses, and similarly sized commercial, residential, governmental or private enterprises. The subsystems are capable of continuous recording and playback operation without dropping frames for networked installations of 32 to 100 High-Definition IP cameras.

Vess A7000 Series Storage Appliance for Video Surveillance are available with the Windows operating system, a Video Management Software suite, and disk drives in order to streamline the installation and integration process. The Vess A7000 Series subsystems are stand-alone devices with internal RAID storage, eliminating need for additional servers, controllers, separate enclosures etc. The Vess A7000 Series uses a thoroughly tested and proven RAID engine for maximum reliability, all drive bays are hot-swappable, and models are available with redundant power supplies to ensure data safety and uninterrupted operation.

The Vess A7000 models include PCIe slots for added flexibility. The PCIe slots are suitable for video graphics cards, video encode/decode cards, RAID cards, or other useful functions available on the PCIe platform.

Storage capacity can be scaled up with the VTrak J5000 Series storage system. Up to five JBODs can be added.

SPECIFICATIONS

Model	Vess A7600	Vess A7800
General		
Form Factor	3U, 19" rack mount	4U, 19" rack mount
Function	Storage Appliance for Video Surveillance	
Drives	Sixteen 3.5" HDD 3.5" SAS (6Gb/s or 12Gb/s) 2.5" SAS (6Gb/s or 12Gb/s)	Twenty-four HDD 3.5" SAS (6Gb/s or 12Gb/s) 2.5" SAS (6Gb/s or 12Gb/s)
Controller	Single	
Network	Two Gigabit Ethernet RJ-45 ports (1000Base-T), one IPMI LAN port	
System Processor	E5-2603v4 /E5-2609v4 for A7600h/A7800h in default (E5-2600v4 series capable up to 2640v4 for Reliability test) , Broadwell-EP	
System Memory	Default in 8GB (Maximum 256/512 GB) @ DDR4 ECC RDIMM/LRDIMM	
Internal Built-in Storage	128GB M.2	
Number of HDD Supported	SAS and iSCSI (144 through SAS 4U24 JBOD per system in terms of 4U24 Head)	
USB Ports	Front: two USB 2.0 / Rear: four USB 2.0, two USB 3.0	
PCI Express	PCIe 3.0 x 16 - 4 slots (PCIE1/PCIE3: x16x0 or x8/x8, PCIE5/PCIE7: x16x0 or x8/x8) PCIe 3.0 x 8 - 1 slot (PCIE4: x8 or x4 with mini PCIe x4) mini PCIe - 1 (support M.2 (Full and Half size)) (x4)	
Graphics	1+1 (one wide @ nVidia 1000 series+ 1 Narrow @ nVidia Tesla)	2+1 (Two wide @ nVidia 1000 series+ 1 Narrow @ nVidia)
Serial Port	1 (Internal COM port)	
Audio & Microphone	3x 3.5mm Audio Jack	

Model	Vess A7600	Vess A7800
RAID		
RAID Levels Supported	0, 1, 1E, 3, 5, 6, 10 (0+1), 30, 50, 60	
Hot Spares	Multiple global or dedicated hot-spare drives with revertible option	
Maximum LUNs per System/Array	256/32	
Software		
Supported OS (64-bit)	Windows 10 in default. Windows Server 2012/2016R2	
Management	Graphical UI/SNMP via Ethernet, CLI/CLU via Ethernet, OPAS Service via USB, IPMI, SDK or API	
Event Notification	Email, SNMP, Buzzer, LEDs	
System		
AC Input	100 ~ 240 VAC, 60 ~ 50Hz	
Current (Maximum)	8-4A (550W, 8A/100V, 4A/240V) , 10A (800W-Vess A7800)	
Power Supply	550W (1+1@550W) in default. 1100W (2+1@550W) optional	1100W (2+1@550W) in default. 1600W(2+1@800W)
Fan	Non-swappable	
Temperature	5° ~ 40°C (-40° ~ 60°C non-operational)	
Relative Humidity	Operational: 10% to 80% (Non-Condensing) Non-Operational: 10% to 95% (Non-Condensing)	
Dimensions (H x W x D)	131 x 447 x 503mm	173 x 447 x 503mm
Safety/EMI	CE, FCC, VCCI, BSMI, RCM, CB, KCC, TUV CB, cTUVus	
Warranty	3 years limited warranty	

HARDWARE

The following section provides a summary of the front and back panel hardware features of Vess A7600, and Vess A7800 Storage Appliance for Video Surveillance. These enclosures are referred to collectively as Vess A7000 enclosures, Vess A7000 units or Vess A7000 subsystems throughout this document when the content applies to all models in the Promise Vess A7000 Series.

FRONT PANEL HARDWARE

The front panel of Vess A7000 enclosures provide access to drives carriers. Vess A7000 units are shipped with secure covers to protect the drive carriers from being unintentionally removed.

For all Vess A7000 enclosures, defective drives can be replaced without interruption of data availability to the host computer. If so configured, a hot spare drive will automatically replace a failed drive, securing the fault-tolerant integrity of the logical drive. The self-contained hardware-based RAID logical drive in the Vess A7000 provides maximum performance in a compact external enclosure.

FRONT OF VESS A7600

The Vess A7600 enclosure features handles on each side used to secure the enclosure to an equipment rack. The system power button and two USB ports are located on the left side, and most of the front LED indicators are located on the right side.

Vess A7600 front view with secure cover

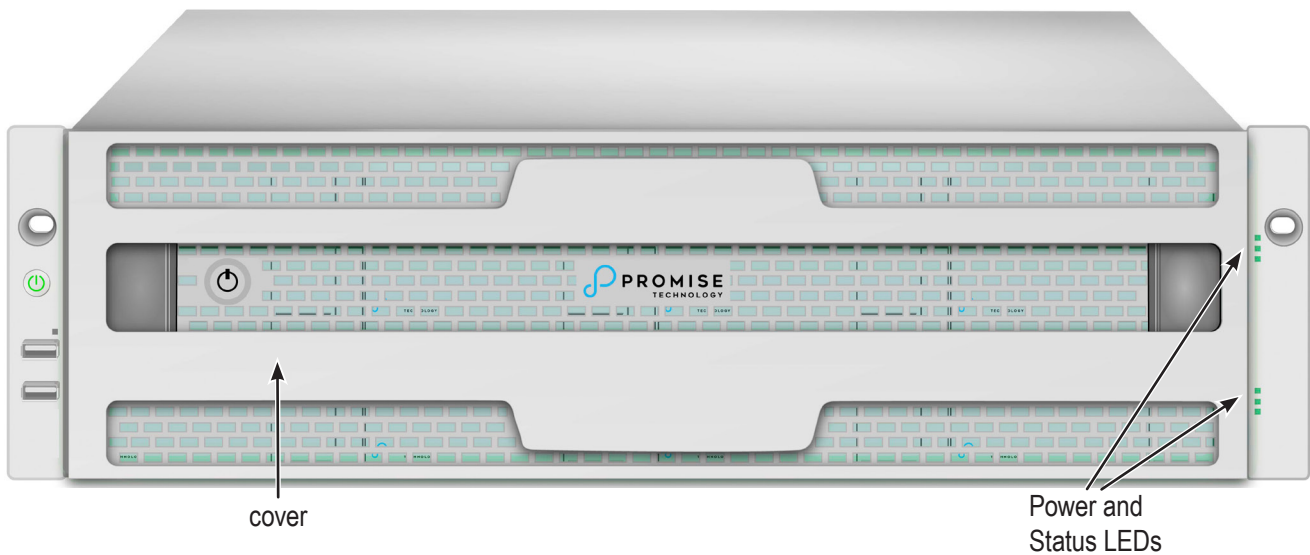

Vess A7600 front view without cover

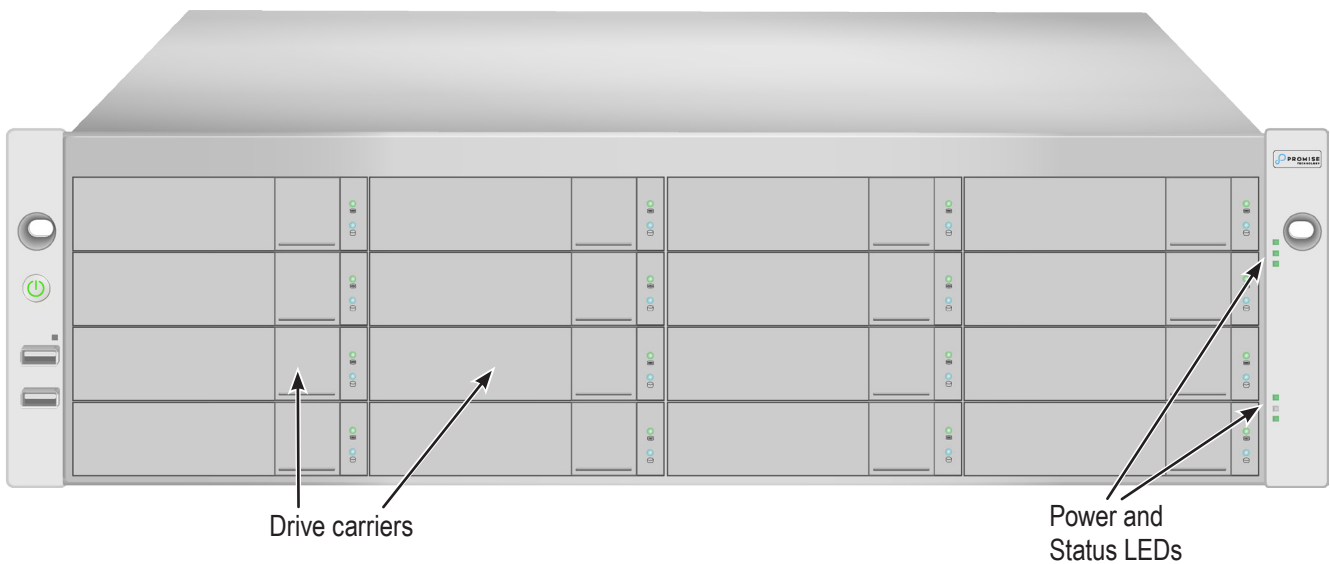

FRONT OF VESS A7800

The front panel hardware components on the Vess A7800 are the same as the Vess A7600.

Vess A7800 front view with secure cover

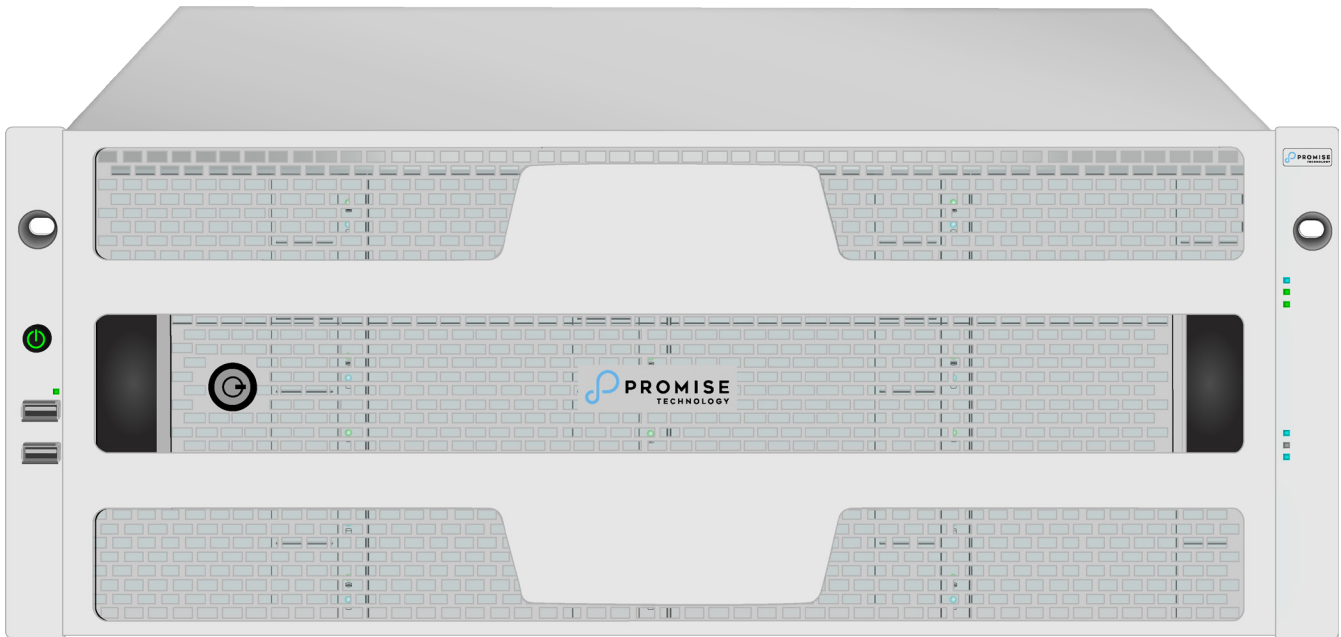

Vess A7800 front view without cover

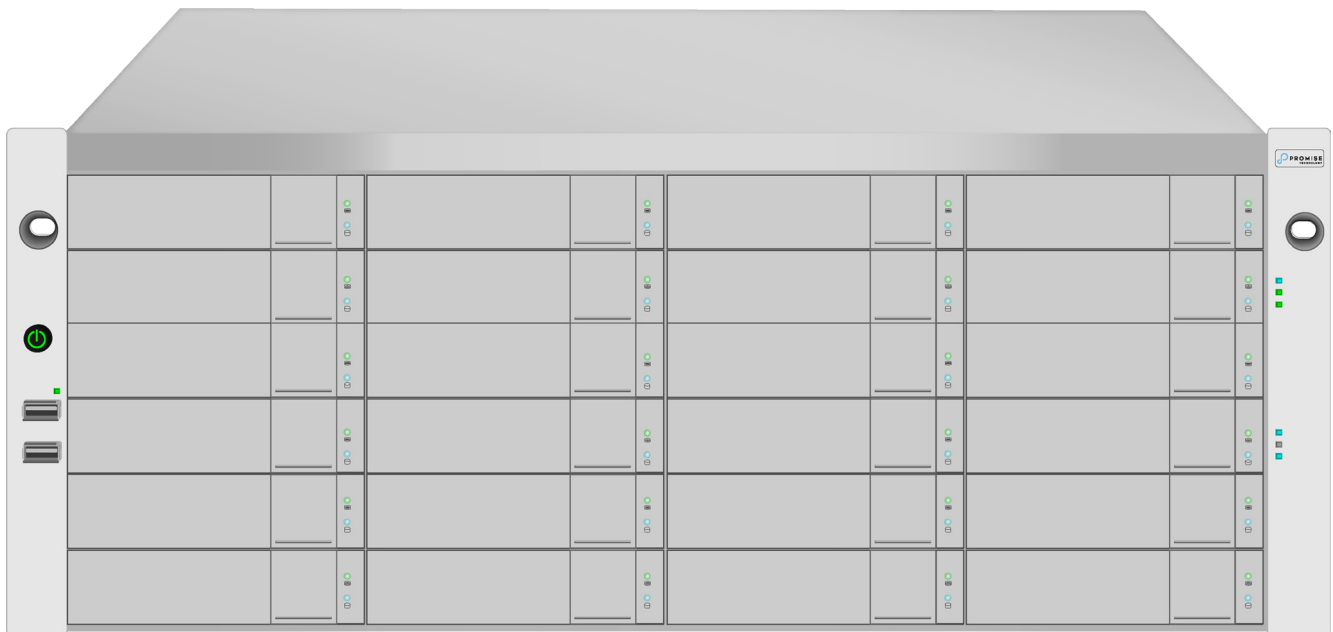

FRONT PANEL LEDs

Descriptions of the LED behavior and function for Vess A7000 enclosures.

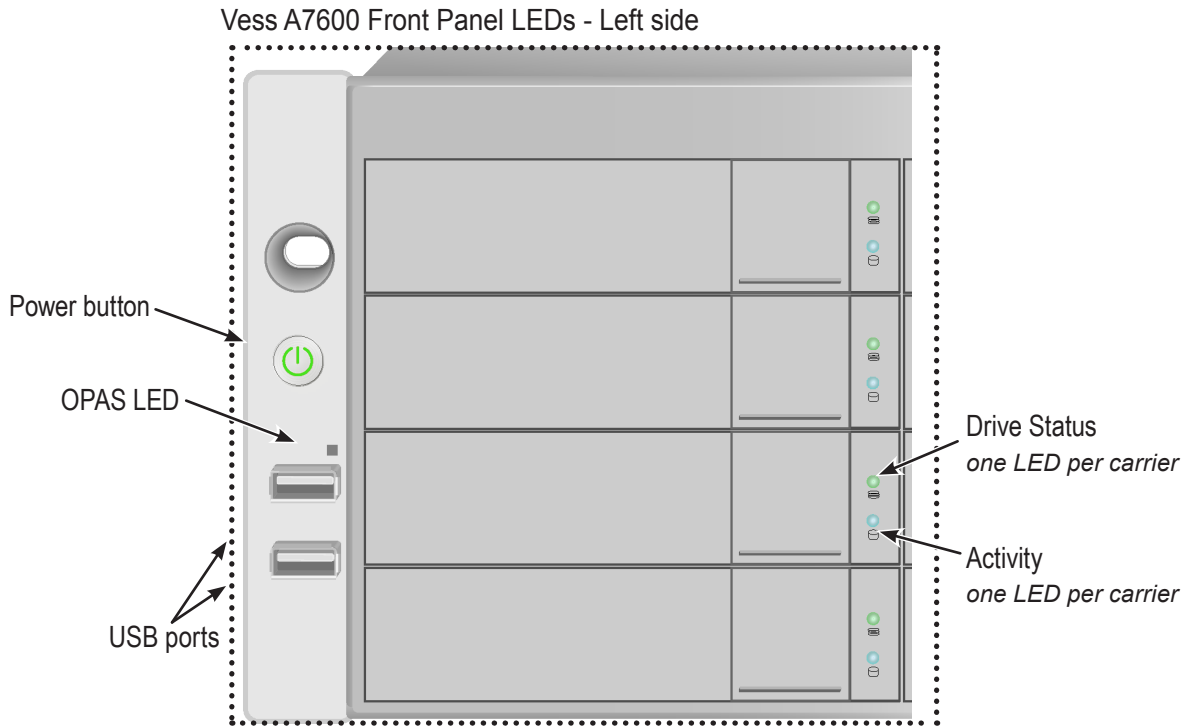

Left side LED behavior for the Vess A7000

LED	Description
OPAS USB	Lights GREEN if an OPAS device (USB disk) is detected, RED if the OPAS operation has failed, blinks GREEN when an OPAS operation is in progress.
Drive Carrier LEDs (located on all drive carriers)	
Drive Status	Each drive carrier has two LEDs on the right side of the front, the Drive Status LED located above the Activity LED. The Drive Status LED displays GREEN when a drive is configured and working properly. When the lights are RED the HDD requires manual replacement. ORANGE indicates background RAID activity on this particular HDD, no user action is required.
Drive Activity	Steady BLUE when HDD link is established, flashes BLUE during drive activity.

Vess A7600 Front Panel LEDs - Right side

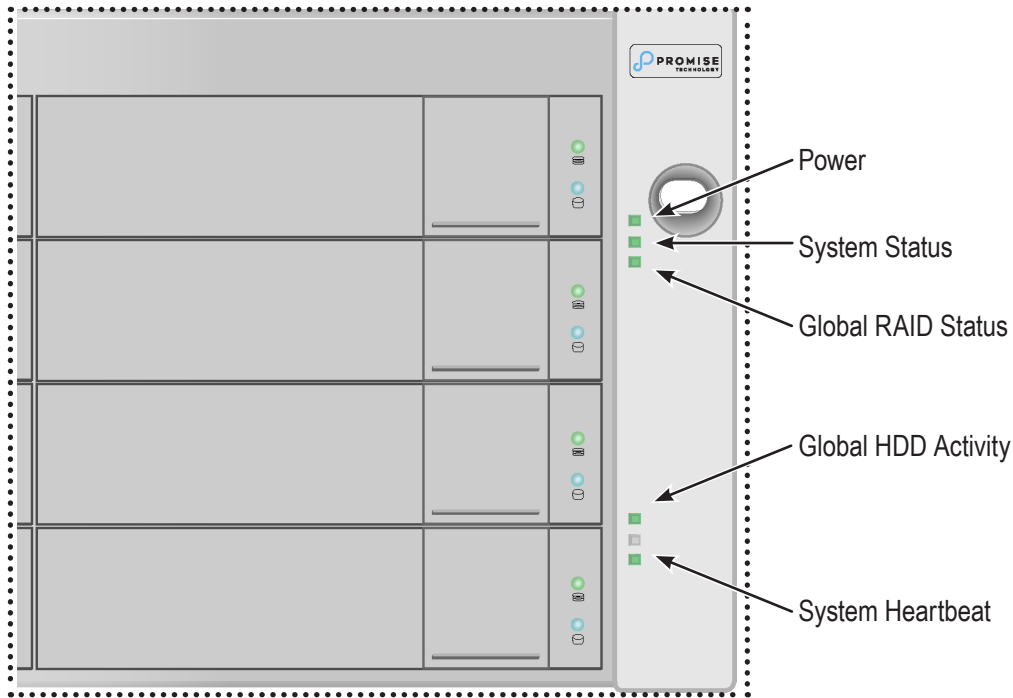

Right side LED behavior for the Vess A7000.

LED	Description
Power	Lights BLUE to indicate the system is powered on. Blinks BLUE in shutdown mode.
System Status	Lights GREEN when healthy, RED if there is a critical problem (LD offline, fan malfunction, voltage out of range, system temperature alert), blinks RED for HDD high temperature alert remains dark when not ready.
Global RAID Status	Lights GREEN when healthy or RED if any RAID volume is offline, ORANGE for critical state of any logical drive.
Global HDD Activity	Blinks BLUE to indicate one or more drives are being accessed, remains dark when no drives are being accessed.
System Heartbeat	Flashes BLUE slowly at regular intervals to indicate the firmware and software are operating normally.

REAR PANEL HARDWARE

The rear panel of the Vess A7000 enclosures provide access to the hot-swappable power supplies, local management connection (via USB keyboard and VGA or HDMI monitor port), iSCSI (Ethernet) data ports, some units also provide I/O connections for audio sensor and alarm systems. The back panel includes two system fans.

VESS A7000 REAR PANEL COMPONENTS

The Vess A7600 enclosure features two hot-swappable power supplies (PSU). The Vess A7800 enclosure has three hot-swappable power supplies.

Vess A76000/A7800 rear panel components

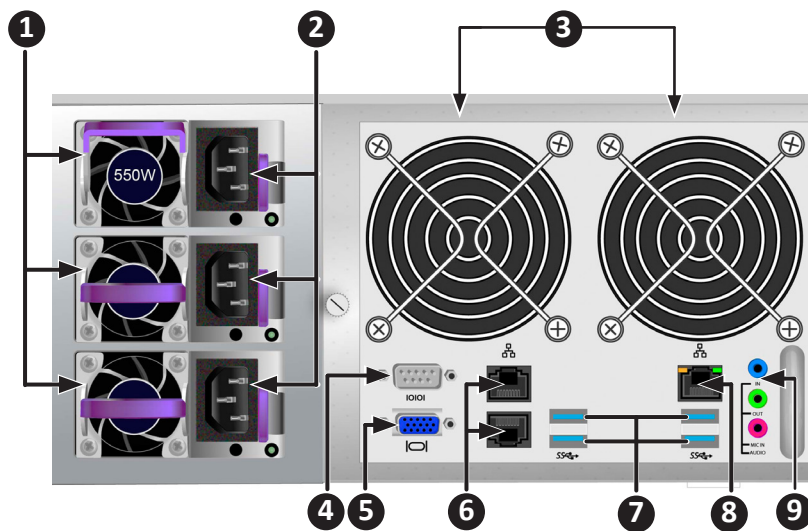

1	PSU fan vents
2	Power inserts
3	System fan vents
4	Serial port (COM1)
5	VGA port
6	1000BASE-T RJ-45 ports (2 ports)
7	USB 3.0 ports (4 ports)
8	RJ-45 IPMI LAN port
9	Audio In/Out ports

The rear panel of the Vess A7800 is nearly identical to the Vess A7600, except it is taller and has three power supplies. *The form factor of the Vess A7800 is 4U, the Vess A7600 form factor is 3U.*

Vess A7600 rear view

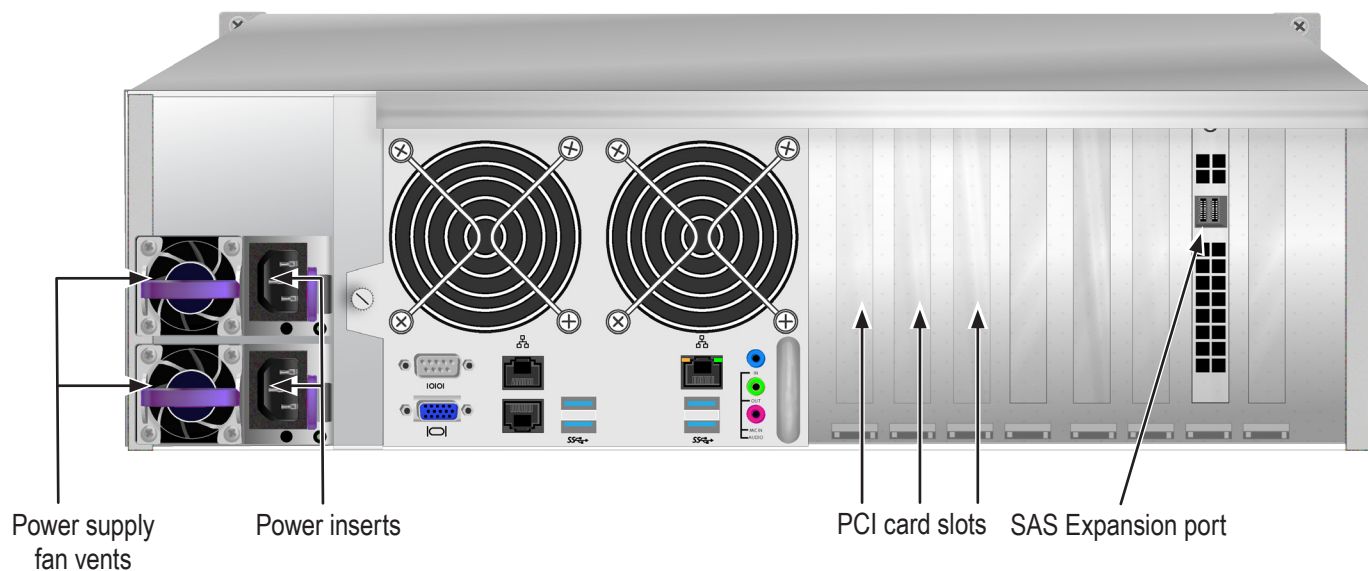

Vess A7800 rear view

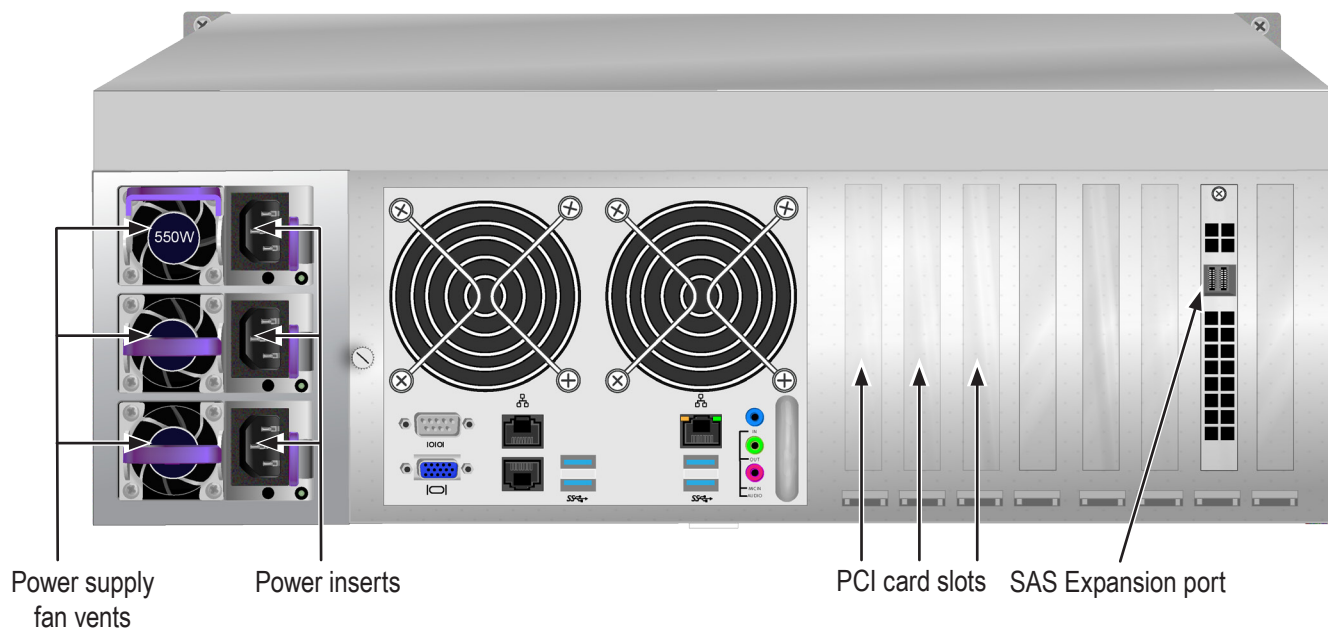

VESS A7000 REAR PANEL LED INDICATORS

The LEDs on the rear panel include LEDs for Ethernet data ports and an LED for each of the hot-swappable PSUs.

LED	Description
Ethernet Link/Act and Speed	The LED located above each port, on the left side, lights ORANGE when connected, flashes ORANGE when there is activity on the port and remains dark no connection has been established. The LED above and on the right of each port indicates connection speed, ORANGE is 100 Mbps, GREEN is 1000 Mbps, dark is 10 Mbps.
PSU	Each power supply LED lights GREEN to indicate normal operation. A RED LED indicates a problem or unit failure.

VESS A7000 REAR PANEL CONNECTIONS

Access to physical data and management connections are located on the back panel of the Vess A7000 including the optional I/O connections for sensor and alarm systems.

Feature	Description
D-sub VGA	This is also used for a video out connection for VGA monitors, it is also used to view the management interface.
Display Port	This is also used for a video out connection for Display Port monitors, it is also used to view the management interface.
DVI	This is also used for a video out connection for DVI monitors, it is also used to view the management interface.
HDMI	Provides video out connection for HDMI enabled monitors used to view the management interface.
USB	Use to connect to a USB keyboard for managing the Vess A7000 Series, or use it to transfer data to or from a USB memory device. There are four USB 2.0 ports and two USB 3.0 ports.
Audio In	Use for input from a peripheral audio device, such as a microphone. Plug-In Power microphones are supported.
Audio Out	Use for output (line out) peripheral audio device (speakers, for example).
Audio Mic	Use for microphone.

HARDWARE SETUP

This chapter presents the basics on unpacking, setting up hardware for the Vess A7000. Hardware installation includes installing the unit in an equipment rack, connecting the power, making network, data and management connection to the device, and installing hard drives.

The sections in Hardware Setup include the following:

- “Unpacking”
- “Mounting the Vess A7000 in a rack”
- “Installing Disk Drives”
 - “Number of Drives Required”
 - “Installing or removing the security cover”
 - “Drive Slot Numbering”
 - “Vess A7000 drive carriers”
- “Management Path Connection”
- “Connect the Power”
- “Power On Enclosure”
- “Connect to iSCSI Storage Area Network (SAN)”

UNPACKING

**Note**

The Vess A7000 Series can accommodate SATA (6Gbps) or SAS (12Gbps/6Gbps) hard drives.

PACKING LIST

The **Vess A7000** box contains the following items:

- One of the following storage appliances:
 - Vess A7600 16-bay
 - Vess A7800 24-bay
- Screws for disk drives

- Three 1.5m (4.9 ft) power cords
- Sliding rail assembly for rack mounting (optional)
- Front panel bezel cover

MOUNTING THE ENCLOSURE IN A RACK

The instructions here apply to 3U 16-bay Vess A7600, as well as the 4U 24-bay Vess A7800. The sliding rail rack mounting hardware is the same for both form factors.

Cautions



- Do not populate any unit with hard drives until it has been securely installed in the rack.
 - At least two persons are required to safely lift, place, and attach the Vess A7000 unit into a rack system.
 - Do not lift or move the Vess A7000 unit by the handles, power supplies or the controller units. Hold the system itself.
 - Do not install the Vess A7000 unit into a rack without rails to support the system.
 - Only a qualified technician who is familiar with the installation procedure should mount and install the Vess A7000 unit.
 - Mount the rails to the rack using the appropriate screws and flange nuts, fully tightened, at each end of the rail.
 - Do not load the rails unless they are installed with screws as instructed.
 - The rails available for the Promise Vess A7000 unit are designed to safely support that Promise Vess A7000 unit when properly installed. Additional loading on the rails is at the customer's risk.
 - Promise Technology, Inc. cannot guarantee that the mounting rails will support your Promise Vess A7000 unit unless you install them as instructed.
-



Note

To lighten the Vess A7000 enclosure, you can remove the power supplies. Replace the power supplies after the Vess A7000 unit is mounted in your rack.

MOUNTING ENCLOSURE IN A RACK



Note

Please refer to the Quick Installation Guide included with the mounting rails for more detailed rack installation instructions.

To install the Vess A7000 into a rack with the supplied mounting rails:

1. Check the fit of the mounting rails in your rack system.
2. Adjust the length of the mounting rails as needed.
 - The rear rail slides inside the front rail. The rail halves are riveted together and use no adjustment screws.
 - The front-left and front-right mounting rail ends are labeled.
 - Be sure the front rail support is on the bottom facing inward
 - All rail ends, front and rear, attach at the outside of the rack posts.
 - The guide pins at the rail ends align with the holes in the rack posts.
 - Use the attaching screws and flange nuts from your rack system. Tighten the screws and nuts according to instructions for your rack system.

Installing the rails onto the rack

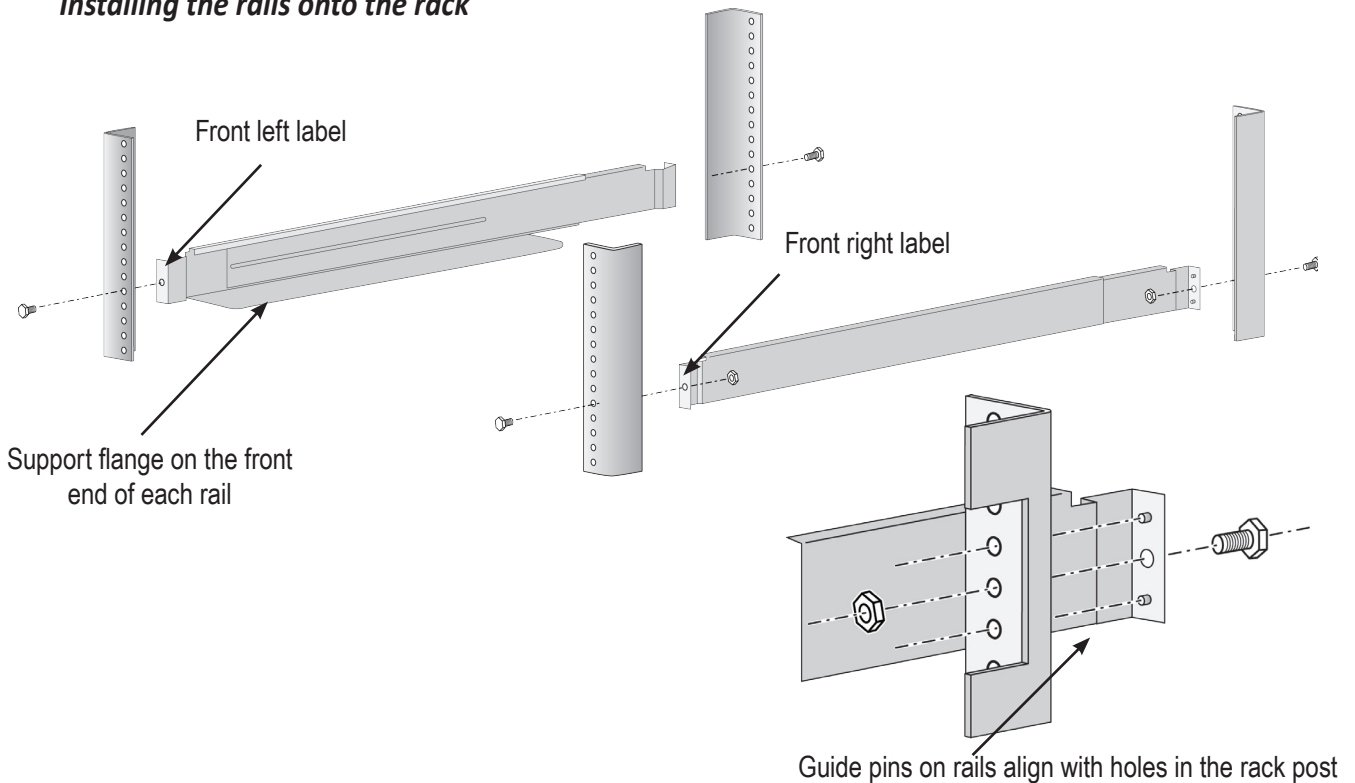

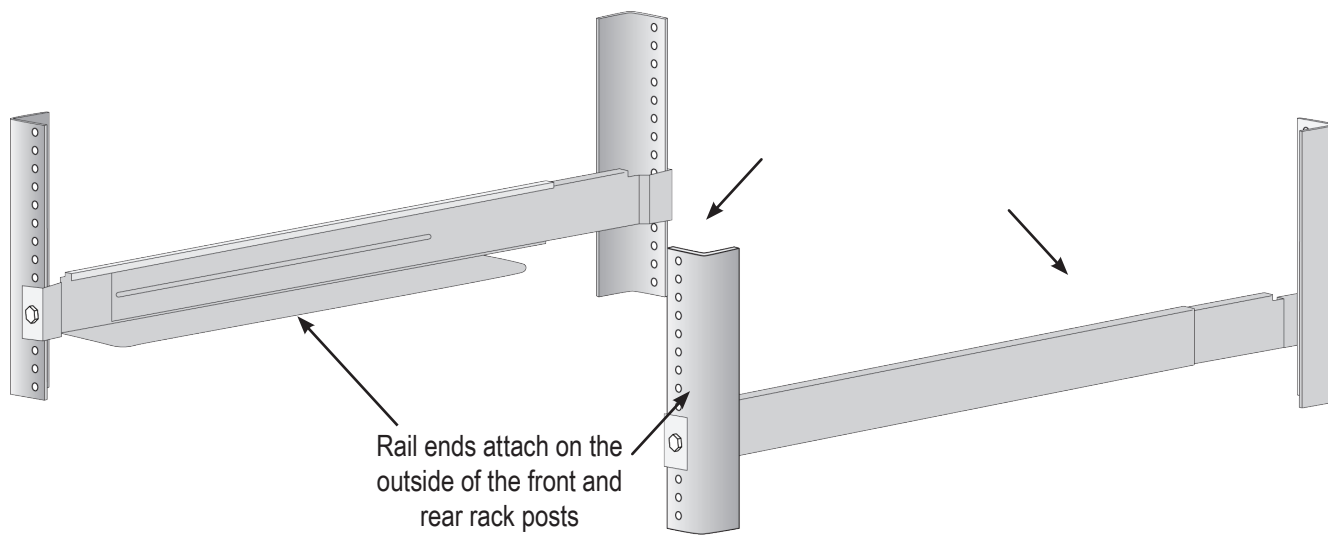
Rail ends attach to the outside of each post

3. Place the Vess A7000 onto the rails.

- At least two persons are required to safely lift the system.
- Lift the Vess A7000 itself. Do not lift the system by its brackets.

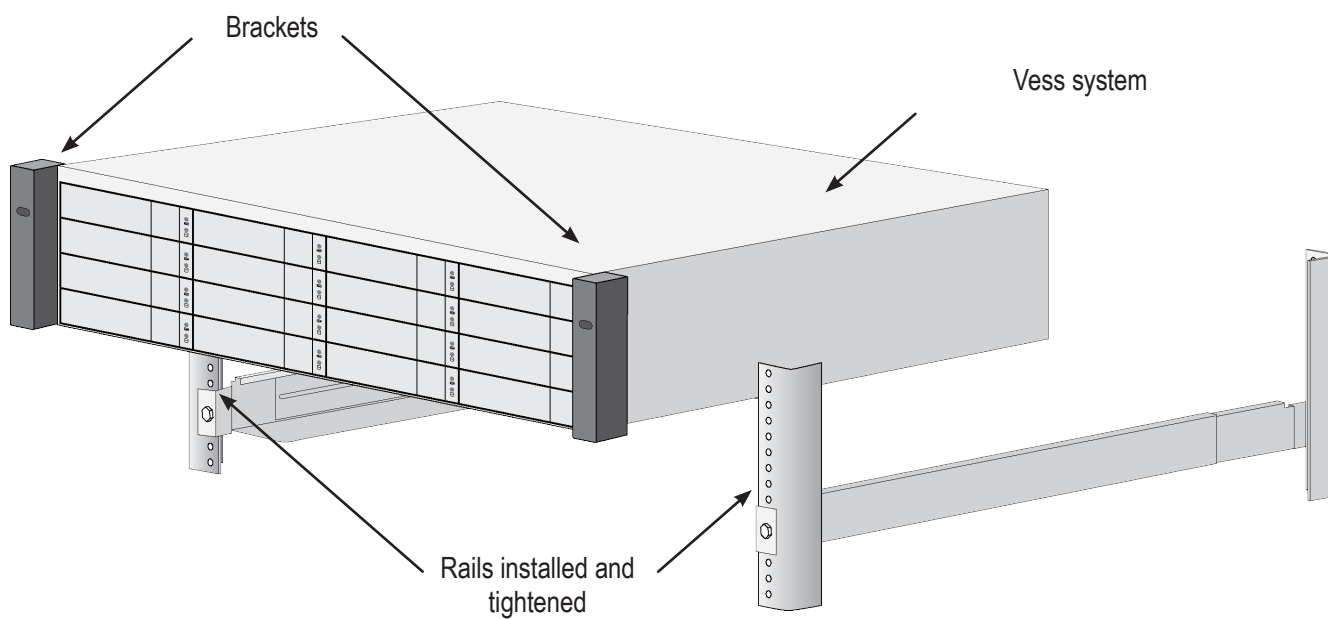
Placing the system onto the rack rails

4. Secure the enclosure to the rack.

- The unit attaches to the rack posts using the included screws and flange nuts. One screw each side, in the upper hole only.
- Use the attaching screws and flange nuts that came with the Vess A7000.

Secure to rack

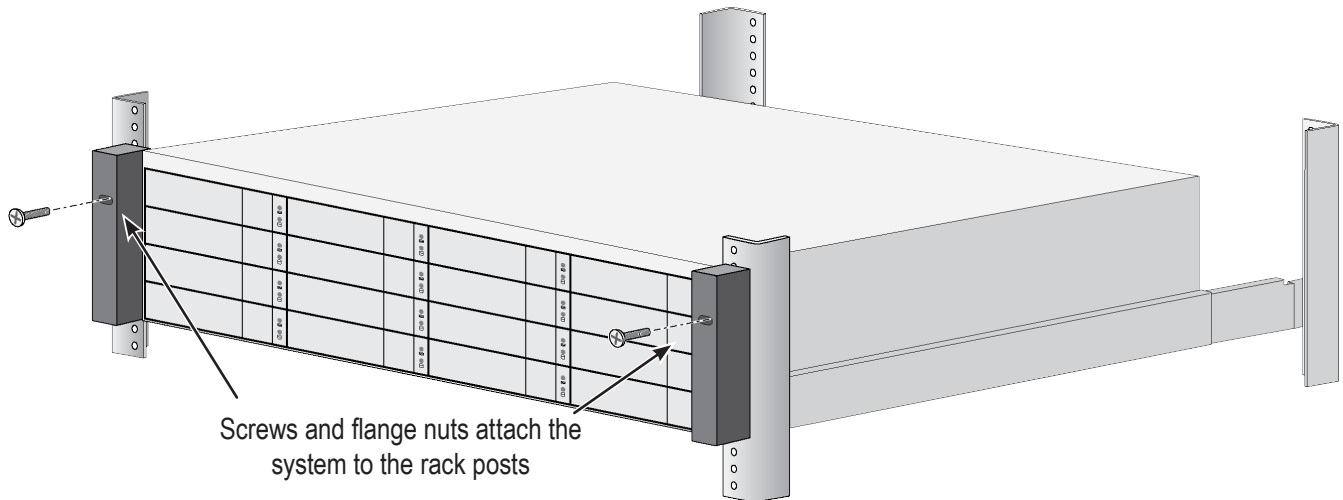

System installed in rack

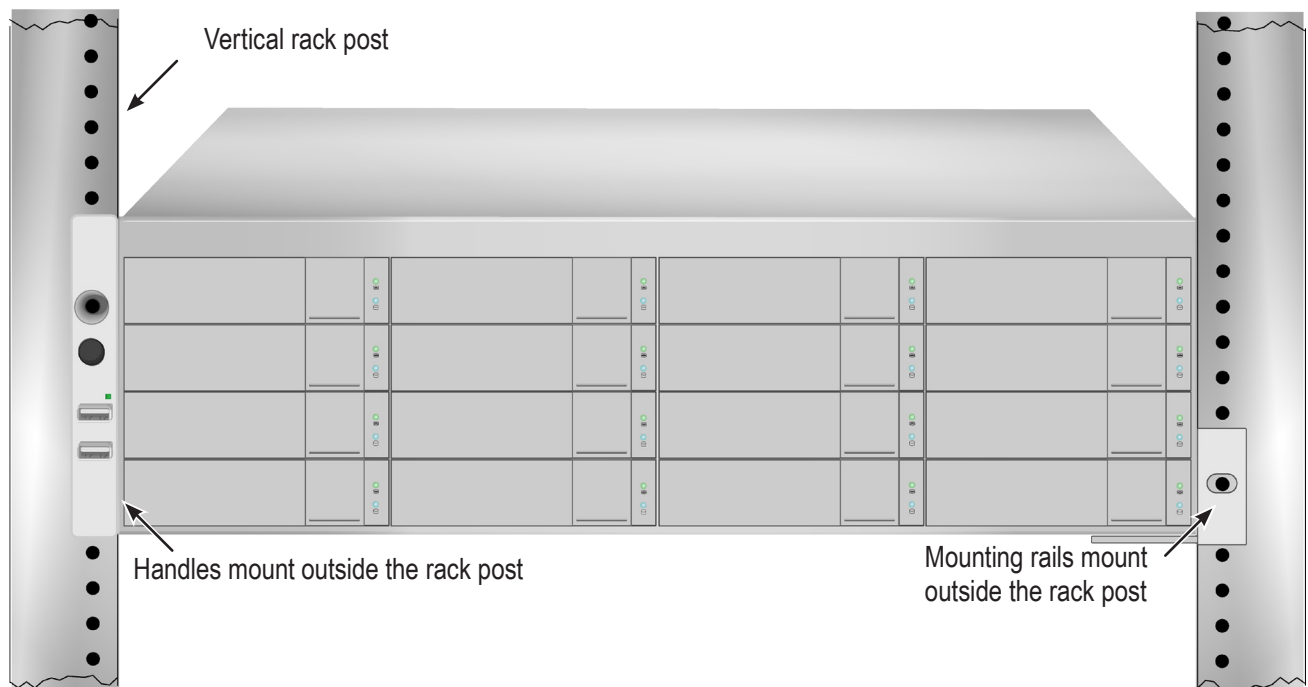

INSTALLING OR REMOVING THE SECURITY COVER

The secure cover hardware is operated in the same fashion on the Vess A7000 models.

To attach the secure cover:

1. Make sure the lock is in the unlocked position. *To unlock, insert the key into the lock and turn counter clockwise.*
2. Insert the tab on the right side of the cover into the slot receptacle on the right handle.
3. Place the cover in position and push in the latch release (to the left of the keyhole).
4. Push the cover into position so that the tab on the right side inserts into the receptacle on the right handle when releasing the latch.
5. Insert the key and turn clockwise to lock.

To remove the cover, unlock it, press the latch release on the left side and pull the left end out first, holding it with both hands.

Vess A7800 installing and removing secure cover

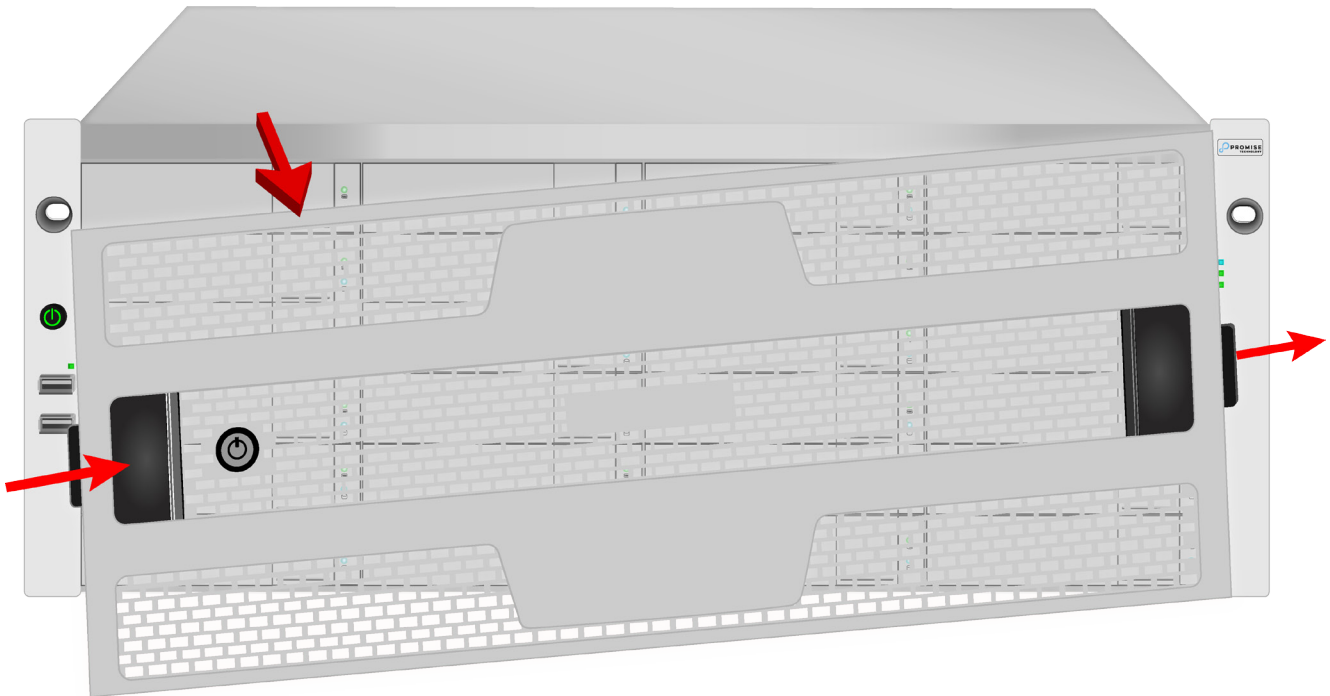

INSTALLING DISK DRIVES

The Vess A7000 subsystems support:

- SATA / SAS hard disks
- 3.5-inch hard disk drives
- SAS 2.5-inch hard disk drives (Optional)

NUMBER OF DRIVES REQUIRED

The table below shows the number of drives required for each RAID level

Level	Number of Drives	Level	Number of Drives
RAID 0	1 or more	RAID 6	4 to 32
RAID 1	2 only	RAID 10	4 or more*
RAID 1E	2 or more	RAID 50	6 or more
RAID 5	3 to 32	RAID 60	8 or more

*Must be an even number of drives.



Caution

The Vess A7000 supports disk drive hot-swapping. To avoid hand contact with an electrical hazard, do not remove more than one drive carrier a time.

DRIVE SLOT NUMBERING

You can install any suitable disk drive into any slot in the enclosure. The diagram below shows how drive slots are numbered on the Vess A7600.

Slot numbering is reflected in the web management user interfaces.

Drive slot numbering for Vess A7600

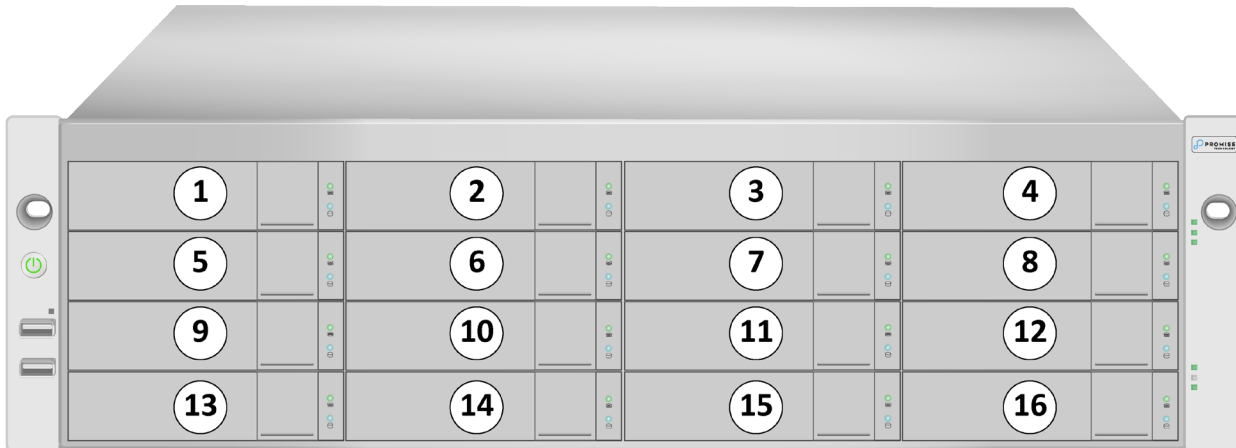

Drive slot numbering for Vess A7800



Install all of the drive carriers into the enclosure to ensure proper airflow, even if you do not populate all the carriers with disk drives.

REMOVING THE DRIVE CARRIER

The drive carrier accommodates 2.5-inch and 3.5-inch drives.

Drive carrier front view

Carrier release button

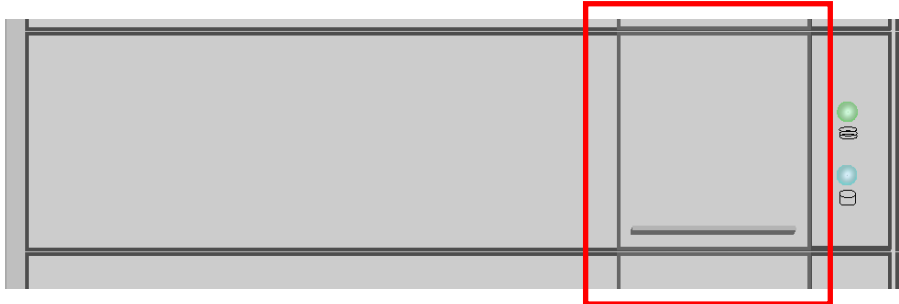

Cautions

Swing open the drive carrier handle before you insert the drive carrier into the enclosure.

To avoid hand contact with an electrical hazard, remove only one drive carrier a time.

1. Press the drive carrier release button.
2. Grasp the handle between thumb and finger, gently pull the empty drive carrier out of the enclosure.
3. Carefully lay the drive into the carrier with the power and data connectors facing away from the carrier handle.

INSTALLING 3.5" DISK DRIVE IN THE CARRIER

The instructions below apply 3.5" hard disk drives installed in drive carriers intended for use with models Vess A7600 and Vess A7800.

1. Remove a disk drive carrier.
2. Carefully lay the disk drive into the drive carrier at the front, so that the screw holes on the sides line up correctly with the power and data connectors facing away from the carrier handle.
3. Insert the screws through the holes in the drive carrier and into the sides of the disk drive.

Install only the counter-sink screws supplied with the drive.

- Install four screws per drive.
 - Snug each screw. Be careful not to over-tighten.
4. Reinstall the drive carrier into the enclosure.

Repeat steps 1 through 3 until all of your disk drives are installed.

SATA disk drive mounted in a drive carrier



INSTALLING 2.5" DISK DRIVE IN THE CARRIER

The instructions below apply 2.5" hard disk drives installed in drive carriers intended for use with models Vess A7600 and Vess A7800.

1. Remove a disk drive carrier.
2. Carefully lay the disk drive into the drive carrier at the front, so that the screw holes on the bottom of the carrier line up correctly with the power and data connectors facing away from the carrier handle.
3. Insert the screws through the holes on the bottom of the drive carrier and into the bottom of the disk drive.

Install only the counter-sink screws supplied with the drive.

- Install four screws per drive.
 - Snug each screw. Be careful not to over-tighten.
4. Reinstall the drive carrier into the enclosure.

Repeat steps 1 through 3 until all of your disk drives are installed.

Bottom view of empty disk carrier

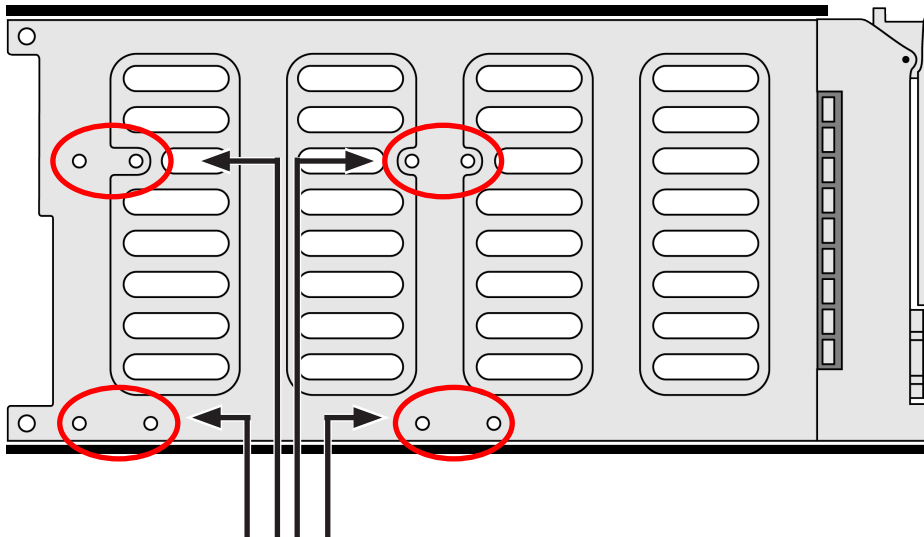

Use these holes on the bottom for mounting 2.5" hard disk drives. Four screw holes on the bottom of the drive will line up with four of the holes on the carrier.

MANAGEMENT PATH CONNECTION

This section describes how to establish a management connection the Vess A7000 subsystems. Management through the Gigabit network connection is done using Promise Management GUI, a web browser based GUI.

NETWORK CONNECTION

Vess A7000 have two Gigabit Ethernet RJ-45 ports on the rear panel for connection to an Ethernet network. Use this connection with Promise Management GUI to login as the device administrator.

To establish the management path:

1. Attach one end of an Ethernet cable to the network connector or standard NIC in the Host PC.

Attach the other end of the Ethernet cable to one of the ports on the standard network switch.

2. Attach one end of an Ethernet cable to one of the ports on the standard network switch.

Attach the other end of the Ethernet cable to either 1GbE network port on the Vess A7000 system.

(See illustration below for port location)

If you have multiple Vess A7000 systems, Host PCs or Servers, repeat steps 1 and 2 as required.

3. Follow the instructions for managing the basic settings of the Vess A7000.

CONNECT THE POWER

Insert one power cable into the power receptacle for each power supply and connect the each PSU to a suitable power source. The subsystem is equipped with three power supplies in an N+1 arrangement.

Each PSU has a Status LED. After boot up, check the LEDs on each power supply on the back of the device. These LEDs will light green to indicate normal operation. A red LED indicates a problem or unit failure.



Important

The Vess A7800 features three N+1 power supplies. In this arrangement, one PSU is redundant, so a minimum of two PSUs are needed to power up the enclosure.

The Vess A7600 feature two N+1 power supplies. In this arrangement, one PSU is redundant, so a minimum of one PSU is needed to power up the enclosure.

Vess A7800 N+1 power connections

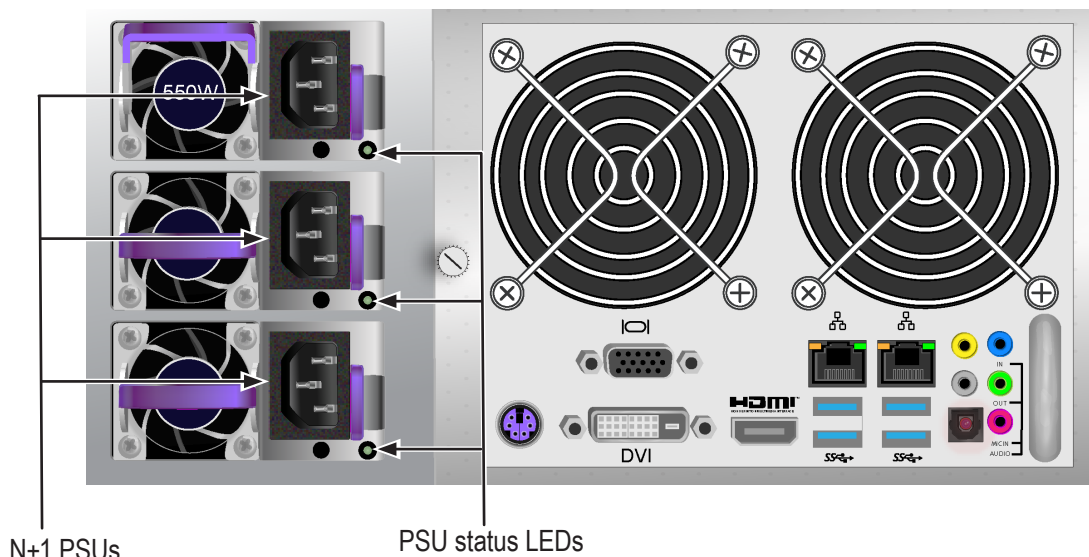

Connect all power supplies to a suitable power source.



Warning

Turn off the power and disconnect all power cord before servicing the Vess A7600 and Vess A7800.

POWER ON ENCLOSURE

With the power supplies connected, the system can now be powered on.

If you are using a VTrak J5000 storage expansion setup, power on the JBODs first.

To power on the Vess A7000 subsystem, press the Power button on the front left bracket facing (see figure below). Observe the LEDs on the front panel to make certain the boot up proceeds smoothly.

Vess A7600 front panel components, left side

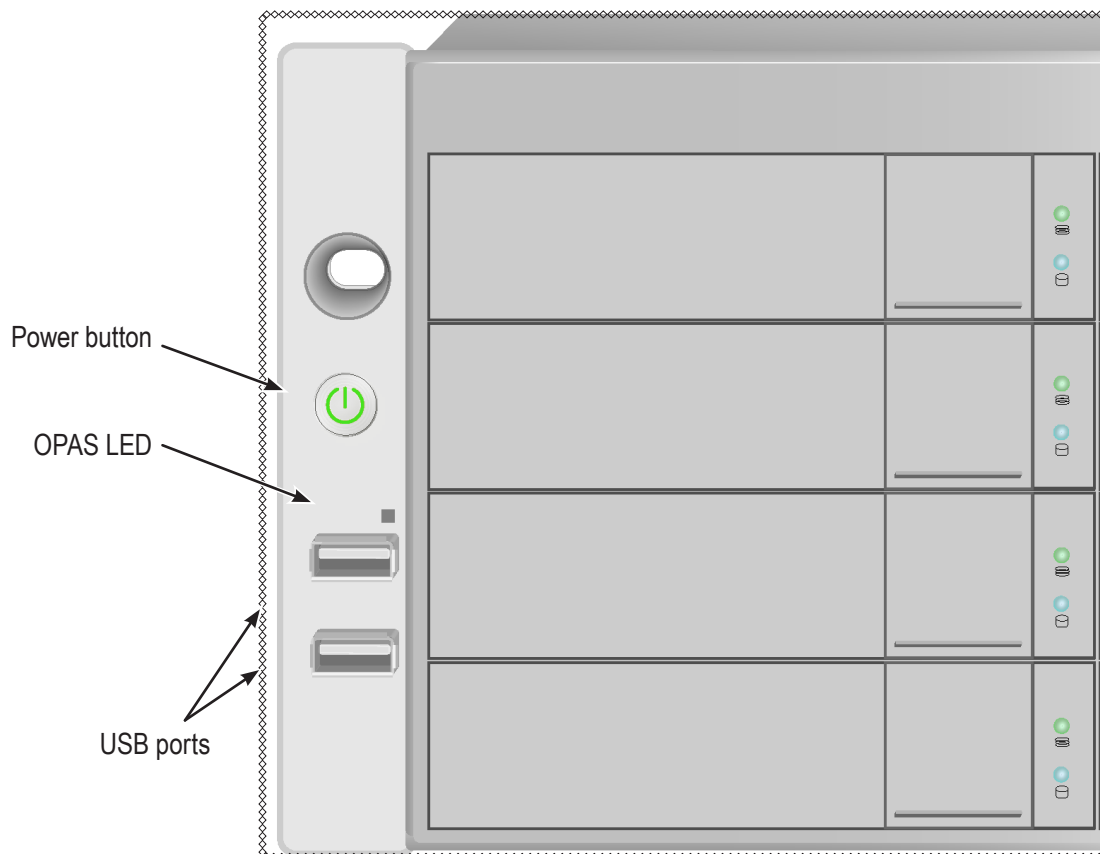

Vess A7600 front right side

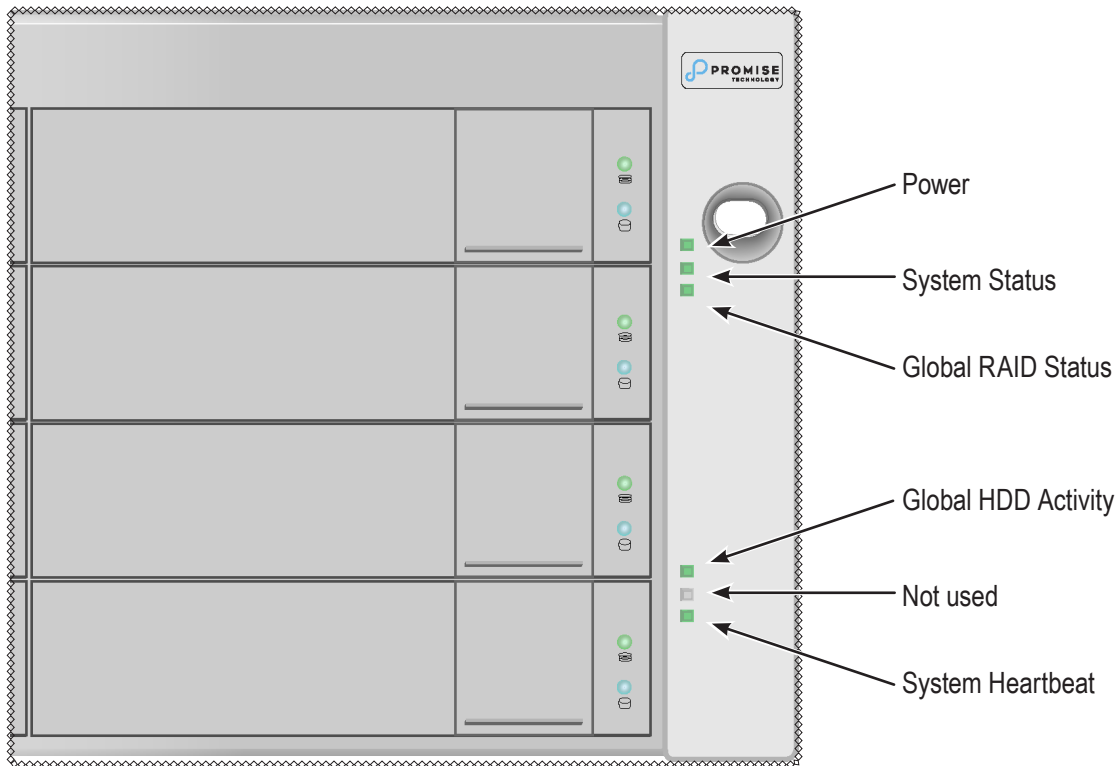

FRONT PANEL LED BEHAVIOR

The table below describes LED behavior when boot-up is finished and the system is functioning normally:

LED	Description
Power	Lights BLUE to indicate the system is powered on.
System Status	Lights GREEN when healthy, RED if there is a critical problem (LD offline, fan malfunction, voltage out of range, system temperature alert), blinks RED for HDD high temperature alert remains dark when not ready.
Global RAID Status	Lights GREEN when healthy or RED if any RAID volume is offline, ORANGE for critical state of any logical drive, or when the system is rebuilding.
Global HDD Activity	Blinks BLUE to indicate one or more drives are being accessed, lights steady BLUE when no drives are being accessed.
System Heartbeat	Blinks BLUE slowly at regular intervals to indicate the firmware and software are operating normally.
OPAS USB	Lights GREEN if an OPAS device (USB disk) is detected, remains dark if the OPAS operation has failed, blinks GREEN when an OPAS operation is in progress.

PROMISE MANAGEMENT GUI

This chapter describes using Promise Management GUI to monitor and manage your RAID system.

LOGGING INTO PROMISE MANAGEMENT GUI

You can log into Promise Management GUI in either of two ways:

- “Logging in at the Enclosure” on page 28
- “Logging in over the Network” on page 29

LOGGING IN AT THE ENCLOSURE

At the Vess A7000 enclosure to log into Promise Management GUI, do one of the following actions:

- Double-click the Promise Management GUI desktop icon.
- Choose Promise Management GUI in the Windows Programs menu.
- Follow the steps under “Logging in over the Network” on page 29.



Note

The default IP settings for the Gigabit Ethernet ports are:

Port 1 = 192.168.0.1

Port 2 = 192.168.1.1

IP settings for the ports are controlled by the OS. Use the normal IP settings configuration procedure for the OS you are using if you want to change the default settings.

LOGGING IN OVER THE NETWORK



Important

For Vess A7000 Series running Windows OS, it is necessary to disable the Windows Firewall in order to allow access to Promise Management GUI through the network interface. If the Firewall is running, no management access is permitted from the network.

You can log into Promise Management GUI from any PC with a network connection to the and Vess A7000 Series enclosure.

1. Launch your Browser.
2. In the Browser address field, type the information provided below. Then press Enter. Note that this example uses the default IP address for Port 1

If you chose External SSL Security during installation, use the Secure Connection. Otherwise, use the Regular Connection.

Regular Connection

- Promise Management GUI uses an HTTP connection.http://
- Enter the Subsystem IP address 192.168.0.1
- Enter the Port number :8090

Together, your entry looks like this:

http://192.168.0.1:8090

Secure Connection

- Promise Management GUI uses a secure HTTP connectionhttps://
- Enter the Subsystem IP address (Port 1 = 192.168.0.1 / Port 2 = 192.168.1.1)
- Enter the Port number:443

Together, your entry looks like this:

https://192.168.0.1:443/



Note

- You can enter the Host PC's network name in place of the IP address.
 - If you are logging in at the Host PC, you can enter local Host in place of the IP address.
 - Whether you select a regular or a secure connection, your login to Promise Management GUI and your user password are always secure.
-

LOGIN SCREEN

When the opening screen appears:

1. Type **administrator** in the User Name field.
2. Type **password** in the Password field.
3. Click the **Login** button.

The User Name and Password are case sensitive.

The Promise Management GUI login screen

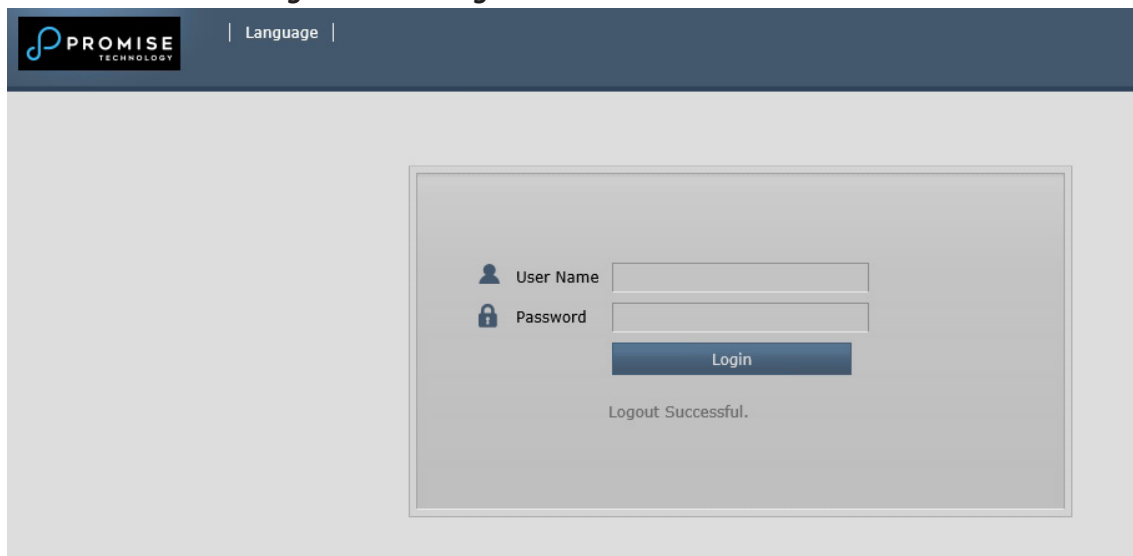

After logging in, the Quick Links menu appears.

Quick Links menu

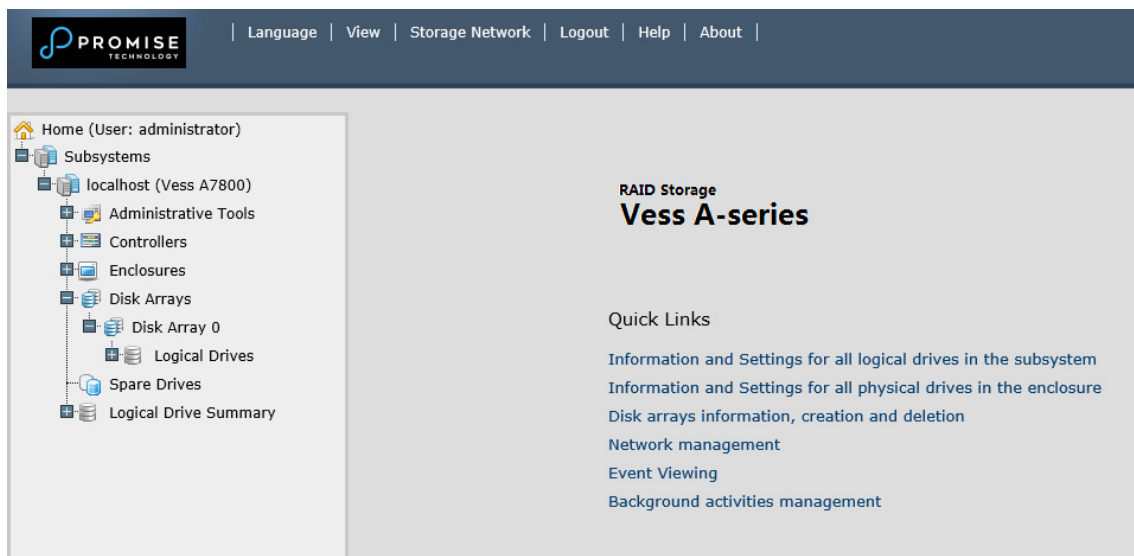

USING THE PROMISE MANAGEMENT GUI INTERFACE

Promise Management GUI is browser-based RAID management software with a graphic user interface. Basic user interface components and functions include:

Promise Management GUI interface - Subsystem home page

The screenshot shows the Promise Management GUI interface. The header (1) contains the Promise Technology logo and navigation links: Language, View, Storage Network, Logout, Help, and About. The tree view (2) on the left shows the system hierarchy: Home (User: administrator), Subsystems, localhost (Vess A7800), Administrative Tools, Controllers, Enclosures, Disk Arrays, Disk Array 0, Logical Drives, Spare Drives, and Logical Drive Summary. The event frame (3) displays background activities and parameters. The background activities section shows 'No background activity is running.' The background activity parameters section is a table with the following data:

Background Activity Parameters	
Rebuild Rate	High
Background Synchronization Rate	High
Logical Drive Initialization Rate	Medium
Redundancy Check Rate	High
Migration Rate	High
PDM Rate	High
Transition Rate	Medium
Reassigned Block Threshold	32 Blocks
Error Block Threshold	32 Blocks
Media Patrol	Enabled
Auto Rebuild	Enabled
Last Media Patrol Start Time	Feb 16, 2018 04:52:27
Last Media Patrol Stop Time	Feb 18, 2018 23:42:15

There are three parts to the Promise Management GUI interface:

1. Header
2. Tree View
3. Event Frame

USING THE HEADER

The Header contains the following items:

Language – Choose a display language

View – To view the Event Frame,

Logout – To logout

USING TREE VIEW

Tree View enables you to navigate around all components of the Vess A7000 enclosure, software management, RAID controller, enclosure, physical drives, disk arrays, logical drives, and spare drives. The figure below shows the components of Tree View.

Promise Management GUI Tree View

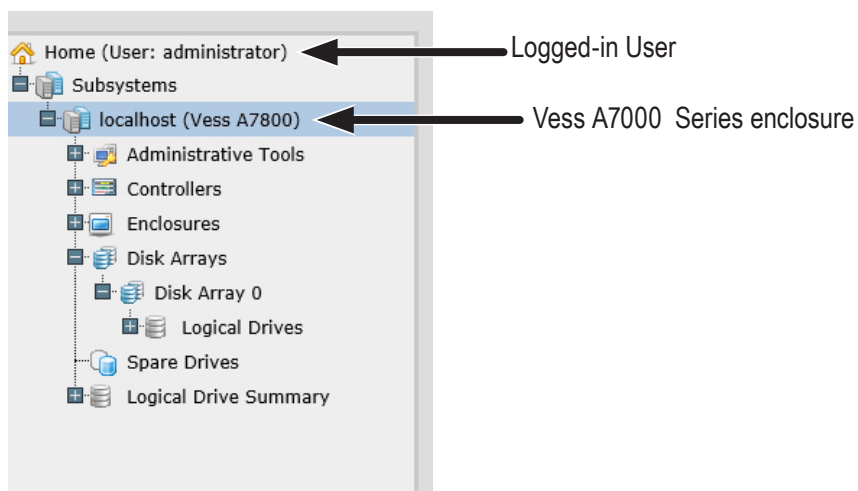

The Administrative Tools section is different for the Administrator and Super Users than for other users. The remainder of the Tree is the same for all users.

USING MANAGEMENT VIEW

Management View displays information and settings menus according to the item you choose in Tree View. It presents the user interface for the Vess A7000 enclosure, including creation, maintenance, deletion, and monitoring of disk arrays and logical drives. Function tabs access menus to control specific actions and processes.

Click the **Help** link to the right of the tabs in Management View to access online help for the function currently displayed.

CHOOSING A DISPLAY LANGUAGE

Promise Management GUI displays in the following languages:

- | | |
|-----------------------|--------------|
| • English | • French |
| • Simplified Chinese | • German |
| • Traditional Chinese | • Italian |
| • Japanese | • Spanish |
| • Korean | • Portuguese |
| • Arabic | • Turkish |
| • Polish | • Russian |

To change the display language:

1. Click the **Language** drop-down menu in the Header.
2. Highlight the language you prefer.

Promise Management GUI displays in the chosen language.

VIEWING THE EVENT FRAME

To view the Event Frame, click Show Event Frame in the Header. To hide the Event Frame, click Hide Event Frame in the Header.

In the event frame, events are listed and sorted by:

- **Device** – Disk array, logical drive, physical drive, controller, etc.
- **Event ID** – The hexadecimal number that identifies the specific type of event
- **Severity** – See below:
 - Information – Information only, no action is required
 - Warning – User can decide whether or not action is required
 - Minor – Action is needed but the condition is not serious at this time
 - Major – Action is needed now
 - Critical – Action is needed now and the implications of the condition are serious
 - Fatal – Non-Recoverable error or failure has occurred
- **Time** – Time and date of the occurrence
- **Description** – A brief description of the event

You can also view events by clicking the Subsystems icon in Tree View, then clicking the Event tab in Management View.

LOGGING OUT OF PROMISE MANAGEMENT GUI

There are two ways to log out of Promise Management GUI:

- Close your browser window
- Click **Logout** in the Promise Management GUI Header

Clicking **Logout** brings you back to the Login Screen. After logging out, you must enter your user name and password in order to log in again.

SUBSYSTEM MANAGEMENT

The menus listed under Subsystems are all the menus used for device management. Click on the Subsystems icon to view read-only information for the Vess A7000 including the management IP address, Alias, Model and WWN.

To view the menus used for system management, click the + symbol of the Subsystems icon to reveal the child menu icons for the following:

- **Administrative Tools** (includes links for User Management, View Network Settings, Performance Monitoring and Software Management)
- **Controllers** (view controller information and manage settings)
- **Enclosures** (view device information and virtual enclosure, set temperature thresholds for warnings and enable/disable warning buzzer)
- **Disk Arrays** (manage disk arrays)
- **Spare Drives** (manage spare drives)
- **Logical Drives Summary** (read-only logical drive information display)

Click on the subsystem IP address and model name listed under the Subsystems top-level menu icon in Tree View. In the Information tab, the following information for the subsystem appears:

- *Alias*
- *Model*
- *World Wide Number*
- *Revision Number*
- *Vendor*
- *Serial Number*
- *Part Number*
- *System Date & Time*

Here you can also save a *System Service Report* (useful for troubleshooting) in the form of an HTML file to the computer you are using by clicking on the **Save** button. See “Saving a Service Report”.

The Subsystem home menu includes the following function tabs:

- **Information** (described above)
- **Settings** (assign an Alias)
- **Background Activities**
- **Scheduler** (schedule background activities)
- **Event** (list runtime and NVRAM events)
- **Lock** (lock/unlock subsystem)

BACKGROUND ACTIVITIES

Background activities perform a variety of preventive and remedial functions on your physical drives, disk arrays, logical drives, and other components.

You can run a background activity immediately or schedule it to run at a later time.

Setting options for each activity are listed after the scheduling options. These settings determine how the background activity affects I/O performance.

VIEW CURRENT BACKGROUND ACTIVITIES

To view current background activities:

1. Click the Subsystem icon of the subsystem on which you want to view Background Activities.
2. In the Subsystem menu, click the Background Activities tab. Background Activities currently running are displayed in the top portion of the menu. You can also view the current Background Activities parameter settings in the lower part of the menu. Click the Background Activity Parameters menu expander to view the current parameter settings.

VIEW BACKGROUND ACTIVITIES PARAMETERS SETTINGS

To view current background parameter settings:

1. Click the Subsystem icon of the subsystem on which you want to view Background Activities.
2. Click the Background Activity Parameters menu expander to view the current parameter settings. The parameters listed are as follows:
 - Rebuild Rate
 - Background Synchronization Rate
 - Logical Drive Initialization Rate
 - Redundancy Check Rate
 - Migration Rate
 - Transition Rate
 - Reassigned Block Threshold
 - Error Block Threshold
 - Enable Media Patrol
 - Enable Auto Rebuild

MANAGE BACKGROUND ACTIVITIES SETTINGS

The parameters listed in the Background Activities menu are configured in the Background Activities Settings menu. To change Background Activities settings

1. Click the Subsystem icon of the subsystem on which you want to view Background Activities.
2. Click the menu expander between the Background Activities tab and the Scheduler tab and select the

Settings option. The following settings can be configured:

- Rebuild Rate *High, Medium, Low*
- Background Synchronization Rate *High, Medium, Low*
- Logical Drive Initialization Rate *High, Medium, Low*
- Redundancy Check Rate *High, Medium, Low*
- Migration Rate *High, Medium, Low*
- PDM Rate *High, Medium, Low*
- Transition Rate *High, Medium, Low*
- Reassigned Block Threshold
- Error Block Threshold
- Enable Media Patrol
- Enable Auto Rebuild

These settings can be also scheduled using the Scheduler. See the instructions for using schedules following the parameters descriptions below.

REBUILD SETTINGS

To change Rebuild setting the in Background Activities Settings menu:

1. Use the **Rebuild Rate** drop-down menu to choose a rate:
 - **Low** – Fewer system resources to the Rebuild, more to data read/write operations.
 - **Medium** – Balances system resources between the Rebuild and data read/write operations.
 - **High** – More system resources to the Rebuild, fewer to data read/write operations.
2. To enable Auto Rebuild (rebuilds when you swap out the failed drive with a new one) Check the **Enable Auto Rebuild** box.
3. Click the **Submit** button.

Rebuild Rate

When you rebuild a disk array, you are actually rebuilding the data on one physical drive.

- When a physical drive in a disk array fails and a spare drive of adequate capacity is available, the disk array begins to rebuild automatically using the spare drive.
- If there is no spare drive of adequate capacity, but the Auto Rebuild function is ENABLED, the disk array begins to rebuild automatically as soon as you remove the failed physical drive and install an unconfigured physical drive in the same slot.
- If there is no spare drive of adequate capacity and the Auto Rebuild function is DISABLED, you must replace the failed drive with an unconfigured physical drive, then perform a **Manual Rebuild**.

BACKGROUND SYNCHRONIZATION

Synchronization is automatically applied to redundant logical drives when they are created. Synchronization recalculates the redundancy data to ensure that the working data on the physical drives is properly in sync.

Background Synchronization Rate

1. To change Background Synchronization Rate setting the in Background Activities Settings menu: Click the Synchronization Rate drop-down menu and choose a rate:
 - **Low** – Fewer system resources to Synchronization, more to data read/write operations.
 - **Medium** – Balances system resources between Synchronization and data read/write operations.
 - **High** – More system resources to Synchronization, fewer to data read/write operations.
2. Click the **Submit** button.

LOGICAL DRIVE INITIALIZATION

Technically speaking, **Initialization** is a foreground activity, as you cannot access a logical drive while it is initiating.

Initialization is normally done to logical drives after they are created from a disk array. Initialization sets all data bits in the logical drive to zero. The action is useful because there may be residual data on the logical drives left behind from earlier configurations. For this reason, Initialization is recommended whenever you create a logical drive.

Logical Drive Initialization Rate

To change Logical Drive Initialization Rate setting the in Background Activities Settings menu:

1. Click the Logical Drive Initialization Rate drop-down menu and choose a rate:
 - **Low** – Fewer system resources to Initialization, more to data read/write operations.
 - **Medium** – Balances system resources between Initialization and data read/write operations.
 - **High** – More system resources to Initialization, fewer to data read/write operations.
2. Click the **Submit** button.

REDUNDANCY CHECK

Redundancy Check is a routine maintenance procedure for fault-tolerant disk arrays (those with redundancy) that ensures all the data matches exactly. Redundancy Check can also correct inconsistencies.



Note

You can use the scheduler to set up a Redundancy Check Schedule. To set up a schedule, click the menu expander to the right of the **Scheduler** tab and select *Redundancy Check Schedule*.

Redundancy Check Rate

To change Redundancy Check Rate setting the in Background Activities Settings menu:

1. Click the Redundancy Check Rate drop-down menu and choose a rate:
 - **Low** – Fewer system resources to Redundancy Check, more to data read/write operations.
 - **Medium** – Balances system resources between Redundancy Check and data read/write operations.
 - **High** – More system resources to Redundancy Check, fewer to data read/write operations.
2. Click the **Submit** button.

PDM

Predictive Data Migration (PDM) is the migration of data from the suspect physical drive to a spare drive, similar to rebuilding a logical drive. But unlike Rebuilding, PDM constantly monitors your physical drives and automatically copies your data to a spare drive before the physical drive fails and your logical drive goes Critical.

PDM Settings

To change PDM setting the in Background Activities Settings menu:

1. Click the PDM Rate drop-down menu and choose a rate:
 - **Low** – Fewer system resources to PDM, more to data read/write operations.
 - **Medium** – Balances system resources between PDM and data read/write operations.
 - **High** – More system resources to PDM, fewer to data read/write operations.
2. Highlight the current values in the block threshold fields and input new values.
 - Reassigned Block Threshold* range is 1 to 512 blocks.
 - Error Block Threshold* range is 1 to 2048 blocks.
3. Click the **Submit** button.

TRANSITION

Transition is the process of replacing a revertible spare drive that is currently part of a disk array with an unconfigured physical drive or a non-revertible spare drive.

Transition Rate

To change Transition Rate setting the in Background Activities Settings menu:

1. Click the Transition Rate drop-down menu and choose a rate:
 - **Low** – Fewer system resources to Transition, more to data read/write operations.
 - **Medium** – Balances system resources between Transition and data read/write operations.
 - **High** – More system resources to Transition, fewer to data read/write operations.
2. Click the **Confirm** button.

MEDIA PATROL

Media Patrol is a routine maintenance procedure that checks the magnetic media on each disk drive. Media Patrol checks are enabled by default on all disk arrays and spare drives. Media Patrol is concerned with the media itself, not the data recorded on the media. If Media Patrol encounters a critical error, it triggers PDM if PDM is enabled on the disk array.

Media Patrol Settings

Media Patrol is enabled or disabled using the Background Activities menu or you can create a schedule to run Media Patrol.

- To enable Media Patrol, click on the Subsystem in Tree View then click on the Background Activities menu tab. Click to check the *Enable Media Patrol* option. Notice also that the *Auto Rebuild* option is here as well. If you want to automatically begin rebuilding a logical drive as soon as a faulty drive is replaced, make sure this option is enabled.
- To begin Media Patrol manually, click on the menu expander to the right of the Background Activities tab and scroll down and select *Start Media Patrol* to see the Start Media Patrol menu. Then click on the **Start** button.
- To schedule Media Patrol, click on the menu expander to the right of the Scheduler tab and scroll down and select *Add Media Patrol Schedule* to open the schedule menu. Use this menu to add a Media Patrol schedule.

MANAGING ACTIVITY SCHEDULES

Schedules for **Media Patrol**, **Redundancy Check** and **Spare Drive Check** can be created to run during off peak times.

ADD OR DELETE AN ACTIVITY SCHEDULE

To add, enable or delete an activity schedule, click on the Subsystem in Tree View, then click on the Scheduler menu expander to the right of the Scheduler tab. Scroll down to the schedule option you want to view that menu. Schedule options are *Add Media Patrol Schedule*, *Add Redundancy Check Schedule*, *Add Spare Check Schedule* and *Delete Schedule*.

VIEW OR MODIFY AN EXISTING ACTIVITY SCHEDULE

To view existing schedules including the recurrence, start time and status of existing schedules, click on the Scheduler tab. Here you can then modify any listed schedule by clicking on the name of the schedule in the list.

EVENT LOGS

Event logs are useful for troubleshooting, tracking functions and monitoring subsystems. To view, save or clear subsystem event logs, click on the subsystem in Tree View, then click on the Event menu expander. Choose to display *Runtime Events* or *NVRAM Events*. Event logs can be saved as a simple text file by clicking the **Save** button in either menu. To clear the log and start fresh, click the **Clear Event Log** button.

ADMINISTRATIVE TOOLS

Click the + symbol of the Administrative Tools icon reveal subsystem administrative tools menu links for User Management, View Network Settings, Performance Monitoring and Software Management. The Administrative Tools menu lists text hyperlinks to these same menus, plus links to menus to Restore Factory Default settings, Clear Statistics and Save System Service Report.

RESTORE FACTORY DEFAULT SETTINGS

To restore any firmware or software settings to the default values:

1. Click on the Administrative Tools icon.
2. Click on the *Restore Factory Defaults* link to reveal a new menu.
3. Check mark the option boxes for the settings you want to return to the factory default values. Default

Settings options include:

Firmware Default Settings

- Background Activities
- Controller Settings
- Enclosure Settings
- Physical Drive Settings
- Subsystem Settings

Software Default Settings

- Service Settings
- Web Server Settings
- Email Settings

4. Click the **Submit** button to return the selected settings to default values. To deselect all options and start over, click the **Reset** button.

CLEAR STATISTICS

To clear all subsystem statistics for controllers, ports physical drives and logical drives:

1. Click on the Administrative Tools icon.
2. Click on the *Clear Statistics* link to reveal a new menu.
3. Click on the **Submit** button to clear all device statistics.

USER MANAGEMENT

User Management deals with user accounts.

VIEWING USER INFORMATION

To view a list of users, their status, access privileges, display name, and email address:

1. Click the Administrative Tools icon.
2. Click the User Management icon.

The Information tab appears in Management View.

MAKING USER SETTINGS

To change settings of other users:

1. Log into Promise Management GUI as the Administrator or a Super User.
2. Click the Administrative Tools icon.
3. Click the User Management icon.
4. Click the **Information** tab.
5. In the list of users, click the link of the user whose settings you want to change.

The Settings screen for the chosen user displays.

6. Enter or change the settings for this user.
 - Enable/disable this user
 - Display name
 - Privilege.
7. Click the **Submit** button.

The Administrator or Super User can change another user's password.

MAKING YOUR OWN USER SETTINGS

To change your own user settings:

1. Log into Promise Management GUI under your own user name.
2. Click the Administrative Tools icon.
3. Click the User Management icon.
4. Click the **Settings** tab in Management View.
5. Enter or change the display name or mail address.
6. Click the **Submit** button.

CHANGING YOUR OWN PASSWORD

To set or change your own password:

1. Log into Promise Management GUI under your own user name.
2. Click the Administrative Tools icon.
3. Click the User Management icon.
4. Click the **Password** tab in Management View.
5. Enter the current password in the Old Password field.
6. If you do not have a password, leave this field blank.
7. Enter the new password in the New Password field.
8. Enter the new password in the Retype Password field.
9. Click the **Submit** button.

CREATING A USER

To create a user:

1. Log into Promise Management GUI as the Administrator or a Super User.
2. Click the Administrative Tools icon.
3. Click the User Management icon.
4. Click the **Create** tab in Management View.
5. Enter a user name in the User Name field.
6. Enter a password for this user in the New Password and Retype Password fields.

A password is optional. If you do not assign password, tell this user to leave the password field blank when he/she logs into to Promise Management GUI.

7. Check the *Enabled* box to enable this user on this subsystem.
8. Enter a display name in the Display Name field.

A display name is optional but recommended.

9. Choose a privilege level from the Privilege drop-down menu.

For definitions of each privilege level, see the List of User Privileges below.

10. Click the **Submit** button.

LIST OF USER PRIVILEGES

- **View** – Allows the user to see all status and settings but not to make any changes
- **Maintenance** – Allows the user to perform maintenance tasks including
 - Rebuilding, PDM, Media Patrol, and Redundancy Check.
- **Power** – Allows the user to create (but not delete) disk arrays and logical drives, change RAID levels, change stripe size; change settings of components such as disk arrays, logical drives, physical drives, and the controller.
- **Super** – Allows the user full access to all functions including create and delete users and changing the settings of other users, and delete disk arrays and logical drives. The default “administrator” account is a Super User.

DELETING A USER

There is always at least one Super User account. You cannot delete the user account you used to log in. To delete a user:

1. Log into Promise Management GUI as the Administrator or a Super User.
2. Click the Administrative Tools icon.
3. Click the User Management icon.
4. Click the **Delete** tab in Management View.
5. Check the box to the left of the user you want to delete.
6. Click the **Submit** button.
7. Click **OK** in the confirmation box.

VIEW NETWORK SETTINGS

To view network settings for the Ethernet ports, including the port used for access to Promise Management GUI, click on the View Network Settings icon under Administrative Tools. Information listed for each port includes:

- If the port is enabled/disabled
- If the link is up/down
- IP type IPv4/IPv6
- IP address
- Subnet mask
- MAC address
- Maximum port speed

SOFTWARE MANAGEMENT

The Software Management menu is used to manage settings for Email, SNMP settings and Web services. The Email function is used for sending notifications of events. The Web service is used for remote network connection to the Promise Management GUI management interface. This is also where you can export and import configuration script files and user database files.

IMPORTING A CONFIGURATION SCRIPT

You can import a previously saved configuration script to automatically configure your Vess A7000 subsystem. The script must be a plain, non-encrypted text file. This file can be saved from the same system, or from another Vess A7000 subsystem. See the next section, “Exporting a Configuration Script” on page 54 for instructions on how to save the file to your host PC.



Cautions

Do NOT attempt to write or modify a configuration script until you receive guidance from Technical Support.

Importing a configuration script overwrites the current settings on your Vess A7000 subsystem.

To import a configuration script for automatic configuration of a subsystem:

1. Click the **Administrative Tools** icon.
2. Click the **Software Management** icon.
3. Click the **Import** tab in the Software Management menu.
4. Choose *Configuration Script* from the **Type** drop-down menu.
5. Click the **Import** button.
6. Click **Browse** and find the file “Configscript.txt” on the Host PC.
7. Click the **Submit** button.

The configuration script is loaded and applied automatically.

EXPORTING A CONFIGURATION SCRIPT

You can save the configuration from one Vess A7000 subsystem, export it, and then import it to automatically configure your other Vess A7000 subsystems.

To export a configuration script:

1. Click the **Administrative Tools** icon.
2. Click the **Service Management** icon.
3. Click the **Export** tab in the Service Management menu.
4. Choose *Configuration Script* from the **Type** drop-down menu.
5. Click the **Export** button.
6. Select a location on the Host PC for the downloaded file and save the file.

The file is saved to your PC as “Configscript.txt”.



Cautions

Do NOT attempt to write or modify a configuration script until you receive guidance from Technical Support.

SAVING A SERVICE REPORT

A Service Report is a detailed report covering the configuration and status of all components in your RAID system. A support technician or field engineer might request a service report for the purpose of diagnosis and troubleshooting.

To save a system configuration file:

1. Click on the Subsystem icon (IP address and device name) in Tree View to open the Subsystem Information display.
2. Click the **Save** button in the Save System Service Report row of the information display.

Information for the report is gathered and compiled. This action takes up to a few minutes, depending on the size of your RAID system.

3. Determine where you want to store the file on the Host PC, then click the **Save** button in the pop-up menu.

The report saves to your Host PC as a compressed HTML file.

4. Double-click the downloaded file to decompress it.
5. Double-click the report to open it in your default browser.

The Service Report includes the following topics:

- About – Report utility
- BBM Info – Bad Block Manager
- BGA Summary – Status and settings
- Buzzer Info
- Controller Info
- Disk Array Info
- Disk Array Dump info
- Disk Array Verbose Info
- Enclosure Info
- Error Table Info
- Event Info - NVRAM
- Event Info - Runtime
- LogDrive Info – Basic logical drive information
- LogDrive Dump Info – Diagnostic information
- Logical Drive Verbose Info – Full logical drive information
- Network Info – Virtual port
- Phydriv Info – Basic physical drive information
- Phydriv Verbose Info – Full physical drive
- SWMGT Info – Software management
- Service Setting – Email
- Service Setting – Webserver
- Spare Info – Basic spare drive information
- Spare Dump Info – Diagnostic information
- Spare Verbose Info – Full spare Drive information
- Statistic Info
- Subsystem info
- User Info

EMAIL SERVICE

Email service enables the RAID subsystem to send you Email messages about events and status changes. By default, Email service is set to Automatic.

STOP EMAIL SERVICE

To stop the Email service:

1. Click the **Administrative Tools** icon.
2. Click the **Software Management** icon.
3. Click on **Email** in the Service List of the Service Management menu.
4. Click the **Stop** button under *Service Status -- Email*.
5. Click the **Confirm** button.

To start the Email service after stopping it:

1. Click the **Administrative Tools** icon.
2. Click the **Software Management** icon.
3. Click on **Email** in the Service List of the Service Management menu.
4. Click the **Start** button under *Service Status -- Email*.
5. Click the **Confirm** button.

RESTARTING EMAIL SERVICE

To restart the Email service:

1. Click the **Administrative Tools** icon.
2. Click the **Software Management** icon.
3. Click on **Email** in the Service List of the Service Management menu.
4. Click the **Restart** button under *Service Status -- Email*.
5. Click the **Confirm** button.

EMAIL SETTINGS

To change Email service settings:

1. Click the **Administrative Tools** icon.
2. Click the **Software Management** icon.
3. Click on **Email** in the Service List of the Service Management menu.
4. Make settings changes as required:

Under *Service Setting -- Email* choose a startup type:

- *Automatic* – (default) Starts and runs with the subsystem.
- *Manual* – You start the service when you need it.

Under *Email Server Settings*

- SMTP Server IP address
- SMTP Authentication under *Email Server Settings*
The Yes option enables authentication.
The No option disables.
- SMTP Authentication under *Email Server Settings*
Username – Required if SMTP authentication is enabled.
SMTP Authentication Password – Required if SMTP authentication is enabled.

Under *Email Content Customization*

- Email Sender (From) Address – The sender's name shown on notification messages.
 - Email Subject – The subject line of the notification message.
5. Click the **Submit** button.
 6. Click the **Confirm** button.

SENDING A TEST EMAIL MESSAGE

After email settings are completed, you can send a test email.

To send a test email message, complete email settings as described above and check the *Send a test email* option box, then click the **Submit** button. A test email message is sent to the address you specified.

PERFORMANCE MONITORING

The Performance Monitor displays real-time performance statistics for logical drives and physical drives. The vertical scale adjusts dynamically to accommodate the statistical data.

Because it reports performance in real-time, to see data in the monitor, there must be I/O data activity taking place between the subsystem and the Host.

To monitor performance:

1. Click the **Administrative Tools** icon.
2. Click the Performance Monitoring icon.
3. Click the Information tab for aggregated statistics; or choose the Read/Write tab to view specific Read and Write performances separately.
4. Under Logical Drive, choose the metric you want to see from the Measurement drop-down menu.

Information

- Bandwidth in MB/s
- Cache usage by %
- Dirty cache usage by %
- Maximum latency in ms
- Average latency in ms
- Minimum latency in ms
- I/Os per second

Read/Write

- Read bandwidth
- Write bandwidth
- Maximum Read latency in ms
- Maximum Write latency in ms
- Average Read latency in ms
- Average Write latency in ms
- Minimum Read latency in ms
- Minimum Write latency in ms
- Write Regs
- Read Regs

5. Check the boxes for the logical drives you want to see.
 - Total of all logical drives
 - Up to 4 devices

6. Under Physical Drive, choose the metric you want to see from the Measurement drop-down menu.

Information

- Bandwidth in MB/s
- Maximum latency in ms
- Average latency in ms
- Minimum latency in ms
- I/Os per second

Read/Write

- Read bandwidth
- Write bandwidth
- Maximum Read latency in ms
- Maximum Write latency in ms
- Average Read latency in ms
- Average Write latency in ms
- Minimum Read latency in ms
- Minimum Write latency in ms
- Write Regs
- Read Regs

7. Check the boxes for the physical drives you want to see.

- Total of all physical drives
- Up to 4 devices
- I/Os per second

Since the performance monitor is a real-time display, it does not accumulate information and there is no clear or save function.

To save performance statistics for analysis or troubleshooting, save a Service Report. See “Saving a Service Report”.

CONTROLLERS

Click on a specific controller in Tree view to display information or statistics for a controller. Or to change controller settings. See the following sections:

- “View Controller Information”
- “Viewing Controller Statistics”
- “Controller Settings”

VIEW CONTROLLER INFORMATION

To view controller information:

1. Click the **Controllers** icon.
2. Click the specific **Controller** icon of the controller for which you want to view information.
3. The Information tab will present basic controller information.

Controller information includes:

- Controller ID
- Alias
- Operational Status
- Power on Time
- Cache Usage
- Dirty Cache Usage
- Part Number
- Serial Number
- Hardware Revision
- WWN
- SCSI Protocols Supported
- Install Package Version
- Install Package Build Date

1. Click the **Advanced Information** menu expander to view advanced information.

Advanced controller information includes:

- Memory Type
- Memory Size
- Flash Type
- Flash Size
- Preferred Cache Line Size
- Cache Line Size
- Coercion *Enabled/Disabled**
- Coercion Method*
- SMART Log *Enabled/Disabled**
- SMART Polling Interval *
- Write Back Cache Flush Interval*
- Enclosure Polling interval
- Host Cache Flushing *Enabled/Disabled**
- Forced Read Ahead *Enabled/Disabled**
- Spin Down Type
- HDD Power Levels*
- HDD Idle Time*
- HDD Standby Time*
- HDD Stopped Time*
- Physical Drive Temperature Threshold*
- Physical Drive Critical Temperature Threshold*

Items with an asterisk (*) are adjustable under Controller Settings.

VIEWING CONTROLLER STATISTICS

To view controller statistics:

1. Click the **Controllers** icon.
2. Click the specific **Controller** icon of the controller for which you want to view statistics.
3. At the top of the Information display menu, between the Information and Settings tabs, click on the menu expander to reveal the Statistics link.

Controller statistics include:

- Data Transferred
- Read Data Transferred
- Errors
- Read Errors
- I/O Requests
- Read IO Requests
- Statistics Start Time
- Write Data Transferred
- Non-Read/Write Errors
- Write Errors
- Non-Read/Write Requests
- Write I/O Requests
- Statistics Collection Time

CONTROLLER SETTINGS

To make controller settings:

1. Click the **Controllers** icon.
2. Click the specific **Controller** icon of the controller you want to manage.
3. Click the **Settings** tab.
4. Make settings changes as required:
 - Enter, change or delete the alias in the **Alias** field.
 - **Coercion** – Check the box to enable or uncheck to disable.
 - **Coercion Method** – Choose a method from the drop-down menu:
 - GBTruncate
 - 10GBTruncate
 - GrpRounding
 - TableRounding
 - **Write Back Cache Flush Interval** – Enter a value into the field, 1 to 12 seconds.
 - **HDD Power Saving** – Choose time periods from the drop-down menus.
After an HDD has been idle for the set period of time:
 - Power Saving Idle Time** – Parks the read/write heads.
 - Power Saving Standby Time** – Lowers disk rotation speed.
 - Power Saving Stopped Time** – Spins down the disk (stops rotation).
 - **Host Cache Flushing** – Check the box to enable or uncheck to disable.
 - **Forced Read Ahead** (cache) – Check the box to enable or uncheck to disable.
 - Physical Drive Temperature Threshold - Type a temperature (50-55 °C) to trigger an event notice and email alert.
 - Physical Drive Critical Temperature Threshold - Type a temperature (58-65 °C) to trigger system shutdown.
5. Click the **Submit** button.

ENCLOSURES

The Enclosure menus are used to provide information for and monitor the status about the various components of the enclosure unit. Click on a specific enclosure in Tree view or in the Enclosures list to display information or settings menus for an enclosure. See the following sections:

- “Enclosure Information”
- “Enclosure temperature sensor settings”
- “Buzzer Settings”
- “Physical Drives”

LOCATE AN ENCLOSURE

To locate an enclosure in the list, click the **Locate** button. The LED indicators on the front panel of the enclosure will blink for one minute.

ENCLOSURE INFORMATION

The Enclosure Information read-only display menu provides key real-time information about current hardware status of the enclosure. Click on the expanders buttons to reveal current conditions and status of the enclosure, power supplies, fans, blowers, temperature sensors and voltage sensors. Move the cursor over the icons in the virtual enclosure displayed at the top of the menu to see current status and relevant conditional statistics for the fans, power supplies, and temperature sensors.

Enclosure Information display

The screenshot shows the Promise Technology Web Manager interface. The navigation tree on the left includes: Home (User: administrator), Subsystems, localhost (Vess A7800), Administrative Tools (User Management, Network Management, Performance Monitoring, Software Management), Controllers, Enclosures (Enclosure 1), Physical Drives, Disk Arrays (Disk Array 0), Logical Drives, and Logical Drive Summary. The main content area is titled 'Enclosure Information' and has tabs for 'Information', 'Settings', and 'Buzzer'. The 'Information' tab is active, showing an 'Enclosure Back View' diagram with icons for temperature, fans, and power. Below the diagram is a table of enclosure information.

Enclosure Information	
Enclosure ID	1
Enclosure Type	ENC_TYPE_VA7800_4U24BAY
Controller Warning Temperature Threshold	90°C / 194°F
Controller Critical Temperature Threshold	100°C / 212°F
Power Switch	Enabled
Max Number of Controllers	1
Max Number of Physical Drive Slots	24
Max Number of Fans	0
Max Number of Blowers	5
Max Number of Temperature Sensors	9

The temperature threshold settings are used to send event notices when the internal temperature reaches a high level. To set enclosure temperature thresholds, click on the enclosure in Tree View, then click on the **Settings** tab to view the Enclosure Settings menu. There are two thresholds to configure:

- *Controller Warning Temperature Threshold [90-95 C°]* — If the enclosure temperature reaches this threshold, a warning message is sent and an event is recorded in the event log.
- *Controller Critical Temperature Threshold [100-105 C°]* — If the enclosure temperature reaches this threshold, a warning message is sent, an event recorded is recorded in the event log.

BUZZER SETTINGS

The audible enclosure alarm buzzer can be enabled or disabled.

To enable or disable the buzzer, click on the enclosure in Tree View, then click on the Buzzer menu expander, scroll to **Settings** and click the check **Enable Buzzer** option box. Click the **Submit** button.

PHYSICAL DRIVES

The Physical Drives menus are used to view information and statistics about physical hard drives installed in the enclosure and to set Global Settings for hard drives. To see the Physical Drives List, expand the individual Enclosure icon in Tree View to see the Physical Drives icon for the enclosure. To display the information for any populated slot, you can expand the Physical Drives icon in Tree View to reveal links to each slot, or click on the slot in the Physical Drives List, or click on the populated slot in the virtual enclosure displayed in the menu.

View individual physical drive information

The screenshot displays the Promise Technology web interface. The top navigation bar includes links for Language, View, Storage Network, Logout, Help, and About. The left sidebar shows a tree view with 'Physical Drives' selected under 'Enclosures'. The main content area has tabs for 'Information' and 'Global Settings'. Under 'Enclosure Front View', there is a diagram of 'Enclosure 1' with a grid of drive slots. Below the diagram is the text 'Click a drive to locate.' The 'Physical Drive List' table is shown below the diagram.

Device	Model	Type	Configurable Capacity	Location	Operational Status	Configuration Status
PD1	TOSHIBA MC04ACA500E	SATA	4.55TB	Encl 1 Slot 1	OK	Array0 SeqNo0
PD2	TOSHIBA MC04ACA500E	SATA	4.55TB	Encl 1 Slot 2	OK	Array0 SeqNo1
PD3	TOSHIBA MC04ACA500E	SATA	4.55TB	Encl 1 Slot 3	OK	Array0 SeqNo2
PD4	TOSHIBA MC04ACA500E	SATA	4.55TB	Encl 1 Slot 4	OK	Array0 SeqNo3
PD5	TOSHIBA MC04ACA500E	SATA	4.55TB	Encl 1 Slot 5	OK	Array0 SeqNo4
PD6	TOSHIBA MC04ACA500E	SATA	4.55TB	Encl 1 Slot 6	OK	Array0 SeqNo5
PD7	TOSHIBA MC04ACA500E	SATA	4.55TB	Encl 1 Slot 7	OK	Array0 SeqNo6
PD8	TOSHIBA MC04ACA500F	SATA	4.55TB	Encl 1 Slot 8	OK	Array0 SeqNo7

The information listed for individual physical drives includes:

Physical Drive Information

- Physical Drive ID
- Location [Enclosure # Slot #]
- Alias
- Physical Capacity
- Configurable Capacity
- Used Capacity
- Block Size [Bytes]
- Operational Status
- Configuration Status
- Model
- Drive Interface
- Serial Number
- Firmware Version
- Protocol Version
- Visible To [Controller #]

Advanced Physical Drive Information

- Write Cache [*Enabled/Disabled*]
- Read Look Ahead Cache [*Enabled/Disabled*]
- SMART Feature Set
- SMART Self Test
- SMART Error Logging
- Command Queuing Support
- Command Queuing [*Enabled/Disabled*]
- Queue Depth
- Maximum Multiple DMA Mode Supported
- Maximum Ultra DMA Mode Supported
- DMA Mode
- Drive Temperature [C°/F°]
- Reference Drive Temperature
- Power Saving Mode

DISK ARRAYS AND LOGICAL DRIVES

Disk arrays and logical drives are created and managed using the **Disk Arrays** menu. Use the Array Configuration menu to view the Disk Array List, and to create and delete disk arrays on the enclosure. Expand the Disk Arrays icon in Tree View to view menu links for existing arrays. Each array icon can be expanded again to see the Logical Drives icon, and this can be expanded to see each logical drive icon.

For a detailed description of how to create disk arrays and logical drives using Promise Management GUI, please refer to the Quick Start Guide.

Use the top-level Disk Arrays menu to view the **Disk Array List**, to delete existing arrays, and to create new disk arrays using the Automatic, Express, or Advanced disk array creation menus. Note that there must be physical drives available in order to use any of the disk array creation menus.

View information for existing disk arrays by clicking on the icon in Tree View or the array name in the Disk Array List. Each individual array menu is used to create and delete logical drives, to change settings (Alias and start/stop PDM, Media Patrol and Power Management) for the array, or to start Background Activities including PDM, Rebuild and Transition.

Individual Disk Array menu

The screenshot displays the Promise Management GUI interface. On the left is a navigation tree with 'Disk Array 0' selected. The main area shows 'Disk Array 0' with tabs for 'Information', 'Settings', 'Create LD', 'Delete LD', and 'Background Activities'. Below the tabs is an 'Enclosure Front View' diagram of a 23-bay enclosure. A table at the bottom provides the following information:

Disk Array Information	
Disk Array ID	0
Alias	
Operational Status	OK
Total Physical Capacity	104.61TB
Configurable Capacity	685.45GB
Free Capacity	661.38GB
Max Contiguous Free Capacity	661.38GB
Media Patrol	Enabled
Drive Health Polling	Disabled
Power Management	Enabled
Number of Physical Drives	23

Information in the Disk Array menu includes:

- Disk Array ID [#]
- Alias
- Operational Status (see below)
- Total Physical Capacity
- Configurable Capacity
- Free Capacity [Bytes]
- Max Contiguous Free Capacity [Bytes]
- Media Patrol [*Enabled/Disabled*]
- Drive Health Polling
- Power Management [*Enabled/Disabled*]
- Number of Physical Drives
- Number of Logical Drives
- Available RAID Levels

Other lists in this menu:

- Physical Drives in the Disk Array
- Logical Drives in the Disk Array
- Available Spare Drives to the Disk Array

Disk Array Operational Status

OK – This is the normal state of a logical drive. When a logical drive is Functional, it is ready for immediate use.

For RAID Levels other than RAID 0, the logical drive has full redundancy.

Synchronizing – This condition is temporary. Synchronizing is a maintenance function that verifies the integrity of data and redundancy in the logical drive. When a logical drive is Synchronizing, it will function and your data is available. However, access will be slower due to the synchronizing operation.

Critical / Degraded – This condition arises as the result of a physical drive failure. A degraded logical drive will still function and your data is still available. However, the logical drive has lost redundancy (fault tolerance). You must determine the cause of the problem and correct it.

Rebuilding – This condition is temporary. When a physical drive has been replaced, the logical drive automatically begins rebuilding in order to restore redundancy (fault tolerance). When a logical drive is rebuilding, it will function and your data is available. However, access will be slower due to the rebuilding operation.

LOGICAL DRIVE MANAGEMENT

Logical drives are made from disk arrays. In the Tree, you can see a graphic representation of the logical drives that belong to each array. The Logical Drive List can be accessed in Tree View by expanding the under Disk Arrays and clicking on the Logical Drives icon for any existing disk array, or simply click on the **Logical Drive Summary** icon for the Subsystem.

Click on any Logical Drive (LD) in the list to view Information and Statistics, to change Settings (Alias, Read Policy, Write Policy), to start Background Activities (Initialization, Redundancy Check), or to view the Check Table for the LD.

Information displayed in the menu includes:

- Logical Drive ID
- Alias
- Raid Level
- Operational Status
- Capacity
- Physical Capacity
- Number of Axles [#]
- Number of Used Physical Drives [#]
- Stripe Size
- Sector Size [Bytes]
- Disk Array ID
- Read Policy
- Write Policy
- Current Write Policy
- Serial Number
- WWN
- Synchronized [Yes/No]
- Tolerable Number of Dead Drives Per Axle
- Parity Pace
- Codec Scheme

SPARE DRIVES

When a physical drive in a disk array fails and a spare drive of the same type and adequate capacity is available, the disk array will begin to rebuild automatically using the spare drive.

In Tree View, click on the Spar Drive icon to see the Spare Drives List, or to create or delete an existing spare drive. Click on any spare drive in the list to information about the drive. Spare Drive Information includes:

- Spare Drive ID
- Physical Drive ID
- Spare Type
- Revertible [Yes/No]
- Operational Status
- Spare Check Status
- Physical Capacity
- Configurable Capacity
- Block Size
- Drive Interface
- Model
- Location
- Configuration Status
- Serial Number
- Firmware Version

RUNNING SPARE CHECK

A Spare Check verifies the operational status of your spare drives. You can also schedule a Spare Check.

To check a spare drive:

1. Click the Spare Drives icon.
2. Click the Spare Check tab.
3. From the Physical Drive drop-down menu, choose the spare drive you want to check. Or choose All to check all the spare drives at the same time.
4. Click the **Submit** button.

The results of the Spare Check appear under Spare Check Status in the Information tab. “Healthy” means normal condition.

LOGICAL DRIVE SUMMARY

The Logical Drive Summary displays a list of all logical drives in the Subsystem. This list does not arrange the logical drives under the disk array to which they belong nor under the enclosure in which they are located. The menu functions in the same way as the Logical Drives menu discussed in “Logical drive management” on page 71

MAINTENANCE

This chapter covers the following topics:

- “Replacing a Power Supply”

REPLACING A POWER SUPPLY

The Vess A7600 systems can accommodate two AC power supplies in the bay at the rear of the chassis. The Vess A7800 systems can accommodate three AC power supplies in the bay at the rear of the chassis. Each unit provides up to 550 Watts of power. Only a single power supply is required for operation, with the second power supply purely as a redundant, load-sharing backup. It can be removed without affecting system operation.

Installing and Removing the Power Supply

1. Align the power supply unit with the power supply slot. Ensure that the LED appears on the left when you are installing the power supply unit.
2. Carefully slide the PSU all the way into the power supply bay until it clicks into place.

REMOVING THE POWER SUPPLY UNIT

To remove a failed power supply, please first identify the failed power supply .

1. Hold onto the power supply handle while pressing the locking lever towards the power supply handle.
2. Pull to remove the power supply from the chassis.

- 1. Before replacing the power supply, power off the server, unplug the power cord, and disconnect all wiring from the power supply.**
- 2. In a redundant system, you do not need to power down the server.**

FAQ

Q: What is Vess A7000 Series Storage Appliance for Video Surveillance?

A: The Vess A7000 platforms are engineered specifically to be the best solution for midsize to large IP video surveillance deployments.

Q: How does it work for surveillance video recording?

A: The Vess A7000 comes complete with your choice of Windows OS, a leading Video Management Software suite, or Disk Drives, minimizing the integration and installation process. Users no longer need an extra PC/server, add-on cards, or a separate connected storage for a complete video surveillance system; the Vess A7000 Series Storage Appliance for Video Surveillance does it all!

Q: What should I do if the device OS fails?

A: Unlike regular COTS servers that come with standard Windows OS, the Vess A7000 provides an embedded version that requires a certain process to rebuild the OS image. Users need to consult Promise tech support and follow installation guide to complete the setup.

Q: What's the standard warranty of Vess A7000?

A: We provide the same standard three (3) years hardware warranty from the time of the delivery of the product to the original end user.

Q: Can I purchase extended warranty package to Vess A7000?

A: Yes, we provide 2-year extended warranty program that uses the same order and support practice as Vess A7000 product series.

TROUBLESHOOTING

This section focuses on how to address issues that might appear during the lifetime of the Vess A7000 enclosure. Common issues that customers might see include hard drive problems and how to know when there is a problem with a hard drive, and how to create and send a service report to technical support.

If a hard drive has errors, is about to fail or has already failed, it will need to be replaced. Follow the instructions in “Installing Disk Drives” on page 25 to swap out bad hard drives.

This chapter includes the following troubleshooting sections and related information:

- “How do I know when a drive is failing?”
- “How to Rebuild a Disk Array”
- “The Alarm Buzzer is Sounding, what does this mean?”
- “How to disable the alarm buzzer”
- “How to Save a Service Report”



Note

Hard drives on the Vess A7000 models can be hot swapped, that is, they can be replaced without first shutting down the system.



Note

Follow the instructions in “Installing Disk Drives” on page 25 to swap out bad hard drives.

HOW DO I KNOW WHEN A DRIVE IS FAILING?

There are many options to determine the health of physical hard drives. In Web PAM PROe, you can either use the Event Frame or go to the Physical Drives information display. Or you can simply check the status LED of the drives on the device.

CHECK DRIVE STATUS LEDs

The quickest way to check drive status if you are near the device is to simply look at the hard drive status LED indicators, then use the other LED indicators to help diagnose any problems that might exist.

Vess A7600 front

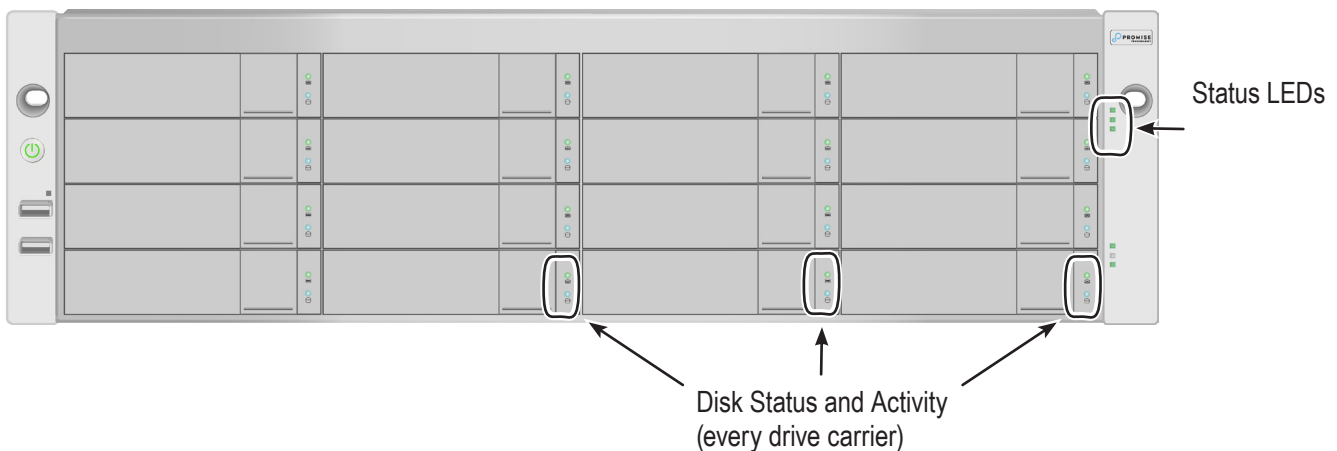

Status LED behavior

HDD Status	The Disk Status LED displays GREEN when a drive is configured and working properly. When the lights are RED the HDD requires manual replacement. When ORANGE is observed it indicates background RAID activity on this particular HDD and no user action is required.
System Status	Lights GREEN when healthy, RED if there is a critical problem (LD offline, fan malfunction, voltage out of range, system temperature alert), blinks RED for HDD high temperature alert remains dark when not ready. This will be RED if a hard drive has failed or has critical errors. Replace the drive corresponding to the RED HDD Status indicator.
Global RAID Status	Lights GREEN when healthy or RED if any RAID volume is offline, ORANGE for critical state of any logical drive. If a hard drive has failed, this will be ORANGE. In this case, it will be necessary to replace the affected drive and rebuild the affected RAID volume.

The Vess A7000 models have hard drive status and activity LEDs on each drive carrier. Also check the status indicators on the right side of the front of the device for clues about what is wrong.

Hard drive carrier front LEDs

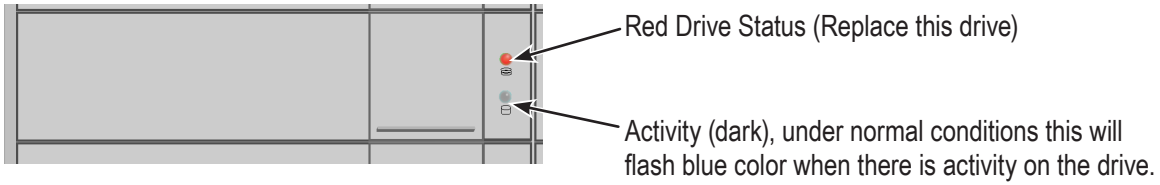

Vess A7800 status LEDs on right side of front

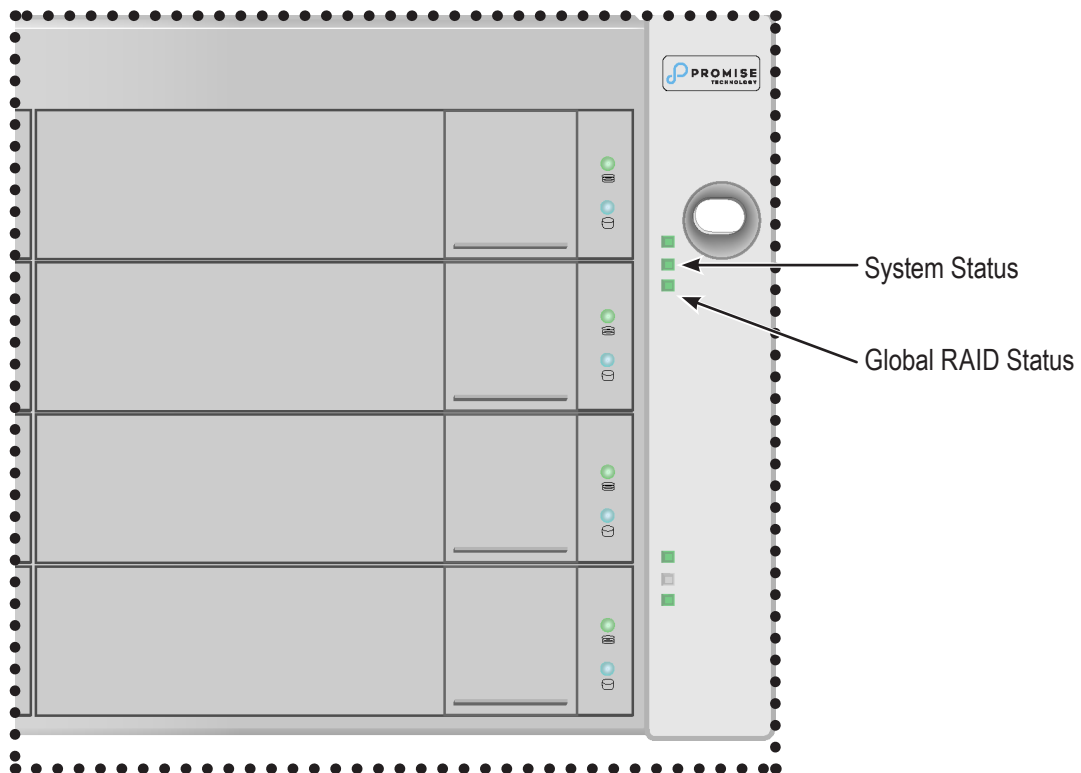

CHECK DRIVE STATUS IN MANAGEMENT GUI

To see the Event Frame, click **Show Event Frame** in the Web PAM PROe Header and check the list under **Device**, any physical drive problems will be indicated in the right most column, the top rows of the event table list the installed physical drives.

Also, in Management GUI, you can go to the **Physical Drives List**. To see the Physical Drives List, expand the individual Enclosure icon in Tree View to see the Physical Drives icon for the enclosure. To display the information for any populated slot, you can expand the Physical Drives icon in Tree View to reveal links to each slot, or click on the slot in the Physical Drives List, or click on the populated slot in the virtual enclosure displayed in the menu.

View physical drive list

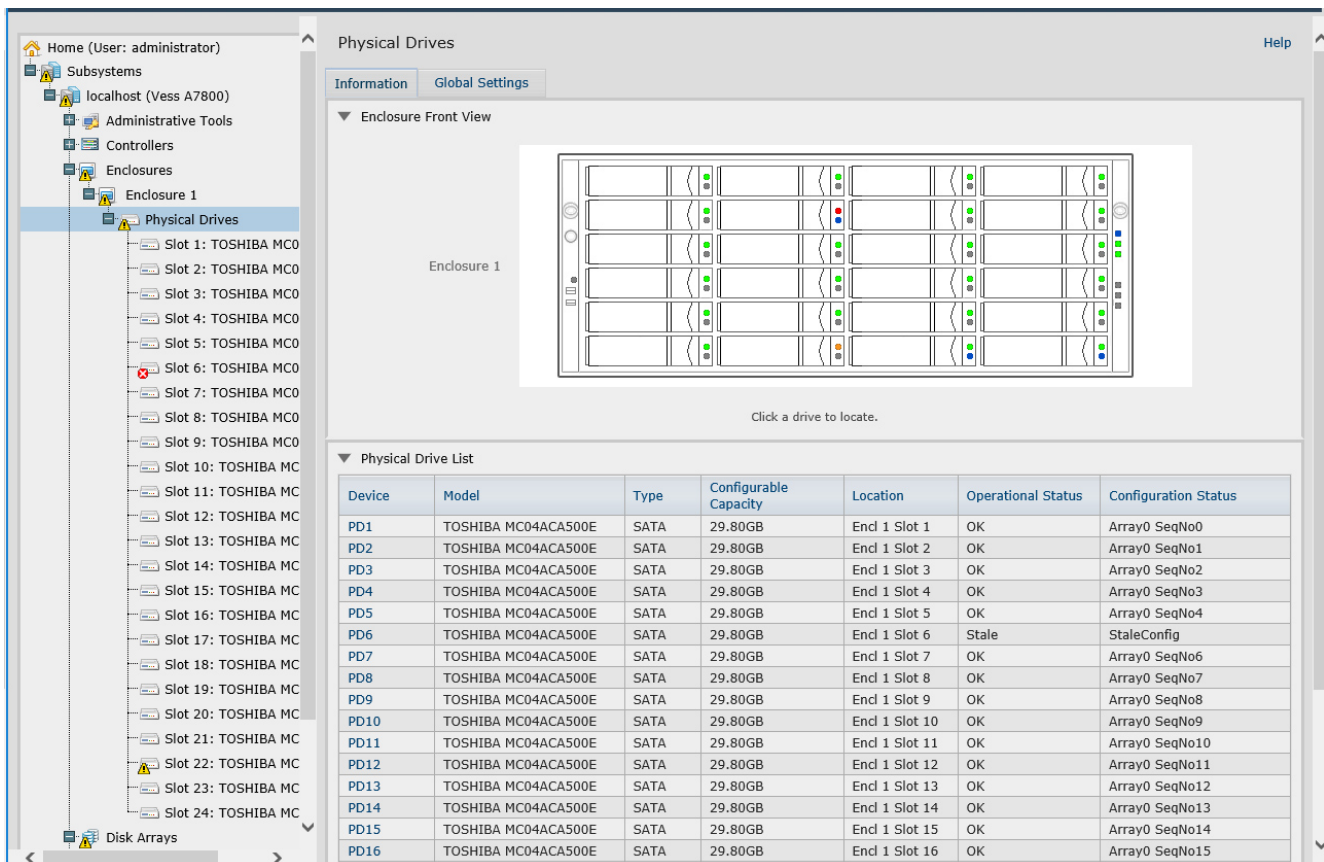

The screenshot shows the Management GUI interface. On the left, a tree view shows the navigation structure: Home (User: administrator) > Subsystems > localhost (Vess A7800) > Enclosures > Enclosure 1 > Physical Drives. The main content area is titled 'Physical Drives' and has two tabs: 'Information' (selected) and 'Global Settings'. Under 'Information', there is an 'Enclosure Front View' section showing a diagram of the enclosure with 16 drive slots. Below the diagram is the text 'Click a drive to locate.'. The 'Physical Drive List' section contains a table with the following data:

Device	Model	Type	Configurable Capacity	Location	Operational Status	Configuration Status
PD1	TOSHIBA MC04ACA500E	SATA	29.80GB	Encl 1 Slot 1	OK	Array0 SeqNo0
PD2	TOSHIBA MC04ACA500E	SATA	29.80GB	Encl 1 Slot 2	OK	Array0 SeqNo1
PD3	TOSHIBA MC04ACA500E	SATA	29.80GB	Encl 1 Slot 3	OK	Array0 SeqNo2
PD4	TOSHIBA MC04ACA500E	SATA	29.80GB	Encl 1 Slot 4	OK	Array0 SeqNo3
PD5	TOSHIBA MC04ACA500E	SATA	29.80GB	Encl 1 Slot 5	OK	Array0 SeqNo4
PD6	TOSHIBA MC04ACA500E	SATA	29.80GB	Encl 1 Slot 6	Stale	StaleConfig
PD7	TOSHIBA MC04ACA500E	SATA	29.80GB	Encl 1 Slot 7	OK	Array0 SeqNo6
PD8	TOSHIBA MC04ACA500E	SATA	29.80GB	Encl 1 Slot 8	OK	Array0 SeqNo7
PD9	TOSHIBA MC04ACA500E	SATA	29.80GB	Encl 1 Slot 9	OK	Array0 SeqNo8
PD10	TOSHIBA MC04ACA500E	SATA	29.80GB	Encl 1 Slot 10	OK	Array0 SeqNo9
PD11	TOSHIBA MC04ACA500E	SATA	29.80GB	Encl 1 Slot 11	OK	Array0 SeqNo10
PD12	TOSHIBA MC04ACA500E	SATA	29.80GB	Encl 1 Slot 12	OK	Array0 SeqNo11
PD13	TOSHIBA MC04ACA500E	SATA	29.80GB	Encl 1 Slot 13	OK	Array0 SeqNo12
PD14	TOSHIBA MC04ACA500E	SATA	29.80GB	Encl 1 Slot 14	OK	Array0 SeqNo13
PD15	TOSHIBA MC04ACA500E	SATA	29.80GB	Encl 1 Slot 15	OK	Array0 SeqNo14
PD16	TOSHIBA MC04ACA500E	SATA	29.80GB	Encl 1 Slot 16	OK	Array0 SeqNo15

View individual physical drive information

Physical Drive 1

Information Settings Force Offline

Enclosure Front View

Enclosure 1

Current drive location is highlighted. To choose a new drive click on the desired location.

Physical Drive Information

Physical Drive ID	1
Location	Enclosure 1 Slot 1
Alias	
Physical Capacity	4.55TB
Configurable Capacity	29.80GB
Used Capacity	128MB
Block Size	512 Bytes
Operational Status	OK
Configuration Status	Array0 SeqNo0
Model	TOSHIBA MC04ACA500E
Drive Interface	SATA 6Gb/s
Serial Number	84B3K01YFLRA
Firmware Version	FP2A
Protocol Version	ATA/ATAPI-8
Visible To	Controller 1

Advanced Physical Drive Information



Note

In order that hard disk problems can be anticipated and dealt with smoothly, it is highly recommended to make sure that Media Patrol is enabled and running and Auto Rebuild is enabled if you are not using a spare drive. If using a spare drive, make sure it is healthy and available.

ANTICIPATING HARD DRIVE PROBLEMS

It is recommended that you always keep a healthy spare drive installed, and run Media Patrol as a background activity so a failing hard drive can migrate data to the spare before the status turns critical.

In Web PAM PROe, Media Patrol is enabled or disabled using the Background Activities menu, you can also create a schedule to run Media Patrol.

Enable Media Patrol

The screenshot shows the 'Background Activities' settings page in the Vess A7000 Storage Appliance web interface. The left sidebar shows the navigation tree with 'localhost (Vess A7800)' selected. The main content area has tabs for 'Information', 'Settings', 'Event', 'Background Activities', 'Scheduler', and 'Lock'. The 'Background Activity Settings' table is expanded, showing various parameters and their values. The 'Enable Media Patrol' checkbox is checked, and the 'Enable Auto Rebuild' checkbox is also checked.

Background Activity Settings		
Rebuild Rate	High	
Background Synchronization Rate	High	
Logical Drive Initialization Rate	Medium	
Redundancy Check Rate	High	
Migration Rate	High	
PDM Rate	High	
Transition Rate	Medium	
Reassigned Block Threshold [1-512]	32	Blocks
Error Block Threshold [1-2048]	32	Blocks
Enable Media Patrol	<input checked="" type="checkbox"/>	
Enable Auto Rebuild	<input checked="" type="checkbox"/>	

Buttons: Reset, Submit, Cancel

- To enable Media Patrol, click on **Background Activities** in the Quick Links menu in the **Home** page, or, click on the **Subsystem** in Tree View then click on the **Background Activities** menu tab, click the expander to the right of the tab and select the **Settings** option from the pull down menu. Click to check the **Enable Media Patrol** option. Notice also that the **Auto Rebuild** option is here as well. If you want to automatically begin rebuilding a logical drive as soon as a faulty drive is replaced, make sure this option is enabled.
- To begin running Media Patrol manually, click on the menu expander to the right of the Background Activities tab and scroll down and select **Start Media Patrol** to see the Start Media Patrol menu. Then click on the **Start** button.
- To schedule Media Patrol, click on the menu expander to the right of the Scheduler tab and scroll down and select **Add Media Patrol Schedule** to open the schedule menu. Use this menu to add a Media Patrol schedule.

REBUILDING A DISK ARRAY

When you rebuild a disk array, you are actually rebuilding the data on one physical drive.

- When a physical drive in a disk array fails and a spare drive of adequate capacity is available, the disk array begins to rebuild automatically using the spare drive.
- If there is no spare drive of adequate capacity, but the Auto Rebuild function is ENABLED, the disk array begins to rebuild automatically as soon as you remove the failed physical drive and install an unconfigured physical drive in the same slot. See “Making Rebuild Settings”
- If there is no spare drive of adequate capacity and the Auto Rebuild function is DISABLED, you must replace the failed drive with an unconfigured physical drive, then perform a Manual Rebuild.

HOW TO REBUILD A DISK ARRAY

When a physical drive is indicated to be degraded or in critical state, the array that contains that drive needs to be rebuilt. If you are not using Auto Rebuild (requires a Spare Drive), then you must rebuild the array manually after the affected drive has been replaced. Follow the instructions here to rebuild an array.

You will know that a logical drive is critical by looking at the **Operational Status** in the **Logical Drive Information** display.

Logical Drive Information

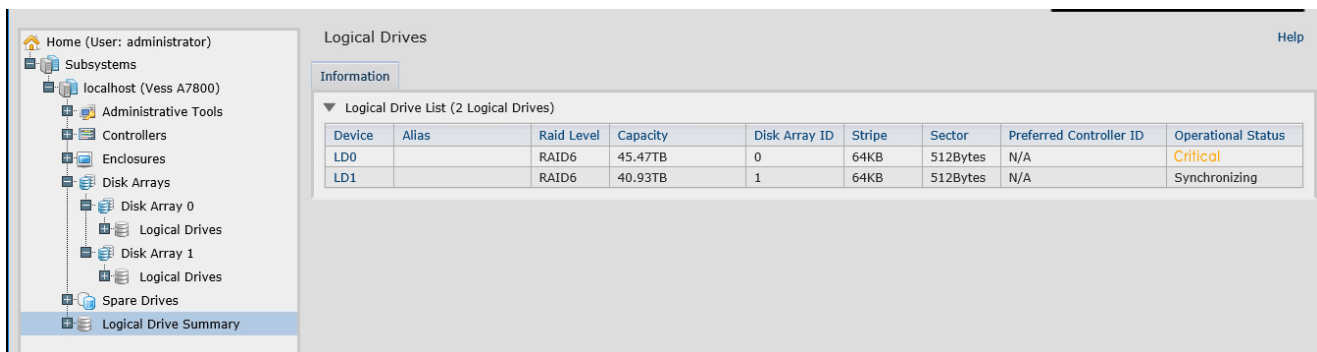

Device	Alias	Raid Level	Capacity	Disk Array ID	Stripe	Sector	Preferred Controller ID	Operational Status
LD0		RAID6	45.47TB	0	64KB	512Bytes	N/A	Critical
LD1		RAID6	40.93TB	1	64KB	512Bytes	N/A	Synchronizing

To begin rebuilding the drive, go to the **Local Host** menu, the **Background Activities** and move the cursor to select **Start Rebuild**. A new menu appears.

Background Activities - Start Rebuild 1

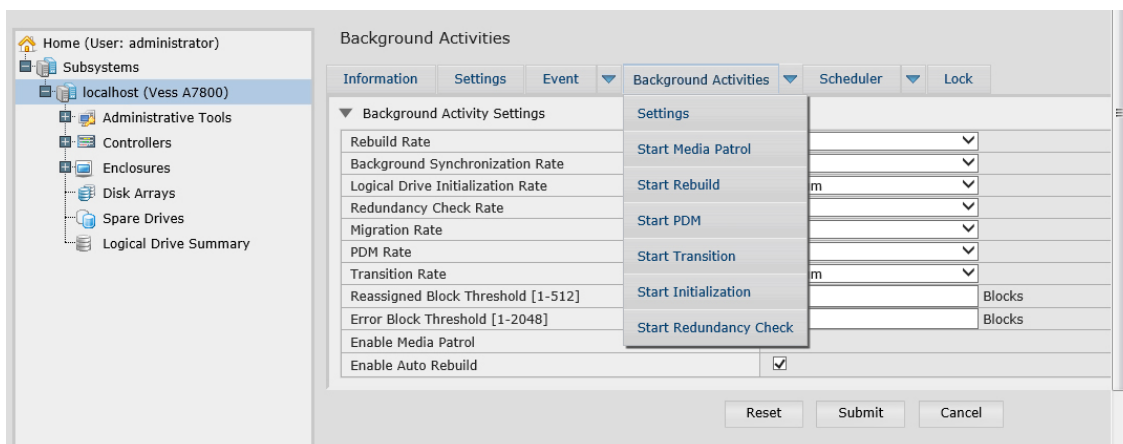

Background Activity Settings	Settings	Scheduler	Lock
Rebuild Rate	Start Media Patrol		
Background Synchronization Rate	Start Rebuild	m	
Logical Drive Initialization Rate	Start PDM		
Redundancy Check Rate	Start Transition		
Migration Rate	Start Initialization	m	
PDM Rate	Start Redundancy Check		
Transition Rate			
Reassigned Block Threshold [1-512]			Blocks
Error Block Threshold [1-2048]			Blocks
Enable Media Patrol			
Enable Auto Rebuild			<input checked="" type="checkbox"/>

Buttons: Reset, Submit, Cancel

Now determine the source and target for the rebuild. In the new menu, choose the **Source Physical Drive** and **Target Physical Drive** from the menus, and click on the **Submit** button.

Background Activities - Start Rebuild 2

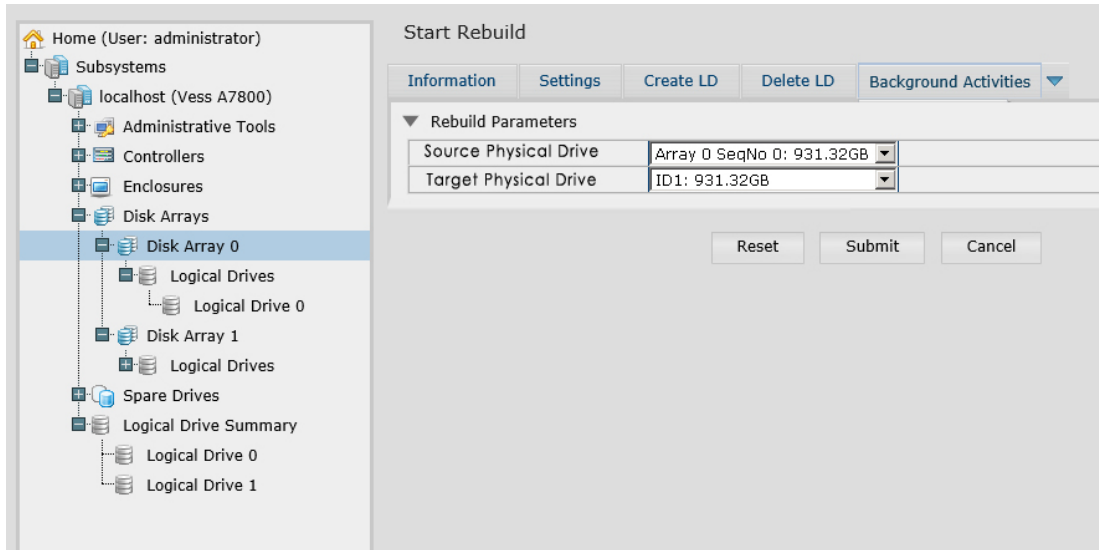

The progress of the rebuild is displayed in the Background Activities information display.

Background Activities - Rebuild Status

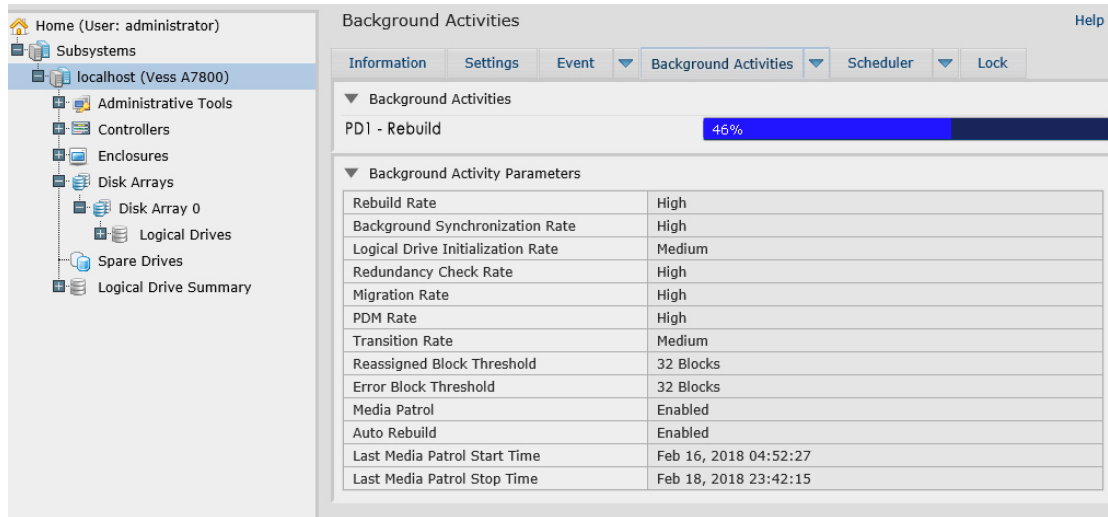

HOW TO SAVE A SERVICE REPORT

A Service Report is a detailed report covering the configuration and status of all components in your RAID system. A support technician or field engineer might request a service report for the purpose of diagnosis and troubleshooting.

Subsystem Information - Save Service Report

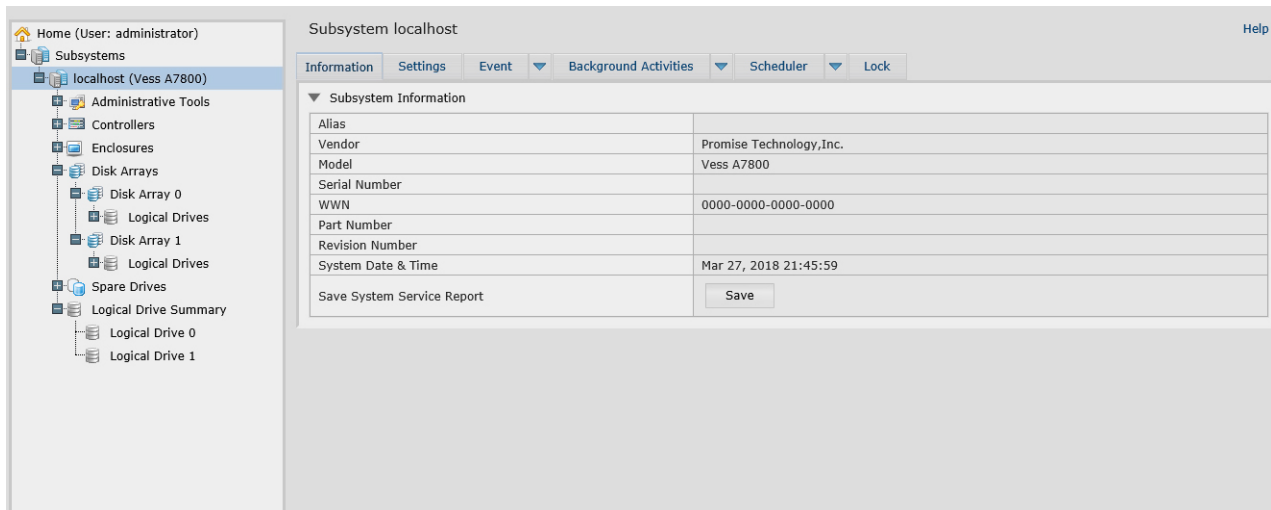

To save a system configuration file:

1. Click on the Subsystem icon (IP address and device name) in Tree View to open the Subsystem Information display.
2. Click the **Save** button in the Save System Service Report row of the information display.

Information for the report is gathered and compiled. This action takes up to a few minutes, depending on the size of your RAID system.

3. Determine where you want to store the file on the Host PC, then click the **Save** button in the pop-up menu.

The report saves to your Host PC as a compressed HTML file.

4. Double-click the downloaded file to decompress it.
5. Double-click the report to open it in your default browser.

Once you have the service report file, you can email it to a Technical Support representative.

The Service Report includes the following topics:

- About – Report utility
- BBM Info – Bad Block Manager
- BGA Summary – Status and settings
- Buzzer Info
- Controller Info
- Disk Array Info
- Disk Array Dump info
- Disk Array Verbose Info
- Enclosure Info
- Error Table Info
- Event Info - NVRAM
- Event Info - Runtime
- LogDrive Info – Basic logical drive information
- LogDrive Dump Info – Diagnostic information
- Logical Drive Verbose Info – Full logical drive information
- Network Info – Virtual port
- Phydriv Info – Basic physical drive information
- Phydriv Verbose Info – Full physical drive
- SWMGT Info – Software management
- Service Setting – Email
- Service Setting – Webserver
- Spare Info – Basic spare drive information
- Spare Dump Info – Diagnostic information
- Spare Verbose Info – Full spare Drive information
- Statistic Info
- Subsystem info
- User Info

THE ALARM BUZZER IS SOUNDING, WHAT DOES THIS MEAN?

When you first power-up the Vess A7000 system beeps twice to show normal operation.

The audible alarm sounds at other times to inform you that the system needs attention. But the buzzer alarm is not specific. Check the device LEDs and Events displays or logs for more information.

When the alarm sounds:

- Check the front and back of the enclosure for red or orange LEDs.
- If email notification is enabled, check for new messages.
- Check the event log.

When a continuous tone sounds, there are multiple alarm patterns sounding at the same time (see example number 1 illustrated below).

Alarm buzzer patterns

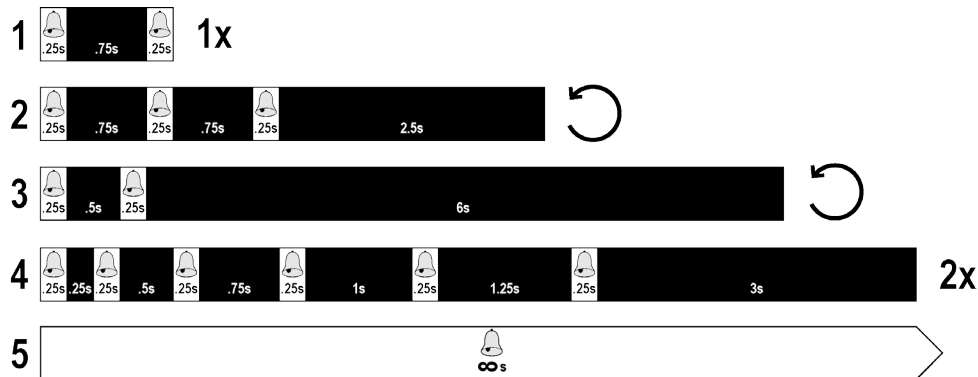

Other alarm patterns include three short buzzes followed by a longer silence, then repeated (example number 2 above). This can indicate a serious problem that requires immediate action such as high enclosure temperature or the system fan is not installed. If you hear this, check the System Status LED. If these are normal, it might indicate a physical drive problem, or a power supply problem. Check the event log for more information.

Pattern number 3 above might indicate an LD offline. Pattern number 4 might be an LD critical or bad sector on a physical disk.

HOW TO DISABLE THE ALARM BUZZER

To disable the buzzer with Web PAM PROe, open Web PAM PROe, click on the enclosure in Tree View, then click on the Buzzer menu expander, scroll to *Settings* and click the **Enable Buzzer** option box to remove the check mark. Click the **Submit** button.

APPENDIX: GRAPHICS CARD INSTALLATION



Warning

Turn off the power and disconnect the power cord before removing the FRU module.



Warning

Power consumption will be increased after installing an additional graphics card.

Power off the Vess A7000 model, disconnect the power. Then follow these instructions to install Graphics card hardware and connect SAS HBA card.

1. Grab the handle in the middle of the FRU module and pull it back and straight out.



2. Remove all screws of the cover, on top and the side.

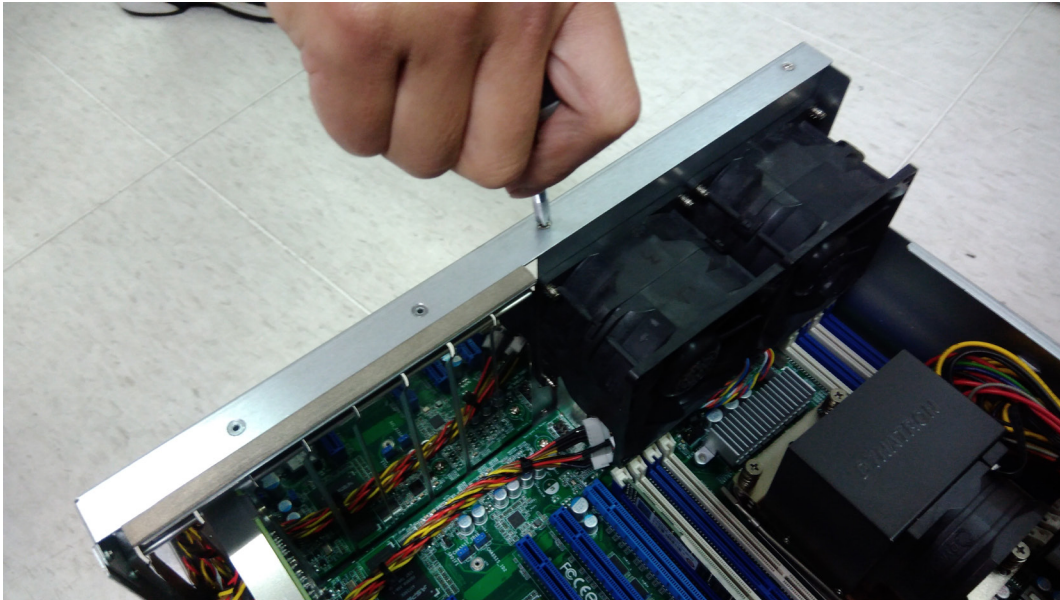

3. Remove the screw and bracket for the graphics card slot to be filled.

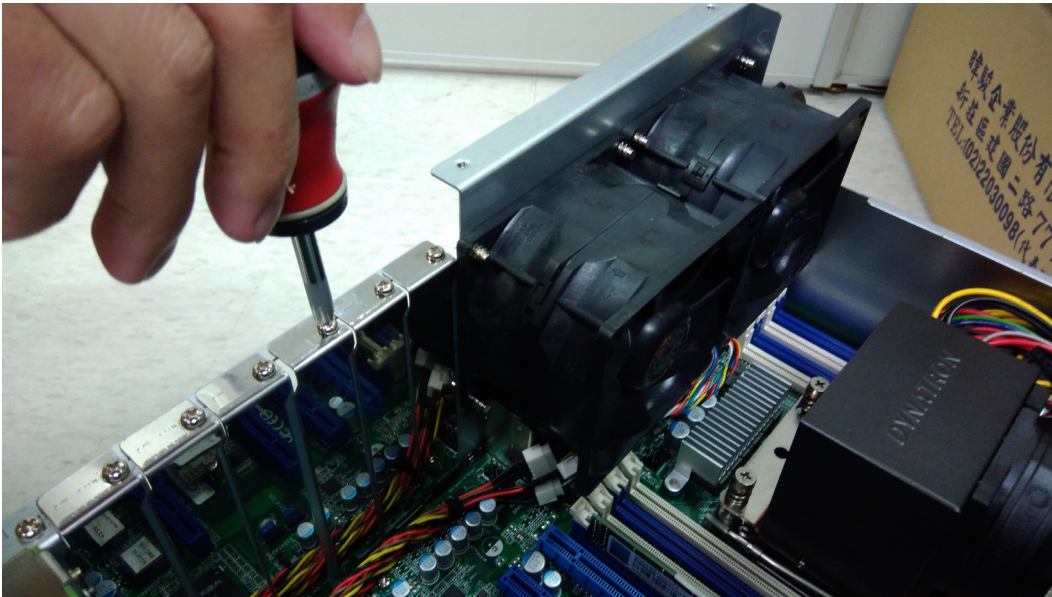

4. Use both hands to insert the graphics card into the slot until it is firmly seated in the graphics slot.



5. Anchor graphics card with screw.

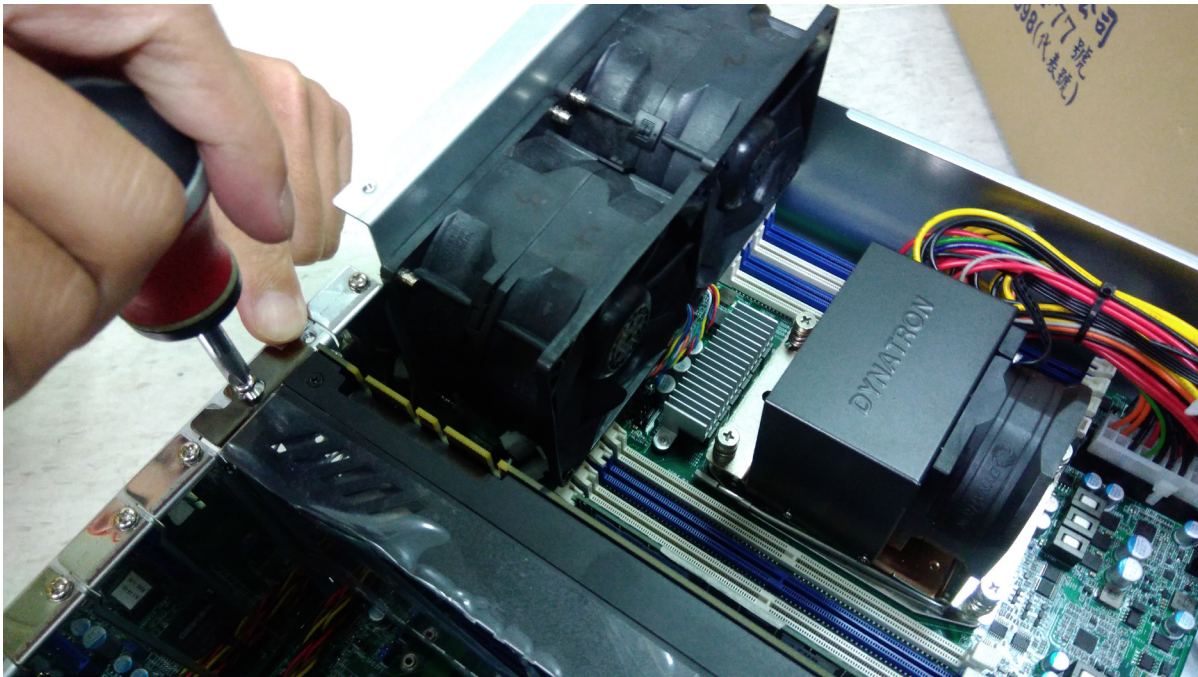

6. Plug in the connector to SAS HBA card.

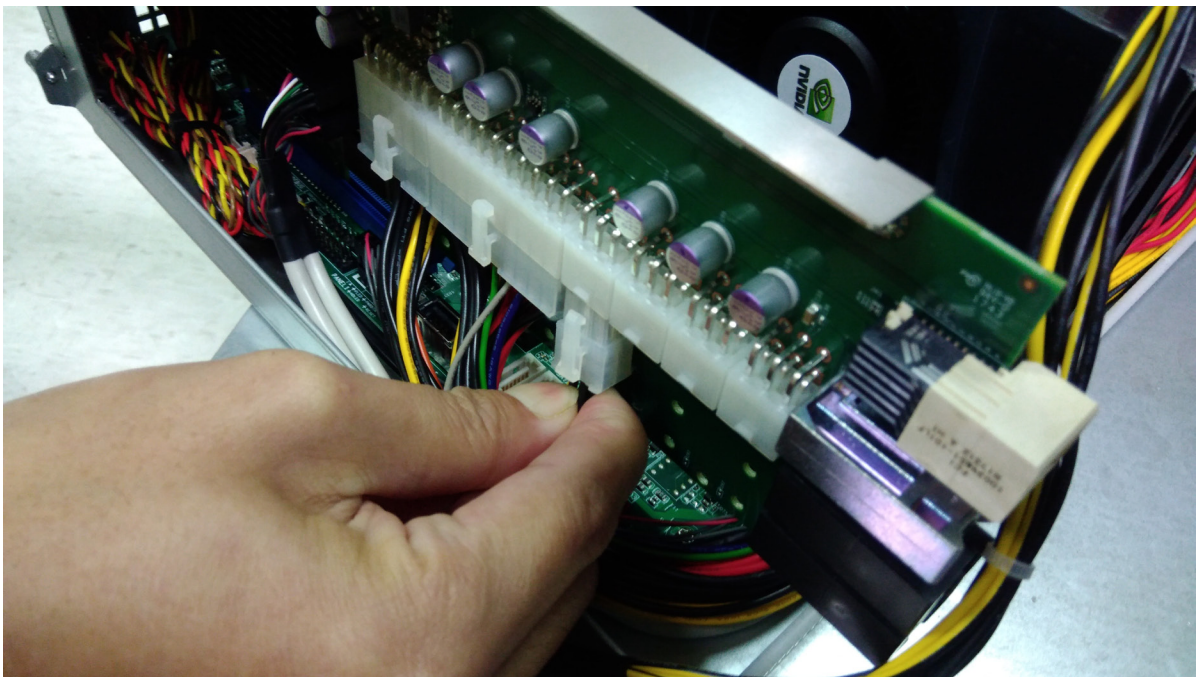

7. Replace the cover and fasten the screws.

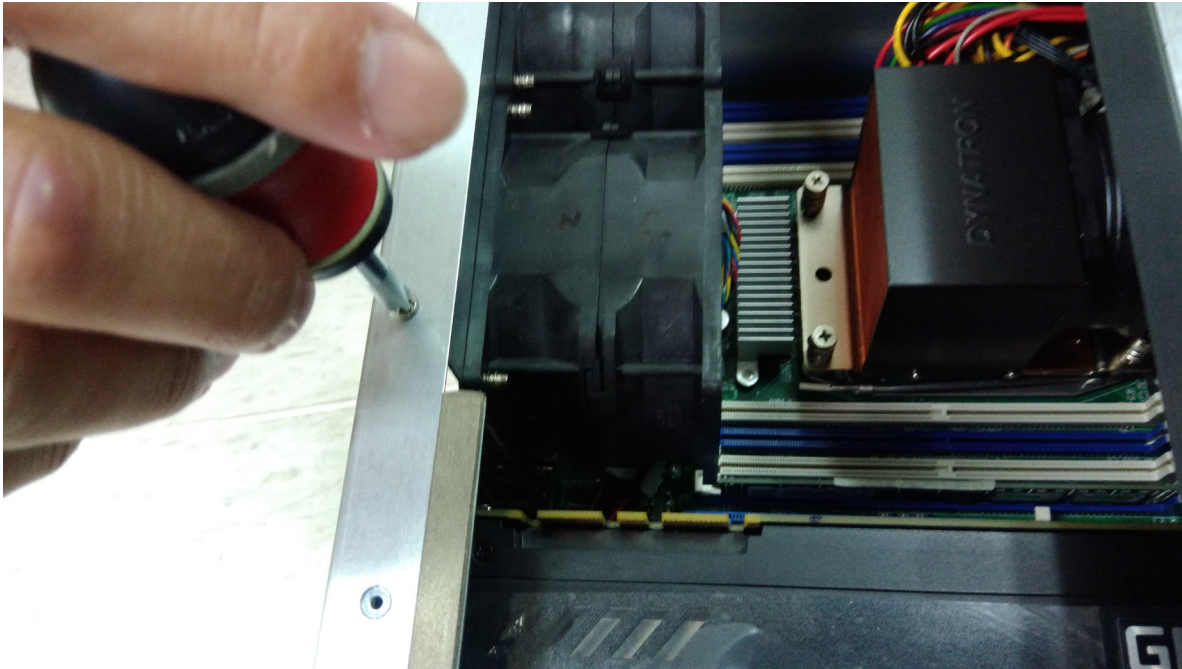

8. Replace the FRU module, push back into position.



APPENDIX: DRIVER INSTALLATION AND UPDATE

This appendix provides instructions for installing or updating the driver for the Promise RAID engine, as well as Management GUI, the management GUI for the Promise Vess A7000 Series.

Follow instructions in the ReadMe.txt file to install the latest hardware driver for the RAID and the latest Management GUI version.

UPDATE/INSTALLATION REQUIREMENTS

USB FLASH DRIVE

A USB flash drive containing the update package is needed. Follow the instructions in the ReadMe.txt file to download the compressed file package and place a copy of the uncompressed file on the USB flash drive.

UPDATE/INSTALL THE DRIVER

Follow instructions in the ReadMe.txt file for complete the installation or update of the driver.