

LINKSYS

USER GUIDE

AC1200

DUAL-BAND WiFi 5 ROUTER

Model E5600

Contents

Product Overview	3
Front.....	3
Back.....	4
Setting Up: Basics	5
Where to find more help	5
How to install your router	5
Advanced Configuration	7
How to open the browser-based utility.....	7
Basic Router Settings.....	8
Language.....	8
Internet Setup	9
Basic Wireless Settings	10
Wireless Security	12
Security Option Settings.....	12
WPA2 Personal	12
Disabled.....	12
Troubleshooting	13
Your router was not successfully set up.....	13
<i>Your Internet cable is not plugged in</i> message.....	14
<i>Cannot access your router</i> message.....	15
After setup.....	16
The internet appears to be unavailable	16
Specifications	18
Linksys E5600	18
Environmental.....	18

Product Overview

Front

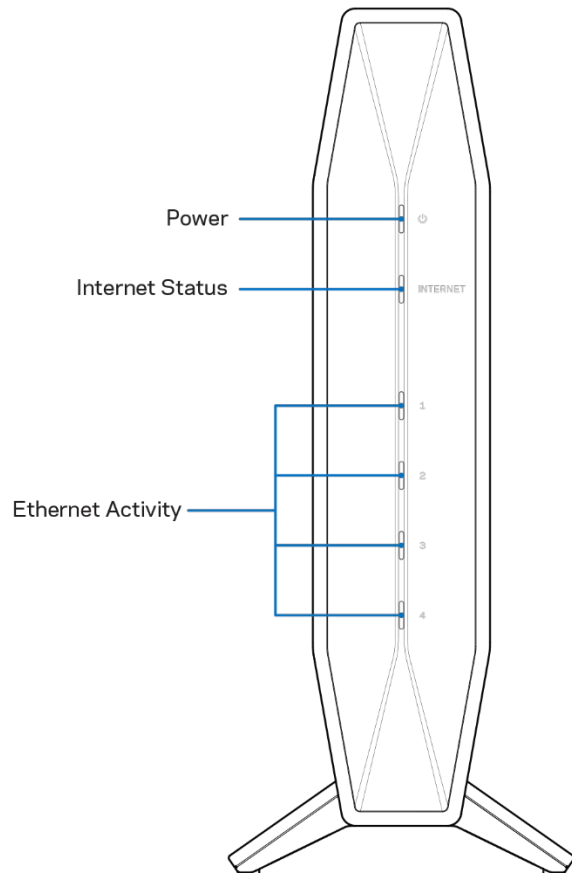

Power light—Blinks blue while router is starting up and during WPS pairing. Blinks yellow if WPS pairing fails

Internet status light—Is solid blue when connected to the internet and solid yellow when not connected.

Ethernet activity lights—Each light will be solid blue if an ethernet cable is connected to the corresponding port. They will blink blue if there is activity on the port.

Back

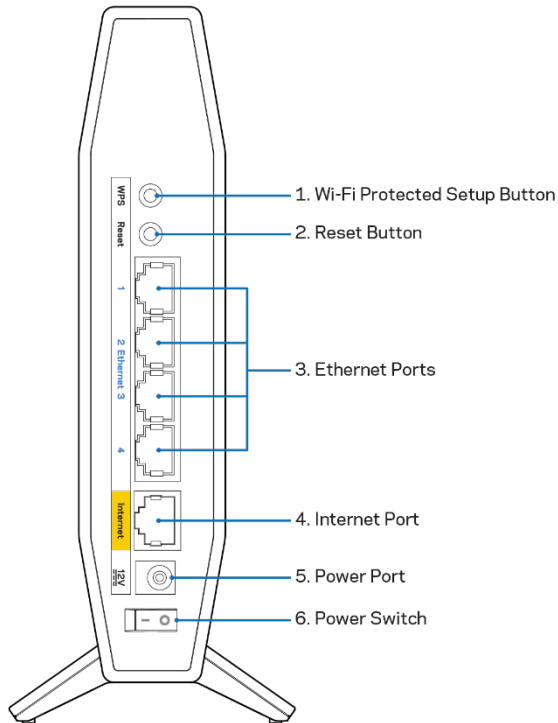

Wi-Fi Protected Setup™ (WPS) button (1)—Press to easily configure wireless security on Wi-Fi Protected Setup-enabled network devices. The light under the button will blink while WPS pairing is active.

Reset button (2)—Press and hold for until the power LED starts flashing to reset the router to factory settings.

Ethernet ports (3)—Connect Ethernet cables (also called network or internet cables) to these Fast Ethernet (10/100/1000) ports and to other wired devices on your network. The lights under the ports will light up only when an Ethernet cable is plugged in and there is data traffic on the cable.

Internet port (4)—Connect an Ethernet cable to this port and to your modem. The light under the port will light up only when an Ethernet cable is plugged in and there is data traffic on the cable.

Power port (5)—Connect the included AC power adapter to this port.

Power switch (6)—Press | (ON) to turn on the router.

Setting Up: Basics

Where to find more help

In addition to this user guide, you can find help at Linksys.com/support/E5600 (documentation, downloads, FAQs, technical support, live chat, forums)

Note—Licenses and notices for third party software used in this product may be viewed on <http://support.linksys.com/en-us/license>. Please contact <http://support.linksys.com/en-us/gplcodecenter> for questions or GPL source code requests.

How to install your router

1. If replacing an existing router, disconnect that router first.
2. Plug in the router to a power source. Make sure the power switch is in the | (ON) position.
3. Connect your new router to your modem or modem-router.

A Modem		B Modem-Router
Plug one end of the included ethernet cable into the yellow Internet port on your new router. If you have a modem, plug the other end into the Ethernet (LAN) port on the modem.	OR	Plug one end of the included ethernet cable to the yellow Internet port on your new router. If you have a modem-router, plug the other end into any available port.

4. Connect to the network name shown in the Quick Start Guide that came with your router. (You can change the network name and password later.) Select the option to automatically connect to this network in the future. If you need help connecting to the network refer to your device documentation on the provided CD.

Note—You will not have internet access until router setup is complete.

5. Enter <http://myrouter.local> in a web browser. Follow the on-screen instructions to complete setup. You also can enter 192.168.1.1 in a browser to start setup.

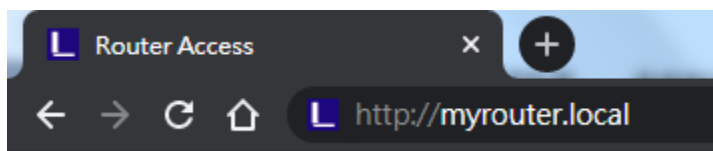

6. Once you are finished with setup, please be sure to register your router so we can keep you informed security updates, product recalls and other things that will improve your experience.

Register your product

Once you register we can share important security updates. Product recalls and other things that will improve your experience. All we need is your email. We will only use your email for limited security and customer support purposes.

Email Address

Linksys may also email me to keep up to date with special offers and information from linksys. You can unsubscribe at any time by using the link at the end of any email we send.[Read our Privacy Policy here.](#)

[Next](#) [Skip](#)

Advanced Configuration

How to open the browser-based utility

To access some advanced settings, you need to open the browser-based utility. Make sure you are connected to the router, open a web browser and enter <http://myrouter.local> in a web browser or go to 192.168.1.1.

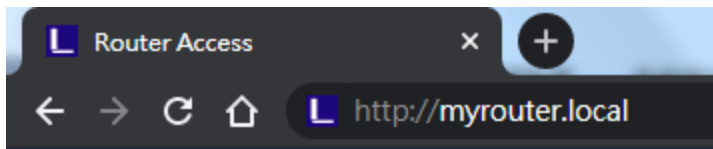

The router will prompt you for a password.

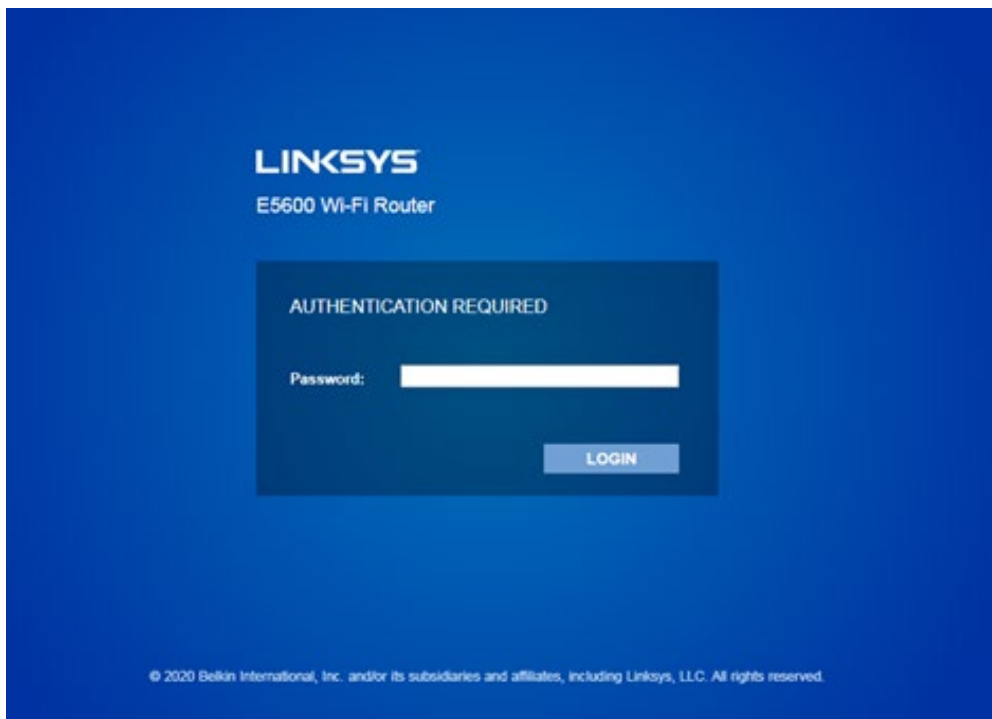

If you changed the password during setup, enter the new password. Click **LOGIN**. If you didn't change the password, or skipped setup altogether, the default password is "admin".

Basic Router Settings

This screen allows you to change the router's basic configuration.

The screenshot shows the Linksys router configuration interface. At the top, there is a blue header with the Linksys logo on the left and 'Log Out' and 'Help' links on the right. Below the header, the firmware version '1.0.1.77' and the model 'AC1200 Wi-Fi Router E5600' are displayed. The main navigation bar includes 'System Status', 'Configuration', 'Parental Controls', and 'Troubleshooting'. The left sidebar shows a tree view with 'Connectivity' expanded, containing 'Local Network', 'WAN Setup', 'VLAN Setup', 'IPv6 Setup', 'MAC Address Clone', and 'Advanced Routing'. The 'Local Network' section is active, showing 'Router Address' with IP '192.168.1.1' and Subnet Mask '255.255.255.0'. Below that is the 'DHCP Server Setting' section, which has a checked 'DHCP Server' option and a 'DHCP Reservation' button. Other settings include 'Start IP Address' (192.168.1.100), 'Maximum Numbers of Users' (50), 'IP Address Range' (192.168.1.100 to 149), 'Client Lease Time' (0 minutes), and three 'Static DNS' fields (all 0.0.0.0) and 'WINS' (0.0.0.0). 'Save' and 'Cancel' buttons are at the bottom.

Language

Select your language—To change language, select one from the drop-down menu. The language of the browser-based utility will change within five seconds.

The screenshot shows the Linksys router configuration interface for the 'Language' settings. The top header and navigation bar are identical to the previous screenshot. The left sidebar shows 'Administration' expanded, with 'Language' selected. The main content area is titled 'Language' and features a 'Select your language' label next to a drop-down menu currently set to 'English'. 'Save' and 'Cancel' buttons are located at the bottom of the configuration area.

Internet Setup

The Internet Setup section configures the router to your internet connection. This information can be provided by your Internet Service Provider (ISP).

Internet Connection Type—Select the type of internet connection your ISP provides from the drop-down menu.

The screenshot shows the Linksys configuration interface for the WAN Setup section. The 'Internet Setup' section has the 'Automatic Configuration - DHCP' option selected. The 'Optional Settings' section includes fields for Host Name, Domain Name, MTU (set to Auto), and Size (set to 1500). The 'Save' button is highlighted in blue.

- **Automatic Configuration - DHCP (default)**
Keep the default only if your ISP supports DHCP or if you connect using a dynamic IP address. (This option usually applies to cable connections.)
- **Static IP**
Select if you are required to use a fixed IP address to connect to the internet.
- **PPPoE**
Select if you have a DSL connection and your ISP uses Point-to-Point Protocol over Ethernet (PPPoE).
- **PPTP**
Point-to-Point Tunneling Protocol (PPTP) is a service that generally applies to connections in Europe. If your PPTP connection supports DHCP or a dynamic IP address, select *Obtain an IP Address Automatically*. If you are required to use a fixed IP address to connect to the internet, select *Specify an IP Address* and configure the options that appear.
- **L2TP**
Layer 2 Tunneling Protocol (L2TP) is a service that generally applies to connections in Israel.
Note—*Connect on Demand or Keep Alive are options when choosing PPPoE, PPTP and L2TP. They let you choose whether the router connects to the internet only as needed (useful if your ISP charges for connect time), or if the router should always be connected. Select the appropriate option.*

- **Bridge Mode**

Bridge Mode disables all router capabilities and turns the router into an access point. The router will cease to act as a DHCP server and its built-in firewall as well as the NAT features will no longer be in effect.

- **Wireless Bridge**

A wireless bridge wirelessly connects to your main router and can share the internet connection with devices connected to the bridge's Ethernet ports.

Basic Wireless Settings

The screenshot shows the Linksys configuration interface for an AC1200 Wi-Fi Router (E5600). The top navigation bar includes 'System Status', 'Configuration', 'Parental Controls', and 'Troubleshooting'. The 'Configuration' section is active, and the left sidebar shows 'Connectivity' > 'Wi-Fi' > 'Basic Wireless Settings' selected. The main content area is titled 'Basic Wireless Settings' and is divided into two sections: '5 GHz Wireless Settings' and '2.4 GHz Wireless Settings'. Each section has a 'Network Mode' dropdown menu, a 'Network Name (SSID)' text input, 'Channel Width' and 'Channel' dropdown menus, and a checked 'SSID Broadcast' checkbox. The 5 GHz settings show 'Mixed(A/N/AC)' for Network Mode and 'Linksys00012_5GHz' for SSID. The 2.4 GHz settings show 'Mixed' for Network Mode and 'Linksys00012' for SSID.

Network Mode—Select the wireless standards your network will support.

- **Mixed** (default)

Keep the default if you have Wireless-N, Wireless-N, and Wireless-AC devices in your network.

- **Wireless-A Only**

Select if you have only Wireless-A devices.

- **Wireless-N Only**

Select if you have only Wireless-N devices.

- **Disabled**

Select if you have no Wireless-A, Wireless-N, and Wireless-AC devices in your network.

Note—You may select *Mixed, Wireless-N/AC Only or Disabled for the 5 GHz band. If you are not sure which mode to select, keep the default, Mixed.*

Network Name (SSID)

The Service Set Identifier (SSID) is a name used by devices to connect to a wireless network. SSIDs are case-sensitive and must not exceed 32 characters. The default SSIDs for the 2.4 GHz and 5 GHz networks are LinksysXXXXX and LinksysXXXXX_5GHz, respectively. The Xs represent the last five digits of the router's serial number, which can be found on the bottom of the router. If you changed the SSID, both bands have the new SSIDs. You may give them different names through the browser-based utility.

Note—*If you restore the router's factory default settings (by pressing the Reset button or using the Administration > Factory Defaults screen), the Network Name will return to its default value. Change the Network Name back to its original name, or you will have to reconnect all devices on your wireless network to the new network name.*

Channel Width

Keep the default, Auto (20 MHz or 40 MHz), for best performance in a 2.4 GHz network using Wireless-B, Wireless-G and Wireless-N devices. For a channel width of 20 MHz, select 20 MHz only. For the best performance in a 5 GHz network, keep the default 20, 40 or 80 MHz.

Channel

Select the channel from the drop-down list. Keep the default, Auto, if you are not sure which channel to select.

SSID Broadcast

Keep the default, Enabled, to broadcast the router's SSID. When wireless clients survey the local area for wireless networks to associate with they will detect the SSID broadcast by the router. Attempting to hide your Wi-Fi name does not make your Wi-Fi more secure. Anyone truly interested in accessing your network can find it even if you turn off this feature. If you still do not want to broadcast the router's SSID, select Disabled.

Wireless Security

The router offers the following wireless security options:

WPA2 Personal (WPA stands for Wi-Fi Protected Access.)

Security Option	Strength
WPA2 Personal	Strongest

Security Option Settings

WPA2 Personal

If you select WPA2 Personal, each device in your wireless network MUST use WPA2 Personal and the same passphrase.

Security Mode

Passphrase—Enter a passphrase of 8-63 characters. This is the Wi-Fi password that provides access to the network. It can be the same as entered in setup.

Disabled

If you choose to disable wireless security, you will be informed that wireless security is disabled when you first attempt to access the internet. You will be given the option to enable wireless security, or confirm that you understand the risks but still wish to proceed without wireless security.

Security Mode

Troubleshooting

You can find more help from our award-winning customer support at Linksys.com/support/E5600.

Your router was not successfully set up

If you could not complete setup in the browser-based interface, you can try the following:

- Press and hold the Reset button on your router with a paperclip or pin until the power light on the front of the router turns off and starts blinking (about 10 seconds). Type 192.168.1.1 in a browser to try setup again.

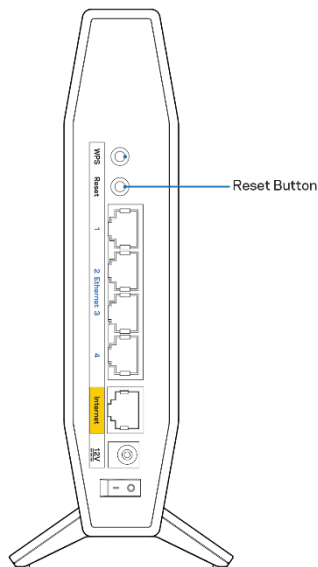

- Temporarily disable your computer's firewall (see the security software's instructions for help). Install the router again.
- If you have another computer, use that computer to install the router.

Your Internet cable is not plugged in message

If you get a “Your Internet cable is not plugged in” message when trying to set up your router:

- Make sure that an ethernet or internet cable (or a cable like the one supplied with your router) is securely connected to the yellow Internet port on the back of the router and to the appropriate port on your modem. This port on the modem is usually labeled Ethernet.

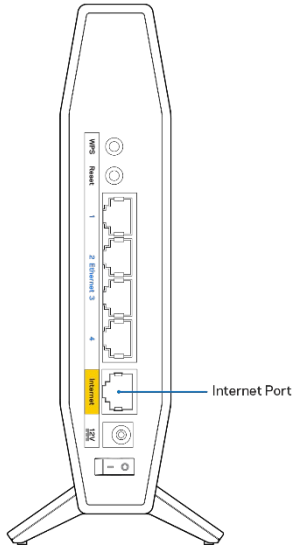

- Make sure that your modem is connected to power and is turned on.

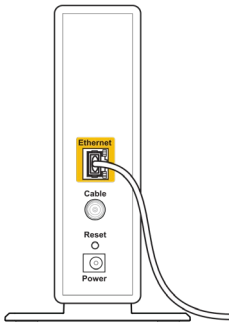
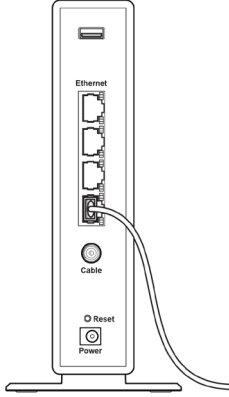
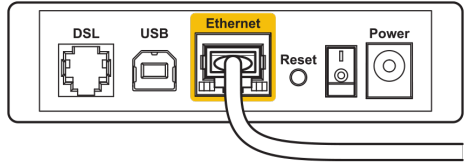
 <p>Back view of cable modem</p>  <p>Back view of Modem - Router</p>	 <p>Back view of DSL modem</p>
<p>If your internet service is cable, verify that the cable modem's CABLE port is connected to the coaxial cable provided by your ISP.</p>	<p>If your internet service is DSL, make sure that the DSL phone line is connected to the modem's DSL port.</p>

- If your computer was previously connected to your modem with a USB cable, disconnect the USB cable.
- Install the router again.

Cannot access your router message

To access your router, you must be connected to your own network. If you currently have wireless internet access, the problem may be that you have accidentally connected to a different wireless network.

To fix the problem on Windows computers, do the following*:

1. On your Windows desktop, click on the wireless icon in the system tray. A list of available networks will appear.
2. Click your own network name. Click Connect. In the example below, the computer was connected to another wireless network named wraith_5GHz. The wireless network name of the Linksys E series router, Damaged_Beez2.4 in this example, is shown selected.

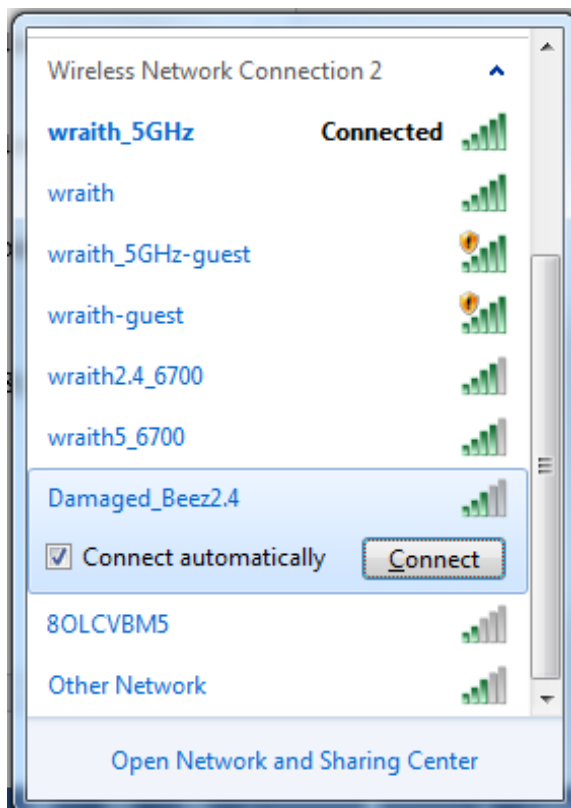

3. If you are prompted to enter a network security key, type your password (security key) into the network security key field. Click **OK**.
4. Your computer will connect to the network, and you should be able to access the router.

**Depending on your version of Windows, there could be some differences in wording or icons in these steps.*

To fix the problem on Mac computers, do the following:

1. In the menu bar across the top of the screen, click the Wi-Fi icon. A list of wireless networks will appear.
2. In the example below, the computer was connected to another wireless network named wraith_5GHz. The wireless network name of the Linksys E series router, Damaged_Beez2.4 in this example, is shown selected.

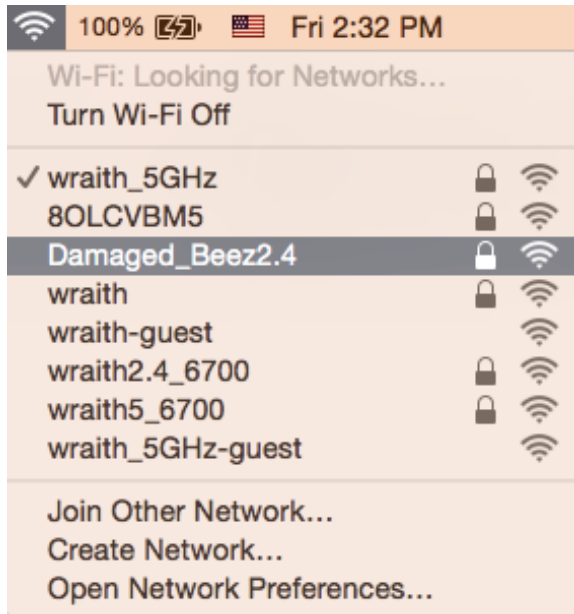

3. Click the wireless network name of your Linksys E series router (Damaged_Beez2.4 in the example).
4. Type your wireless network password (Security Key) into the *Password* field. Click **OK**.

After setup

The internet appears to be unavailable

If the internet has difficulty communicating with your router, the problem may appear as a “Cannot find [internet address]” message in your web browser. If you know that the internet address is correct, and if you’ve tried several valid internet addresses with the same result, the message could mean that there’s a problem with your ISP or modem communicating with your router.

Try the following:

- Make sure that the network and power cables are securely connected.
- Make sure that the power outlet that your router is connected to has power.
- Reboot your router.
- Contact your ISP and ask about outages in your area.

The most common method of troubleshooting your router is to turn it off, then back on again. Your router can then reload its custom settings, and other devices (such as the modem) will be able to rediscover the router and communicate with it. This process is called rebooting.

To restart your router using the power cord, do the following:

1. Disconnect the power cord from the router and the modem.
2. Wait 10 seconds and reconnect the power cord to the modem. Make sure it has power.
3. Wait until the modem's online indicator has stopped blinking (about two minutes). Reconnect the power cord to the router.
4. Wait until the flashing green LED between the Reset button and power port is solid. Wait two minutes before trying to connect to the internet from a computer.

Specifications

Linksys E5600

Model Name	AC1200 Dual-Band WiFi 5 Router
Model Number	E5600
Switch Port Speed	10/100/1000 Mbps (Fast Ethernet)
Radio Frequency	2.4 GHz and 5 GHz
# of Antennas	4 internal
Ports	Ethernet (1-4), Internet, Power
Buttons	Wi-Fi Protected Setup, Reset, Power Switch
LEDs	Power, Internet, Ethernet (1-4)
UPnP	Supported
Security Features	WPA2 Personal
Security Key Bits	Up to 128-bit encryption

Environmental

Dimensions	135mm (L) x 38mm (W) x 185.5mm (H)
Unit Weight	410 g (0.9 lbs)
Power	12V, 1A
Certifications	FCC, IC, CE, Wi-Fi (IEEE 802.11 a/b/g/n/ac)
Operating Temperature	32 to 104°F (0 to 40°C)
Storage Temperature	-4 to 140°F (-20 to 60°C)
Operating Humidity	10% to 80% relative humidity, non-condensing
Storage Humidity	5% to 90% non-condensing

Notes:

For regulatory, warranty, and safety information, see the CD that came with your router or go to Linksys.com/support/E5600.

Specifications are subject to change without notice.

Maximum performance derived from IEEE Standard 802.11 specifications. Actual performance can vary, including lower wireless network capacity, data throughput rate, range and coverage.

Performance depends on many factors, conditions and variables, including distance from the access point, volume of network traffic, building materials and construction, operating system used, mix of wireless products used, interference and other adverse conditions.

BELKIN, LINKSYS and many product names and logos are trademarks of the Belkin group of companies. Third-party trademarks mentioned are the property of their respective owners. Licenses and notices for third party software used in this product may be viewed here: <http://support.linksys.com/en-us/license>. Please contact <http://support.linksys.com/en-us/gplcodecenter> for questions or GPL source code requests.

© 2020 Belkin International, Inc. and/or its affiliates. All rights reserved.

LINKSYS

PANDUAN PENGGUNA

AC1200

ROUTER DUAL-BAND WiFi 5

Model E5600

Daftar Isi

Tinjauan Produk.....	3
Depan.....	3
Belakang.....	4
Persiapan: Dasar.....	5
Bantuan lebih lanjut.....	5
Cara memasang router Anda.....	5
Konfigurasi Lanjutan.....	7
Cara membuka utilitas berbasis browser.....	7
Pengaturan Router Dasar.....	8
Bahasa.....	8
Persiapan Internet.....	9
Pengaturan Nirkabel Dasar.....	10
Keamanan Nirkabel.....	12
Pengaturan Opsi Keamanan.....	12
WPA2 Personal.....	12
Dinonaktifkan.....	12
Pemecahan Masalah.....	13
Pengaturan router Anda tidak berhasil.....	13
Pesan " <i>kabel Internet Anda tidak tersambung</i> ".....	14
Pesan " <i>Tidak dapat mengakses router Anda</i> ".....	15
Setelah persiapan.....	16
Internet sepertinya tak tersedia.....	16
Spesifikasi.....	18
Linksys E5600.....	18
Lingkungan.....	18

Tinjauan Produk

Depan

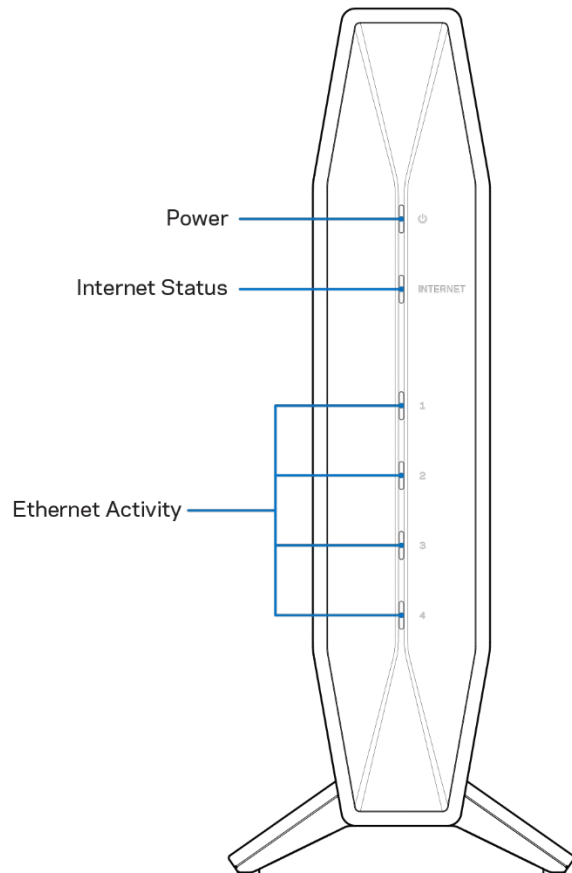

Lampu daya—Berkedip biru saat router dihidupkan dan selama proses pemasangan WPS. Berkedip kuning jika pemasangan WPS gagal.

Lampu status Internet—Menyala biru terang jika tersambung ke internet dan menyala kuning terang saat tidak tersambung.

Lampu aktivitas Ethernet—Setiap lampu akan menyala biru terang jika kabel ethernet disambungkan ke port tersebut. Lampu akan berkedip biru jika ada aktivitas di port.

Belakang

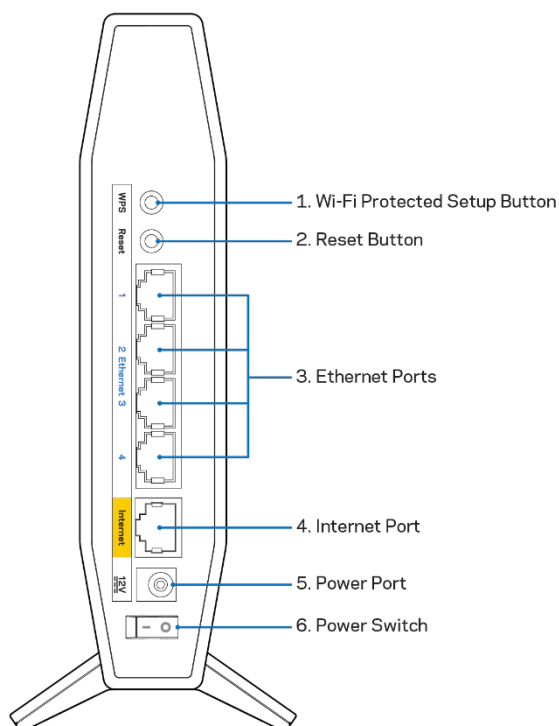

Tombol Wi-Fi Protected Setup™ (WPS) (1)—Tekan tombol ini untuk melakukan konfigurasi keamanan nirkabel dengan mudah di perangkat jaringan berkemampuan Wi-Fi Protected Setup. Lampu di bawah tombol akan berkedip saat proses penyandingan WPS aktif.

Tombol Reset (Atur Ulang) (2)— Tekan terus sampai LED daya mulai berkedip untuk melakukan reset router kembali ke pengaturan pabrik.

Port Ethernet(3)—Sambungkan kabel Ethernet (juga disebut kabel jaringan atau internet) ke port Fast Ethernet (10/100/1000) ini dan juga ke perangkat berkabel lain pada jaringan Anda. Lampu di bawah port hanya akan menyala saat kabel Ethernet dicolokkan dan terdapat lalu-lintas data pada kabel tersebut.

Port Internet(4)—Sambungkan kabel Ethernet ke port ini dan ke modem Anda. Lampu di bawah port hanya akan menyala saat kabel Ethernet dicolokkan dan terdapat lalu-lintas data pada kabel tersebut.

Port daya (5)— Sambungkan adaptor daya AC yang disertakan ke port ini.

Sakelar daya (6)—Tekan | (HIDUP) untuk menghidupkan router.

Persiapan: Dasar

Bantuan lebih lanjut

Selain panduan pengguna ini, Anda bisa menemukan bantuan di Linksys.com/support/E5600 (dokumentasi, unduhan, tanya-jawab, dukungan teknis, obrolan langsung, forum)

Catatan—*Lisensi dan pemberitahuan untuk perangkat lunak pihak ketiga yang digunakan pada produk ini dapat dilihat di <http://support.linksys.com/en-us/license>. Hubungi <http://support.linksys.com/en-us/gplcodecenter> untuk pertanyaan atau permintaan kode sumber GPL.*

Cara memasang router Anda

1. Jika Anda mengganti router sebelumnya, putuskan sambungan router tersebut terlebih dahulu.
2. Colokkan router ke catu daya. Pastikan sakelar daya pada posisi | (HIDUP).
3. Sambungkan router baru Anda ke modem atau modem-router.

A Modem	ATAU	B Modem-Router
Colokkan salah satu ujung kabel ethernet yang disertakan ke port internet berwarna kuning pada router baru Anda. Jika Anda memiliki modem, colokkan ujung lainnya ke port Ethernet (LAN) pada modem tersebut.		Colokkan salah satu ujung kabel ethernet yang disertakan ke port internet berwarna kuning pada router baru Anda. Jika Anda memiliki modem-router, colokkan ujung lainnya ke port mana pun yang tersedia.

4. Sambungkan ke nama jaringan yang ditunjukkan dalam Panduan Mulai Cepat yang disertakan bersama router Anda. (Anda dapat mengubah nama jaringan dan kata sandi nanti.) Pilih opsi untuk secara otomatis tersambung ke jaringan ini di masa mendatang. Jika Anda perlu bantuan untuk menyambungkan ke jaringan, lihat dokumentasi perangkat Anda pada CD yang disertakan.

Catatan—*Anda tidak akan dapat mengakses internet hingga persiapan router selesai.*

5. Ketik <http://myrouter.local> pada browser web. Ikuti instruksi di layar untuk menyelesaikan persiapan. Anda juga dapat memasukkan 192.168.1.1 dalam browser untuk memulai persiapan.

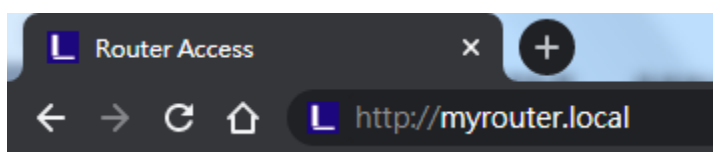

6. Setelah selesai dengan persiapan, pastikan Anda mendaftarkan router agar kami dapat memberi tahu tentang pembaruan keamanan, penarikan produk dan hal-hal lain yang akan meningkatkan pengalaman Anda.

Register your product

Once you register we can share important security updates. Product recalls and other things that will improve your experience. All we need is your email. We will only use your email for limited security and customer support purposes.

Email Address

Linksys may also email me to keep up to date with special offers and information from linksys. You can unsubscribe at any time by using the link at the end of any email we send.[Read our Privacy Policy here.](#)

[Next](#) [Skip](#)

Konfigurasi Lanjutan

Cara membuka utilitas berbasis browser

Untuk mengakses beberapa pengaturan lanjutan, Anda perlu membuka utilitas berbasis browser. Pastikan Anda tersambung ke router, buka browser web lalu masukkan <http://myrouter.local> pada browser web atau buka 192.168.1.1.

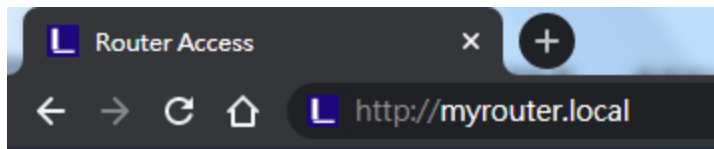

Router akan meminta kata sandi Anda.

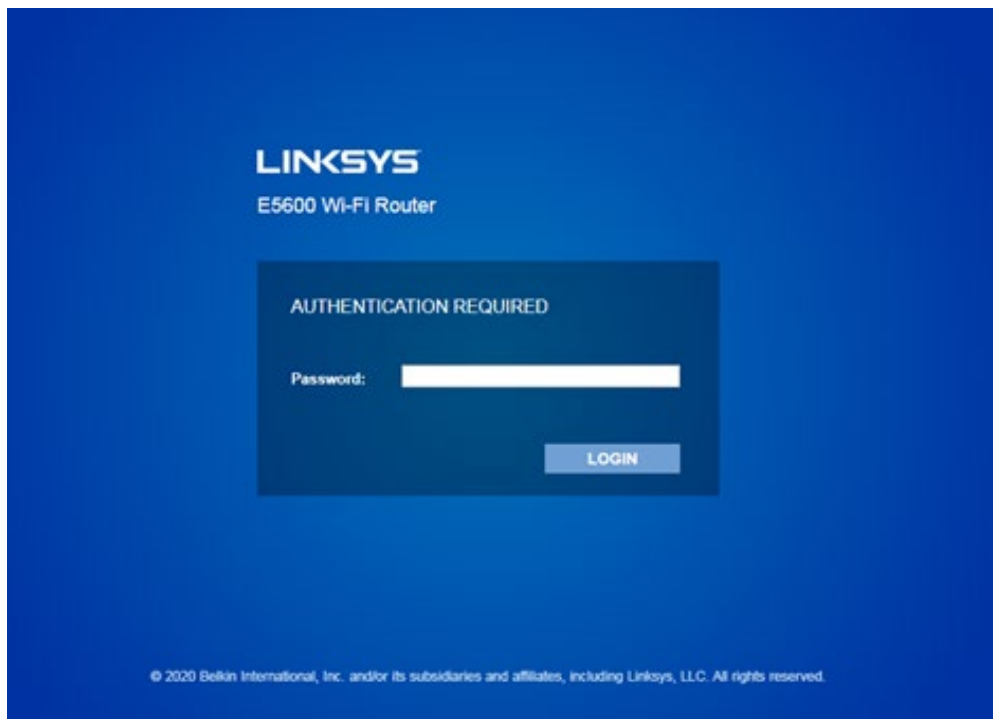

Jika Anda mengubah kata sandi saat persiapan, masukkan kata sandi baru tersebut. Klik **LOGIN**. Jika Anda tidak mengubah kata sandi, atau melewati keseluruhan persiapan, kata sandi default adalah "admin".

Pengaturan Router Dasar

Layar ini memungkinkan Anda mengubah konfigurasi dasar router.

The screenshot shows the Linksys configuration interface for an AC1200 Wi-Fi Router (E5600). The page is titled "Local Network" under the "Configuration" tab. The "Router Address" section includes fields for IP Address (192.168.1.1), Subnet Mask (255.255.255.0), and Router Name (Linksys00020). The "DHCP Server Setting" section has a checked "DHCP Server" option and a "DHCP Reservation" button. Other settings include Start IP Address (192.168.1.100), Maximum Numbers of Users (50), IP Address Range (192.168.1.100 to 149), Client Lease Time (0 minutes), and three Static DNS fields (all set to 0.0.0.0). A WINS field is also set to 0.0.0.0. "Save" and "Cancel" buttons are at the bottom.

Bahasa

Pilih bahasa Anda—Untuk mengubah bahasa, pilih salah satu dari menu turun. Bahasa utilitas berbasis browser akan berubah dalam lima detik.

The screenshot shows the Linksys configuration interface for the "Language" setting. The "Administration" tab is selected in the left sidebar. The "Language" section has a "Select your language" dropdown menu currently set to "English". "Save" and "Cancel" buttons are at the bottom.

Persiapan Internet

Bagian Persiapan Internet mengkonfigurasi router ke sambungan Internet Anda. Informasi ini dapat diberikan oleh Penyedia Layanan Internet (Internet Service Provider/ISP) Anda.

Jenis Sambungan Internet—Pilih jenis sambungan Internet yang disediakan ISP Anda dari menu turun.

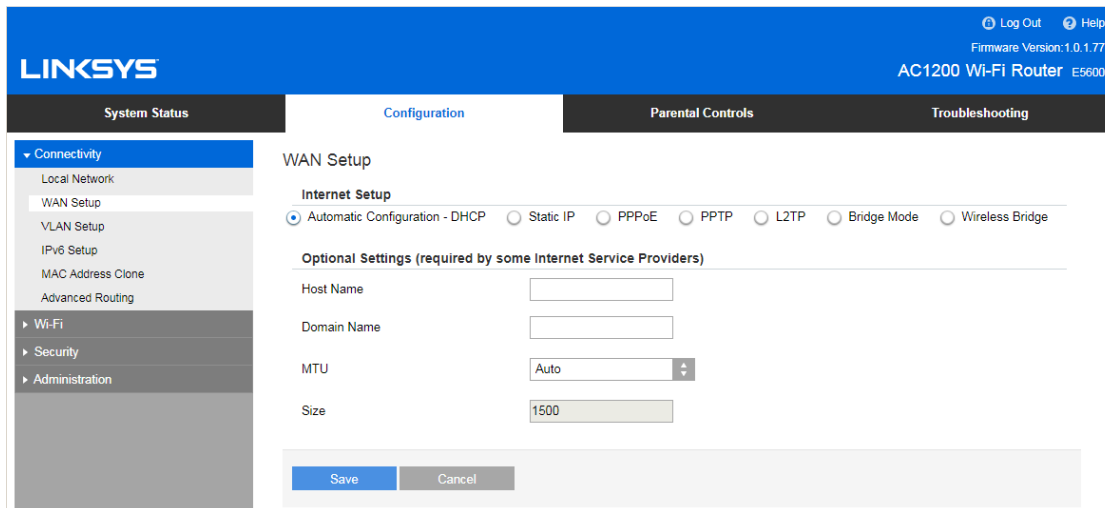

The screenshot shows the Linksys configuration interface for an AC1200 Wi-Fi Router (E5600). The 'WAN Setup' section is active, showing the 'Internet Setup' options. The 'Automatic Configuration - DHCP' option is selected. The 'Optional Settings' section includes fields for Host Name, Domain Name, MTU (set to Auto), and Size (set to 1500). The 'Save' button is highlighted in blue.

- **Konfigurasi Otomatis - DHCP (default)**

Pertahankan default hanya jika ISP Anda mendukung DHCP atau jika Anda menggunakan alamat IP dinamis. (Opsi ini biasanya berlaku untuk sambungan kabel.)

- **IP Statis**

Jika Anda diharuskan menggunakan alamat IP tetap untuk tersambung ke internet.

- **PPPoE**

Jika Anda mempunyai sambungan DSL dan ISP Anda menggunakan Point-to-Point Protocol over Ethernet (PPPoE).

- **PPTP**

Point-to-Point Tunneling Protocol (PPTP) adalah layanan yang secara umum berlaku pada sambungan di Eropa. Jika koneksi PPTP Anda mendukung DHCP atau alamat IP dinamis, maka pilih *Dapatkan Alamat IP Secara Otomatis*. Jika Anda harus menggunakan alamat IP tetap untuk tersambung ke Internet, maka pilih *Tentukan Alamat IP* dan konfigurasi opsi yang muncul.

- **L2TP**

Layer 2 Tunneling Protocol (L2TP) adalah layanan yang secara umum berlaku pada sambungan di Israel.

Catatan—*Sambungkan Bila Perlu atau Aktifkan Terus adalah opsi saat memilih PPPoE, PPTP dan L2TP. Opsi ini memungkinkan Anda memilih apakah router akan tersambung ke Internet hanya bila diperlukan (berguna jika ISP Anda mengenakan tarif selama waktu sambungan), atau bila router harus selalu tersambung. Pilih opsi yang sesuai.*

- **Mode Jembatan**

Mode Jembatan menonaktifkan semua kemampuan router dan mengubah router menjadi access point. Router akan berhenti bertindak sebagai server DHCP dan firewall bawaannya serta fitur-fitur NAT tidak akan lagi berlaku.

- **Jembatan Nirkabel**

Jembatan nirkabel terhubung secara nirkabel ke router utama Anda dan dapat berbagi sambungan internet dengan perangkat yang terhubung ke port Ethernet dari jembatan.

Pengaturan Nirkabel Dasar

The screenshot shows the Linksys configuration interface for an AC1200 Wi-Fi Router. The top navigation bar includes 'Log Out' and 'Help' buttons, and displays 'Firmware Version: 1.0.1.95' and 'AC1200 Wi-Fi Router E5600'. The main navigation tabs are 'System Status', 'Configuration', 'Parental Controls', and 'Troubleshooting'. The left sidebar shows a tree view with 'Connectivity' expanded to 'Wi-Fi', which includes 'Basic Wireless Settings', 'Wi-Fi Protected Setup', 'Wireless Security', 'Guest Access', 'Wireless MAC Filter', and 'Beamforming'. The 'Security' and 'Administration' sections are also visible. The main content area is titled 'Basic Wireless Settings' and is divided into two sections: '5 GHz Wireless Settings' and '2.4 GHz Wireless Settings'. Each section contains fields for 'Network Mode', 'Network Name (SSID)', 'Channel Width', and 'Channel', along with a checkbox for 'SSID Broadcast'. In the 5 GHz section, 'Network Mode' is set to 'Mixed(A/N/AC)', 'Network Name (SSID)' is 'Linksys00012_5GHz', 'Channel Width' is 'Auto', and 'Channel' is 'Auto'. In the 2.4 GHz section, 'Network Mode' is 'Mixed', 'Network Name (SSID)' is 'Linksys00012', 'Channel Width' is 'Auto', and 'Channel' is 'Auto'. Both 'SSID Broadcast' checkboxes are checked.

Modus Jaringan—Pilih standar nirkabel yang akan didukung jaringan Anda.

- **Campuran (default)**

Pilih tetap default jika Anda memiliki perangkat Wireless-A, Wireless-N, dan Wireless-AC di jaringan.

- **Hanya Wireless-A**

Pilih jika Anda hanya memiliki perangkat Wireless-A.

- **Hanya Wireless-N**

Pilih jika Anda hanya memiliki perangkat Wireless-N.

- **Dinonaktifkan**

Pilih jika Anda tidak mempunyai perangkat Wireless-B, Wireless-G, dan Wireless-N di jaringan Anda.

Catatan—Anda dapat memilih Campuran, Hanya Wireless-N/AC atau Nonaktif untuk pita 5 GHz. Jika Anda tidak yakin mode mana yang akan dipilih, pertahankan default, Campuran.

Nama Jaringan (SSID)

Pengenal Perangkat Layanan (SSID/Service Set Identifier) adalah nama yang digunakan oleh perangkat untuk tersambung ke jaringan nirkabel. SSID membedakan huruf besar-kecil dan tidak boleh melebihi 32 karakter. Pengaturan SSID awal untuk jaringan 2,4 GHz dan 5 GHz secara berurutan adalah LinksysXXXXX dan LinksysXXXXX_5GHz. X merupakan lima angka terakhir dari nomor seri router, yang bisa dilihat di bagian bawah router. Jika Anda mengubah SSID, kedua pita itu akan memiliki SSID baru. Anda dapat memberi nama yang berbeda melalui utilitas berbasis browser.

Catatan—Jika Anda mengembalikan router ke pengaturan awal pabrik (dengan menekan tombol Reset atau menggunakan layar Administrasi > Default Pabrik), Nama Jaringan akan kembali ke nilai default. Ubah kembali Nama Jaringan ke nama aslinya, atau Anda nanti harus menghubungkan ulang semua perangkat di jaringan nirkabel Anda ke nama jaringan yang baru.

Lebar Saluran

Pertahankan default, Otomatis (20 MHz atau 40 MHz), untuk kinerja terbaik di jaringan 2,4 GHz menggunakan perangkat Wireless-B, Wireless-G dan Wireless-N. Untuk lebar saluran 20 MHz, pilih hanya 20 MHz. Untuk performa terbaik di jaringan 5 GHz, pertahankan default 20, 40 atau 80 MHz.

Saluran

Pilih saluran dari daftar menurun. Pertahankan default, Otomatis, jika Anda tidak yakin saluran mana yang harus dipilih.

Penyiaran SSID

Pertahankan default, Aktifkan, untuk memancarkan SSID router. Bila klien nirkabel memindai area lokal untuk mendapatkan jaringan nirkabel yang akan dikaitkan dengannya, klien tersebut akan mendeteksi pemancaran SSID oleh router. Mencoba menyembunyikan nama Wi-Fi Anda tidak membuat Wi-Fi menjadi lebih aman. Siapa pun yang benar-benar tertarik mengakses jaringan Anda dapat menemukannya, meskipun Anda mematikan fitur ini. Jika Anda tidak ingin memancarkan SSID router, pilih Nonaktif.

Keamanan Nirkabel

Router ini menawarkan opsi keamanan nirkabel berikut:

WPA2 Personal (WPA singkatan dari Wi-Fi Protected Access.).

Opsi Keamanan	Kekuatan
WPA2 Personal	Terkuat

Pengaturan Opsi Keamanan

WPA2 Personal

Jika Anda memilih WPA2 Personal, maka setiap perangkat di jaringan nirkabel Anda HARUS menggunakan WPA2 Personal dan kata kunci yang sama.

Security Mode

WPA2 Personal

Kata Kunci—Masukkan kata kunci yang berisi 8-63 karakter. Ini adalah sandi Wi-Fi yang menyediakan akses ke jaringan. Ini bisa sama dengan yang dimasukkan dalam persiapan.

Dinonaktifkan

Jika Anda memilih untuk menonaktifkan keamanan nirkabel, Anda akan diberitahu bahwa keamanan nirkabel telah dinonaktifkan saat pertama kali Anda mencoba mengakses Internet. Anda akan diberi opsi untuk mengaktifkan keamanan nirkabel, atau mengonfirmasi bahwa Anda memahami risikonya namun tetap ingin meneruskan tanpa keamanan nirkabel.

Security Mode

Disabled

Pemecahan Masalah

Anda dapat menemukan bantuan lebih lanjut dari dukungan pelanggan kami yang telah meraih penghargaan di Linksys.com/support/E5600.

Pengaturan router Anda tidak berhasil

Jika Anda tidak dapat menyelesaikan persiapan pada antarmuka berbasis browser, Anda dapat mencoba yang berikut:

- Dengan menggunakan klip kertas atau peniti, tekan terus tombol Reset hingga lampu daya di bagian depan router mati dan mulai berkedip (sekitar 10 detik). Ketikkan 192.168.1.1 pada browser untuk mencoba kembali persiapan.

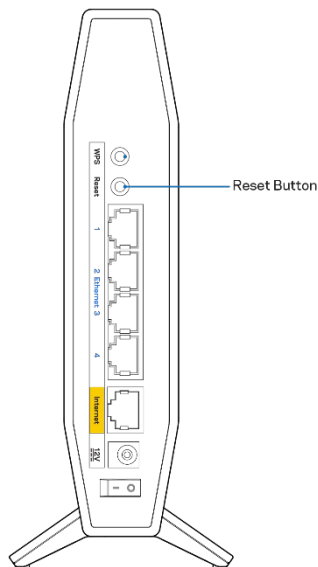

- Untuk sementara nonaktifkan firewall komputer Anda (lihat petunjuk perangkat lunak keamanan untuk mendapatkan bantuan). Pasang kembali router.
- Jika Anda memiliki komputer lain, gunakan komputer tersebut untuk memasang router.

Pesan “kabel Internet Anda tidak tersambung”

Jika Anda mendapatkan pesan “Kabel internet Anda tidak tersambung” saat mencoba menyiapkan router:

- Pastikan kabel ethernet atau internet (atau kabel seperti yang disertakan bersama router Anda) tersambung erat ke port Internet berwarna kuning di bagian belakang router dan pada port yang sesuai dengan modem. Port ini pada modem biasanya bertuliskan Ethernet.

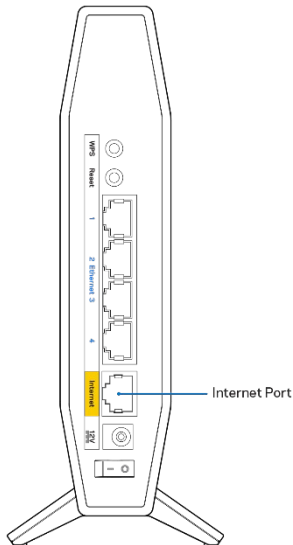

- Pastikan bahwa modem Anda telah tersambung ke daya dan telah dihidupkan.

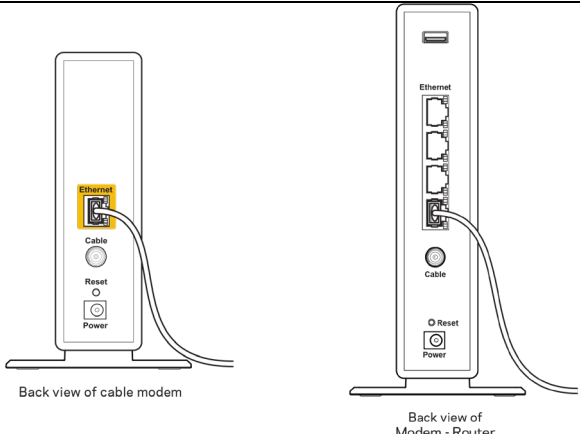
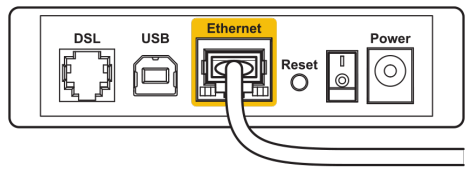
 <p>Back view of cable modem</p> <p>Back view of Modem - Router</p>	 <p>Back view of DSL modem</p>
<p>Jika layanan internet Anda melalui kabel, pastikan bahwa port CABLE pada modem kabel tersambung ke kabel koaksial yang disediakan oleh ISP Anda.</p>	<p>Jika layanan internet Anda adalah DSL, pastikan bahwa saluran telepon DSL tersambung ke port DSL pada modem.</p>

- Jika komputer Anda sebelumnya tersambung ke modem menggunakan kabel USB, lepaskan kabel USB tersebut,
- Pasang kembali router.

Pesan “Tidak dapat mengakses router Anda”

Untuk mengakses router, Anda harus tersambung ke jaringan Anda sendiri. Jika Anda saat ini mempunyai akses internet nirkabel, masalah yang terjadi mungkin karena Anda tidak sengaja tersambung ke jaringan nirkabel yang berbeda.

Untuk memperbaiki masalah pada komputer berbasis Windows, lakukan hal berikut*:

1. Pada desktop Windows Anda, klik ikon nirkabel di baki sistem. Daftar jaringan yang tersedia akan muncul.
2. Klik nama jaringan Anda sendiri. Klik Sambungkan. Dalam contoh di bawah ini, komputer telah tersambung ke jaringan nirkabel lain bernama wraith_5GHz. Nama jaringan nirkabel dari router Linksys seri E, Damaged_Beez2.4 dalam contoh ini, ditunjukkan telah dipilih.

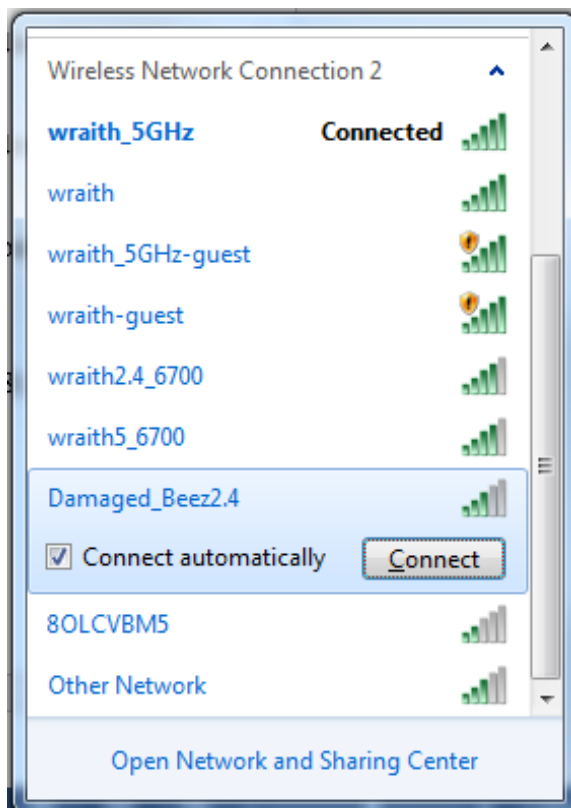

3. Jika Anda diminta untuk memasukkan kunci pengaman jaringan, ketikkan kata sandi Anda (kunci pengaman) ke dalam bidang *kunci pengaman jaringan*. Klik **Oke**.
4. Komputer Anda akan tersambung ke jaringan, dan sekarang router tersebut dapat Anda akses.

**Bergantung pada versi Windows Anda, mungkin ada beberapa perbedaan dalam istilah atau ikon pada langkah ini.*

Untuk memperbaiki masalah pada komputer berbasis Mac, lakukan hal berikut:

1. Dalam bilah menu di bagian atas layar, klik ikon Wi-Fi. Daftar jaringan nirkabel akan muncul.
2. Dalam contoh di bawah ini, komputer telah tersambung ke jaringan nirkabel lain bernama wraith_5GHz. Nama jaringan nirkabel dari router Linksys seri E, Damaged_Beez2.4 dalam contoh ini, ditunjukkan telah dipilih.

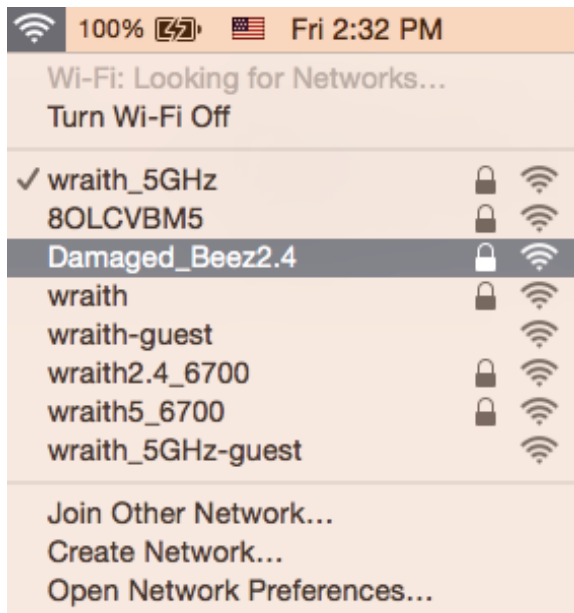

3. Klik nama jaringan nirkabel router Linksys seri E Anda (Damaged_Beez2.4 dalam contoh ini).
4. Ketik kata sandi jaringan nirkabel (Kunci Keamanan) ke dalam bidang *Kata Sandi*. Klik **Oke**.

Setelah persiapan

Internet sepertinya tak tersedia

Jika internet kesulitan berkomunikasi dengan router Anda, masalahnya mungkin muncul sebagai pesan “Tidak dapat menemukan [alamat internet]” pada browser web Anda. Jika Anda tahu bahwa alamat internet tersebut benar, dan jika Anda telah mencoba beberapa alamat Internet yang sah dengan hasil yang sama, pesan tersebut berarti mungkin ada masalah dengan ISP atau modem yang berkomunikasi dengan router Anda.

Coba lakukan hal berikut:

- Pastikan kabel jaringan dan daya terpasang dengan kuat.
- Pastikan stopkontak tempat router disambungkan memiliki daya.
- Lakukan boot ulang router Anda.
- Hubungi ISP dan tanyakan apakah ada putus jaringan di area Anda.

Metode pemecahan masalah yang paling umum untuk router Anda adalah mematikan, lalu menghidupkannya kembali. Router Anda kemudian dapat memuat ulang pengaturan kustom, dan perangkat lain (seperti modem) akan dapat menemukan kembali router serta berkomunikasi dengannya. Proses ini disebut boot ulang.

Untuk menghidupkan ulang router Anda menggunakan kabel daya, lakukan hal berikut:

1. Putuskan kabel daya dari router dan modem.
2. Tunggu 10 detik lalu sambungkan kembali kabel daya ke modem. Pastikan modem mendapatkan daya.
3. Tunggu hingga indikator online modem berhenti berkedip (sekitar 2 menit). Sambungkan kembali kabel daya ke router.
4. Tunggu sampai LED hijau yang berkedip antara tombol Reset dan port daya menyala terang. Tunggu dua menit sebelum mencoba tersambung ke internet dari komputer.

Spesifikasi

Linksys E5600

Nama Model	Router AC1200 Dual-Band WiFi 5
Nomor Model	E5600
Kecepatan Switch Port	10/100/1000 Mbps (Gigabit Ethernet)
Frekuensi Radio	2,4 GHz dan 5 GHz
Jumlah Antena	4 (internal)
Port	Ethernet (1-4), Internet, Daya
Tombol	Wi-Fi Protected Setup, Reset, Sakelar Daya
LED	Daya, Internet, Ethernet (1-4)
UPnP	Didukung
Fitur Keamanan	WPA2 Personal
Bit Kunci Keamanan	Enkripsi hingga 128-bit

Lingkungan

Dimensi	135mm (P) x 38mm (L) x 185,5mm (T)
Berat Unit	410 g (0,9 lbs)
Daya	12V, 1A
Sertifikasi	FCC, IC, CE, Wi-Fi (IEEE 802.11 a/b/g/n/ac)
Suhu Operasi	32 hingga 104°F (0 hingga 40°C)
Suhu Penyimpanan	-4 hingga 140°F (-20 hingga 60°C)
Kelembapan Operasi	10% hingga 80% kelembapan relatif, nonkondensasi
Kelembapan Penyimpanan	5% hingga 90%, nonkondensasi

Catatan:

Untuk mengetahui informasi peraturan, garansi, dan keselamatan, lihat pada CD yang disertakan bersama router Anda atau kunjungi Linksys.com/support/E5600.

Spesifikasi dapat berubah sewaktu-waktu tanpa pemberitahuan.

Kinerja maksimal diperoleh dari spesifikasi IEEE Standard 802.11. Kinerja sesungguhnya dapat bervariasi, termasuk kapasitas jaringan nirkabel yang lebih rendah, laju transfer data, kisaran dan jangkauan. Kinerja tergantung pada banyak faktor, kondisi dan variabel, termasuk jarak dari titik akses, volume lalu-lintas jaringan, bahan konstruksi dan bangunan, sistem operasi yang digunakan, campuran produk nirkabel yang digunakan, interferensi dan kondisi lainnya yang merugikan.

BELKIN, LINKSYS dan banyak nama produk serta logo adalah merek dagang dari grup perusahaan Belkin. Merek dagang pihak ketiga yang disebutkan adalah milik dari masing-masing pemiliknya. Lisensi dan pemberitahuan untuk perangkat lunak pihak ketiga yang digunakan dalam produk ini dapat dilihat di sini: <http://support.linksys.com/en-us/license> Hubungi <http://support.linksys.com/en-us/gplcodecenter> jika ada pertanyaan atau untuk permintaan kode sumber GPL.

© 2020 Belkin International, Inc. dan/atau afiliasinya. Hak cipta dilindungi undang-undang.

LINKSYS

사용자 안내서

AC1200

듀얼-밴드 WiFi 5 라우터

모델 E5600

목차

제품 개요.....	3
전면.....	3
뒤로.....	4
설정: 기본.....	5
추가 도움을 받을 수 있는 곳.....	5
라우터를 설치하는 방법.....	5
고급 구성.....	7
브라우저 기반 유틸리티를 여는 방법.....	7
기본 라우터 설정.....	8
언어.....	8
인터넷 설정.....	9
기본 라우터 설정.....	10
무선 보안.....	12
보안 옵션 설정.....	12
WPA2 개인.....	12
비활성화됨.....	12
문제해결.....	13
라우터가 성공적으로 설정되었습니다.....	13
인터넷 케이블이 메시지에 연결되어 있지 않습니다.....	14
라우터 메시지에 액세스할 수 없습니다.....	15
설정 후.....	16
인터넷을 사용할 수 없는 것으로 보입니다.....	16
사양.....	18
Linksys E5600.....	18
환경.....	18

제품 개요

전면

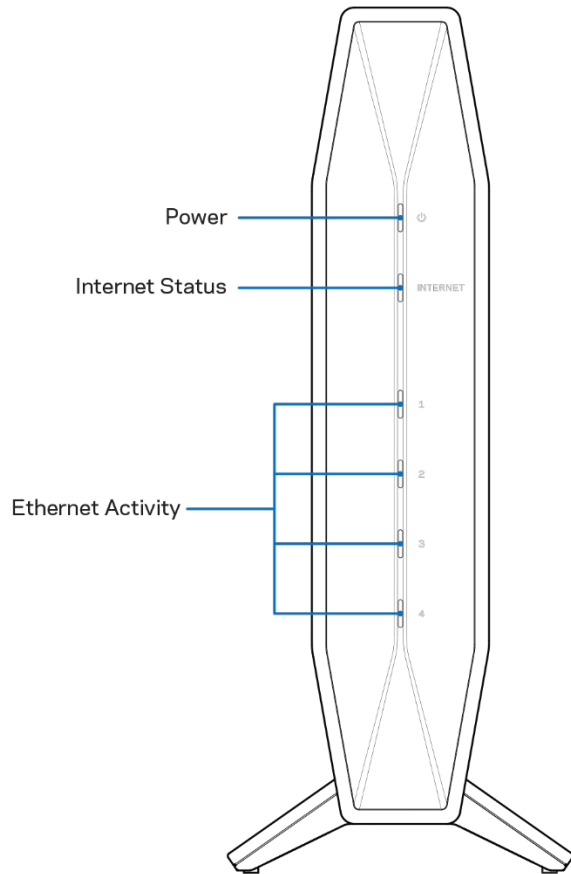

전원 표시등 — 라우터가 시작되는 동안, 그리고 WPS 페어링 중에 파란색으로 깜박입니다. WPS 페어링에 실패하면 노란색으로 깜박입니다.

인터넷 상태 표시등— 인터넷에 연결하면 파란색으로 점등되고, 연결되지 않으면 노란색으로 점등됩니다.

이더넷 작동 표시등— 이더넷 케이블이 해당 포트에 연결되면 각 표시등이 파란색으로 점등됩니다. 포트에 활동이 있으면 파란색으로 깜박입니다.

뒤로

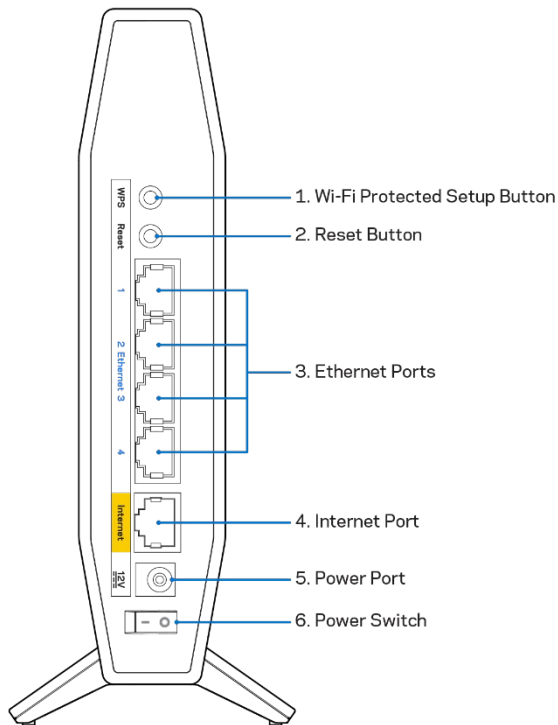

Wi-Fi Protected Setup™(WPS) 버튼(1)— 이 버튼을 누르면 Wi-Fi Protected Setup 기능을 지원하는 네트워크 장치에서 무선 보안을 쉽게 구성할 수 있습니다. WPS 페어링이 활성화되어 있는 동안 버튼 아래의 표시등이 깜박입니다.

재설정 버튼(2) — 전원 LED가 깜박이기 시작할 때까지 길게 눌러 라우터를 출하 시 기본 설정으로 재설정합니다.

이더넷 포트(3)—이러한 고속 이더넷(10/100) 포트 및 네트워크의 다른 유선 장치에 이더넷 케이블(네트워크 또는 인터넷 케이블이라고도 함)을 연결합니다. 포트 아래의 표시등은 이더넷 케이블이 연결되어 있고, 케이블에 데이터 트래픽이 있는 경우에만 켜집니다.

인터넷 포트(4) -이 포트와 모뎀에 이더넷 케이블을 연결합니다. 포트 아래의 표시등은 이더넷 케이블이 연결되어 있고, 케이블에 데이터 트래픽이 있는 경우에만 켜집니다.

전원 포트(5)—포함된 AC 전원 어댑터를 이 포트에 연결합니다.

전원 스위치(6)— | (켜기) 버튼을 눌러 라우터를 켭니다.

설정: 기본

추가 도움을 받을 수 있는 곳

이 사용자 안내서 외에도 [Linksys.com/support/E5600](http://support.linksys.com/E5600)(설명서, 다운로드, FAQ, 기술 지원, 실시간 채팅, 포럼)에서 도움말을 찾아볼 수 있습니다.

참고—이 제품에 사용된 라이선스 및 제3자 소프트웨어는 <http://support.linksys.com/en-us/license>에서 참조할 수 있습니다. 질문이나 GPL 소스 코드 요청은 <http://support.linksys.com/en-us/gplcodecenter>를 방문하십시오.

라우터를 설치하는 방법

1. 기존 라우터를 교체하는 경우, 먼저 해당 라우터의 연결을 해제합니다.
2. 전원에 라우터를 연결하십시오. 전원 스위치가 | (켜짐) 위치에 있는지 확인합니다.
3. 새 라우터를 모뎀 또는 모뎀 라우터에 연결합니다.

A 모뎀	또는	B 모뎀-라우터
포함된 이더넷 케이블의 한쪽 끝을 새 라우터의 노란색 인터넷 포트에 연결합니다. 모뎀이 있는 경우, 모뎀의 이더넷(LAN) 포트 에 다른 쪽 끝을 연결합니다.		포함된 이더넷 케이블의 한쪽 끝을 새 라우터의 노란색 인터넷 포트에 연결합니다. 모뎀-라우터가 있는 경우, 다른 쪽 끝을 사용 가능한 포트 에 연결하십시오.

4. 라우터와 함께 제공된 빠른 시작 안내서에 표시된 네트워크 이름에 연결하십시오. (나중에 네트워크 이름과 암호를 변경할 수 있습니다.) 향후 이 네트워크에 자동으로 연결하는 옵션을 선택하십시오. 네트워크에 연결하는 데 도움이 필요한 경우, 제공된 CD의 장치 설명서를 참조하십시오.

참고 - 라우터 설정이 완료될 때까지 인터넷에 접속할 수 없게 됩니다.

5. 웹 브라우저에서 <http://myrouter.local> 을 입력합니다. 화면 상의 지침에 따라 설정을 완료합니다. 또한 브라우저에 192.168.1.1 을 입력하여 설정을 시작 할 수도 있습니다.

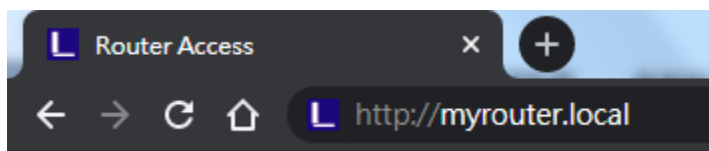

- 설정을 마치면 보안 업데이트, 제품 리콜 및 기타 경험을 향상시킬 수 있는 다른 정보를 받아볼 수 있도록 라우터를 등록하십시오.

Register your product

Once you register we can share important security updates. Product recalls and other things that will improve your experience. All we need is your email. We will only use your email for limited security and customer support purposes.

Email Address

Linksys may also email me to keep up to date with special offers and information from linksys. You can unsubscribe at any time by using the link at the end of any email we send.[Read our Privacy Policy here.](#)

고급 구성

브라우저 기반 유틸리티를 여는 방법

일부 고급 설정에 액세스하려면 브라우저 기반 유틸리티를 열어야 합니다. 라우터에 연결되어 있는지 확인하고, 웹 브라우저를 열고 웹 브라우저에서 <http://myrouter.local>을 입력하거나 192.168.1.1로 이동하십시오.

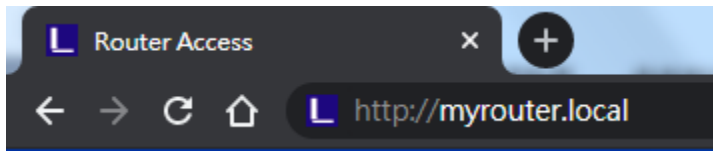

라우터에서 암호를 묻는 메시지가 표시됩니다.

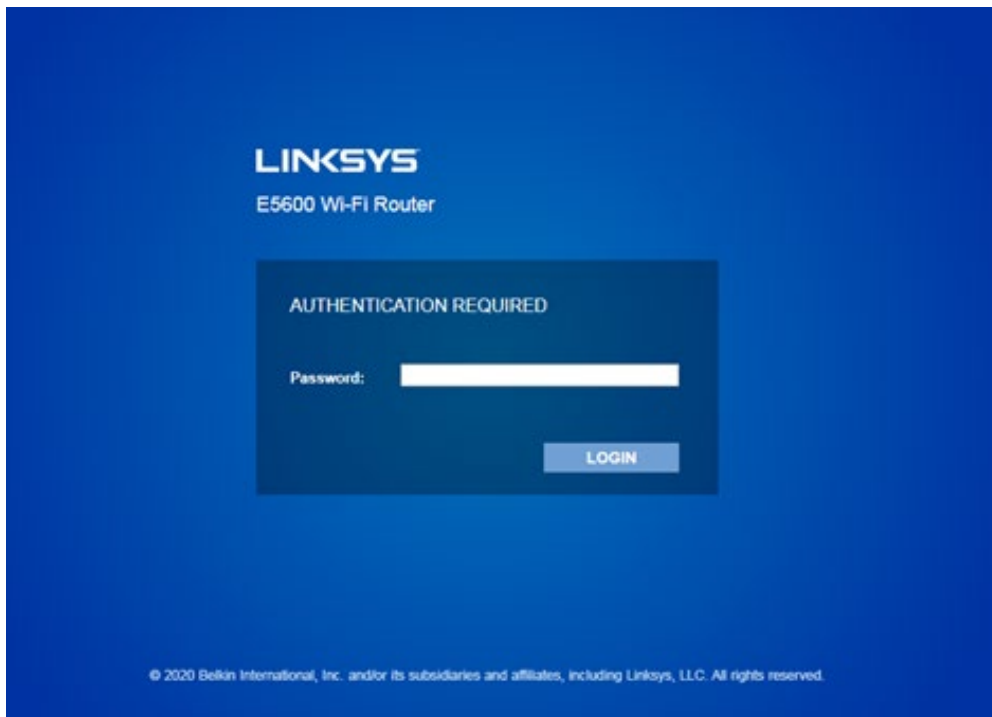

설정 중에 암호를 변경한 경우, 새로운 암호를 입력하십시오. 로그인을 클릭합니다. 암호를 변경하지 않거나 설정을 모두 건너 뛰면, 기본 암호는 "admin"입니다.

기본 라우터 설정

이 화면에서는 라우터의 기본 구성을 변경할 수 있습니다.

The screenshot shows the Linksys configuration interface for an AC1200 Wi-Fi Router (E5600). The top navigation bar includes 'System Status', 'Configuration', 'Parental Controls', and 'Troubleshooting'. The 'Configuration' tab is active, and the 'Local Network' section is selected in the left sidebar. The main content area is titled 'Local Network' and contains two sections: 'Router Address' and 'DHCP Server Setting'. The 'Router Address' section includes fields for IP Address (192.168.1.1), Subnet Mask (255.255.255.0), and Router Name (Linksys00020). The 'DHCP Server Setting' section has a checked 'DHCP Server' option and a 'DHCP Reservation' button. Below this, there are fields for Start IP Address (192.168.1.100), Maximum Numbers of Users (50), IP Address Range (192.168.1.100 to 149), Client Lease Time (0 minutes), and three Static DNS fields (all set to 0.0.0.0). A WINS field is also present (set to 0.0.0.0). At the bottom of the configuration area are 'Save' and 'Cancel' buttons.

언어

언어 선택 - 언어를 변경하려면 드롭 다운 메뉴에서 언어를 선택합니다. 브라우저 기반 유틸리티의 언어가 5초 이내에 변경됩니다.

The screenshot shows the Linksys configuration interface for an AC1200 Wi-Fi Router (E5600). The top navigation bar includes 'System Status', 'Configuration', 'Parental Controls', and 'Troubleshooting'. The 'Configuration' tab is active, and the 'Administration' section is selected in the left sidebar. The 'Language' sub-section is active, showing a 'Select your language' dropdown menu with 'English' selected. At the bottom of the configuration area are 'Save' and 'Cancel' buttons.

인터넷 설정

인터넷 설정 섹션은 인터넷 연결에 대해 라우터를 구성합니다. 이 정보는 인터넷 서비스 제공자(ISP)를 통해 제공됩니다.

인터넷 연결 유형—드롭 다운 메뉴에서 ISP가 제공하는 인터넷 연결 유형을 선택합니다.

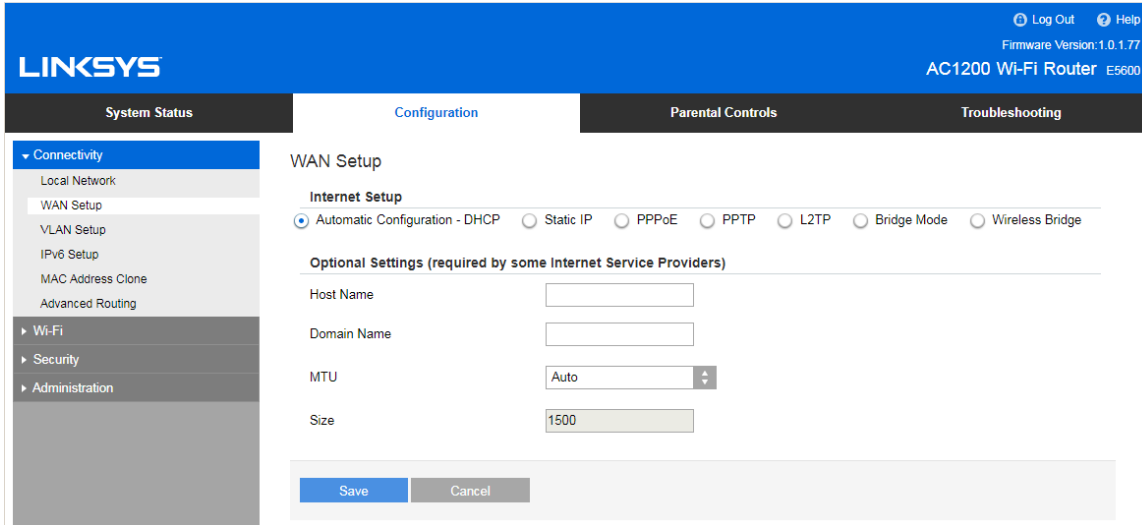

The screenshot shows the Linksys configuration interface for an AC1200 Wi-Fi Router E5600. The 'Configuration' tab is active, and the 'WAN Setup' section is expanded. Under 'Internet Setup', the 'Automatic Configuration - DHCP' radio button is selected. The 'Optional Settings' section includes input fields for 'Host Name', 'Domain Name', a dropdown menu for 'MTU' set to 'Auto', and a 'Size' field set to '1500'. At the bottom of the configuration area, there are 'Save' and 'Cancel' buttons.

- 자동 구성 - DHCP(기본값)
ISP가 DHCP를 지원하거나 동적 IP 주소를 사용하여 연결하는 경우에만 기본값을 유지하십시오. (이 옵션은 일반적으로 케이블 연결에 적용됩니다.)
- 고정 IP
고정 IP 주소를 사용하여 인터넷에 연결해야 하는 경우 선택하십시오.
- PPPoE
DSL 연결이 있고 ISP가 PPPoE(Point-to-Point Protocol over Ethernet)를 사용하는 경우 선택하십시오.
- PPTP
PPTP(Point-to-Point Tunneling Protocol)는 일반적으로 유럽의 연결에 적용되는 서비스입니다. PPTP 연결이 DHCP 또는 동적 IP 주소를 지원하는 경우, 자동으로 IP 주소 받기를 선택하십시오. 고정 IP 주소를 사용하여 인터넷에 연결해야 하는 경우, IP 주소 지정을 선택하고 표시되는 옵션을 구성하십시오.
- L2TP
L2TP(Layer 2 Tunneling Protocol)는 일반적으로 이스라엘의 연결에 적용되는 서비스입니다.

참고 - PPPoE, PPTP 및 L2TP를 선택할 때 연결 요청시 또는 연결 유지 옵션이 있습니다. 라우터가 필요한 경우에만 인터넷에 연결되어 있는지 여부(ISP가 연결 시간에 대해 요금을 부과하는 경우에 유용함)를 선택하거나 라우터를 항상 연결해야 하는지 여부를 선택할 수 있습니다. 적절한 옵션을

선택합니다.

- 브릿지 모드

브릿지 모드는 모든 라우터 기능을 비활성화하고 라우터를 액세스 지점으로 전환합니다. 라우터가 DHCP 서버 역할을 멈추고, 내장된 방화벽과 NAT 기능이 더 이상 적용되지 않습니다.

- 무선 브릿지

무선 브릿지는 기본 라우터에 무선으로 연결되며, 브릿지의 이더넷 포트에 연결된 장치와 인터넷 연결을 공유할 수 있습니다.

기본 라우터 설정

The screenshot shows the Linksys web interface for an AC1200 Wi-Fi Router. The top navigation bar includes 'System Status', 'Configuration', 'Parental Controls', and 'Troubleshooting'. The 'Configuration' tab is active, and the left sidebar shows 'Connectivity' > 'Wi-Fi' > 'Basic Wireless Settings' selected. The main content area is titled 'Basic Wireless Settings' and is divided into two sections: '5 GHz Wireless Settings' and '2.4 GHz Wireless Settings'. In the 5 GHz section, 'Network Mode' is set to 'Mixed(A/N/AC)', 'Network Name (SSID)' is 'Linksys00012_5GHz', 'Channel Width' is 'Auto', and 'Channel' is 'Auto'. The 'SSID Broadcast' checkbox is checked. In the 2.4 GHz section, 'Network Mode' is set to 'Mixed', 'Network Name (SSID)' is 'Linksys00012', 'Channel Width' is 'Auto', and 'Channel' is 'Auto'. The 'SSID Broadcast' checkbox is also checked. The top right corner of the interface shows 'Log Out', 'Help', 'Firmware Version: 1.0.1.95', and 'AC1200 Wi-Fi Router E5600'.

네트워크 모드 - 네트워크에서 지원할 무선 표준을 선택하십시오.

- 혼용(기본값)

네트워크에서 무선-N, 무선-A 및 무선-AC 장치가있는 경우 기본값을 유지하십시오.

- 무선-A 전용
무선-A 장치만 있는 경우 선택하십시오.

- 무선-N 전용
무선-N 장치만 있는 경우 선택하십시오.

- 비활성화됨
네트워크에 무선-B, 무선-G 및 무선-N 장치가 없는 경우 선택하십시오.

참고 - 5GHz 대역에서 혼용, 무선-N/AC 전용 또는 비활성화됨을 선택할 수 있습니다. 어떤 모드를 선택해야 할지 모르는 경우, 기본값인 혼용을 유지하십시오.

네트워크 이름(SSID)

SSID(Service Set Identifier)는 무선 네트워크에 장치를 연결할 때 사용하는 이름입니다. SSID는 대소문자를 구분하며 32자를 초과할 수 없습니다. 2.4GHz 및 5GHz 네트워크의 기본 SSID는 각각 LinksysXXXXX 및 LinksysXXXXX_5GHz입니다. X는 라우터의 일련 번호 중 마지막 5자리를 나타내며 라우터 하단에 나와 있습니다. SSID를 변경하면 두 개 대역 모두에 새로운 SSID가 적용됩니다. 브라우저 기반 유틸리티를 통해 다른 이름을 지정할 수 있습니다.

참고 - 라우터의 출하 시 기본 설정을 복원하는 경우, (재설정 버튼을 누르거나 관리> 출하 시 기본값 화면 사용) 네트워크 이름이 기본값으로 돌아갑니다. 네트워크 이름을 원래 이름으로 다시 변경하십시오. 그렇지 않으면 무선 네트워크의 모든 장치를 새로운 네트워크 이름에 다시 연결해야 합니다.

채널 폭

무선-B, 무선-G 및 무선-N 장치를 사용하는 2.4GHz 네트워크에서 최상의 성능을 얻으려면 기본값인 자동(20MHz 또는 40MHz)을 유지하십시오. 20MHz 채널 폭의 경우, 20MHz만 선택합니다. 5GHz 네트워크에서 최상의 성능을 얻으려면 기본값인 20, 40 또는 80MHz를 유지하십시오.

채널

드롭 다운 목록에서 채널을 선택하십시오. 어떤 채널을 선택해야 하는지 모를 경우 기본값인 자동을 유지하십시오.

SSID 송출

라우터의 SSID를 송출하려면 기본값인 비활성화 상태를 유지하십시오. 무선 클라이언트가 연결할 무선 네트워크에 대한 로컬 영역을 검색할 때, 라우터가 송출하는 SSID를 감지합니다. Wi-Fi 이름을 숨기려고 시도하는 경우 Wi-Fi 보안성이 약화됩니다. 네트워크 액세스에 실제로 관심이 있는 사람은 누구든지 이 기능이 꺼진 경우에도 이를 찾을 수 있습니다. 여전히 라우터의 SSID를 송출하고 싶지 않은 경우, 비활성화 상태를 선택하십시오.

무선 보안

라우터는 다음과 같은 무선 보안 옵션을 제공합니다.

WPA2 개인/ WPA2 엔터프라이즈(WPA는 Wi-Fi Protected Access의 약자임)

보안 옵션	강도
WPA2 개인	가장 강함

보안 옵션 설정

WPA2 개인

WPA2 개인을 선택하면 무선 네트워크의 각 장치가 WPA2 개인과 동일한 암호 문구를 사용해야 합니다.

Security Mode

WPA2 Personal

암호 문구 - 8-63자의 암호 문구를 입력하십시오. 이것은 네트워크에 대한 액세스를 제공하는 Wi-Fi 암호입니다. 이것은 설정에서 입력한 것과 동일할 수 있습니다.

비활성화됨

무선 보안을 사용하지 않도록 선택하면 인터넷에 처음 접속할 때 무선 보안이 비활성화되었다는 메시지가 표시됩니다. 무선 보안을 활성화하거나, 위험을 이해하지만 무선 보안 없이 계속 진행할 것임을 확인하는 옵션이 제공됩니다.

Security Mode

Disabled

문제해결

수상 경력에 빛나는 고객 지원([Linksys.com/support/E5600](https://www.linksys.com/support/E5600)) 서비스를 통해 더 많은 도움을 얻을 수 있습니다.

라우터가 성공적으로 설정되었습니다.

브라우저 기반 인터페이스에서 설치를 완료할 수 없는 경우 다음을 시도해보십시오.

- 라우터 전면의 전원 표시등이 꺼지고 깜박이기 시작할 때까지(약 10 초), 페이퍼 클립이나 핀으로 라우터의 재설정 버튼을 길게 누릅니다. 브라우저에 192.168.1.1 을 입력하여 설정을 다시 시도하십시오.

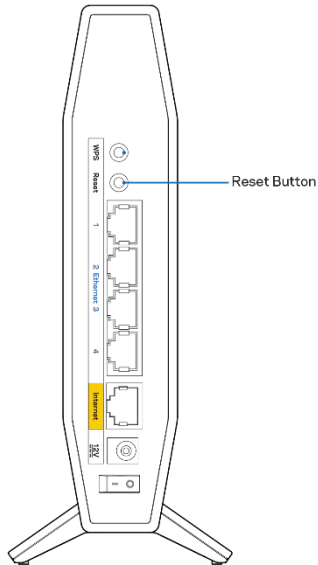

- 컴퓨터의 방화벽을 일시적으로 비활성화하십시오(보안 소프트웨어 지침의 도움말 참조). 라우터를 다시 설치하십시오.
- 다른 컴퓨터가 있는 경우 해당 컴퓨터를 사용하여 라우터를 설치하십시오.

인터넷 케이블이 메시지에 연결되어 있지 않습니다.

라우터를 설정하려고 할 때 "인터넷 케이블이 연결되어 있지 않습니다"라는 메시지가 나타나는 경우:

- 이더넷 또는 인터넷 케이블(또는 라우터와 함께 제공되는 것과 같은 케이블)이 라우터 후면의 노란색 인터넷 포트와 모뎀의 해당 포트에 단단히 연결되어 있는지 확인하십시오. 모뎀의 이 포트는 일반적으로 이더넷이란 라벨로 표시됩니다.

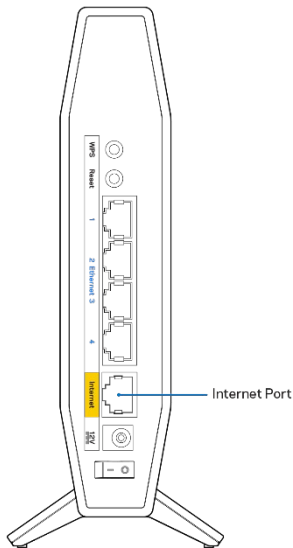

- 모뎀이 전원에 연결되어 켜져 있는지 확인하십시오.

<p>The left side of the table contains two diagrams. The first is labeled 'Back view of cable modem' and shows a cable modem with an Ethernet port highlighted in yellow. The second is labeled 'Back view of Modem - Router' and shows a modem-router with an Ethernet port highlighted in yellow. Both diagrams also show Cable, Reset, and Power ports.</p>	<p>The right side of the table contains a diagram labeled 'Back view of DSL modem'. It shows a DSL modem with an Ethernet port highlighted in yellow. Other ports shown are DSL, USB, Reset, and Power.</p>
<p>인터넷 서비스가 케이블인 경우, 케이블 모뎀의 케이블 포트가 ISP에서 제공하는 동축 케이블에 연결되어 있는지 확인하십시오.</p>	<p>인터넷 서비스가 DSL인 경우, DSL 전화선이 모뎀의 DSL 포트에 연결되어 있는지 확인하십시오.</p>

- 컴퓨터가 이전에 USB 케이블로 모뎀에 연결되어 있었다면 USB 케이블을 분리하십시오.
- 라우터를 다시 설치하십시오.

라우터 메시지에 액세스할 수 없습니다.

라우터에 액세스하려면 고유 네트워크에 연결되어 있어야 합니다. 현재 무선 인터넷에 연결되어 있다면 다른 무선 네트워크에 실수로 연결한 것일 수 있습니다.

Windows 컴퓨터에서 문제를 해결하려면 다음 작업을 수행하십시오.*

1. Windows 바탕 화면에서 시스템 트레이의 무선 아이콘을 클릭하십시오. 사용 가능한 네트워크 목록이 나타납니다.
2. 고유 네트워크 이름을 클릭하십시오. 연결을 클릭합니다. 아래의 예에서는 컴퓨터가 wraith_5GHz라는 다른 무선 네트워크에 연결되었습니다. 이 예의 경우 Linksys E 시리즈 라우터의 무선 네트워크 이름인 Damaged_Beez2.4가 선택되어 표시됩니다.

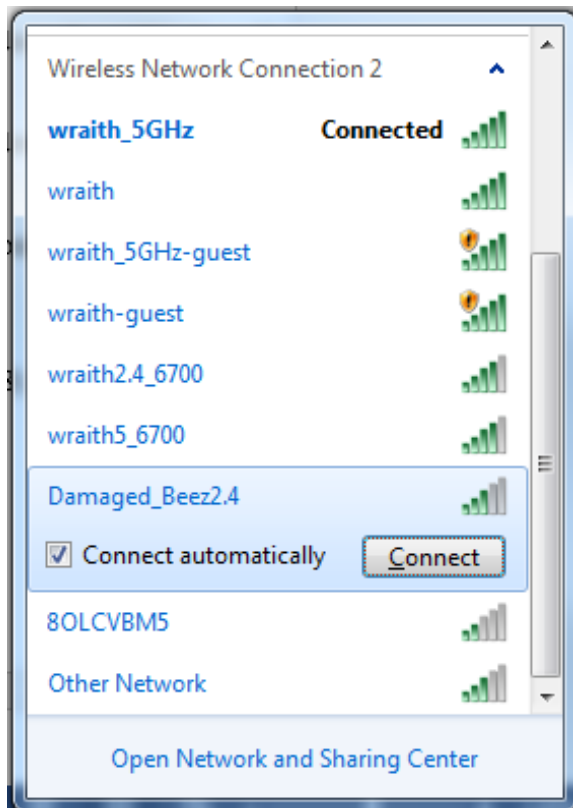

3. 네트워크 보안 키를 입력하라는 메시지가 표시되면, 네트워크 보안 키 필드에 암호(보안 키)를 입력하십시오. 확인을 클릭합니다.
4. 컴퓨터가 네트워크에 연결되고 라우터에 액세스할 수 있습니다.

*Windows 버전에 따라 이 단계에서 문구나 아이콘에 약간의 차이가 있을 수 있습니다.

Mac 컴퓨터에서 문제를 해결하려면 다음 작업을 수행하십시오.

1. 화면 상단의 메뉴 막대에서 Wi-Fi 아이콘을 클릭합니다. 무선 네트워크 목록이 표시됩니다.
2. 아래의 예에서 컴퓨터가 wraith_5GHz라는 다른 무선 네트워크에 연결되었습니다. 이 예에서는 Linksys E 시리즈 라우터의 무선 네트워크 이름인 Damaged_Beez2.4가 선택되어 표시됩니다.

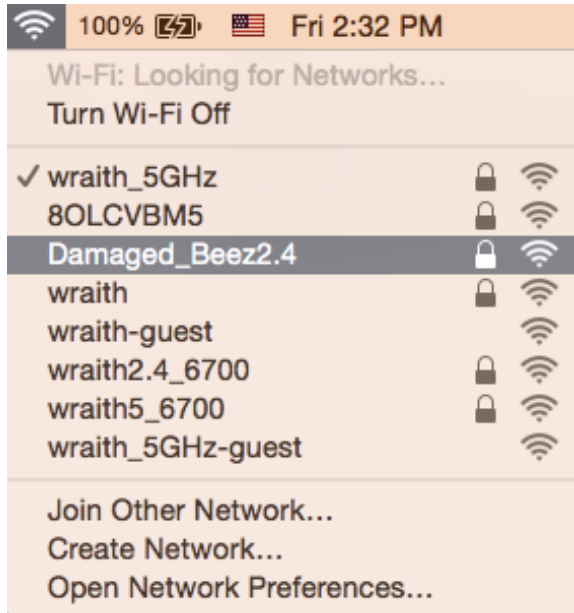

3. Linksys E 시리즈 라우터의 무선 네트워크 이름(이 예에서는 Damaged_Beez2.4)을 클릭하십시오.
4. 암호 필드에 무선 네트워크 암호(보안 키)를 입력하십시오. 확인을 클릭합니다.

설정 후

인터넷을 사용할 수 없는 것으로 보입니다.

인터넷이 라우터와 통신하는 데 문제가 있는 경우, 웹 브라우저에 "인터넷 주소를 찾을 수 없습니다"라는 메시지가 나타날 수 있습니다. 인터넷 주소가 정확하고 동일한 결과를 가진 유효한 여러 인터넷 주소를 시도한 경우, 이 메시지는 ISP 또는 라우터와 통신하는 모뎀에 문제가 있음을 의미할 수 있습니다.

다음을 시도하십시오.

- 네트워크 및 전원 케이블이 안전하게 연결되었는지 확인합니다.
- 라우터가 연결된 전원 콘센트가 전원에 연결되어 있는지 확인합니다.
- 라우터를 재부팅합니다.
- ISP에 연락하여 해당 지역의 정전에 관해 문의하십시오.

라우터 문제를 해결하는 가장 일반적인 방법은 라우터를 꺾다가 다시 켜는 것입니다. 이렇게 하면 라우터가 맞춤형 설정을 다시 로드할 수 있고, 다른 장치(예: 모뎀)가 라우터를 다시 발견하고 라우터와 통신할 수 있습니다. 이 프로세스를 재부팅이라고 합니다.

전원 코드를 사용하여 라우터를 다시 시작하려면 다음 작업을 수행하십시오.

1. 라우터 및 모뎀에서 전원 코드를 분리합니다.
2. 10초 동안 기다렸다가, 모뎀에 전원 코드를 다시 연결하십시오. 전원이 들어오는지 확인합니다.
3. 모뎀의 온라인 표시기가 깜박임(약 2분)을 멈출 때까지 기다립니다. 라우터에 전원 코드를 다시 연결합니다.
4. 재설정 버튼과 전원 포트 사이에서 깜박이는 녹색 LED가 깜박임을 멈출 때까지 기다리십시오. 컴퓨터에서 인터넷에 연결을 시도하기 전에 2분을 기다립니다.

사양

Linksys E5600

모델 이름	AC1200 듀얼-밴드 WiFi 5 라우터
모델 번호	E5600
스위치 포트 속도	10/100/1000 Mbps(고속 이더넷)
무선 주파수	2.4GHz 및 5GHz
안테나 수	4 (내부)
포트	이더넷(1-4), 인터넷, 전원
버튼	Wi-Fi 보호 설정, 재설정, 전원 스위치
LED	전원, 인터넷, 이더넷(1-4)
UPnP	지원됨
보안 특성	WPA2 개인
보안 키 비트	최대 128 비트 암호화

환경

치수	135mm(L) x 38mm(W) x 185.5mm(H)
단위 중량	410g(0.9lbs)
전원	12V, 1A
인증	FCC, IC, CE, Wi-Fi(IEEE 802.11 a/b/g/n/ac)
작동 온도	32 ~ 104°F(0 ~ 40°C)
보관 온도	-4 ~ 140°F(-20 ~ 60°C)
작동 습도	10% ~ 80% 상대 습도, 비응축
보관 습도	5% ~ 90% 비응축

참고:

규정, 보증 및 안전 정보는 라우터와 함께 제공된 CD 를 참조하거나, Linksys.com/support/E5600 을 참조하십시오.

사양은 고지 없이 변경될 수 있습니다.

IEEE Standard 802.11 사양에서 얻은 최대 성능입니다. 실제 성능은 무선 네트워크의 용량 부족, 데이터 처리량, 범위 및 서비스 구역 등에 따라 차이가 있을 수 있습니다. 성능은 액세스 지점으로부터의 거리, 네트워크 트래픽 용량, 건물의 자재 및 건축물, 사용되는 운영 체제, 사용되는 무선 장치의 혼용, 간섭 및 기타 부정적인 조건을 포함한 많은 요인, 조건 및 변수에 따라 차이가 있습니다.

Belkin, Linksys 및 많은 제품 이름과 로고는 Belkin 그룹사의 상표입니다. 여기에 언급된 제 3 자 상표는 각 소유자의 재산입니다. 이 제품에 사용된 제 3 자 소프트웨어의 라이선스 및 고지는 다음에서 참조할 수 있습니다. <http://support.linksys.com/en-us/license>. 질문이나 GPL 소스 코드 요청은 <http://support.linksys.com/en-us/gplcodecenter> 에 문의하십시오.

© 2020 Belkin International, Inc. 및/또는 그 계열사. 모든 권한 보유.

LINKSYS

用户指南》

AC1200

双频段 WiFi 5 路由器

型号 E5600

目录

产品概览	3
前部	3
后部	4
设置：基本信息	5
如何查找更多帮助	5
如何安装您的路由器	5
高级配置	7
如何使用基于浏览器的实用工具	7
基本路由器设置	8
语言	8
互联网设置	9
基本无线设置	10
无线安全	12
安全选项设置	12
WPA2 个人版	12
已禁用	12
故障排除	13
您的路由器设置失败	13
消息：您网线未插入	14
消息：无法访问您的路由器	14
安装完成后	16
互联网似乎不可用	16
规格	17
Linksys E5600	17
环境要求	17

产品概览

前部

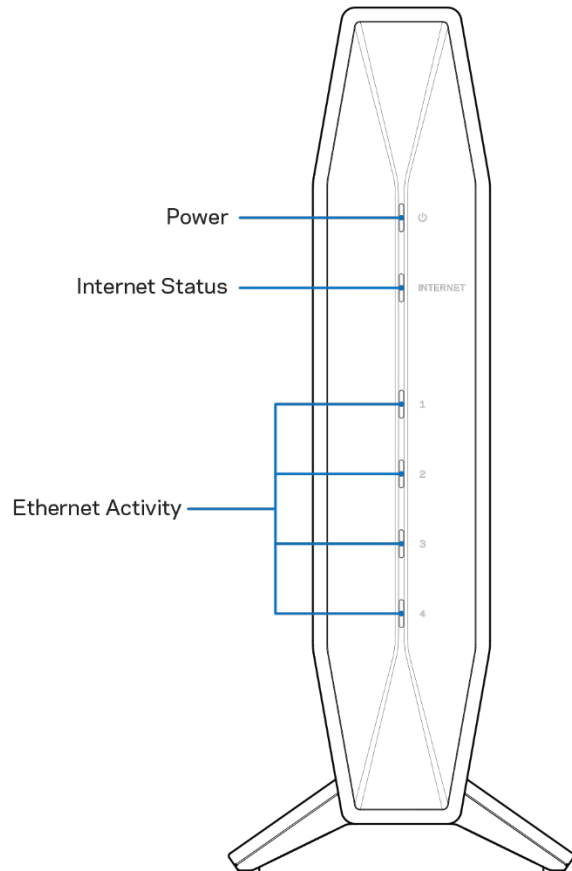

电源指示灯 - 路由器启动时和 WPS 配对过程中闪烁蓝光。如果 WPS 配对失败，则闪烁黄光。

互联网状态指示灯 - 连接到互联网时常亮蓝光，未连接时常亮黄光。

以太网活动指示灯 - 如果以太网缆线连接到相应端口，每个指示灯将常亮蓝光。如果端口上有活动，指示灯将闪烁蓝光。

后部

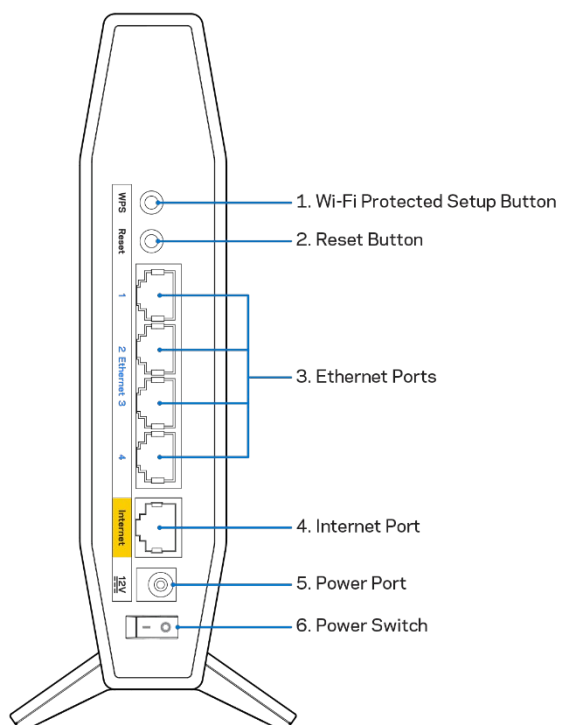

Wi-Fi Protected Setup™ (WPS) 按钮 (1) - 按下即可在启用了 Wi-Fi Protected Setup 的网络设备上轻松配置无线安全性。在 WPS 配对激活之时，按钮下方的指示灯将会闪烁。

重置按钮 (2) - 长按按钮，直到电源 LED 开始闪烁，以将路由器重置为出厂设置。

以太网端口 (3) - 将以太网缆线（也称为网络缆线或网线）连接到这些高速以太网（10/100/1000）端口以及网络上的其他有线设备。仅当以太网缆线已插上并且缆线存在数据流量时，端口下方的指示灯才会亮起。

互联网端口 (4) - 将以太网缆线连接到此端口和调制解调器。仅当以太网缆线已插上并且缆线存在数据流量时，端口下方的指示灯才会亮起。

电源端口 (5) - 将附带的交流电源适配器连接到此端口。

电源开关 (6) - 按 |（开）打开路由器。

注意: 核准编号在产品底部位置标识。

设置：基本信息

如何查找更多帮助

除了本用户指南之外，您还可以访问 Linksys.com/support/E5600 查看帮助（文档、下载、常见问题解答、技术支持、实时聊天、论坛）。

注意：本产品所使用的第三方软件之许可和通知可从以下链接查看：<http://support.linksys.com/en-us/license>。请联系 <http://support.linksys.com/en-us/gplcodecenter>，以获取问题或 GPL 源代码请求。

如何安装您的路由器

1. 如需更换现有的路由器，请首先断开路由器。
2. 将路由器插入电源。确保电源开关处于 |（开）位置。
3. 将您的新路由器连接至您的调制解调器或调制解调器路由器。

A 调制解调器		B 调制解调器路由器
将包含的以太网缆线一端插入您新路由器的黄色互联网端口。如果您使用调制解调器，则将另一端插入到调制解调器上的以太网 (LAN) 端口。	或者	将以太网缆线一端插入您新路由器的黄色互联网端口。如果您有调制解调器路由器，请将另一端插入任何可用端口。

4. 连接到您的路由器随附的《快速入门指南》中所示的网络名称。（您可以稍后更改网络名称和密码。）选择此选项可在日后自动连接该网络。如果您需要获得连接网络方面的帮助，请参考随附 CD 上的设备文件。

注意——在路由器设置完成之前，您将无法访问互联网。

5. 打开网页浏览器访问 <http://myrouter.local>。遵循屏幕上的指示，以完成设置流程。您还可以在浏览器中输入 192.168.1.1，以开始设置。

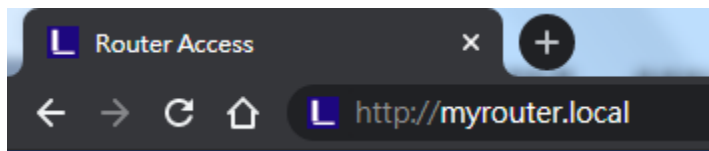

6. 安装完成之后，请确保注册您的路由器，这样您能够随时获取相关安全更新、产品召回以及能够改进您体验的其他事宜。

Register your product

Once you register we can share important security updates. Product recalls and other things that will improve your experience. All we need is your email. We will only use your email for limited security and customer support purposes.

Email Address

Linksys may also email me to keep up to date with special offers and information from linksys. You can unsubscribe at any time by using the link at the end of any email we send.[Read our Privacy Policy here.](#)

[Next](#) [Skip](#)

高级配置

如何使用基于浏览器的实用工具

如欲访问某些高级设置，您需要打开基于浏览器的实用工具。确保您成功连接到路由器，打开网页浏览器，并输入 <http://myrouter.local> 或者前往 192.168.1.1。

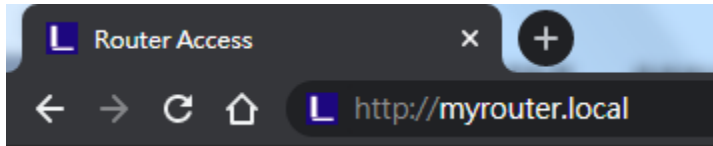

路由器将提示您输入密码。

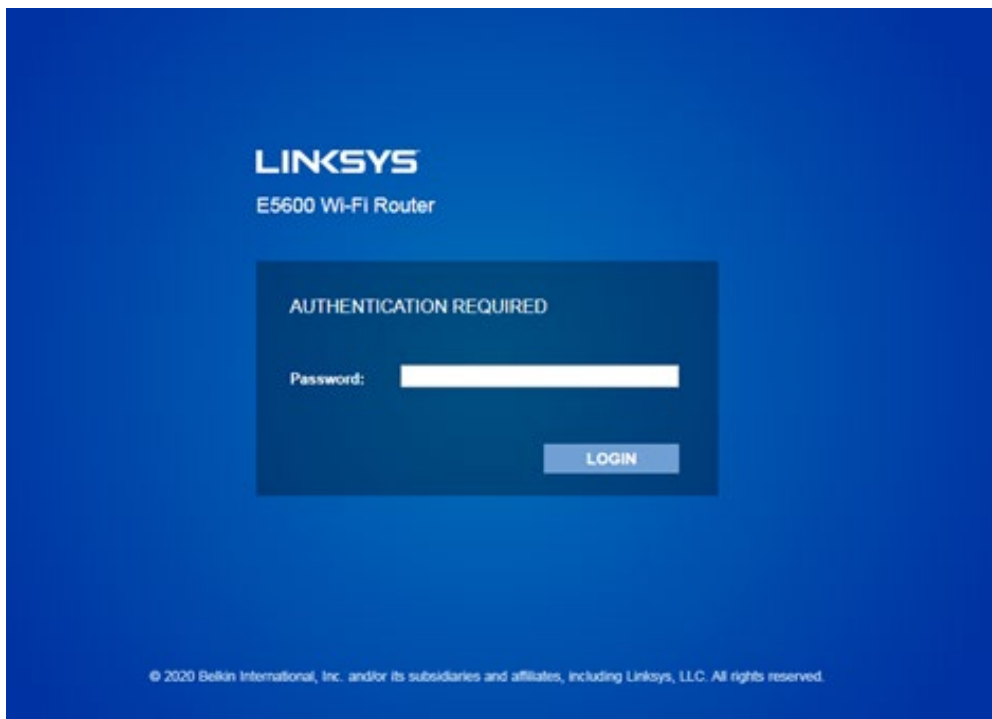

如果您在设置过程中更改了密码，请输入新密码。点击“登录”。如果您未更改密码或完全跳过了设置，默认密码为“admin”。

基本路由器设置

该窗口允许您更改路由器的基本配置。

The screenshot shows the Linksys configuration interface for the 'Local Network' section. The top navigation bar includes 'System Status', 'Configuration', 'Parental Controls', and 'Troubleshooting'. The left sidebar lists various settings categories, with 'Connectivity' expanded to show 'Local Network' options like WAN Setup, VLAN Setup, IPv6 Setup, MAC Address Clone, and Advanced Routing. The main content area is titled 'Local Network' and contains two sections: 'Router Address' and 'DHCP Server Setting'. The 'Router Address' section includes fields for IP Address (192.168.1.1), Subnet Mask (255.255.255.0), and Router Name (Linksys00020). The 'DHCP Server Setting' section has a checked 'DHCP Server' checkbox and a 'DHCP Reservation' button. Below this are fields for Start IP Address (192.168.1.100), Maximum Numbers of Users (50), IP Address Range (192.168.1.100 to 149), Client Lease Time (0 minutes), and three Static DNS fields (all set to 0.0.0.0). A WINS field is also present, set to 0.0.0.0. At the bottom of the form are 'Save' and 'Cancel' buttons.

语言

选择您的语言——如需更改语言，请从下拉菜单中选择一种语言。基于浏览器工具的语言将在5秒钟内进行变更。

The screenshot shows the Linksys configuration interface for the 'Language' section. The top navigation bar and left sidebar are consistent with the previous screenshot. The main content area is titled 'Language' and features a 'Select your language' dropdown menu currently set to 'English'. Below the dropdown are 'Save' and 'Cancel' buttons.

互联网设置

“互联网设置”部分可使用您的互联网连接信息配置路由器。此信息由您的互联网服务提供商（ISP）提供。互联网连接类型——从下拉菜单中选择您的ISP提供商所提供的互联网连接类型。

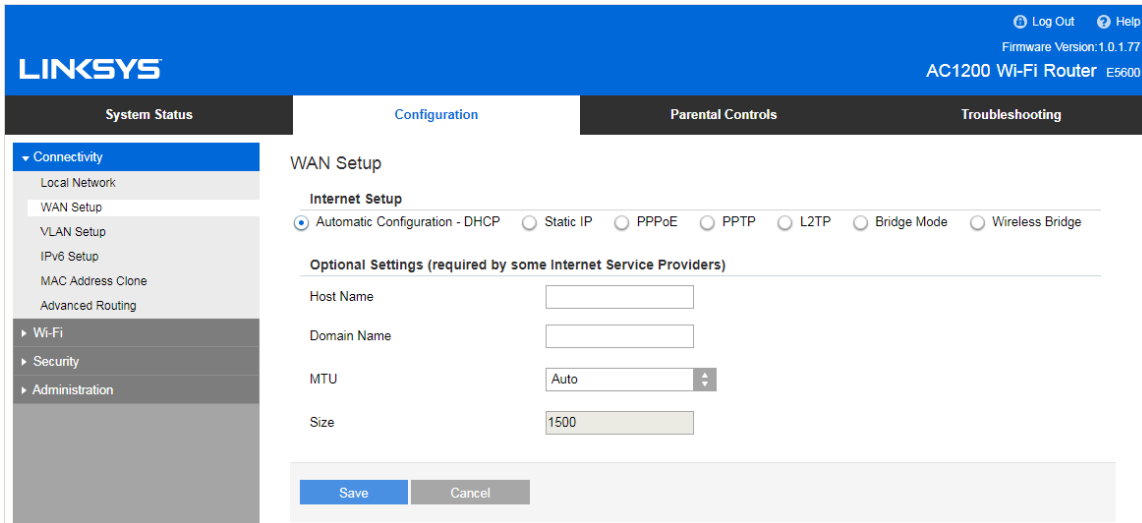

The screenshot shows the Linksys configuration interface for WAN Setup. The 'Internet Setup' section has the following options:

- Automatic Configuration - DHCP
- Static IP
- PPPoE
- PPTP
- L2TP
- Bridge Mode
- Wireless Bridge

The 'Optional Settings' section includes:

- Host Name:
- Domain Name:
- MTU:
- Size:

Buttons: Save, Cancel

- 自动配置 - DHCP（默认）

只有在互联网服务提供商支持 DHCP 或使用动态 IP 地址连接网络时，才保持默认设置。（这一选项通常适用于网线连接。）
- 静态 IP
如果您需要使用固定的 IP 地址连接至互联网，请选择此项。
- PPPoE
如果您拥有一个 DSL 设备且您的 ISP 使用以太网点对点协议（PPPoE），请选择此项。
- PPTP
点对点隧道协议（PPTP）是一项通常适用于欧洲地区互联网连接的服务。如果您的 PPTP 连接支持 DHCP 或动态 IP 地址，请选择自动获取 IP 地址。如果您需要使用固定 IP 地址连接互联网，请选择指定 IP 地址并配置所显示的选项。
- L2TP
第二层隧道协议（L2TP）是以色列常用连接服务协议。
请注意：“按需连接”或“保持连接”是选择 PPPoE、PPTP 和 L2TP 时的选择。其可允许您选择路由器仅按需连接至互联网（如果您的 ISP 按连接时间收费的话），或者始终保持连接。选择恰当的选项。
- 桥接模式
桥接模式将禁用所有路由器功能，并将路由器变为一个接入点。 路由器将不再作为一个 DHCP 服务器；并且，其内置防火墙及 NAT 功能也将失效。
- 无线网桥
无线网桥可通过无线的方式连接至您的主路由器，并与连接至网桥以太网端口的设备分享互联网连接。

基本无线设置

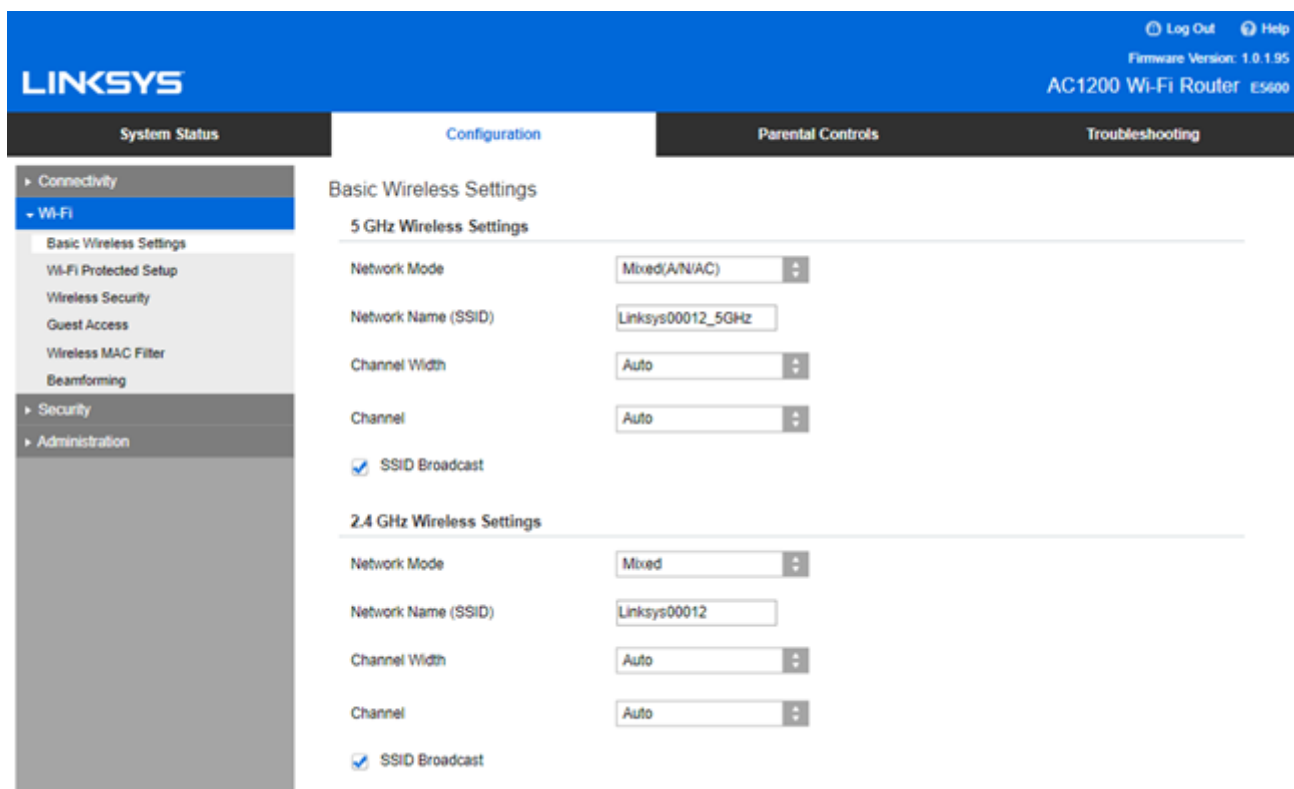

网络模式——选择您的网络支持的无线标准。

- 混合（默认）
如果您的网络中有 Wireless-N、Wireless-A 和 Wireless-AC 设备，请保留默认设置。
- 仅使用Wireless-A
如果您只有Wireless-A设备，请选择此项。
- 仅使用Wireless-N
如果您只有Wireless-N 设备，请选择此项。
- 已禁用
如果您的网络中没有Wireless-N、Wireless-G和Wireless-B设备，请保持默认设置。

请注意——您可以选择混合、仅限Wireless-N/AC 或禁用5 GHz频段。如果您不确定要选择哪种模式，请选择默认（混合）设置。

网络名称 (SSID)

服务设备标识符 (SSID) 是设备用于连接无线网络的名称。SSID区分大小写，并不可超过32个字符。2.4 GHz和5 GHz网络默认的SSID分别是LinksysXXXXX和LinksysXXXXX_5GHz。X代表路由器序列号最后5位数，可在路由器底部找到。如果您更改SSID，两个频段都会显示新的SSID。您可通过基于浏览器的工具给它们设置新的名称。

请注意——如果您将路由器恢复出厂默认设置（按住“重置”按钮或，或进入“管理>恢复默认设置”窗口），网络名称会恢复为默认名称。将网络名称更改为原来的名称，否则，您需要将无线网络中所有设备重新连接至新的网络名称。

信道宽度

保持默认的“自动”（20 MHz或40 MHz），可在2.4 GHz网络中确保Wireless-B、Wireless-G和Wireless-N 设备实现最佳性能。对于20 MHz的信道宽度，请选择仅使用20 MHz。如希望在5 GHz网络中实现最佳性能，请保持默认的20、40或80 MHz。

信道

从下拉列表中选择信道。如果您不知道要选择哪个信道，请保持默认设置“自动”。

SSID广播

请保持默认设置“启用”，以广播路由器的SSID。在搜索局部地区要关联的无线网络时，无线客户端可以检测到路由器广播的SSID。尝试隐藏您的Wi-Fi网络名称并不能增强您Wi-Fi网络的安全性。即使您关闭了项功能，如果某人真的想要访问您的网络，他们也能够找到该网络名称。如果您依然不希望广播路由器的SSID，请选择“禁用”。

无线安全

路由器可提供以下无线安全选项：

WPA2 个人版/WPA2 企业版（WPA 代表 Wi-Fi 保护访问。）

安全选项	强度
WPA2 个人版	最强

安全选项设置

WPA2 个人版

如果您选择“**WPA2 个人版**”，无线网络中的每个设备都必须使用“**WPA2 个人版**”配置和同样的密码。

Security Mode

WPA2 Personal

密码——请输入由8-63个字符组成的密码。这是用于提供网络访问权限的Wi-Fi密码。其可以和设置时所输入的密码一致。

已禁用

如果您选择禁用无线安全，您将会在首次尝试访问互联网时收到提示信息，说明无线安全已禁用。将会向您提供启用无线安全或确认已经了解相关风险但是仍然希望禁用无线安全并继续的选项。

Security Mode

Disabled

故障排除

您可以访问我们备受赞誉的客户支持网站 (Linksys.com/support/E5600) 查看更多帮助。

您的路由器设置失败

如果您无法在基于浏览器的界面中完成设置，您可以尝试以下步骤：

- 用回形针或别针长按路由器上的“重置”按钮，直到路由器正面的电源指示灯熄灭并开始闪烁（约 10 秒）。在浏览器中输入 192.168.1.1，然后再次尝试设置。

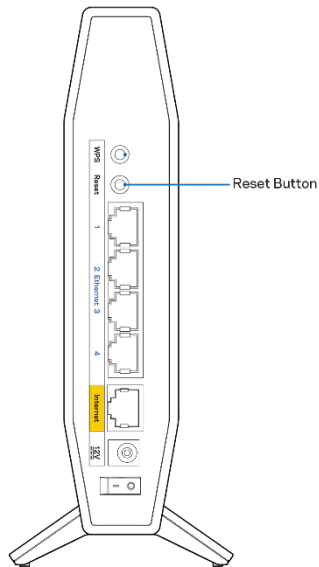

- 临时禁用您计算机的防火墙（请参考安全软件指南，以获得更多帮助）。重新安装路由器。
- 如果您拥有另一台计算机，则可使用该计算机设置路由器。

消息：您网线未插入

如果您在尝试设置路由器时收到“您的网线未插入”的提示消息：

- 请确保以太网缆线或网线（或一条类似路由器所随附的缆线）牢固地连接到路由器背后的黄色互联网端口以及调制解调器的适当端口上。调制解调器的端口通常标记为以太网端口。

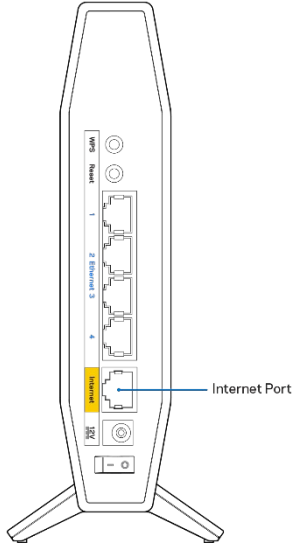

- 请确保您的调制解调器接上电源并处于开启状态。

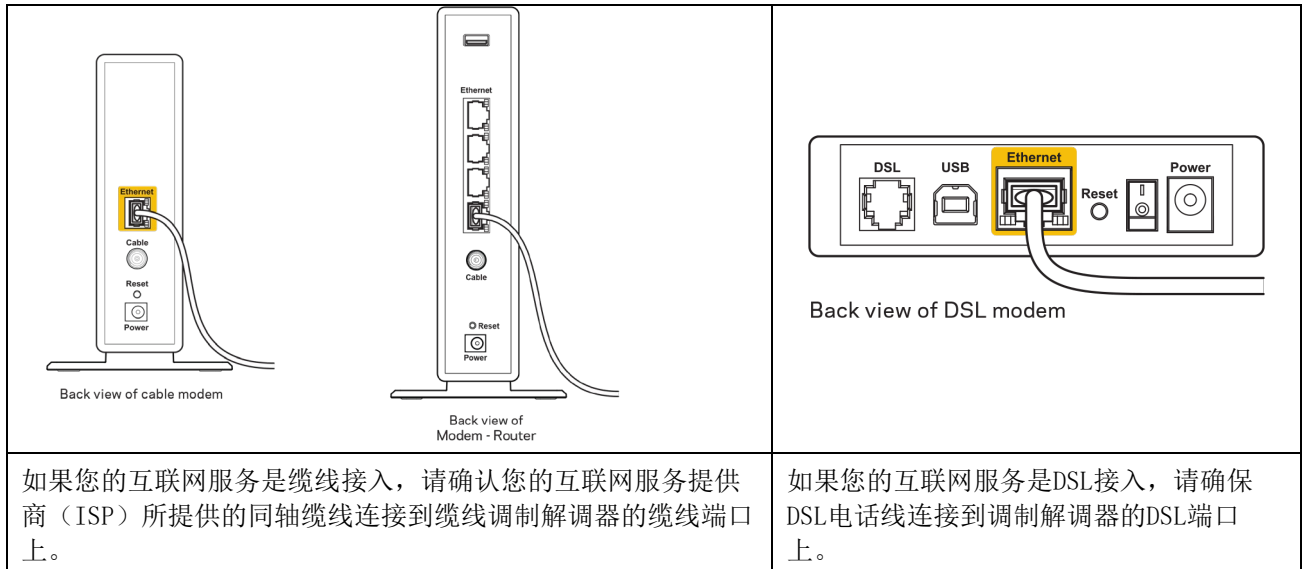

如果您的互联网服务是缆线接入，请确认您的互联网服务提供商（ISP）所提供的同轴缆线连接到缆线调制解调器的缆线端口上。

如果您的互联网服务是DSL接入，请确保DSL电话线连接到调制解调器的DSL端口上。

- 如果您的计算机之前曾使用USB缆线连接到您的调制解调器，请断开该USB缆线。
- 重新安装路由器。

消息：无法访问您的路由器

如需访问您的路由器，您必须连接到您自己的网络。如果您使用无线互联网连接，问题的原因可能是您意外连接到其他无线网络。

在Windows计算机上解决问题，请遵循以下步骤*：

1. 请在您的Windows桌面上点击系统托盘中的无线图标。出现一个可用网络列表。
2. 点击您自己的网络名称。点击“连接”。在下文所示的示例中，该计算机已连接到另一个名为“wraith_5GHz”的无线网络。在此示例中，我们选择了名为“Damaged_Beez2.4”的Linksys E系列路由器的无线网络。



3. 如果您收到输入网络安全密钥的提示，请将您的密码（安全密钥）输入到网络安全密钥对话框中。点击“确定”。
4. 您的计算机将连接到网络，现在您可以访问路由器。

*根据您的计算机版本，在这些步骤中的用词或图标可能会存在差异。

如需在Mac计算机上解决问题，请遵循以下步骤：

1. 在屏幕上方的菜单栏中点击Wi-Fi图标。出现一个无线网络列表。
2. 在下文所示的示例中，该计算机已连接到另一个名为“wraith_5GHz”的无线网络。在此示例中，我们选择了名为“Damaged_Beez2.4”的Linksys E系列路由器的无线网络。

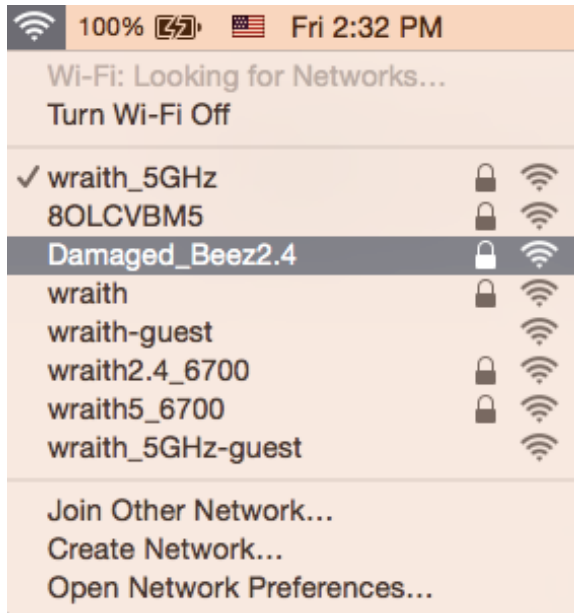

3. 点击您的Linksys E系列路由器无线网络名称（在此示例中为“Damaged_Beez2.4”）。
4. 在“密码”栏中输入您的无线网络密码（安全密钥）。点击“确定”。

安装完成后

互联网似乎不可用

如果您的路由器无法连接到互联网，则您的网页浏览器将会出现提示信息“无法找到[互联网地址]”。如果您确定该互联网地址正确，并且，如果您已经多次尝试了有效的互联网地址但结果相同的话，则该信息将意味着您的路由器无法连接到您的ISP或调制解调器。

请尝试以下步骤：

- 确保网络和电源线均安全连接。
- 确保您路由器的电源插座正确连接。
- 重启您的路由器。
- 联系您所在区域的ISP，并咨询有关服务中断情况。

检修您路由器的最常用方法是关闭电源，然后重启。然后您的路由器可以重载其自定义设置，而其他设备（例如调制解调器）将可以重新发现路由器并且与其连接。此过程称为“重启”。

如需通过电源线重启您的路由器，请遵循以下步骤：

1. 断开路由器和调制解调器的电源线。
2. 等待 10 秒，然后将电源线重新连接到调制解调器。确保通电正常。
3. 等待直到调制解调器的在线指示灯停止闪烁（大概2分钟）。重新连接路由器的电源线。
4. 等待直至设置按钮和电源线之间绿色闪烁的LED指示灯转为常亮。在尝试从一台计算机连接到互联网之前，请等待2分钟。

规格

Linksys E5600

型号名称	AC1200 双频段 WiFi 5 路由器
产品型号	E5600
交换机端口速度	10/100/1000 Mbps (高速以太网)
无线电频率	2.4 GHz 和 5 GHz
天线数量	4 个内部天线
端口	以太网 (1-4) 端口、互联网端口、电源接口
按钮	Wi-Fi Protected Setup、重置、电源开关
LED 指示灯	电源、互联网、以太网 (1-4)
UPnP	支持
安全特性	WPA2 个人版
安全密钥数位	高达 128 位加密

环境要求

尺寸	135mm (长) x 38mm (宽) x 185.5mm (高)
单位重量	410 克 (0.9 磅)
电源	12V, 1A
认证	FCC、IC、CE、Wi-Fi (IEEE 802.11a/b/g/n/ac)
工作温度	32 至 104° F (0 至 40° C)
存储温度	-4至140° F (-20至60° C)
工作湿度	10%至80%相对湿度, 无冷凝
存储湿度	5%至90%, 无冷凝

注意:

有关法规、保修和安全信息, 请参阅路由器随附的 CD 或访问 Linksys.com/support/E5600。

如规格发生变化, 恕不另行通知。

最佳性能基于IEEE标准802.11规范。实际性能可能有所变化, 包括无线网络功能降低、数据吞吐率减小、距离和覆盖范围缩小。性能取决于很多因素、条件和变量, 包括与接入点的距离、网络通信量、建筑物材料和构造、所使用的操作系统、无线产品组合、干扰和其他不利条件。

BELKIN、LINKSYS 以及众多产品名称和徽标均为贝尔金公司集团的商标。所述的第三方商标均为其各自所有者之财产。本产品所使用的第三方软件之许可和通知可从以下链接查看: <http://support.linksys.com/en-us/license>。请联系 <http://support.linksys.com/en-us/gplcodecenter>, 以获取问题或 GPL 源代码请求。

© 2020 贝尔金国际有限公司及/或其附属品牌公司。保留所有权利。

LINKSYS

使用者指南

AC1200
雙頻段 WiFi 5 路由器

型號 E5600

目錄

產品概觀	3
前板	3
背板	4
設定：基本知識	5
如何尋找更多說明	5
如何安裝您的路由器	5
進階設定	7
如何開啟瀏覽器公用程式	7
基本路由器設定	8
語言	8
網際網路設定	9
基本無線設定	10
無線安全	12
安全性選項設定	12
WPA2 個人	12
已停用	12
故障排除	13
您的路由器設定失敗	13
未插入網路纜線訊息	14
無法存取您的路由器訊息	14
設定後	16
網際網路似乎無法使用	16
規格	17
Linksys E 5600	17
環境規格	17

產品概觀

前板

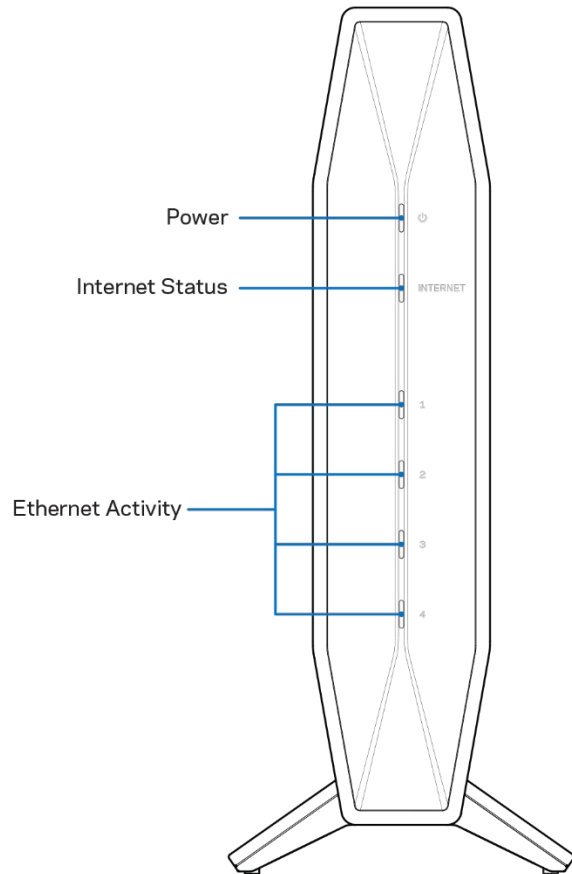

電源燈—路由器啟動時和 WPS 配對過程中將會發出閃爍的藍光。如果 WPS 配對失敗，則發出閃爍的黃光
網際網路連接狀態指示燈—當連接到網路時會發出穩定的藍光，未連接時則發出穩定的黃光。

乙太網活動燈—如果將乙太網電纜連接到相應的端口，指示燈將呈穩定的藍光。如果端口上有活動，這些指示燈將呈現閃爍的藍光。

背板

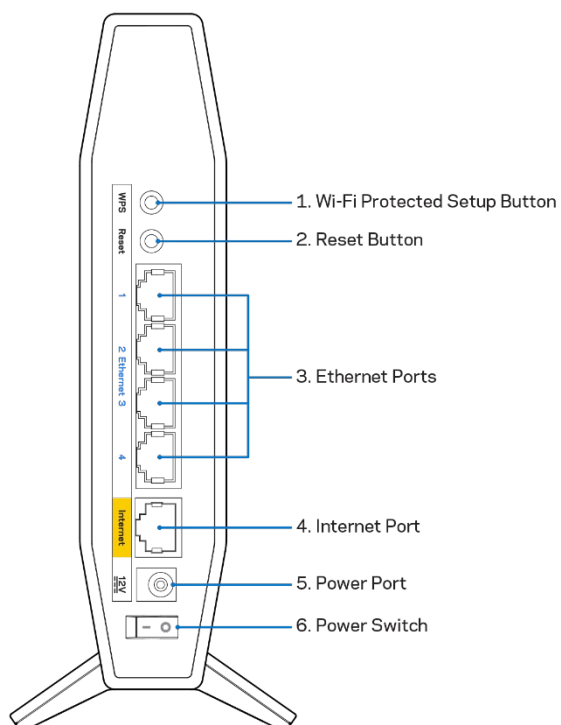

Wi-Fi Protected Setup™ (WPS) 按鈕 (1) — 按一下即可在啟用了 Wi-Fi 保護設置的網路設備上輕鬆設定無線安全功能的參數。按鈕下方的指示燈會在 WPS 配對啟動時閃爍。

重設按鈕 (2) — 按住直到電源的 LED 指示燈開始閃爍，即可將路由器重設為出廠設定。

乙太網端口 (3) - 將乙太網電纜（也稱為網絡電纜或因特網電纜）連接到高速的乙太網（10/100/1000）端口以及網路上的其他有線連接設備。連接埠下方的指示燈僅會在已插入乙太網路纜線，且該纜線上有資料流量時亮起。

網際網路端口 (4) — 將乙太網電纜連接到此端口和數據機上。連接埠下方的指示燈僅會在已插入乙太網路纜線，且該纜線上有資料流量時亮起。

電源端口 (5) — 將附帶的交流電源適配器連接到此端口。

電源開關 (6) — 按 I (ON) 鍵開啟路由器。

設定：基本知識

如何尋找更多說明

除了本用戶指南之外，您還可以在 Linksys.com/support/E5600 上找到幫助（文檔、下載、常見問題解答、技術支援、即時聊天、論壇）。

備註：您可以在下列位置檢視用於本產品的協力廠商軟體授權與注意事項：<http://support.linksys.com/en-us/license>。請造訪：<http://support.linksys.com/en-us/gplcodecenter>，詢問問題或請求 GPL 原始程式碼。

如何安裝您的路由器

1. 如需更換現有的路由器，請先中斷路由器連線。
2. 將路由器插入電源。請確認電源開關在（ON）的位置。
3. 將新的路由器連接至數據機或數據機路由器。

A數據機	或者	B數據機 — 路由器
將隨附的乙太網路纜線的一端連接至新路由器上的黃色網際網路連接埠。若您有數據機，請將另一端插入數據機上的 乙太網路 (LAN) 連接埠 。		將隨附的乙太網路纜線的一端連接至新路由器上的黃色網際網路連接埠。如果您有數據機-路由器，請將另一端插入 任何可用的端口 。

4. 連接到於路由器隨附之《快速入門手冊》中所示的網路名稱。（稍後您可變更網路名稱與密碼。）選取選項以方便日後自動連接至此網路。如果您需要如何連接至網路的說明，請參閱隨附 **CD** 中的裝置文件。

注意：在路由器設定完成之前，您將沒有網際網路存取。

5. 在網路瀏覽器中輸入：<http://myrouter.local>。依照畫面上的指示，完成設定。您也可以直接在瀏覽器輸入 192.168.1.1 以開始設定。

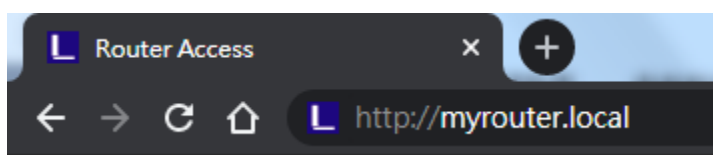

6. 一旦您完成設定之後，請務必註冊您的路由器，持續獲得安全性更新、產品召回與其他能改善您體驗的事物。

Register your product

Once you register we can share important security updates. Product recalls and other things that will improve your experience. All we need is your email. We will only use your email for limited security and customer support purposes.

Email Address

Linksys may also email me to keep up to date with special offers and information from linksys. You can unsubscribe at any time by using the link at the end of any email we send.[Read our Privacy Policy here.](#)

[Next](#) [Skip](#)

進階設定

如何開啟瀏覽器公用程式

若要存取某些進階設定，您必須開啟瀏覽器公用程式。請確認您已連線至路由器，開啟網路流反器並在網頁瀏覽器中輸入 <http://myrouter.local>，或前往 192.168.1.1。

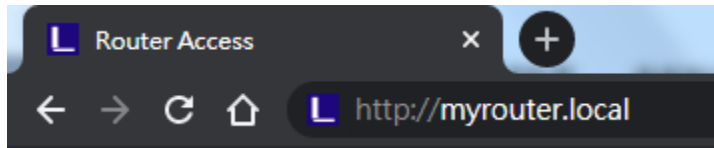

路由器將提示您輸入密碼。

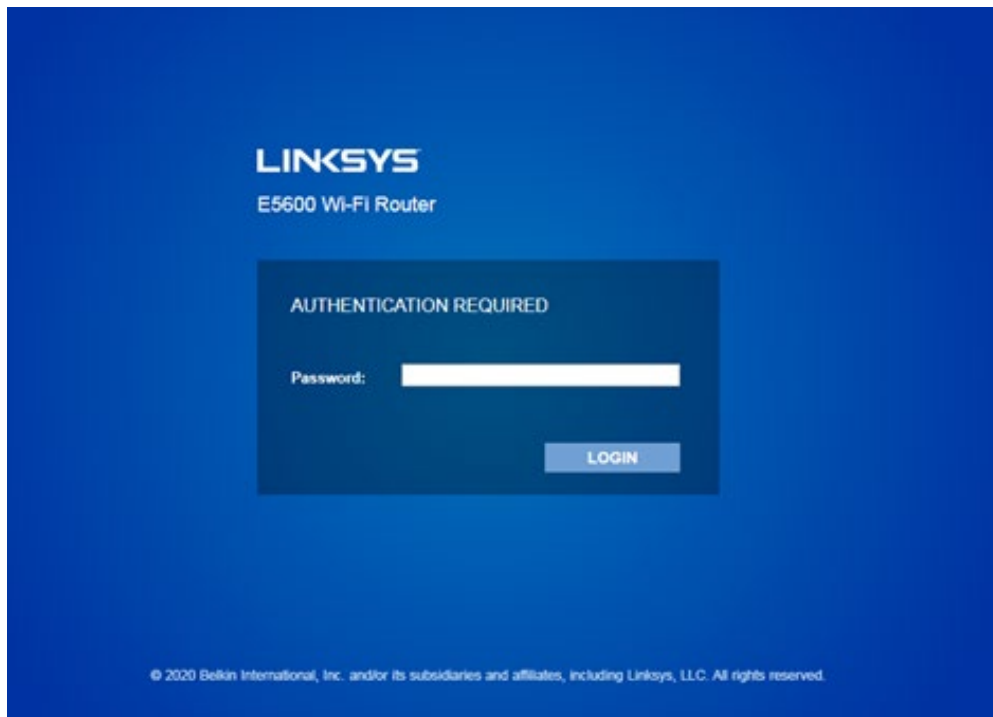

如果您在設定過程中更改了密碼，請輸入新密碼。按一下登入。如果您沒有更改密碼或完全跳過設定，則默認密碼為「admin」。

基本路由器設定

此畫面讓您可以變更路由器的基本設定。

The screenshot shows the Linksys configuration interface for the 'Local Network' section. The top navigation bar includes 'System Status', 'Configuration', 'Parental Controls', and 'Troubleshooting'. The left sidebar lists various settings categories like 'Connectivity', 'Wi-Fi', 'Security', and 'Administration'. The main content area is titled 'Local Network' and contains two sub-sections: 'Router Address' and 'DHCP Server Setting'. The 'Router Address' section includes fields for IP Address (192.168.1.1), Subnet Mask (255.255.255.0), and Router Name (Linksys00020). The 'DHCP Server Setting' section has a checked 'DHCP Server' option, a 'DHCP Reservation' button, and fields for Start IP Address (192.168.1.100), Maximum Numbers of Users (50), IP Address Range (192.168.1.100 to 149), Client Lease Time (0 minutes), and three Static DNS fields (all set to 0.0.0.0). A 'WINS' field is also present, set to 0.0.0.0. At the bottom, there are 'Save' and 'Cancel' buttons.

語言

選擇您的語言－若要變更語言，請從下拉式功能表中選擇一種語言。瀏覽器公用程式的語言將會在五秒內變更。

The screenshot shows the Linksys configuration interface for the 'Language' section. The top navigation bar and left sidebar are identical to the previous screenshot. The main content area is titled 'Language' and contains a 'Select your language' dropdown menu currently set to 'English'. At the bottom, there are 'Save' and 'Cancel' buttons.

網際網路設定

網際網路設定區域可以將路由器設定至您的網際網路連線。此資訊皆可透過您的網際網路服務提供者 (ISP) 取得。

網際網路連線類型－從下拉式功能表中，選取您的 ISP 所提供的網際網路連線型別。

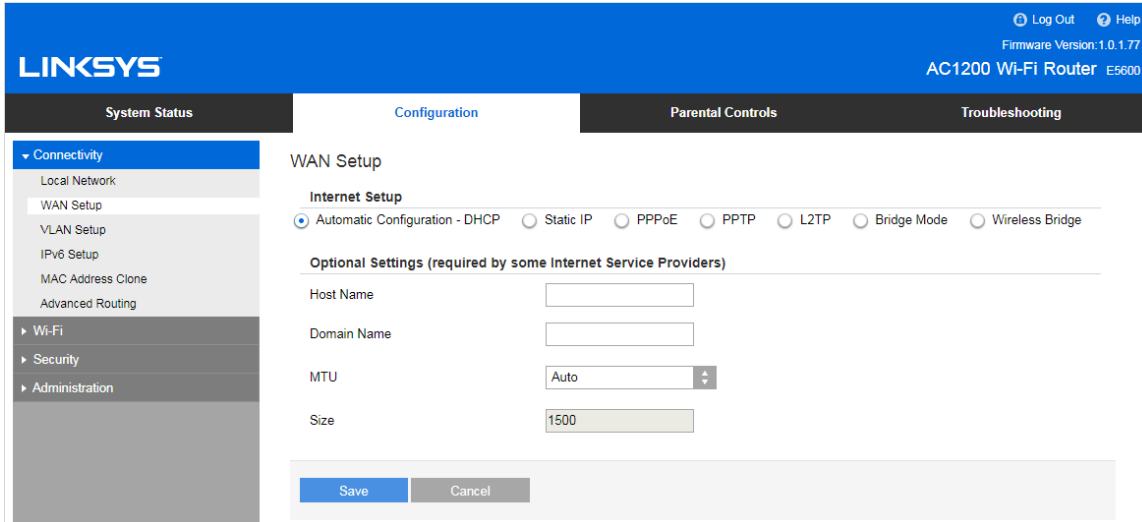

The screenshot shows the Linksys configuration interface for an AC1200 Wi-Fi Router E5600. The 'Configuration' tab is active, and the 'WAN Setup' section is expanded. Under 'Internet Setup', the 'Automatic Configuration - DHCP' option is selected. The 'Optional Settings' section includes fields for Host Name, Domain Name, MTU (set to Auto), and Size (set to 1500). Save and Cancel buttons are visible at the bottom.

- 自動設定－DHCP（預設）
僅在若您的 ISP 支援 DHCP 或若您的連線使用動態的 IP 位址時維持預設。（此選項通常適用於電纜連線）。
- 靜態 IP
若您必須使用固定 IP 位址來連接至網際網路，請選擇靜態 IP。
- PPPoE
若您擁有 DSL 連線，且您的 ISP 使用乙太網路上的點對點通訊協定 (PPPoE)，請選擇 PPPoE。
- PPTP
點對點通道通訊協定 (PPTP) 為一種一般來說適用於歐洲連線的服務。若您的 PPTP 連線支援 DHCP 或動態 IP 位址，則請選擇「自動取得 IP 位址」。若您必須使用固定的 IP 位址 連接到網際網路，則請選擇「指定一組 IP 位址」，並設定下方選項。
- L2TP
第 2 層通道通訊協定 (L2TP) 為一種一般來說適用於以色列連線的服務。
[備註－隨選連線與保持活躍，為選擇 PPPoE、PPTP 與 L2TP 時的選項。這讓您可以選擇路由器是否幾在需要時連線至網際網路（若您的 ISP 因連線時間而收費時使用），或者選擇路由器是否應永遠連線。請選擇適當的選項。](#)
- 橋接模式
橋接模式會停用所有路由器功能，且將路由器當作存取點使用。 路由器將不會再被當成 DHCP 伺服器使用，且內建防火牆以及 NAT 功能也將失效。
- 無線橋接器
無線橋接器可以無線連接至您的主路由器，且可以與連線至橋接器乙太網路連接埠的裝置共用網際網路連線。

基本無線設定

The screenshot shows the Linksys web interface for an AC1200 Wi-Fi Router. The top navigation bar includes 'Log Out' and 'Help' links, and the firmware version is 1.0.1.95. The main menu has four tabs: 'System Status', 'Configuration', 'Parental Controls', and 'Troubleshooting'. Under 'Configuration', the 'Wi-Fi' section is expanded, showing 'Basic Wireless Settings' as the active page. The settings are divided into two sections: '5 GHz Wireless Settings' and '2.4 GHz Wireless Settings'. In the 5 GHz section, 'Network Mode' is set to 'Mixed(A/N/AC)', 'Network Name (SSID)' is 'Linksys00012_5GHz', 'Channel Width' is 'Auto', and 'Channel' is 'Auto'. The 'SSID Broadcast' checkbox is checked. In the 2.4 GHz section, 'Network Mode' is set to 'Mixed', 'Network Name (SSID)' is 'Linksys00012', 'Channel Width' is 'Auto', and 'Channel' is 'Auto'. The 'SSID Broadcast' checkbox is also checked.

網路模式－選擇您的網路可支援的無線標準。

- 混合型（預設）

如果網路中有 Wireless-N、Wireless-A 和 Wireless-AC 設備，請保留默認設定。

- 僅 Wireless-A

若您僅有 Wireless-A 裝置請選擇此項。

- 僅 Wireless-N

若您僅有 Wireless-N 裝置請選擇此項。

- 已停用

若您的網路上沒有 Wireless-B、Wireless-G 與 Wireless-N 裝置，請選擇「已停用」。

備註－您也可以 5 GHz 頻帶上選擇混用型、僅 Wireless-N/AC 或已停用。若您不確定應使用何種模式，請維持預設的「混用型」。

網路名稱 (SSID)

服務組識別元 (SSID) 是裝置用於連線至無線網路的名稱。SSID 區分大小寫，且不可超過 32 個鍵盤字元。2.4 GHz 與 5 GHz 網路的預設服務組識別元 (SSID) 各為 LinksysXXXXXX 與 LinksysXXXXXX_5GHz。X 代表路由器序號的最後 5 碼，您可於路由器背面找到此組序號。若您變更了 SSID，兩種頻帶都會擁有新 SSID。您可以透過瀏覽器公用程式為其提供不同名稱。

備註—若您還原了路由器的出廠預設（透過按下重新開機按鈕或使用「管理 > 出廠預設畫面」），則網路名稱將會回到預設值。將網路名稱變更至原始名稱，否則您將無線網路上所有裝置重新連線至新的網路名稱。

通道寬度

維持預設的「自動 (20 MHz 或 40 MHz)」可在使用 Wireless-B、Wireless-G 與 Wireless-N 的裝置 2.4 GHz 網路上獲得最佳效能。僅針對 20 MHz 頻道寬度，請選擇「僅 20 MHz」。為了在 5 GHz 網路上獲得最佳效能，請維持預設的 20、40 或 80 MHz。

通道

從下拉式清單中選擇通道。若您不確定應選擇哪一個通道時，請維持預設「自動」。

SSID 廣播

維持預設的「已啟用」才可廣播路由器的 SSID。當無線用戶端檢視本地區域，尋找關連的無線網路時，將會偵測到路由器廣播的 SSID。嘗試隱藏您的 Wi-Fi 名稱並不會讓 Wi-Fi 變得更安全。即便您關閉此功能，任何真心想取用您網路的人仍可以找得到您的網路。若您不想廣播路由器的 SSID，則請選擇「已停用」。

無線安全

路由器提供下列無線安全性選項：

WPA2 個人（WPA 代表受到保護的 Wi-Fi 訪問。）

安全性選項	強度
WPA2 個人	最強

安全性選項設定

WPA2 個人

若您選擇了 WPA2 個人，則您無線網路上的各裝置都必須使用 WPA2 個人且擁有相同的複雜密碼。

Security Mode

WPA2 Personal

複雜密碼—輸入一組 8-63 個字元的複雜密碼。此為提供網際網路存取的 Wi-Fi 密碼。可以與設定時輸入的密碼相同。

已停用

若您選擇停用無線安全性，在您第一次嘗試存取網際網路時，將收到無線安全性已停用的通知。您將可以選擇啟用無線安全性，或確認您瞭解其中風險，但仍希望停用無線安全性便繼續。

Security Mode

Disabled

故障排除

您可以從我們屢獲殊榮的客戶服務 (Linksys.com/support/E5600) 中找到更多幫助。

您的路由器設定失敗

若您無法在瀏覽器介面上完成設定，可以嘗試下列步驟：

- 用迴紋針或大頭針按住路由器上的「重設」按鈕，直到路由器前面的電源指示燈熄滅並開始閃爍（約 10 秒鐘）為止。在瀏覽器中輸入 192.168.1.1 來重新嘗試設定。

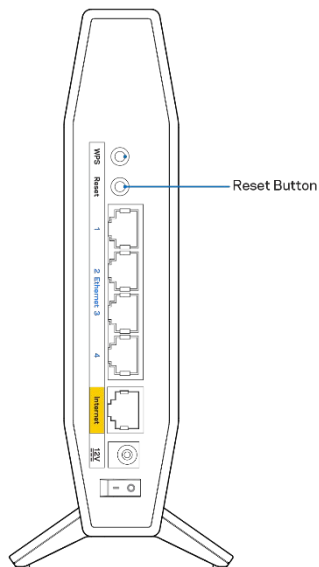

- 暫時停用您電腦的防火牆 (請參閱安全性軟體的說明)。重新安裝路由器。
- 若您有其他台電腦，請使用該電腦來安裝路由器。

未插入網路纜線訊息

如果您在嘗試設定路由器時收到「未插入網路纜線」的訊息，請按照以下設定您的路由器：

- 請確保乙太網路或網際網路纜線（或一條類似路由器所隨附的纜線）牢固地連接到路由器背後的黃色網際網路連接埠，以及數據機的適當連接埠上。數據機的埠通常標記為乙太網埠。

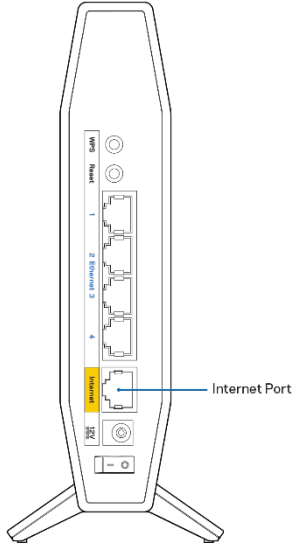

- 請確保您的數據機接上電源並處於開啟狀態。

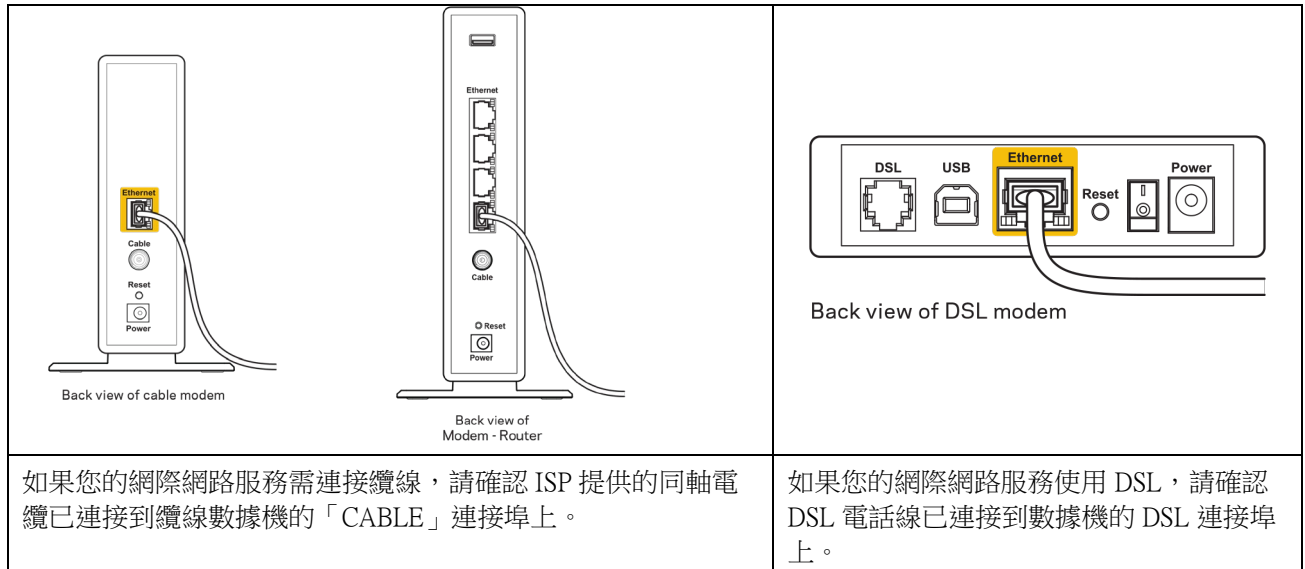

如果您的網際網路服務需連接纜線，請確認 ISP 提供的同軸電纜已連接到纜線數據機的「CABLE」連接埠上。

如果您的網際網路服務使用 DSL，請確認 DSL 電話線已連接到數據機的 DSL 連接埠上。

- 如果您的電腦之前使用 USB 纜線連接至數據機，請中斷該 USB 纜線的連線。
- 重新安裝路由器。

無法存取您的路由器訊息

如需存取您的路由器，您必須連接到您自己的網路。如果您目前使用無線網際網路存取，您可能意外連接到其他無線網路，因而發生此問題。

若要在 Windows 電腦上解決此問題，請您進行下列步驟*：

1. 請在您的 Windows 桌面上按一下系統託盤中的無線圖示。隨即會顯示可用的網路清單。
2. 按一下您自己的網路名稱。點選「連線」。在下文所示的範例中，該電腦已連線到另一個名為「wraith_5GHz」的無線網路。本範例顯示我們選擇了名為「Damaged_Beez2.4」的 Linksys E 系列路由器無線網路。



3. 如果您收到輸入網路安全金鑰的提示，請將您的密碼 (安全金鑰) 輸入到網路安全金鑰對話方塊中。然後按一下「OK (確定)」。
4. 您的電腦會連線至網路，現在您應可存取路由器。

*視您的 Windows 版本而定，這些步驟的文字或圖示可能會有些許不同。

若要在 Mac 電腦上解決此問題，請您進行下列步驟：

1. 在畫面上方的功能表列中按一下 Wi-Fi 圖示。出現一個無線網路清單。
2. 在下文所示的範例中，該電腦已連線到另一個名為「wraith_5GHz」的無線網路。本範例顯示我們選擇了名為「Damaged_Beez2.4」的 Linksys E 系列路由器無線網路。

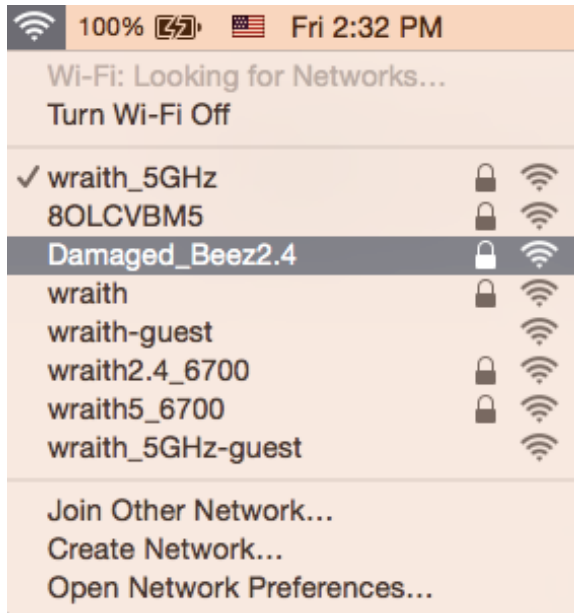

3. 按一下您的 Linksys E 系列路由器的無線網路名稱（在此範例中為「Damaged_Beez2.4」）。
4. 在「密碼」欄位中輸入您的無線網路密碼 (安全金鑰)。然後按一下「OK (確定)」。

設定後

網際網路似乎無法使用

若網際網路與您的路由器通訊發生問題，您的網路瀏覽器可能會出現類似「找不到[網際網路位址]」的訊息。若您確定該網際網路位址正確，且您嘗試了數個有效的網際網路位址但卻出現一樣的訊息，這可能表示您的 ISP 或數據機在與路由器通訊時發生問題。

請嘗試下列步驟：

- 確定網路線與電源線皆穩固連接。
- 確定路由器所插入的電源插座有通電。
- 重新啟動您的路由器。
- 聯絡您的 ISP，詢問所在區域是否有中斷情形。

最常見的解決方法是關掉路由器，然後再重新開啟。此時路由器即可載入其自訂設定，而其他裝置（例如數據機）將能重新探索路由器並與其通訊。這個程序稱為重開機。

若要使用電源線將路由器重新啟動，請您進行下列步驟：

1. 中斷路由器和數據機的電源線連線。
2. 等待10秒鐘，然後將電源線重新連接到數據機上。確保通電正常。
3. 等待直到數據機的線上指示燈停止閃爍 (約兩分鐘)。重新連接路由器的電源線。
4. 稍候直到重新開機按鈕與電源連接埠之間的綠色 LED 燈變成長亮。請先等待兩分鐘，再嘗試從電腦連接至網際網路。

規格

Linksys E 5600

型號名稱	AC1200 雙頻 WiFi 5 路由器
型號編號	E5600
交換器連接埠速度	10/100/1000 Mbps (高速乙太網)
無線電頻率	2.4 GHz 與 5 GHz
天線數	4 內部
連接埠	乙太網路 (1-4)、網際網路、電源
按鈕	Wi-Fi 保護設置, 重設, 電源開關
LEDs	電源, 網路, 乙太網 (1-4)
UPnP	支援
安全性功能	WPA2 個人版
安全金鑰位元	高達 128 位元加密

環境規格

尺寸	135mm (長) x 38mm (寬) x 185.5mm (高)
產品重量	410 克 (0.9 磅)
電源	12V、1A
認證	FCC、IC、CE、Wi-Fi (IEEE 802.11 a/b/g/n/ac)
操作溫度	32 至 104°F (0 至 40°C)
儲存溫度	-4 至 140°F (-20 至 60°C)
操作溼度	10% 至 80% 相對濕度, 非冷凝
儲存溼度	5% 至 90%, 非冷凝

備註：

有關規定、保修和安全性資訊，請參閱路由器隨附的 CD 或造訪 Linksys.com/support/E5600。

如規格發生變化，恕不另行通知。

最佳性能源自 IEEE 標準 802.11 規範。實際性能可能有所不同，包含較低無線網路容量、資料輸送率、範圍與涵蓋面。性能取決於許多因素、條件與變數，包括與存取點之間的距離、網路流量、建築材料與結構、使用作業系統、使用多種無線產品、介面與其他負面影響。

BELKIN、LINKSYS 以及許多產品名稱和標誌均屬於 Belkin 公司集團的商標。所提及的協力廠商商標均歸其各自的所有者所有。您可以在下列位置檢視用於本產品的協力廠商軟體授權與注意事項：

<http://support.linksys.com/en-us/license>。請聯繫 <http://support.linksys.com/en-us/gplcodecenter> 以提出疑問或 GPL 源代碼請求。

© 2020 Belkin International, Inc. 及/或其附屬機構。版權所有。

LINKSYS

คู่มือผู้ใช้

**เราเตอร์ AC1200
DUAL-BAND WiFi 5**

รุ่น E5600

สารบัญ

ภาพรวมผลิตภัณฑ์	3
ด้านหน้า	3
กลับ	4
การตั้งค่า: ข้อมูลเบื้องต้น	5
มีวิธีใช้เพิ่มเติมที่ใด	5
วิธีการติดตั้งเราเตอร์ของคุณ	5
การตั้งค่าขั้นสูง	7
วิธีการเปิดยูทิลิตีบนเบราเซอร์	7
การตั้งค่าเราเตอร์พื้นฐาน	8
Language (ภาษา)	8
Internet Setup (การตั้งค่าอินเทอร์เน็ต)	9
Basic Wireless Settings (การตั้งค่าเครือข่ายไร้สายขั้นพื้นฐาน)	10
การรักษาความปลอดภัยแบบไร้สาย	12
การตั้งค่าตัวเลือกการรักษาความปลอดภัย	12
WPA2 Personal	12
Disabled (ปิดใช้งาน)	12
การแก้ไขปัญหา	13
การตั้งค่าเราเตอร์ของคุณไม่เสร็จสมบูรณ์	13
ข้อความ <i>Your Internet cable is not plugged in</i> (คุณยังไม่ได้เสียบสายเคเบิลอินเทอร์เน็ต)	14
ข้อความ <i>Cannot access your router</i> (ไม่สามารถเข้าถึงเราเตอร์ของคุณได้)	15
หลังการตั้งค่า	16
ปรากฏว่าอินเทอร์เน็ตไม่สามารถใช้งานได้	16
คุณสมบัติเฉพาะ	17
Linksys E5600	17
คุณสมบัติภายนอก	17

ภาพรวมผลิตภัณฑ์

ด้านหน้า

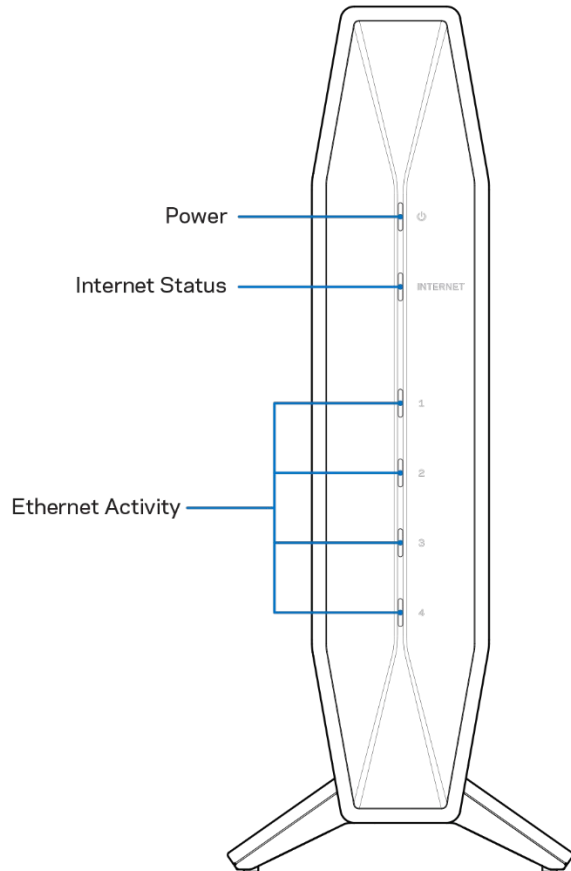

ไฟเปิด/ปิด—กะพริบเป็นสีน้ำเงินในขณะที่เราเตอร์เริ่มต้นและระหว่างการจับคู่ WPS และจะกะพริบเป็นสีเหลืองหากการจับคู่ WPS ล้มเหลว

ไฟสถานะอินเทอร์เน็ต—เป็นสีน้ำเงินนิ่งเมื่อเชื่อมต่อกับอินเทอร์เน็ตและสีเหลืองนิ่งเมื่อไม่ได้เชื่อมต่อ

ไฟกิจกรรมอีเทอร์เน็ต—ไฟแต่ละดวงจะเป็นสีน้ำเงินนิ่งถ้าสายอีเทอร์เน็ตเชื่อมต่อกับพอร์ตที่เกี่ยวข้อง

ไฟจะกะพริบเป็นสีน้ำเงินหากมีกิจกรรมเกิดขึ้นในพอร์ต

กลับ

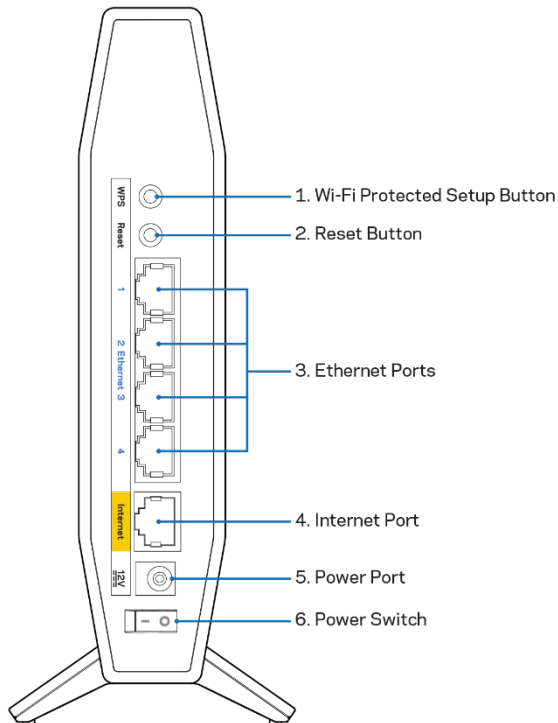

ปุ่ม Wi-Fi Protected Setup™ (WPS) (1)—กดปุ่มเพื่อกำหนดค่าการรักษาความปลอดภัยแบบไร้สายได้อย่างง่ายดายบนอุปกรณ์เครือข่ายที่เปิดใช้งาน Wi-Fi Protected Setup ไฟใต้ปุ่มจะกะพริบระหว่างที่การจับคู่ WPS เปิดใช้งาน

ปุ่มรีเซ็ต (2)—กดปุ่มนี้ค้างไว้จนกว่าไฟ LED เปิด/ปิดจะเริ่มกะพริบ เพื่อรีเซ็ตเราเตอร์ให้เป็นค่าจากโรงงาน

พอร์ตอีเทอร์เน็ต (3)—เชื่อมต่อสายเคเบิลอีเทอร์เน็ต (หรือที่เรียกว่า สายเคเบิลเครือข่ายหรือสายเคเบิลอินเทอร์เน็ต) ไปยังพอร์ต Fast Ethernet (10/100/1000) และอุปกรณ์เชื่อมต่อผ่านสายเคเบิลอื่นๆ บนเครือข่ายของคุณ ไฟใต้พอร์ตจะติดสว่างเฉพาะเมื่อสายเคเบิลอีเทอร์เน็ตเสียบอยู่และมีการรับส่งข้อมูลบนสายเคเบิลเท่านั้น

พอร์ตอินเทอร์เน็ต (4)—เชื่อมต่อสายเคเบิลอีเทอร์เน็ตเข้ากับพอร์ตนี้และกับโมเด็มของคุณ ไฟใต้พอร์ตจะติดสว่างเฉพาะเมื่อสายเคเบิลอีเทอร์เน็ตเสียบอยู่และมีการรับส่งข้อมูลบนสายเคเบิลเท่านั้น

พอร์ตจ่ายไฟ (5)—เชื่อมต่ออะแดปเตอร์ AC ที่ให้มาเข้ากับพอร์ตนี้

สวิตช์เปิด/ปิด (6)—กด | (เปิด) เพื่อเปิดเราเตอร์

การตั้งค่า: ข้อมูลเบื้องต้น

วิธีใช้เพิ่มเติมที่ใด

นอกเหนือจากคู่มือผู้ใช้ฉบับนี้ คุณยังสามารถขอความช่วยเหลือได้ที่ Linksys.com/support/E5600 (เอกสาร, การดาวน์โหลด, คำถามที่ถามบ่อย, การสนับสนุนทางเทคนิค, การสนทนาสด, กระดานสนทนา)

หมายเหตุ—สามารถอ่านลิขสิทธิ์และประกาศเกี่ยวกับซอฟต์แวร์บุคคลที่สามในผลิตภัณฑ์นี้ได้ที่

<http://support.linksys.com/en-us/license> โปรดติดต่อ <http://support.linksys.com/en-us/gplcodecenter>

หากมีคำถามหรือต้องการร้องขอซอร์สโค้ด GPL

วิธีการติดตั้งเราเตอร์ของคุณ

1. หากต้องการเปลี่ยนเราเตอร์ที่มีอยู่ ให้ยกเลิกการเชื่อมต่อเราเตอร์นั้นก่อน
2. ต่อเราเตอร์เข้ากับแหล่งจ่ายไฟ ตรวจสอบให้แน่ใจว่าสวิตช์เปิด/ปิดอยู่ในตำแหน่ง | (เปิด)
3. เชื่อมต่อเราเตอร์เครื่องใหม่ของคุณเข้ากับโมเด็มหรือโมเด็มเราเตอร์

A โมเด็ม		B โมเด็มเราเตอร์
เสียบปลายด้านหนึ่งของสายเคเบิลอีเทอร์เน็ตที่เข้ามาเข้ากับพอร์ตอินเทอร์เน็ตสีเหลืองบนเราเตอร์เครื่องใหม่ของคุณ หากคุณมีโมเด็ม ให้เสียบปลายอีกด้านหนึ่งเข้ากับ พอร์ตอีเทอร์เน็ต (LAN) บนโมเด็ม	หรือ	เสียบปลายด้านหนึ่งของสายเคเบิลอีเทอร์เน็ตที่เข้ามาเข้ากับพอร์ตอินเทอร์เน็ตสีเหลืองบนเราเตอร์เครื่องใหม่ของคุณ หากคุณมีโมเด็มเราเตอร์ ให้เสียบปลายอีกด้านหนึ่งเข้าไปที่ พอร์ตใดก็ได้ที่ว่างอยู่

4. เชื่อมต่อไปยังชื่อเครือข่ายซึ่งปรากฏอยู่ในคู่มือการเริ่มต้นฉบับย่อที่มาพร้อมกับเราเตอร์ของคุณ (คุณสามารถเปลี่ยนชื่อเครือข่ายและรหัสผ่านได้ในภายหลัง)
เลือกตัวเลือกนี้เพื่อเชื่อมต่อกับเครือข่ายนี้โดยอัตโนมัติในอนาคต
หากคุณต้องการความช่วยเหลือในการเชื่อมต่อกับเครือข่ายโปรดดูเอกสารประกอบอุปกรณ์ในแผ่นซีดีที่มีให้
หมายเหตุ—คุณจะไม่สามารถใช้งานอินเทอร์เน็ตได้จนกว่าการตั้งค่าเราเตอร์จะเสร็จสมบูรณ์
5. ป้อน <http://myrouter.local> ในเว็บเบราว์เซอร์ ทำตามคำแนะนำบนหน้าจอเพื่อตั้งค่าให้เสร็จสมบูรณ์
นอกจากนี้คุณยังสามารถป้อน 192.168.1.1 ในเบราว์เซอร์เพื่อเริ่มการตั้งค่า

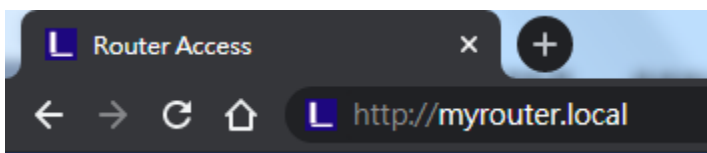

6. เมื่อตั้งค่าเสร็จแล้ว
โปรดลงทะเบียนเราเตอร์ของคุณเพื่อที่เราจะสามารถแจ้งการอัปเดตด้านความปลอดภัย
การเรียกคืนผลิตภัณฑ์และข่าวสารอื่นๆ กับคุณได้เสมอ

Register your product

Once you register we can share important security updates. Product recalls and other things that will improve your experience. All we need is your email. We will only use your email for limited security and customer support purposes.

Email Address

Linksys may also email me to keep up to date with special offers and information from linksys. You can unsubscribe at any time by using the link at the end of any email we send.[Read our Privacy Policy here.](#)

การตั้งค่าขั้นสูง

วิธีการเปิดยูทิลิตีบนเบราเซอร์

ในการเข้าถึงการตั้งค่าขั้นสูง คุณจำเป็นต้องเปิดยูทิลิตีที่ทำงานบนเบราเซอร์ ตรวจสอบให้แน่ใจว่าเชื่อมต่อเราเตอร์แล้ว จากนั้นเปิดเว็บเบราเซอร์และป้อน <http://myrouter.local> ในเว็บเบราเซอร์แล้วไปยัง 192.168.1.1

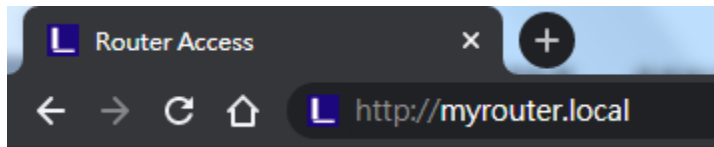

เราเตอร์จะถามชื่อผู้ใช้และรหัสผ่าน



หากคุณเปลี่ยนรหัสผ่านระหว่างการตั้งค่า ให้ป้อนรหัสผ่านใหม่ คลิก LOGIN (ล็อกอิน) หากคุณยังไม่ได้เปลี่ยนรหัสผ่านหรือข้ามการตั้งค่าทั้งหมด รหัสผ่านดีฟอลต์นั้นคือ "admin"

การตั้งค่าเราเตอร์พื้นฐาน

คุณสามารถเปลี่ยนแปลงการกำหนดค่าพื้นฐานของเราเตอร์ได้ในหน้านี้

The screenshot shows the Linksys configuration interface for the AC1200 Wi-Fi Router E5600. The 'Configuration' tab is active, and the 'Local Network' section is selected in the left sidebar. The 'Router Address' section shows the IP Address as 192.168.1.1, Subnet Mask as 255.255.255.0, and Router Name as Linksys00020. The 'DHCP Server Setting' section has the 'DHCP Server' checkbox checked, and the 'DHCP Reservation' button is highlighted. Other settings include Start IP Address (192.168.1.100), Maximum Numbers of Users (50), IP Address Range (192.168.1.100 to 149), Client Lease Time (0 minutes), and Static DNS 1, 2, and 3 (all 0.0.0.0). WINS is also set to 0.0.0.0. At the bottom, there are 'Save' and 'Cancel' buttons.

Language (ภาษา)

Select your language (เลือกภาษาของคุณ)—หากต้องการเปลี่ยนภาษา ให้เลือกภาษาจากเมนูรอปดาวน์ภาษาของผู้ทึลิตีที่ทำงานผ่านเบราว์เซอร์จะเปลี่ยนภายในห้าวินาที

The screenshot shows the Linksys configuration interface for the AC1200 Wi-Fi Router E5600. The 'Configuration' tab is active, and the 'Administration' section is selected in the left sidebar. The 'Language' section is highlighted, and the 'Select your language' dropdown menu is set to 'English'. At the bottom, there are 'Save' and 'Cancel' buttons.

Internet Setup (การตั้งค่าอินเทอร์เน็ต)

ส่วน Internet Setup (การตั้งค่าอินเทอร์เน็ต) จะตั้งค่าเราเตอร์ให้เข้ากับการเชื่อมต่อกับอินเทอร์เน็ตของคุณ ข้อมูลนี้จะได้รับผ่านผู้ให้บริการอินเทอร์เน็ต (ISP - Internet Service Provider) ของคุณ

Internet Connection Type (ประเภทการเชื่อมต่ออินเทอร์เน็ต)—เลือกประเภทการเชื่อมต่ออินเทอร์เน็ตที่ ISP ของคุณให้บริการจากเมนูด้านบน

The screenshot shows the Linksys configuration interface for an AC1200 Wi-Fi Router. The 'WAN Setup' section is active, and the 'Internet Setup' tab is selected. Under 'Internet Setup', the 'Automatic Configuration - DHCP' option is selected. Below this, there are 'Optional Settings' for Host Name, Domain Name, MTU (set to Auto), and Size (set to 1500). At the bottom of the form are 'Save' and 'Cancel' buttons.

- **Automatic Configuration – DHCP (การตั้งค่าอัตโนมัติ - DHCP) (ค่าดีฟอลต์)**
ให้รักษาค่าดีฟอลต์ไว้ต่อเมื่อ ISP ของคุณสนับสนุน DHCP เท่านั้น หรือหากคุณเชื่อมต่อโดยใช้ IP แอดเดรสแบบไดนามิก (โดยทั่วไปตัวเลือกนี้จะใช้กับการเชื่อมต่อโดยใช้สายเคเบิลเท่านั้น)
- **Static IP (IP แบบสแตติก)**
เลือกประเภทนี้หากคุณถูกกำหนดให้ใช้ IP แอดเดรสแบบถาวรเพื่อเชื่อมต่อกับอินเทอร์เน็ต
- **PPPoE**
เลือกประเภทนี้หากคุณใช้การเชื่อมต่อแบบ DSL และ ISP ของคุณใช้ Point-to-Point Protocol over Ethernet (PPPoE)
- **PPTP**
Point-to-Point Tunneling Protocol (PPTP) เป็นบริการที่ใช้กับการเชื่อมต่อทั่วไปในยุโรป หากการเชื่อมต่อ PPTP ของคุณสนับสนุน DHCP หรือ IP แอดเดรสแบบไดนามิก ให้เลือก Obtain an IP Address Automatically (รับ IP แอดเดรสโดยอัตโนมัติ) หากคุณถูกกำหนดให้ใช้ IP แอดเดรสแบบถาวรเพื่อเชื่อมต่อกับอินเทอร์เน็ต ให้เลือก Specify an IP Address (ระบุ IP แอดเดรส) และกำหนดค่าตามตัวเลือกที่ปรากฏ
- **L2TP**
Layer 2 Tunneling Protocol (L2TP) เป็นบริการที่ใช้กับการเชื่อมต่อทั่วไปในอิสราเอล
หมายเหตุ—ตัวเลือก Connect on Demand (เชื่อมต่อเมื่อต้องการ) หรือ Keep Alive (คงการเชื่อมต่อ) จะปรากฏเมื่อเลือก PPPoE, PPTP และ L2TP
ตัวเลือกเหล่านี้ช่วยให้คุณเลือกว่าจะเชื่อมต่อเราเตอร์เข้ากับอินเทอร์เน็ตตามความจำเป็นเท่านั้น (มีประโยชน์หาก ISP ของคุณคิดค่าใช้จ่ายสำหรับเชื่อมต่อตามระยะเวลา) หรือให้เราเตอร์เชื่อมต่อตลอดเวลา
เลือกตัวเลือกที่เหมาะสม
- **Bridge Mode (โหมตบริดจ์)**
โหมตบริดจ์จะปิดการทำงานของเราเตอร์และเปลี่ยนเราเตอร์ให้กลายเป็นจุดเชื่อมต่อ เราเตอร์จะหยุดการเป็นเซิร์ฟเวอร์ DHCP นอกจากนี้ไฟร์วอลล์ที่ติดตั้งมาและคุณสมบัติ NAT จะไม่ทำงาน
- **Wireless Bridge (บริดจ์ไร้สาย)**

Wireless Bridge (มิดจ์ไร้สาย)

เชื่อมต่อกับเราเตอร์หลักของคุณแบบไร้สายและสามารถแบ่งปันการเชื่อมต่ออินเทอร์เน็ตกับอุปกรณ์ที่เชื่อมต่ออยู่กับพอร์ตอีเทอร์เน็ตของมิดจ์

Basic Wireless Settings (การตั้งค่าเครือข่ายไร้สายขั้นพื้นฐาน)

The screenshot shows the Linksys configuration interface for an AC1200 Wi-Fi Router E5600. The page is titled "Basic Wireless Settings" and is divided into two sections: "5 GHz Wireless Settings" and "2.4 GHz Wireless Settings".

5 GHz Wireless Settings:

- Network Mode: Mixed(A/N/AC)
- Network Name (SSID): Linksys00012_5GHz
- Channel Width: Auto
- Channel: Auto
- SSID Broadcast:

2.4 GHz Wireless Settings:

- Network Mode: Mixed
- Network Name (SSID): Linksys00012
- Channel Width: Auto
- Channel: Auto
- SSID Broadcast:

Network Mode (โหมดเครือข่าย)—เลือกมาตรฐานเครือข่ายไร้สายที่เครือข่ายของคุณสนับสนุน

- Mixed (ผสม) (ค าดีฟอลด์)
เลือกค าดีฟอลด์ หากคุณมีอุปกรณ์ Wireless-N, Wireless-A และ Wireless-AC อยู่ ในเครือข ายของคุณ
 - Wireless-A Only (Wireless-A เท่านั้น)
เลือกโหมดนี้หากคุณมีเฉพาะอุปกรณ์ Wireless-A เท่านั้น
 - Wireless-N Only (Wireless-N เท่านั้น)
เลือกโหมดนี้หากคุณมีเฉพาะอุปกรณ์ Wireless-N เท่านั้น
 - Disabled (ปิดใช้งาน)
เลือกโหมดนี้หากคุณไม่มีอุปกรณ์ Wireless-B, Wireless-G และ Wireless-N ในเครือข่ายของคุณ
- หมายเหตุ—คุณอาจเลือก Mixed (ผสม), Wireless-N/AC Only (Wireless-N/AC เท่านั้น) หรือ Disabled (ปิดใช้งาน) สำหรับย่านความถี่ 5 GHz หากคุณไม่แน่ใจว่าควรเลือกโหมดใด ให้ใช้ ค าดีฟอลด์ Mixed (ผสม)

Network Name (SSID) (ชื่อเครือข่าย (SSID))

ตัวระบุเซตบริการ (SSID - Service Set Identifier) คือชื่อที่อุปกรณ์ใช้ในการเชื่อมต่อเครือข่ายไร้สาย SSID จะจำแนกตัวพิมพ์เล็กและตัวพิมพ์ใหญ่และจะต้องมีความยาวไม่เกิน 32 ตัวอักษร ค่าดีฟอลต์ SSID สำหรับเครือข่าย 2.4 GHz และ 5 GHz คือ LinksysXXXXX และ LinksysXXXXX_5GHz ตามลำดับ X แทนหมายเลขห้าตัวสุดท้ายในหมายเลขซีเรียลของเราเตอร์ ซึ่งจะพบได้ที่ด้านล่างของเราเตอร์ หากคุณเปลี่ยน SSID ทั้งสองย่านความถี่จะมี SSID ใหม่ คุณอาจตั้งชื่อให้แตกต่างกันผ่านยูทิลิตี้ที่ทำงานผ่านเบราว์เซอร์

หมายเหตุ—หากคุณคืนการตั้งค่าดีฟอลต์จากโรงงานให้กับเราเตอร์ของคุณ (โดยการกดปุ่มรีเซ็ตหรือใช้หน้าจอ Administration (การดูแลระบบ) > Factory Defaults (ค่าดีฟอลต์จากโรงงาน)) ชื่อเครือข่ายจะกลับไปเป็นค่าที่ตั้งจากโรงงาน เปลี่ยนชื่อเครือข่ายกลับไปเป็นชื่อเดิม หรือคุณจะต้องเชื่อมต่ออุปกรณ์ทั้งหมดในเครือข่ายไร้สายของคุณกับชื่อเครือข่ายใหม่

Channel Width (ความกว้างช่องสัญญาณ)

เลือกค่าดีฟอลต์ อัตโนมัติ (20 MHz หรือ 40 Mhz) เพื่อประสิทธิภาพสูงสุดในเครือข่าย 2.4 GHz เมื่อใช้งานอุปกรณ์ Wireless-B, Wireless-G และ Wireless-N สำหรับความกว้างช่องสัญญาณ 20 MHz ให้เลือก 20MHz เท่านั้น เพื่อประสิทธิภาพการทำงานสูงสุดในเครือข่าย 5 GHz ให้ใช้ค่าดีฟอลต์ 20, 40 หรือ 80 MHz

Channel (ช่องสัญญาณ)

เลือกช่องสัญญาณจากรายการรอปดาวน์ เลือกค่าดีฟอลต์ Auto (อัตโนมัติ) หาก你不แน่ใจว่าต้องเลือกช่องสัญญาณใด

SSID Broadcast (การเผยแพร่ SSID)

เลือกค่าดีฟอลต์ Enabled (เปิดใช้งาน) เพื่อเผยแพร่ SSID ของเราเตอร์

เมื่อไคลเอนต์ไร้สายสำรวจเครือข่ายเฉพาะที่เพื่อหาเครือข่ายไร้สายที่สัมพันธ์กัน ไคลเอนต์จะตรวจพบการเผยแพร่ SSID โดยเราเตอร์ การพยายามซ่อนชื่อ Wi-Fi ไม่ได้ช่วยให้ Wi-Fi ของคุณมีความปลอดภัยมากขึ้น

ใครก็ตามที่ต้องการเข้าถึงเครือข่ายของคุณจริงๆ จะสามารถหาเครือข่ายของคุณพบได้แม้ว่าคุณจะปิดคุณลักษณะนี้ไว้ หากคุณยังไม่ต้องการให้เผยแพร่ SSID ของเราเตอร์ให้เลือก Disabled (ปิดใช้งาน)

การรักษาความปลอดภัยแบบไร้สาย

เราเตอร์สนับสนุนตัวเลือกการรักษาความปลอดภัยแบบไร้สายต่อไปนี้:

WPA2 Personal / WPA2 Enterprise (WPA ย่อมาจาก Wi-Fi Protected Access)

ตัวเลือกการรักษาความปลอดภัย	ความเข้มงวด
WPA2 Personal	มากที่สุด

การตั้งค่าตัวเลือกการรักษาความปลอดภัย

WPA2 Personal

หากคุณเลือก WPA2 Personal อุปกรณ์แต่ละเครื่องในเครือข่ายไร้สายของคุณต้องใช้ WPA2 Personal และวสิรหัสผ่านเดียวกัน

Security Mode

WPA2 Personal

วสิรหัสผ่าน—ป้อนวสิรหัสผ่านที่มี 8-63 ตัวอักษร นี่คือวสิรหัสผ่าน Wi-Fi ที่ใช้เพื่อเข้าสู่เครือข่าย ซึ่งสามารถเป็นรหัสเดียวกับที่ป้อนในการตั้งค่า

Disabled (ปิดใช้งาน)

หากคุณเลือกปิดใช้งานการรักษาความปลอดภัยแบบไร้สาย

คุณจะได้รับข้อความแจ้งว่าการรักษาความปลอดภัยแบบไร้สายถูกปิดใช้งานเมื่อคุณเข้าใช้อินเทอร์เน็ตครั้งแรก

คุณจะได้รับตัวเลือกให้เปิดใช้งานการรักษาความปลอดภัยแบบไร้สาย

หรือยืนยันว่าคุณทราบถึงความเสี่ยงที่อาจเกิดขึ้นแต่ยังคงต้องการดำเนินการต่อโดยไม่เปิดใช้งานการรักษาความปลอดภัยแบบไร้สาย

Security Mode

Disabled

การแก้ไขปัญหา

คุณสามารถรับความช่วยเหลือเพิ่มเติมจากฝ่ายบริการลูกค้าที่ได้รับรางวัลของเราได้ที่ Linksys.com/support/E5600

การตั้งค่าเราเตอร์ของคุณไม่เสร็จสมบูรณ์

หากคุณไม่สามารถตั้งค่าให้เสร็จสมบูรณ์ในอินเทอร์เน็ตที่ทำงานผ่านเบราว์เซอร์ คุณสามารถทำตามขั้นตอนต่อไปนี้:

- กดปุ่มรีเซ็ตบนเราเตอร์ของคุณค้างไว้โดยใช้คลิปหนีบกระดาษหรือเข็มหมุดจนกว่าไฟเปิด/ปิดด้านหน้าเราเตอร์ที่สว่างอยู่จะดับลงและเริ่มกะพริบ (ประมาณ 10 วินาที) พิมพ์ 192.168.1.1 ในเบราว์เซอร์เพื่อลองตั้งค่าอีกครั้ง

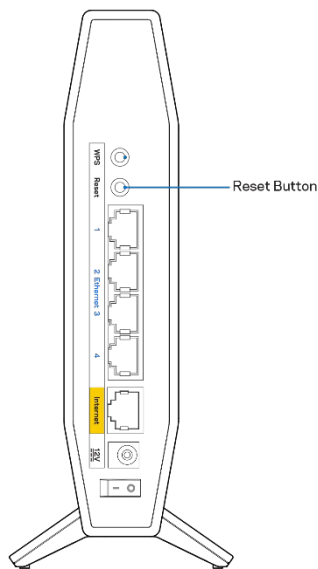

- ปิดการใช้งานไฟร์วอลล์ของคอมพิวเตอร์ของคุณชั่วคราว (ดูคำแนะนำของซอฟต์แวร์การรักษาความปลอดภัย) ติดตั้งเราเตอร์อีกครั้ง
- หากคุณมีคอมพิวเตอร์เครื่องอื่น ให้ใช้คอมพิวเตอร์นั้นเพื่อติดตั้งเราเตอร์

(หากต้องการความช่วยเหลือ

ข้อความ *Your Internet cable is not plugged in* (คุณยังไม่ได้เสียบสายเคเบิลอินเทอร์เน็ต)

หากคุณได้รับข้อความ "Your Internet cable is not plugged in" (คุณยังไม่ได้เสียบสายเคเบิลอินเทอร์เน็ต) ขณะพยายามตั้งค่าเราเตอร์ของคุณ:

- ตรวจสอบให้แน่ใจว่าสายเคเบิลอีเทอร์เน็ตหรืออินเทอร์เน็ต (หรือสายเคเบิลแบบเดียวกันที่ให้มาจากรเราเตอร์ของคุณ) เชื่อมต่อกับพอร์ตอินเทอร์เน็ตสีเหลืองที่ด้านหลังของเราเตอร์และกับพอร์ตที่เหมาะสมบนโมเด็มของคุณแน่นดีแล้ว โดยปกติพอร์ตนี้บนโมเด็มจะมีป้ายกำกับว่าอีเทอร์เน็ต

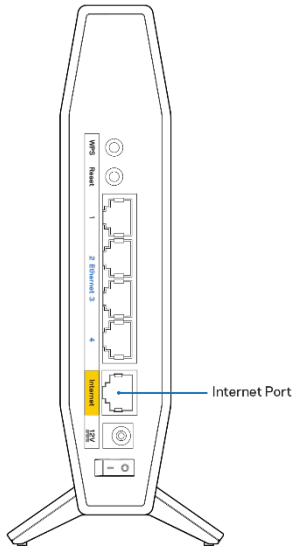

- ตรวจสอบให้แน่ใจว่าโมเด็มของคุณเชื่อมต่อกับสายไฟและเปิดเครื่องอยู่

<p>Back view of cable modem</p> <p>Back view of Modem - Router</p>	<p>Back view of DSL modem</p>
<p>หากคุณใช้บริการอินเทอร์เน็ตผ่านสายเคเบิล ตรวจสอบว่าพอร์ต CABLE ของเคเบิลโมเด็มนั้นเชื่อมต่อกับสายเคเบิล Coax ที่ ISP ของคุณจัดเตรียมให้</p>	<p>หากบริการอินเทอร์เน็ตของคุณคือ DSL ตรวจสอบให้แน่ใจว่าสายโทรศัพท์ DSL เชื่อมต่อกับพอร์ต DSL ของโมเด็ม</p>

- หากก่อนหน้านี้ คอมพิวเตอร์ของคุณเชื่อมต่อกับโมเด็มของคุณด้วยสาย USB ให้ยกเลิกการเชื่อมต่อสาย USB
- ติดตั้งเราเตอร์อีกครั้ง

ข้อความ *Cannot access your router* (ไม่สามารถเข้าถึงเราเตอร์ของคุณได้)

ในการเข้าถึงเราเตอร์ของคุณ คุณต้องเชื่อมต่อกับเครือข่ายของคุณเอง หากขณะนี้คุณมีการเข้าถึงอินเทอร์เน็ตแบบไร้สาย ปัญหาอาจเกิดขึ้นจากการที่คุณเชื่อมต่อกับเครือข่ายไร้สายอื่นโดยบังเอิญ

เมื่อต้องการแก้ปัญหาบนคอมพิวเตอร์ที่ใช้ Windows ให้ทำดังนี้*:

1. บนเดสก์ท็อปของ Windows ให้คลิกที่ไอคอนการเชื่อมต่อแบบไร้สายในถาดระบบ รายการเครือข่ายที่พร้อมใช้งานจะปรากฏขึ้น
2. คลิกชื่อเครือข่ายของคุณเอง คลิก Connect (เชื่อมต่อ) ในตัวอย่างด้านล่าง คอมพิวเตอร์จะเชื่อมต่อกับเครือข่ายไร้สายอื่นที่ชื่อว่า wraith_5GHz ชื่อเครือข่ายไร้สายของเราเตอร์ Linksys ซีรีส์ E ซึ่งในตัวอย่างนี้คือ Damaged_Beez2.4 จะแสดงว่าถูกเลือกไว้

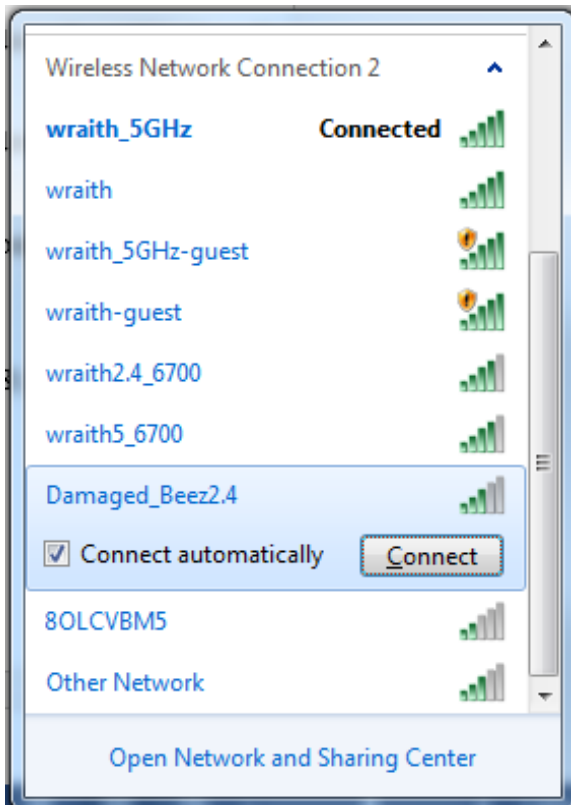

3. ถ้าคุณต้องป้อนคีย์การรักษาความปลอดภัยของเครือข่าย ให้พิมพ์รหัสผ่านของคุณ (คีย์การรักษาความปลอดภัย) ลงในฟิลด์ network security key (คีย์การรักษาความปลอดภัยของเครือข่าย) คลิก OK (ตกลง)
4. คอมพิวเตอร์ของคุณจะเชื่อมต่อกับเครือข่าย และคุณสามารถเข้าถึงเราเตอร์ได้

*อาจมีความแตกต่างบางประการในการใช้คำหรือไอคอนในขั้นตอนต่อไปนี้ ทั้งนี้ขึ้นอยู่กับรุ่นของ Windows ของคุณ

เมื่อต้องการแก้ปัญหาบนคอมพิวเตอร์ที่ใช้ Mac ให้ทำดังนี้:

1. ให้คลิกที่ไอคอน Wi-Fi ในแถบเมนูที่ด้านบนของหน้าจอ รายการเครือข่ายไร้สายจะปรากฏขึ้น
2. ในตัวอย่างด้านล่าง คอมพิวเตอร์จะเชื่อมต่อกับเครือข่ายไร้สายอื่นที่ชื่อว่า wraith_5GHz ชื่อเครือข่ายไร้สายของเราเตอร์ Linksys ซีรีส์ E ซึ่งในตัวอย่างนี้คือ Damaged_Beez2.4 จะแสดงว่าถูกเลือกไว้

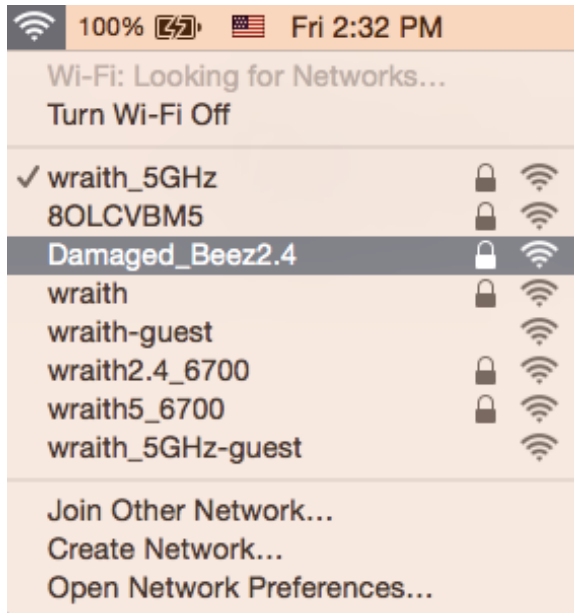

3. คลิกชื่อเครือข่ายไร้สายของเราเตอร์ Linksys ซีรีส์ E (Damaged_Beez2.4 ในตัวอย่างนี้)
4. พิมพ์รหัสผ่านเครือข่ายไร้สาย (คีย์การรักษาความปลอดภัย) ลงในฟิลด์ Password (รหัสผ่าน) คลิก OK (ตกลง)

หลังการตั้งค่า

ปรากฏว่าอินเทอร์เน็ตไม่สามารถใช้งานได้

ถ้าอินเทอร์เน็ตมีปัญหาในการสื่อสารกับเราเตอร์ของคุณ ปัญหาอาจปรากฏเป็นข้อความ "Cannot find (ไม่พบ) [ที่อยู่อินเทอร์เน็ต]" ในเว็บเบราว์เซอร์ของคุณ หากคุณทราบว่าที่อยู่อินเทอร์เน็ตนั้นถูกต้อง และถ้าคุณลองใช้ที่อยู่อินเทอร์เน็ตที่ถูกต้องแล้วได้ผลเหมือนเดิม ข้อความนั้นอาจหมายความว่าปัญหาเกิดขึ้นกับผู้ให้บริการอินเทอร์เน็ตของคุณหรือโมเด็มที่สื่อสารกับเราเตอร์ของคุณ ให้ลองทำดังนี้:

- ตรวจสอบให้แน่ใจว่าได้เสียบสายเคเบิลเครือข่ายและสายไฟแนตต์แล้ว
- ตรวจสอบให้แน่ใจว่าเต้ารับที่เราเตอร์ของคุณเสียบอยู่มีไฟ
- รีบูตเราเตอร์ของคุณ
- ติดต่อ ISP ของคุณและสอบถามเกี่ยวกับปัญหาการใช้งานไม่ได้ในพื้นที่ของคุณ

วิธีการที่ใช้กันโดยทั่วไปเมื่อต้องการแก้ปัญหาเราเตอร์ของคุณคือ การปิดและเปิดใหม่อีกครั้ง เราเตอร์ของคุณสามารถโหลดการตั้งค่าที่กำหนดเองอีกครั้ง และอุปกรณ์อื่นๆ (เช่น โมเด็ม) จะสามารถค้นพบเราเตอร์และสื่อสารกันได้ กระบวนการนี้เรียกว่าการรีบูต

เมื่อต้องการรีเซ็ตเราเตอร์ของคุณโดยใช้สายไฟ ให้ทำดังนี้:

1. ถอดสายไฟออกจากเราเตอร์และโมเด็ม
2. รอประมาณ 10 วินาที แล้วต่อสายไฟเข้ากับโมเด็ม ตรวจสอบให้แน่ใจว่ามีไฟ
3. รอจนกว่าไฟแสดงสถานะการออนไลน์ของโมเด็มจะหยุดกะพริบ (ประมาณสองนาทีก่อน) เชื่อมต่อสายไฟเข้ากับเราเตอร์อีกครั้ง
4. รอจนกว่าไฟ LED กะพริบสีเขียวระหว่างปุ่มรีเซ็ตและพอร์ตจ่ายไฟจะหยุดนิ่ง รอประมาณสองนาทีก่อนพยายามเชื่อมต่อกับอินเทอร์เน็ตจากคอมพิวเตอร์

คุณสมบัติเฉพาะ

Linksys E5600

ชื่อรุ่น	เราเตอร์ AC1200 Dual-Band WiFi 5
หมายเลขรุ่น	E5600
ความเร็วพอร์ตสวิตช์	10/100/1000 Mbps (Fast Ethernet)
คลื่นวิทยุความถี่	2.4 GHz และ 5 GHz
จำนวนของเสาอากาศ	4 ภายใน
พอร์ต	อีเธอร์เน็ต (1-4), อินเทอร์เน็ต, จ่ายไฟ
ปุ่ม	Wi-Fi Protected Setup, รีเซ็ต, สวิตช์เปิด/ปิด
ไฟ LED	จ่ายไฟ, อินเทอร์เน็ต และอีเธอร์เน็ต (1-4)
UPnP	สนับสนุน
คุณสมบัติในการรักษาความปลอดภัย	WPA2 Personal
จำนวนบิตของคีย์การรักษาความปลอดภัย	เข้ารหัสข้อมูลที่ระดับสูงถึง 128 บิต

คุณสมบัติภายนอก

ขนาด	135 มม. (ยาว) x 38 มม. (กว้าง) x 185.5 มม. (สูง)
น้ำหนักเครื่อง	410 กรัม (0.9 ปอนด์)
ไฟแสดงสถานะ	12V, 1A
การรับรองมาตรฐาน	FCC, IC, CE, Wi-Fi (IEEE 802.11 a/b/g/n/ac)
อุณหภูมิในการใช้งาน	32 ถึง 104°F (0 ถึง 40°C)
อุณหภูมิในการจัดเก็บ	-4 ถึง 140°F (-20 ถึง 60°C)
ความชื้นที่เหมาะสมในการใช้งาน	ความชื้นสัมพัทธ์ 10% ถึง 80% ไม่มีการควบแน่น
ความชื้นที่เหมาะสมในการจัดเก็บ	5% ถึง 90% ไม่มีการควบแน่น

หมายเหตุ:

สำหรับข้อบังคับ การรับประกัน และข้อมูลความปลอดภัย โปรดดูในแผ่นซีดีที่มาพร้อมกับเราเตอร์ของคุณ หรือไปที่ Linksys.com/support/E5600

คุณสมบัติเฉพาะอาจเปลี่ยนแปลงได้โดยไม่ต้องแจ้งให้ทราบล่วงหน้า

ประสิทธิภาพสูงสุดตามมาตรฐาน IEEE Standard 802.11 ประสิทธิภาพการทำงานจริงอาจแตกต่างกันไป เช่น การรองรับการใช้งานเครือข่ายไร้สาย อัตราการรับส่งข้อมูล ระยะและการครอบคลุมการใช้งานอาจต่ำกว่าที่ระบุไว้ ประสิทธิภาพการทำงานจะขึ้นอยู่กับหลายปัจจัย สภาพแวดล้อมการทำงาน และตัวแปรอื่นๆ รวมถึงระยะห่างจากจุดเชื่อมต่อ ปริมาณการรับส่งข้อมูลเครือข่าย โครงสร้างและส่วนประกอบของอาคาร ระบบปฏิบัติการที่ใช้ การใช้ผลิตภัณฑ์ไร้สายจากผู้ผลิตหลายราย สัญญาณรบกวน และสภาพแวดล้อมอื่นๆ ที่อาจส่งผลกระทบต่อการทำงาน

BELKIN, LINKSYS รวมถึงชื่อและโลโก้ของผลิตภัณฑ์ต่างๆ เป็นเครื่องหมายการค้าของบริษัทในเครือ Belkin เครื่องหมายการค้าของบุคคลที่สามที่ระบุไว้เป็นกรรมสิทธิ์ของผู้เป็นเจ้าของแต่ละราย

สามารถอ่านลิขสิทธิ์และประกาศเกี่ยวกับซอฟต์แวร์ของบุคคลที่สามในผลิตภัณฑ์นี้ได้ที่นี่:

<http://support.linksys.com/en-us/license> โปรดติดต่อ <http://support.linksys.com/en-us/gplcodecenter>

หากมีคำถามหรือต้องการร้องขอซอร์สโค้ด GPL

© 2020 Belkin International, Inc. และ/หรือบริษัทในเครือ สงวนลิขสิทธิ์

LINKSYS

HƯỚNG DẪN SỬ DỤNG

**BỘ ĐỊNH TUYẾN WIFI 5
BẢNG TẦN KÉP AC1200**

Mã sản phẩm E5600

Mục lục

Tổng quan Sản phẩm	3
Mặt trước	3
Quay lại	4
Thiết lập: Cơ bản	5
Tìm trợ giúp thêm ở đâu	5
Cách cài đặt bộ định tuyến	5
Cấu hình Nâng cao	7
Cách mở tiện ích trên trình duyệt	7
Cài đặt bộ định tuyến cơ bản	8
Ngôn ngữ	8
Thiết lập Internet	9
Cài đặt không dây cơ bản	10
Bảo mật không dây	12
Cài đặt tùy chọn bảo mật	12
WPA2 Cá nhân	12
Tắt	12
Xử lý sự cố	13
Bộ định tuyến của bạn chưa được thiết lập thành công	13
Thông báo Chưa cấm cáp Internet	14
Thông báo Không thể truy nhập bộ định tuyến	14
Sau khi thiết lập	16
Mạng Internet không khả dụng	16
Thông số kỹ thuật	17
Linksys E5600	17
Môi trường	17

Tổng quan Sản phẩm

Mặt trước

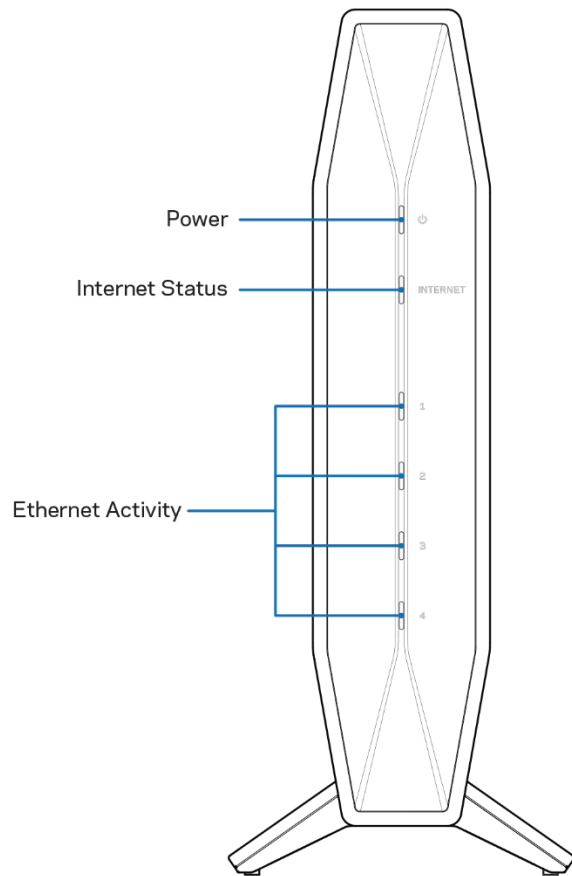

Đèn Nguồn—Nhấp nháy màu xanh lam trong khi bộ định tuyến đang khởi động và trong khi đang ghép đôi WPS. Nhấp nháy màu vàng nếu ghép đôi WPS không thành công.

Đèn trạng thái Internet—Sáng ổn định màu xanh lam khi được kết nối với Internet và sáng ổn định màu vàng khi không kết nối.

Đèn báo hoạt động Ethernet—Từng đèn sẽ sáng ổn định màu xanh lam nếu cáp Ethernet được kết nối với cổng tương ứng. Chúng sẽ nhấp nháy màu xanh lam nếu có hoạt động trên cổng.

Quay lại

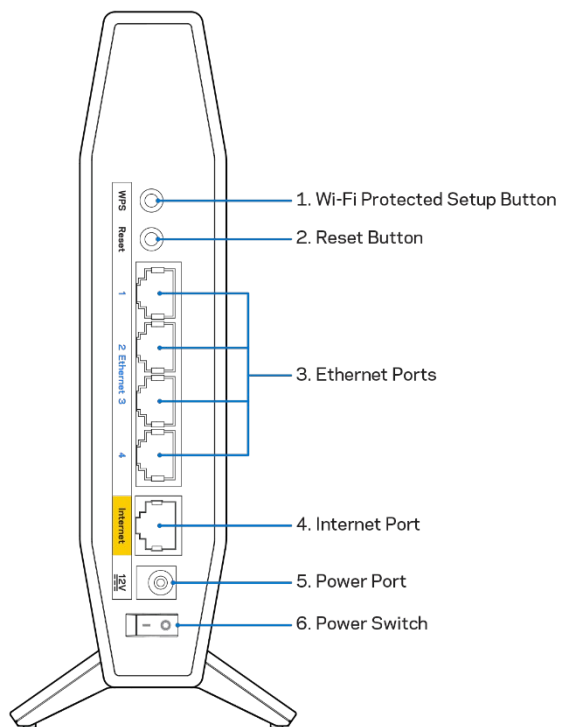

Nút Wi-Fi Protected Setup™ (WPS) (1)—Ấn nút này để dễ dàng cấu hình bảo mật không dây trên các thiết bị mạng có hỗ trợ Wi-Fi Protected Setup. Đèn dưới nút sẽ nhấp nháy trong khi đang ghép đôi WPS.

Nút Reset (Đặt lại) (2)—Ấn và giữ cho đến khi đèn LED nguồn bắt đầu nhấp nháy để đặt lại bộ định tuyến về cài đặt gốc.

Cổng Ethernet (3)—Kết nối cáp Ethernet (cũng có tên là cáp mạng hoặc cáp Internet) với cổng Ethernet Nhanh (10/100/1000) và với các thiết bị nối dây khác trong mạng của bạn. Đèn dưới các cổng sẽ sáng chỉ khi cáp Ethernet được cắm vào và có lưu lượng dữ liệu chạy qua cáp.

Cổng Internet (4)—Kết nối cáp Ethernet với cổng này và với modem của bạn. Đèn dưới cổng sẽ sáng chỉ khi cáp Ethernet được cắm vào và có lưu lượng dữ liệu chạy qua cáp.

Cổng nguồn (5)—Kết nối bộ chuyển đổi nguồn điện AC kèm theo với cổng này.

Công tắc nguồn (6) —Ấn | (ON) bật nguồn bộ định tuyến.

Thiết lập: Cơ bản

Tìm trợ giúp thêm ở đâu

Ngoài hướng dẫn sử dụng này, bạn có thể tìm trợ giúp tại Linksys.com/support/E5600 (tài liệu, nội dung tải xuống, câu hỏi thường gặp, hỗ trợ kỹ thuật, trò chuyện trực tiếp, diễn đàn)

Lưu ý—Các giấy phép và thông báo cho các phần mềm của bên thứ ba được sử dụng trong sản phẩm này có thể xem tại <http://support.linksys.com/en-us/license>. Vui lòng liên hệ <http://support.linksys.com/en-us/gplcodecenter> nếu có câu hỏi hoặc yêu cầu mã nguồn GPL.

Cách cài đặt bộ định tuyến

1. Nếu thay thế một bộ định tuyến sẵn có, trước tiên hãy ngắt kết nối bộ định tuyến cũ.
2. Cắm bộ định tuyến vào nguồn điện. Hãy chắc chắn rằng công tắc nguồn đã ở vị trí | (ON).
3. Kết nối bộ định tuyến mới với modem hoặc bộ định tuyến modem của bạn.

A Modem		B Bộ định tuyến Modem
Cắm một đầu của cáp Ethernet đi kèm vào cổng Internet màu vàng trên bộ định tuyến mới của bạn. Nếu bạn có modem, hãy cắm đầu còn lại vào cổng Ethernet (LAN) trên modem.	HOẶC	Cắm một đầu của cáp Ethernet đi kèm vào cổng Internet màu vàng trên bộ định tuyến mới của bạn. Nếu bạn có bộ định tuyến modem, hãy cắm đầu cáp còn lại vào bất kỳ cổng nào còn trống .

4. Kết nối với tên mạng ghi trong Hướng dẫn Sử dụng Nhanh đi kèm cùng bộ định tuyến. (Bạn có thể đổi tên mạng và mật khẩu sau.) Chọn tùy chọn tự động kết nối tới mạng này trong tương lai. Nếu bạn cần trợ giúp kết nối mạng, hãy tham khảo tài liệu thiết bị của bạn trong CD được cung cấp.
Lưu ý—Bạn sẽ không thể truy nhập Internet cho đến khi hoàn tất quá trình thiết lập bộ định tuyến.
5. Nhập <http://myrouter.local> vào một trình duyệt web. Làm theo hướng dẫn trên màn hình để hoàn tất thiết lập. Bạn cũng có thể nhập 192.168.1.1 vào trình duyệt để bắt đầu thiết lập.

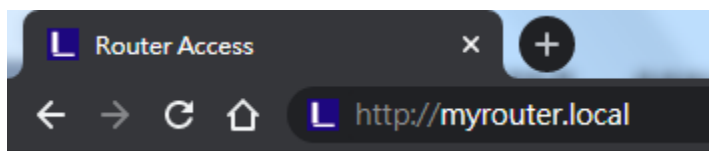

6. Khi bạn đã hoàn tất thiết lập, hãy nhớ đăng ký bộ định tuyến để chúng tôi có thể thông báo cho bạn các cập nhật bảo mật, thu hồi sản phẩm và các thông tin khác giúp nâng cao trải nghiệm.

Register your product

Once you register we can share important security updates. Product recalls and other things that will improve your experience. All we need is your email. We will only use your email for limited security and customer support purposes.

Email Address

Linksys may also email me to keep up to date with special offers and information from linksys. You can unsubscribe at any time by using the link at the end of any email we send.[Read our Privacy Policy here.](#)

[Next](#) [Skip](#)

Cấu hình Nâng cao

Cách mở tiện ích trên trình duyệt

Để truy cập một số cài đặt nâng cao, bạn cần phải mở tiện ích trên trình duyệt. Hãy chắc chắn rằng bạn đã được kết nối với bộ định tuyến, mở một trình duyệt web và nhập <http://myrouter.local> vào trình duyệt web đó, hoặc truy cập 192.168.1.1.

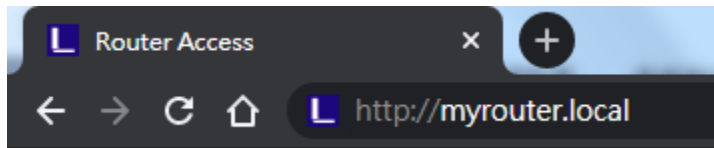

Bộ định tuyến sẽ nhắc bạn nhập mật khẩu.

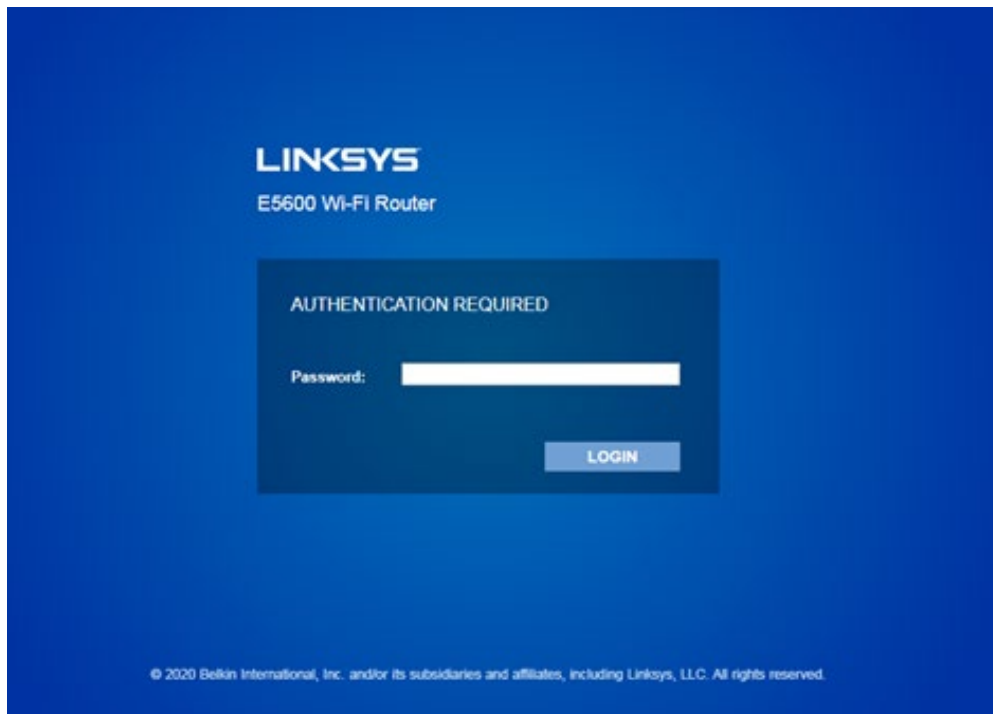

Nếu bạn đã thay đổi mật khẩu trong quá trình thiết lập, hãy nhập mật khẩu mới. Bấm **ĐĂNG NHẬP**. Nếu bạn không thay đổi mật khẩu, hoặc đã bỏ qua phần thiết lập thì mật khẩu mặc định là "admin".

Cài đặt bộ định tuyến cơ bản

Màn hình này cho phép bạn thay đổi cấu hình cơ bản của bộ định tuyến.

The screenshot shows the Linksys configuration interface for the AC1200 Wi-Fi Router (E5600). The page is titled "Local Network" and is part of the "Configuration" section. The left sidebar shows a navigation menu with "Connectivity" expanded, and "Local Network" selected. The main content area is divided into two sections: "Router Address" and "DHCP Server Setting".

Router Address

- IP Address: 192 . 168 . 1 . 1
- Subnet Mask: 255.255.255.0
- Router Name: Linksys00020

DHCP Server Setting

- DHCP Server
- DHCP Reservation**
- Start IP Address: 192 . 168 . 1 . 100
- Maximum Numbers of Users: 50
- IP Address Range: 192 . 168 . 1 . 100 to 149
- Client Lease Time: 0 minutes (0 means one day)
- Static DNS 1: 0 . 0 . 0 . 0
- Static DNS 2: 0 . 0 . 0 . 0
- Static DNS 3: 0 . 0 . 0 . 0
- WINS: 0 . 0 . 0 . 0

At the bottom of the form, there are "Save" and "Cancel" buttons.

Ngôn ngữ

Chọn ngôn ngữ của bạn—Để thay đổi ngôn ngữ, hãy chọn một ngôn ngữ khác từ menu thả xuống. Ngôn ngữ của tiện ích trên trình duyệt sẽ thay đổi trong vòng năm giây.

The screenshot shows the Linksys configuration interface for the AC1200 Wi-Fi Router (E5600). The page is titled "Language" and is part of the "Configuration" section. The left sidebar shows a navigation menu with "Administration" expanded, and "Language" selected. The main content area is simple, with a "Select your language" dropdown menu set to "English".

Language

- Select your language: English

At the bottom of the form, there are "Save" and "Cancel" buttons.

Thiết lập Internet

Phần Thiết lập Internet giúp đặt cấu hình bộ định tuyến với kết nối Internet của bạn. Thông tin này được cung cấp qua Nhà cung cấp dịch vụ Internet (ISP) của bạn.

Loại kết nối Internet—Chọn loại kết nối Internet mà ISP của bạn cung cấp từ menu thả xuống.

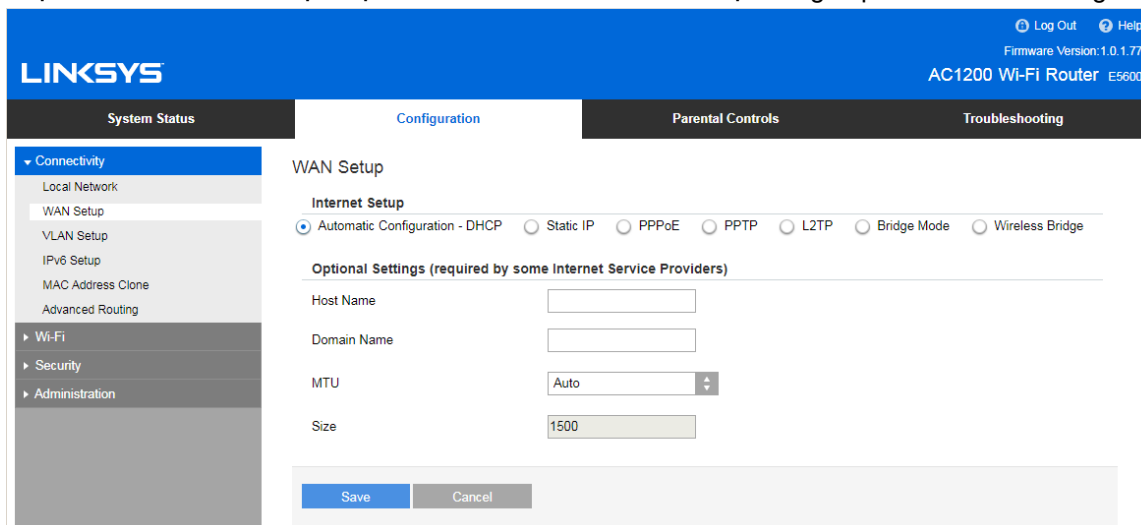

The screenshot shows the Linksys configuration interface for WAN Setup. The 'Internet Setup' section has 'Automatic Configuration - DHCP' selected. The 'Optional Settings' section includes fields for Host Name, Domain Name, MTU (set to Auto), and Size (set to 1500). There are 'Save' and 'Cancel' buttons at the bottom.

- **Cấu hình tự động – DHCP (mặc định)**
Chỉ giữ cấu hình mặc định nếu ISP hỗ trợ DHCP hoặc nếu bạn kết nối bằng địa chỉ IP động. (Tuỳ chọn này thường áp dụng cho kết nối cáp).
- **IP tĩnh**
Hãy lựa chọn nếu bạn phải sử dụng địa chỉ IP cố định để kết nối Internet.
- **PPPoE**
Hãy lựa chọn nếu bạn có kết nối DSL và ISP của bạn sử dụng Giao thức điểm nối điểm qua Ethernet (PPPoE).
- **PPTP**
Giao thức Tạo Đường hầm Điểm nối Điểm (PPTP) là dịch vụ thường áp dụng cho kết nối ở Châu Âu. Nếu kết nối PPTP của bạn hỗ trợ DHCP hoặc địa chỉ IP động, hãy chọn Tự động nhận địa chỉ IP. Nếu bạn phải sử dụng địa chỉ IP cố định để kết nối Internet, hãy chọn Chỉ định địa chỉ IP và đặt cấu hình cho các tùy chọn xuất hiện.
- **L2TP**
Giao thức Tạo Đường hầm Lớp 2 (L2TP) là dịch vụ thường áp dụng cho kết nối ở Israel.
Lưu ý—Kết nối theo yêu cầu và Duy trì kết nối là các tùy chọn khi lựa chọn PPPoE, PPTP và L2TP. Chúng cho phép bạn chọn bộ định tuyến chỉ kết nối Internet khi cần (hữu ích nếu ISP của bạn tính phí theo thời gian kết nối) hoặc bộ định tuyến phải luôn được kết nối. Hãy chọn tùy chọn phù hợp.
- **Chế độ cầu nối**
Chế độ cầu nối sẽ tắt tất cả các chức năng bộ định tuyến và biến bộ định tuyến này thành một điểm truy nhập. Bộ định tuyến sẽ không còn hoạt động như một máy chủ DHCP, tường lửa tích hợp và các tính năng NAT cũng không còn hiệu lực.
- **Cầu nối không dây**
Cầu nối không dây sẽ kết nối không dây với bộ định tuyến chính của bạn và có thể chia sẻ kết nối Internet với các thiết bị đã kết nối với cổng Ethernet của cầu nối.

Cài đặt không dây cơ bản

The screenshot shows the Linksys web interface for an AC1200 Wi-Fi Router. The top navigation bar includes 'System Status', 'Configuration', 'Parental Controls', and 'Troubleshooting'. The 'Configuration' section is active, and the 'Wi-Fi' menu item is selected. The 'Basic Wireless Settings' page is displayed, showing settings for both 5 GHz and 2.4 GHz wireless networks. The 5 GHz settings include Network Mode (Mixed/A/N/AC), Network Name (Linksys00012_5GHz), Channel Width (Auto), Channel (Auto), and SSID Broadcast (checked). The 2.4 GHz settings include Network Mode (Mixed), Network Name (Linksys00012), Channel Width (Auto), Channel (Auto), and SSID Broadcast (checked).

Chế độ mạng—Chọn các chuẩn không dây mà mạng của bạn sẽ hỗ trợ.

- Hỗn hợp (mặc định)
Giữ nguyên mặc định nếu bạn có các thiết bị Không dây-N, Không dây-A và Không dây-AC trong mạng.
 - Chỉ Không dây-A
Hãy lựa chọn nếu bạn chỉ có các thiết bị Không dây-A.
 - Chỉ Không dây-N
Hãy lựa chọn nếu bạn chỉ có các thiết bị Không dây-N.
 - Tắt
Hãy lựa chọn nếu bạn không có các thiết bị Không dây-B, Không dây-G và Không dây-N trong mạng.
- Lưu ý—Bạn có thể chọn Hỗn hợp, Chỉ Không dây-N/AC hoặc Tắt cho băng tần 5 GHz. Nếu bạn không rõ nên chọn chế độ nào, hãy giữ cài đặt mặc định, Hỗn hợp.

Tên mạng (SSID)

Bộ Định danh Thiết đặt Dịch vụ (SSID) là tên được sử dụng bởi các thiết bị để kết nối với một mạng không dây. SSID có phân biệt chữ hoa/chữ thường và không được dài quá 32 ký tự. SSID mặc định cho mạng 2.4 GHz và 5 GHz lần lượt là LinksysXXXXX và LinksysXXXXX_5GHz. Các chữ X chính là năm số cuối trong dãy số sê-ri của bộ định tuyến, dãy số này có thể tìm thấy ở dưới đáy bộ định tuyến. Nếu bạn đã thay đổi SSID, cả hai băng tần đều có SSID mới. Bạn có thể đặt tên khác cho chúng qua tiện ích trên trình duyệt.

Lưu ý—Nếu bạn khôi phục cài đặt gốc của bộ định tuyến (bằng cách ấn nút Reset (Đặt lại) hoặc sử dụng màn hình Quản trị > Cài đặt gốc), Tên mạng sẽ trở về giá trị mặc định. Hãy thay đổi Tên mạng về lại tên gốc hoặc bạn sẽ phải kết nối lại tất cả thiết bị trong mạng không dây của bạn theo tên mạng mới.

Độ rộng kênh

Giữ nguyên mặc định, Tự động (20 MHz hoặc 40 MHz), để có hiệu suất tốt nhất trong mạng 2.4 GHz sử dụng các thiết bị Không dây-B, Không dây-G và Không dây-N. Với độ rộng kênh là 20 MHz, hãy chọn Chỉ 20 MHz. Để đạt hiệu suất tốt nhất trong mạng 5 GHz, hãy giữ giá trị mặc định 20, 40 hoặc 80 MHz.

Kênh

Hãy chọn kênh từ danh sách thả xuống. Giữ nguyên mặc định, Tự động, nếu bạn không rõ nên chọn kênh nào.

Phát rộng SSID

Giữ nguyên mặc định, Bật, để phát rộng SSID của bộ định tuyến. Khi các thiết bị khách không dây khảo sát khu vực lân cận để tìm các mạng không dây và kết nối, chúng sẽ tìm thấy tên SSID được phát rộng bởi bộ định tuyến. Cố gắng ẩn tên Wi-Fi không thể giúp mạng Wi-Fi của bạn trở nên an toàn hơn. Bất kỳ người nào thực sự muốn truy nhập mạng của bạn sẽ đều có thể tìm ra nó, ngay cả khi bạn đã tắt tính năng này. Nếu bạn vẫn không muốn phát rộng SSID của bộ định tuyến, chọn Tắt.

Bảo mật không dây

Bộ định tuyến cung cấp các tùy chọn bảo mật không dây sau:

WPA2 Cá nhân (WPA là viết tắt của Wi-Fi Protected Access.)

Tùy chọn bảo mật	Độ mạnh
WPA2 Cá nhân	Mạnh nhất

Cài đặt tùy chọn bảo mật

WPA2 Cá nhân

Nếu bạn chọn WPA2 Cá nhân, mỗi thiết bị trong mạng không dây của bạn **PHẢI** sử dụng WPA2 Cá nhân và chuỗi mật khẩu tương tự.

Security Mode

WPA2 Personal

Chuỗi mật khẩu—Nhập chuỗi mật khẩu dài từ 8-63 ký tự. Đây là mật khẩu Wi-Fi cung cấp quyền truy nhập vào mạng. Nó có thể giống như mật khẩu đã nhập khi thiết lập.

Tắt

Nếu bạn chọn tắt bảo mật không dây, bạn sẽ được thông báo rằng bảo mật không dây đã bị tắt khi truy nhập Internet lần đầu. Bạn sẽ được tùy chọn bật bảo mật không dây hoặc xác nhận rằng bạn đã biết rõ các rủi ro nhưng vẫn muốn tiếp tục mà không cần bảo mật không dây.

Security Mode

Disabled

Xử lý sự cố

Bạn có thể tìm thêm trợ giúp từ bộ phận hỗ trợ khách hàng đã giành nhiều giải thưởng của chúng tôi tại địa chỉ Linksys.com/support/E5600.

Bộ định tuyến của bạn chưa được thiết lập thành công

Nếu bạn không thể hoàn tất thiết lập trong giao diện trên trình duyệt, bạn có thể thử các bước sau:

- Ấn và giữ nút Reset (Đặt lại) trên bộ định tuyến bằng cây kẹp giấy hoặc đinh ghim cho đến khi đèn nguồn ở phía trước của bộ định tuyến tắt và bắt đầu nhấp nháy (khoảng 10 giây). Nhập 192.168.1.1 vào trình duyệt để thử thiết lập lại.

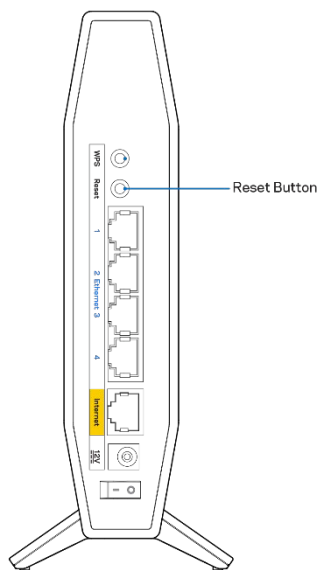

- Tạm thời tắt tường lửa trên máy tính của bạn (xem hướng dẫn của phần mềm bảo mật để được trợ giúp). Cài đặt lại bộ định tuyến.
- Nếu bạn có máy tính khác, hãy sử dụng máy tính đó để cài đặt bộ định tuyến.

Thông báo Chưa cắm cáp Internet

Nếu bạn nhận được thông báo “Chưa cắm cáp Internet” khi đang thiết lập bộ định tuyến:

- Hãy chắc chắn rằng cáp Ethernet hoặc Internet (hoặc cáp giống với loại được cung cấp cùng với bộ định tuyến) đã được cắm chắc chắn vào cổng Internet màu vàng ở mặt sau của bộ định tuyến và vào cổng thích hợp trên modem. Cổng này trên modem thường có nhãn Ethernet.

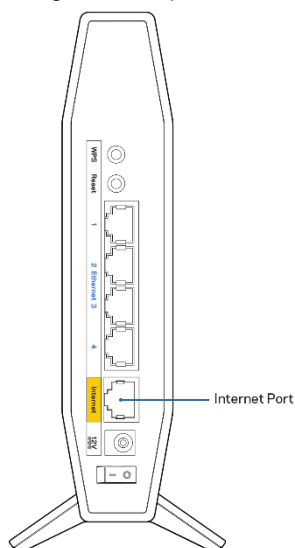

- Hãy đảm bảo rằng modem của bạn đã cắm nguồn và đã bật.

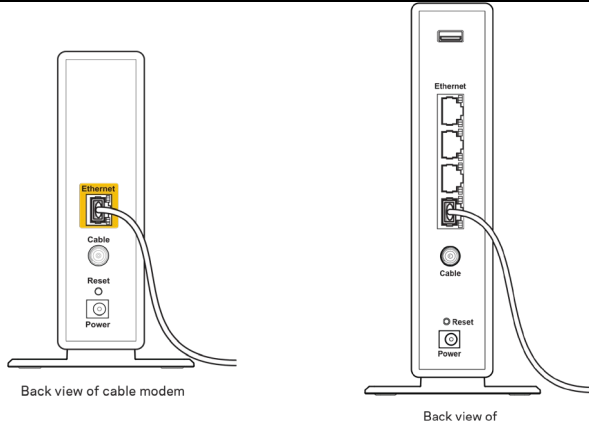
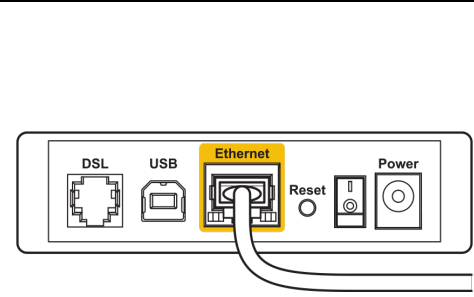
 <p>Back view of cable modem</p> <p>Back view of Modem - Router</p>	 <p>Back view of DSL modem</p>
<p>Nếu dịch vụ Internet của bạn là dịch vụ cáp, hãy kiểm tra và đảm bảo rằng cổng CABLE (CÁP) của modem cáp đã được kết nối với cáp đồng trục do ISP của bạn cung cấp.</p>	<p>Nếu dịch vụ Internet của bạn là dịch vụ DSL, hãy đảm bảo rằng đường dây điện thoại DSL đã được kết nối với của cổng DSL của modem.</p>

- Nếu trước đây, máy tính của bạn đã kết nối với modem bằng cáp USB, hãy rút cáp USB ra.
- Cài đặt lại bộ định tuyến.

Thông báo Không thể truy nhập bộ định tuyến

Để truy nhập bộ định tuyến, bạn phải kết nối với mạng của riêng bạn. Nếu bạn hiện có truy nhập Internet không dây, sự cố có thể là do bạn đã vô tình kết nối với một mạng không dây khác.

Để khắc phục sự cố trên máy tính chạy Windows, hãy làm theo các bước sau*:

1. Trên màn hình Windows, bấm vào biểu tượng không dây trên khay hệ thống. Danh sách các mạng hiện có sẽ xuất hiện.
2. Bấm vào tên mạng riêng của bạn. Bấm Connect (Kết nối). Trong ví dụ dưới đây, máy tính đã được kết nối vào một mạng không dây khác có tên wraith_5GHz. Tên mạng không dây của bộ định tuyến Linksys sê-ri E, trong ví dụ này là Damaged_Beez2.4, đã được chọn như minh họa.



3. Nếu bạn được nhắc nhập khóa bảo mật mạng, hãy nhập mật khẩu (khóa bảo mật) của bạn vào trường network security key (khóa bảo mật mạng). Bấm OK.
4. Máy tính của bạn sẽ kết nối vào mạng và bạn sẽ có thể truy nhập bộ định tuyến.

*Tùy thuộc vào phiên bản Windows của bạn mà có thể có một số sự khác nhau trong câu chữ hay các biểu tượng ở các bước này.

Để khắc phục sự cố trên máy tính Mac, hãy làm theo các bước sau:

1. Trên thanh menu ngang trên cùng màn hình, hãy bấm vào biểu tượng Wi-Fi. Danh sách các mạng không dây sẽ xuất hiện.
2. Trong ví dụ dưới đây, máy tính đã được kết nối vào một mạng không dây khác có tên wraith_5GHz. Tên mạng không dây của bộ định tuyến Linksys sê-ri E, trong ví dụ này là Damaged_Beez2.4, đã được chọn như minh họa.

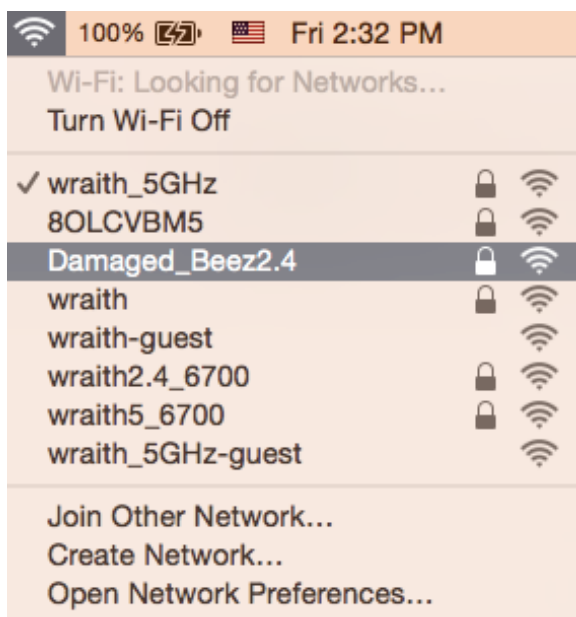

3. Bấm vào tên mạng không dây của bộ định tuyến Linksys sê-ri E của bạn (trong ví dụ này là Damaged_Beez2.4).
4. Nhập mật khẩu mạng không dây (Khoá Bảo mật) của bạn vào trường Password (Mật khẩu). Bấm OK.

Sau khi thiết lập

Mạng Internet không khả dụng

Nếu mạng Internet gặp khó khăn khi giao tiếp với bộ định tuyến của bạn thì vấn đề này có thể sẽ làm xuất hiện thông điệp “Không tìm thấy [địa chỉ Internet]” trong trình duyệt Web của bạn. Nếu bạn biết rằng địa chỉ Internet đó là chính xác và nếu bạn đã thử một vài địa chỉ Internet hợp lệ mà vẫn nhận kết quả tương tự thì thông điệp này có nghĩa là có sự cố với ISP của bạn hoặc với modem giao tiếp với bộ định tuyến của bạn.

Hãy thử các cách sau:

- Hãy chắc chắn rằng cáp mạng và cáp nguồn đã được kết nối chắc chắn.
- Hãy chắc chắn rằng bộ định tuyến được cắm vào ổ cắm có điện.
- Khởi động lại bộ định tuyến.
- Liên hệ ISP của bạn và hỏi về tình hình ngừng dịch vụ trong khu vực của bạn.

Phương pháp phổ biến nhất để xử lý sự cố cho bộ định tuyến là tắt đi, rồi bật lại. Khi đó, bộ định tuyến có thể nạp lại các cài đặt tùy chỉnh của nó, và các thiết bị khác (ví dụ như modem) sẽ có thể phát hiện lại bộ định tuyến và giao tiếp với nó. Quy trình này gọi là khởi động lại.

Để khởi động lại bộ định tuyến của bạn bằng cách sử dụng dây nguồn, hãy làm như sau:

1. Ngắt kết nối dây nguồn khỏi bộ định tuyến và modem.
2. Đợi 10 giây và cắm lại dây nguồn vào modem. Hãy chắc chắn rằng nó có điện.
3. Đợi đến khi đèn báo trực tuyến của modem dừng nhấp nháy (khoảng hai phút). Cắm lại dây nguồn vào bộ định tuyến.
4. Chờ đến khi đèn LED nhấp nháy màu xanh lá cây giữa nút Reset (Đặt lại) và cổng nguồn sáng ổn định. Đợi hai phút trước khi thử kết nối Internet từ một máy tính.

Thông số kỹ thuật

Linksys E5600

Tên sản phẩm	Bộ định tuyến WiFi 5 Băng tần kép AC1200
Mã sản phẩm	E5600
Tốc độ Cổng Thiết bị chuyển mạch	10/100/1000 Mbps (Ethernet Nhanh)
Tần số vô tuyến	2.4 GHz và 5 GHz
Số lượng ăng-ten	4 bên trong
Cổng	Ethernet (1-4), Internet, Nguồn
Nút	Wi-Fi Protected Setup, Reset (Đặt lại), Công tắc nguồn
Đèn LED	Nguồn, Internet, Ethernet (1-4)
UPnP	Có hỗ trợ
Tính năng bảo mật	WPA2 Cá nhân
Bit mã khóa bảo mật	Mã hóa tối đa 128-bit

Môi trường

Kích thước	135mm (D) x 38mm (R) x 185,5mm (C)
Trọng lượng thiết bị	410 g (0,9 lbs)
Nguồn	12V, 1A
Chứng chỉ	FCC, IC, CE, Wi-Fi (IEEE 802.11 a/b/g/n/ac)
Nhiệt độ hoạt động	32 đến 104°F (0 đến 40°C)
Nhiệt độ bảo quản	-4 đến 140°F (-20 đến 60°C)
Độ ẩm hoạt động	10% đến 80% độ ẩm tương đối, không ngưng tụ
Độ ẩm bảo quản	5 đến 90% không ngưng tụ

Lưu ý:

Để biết thông tin quy định, bảo hành và an toàn, hãy xem CD đi kèm với bộ định tuyến hoặc truy cập Linksys.com/support/E5600.

Các thông số kỹ thuật có thể thay đổi mà không cần thông báo.

Hiệu suất tối đa lấy từ các thông số kỹ thuật của Tiêu chuẩn IEEE 802.11. Hiệu suất thực tế có thể thay đổi, trong đó công suất của mạng không dây, tốc độ truyền dữ liệu, phạm vi và vùng phủ sóng có thể thấp hơn. Hiệu suất phụ thuộc vào nhiều yếu tố, điều kiện và biến số như: khoảng cách tới điểm truy nhập, lưu lượng mạng, vật liệu và cấu trúc xây dựng, hệ điều hành sử dụng, kết hợp nhiều sản phẩm không dây, nhiều và các điều kiện bất lợi khác.

BELKIN, LINKSYS và nhiều tên sản phẩm và logo là thương hiệu của tập đoàn các công ty Belkin. Các thương hiệu của bên thứ ba được đề cập là tài sản của chủ sở hữu tương ứng. Các giấy phép và thông báo cho các phần mềm của bên thứ ba được sử dụng trong sản phẩm này có thể xem ở đây: <http://support.linksys.com/en-us/license>. Vui lòng liên hệ <http://support.linksys.com/en-us/gplcodecenter> nếu có câu hỏi hoặc yêu cầu mã nguồn GPL.

© 2020 Belkin International, Inc. và/hoặc các công ty con. Bảo lưu mọi quyền.

LNKPG-00697_RevA00