



# **CX331, CX431, MC3224, MC3326, MC3426, XC2326 MFPs**

---

## **User's Guide**

**September 2021**

**[www.lexmark.com](http://www.lexmark.com)**

---

Machine type:

3500

Models:

285, 485, 685, 876, 8c6, 8c9

# Contents

- Safety information..... 6**
  - Conventions..... 6
  - Product statements..... 6
  
- Learn about the printer..... 9**
  - Finding information about the printer.....9
  - Finding the printer serial number.....10
  - Printer configurations..... 11
  - Using the control panel.....13
  - Customizing the home screen..... 13
  - Changing the language of the keyboard on the display..... 13
  - Understanding the status of the indicator light..... 14
  - Selecting paper.....14
  
- Set up, install, and configure..... 20**
  - Selecting a location for the printer..... 20
  - Attaching cables..... 21
  - Installing optional trays..... 22
  - Setting up and using the home screen applications..... 23
  - Setting up the printer to fax..... 24
  - Configuring the e-mail SMTP settings..... 32
  - Loading paper and specialty media..... 40
  - Installing and updating software, drivers, and firmware..... 44
  - Available options..... 47
  - Networking.....48
  - Printing the Menu Settings Page.....52
  
- Secure the printer.....53**
  - Erasing printer memory..... 53
  - Restoring factory default settings..... 53
  - Statement of Volatility..... 53
  
- Print..... 54**
  - Printing from a computer.....54
  - Printing from a mobile device..... 54

Printing from a flash drive..... 55

Supported flash drives and file types..... 56

Configuring confidential jobs..... 57

Printing confidential and other held jobs..... 58

Printing from a Cloud Connector profile..... 59

Printing a font sample list..... 59

Placing separator sheets between copies..... 59

Canceling a print job..... 59

Adjusting toner darkness..... 60

**Copy..... 61**

Using the automatic document feeder and scanner glass..... 61

Making copies..... 61

Copying photos..... 61

Copying on letterhead..... 62

Copying on both sides of the paper..... 62

Reducing or enlarging copies..... 62

Copying multiple pages onto a single sheet..... 62

Collating copies..... 62

Copying cards..... 63

Creating a copy shortcut..... 63

**E-mail..... 64**

Using the automatic document feeder and scanner glass..... 64

Sending an e-mail..... 64

Creating an e-mail shortcut..... 65

**Fax..... 66**

Using the automatic document feeder and scanner glass..... 66

Sending a fax..... 66

Scheduling a fax..... 67

Creating a fax destination shortcut..... 67

Changing the fax resolution..... 67

Adjusting the fax darkness..... 68

Printing a fax log..... 68

Blocking junk faxes..... 68

Holding faxes..... 68

Forwarding a fax.....68

**Scan..... 70**

Using the automatic document feeder and scanner glass..... 70

Scanning to a computer.....70

Scanning to an FTP server using a shortcut.....71

Scanning to a network folder using a shortcut.....72

Scanning to a flash drive..... 72

Scanning to a Cloud Connector profile..... 73

**Use printer menus..... 74**

Menu map..... 74

Device.....75

Print..... 87

Paper.....93

Copy.....95

Fax..... 97

E-mail.....108

FTP.....112

USB Drive.....115

Network/Ports.....119

Security.....132

Cloud Connector.....136

Reports.....136

Troubleshooting.....138

**Maintain the printer..... 139**

Checking the status of parts and supplies.....139

Configuring supply notifications.....139

Setting up e-mail alerts.....139

Viewing reports.....139

Ordering parts and supplies.....140

Replacing parts and supplies.....143

Cleaning printer parts.....157

Saving energy and paper.....164

Moving the printer to another location.....164

Shipping the printer.....165

**Troubleshoot a problem..... 166**

- Print quality problems.....166
- Printing problems..... 167
- The printer is not responding..... 193
- Unable to read flash drive..... 194
- Enabling the USB port..... 195
- Network connection problems.....195
- Issues with supplies.....197
- Clearing jams..... 198
- Paper feed problems..... 210
- E-mailing problems.....212
- Faxing problems.....213
- Scanning problems.....218
- Color quality problems..... 225
- Contacting customer support..... 227

**Recycle and dispose..... 229**

- Recycling Lexmark products.....229
- Recycling Lexmark packaging.....229

**Notices..... 230**

**Index.....248**

# Safety information





## Conventions

**Note:** A *note* identifies information that could help you.







**Warning:** A *warning* identifies something that could damage the product hardware or software.

**CAUTION:** A *caution* indicates a potentially hazardous situation that could injure you.

Different types of caution statements include:

-  **CAUTION—POTENTIAL INJURY:** Indicates a risk of injury.
-  **CAUTION—SHOCK HAZARD:** Indicates a risk of electrical shock.
-  **CAUTION—HOT SURFACE:** Indicates a risk of burn if touched.
-  **CAUTION—TIPPING HAZARD:** Indicates a crush hazard.
-  **CAUTION—PINCH HAZARD:** Indicates a risk of being caught between moving parts.

## Product statements

-  **CAUTION—POTENTIAL INJURY:** To avoid the risk of fire or electrical shock, connect the power cord to an appropriately rated and properly grounded electrical outlet that is near the product and easily accessible.
-  **CAUTION—POTENTIAL INJURY:** To avoid the risk of fire or electrical shock, use only the power cord provided with this product or the manufacturer's authorized replacement.
-  **CAUTION—POTENTIAL INJURY:** Do not use this product with extension cords, multioutlet power strips, multioutlet extenders, or UPS devices. The power capacity of these types of accessories can be easily overloaded by a laser printer and may result in a risk of fire, property damage, or poor printer performance.
-  **CAUTION—POTENTIAL INJURY:** Only a Lexmark Inline Surge Protector that is properly connected between the printer and the power cord provided with the printer may be used with this product. The use of non-Lexmark surge protection devices may result in a risk of fire, property damage, or poor printer performance.
-  **CAUTION—POTENTIAL INJURY:** To reduce the risk of fire, use only a 26 AWG or larger telecommunications (RJ-11) cord when connecting this product to the public switched telephone network. For users in Australia, the cord must be approved by the Australian Communications and Media Authority.
-  **CAUTION—SHOCK HAZARD:** To avoid the risk of electrical shock, do not place or use this product near water or wet locations.
-  **CAUTION—SHOCK HAZARD:** To avoid the risk of electrical shock, do not set up this product or make any electrical or cabling connections, such as the power cord, fax feature, or telephone, during a lightning storm.

 **CAUTION—POTENTIAL INJURY:** Do not cut, twist, bind, crush, or place heavy objects on the power cord. Do not subject the power cord to abrasion or stress. Do not pinch the power cord between objects such as furniture and walls. If any of these things happen, a risk of fire or electrical shock results. Inspect the power cord regularly for signs of such problems. Remove the power cord from the electrical outlet before inspecting it.

 **CAUTION—SHOCK HAZARD:** To avoid the risk of electrical shock, make sure that all external connections (such as Ethernet and telephone system connections) are properly installed in their marked plug-in ports.

 **CAUTION—SHOCK HAZARD:** To avoid the risk of electrical shock, if you are accessing the controller board or installing optional hardware or memory devices sometime after setting up the printer, then turn the printer off, and unplug the power cord from the electrical outlet before continuing. If you have any other devices attached to the printer, then turn them off as well, and unplug any cables going into the printer.

 **CAUTION—SHOCK HAZARD:** To avoid the risk of electrical shock, do not use the fax feature during a lightning storm.





 **CAUTION—SHOCK HAZARD:** To avoid the risk of electrical shock when cleaning the exterior of the printer, unplug the power cord from the electrical outlet and disconnect all cables from the printer before proceeding.

 **CAUTION—POTENTIAL INJURY:** If the printer weight is greater than 20 kg (44 lb), then it may require two or more people to lift it safely.

 **CAUTION—POTENTIAL INJURY:** When moving the printer, follow these guidelines to avoid personal injury or printer damage:

- Make sure that all doors and trays are closed.
- Turn off the printer, and then unplug the power cord from the electrical outlet.
- Disconnect all cords and cables from the printer.
- If the printer has separate floor-standing optional trays or output options attached to it, then disconnect them before moving the printer.
- If the printer has a caster base, then carefully roll it to the new location. Use caution when passing over thresholds and breaks in flooring.
- If the printer does not have a caster base but is configured with optional trays or output options, then remove the output options and lift the printer off the trays. Do not try to lift the printer and any options at the same time.
- Always use the handholds on the printer to lift it.
- Any cart used to move the printer must have a surface able to support the full footprint of the printer.
- Any cart used to move the hardware options must have a surface able to support the dimensions of the options.
- Keep the printer in an upright position.
- Avoid severe jarring movements.
- Make sure that your fingers are not under the printer when you set it down.
- Make sure that there is adequate clearance around the printer.

 **CAUTION—TIPPING HAZARD:** Installing one or more options on your printer or MFP may require a caster base, furniture, or other feature to prevent instability causing possible injury. For more information on supported configurations, see [www.lexmark.com/multifunctionprinters](http://www.lexmark.com/multifunctionprinters).

-  **CAUTION—TIPPING HAZARD:** To reduce the risk of equipment instability, load each tray separately. Keep all other trays closed until needed.
-  **CAUTION—HOT SURFACE:** The inside of the printer might be hot. To reduce the risk of injury from a hot component, allow the surface to cool before touching it.
-  **CAUTION—PINCH HAZARD:** To avoid the risk of a pinch injury, use caution in areas marked with this label. Pinch injuries may occur around moving parts, such as gears, doors, trays, and covers.
-  **CAUTION—POTENTIAL INJURY:** This product uses a laser. Use of controls or adjustments or performance of procedures other than those specified in the *User's Guide* may result in hazardous radiation exposure.
-  **CAUTION—POTENTIAL INJURY:** The lithium battery in this product is not intended to be replaced. There is a danger of explosion if a lithium battery is incorrectly replaced. Do not recharge, disassemble, or incinerate a lithium battery. Discard used lithium batteries according to the manufacturer's instructions and local regulations.

This product is designed, tested, and approved to meet strict global safety standards with the use of specific manufacturer's components. The safety features of some parts may not always be obvious. The manufacturer is not responsible for the use of other replacement parts.

Refer service or repairs, other than those described in the user documentation, to a service representative.

**SAVE THESE INSTRUCTIONS.**



# Learn about the printer

## Finding information about the printer

| What are you looking for?   | Find it here  |
|---|---|
| Initial setup instructions  | See the setup documentation that came with the printer.   |
| <ul style="list-style-type: none"> <li>• Printer software</li> <li>• Print or fax driver</li> <li>• Printer firmware</li> <li>• Utility</li> </ul>  | Go to <a href="http://www.lexmark.com/downloads">www.lexmark.com/downloads</a> , search for your printer model, and then in the Type menu, select the driver, firmware, or utility that you need.   |
| <ul style="list-style-type: none"> <li>• Selecting and storing paper and specialty media</li> <li>• Loading paper</li> <li>• Configuring printer settings</li> <li>• Viewing and printing documents and photos</li> <li>• Configuring the printer on a network</li> <li>• Caring for and maintaining the printer</li> <li>• Troubleshooting and solving problems</li> </ul> | Information Center—Go to <a href="https://infoserve.lexmark.com">https://infoserve.lexmark.com</a> .<br>How-to videos—Go to <a href="https://infoserve.lexmark.com/idv/">https://infoserve.lexmark.com/idv/</a> .   |
| Help information for using the printer software.  | <p>Help for Microsoft Windows or Macintosh operating systems—Open a printer software program or application, and then click <b>Help</b>.</p> <p>Click  to view context-sensitive information.</p> <p><b>Notes:</b></p> <ul style="list-style-type: none"> <li>• Help is automatically installed with the printer software.</li> <li>• Depending on the operating system, the printer software is either in the printer program folder or on the desktop.</li> </ul>  |
| <ul style="list-style-type: none"> <li>• Documentation</li> <li>• Live chat support</li> <li>• E-mail support</li> <li>• Voice support</li> </ul>   | <p>Go to <a href="http://support.lexmark.com">http://support.lexmark.com</a>.</p> <p><b>Note:</b> Select your country or region, and then select your product to view the appropriate support site.</p> <p>Support contact information for your country or region can be found on the website or on the printed warranty that came with the printer.</p> <p>Have the following information ready when you contact customer support:</p> <ul style="list-style-type: none"> <li>• Place and date of purchase</li> <li>• Machine type and serial number</li> </ul> <p>For more information, see <a href="#">“Finding the printer serial number” on page 10</a>.</p> |

| What are you looking for?  | Find it here   |
|--|--|
| <ul style="list-style-type: none"><li>• Safety information</li><li>• Regulatory information</li><li>• Warranty information</li><li>• Environmental information</li></ul> | Warranty information varies by country or region: <ul style="list-style-type: none"><li>• <b>In the U.S.</b>—See the Statement of Limited Warranty included with the printer, or go to <a href="http://support.lexmark.com">http://support.lexmark.com</a>.</li><li>• <b>In other countries and regions</b>—See the printed warranty that came with the printer.</li></ul> <i>Product Information Guide</i> —See the documentation that came with the printer or go to <a href="http://support.lexmark.com">http://support.lexmark.com</a> . |
| Information on Lexmark digital passport  | Go to <a href="https://csr.lexmark.com/digital-passport.php">https://csr.lexmark.com/digital-passport.php</a> .  |

## Finding the printer serial number

- 1 Open the front door, and then firmly push it down.

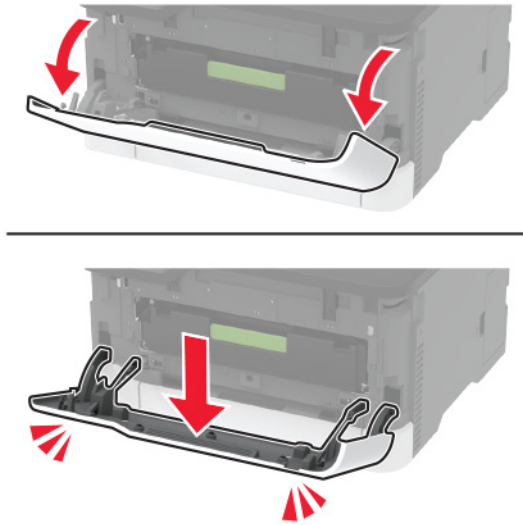

- 2 Locate the printer serial number behind the front door.

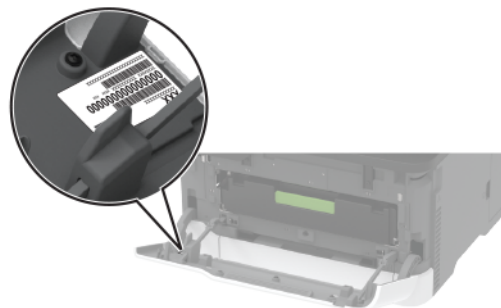

# Printer configurations

## Lexmark MC3224dwe MFP

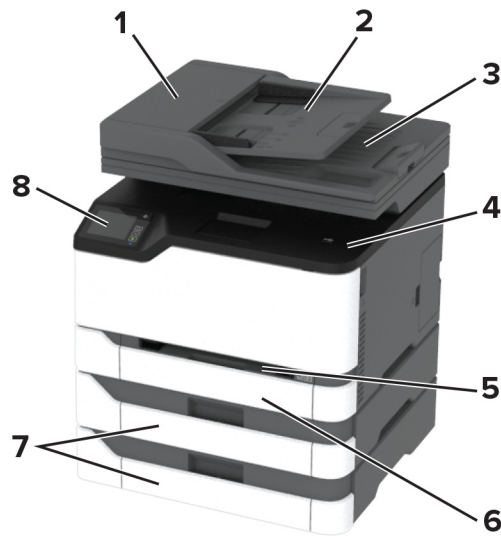

|          |                |
|----------|----------------|
| <b>1</b> | Scanner        |
| <b>2</b> | Standard bin   |
| <b>3</b> | Manual feeder  |
| <b>4</b> | 250-sheet tray |
| <b>5</b> | Control panel  |

**Lexmark CX331, Lexmark CX431, Lexmark MC3224adwe, Lexmark MC3326, Lexmark MC3426, Lexmark XC2326 MFPs**

|          |   |
|----------|---|
| <b>1</b> | Automatic document feeder (ADF)   |
| <b>2</b> | ADF tray  |
| <b>3</b> | ADF bin   |
| <b>4</b> | Standard bin  |
| <b>5</b> | Manual feeder   |
| <b>6</b> | Standard 250-sheet tray   |
| <b>7</b> | Optional 250-sheet trays<br><b>Note:</b> Supported only in some printer models. |
| <b>8</b> | Control panel   |

## Using the control panel

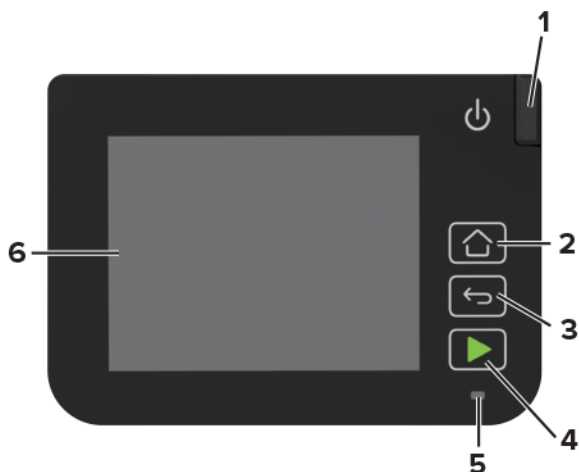

|   | Control panel part | Function  |
|---|--------------------|---|
| 1 | Power button       | Turn on or turn off the printer.<br><b>Note:</b> To turn off the printer, press and hold the power button for five seconds.         |
| 2 | Home button        | Go to the home screen.  |
| 3 | Back button        | Return to the previous screen.  |
| 4 | Start button       | Start a job, depending on which mode is selected.   |
| 5 | Indicator light    | Check the status of the printer.  |
| 6 | Display            | <ul style="list-style-type: none"> <li>View printer messages and supply status.</li> <li>Set up and operate the printer.</li> </ul> |

## Customizing the home screen

- 1 From the control panel, touch **Settings > Device > Visible Home Screen Icons**.
- 2 Select the icons that you want to appear on the home screen.
- 3 Apply the changes.

## Changing the language of the keyboard on the display

**Note:** You can only change the language of the keyboard in printer tasks that require alphanumeric input such as e-mail or scan.

- 1 Touch the input field.
- 2 On the keyboard, touch and hold the language key.
- 3 Select a language.

## Understanding the status of the indicator light

| Indicator light | Printer status                          |
|-----------------|---|
| Off             | The printer is off.                     |
| Blue            | The printer is on or ready.             |
| Blinking blue   | The printer is processing data.         |
| Blinking red    | The printer requires user intervention. |
| Amber           | The printer is in Sleep mode.           |

## Selecting paper

### Paper guidelines

Use the appropriate paper to prevent jams and help ensure trouble-free printing.

- Always use new, undamaged paper.
- Before loading paper, know the recommended printable side of the paper. This information is usually indicated on the paper package.
- Do not use paper that has been cut or trimmed by hand.
- Do not mix paper sizes, types, or weights in the same tray; mixing results in jams.
- Do not use coated papers unless they are specifically designed for electrophotographic printing.

### Paper characteristics

The following paper characteristics affect print quality and reliability. Consider these factors before printing on them.

#### Weight

The trays can feed paper weights from 60 to 162 g/m<sup>2</sup> (16 to 43 lb) grain long paper. Paper lighter than 60 g/m<sup>2</sup> (16 lb) may not be stiff enough to feed properly, and may cause jams.

#### Curl

Curl is the tendency for paper to curl at its edges. Excessive curl can cause paper feeding problems. Curl can occur after the paper passes through the printer, where it is exposed to high temperatures. Storing paper unwrapped in hot, humid, cold, or dry conditions can contribute to paper curling before printing and can cause feeding problems.

#### Smoothness

Paper smoothness directly affects print quality. If paper is too rough, toner cannot fuse to it properly. If paper is too smooth, it can cause paper feeding or print quality issues. We recommend the use of paper with 50 Sheffield points.

## Moisture content

The amount of moisture in paper affects both print quality and the printer ability to feed the paper correctly. Leave paper in its original wrapper until you use it. Exposure of paper to moisture changes can degrade its performance.

Store paper in its original wrapper in the same environment as the printer for 24 to 48 hours before printing. Extend the time several days if the storage or transportation environment is very different from the printer environment. Thick paper may also require a longer conditioning period.

## Grain direction

Grain refers to the alignment of the paper fibers in a sheet of paper. Grain is either *grain long*, running the length of the paper, or *grain short*, running the width of the paper.

For 60–162-g/m<sup>2</sup> (16–43-lb) paper, grain long paper is recommended.

## Fiber content

Most high-quality xerographic paper is made from 100 percent chemically treated pulped wood. This content provides the paper with a high degree of stability, resulting in fewer paper feeding problems and better print quality. Paper containing fibers such as cotton can negatively affect paper handling.

## Unacceptable paper

The following paper types are not recommended for use with the printer:

- Chemically treated papers used to make copies without carbon paper, also known as carbonless papers, carbonless copy paper (CCP), or no carbon required (NCR) paper
- Preprinted papers with chemicals that may contaminate the printer
- Preprinted papers that can be affected by the temperature in the printer fuser
- Preprinted papers that require a registration (the precise print location on the page) greater than ±2.3 mm (±0.9 in.), such as optical character recognition (OCR) forms

In some cases, registration can be adjusted with a software application to successfully print on these forms.

- Coated papers (erasable bond), synthetic papers, thermal papers
- Rough-edged, rough or heavily textured surface papers, or curled papers
- Recycled papers that fail EN12281:2002 (European)
- Paper weighing less than 60 g/m<sup>2</sup> (16 lb)
- Multiple-part forms or documents

## Selecting preprinted forms and letterhead

- Use grain long paper.
- Use only forms and letterhead printed using an offset lithographic or engraved printing process.
- Avoid paper with rough or heavily textured surfaces.
- Use inks that are not affected by the resin in toner. Inks that are oxidation-set or oil-based generally meet these requirements; latex inks might not.
- Print samples on preprinted forms and letterheads considered for use before buying large quantities. This action determines whether the ink in the preprinted form or letterhead affects print quality.

- When in doubt, contact your paper supplier.
- When printing on letterhead, load the paper in the proper orientation for your printer. For more information, see the *Paper and Specialty Media Guide*.

## Storing paper

Use these paper storage guidelines to help avoid jams and uneven print quality:

- Store paper in its original wrapper in the same environment as the printer for 24 to 48 hours before printing.
- Extend the time several days if the storage or transportation environment is very different from the printer environment. Thick paper may also require a longer conditioning period.
- For best results, store paper where the temperature is 21°C (70°F) and the relative humidity is 40 percent.
- Most label manufacturers recommend printing in a temperature range of 18–24°C (65–75°F) with relative humidity between 40 and 60 percent.
- Store paper in cartons, on a pallet or shelf, rather than on the floor.
- Store individual packages on a flat surface.
- Do not store anything on top of individual paper packages.
- Take paper out of the carton or wrapper only when you are ready to load it in the printer. The carton and wrapper help keep the paper clean, dry, and flat.

## Supported paper sizes

| Paper size   | Standard or optional 250-sheet tray | Manual feeder | Two-sided printing | ADF | Scanner glass |
|--|-------------------------------------|---------------|--------------------|-----|---------------|
| <b>A4</b><br>210 x 297 mm<br>(8.27 x 11.7 in.)             | ✓                                   | ✓             | ✓                  | ✓   | ✓             |
| <b>A5<sup>1</sup></b><br>148 x 210 mm<br>(5.83 x 8.27 in.) | ✓                                   | ✓             | x                  | ✓   | ✓             |
| <b>A6</b><br>105 x 148 mm<br>(4.13 x 5.83 in.)             | ✓                                   | ✓             | x                  | ✓   | ✓             |
| <b>JIS B5</b><br>182 x 257 mm<br>(7.17 x 10.1 in.)         | ✓                                   | ✓             | x                  | ✓   | ✓             |

<sup>1</sup> The default support is long-edge feed. When running on short-edge feed, A5 is treated as narrow paper.

<sup>2</sup> When selected, the page is formatted for 215.90 x 355.60 mm (8.5 x 14 in.) unless specified by the software application.

<sup>3</sup> Load narrow paper with the short edge entering the printer first.

<sup>4</sup> Supports paper size only up to 216 x 297 mm (8.5 x 11.7 in.).

<sup>5</sup> The standard 250-sheet tray supports only up to five envelopes at a time. The optional 250-sheet tray supports up to 40 envelopes at a time.



| Paper size   | Standard or optional 250-sheet tray | Manual feeder | Two-sided printing | ADF | Scanner glass  |
|--|-------------------------------------|---------------|--------------------|-----|----------------|
| <b>Oficio (Mexico)</b><br>215.9 x 340.4 mm<br>(8.5 x 13.4 in.)   | ✓                                   | ✓             | ✓                  | ✓   | ✗              |
| <b>Hagaki</b><br>100 x 148 mm<br>(3.94 x 5.83 in.)   | ✓                                   | ✓             | ✗                  | ✗   | ✓              |
| <b>Statement</b><br>139.7 x 215.9 mm<br>(5.5 x 8.5 in.)  | ✓                                   | ✓             | ✗                  | ✓   | ✓              |
| <b>Executive</b><br>184.2 x 266.7 mm<br>(7.25 x 10.5 in.)  | ✓                                   | ✓             | ✗                  | ✓   | ✓              |
| <b>Letter</b><br>215.9 x 279.4 mm<br>(8.5 x 11 in.)  | ✓                                   | ✓             | ✓                  | ✓   | ✓              |
| <b>Legal</b><br>215.9 x 355.6 mm<br>(8.5 x 14 in.)   | ✓                                   | ✓             | ✓                  | ✓   | ✗              |
| <b>Folio</b><br>215.9 x 330.2 mm<br>(8.5 x 13 in.)   | ✓                                   | ✓             | ✓                  | ✓   | ✗              |
| <b>Universal<sup>2, 3</sup></b><br>98.4 x 148 mm<br>(3.86 x 5.83 in.) to<br>215.9 x 355.6 mm<br>(8.5 x 14 in.) | ✓                                   | ✓             | ✓                  | ✓   | ✓ <sup>4</sup> |
| <b>Universal<sup>2, 3</sup></b><br>25.4 x 25.4 mm (1x1 in.)<br>to 215.9 x 297 mm<br>(8.5 x 11.69 in.)          | ✗                                   | ✗             | ✗                  | ✗   | ✓              |

<sup>1</sup> The default support is long-edge feed. When running on short-edge feed, A5 is treated as narrow paper.

<sup>2</sup> When selected, the page is formatted for 215.90 x 355.60 mm (8.5 x 14 in.) unless specified by the software application.

<sup>3</sup> Load narrow paper with the short edge entering the printer first.

<sup>4</sup> Supports paper size only up to 216 x 297 mm (8.5 x 11.7 in.).

<sup>5</sup> The standard 250-sheet tray supports only up to five envelopes at a time. The optional 250-sheet tray supports up to 40 envelopes at a time.

| Paper size   | Standard or optional 250-sheet tray | Manual feeder | Two-sided printing | ADF | Scanner glass |
|--|-------------------------------------|---------------|--------------------|-----|---------------|
| <b>Universal</b> <sup>2, 3</sup><br>105 x 148 mm<br>(4.13 x 5.83 in.) to<br>215.9 x 355.6 mm<br>(8.5 x 14 in.) | X                                   | X             | X                  | ✓   | X             |
| <b>7 3/4 Envelope</b><br>98.4 x 190.5 mm<br>(3.875 x 7.5 in.)  | ✓ <sup>5</sup>                      | ✓             | X                  | X   | ✓             |
| <b>9 Envelope</b><br>98.4 x 225.4 mm<br>(3.875 x 8.9 in.)  | ✓ <sup>5</sup>                      | ✓             | X                  | X   | ✓             |
| <b>10 Envelope</b><br>104.8 x 241.3 mm<br>(4.12 x 9.5 in.)   | ✓ <sup>5</sup>                      | ✓             | X                  | X   | ✓             |
| <b>DL Envelope</b><br>110 x 220 mm<br>(4.33 x 8.66 in.)  | ✓ <sup>5</sup>                      | ✓             | X                  | X   | ✓             |
| <b>C5 Envelope</b><br>162 x 229 mm<br>(6.38 x 9.01 in.)  | ✓ <sup>5</sup>                      | ✓             | X                  | X   | ✓             |
| <b>B5 Envelope</b><br>176 x 250 mm<br>(6.93 x 9.84 in.)  | ✓ <sup>5</sup>                      | ✓             | X                  | X   | ✓             |
| <b>Other Envelope</b><br>98.4 x 162 mm<br>(3.87 x 6.38 in.) to<br>176 x 250 mm<br>(6.93 x 9.84 in.)            | ✓ <sup>5</sup>                      | ✓             | X                  | X   | N/A           |

<sup>1</sup> The default support is long-edge feed. When running on short-edge feed, A5 is treated as narrow paper.

<sup>2</sup> When selected, the page is formatted for 215.90 x 355.60 mm (8.5 x 14 in.) unless specified by the software application.

<sup>3</sup> Load narrow paper with the short edge entering the printer first.

<sup>4</sup> Supports paper size only up to 216 x 297 mm (8.5 x 11.7 in.).

<sup>5</sup> The standard 250-sheet tray supports only up to five envelopes at a time. The optional 250-sheet tray supports up to 40 envelopes at a time.

## Supported paper types

### Notes:

- Labels, envelopes, and card stock always print at reduced speed.
- Labels are supported for occasional use and must be tested for acceptability.

- The ADF supports only plain paper.

| Paper type  | Standard or optional 250-sheet tray | Manual feeder | Two-sided printing |
|-------------|-------------------------------------|---------------|--------------------|
| Plain paper | ✓                                   | ✓             | ✓                  |
| Card stock  | ✓                                   | ✓             | x                  |
| Labels      | ✓                                   | ✓             | x                  |
| Envelopes   | ✓                                   | ✓             | x                  |

## Supported paper weights

### Notes:

- The ADF supports 60–90 g/m<sup>2</sup> (16–24 lb bond) paper.
- Hagaki and A6 are supported only in the manual feeder and optional tray up to a weight of 209 g/m<sup>2</sup>. Heavier weight must be tested for acceptability.

| Paper type and weight  | Standard or optional 250-sheet tray | Manual feeder | Two-sided printing |
|--|-------------------------------------|---------------|--------------------|
| <b>Light paper</b><br>60–74.9 g/m <sup>2</sup> grain long (16–19.9-lb bond)  | ✓                                   | ✓             | ✓                  |
| <b>Plain paper</b><br>75–90.3 g/m <sup>2</sup> grain long (20–24-lb bond)    | ✓                                   | ✓             | ✓                  |
| <b>Heavy paper</b><br>90.3–105 g/m <sup>2</sup> grain long (24.1–28-lb bond) | ✓                                   | ✓             | ✓                  |
| <b>Card stock</b><br>105.1–162 g/m <sup>2</sup> grain long (28.1–43-lb bond) | ✓                                   | ✓             | x                  |
| <b>Card stock</b><br>163–200 g/m <sup>2</sup> grain long (43.1–53-lb bond)   | x                                   | ✓             | x                  |
| <b>Paper labels</b><br>131 g/m <sup>2</sup> (35-lb bond)                     | ✓                                   | ✓             | x                  |
| <b>Envelopes</b><br>60–105 g/m <sup>2</sup> (16–28-lb bond)                  | ✓                                   | ✓             | x                  |

# Set up, install, and configure

## Selecting a location for the printer

- Leave enough room to open trays, covers, and doors and to install hardware options.
- Set up the printer near an electrical outlet.

**⚠ CAUTION—POTENTIAL INJURY:** To avoid the risk of fire or electrical shock, connect the power cord to an appropriately rated and properly grounded electrical outlet that is near the product and easily accessible.

**⚡ CAUTION—SHOCK HAZARD:** To avoid the risk of electrical shock, do not place or use this product near water or wet locations.

- Make sure that airflow in the room meets the latest revision of the ASHRAE 62 standard or the CEN Technical Committee 156 standard.
- Provide a flat, sturdy, and stable surface.
- Keep the printer:
  - Clean, dry, and free of dust
  - Away from stray staples and paper clips
  - Away from the direct airflow of air conditioners, heaters, or ventilators
  - Free from direct sunlight and humidity extremes
- Observe the temperature range.

|                       |                           |
|-----------------------|---------------------------|
| Operating temperature | 10 to 32.2°C (50 to 90°F) |
|-----------------------|---------------------------|

- Allow the following recommended amount of space around the printer for proper ventilation:

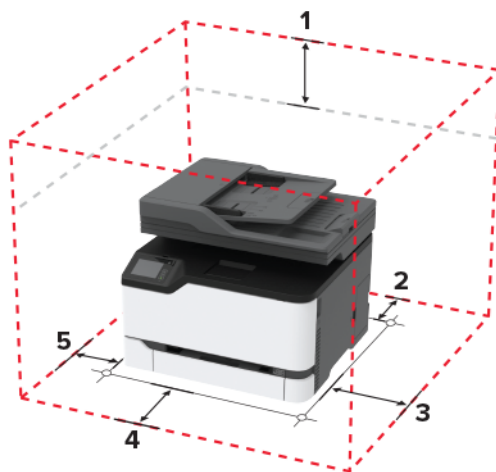

|          |            |                 |
|----------|------------|-----------------|
| <b>1</b> | Top        | 305 mm (12 in.) |
| <b>2</b> | Rear       | 102 mm (4 in.)  |
| <b>3</b> | Right side | 76 mm (3 in.)   |
| <b>4</b> | Front      | 76 mm (3 in.)   |

|   |           |               |
|---|-----------|---------------|
| 5 | Left side | 76 mm (3 in.) |
|---|-----------|---------------|

## Attaching cables

- ⚠ CAUTION—SHOCK HAZARD:** To avoid the risk of electrical shock, do not set up this product or make any electrical or cabling connections, such as the power cord, fax feature, or telephone, during a lightning storm.
- ⚠ CAUTION—POTENTIAL INJURY:** To avoid the risk of fire or electrical shock, connect the power cord to an appropriately rated and properly grounded electrical outlet that is near the product and easily accessible.
- ⚠ CAUTION—POTENTIAL INJURY:** To avoid the risk of fire or electrical shock, use only the power cord provided with this product or the manufacturer's authorized replacement.
- ⚠ CAUTION—POTENTIAL INJURY:** To reduce the risk of fire, use only a 26 AWG or larger telecommunications (RJ-11) cord when connecting this product to the public switched telephone network. For users in Australia, the cord must be approved by the Australian Communications and Media Authority.

**Warning—Potential Damage:** To avoid loss of data or printer malfunction, do not touch the USB cable, any wireless network adapter, or the printer in the areas shown while actively printing.

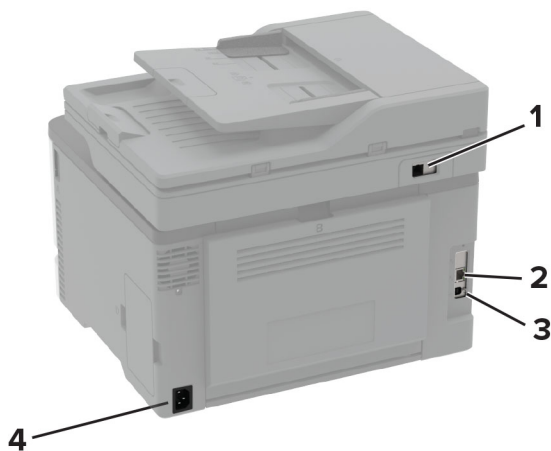

|   | Printer port   | Function   |
|---|--|--|
| 1 | LINE port<br><b>Note:</b> Available only in some printer models. | Connect the printer to an active telephone line through a standard wall jack (RJ-11), DSL filter, or VoIP adapter, or any other adapter that allows you to access the telephone line to send and receive faxes.<br><b>Note:</b> To enable manual fax, use a corded fax splitter. |
| 2 | Ethernet port  | Connect the printer to a network.  |
| 3 | USB printer port   | Connect the printer to a computer.   |
| 4 | Power cord socket  | Connect the printer to a properly grounded electrical outlet.  |

## Installing optional trays

**⚠ CAUTION—SHOCK HAZARD:** To avoid the risk of electrical shock, if you are accessing the controller board or installing optional hardware or memory devices sometime after setting up the printer, then turn the printer off, and unplug the power cord from the electrical outlet before continuing. If you have any other devices attached to the printer, then turn them off as well, and unplug any cables going into the printer.

- 1 Turn off the printer.
- 2 Unplug the power cord from the electrical outlet, and then from the printer.
- 3 Unpack the optional tray, and then remove all packing material.
- 4 Align the printer with the optional tray, and then lower the printer into place.

**⚠ CAUTION—POTENTIAL INJURY:** If the printer weight is greater than 20 kg (44 lb), then it may require two or more people to lift it safely.



- 5 Connect the power cord to the printer, and then to the electrical outlet.

**⚠ CAUTION—POTENTIAL INJURY:** To avoid the risk of fire or electrical shock, connect the power cord to an appropriately rated and properly grounded electrical outlet that is near the product and easily accessible.

- 6 Turn on the printer.

Add the tray in the print driver to make it available for print jobs. For more information, see [“Adding available options in the print driver” on page 47](#).

## Setting up and using the home screen applications

### Creating a Cloud Connector profile

- 1 From the home screen, touch **Cloud Connector**.
- 2 Select a cloud service provider.
- 3 Touch **Create** or .
- 4 Type a unique profile name.  
**Note:** We recommend creating a PIN to protect the profile.
- 5 Touch **OK**, and then take note of the authorization code.  
**Note:** The authorization code is valid only for 24 hours.
- 6 Open a web browser, and then go to <https://lexmark.cloud-connect.co>.
- 7 Click **Next**, and then accept the Terms of Use.
- 8 Enter the authorization code, and then click **Connect**.
- 9 Log in to your cloud service provider account.
- 10 Grant permissions.  
**Note:** To complete the authorization process, open the profile within 72 hours.

### Managing bookmarks

#### Creating bookmarks

Use bookmarks to print frequently accessed documents that are stored in servers or on the web.

- 1 Open a web browser, and then type the printer IP address in the address field.

**Notes:**

- View the printer IP address on the printer home screen. The IP address appears as four sets of numbers separated by periods, such as 123.123.123.123.
- If you are using a proxy server, then temporarily disable it to load the web page correctly.

- 2 Click **Bookmarks > Add Bookmark**, and then type a bookmark name.
- 3 Select an Address protocol type, and then do one of the following:
  - For HTTP and HTTPS, type the URL that you want to bookmark.
  - For HTTPS, make sure to use the host name instead of the IP address. For example, type **myWebsite.com/sample.pdf** instead of typing **123.123.123.123/sample.pdf**. Make sure that the host name also matches the Common Name (CN) value in the server certificate. For more information on obtaining the CN value in the server certificate, see the help information for your web browser.
  - For FTP, type the FTP address. For example, **myServer/myDirectory**. Enter the FTP port. Port 21 is the default port for sending commands.

- For SMB, type the network folder address. For example, **myServer/myShare/myFile.pdf**. Type the network domain name.
- If necessary, select the Authentication type for FTP and SMB.

To limit access to the bookmark, enter a PIN.

**Note:** The application supports the following file types: PDF, JPEG, TIFF, and HTML-based web pages. Other file types such as DOCX and XLXS are supported in some printer models.

#### 4 Click **Save**.

## Creating folders

### 1 Open a web browser, and then type the printer IP address in the address field.

#### Notes:

- View the printer IP address on the printer home screen. The IP address appears as four sets of numbers separated by periods, such as 123.123.123.123.
- If you are using a proxy server, then temporarily disable it to load the web page correctly.

### 2 Click **Bookmarks > Add Folder**, and then type a folder name.

**Note:** To limit access to the folder, enter a PIN.

### 3 Click **Save**.

**Note:** You can create folders or bookmarks inside a folder. To create a bookmark, see [“Creating bookmarks” on page 23](#).

## Setting up the printer to fax

### Supported fax

| Printer model | Analog fax | etherFAX <sup>1</sup> | Fax server | Fax over IP (FoIP) <sup>2</sup> |
|---------------|------------|-----------------------|------------|---------------------------------|
| CX331adwe     | ✓          | ✓                     | ✓          | ✓                               |
| CX431adw      | ✓          | ✓                     | ✓          | ✓                               |
| CX431dw       | x          | ✓                     | ✓          | ✓                               |
| MC3224adwe    | ✓          | ✓                     | ✓          | ✓                               |
| MC3224dwe     | x          | ✓                     | ✓          | ✓                               |
| MC3224i       | x          | ✓                     | ✓          | ✓                               |

<sup>1</sup> Needs a subscription. For more information, go to <https://www.etherfax.net/lexmark> or contact the place where you purchased the printer.

<sup>2</sup> Needs an installed license bundle. For more information, contact the place where you purchased the printer.



| Printer model | Analog fax | etherFAX <sup>1</sup> | Fax server | Fax over IP (FoIP) <sup>2</sup> |
|---------------|------------|-----------------------|------------|---------------------------------|
| MC3326adwe    | ✓          | ✓                     | ✓          | ✓                               |
| MC3326i       | x          | ✓                     | ✓          | ✓                               |
| MC3426adw     | ✓          | ✓                     | ✓          | ✓                               |
| MC3426i       | x          | ✓                     | ✓          | ✓                               |
| XC2326        | ✓          | ✓                     | ✓          | ✓                               |

<sup>1</sup> Needs a subscription. For more information, go to <https://www.etherfax.net/lexmark> or contact the place where you purchased the printer.

<sup>2</sup> Needs an installed license bundle. For more information, contact the place where you purchased the printer.

## Setting up the fax function using analog fax

### Notes:

- This feature is available only in some printer models.
- Some connection methods are applicable only in some countries or regions.
- If the fax function is enabled and not fully set up, then the indicator light may blink red.
- If you do not have a TCP/IP environment, then use the control panel to set up fax.

**Warning—Potential Damage:** To avoid loss of data or printer malfunction, do not touch cables or the printer in the area shown while actively sending or receiving a fax.



## Using the fax setup wizard in the printer

### Notes:

- The setup wizard is available only if no device-based fax, such as analog, etherFAX, or Fax over IP (FoIP), is configured.

- Before using the wizard, make sure that the printer firmware is updated. For more information, see [“Updating firmware” on page 46](#).

- 1 From the home screen, touch **Fax**.
- 2 Touch **Set up now**.
- 3 Type the fax name, and then touch **Next**.
- 4 Enter the fax number and then touch **Done**.

### Using the Settings menu in the printer

- 1 From the home screen, touch **Settings > Fax > Fax Setup > General Fax settings**.
- 2 Configure the settings.

### Using the Embedded Web Server

- 1 Open a web browser, and then type the printer IP address in the address field.

#### Notes:

- View the printer IP address on the home screen. The IP address appears as four sets of numbers separated by periods, such as 123.123.123.123.
- If you are using a proxy server, then temporarily disable it to load the web page correctly.

- 2 Click **Settings > Fax > Fax Setup > General Fax Settings**.
- 3 Configure the settings.
- 4 Apply the changes.

## Setting up the fax function using etherFAX

#### Notes:

- The printer firmware must be updated to the latest version. For more information, see [“Updating firmware” on page 46](#).
- An appropriate license bundle must be installed in your printer. For more information, contact etherFAX.
- Make sure that you have registered your printer to the etherFAX portal. For more information, go to <https://www.etherfax.net/lexmark>.
- The printer serial number is required on registration. To locate the serial number, see [“Finding the printer serial number” on page 10](#).

- 1 Open a web browser, and then type the printer IP address in the address field.

#### Notes:

- View the printer IP address on the home screen. The IP address appears as four sets of numbers separated by periods, such as 123.123.123.123.
- If you are using a proxy server, then temporarily disable it to load the web page correctly.

- 2 Click **Settings > Fax > Fax Setup > General Fax Settings**.

**Note:** Fax Setup appears only if Fax Mode is set to Fax.

- 3 In the Fax Name field, type a unique name.

- 4 In the Fax Number field, enter the fax number that etherFAX provided.
- 5 From the Fax Transport menu, select **etherFAX**.
- 6 Apply the changes.

## Setting up the fax function using fax server

### Notes:

- This feature lets you send fax messages to a fax service provider that supports e-mail receiving.
- This feature supports outgoing fax messages only. To support fax receive, make sure that you have a device-based fax, such as analog fax, etherFAX, or Fax over IP (FoIP), configured in your printer.

- 1 Open a web browser, and then type the printer IP address in the address field.

### Notes:

- View the printer IP address on the home screen. The IP address appears as four sets of numbers separated by periods, such as 123.123.123.123.
- If you are using a proxy server, then temporarily disable it to load the web page correctly.

- 2 Click **Settings > Fax**.

- 3 From the Fax Mode menu, select **Fax Server**, and then click **Save**.

- 4 Click **Fax Server Setup**.

- 5 In the To Format field, type **[#]@myfax.com**, where **[#]** is the fax number and **myfax.com** is the fax provider domain.

### Notes:

- If necessary, configure the Reply Address, Subject, or Message fields.
- To let the printer receive fax messages, enable the device-based fax receive setting. Make sure that you have a device-based fax configured.

- 6 Click **Save**.

- 7 Click **Fax Server E-mail Settings**, and then do either of the following:

- Enable **Use E-mail SMTP Server**.

**Note:** If the E-mail SMTP settings are not configured, then see [“Configuring the e-mail SMTP settings” on page 32](#).

- Configure the SMTP settings. For more information, contact your e-mail service provider.

- 8 Apply the changes.

## Setting up fax using a standard telephone line

**Note:** These instructions apply only to printers that support analog fax. For more information, see [“Supported fax” on page 24](#).



**CAUTION—SHOCK HAZARD:** To avoid the risk of electrical shock, do not set up this product or make any electrical or cabling connections, such as the power cord, fax feature, or telephone, during a lightning storm.

**⚠ CAUTION—SHOCK HAZARD:** To avoid the risk of electrical shock, do not use the fax feature during a lightning storm.

**⚠ CAUTION—POTENTIAL INJURY:** To reduce the risk of fire, use only a 26 AWG or larger telecommunications (RJ-11) cord when connecting this product to the public switched telephone network. For users in Australia, the cord must be approved by the Australian Communications and Media Authority.

### Setup 1: Printer is connected to a dedicated fax line

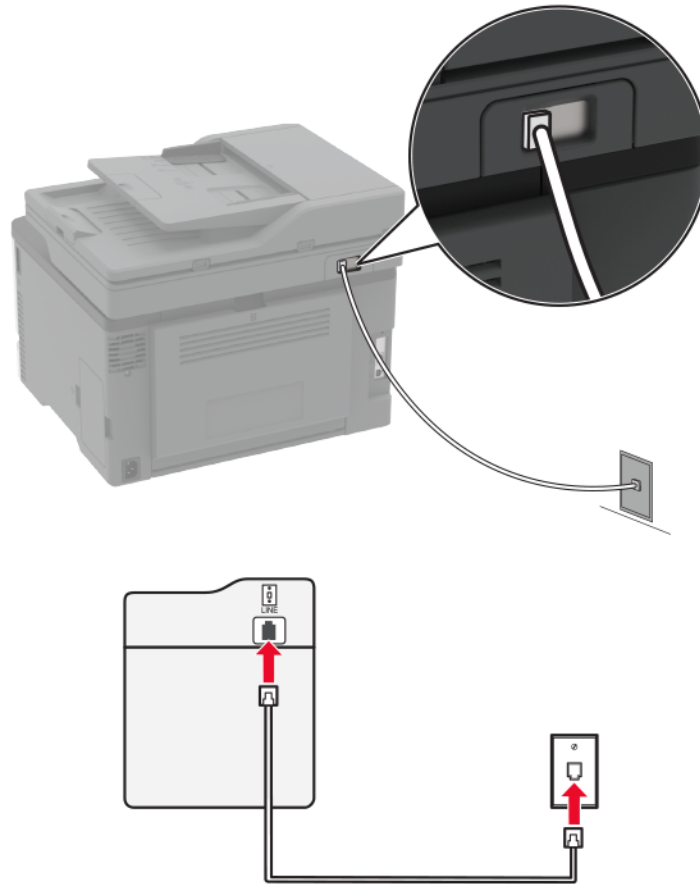

- 1 Connect one end of the telephone cable to the line port of the printer.
- 2 Connect the other end of the cable to an active analog wall jack.

#### Notes:

- You can set the printer to receive faxes automatically (set Auto Answer to **On**) or manually (set Auto Answer to **Off**).
- If you want to receive faxes automatically, then set the printer to pick up on a specified number of rings.

### Setup 2: Printer is sharing the line with an answering machine

**Note:** If you subscribe to a distinctive ring service, then make sure that you set the correct ring pattern for the printer. Otherwise, the printer does not receive faxes even if you have set it to receive faxes automatically.

## Connected to different wall jacks

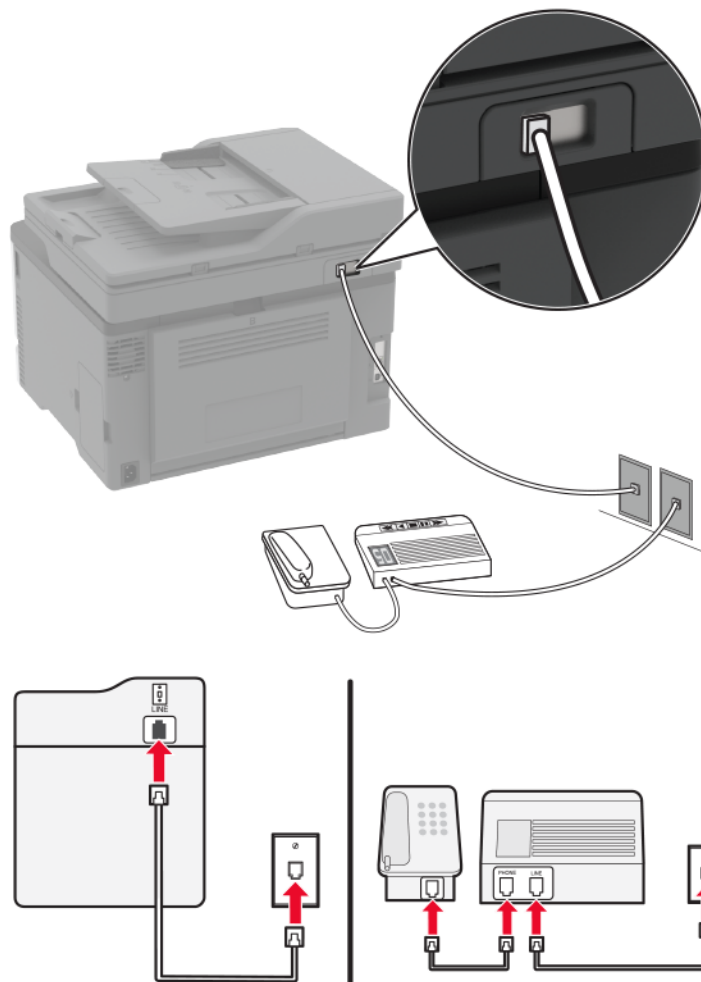

**1** Connect one end of the telephone cable to the line port of the printer.

**2** Connect the other end of the cable to an active analog wall jack.

### Notes:

- If you have only one telephone number on your line, then set the printer to receive faxes automatically.
- Set the printer to pick up calls two rings after the answering machine. For example, if the answering machine picks up calls after four rings, then set the printer Rings to Answer setting to **6**.

## Setting up fax in countries or regions with different telephone wall jacks and plugs

**Note:** These instructions apply only to printers that support analog fax. For more information, see [“Supported fax” on page 24](#).

**⚠ CAUTION—SHOCK HAZARD:** To avoid the risk of electrical shock, do not set up this product or make any electrical or cabling connections, such as the power cord, fax feature, or telephone, during a lightning storm.

**CAUTION—SHOCK HAZARD:** To avoid the risk of electrical shock, do not use the fax feature during a lightning storm.

**CAUTION—POTENTIAL INJURY:** To reduce the risk of fire, use only a 26 AWG or larger telecommunications (RJ-11) cord when connecting this product to the public switched telephone network. For users in Australia, the cord must be approved by the Australian Communications and Media Authority.

The standard wall jack adopted by most countries or regions is RJ-11. If the wall jack or equipment in your facility is not compatible with this type of connection, then use a telephone adapter. An adapter for your country or region may not come with your printer, and you may need to purchase it separately.

There may be an adapter plug installed in the telephone port of the printer. Do not remove the adapter plug from the telephone port of the printer if you are connecting to a serial or cascaded telephone system.

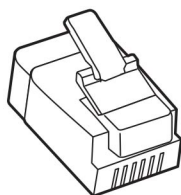

| Part name            | Part number |
|----------------------|-------------|
| Lexmark adapter plug | 40X8519     |

## Connecting the printer to a non-RJ-11 wall jack

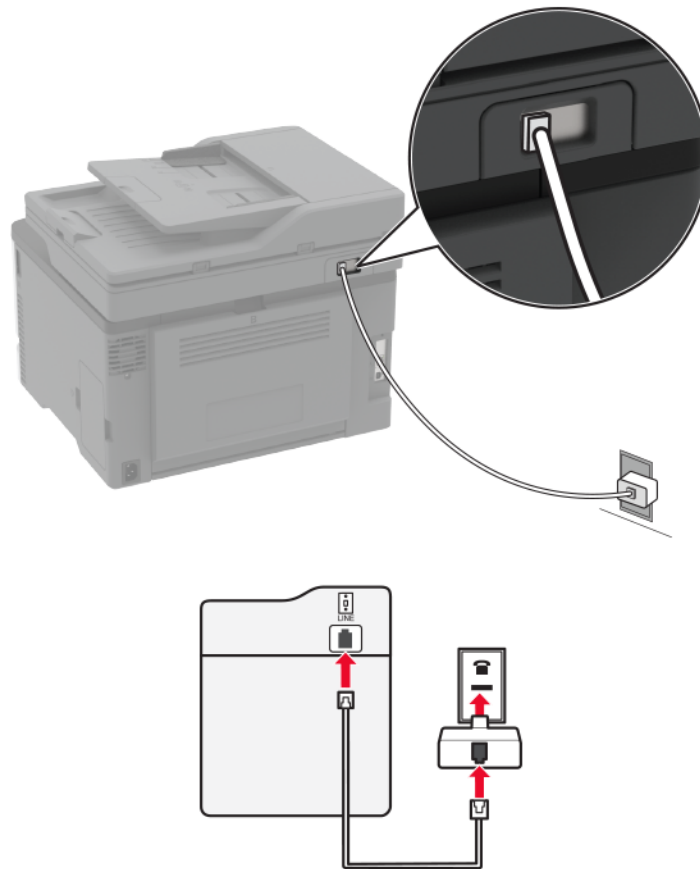

- 1 Connect one end of the telephone cable to the line port of the printer.
- 2 Connect the other end of the cable to the RJ-11 adapter, and then connect the adapter to the wall jack.
- 3 If you want to connect another device with a non-RJ-11 connector to the same wall jack, then connect it directly to the telephone adapter.

## Connecting to a distinctive ring service

A distinctive ring service lets you have multiple telephone numbers on one telephone line. Each telephone number is assigned a different ring pattern.

**Note:** These instructions apply only to printers that support analog fax. For more information, see [“Supported fax” on page 24](#).

- 1 From the home screen, touch **Settings > Fax > Fax Setup > Fax Receive Settings > Admin Controls > Answer On**.
- 2 Select a ring pattern.

## Setting the fax date and time

**Note:** Make sure that fax is configured. For more information, see [“Setting up the printer to fax” on page 24](#).

- 1 From the home screen, touch **Settings > Device > Preferences > Date and Time > Configure**.
- 2 Configure the settings.

## Configuring daylight saving time

**Note:** Make sure that fax is configured. For more information, see [“Setting up the printer to fax” on page 24](#).

- 1 From the home screen, touch **Settings > Device > Preferences > Date and Time > Configure**.
- 2 In the Time Zone menu, select **(UTC+user) Custom**.
- 3 Configure the settings.

## Configuring the fax speaker settings

**Note:** Make sure that fax is configured. For more information, see [“Setting up the printer to fax” on page 24](#).

- 1 From the home screen, touch **Settings > Fax > Fax Setup > Speaker Settings**.
- 2 Do the following:
  - Set Speaker Mode to **Always On**.
  - Set Speaker Volume to **High**.
  - Enable Ringer Volume.

## Configuring the e-mail SMTP settings

Configure the Simple Mail Transfer Protocol (SMTP) settings to send a scanned document through e-mail. The settings vary with each e-mail service provider. For more information, see [e-mail service providers](#).

Before you begin, make sure that the printer is connected to a network and that the network is connected to the Internet.

### Using the Embedded Web Server

- 1 Open a web browser, and then type the printer IP address in the address field.

**Notes:**

- View the printer IP address on the printer home screen. The IP address appears as four sets of numbers separated by periods, such as 123.123.123.123.
- If you are using a proxy server, then temporarily disable it to load the web page correctly.

- 2 Click **Settings > E-mail**.

- 3 From the E-mail Setup section, configure the settings.

**Notes:**

- For more information on the password, see the list of [e-mail service providers](#).



- For e-mail service providers that are not on the list, contact your provider and ask for the settings.

**4** Click **Save**.

## Using the e-mail setup wizard in the printer

**Note:** Before using the wizard, make sure that the printer firmware is updated. For more information, see [“Updating firmware” on page 46](#).

- 1** From the home screen, touch **E-mail**.
- 2** Touch **Set up now**, and then type your e-mail address.
- 3** Type the password.

### Notes:

- Depending on your e-mail service provider, type your account password, app password, or authentication password. For more information on the password, see the list of [e-mail service providers](#), and then look for Device Password.
- If your provider is not listed, then contact your provider and ask for the Primary SMTP Gateway, Primary SMTP Gateway Port, Use SSL/TLS, and SMTP Server Authentication settings. Proceed with the setup after getting the settings.

**4** Touch **OK**.

## Using the Settings menu in the printer

- 1** From the home screen, touch **Settings** > **E-mail** > **E-mail Setup**.
- 2** Configure the settings.

### Notes:

- For more information on the password, see the list of [e-mail service providers](#).
- For e-mail service providers that are not on the list, contact your provider and ask for the settings.

## E-mail service providers

- [AOL Mail](#)
- [Comcast Mail](#)
- [Gmail](#)
- [iCloud Mail](#)
- [Mail.com](#)
- [NetEase Mail \(mail.126.com\)](#)
- [NetEase Mail \(mail.163.com\)](#)
- [NetEase Mail \(mail.yeah.net\)](#)
- [Outlook Live or Microsoft 365](#)
- [QQ Mail](#)
- [Sina Mail](#)
- [Sohu Mail](#)
- [Yahoo! Mail](#)
- [Zoho Mail](#)

**Notes:**

- If you encounter errors using the settings provided, then contact your e-mail service provider.
- For e-mail service providers that are not on the list, contact your provider.

**AOL Mail**

| Setting                            | Value  |
|------------------------------------|--|
| <b>Primary SMTP Gateway</b>        | smtp.aol.com   |
| <b>Primary SMTP Gateway Port</b>   | 587  |
| <b>Use SSL/TLS</b>                 | Required   |
| <b>Require Trusted Certificate</b> | Disabled   |
| <b>Reply Address</b>               | Your e-mail address  |
| <b>SMTP Server Authentication</b>  | Login / Plain  |
| <b>Device-Initiated E-mail</b>     | Use Device SMTP Credentials  |
| <b>Device UserID</b>               | Your e-mail address  |
| <b>Device Password</b>             | App password<br><b>Note:</b> To create an app password, go to the <a href="#">AOL Account Security</a> page, log in to your account, and then click <b>Generate app password</b> . |

**Comcast Mail**

| Setting                            | Value                       |
|------------------------------------|-----------------------------|
| <b>Primary SMTP Gateway</b>        | smtp.comcast.net            |
| <b>Primary SMTP Gateway Port</b>   | 587                         |
| <b>Use SSL/TLS</b>                 | Required                    |
| <b>Require Trusted Certificate</b> | Disabled                    |
| <b>Reply Address</b>               | Your e-mail address         |
| <b>SMTP Server Authentication</b>  | Login / Plain               |
| <b>Device-Initiated E-mail</b>     | Use Device SMTP Credentials |
| <b>Device UserID</b>               | Your e-mail address         |
| <b>Device Password</b>             | Account password            |

**Gmail™**

**Note:** Make sure that two-step verification is enabled on your Google account. To enable two-step verification, go to the [Google Account Security](#) page, log in to your account, and then from the “Signing in to Google” section, click **2-Step Verification**.

| Setting                          | Value          |
|----------------------------------|----------------|
| <b>Primary SMTP Gateway</b>      | smtp.gmail.com |
| <b>Primary SMTP Gateway Port</b> | 587            |

| Setting                            | Value   |
|------------------------------------|---|
| <b>Use SSL/TLS</b>                 | Required  |
| <b>Require Trusted Certificate</b> | Disabled  |
| <b>Reply Address</b>               | Your e-mail address   |
| <b>SMTP Server Authentication</b>  | Login / Plain   |
| <b>Device-Initiated E-mail</b>     | Use Device SMTP Credentials   |
| <b>Device UserID</b>               | Your e-mail address   |
| <b>Device Password</b>             | App password<br><br><b>Notes:</b> <ul style="list-style-type: none"> <li>To create an app password, go to the <a href="#">Google Account Security</a> page, log in to your account, and then from the “Signing in to Google” section, click <b>App passwords</b>.</li> <li>“App passwords” shows only if two-step verification is enabled.</li> </ul> |

## iCloud Mail

**Note:** Make sure that two-step verification is enabled on your account.

| Setting                            | Value  |
|------------------------------------|--|
| <b>Primary SMTP Gateway</b>        | smtp.mail.me.com   |
| <b>Primary SMTP Gateway Port</b>   | 587  |
| <b>Use SSL/TLS</b>                 | Required   |
| <b>Require Trusted Certificate</b> | Disabled   |
| <b>Reply Address</b>               | Your e-mail address  |
| <b>SMTP Server Authentication</b>  | Login / Plain  |
| <b>Device-Initiated E-mail</b>     | Use Device SMTP Credentials  |
| <b>Device UserID</b>               | Your e-mail address  |
| <b>Device Password</b>             | App password<br><br><b>Note:</b> To create an app password, go to the <a href="#">iCloud Account Management</a> page, log in to your account, and then from the Security section, click <b>Generate Password</b> . |

## Mail.com

| Setting                            | Value               |
|------------------------------------|---------------------|
| <b>Primary SMTP Gateway</b>        | smtp.mail.com       |
| <b>Primary SMTP Gateway Port</b>   | 587                 |
| <b>Use SSL/TLS</b>                 | Required            |
| <b>Require Trusted Certificate</b> | Disabled            |
| <b>Reply Address</b>               | Your e-mail address |

| Setting                           | Value                       |
|-----------------------------------|-----------------------------|
| <b>SMTP Server Authentication</b> | Login / Plain               |
| <b>Device-Initiated E-mail</b>    | Use Device SMTP Credentials |
| <b>Device UserID</b>              | Your e-mail address         |
| <b>Device Password</b>            | Account password            |

### NetEase Mail (mail.126.com)

**Note:** Make sure that the SMTP service is enabled on your account. To enable the service, from the NetEase Mail home page, click **Settings** > **POP3/SMTP/IMAP**, and then enable either **IMAP/SMTP service** or **POP3/SMTP service**.

| Setting                            | Value   |
|------------------------------------|---|
| <b>Primary SMTP Gateway</b>        | smtp.126.com  |
| <b>Primary SMTP Gateway Port</b>   | 465   |
| <b>Use SSL/TLS</b>                 | Required  |
| <b>Require Trusted Certificate</b> | Disabled  |
| <b>Reply Address</b>               | Your e-mail address   |
| <b>SMTP Server Authentication</b>  | Login / Plain   |
| <b>Device-Initiated E-mail</b>     | Use Device SMTP Credentials   |
| <b>Device UserID</b>               | Your e-mail address   |
| <b>Device Password</b>             | Authorization password<br><b>Note:</b> The authorization password is provided when IMAP/SMTP service or POP3/SMTP service is enabled. |

### NetEase Mail (mail.163.com)

**Note:** Make sure that the SMTP service is enabled on your account. To enable the service, from the NetEase Mail home page, click **Settings** > **POP3/SMTP/IMAP**, and then enable either **IMAP/SMTP service** or **POP3/SMTP service**.

| Setting                            | Value                       |
|------------------------------------|-----------------------------|
| <b>Primary SMTP Gateway</b>        | smtp.163.com                |
| <b>Primary SMTP Gateway Port</b>   | 465                         |
| <b>Use SSL/TLS</b>                 | Required                    |
| <b>Require Trusted Certificate</b> | Disabled                    |
| <b>Reply Address</b>               | Your e-mail address         |
| <b>SMTP Server Authentication</b>  | Login / Plain               |
| <b>Device-Initiated E-mail</b>     | Use Device SMTP Credentials |
| <b>Device UserID</b>               | Your e-mail address         |

| Setting                | Value   |
|------------------------|---|
| <b>Device Password</b> | Authorization password<br><b>Note:</b> The authorization password is provided when IMAP/SMTP service or POP3/SMTP service is enabled. |

### NetEase Mail (mail.yeah.net)

**Note:** Make sure that the SMTP service is enabled on your account. To enable the service, from the NetEase Mail home page, click **Settings** > **POP3/SMTP/IMAP**, and then enable either **IMAP/SMTP service** or **POP3/SMTP service**.

| Setting                            | Value   |
|------------------------------------|---|
| <b>Primary SMTP Gateway</b>        | smtp.yeah.net   |
| <b>Primary SMTP Gateway Port</b>   | 465   |
| <b>Use SSL/TLS</b>                 | Required  |
| <b>Require Trusted Certificate</b> | Disabled  |
| <b>Reply Address</b>               | Your e-mail address   |
| <b>SMTP Server Authentication</b>  | Login / Plain   |
| <b>Device-Initiated E-mail</b>     | Use Device SMTP Credentials   |
| <b>Device UserID</b>               | Your e-mail address   |
| <b>Device Password</b>             | Authorization password<br><b>Note:</b> The authorization password is provided when IMAP/SMTP service or POP3/SMTP service is enabled. |

### Outlook Live or Microsoft 365

These settings apply to outlook.com, hotmail.com e-mail domains, and Microsoft 365 accounts.

| Setting                            | Value                       |
|------------------------------------|-----------------------------|
| <b>Primary SMTP Gateway</b>        | smtp.office365.com          |
| <b>Primary SMTP Gateway Port</b>   | 587                         |
| <b>Use SSL/TLS</b>                 | Required                    |
| <b>Require Trusted Certificate</b> | Disabled                    |
| <b>Reply Address</b>               | Your e-mail address         |
| <b>SMTP Server Authentication</b>  | Login / Plain               |
| <b>Device-Initiated E-mail</b>     | Use Device SMTP Credentials |
| <b>Device UserID</b>               | Your e-mail address         |

| Setting                | Value  |
|------------------------|--|
| <b>Device Password</b> | Account password or app password<br><br><b>Notes:</b> <ul style="list-style-type: none"> <li>• For accounts with two-step verification disabled, use your account password.</li> <li>• For outlook.com or hotmail.com accounts with two-step verification enabled, use an app password. To create an app password, go to the <a href="#">Outlook Live Account Management</a> page, and then log in to your account.</li> </ul> |

**Note:** For additional setup options for business using Microsoft 365, go to the [Microsoft 365 help page](#).

## QQ Mail

**Note:** Make sure that the SMTP service is enabled on your account. To enable the service, from the QQ Mail home page, click **Settings > Account**. From the POP3/IMAP/SMTP/Exchange/CardDAV/CalDAV Service section, enable either **POP3/SMTP service** or **IMAP/SMTP service**.

| Setting                            | Value   |
|------------------------------------|---|
| <b>Primary SMTP Gateway</b>        | smtp.qq.com   |
| <b>Primary SMTP Gateway Port</b>   | 587   |
| <b>Use SSL/TLS</b>                 | Required  |
| <b>Require Trusted Certificate</b> | Disabled  |
| <b>Reply Address</b>               | Your e-mail address   |
| <b>SMTP Server Authentication</b>  | Login / Plain   |
| <b>Device-Initiated E-mail</b>     | Use Device SMTP Credentials   |
| <b>Device UserID</b>               | Your e-mail address   |
| <b>Device Password</b>             | Authorization code<br><br><b>Note:</b> To generate an authorization code, from the QQ Mail home page, click <b>Settings &gt; Account</b> , and then from the POP3/IMAP/SMTP/Exchange/CardDAV/CalDAV Service section, click <b>Generate authorization code</b> . |

## Sina Mail

**Note:** Make sure that the POP3/SMTP service is enabled on your account. To enable the service, from the Sina Mail home page, click **Settings > More settings > User-end POP/IMAP/SMTP**, and then enable **POP3/SMTP service**.

| Setting                            | Value         |
|------------------------------------|---------------|
| <b>Primary SMTP Gateway</b>        | smtp.sina.com |
| <b>Primary SMTP Gateway Port</b>   | 587           |
| <b>Use SSL/TLS</b>                 | Required      |
| <b>Require Trusted Certificate</b> | Disabled      |

| Setting                           | Value  |
|-----------------------------------|--|
| <b>Reply Address</b>              | Your e-mail address  |
| <b>SMTP Server Authentication</b> | Login / Plain  |
| <b>Device-Initiated E-mail</b>    | Use Device SMTP Credentials  |
| <b>Device UserID</b>              | Your e-mail address  |
| <b>Device Password</b>            | Authorization code<br><b>Note:</b> To create an authorization code, from the e-mail home page, click <b>Settings &gt; More settings &gt; User-end POP/IMAP/SMTP</b> , and then enable <b>Authorization code status</b> . |

### Sohu Mail

**Note:** Make sure that the SMTP service is enabled on your account. To enable the service, from the Sohu Mail home page, click **Options > Settings > POP3/SMTP/IMAP**, and then enable either **IMAP/SMTP service** or **POP3/SMTP service**.

| Setting                            | Value   |
|------------------------------------|---|
| <b>Primary SMTP Gateway</b>        | smtp.sohu.com   |
| <b>Primary SMTP Gateway Port</b>   | 465   |
| <b>Use SSL/TLS</b>                 | Required  |
| <b>Require Trusted Certificate</b> | Disabled  |
| <b>Reply Address</b>               | Your e-mail address   |
| <b>SMTP Server Authentication</b>  | Login / Plain   |
| <b>Device-Initiated E-mail</b>     | Use Device SMTP Credentials   |
| <b>Device UserID</b>               | Your e-mail address   |
| <b>Device Password</b>             | Independent password<br><b>Note:</b> The independent password is provided when IMAP/SMTP service or POP3/SMTP service is enabled. |

### Yahoo! Mail

| Setting                            | Value                       |
|------------------------------------|-----------------------------|
| <b>Primary SMTP Gateway</b>        | smtp.mail.yahoo.com         |
| <b>Primary SMTP Gateway Port</b>   | 587                         |
| <b>Use SSL/TLS</b>                 | Required                    |
| <b>Require Trusted Certificate</b> | Disabled                    |
| <b>Reply Address</b>               | Your e-mail address         |
| <b>SMTP Server Authentication</b>  | Login / Plain               |
| <b>Device-Initiated E-mail</b>     | Use Device SMTP Credentials |
| <b>Device UserID</b>               | Your e-mail address         |

| Setting                | Value  |
|------------------------|--|
| <b>Device Password</b> | App password<br><b>Note:</b> To create an app password, go to the <a href="#">Yahoo Account Security</a> page, log in to your account, and then click <b>Generate app password</b> . |

## Zoho Mail

| Setting                            | Value   |
|------------------------------------|---|
| <b>Primary SMTP Gateway</b>        | smtp.zoho.com   |
| <b>Primary SMTP Gateway Port</b>   | 587   |
| <b>Use SSL/TLS</b>                 | Required  |
| <b>Require Trusted Certificate</b> | Disabled  |
| <b>Reply Address</b>               | Your e-mail address   |
| <b>SMTP Server Authentication</b>  | Login / Plain   |
| <b>Device-Initiated E-mail</b>     | Use Device SMTP Credentials   |
| <b>Device UserID</b>               | Your e-mail address   |
| <b>Device Password</b>             | Account password or app password<br><b>Notes:</b> <ul style="list-style-type: none"> <li>• For accounts with two-step verification disabled, use your account password.</li> <li>• For accounts with two-step verification enabled, use an app password. To create an app password, go to the <a href="#">Zoho Mail Account Security</a> page, log in to your account, and then from the Application-Specific Passwords section, click <b>Generate New Password</b>.</li> </ul> |

## Loading paper and specialty media

### Setting the paper size and type

- 1 From the home screen, navigate to:  
**Settings > Paper > Tray Configuration > Paper Size/Type** > select a paper source
- 2 Set the paper size and type.

### Configuring Universal paper settings

- 1 From the home screen, touch **Settings > Paper > Media Configuration > Universal Setup**.
- 2 Configure the settings.



## Loading trays

**CAUTION—TIPPING HAZARD:** To reduce the risk of equipment instability, load each tray separately. Keep all other trays closed until needed.

**1** Remove the tray.

**Note:** To avoid paper jams, do not remove trays while the printer is busy.



**2** Flex, fan, and align the paper edges before loading.

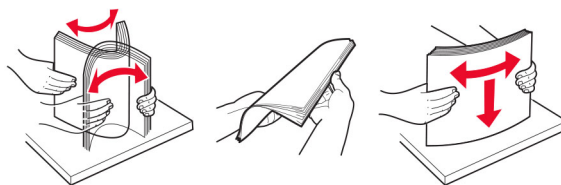

**3** Load the paper stack with the printable side faceup.



### Notes:

- Load letterhead faceup with the header toward the back of the tray for one-sided printing.
- Load letterhead facedown with the header toward the front of the tray for two-sided printing.
- Do not slide paper into the tray.
- To avoid paper jams, make sure that the stack height is below the maximum paper fill indicator.

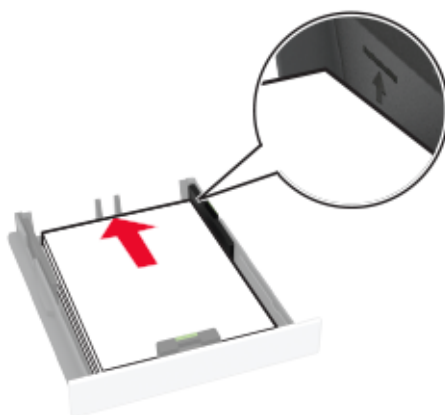

**4** Adjust the guides to match the size of the paper that you are loading.

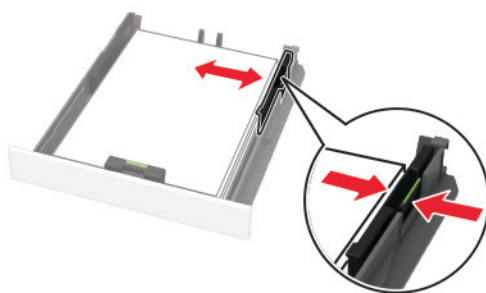
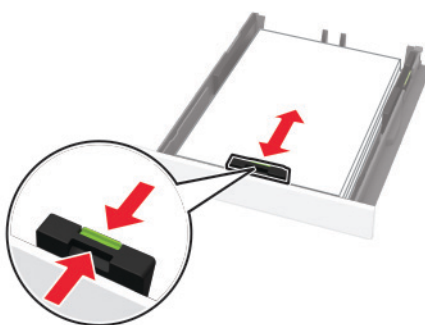

**5** Insert the tray.

If necessary, set the paper size and paper type from the control panel to match the paper loaded.

## Loading the manual feeder

- 1 Adjust the guide to match the size of the paper that you are loading.

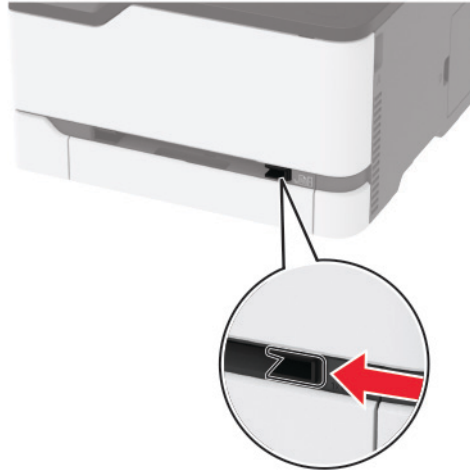

- 2 Load a sheet of paper with the printable side faceup.

- Load letterhead with the printable side faceup and the top edge entering the printer first for one-sided printing.

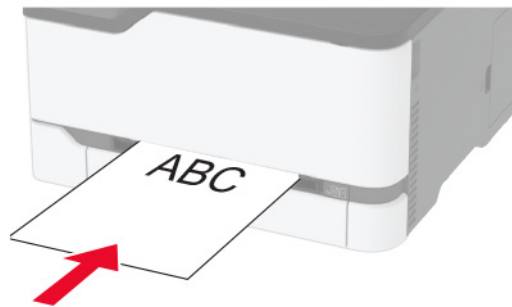

- Load letterhead with the printable side facedown and the top edge entering the printer last for two-sided printing.



- Load envelope with the flap side down and against the right side of the paper guide.



**3** Feed the paper until its leading edge gets pulled in.

**Notes:**

- To avoid paper jams, do not force paper into the manual feeder.
- Before loading another sheet, wait for a message to appear on the display.

## Linking trays

- 1** From the home screen, touch **Settings > Paper > Tray Configuration** > select a paper source.
- 2** Set the same paper size and paper type for the trays that you are linking.
- 3** From the home screen, touch **Settings > Device > Maintenance > Config Menu > Tray Configuration > Tray Linking**.
- 4** Touch **Automatic**.

To unlink trays, make sure that no trays have the same paper size and paper type settings.

**Warning—Potential Damage:** The temperature of the fuser varies according to the specified paper type. To avoid printing issues, match the paper type setting in the printer with the paper loaded in the tray.

# Installing and updating software, drivers, and firmware

## Installing the printer software

**Notes:**

- The print driver is included in the software installer package.
  - For Macintosh computers with macOS version 10.7 or later, you do not need to install the driver to print on an AirPrint-certified printer. If you want custom printing features, then download the print driver.
- 1** Obtain a copy of the software installer package.
    - From the software CD that came with your printer.
    - Go to [www.lexmark.com/downloads](http://www.lexmark.com/downloads).
  - 2** Run the installer, and then follow the instructions on the computer screen.

## Installing the fax driver

- 1 Go to [www.lexmark.com/downloads](http://www.lexmark.com/downloads), search for your printer model, and then download the appropriate installer package.
- 2 From your computer, click **Printer Properties**, and then navigate to the **Configuration** tab.
- 3 Select **Fax**, and then click **Apply**.

## Adding printers to a computer

Before you begin, do one of the following:

- Connect the printer and the computer to the same network. For more information on connecting the printer to a network, see [“Connecting the printer to a Wi-Fi network” on page 49](#).
- Connect the computer to the printer. For more information, see [“Connecting a computer to the printer” on page 52](#).
- Connect the printer to the computer using a USB cable. For more information, see [“Attaching cables” on page 21](#).

**Note:** The USB cable is sold separately.

### For Windows users

- 1 From a computer, install the print driver.  
**Note:** For more information, see [“Installing the printer software” on page 44](#).
- 2 Open **Printers & scanners**, and then click **Add a printer or scanner**.
- 3 Depending on your printer connection, do one of the following:
  - Select a printer from the list, and then click **Add device**.
  - Click **Show Wi-Fi Direct printers**, select a printer, and then click **Add device**.
  - Click **The printer that I want isn't listed**, and then from the Add Printer window, do the following:
    - a Select **Add a printer using a TCP/IP address or hostname**, and then click **Next**.
    - b In the “Hostname or IP address” field, type the printer IP address, and then click **Next**.

#### Notes:

- View the printer IP address on the printer home screen. The IP address appears as four sets of numbers separated by periods, such as 123.123.123.123.
  - If you are using a proxy server, then temporarily disable it to load the web page correctly.
- c Select a print driver, and then click **Next**.
  - d Select **Use the print driver that is currently installed (recommended)**, and then click **Next**.
  - e Type a printer name, and then click **Next**.
  - f Select a printer sharing option, and then click **Next**.
  - g Click **Finish**.

### For Macintosh users

- 1 From a computer, open **Printers & Scanners**.
- 2 Click **+**, and then select a printer.
- 3 From the Use menu, select a print driver.

**Notes:**

- To use the Macintosh print driver, select either **AirPrint** or **Secure AirPrint**.
- If you want custom printing features, then select the Lexmark print driver. To install the driver, see [“Installing the printer software” on page 44](#).

4 Add the printer.

## Updating firmware

Some applications require a minimum device firmware level to operate correctly.

For more information on updating the device firmware, contact your Lexmark representative.

1 Open a web browser, and then type the printer IP address in the address field.

**Notes:**

- View the printer IP address on the printer home screen. The IP address appears as four sets of numbers separated by periods, such as 123.123.123.123.
- If you are using a proxy server, then temporarily disable it to load the web page correctly.

2 Click **Settings > Device > Update Firmware**.

3 Do either of the following:

- Click **Check for updates > I agree, start update**.
- Upload the flash file.

**Note:** To get the latest firmware, go to [www.lexmark.com/downloads](http://www.lexmark.com/downloads), and then search for your printer model.

a Browse to the flash file.

**Note:** Make sure that you have extracted the firmware zip file.

b Click **Upload > Start**.

## Exporting or importing a configuration file

You can export the configuration settings of your printer into a text file, and then import the file to apply the settings to other printers.

1 Open a web browser, and then type the printer IP address in the address field.

**Notes:**

- View the printer IP address on the printer home screen. The IP address appears as four sets of numbers separated by periods, such as 123.123.123.123.
- If you are using a proxy server, then temporarily disable it to load the web page correctly.

2 From the Embedded Web Server, click **Export Configuration** or **Import Configuration**.

3 Follow the instructions on the screen.

4 If the printer supports applications, then do the following:

a Click **Apps >** select the application **> Configure**.

b Click **Export** or **Import**.

## Adding available options in the print driver

### For Windows users

- 1 Open the printers folder.
- 2 Select the printer you want to update, and then do either of the following:
  - For Windows 7 or later, select **Printer properties**.
  - For earlier versions, select **Properties**.
- 3 Navigate to the Configuration tab, and then select **Update Now - Ask Printer**.
- 4 Apply the changes.

### For Macintosh users

- 1 From System Preferences in the Apple menu, navigate to your printer, and then select **Options & Supplies**.
- 2 Navigate to the list of hardware options, and then add any installed options.
- 3 Apply the changes.

## Available options

MarkNet™ N8372 802.11a/b/g/n/ac Wireless Print Server Interface Card

**Note:** Supported only in the Lexmark MC3426adwe printer model.

## Networking

### Installing the wireless print server

- 1 Turn off the printer.
- 2 Install the adapter.





- 3 Attach the NFC card.



- 4 Turn on the printer.

## Connecting the printer to a Wi-Fi network

Before you begin, make sure that:

- Active Adapter is set to Auto. From the home screen, touch **Settings** > **Network/Ports** > **Network Overview** > **Active Adapter**.
- The Ethernet cable is not connected to the printer.

### Using the wireless setup wizard in the printer

Before using the wizard, make sure that the printer firmware is updated. For more information, see [“Updating firmware” on page 46](#).

- 1 From the home screen, touch  > **Set up now**.
- 2 Select a Wi-Fi network, and then type the network password.
- 3 Touch **Done**.

### Using the Settings menu in the printer

- 1 From the home screen, touch **Settings** > **Network/Ports** > **Wireless** > **Setup On Printer Panel** > **Choose Network**.
- 2 Select a Wi-Fi network, and then type the network password.

**Note:** For Wi-Fi-network-ready printer models, a prompt to set up the Wi-Fi network appears during initial setup.

## Using Lexmark Mobile Assistant

- 1 Depending on your mobile device, download the Lexmark Mobile Assistant app from either Google Play™ or App Store.
- 2 From the printer home screen, touch **Settings > Network/Ports > Wireless > Setup Using Mobile App > Printer ID**.
- 3 From your mobile device, launch the app, and then accept the Terms of Use.  
**Note:** If necessary, grant permissions.
- 4 Tap **Connect to Printer > Go to Wi-Fi Settings**.
- 5 Connect your mobile device to the printer wireless network.
- 6 Return to the app, and then tap **Setup Wi-Fi Connection**.
- 7 Select a Wi-Fi network, and then type the network password.
- 8 Tap **Done**.

## Connecting the printer to a wireless network using Wi-Fi Protected Setup (WPS)

Before you begin, make sure that:

- The access point (wireless router) is WPS-certified or WPS-compatible. For more information, see the documentation that came with your access point.
- A wireless network adapter is installed in your printer. For more information, see the instructions that came with the adapter.
- Active Adapter is set to Auto. From the home screen, touch **Settings > Network/Ports > Network Overview > Active Adapter**.

### Using the Push Button method

- 1 From the home screen, touch **Settings > Network/Ports > Wireless > Wi-Fi Protected Setup > Start Push Button Method**.
- 2 Follow the instructions on the display.

### Using the personal identification number (PIN) method

- 1 From the home screen, touch **Settings > Network/Ports > Wireless > Wi-Fi Protected Setup > Start PIN Method**.
- 2 Copy the eight-digit WPS PIN.
- 3 Open a web browser, and then type the IP address of your access point in the address field.

#### Notes:

- To know the IP address, see the documentation that came with your access point.
  - If you are using a proxy server, then temporarily disable it to load the web page correctly.
- 4 Access the WPS settings. For more information, see the documentation that came with your access point.
  - 5 Enter the eight-digit PIN, and then save the changes.

## Configuring Wi-Fi Direct

Wi-Fi Direct® is a Wi-Fi-based peer-to-peer technology that allows wireless devices to connect directly to a Wi-Fi Direct-enabled printer without using an access point (wireless router).

**1** From the home screen, touch **Settings > Network/Ports > Wi-Fi Direct**.

**2** Configure the settings.

- **Enable Wi-Fi Direct**—Enables the printer to broadcast its own Wi-Fi Direct network.
- **Wi-Fi Direct Name**—Assigns a name for the Wi-Fi Direct network.
- **Wi-Fi Direct Password**—Assigns the password for negotiating the wireless security when using the peer-to-peer connection.
- **Show Password on Setup Page**—Shows the password on the Network Setup Page.
- **Auto-Accept Push Button Requests**—Lets the printer accept connection requests automatically.

**Note:** Accepting push-button requests automatically is not secured.

### Notes:

- By default, the Wi-Fi Direct network password is not visible on the printer display. To show the password, enable the password peek icon. From the home screen, touch **Settings > Security > Miscellaneous > Enable Password/PIN Reveal**.
- To know the password of the Wi-Fi Direct network without showing it on the printer display, from the home screen touch **Settings > Reports > Network > Network Setup Page**.

## Connecting a mobile device to the printer

Before connecting your mobile device, make sure that Wi-Fi Direct has been configured. For more information, see [“Configuring Wi-Fi Direct” on page 51](#).

### Connecting using Wi-Fi Direct

**Note:** These instructions apply only to Android mobile devices.

- 1** From the mobile device, go to the settings menu.
- 2** Enable **Wi-Fi**, and then tap **Wi-Fi Direct**.
- 3** Select the printer Wi-Fi Direct name.
- 4** Confirm the connection on the printer control panel.

### Connecting using Wi-Fi

- 1** From the mobile device, go to the settings menu.
- 2** Tap **Wi-Fi**, and then select the printer Wi-Fi Direct name.

**Note:** The string DIRECT-xy (where x and y are two random characters) is added before the Wi-Fi Direct name.

- 3** Enter the Wi-Fi Direct password.

## Connecting a computer to the printer

Before connecting your computer, make sure that Wi-Fi Direct has been configured. For more information, see [“Configuring Wi-Fi Direct” on page 51](#).

### For Windows users

- 1 Open **Printers & scanners**, and then click **Add a printer or scanner**.
- 2 Click **Show Wi-Fi Direct printers**, and then select the printer Wi-Fi Direct name.
- 3 From the printer display, take note of the eight-digit PIN of the printer.
- 4 Enter the PIN on the computer.

**Note:** If the print driver is not already installed, then Windows downloads the appropriate driver.

### For Macintosh users

- 1 Click the wireless icon, and then select the printer Wi-Fi Direct name.

**Note:** The string DIRECT-xy (where x and y are two random characters) is added before the Wi-Fi Direct name.

- 2 Type the Wi-Fi Direct password.

**Note:** Switch your computer back to its previous network after disconnecting from the Wi-Fi Direct network.

## Deactivating the Wi-Fi network

- 1 From the home screen, touch **Settings > Network/Ports > Network Overview > Active Adapter > Standard Network**.
- 2 Follow the instructions on the display.

## Checking the printer connectivity

- 1 From the home screen, touch **Settings > Reports > Network > Network Setup Page**.
- 2 Check the first section of the network setup page, and confirm that the status is connected.  
If the status is not connected, then the LAN drop may be inactive, or the network cable may be malfunctioning. Contact your administrator for assistance.

## Printing the Menu Settings Page

From the home screen, touch **Settings > Reports > Menu Settings Page**.

# Secure the printer

## Erasing printer memory

To erase volatile memory or buffered data in your printer, turn off the printer.

To erase non-volatile memory or individual settings, device and network settings, security settings, and embedded solutions, do the following:

- 1 From the home screen, touch **Settings** > **Device** > **Maintenance** > **Out of Service Erase**.
- 2 Select the **Sanitize all information on nonvolatile memory** check box, and then touch **OK**.
- 3 Select either **Start initial setup** or **Leave printer offline**, and then touch **OK**.

## Restoring factory default settings

- 1 From the home screen, touch **Settings** > **Device** > **Restore Factory Defaults**.
- 2 In the Restore Settings menu, select the settings that you want to restore.
- 3 Touch **RESTORE**.
- 4 Follow the instructions on the display.

## Statement of Volatility

Your printer contains various types of memory that can store device and network settings, and user data.

| Type of memory      | Description   |
|---------------------|---|
| Volatile memory     | Your printer uses standard <i>random access memory</i> (RAM) to temporarily buffer user data during simple print jobs.  |
| Non-volatile memory | Your printer may use two forms of non-volatile memory: EEPROM and NAND (flash memory). Both types are used to store operating system, device settings, and network information. |

Erase the content of any installed printer memory in the following circumstances:

- The printer is being decommissioned.
- The printer is being moved to a different department or location.
- The printer is being serviced by someone from outside your organization.
- The printer is being removed from your premises for service.
- The printer is being sold to another organization.

# Print

## Printing from a computer

**Note:** For labels, card stock, and envelopes, set the paper size and type in the printer before printing the document.

- 1 From the document that you are trying to print, open the Print dialog.
- 2 If necessary, adjust the settings.
- 3 Print the document.

## Printing from a mobile device

### Printing from a mobile device using Lexmark Mobile Print

Lexmark™ Mobile Print allows you to send documents and images directly to a supported Lexmark printer.

- 1 Open the document, and then send or share the document to Lexmark Mobile Print.



**Note:** Some third-party applications may not support the send or share feature. For more information, see the documentation that came with the application.

- 2 Select a printer.
- 3 Print the document.

### Printing from a mobile device using Mopria Print Service

Mopria® Print Service is a mobile printing solution for mobile devices running on Android™ version 5.0 or later. It allows you to print directly to any Mopria-certified printer.

**Note:** Make sure that you download the Mopria Print Service application from the Google Play™ store and enable it in the mobile device.

- 1 From your Android mobile device, launch a compatible application or select a document from your file manager.
- 2 Tap  > **Print**.
- 3 Select a printer, and then adjust the settings, if necessary.
- 4 Tap .

### Printing from a mobile device using AirPrint

The AirPrint software feature is a mobile printing solution that allows you to print directly from Apple devices to an AirPrint-certified printer.

**Notes:**

- Make sure that the Apple device and the printer are connected to the same network. If the network has multiple wireless hubs, then make sure that both devices are connected to the same subnet.
- This application is supported only in some Apple devices.

**1** From your mobile device, select a document from your file manager or launch a compatible application.

**2** Tap  > **Print**.

**3** Select a printer, and then adjust the settings, if necessary.

**4** Print the document.



## Printing from a mobile device using Wi-Fi Direct®

Wi-Fi Direct® is a printing service that lets you print to any Wi-Fi Direct-ready printer.

**Note:** Make sure that the mobile device is connected to the printer wireless network. For more information, see [“Connecting a mobile device to the printer” on page 51](#).

**1** From your mobile device, launch a compatible application or select a document from your file manager.

**2** Depending on your mobile device, do one of the following:

- Tap  > **Print**.
- Tap  > **Print**.
- Tap  > **Print**.

**3** Select a printer, and then adjust the settings, if necessary.

**4** Print the document.

## Printing from a flash drive

This feature is available only in some printer models.

**1** Insert the flash drive.

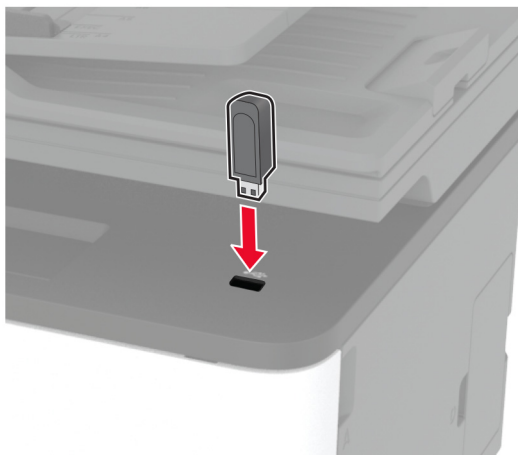

**Notes:**

- If you insert the flash drive when an error message appears, then the printer ignores the flash drive.
- If you insert the flash drive while the printer is processing other print jobs, then **Busy** appears on the display.

**2** Select the document that you want to print.

If necessary, configure other print settings.

**3** Print the document.

To print another document, select **USB Drive**.

**Warning—Potential Damage:** To avoid loss of data or printer malfunction, do not touch the flash drive or the printer in the area shown while actively printing, reading, or writing from the memory device.



## Supported flash drives and file types

### Flash drives

- Lexar JumpDrive S70 (16GB and 32GB)
- SanDisk Cruzer (16GB and 32GB)
- PNY Attaché (16GB and 32GB)

**Notes:**

- The printer supports high-speed USB flash drives with full-speed standard.
- USB flash drives must support the File Allocation Table (FAT) system.



## File types

| Documents  | Images  |
|--|---|
| <ul style="list-style-type: none"> <li>• PDF (version 1.7 or earlier)*</li> <li>• Microsoft file formats (DOC, DOCX, XLS, XLSX, PPT, PPTX)*</li> </ul> | <ul style="list-style-type: none"> <li>• JPEG or JPG</li> <li>• TIFF or TIF*</li> <li>• GIF*</li> <li>• BMP*</li> <li>• PNG*</li> <li>• PCX*</li> <li>• DCX*</li> </ul> |
| <p>* Supported only in some printer models.</p>  |   |

## Configuring confidential jobs

### Using the control panel

- 1 From the home screen, touch **Settings > Security > Confidential Print Setup**.
- 2 Configure the settings.

### Using the Embedded Web Server

- 1 Open a web browser, and then type the printer IP address in the address field.

**Notes:**

- View the printer IP address on the home screen. The IP address appears as four sets of numbers separated by periods, such as 123.123.123.123.
- If you are using a proxy server, then temporarily disable it to load the web page correctly.

- 2 Click **Settings > Security > Confidential Print Setup**.

- 3 Configure the settings.

| Use                         | To  |
|-----------------------------|---|
| Max Invalid PIN             | Set the number of times an invalid PIN can be entered.<br><b>Note:</b> When the limit is reached, the print jobs for that user name are deleted.  |
| Confidential Job Expiration | Set the expiration time for confidential print jobs.<br><b>Note:</b> Confidential held jobs are stored in the printer until they are released or deleted manually.  |
| Repeat Job Expiration       | Set the expiration time for print jobs that you want to repeat.<br><b>Note:</b> Repeat held jobs are stored in the printer memory for reprinting.   |
| Verify Job Expiration       | Set the expiration time for printing a copy of a job for you to check its quality before printing the remaining copies.<br><b>Note:</b> Verify jobs print one copy to check if it is satisfactory before printing the remaining copies. |

| Use                         | To   |
|-----------------------------|--|
| Reserve Job Expiration      | Set the expiration time print for jobs that you want to store in the printer for printing later.<br><b>Note:</b> Reserve held jobs are automatically deleted after printing. |
| Require All Jobs to be Held | Set the printer to hold all print jobs.  |
| Keep duplicate documents    | Set the printer to print all documents with the same file name.  |

## Printing confidential and other held jobs

### For Windows users

- 1 With a document open, click **File > Print**.
- 2 Select a printer, and then click **Properties, Preferences, Options, or Setup**.
- 3 Click **Print and Hold**.
- 4 Select **Use Print and Hold**, and then assign a user name.
- 5 Select the print job type (Confidential, Repeat, Reserve, or Verify).  
If you select **Confidential**, then secure the print job with a personal identification number (PIN).
- 6 Click **OK** or **Print**.
- 7 From the printer home screen, release the print job.
  - For confidential print jobs, touch **Held jobs** > select your user name > **Confidential** > enter the PIN > select the print job > configure the settings > **Print**.
  - For other print jobs, touch **Held jobs** > select your user name > select the print job > configure the settings > **Print**.

### For Macintosh users

#### Using AirPrint

- 1 With a document open, choose **File > Print**.
- 2 Select a printer, and then from the drop-down menu following the Orientation menu, choose **PIN Printing**.
- 3 Enable **Print with PIN**, and then enter a four-digit PIN.
- 4 Click **Print**.
- 5 From the printer home screen, release the print job. Touch **Held jobs** > select your computer name > **Confidential** > enter the PIN > select the print job > **Print**.

#### Using the print driver

- 1 With a document open, choose **File > Print**.
- 2 Select a printer, and then from the drop-down menu following the Orientation menu, choose **Print and Hold**.
- 3 Choose **Confidential Print**, and then enter a four-digit PIN.

- 4 Click **Print**.
- 5 From the printer home screen, release the print job. Touch **Held jobs** > select your computer name > **Confidential** > select the print job > enter the PIN > **Print**.

## Printing from a Cloud Connector profile

- 1 From the home screen, touch **Cloud Connector**.
- 2 Select a cloud service provider, and then select a profile.  
**Note:** For more information on creating a Cloud Connector profile, see [“Creating a Cloud Connector profile” on page 23](#).
- 3 Touch **Print**, and then select a file.  
If necessary, change the settings.  
**Note:** Make sure to select a supported file.
- 4 Print the document.

## Printing a font sample list

- 1 From the home screen, touch **Settings** > **Reports** > **Print** > **Print Fonts**.
- 2 Touch **PCL Fonts** or **PostScript Fonts**.

## Placing separator sheets between copies

- 1 From the home screen, touch **Settings** > **Print** > **Layout** > **Separator Sheets** > **Between Copies**.
- 2 Print the document.

## Canceling a print job

### From the printer control panel

- 1 From the home screen, touch **Cancel Job**.
- 2 Select a job to cancel.

### From the computer



- 1 Depending on the operating system, do either of the following:
  - Open the printers folder, and then select your printer.
  - From the System Preferences in the Apple menu, navigate to your printer, and then open the print queue.
- 2 Select a job to cancel.

## Adjusting toner darkness

- 1 From the home screen, touch **Settings** > **Print** > **Quality** > **Toner Darkness**.
- 2 Select a setting.

# Copy

## Using the automatic document feeder and scanner glass

| Automatic document feeder (ADF)   | Scanner glass  |
|---|--|
| <p><b>Note:</b> The ADF is available only in some printer models.</p>  <ul style="list-style-type: none"> <li>• Use the ADF for multiple-page or two-sided documents.</li> <li>• Load an original document faceup. For multiple-page documents, make sure to align the leading edge before loading.</li> <li>• Make sure to adjust the ADF guides to match the width of the paper that you are loading.</li> </ul> |  <ul style="list-style-type: none"> <li>• Use the scanner glass for single-page documents, book pages, small items (such as postcards or photos), transparencies, photo paper, or thin media (such as magazine clippings).</li> <li>• Place the document facedown in the corner with the arrow.</li> </ul> |

## Making copies

- 1 Load an original document into the ADF tray or on the scanner glass.

**Note:** To avoid a cropped image, make sure that the original document and output have the same paper size.

- 2 From the home screen, touch **Copy**, and then specify the number of copies.  
If necessary, adjust the copy settings.

- 3 Copy the document.

**Note:** To make a quick copy, from the control panel, press .

## Copying photos

- 1 Place a photo on the scanner glass.
- 2 From the home screen, touch **Copy** > **Content Type** > **Photo**.
- 3 Copy the document.

## Copying on letterhead

- 1 Load an original document into the ADF tray or on the scanner glass.
- 2 From the home screen, touch **Copy** > **Copy From** > select the size of the original document.
- 3 Touch **Copy To**, and then select the paper source that contains the letterhead.  
If you loaded the letterhead into the manual feeder, then navigate to:  
**Copy To** > **Manual Feeder** > select a paper size > **Letterhead**
- 4 Copy the document.

## Copying on both sides of the paper

- 1 Load an original document into the ADF tray or on the scanner glass.
- 2 From the home screen, touch **Copy** > **Sides**.
- 3 Adjust the settings.
- 4 Copy the document.

## Reducing or enlarging copies

- 1 Load an original document into the ADF tray or on the scanner glass.
- 2 From the home screen, navigate to:  
**Copy** > **Scale** > specify a scale value  
**Note:** Changing the size of the original document or output after setting Scale restores the scale value to Auto.
- 3 Copy the document.

## Copying multiple pages onto a single sheet

- 1 Load an original document into the ADF tray or on the scanner glass.
- 2 From the home screen, touch **Copy** > **Pages per Side**.
- 3 Adjust the settings.
- 4 Copy the document.

## Collating copies

- 1 Load an original document into the ADF tray or on the scanner glass.
- 2 From the home screen, touch **Copy** > **Collate** > **On [1,2,1,2,1,2]**.
- 3 Copy the document.

## Copying cards



- 1 Load a card on the scanner glass.
- 2 From the control panel, navigate to:  
**Copy > ID Copy**
- 3 If necessary, adjust the settings.
- 4 Copy the document.

## Creating a copy shortcut

- 1 From the home screen, touch **Copy**.
- 2 Configure the settings, and then touch  .
- 3 Create a shortcut.

## E-mail

### Using the automatic document feeder and scanner glass

| Automatic document feeder (ADF)   | Scanner glass  |
|---|--|
| <p><b>Note:</b> The ADF is available only in some printer models.</p>  <ul style="list-style-type: none"> <li>• Use the ADF for multiple-page or two-sided documents.</li> <li>• Load an original document faceup. For multiple-page documents, make sure to align the leading edge before loading.</li> <li>• Make sure to adjust the ADF guides to match the width of the paper that you are loading.</li> </ul> |  <ul style="list-style-type: none"> <li>• Use the scanner glass for single-page documents, book pages, small items (such as postcards or photos), transparencies, photo paper, or thin media (such as magazine clippings).</li> <li>• Place the document facedown in the corner with the arrow.</li> </ul> |

## Sending an e-mail

Before you begin, make sure that the SMTP settings are configured. For more information, see [“Configuring the e-mail SMTP settings” on page 32](#).

### Using the control panel

- 1 Load an original document into the ADF tray or on the scanner glass.
- 2 From the home screen, touch **E-mail**, and then enter the needed information.
- 3 If necessary, configure the output file type settings.
- 4 Send the e-mail.

### Using a shortcut number

- 1 Load an original document into the ADF tray or on the scanner glass.
- 2 From the home screen, touch **Shortcuts > E-mail**.
- 3 Select the shortcut number.
- 4 Send the e-mail.





## Creating an e-mail shortcut

- 1 From the home screen, touch **E-mail**.
- 2 Configure the settings, and then touch .
- 3 Create a shortcut.

# Fax

## Using the automatic document feeder and scanner glass

| Automatic document feeder (ADF)   | Scanner glass  |
|---|--|
| <p><b>Note:</b> The ADF is available only in some printer models.</p>  <ul style="list-style-type: none"> <li>• Use the ADF for multiple-page or two-sided documents.</li> <li>• Load an original document faceup. For multiple-page documents, make sure to align the leading edge before loading.</li> <li>• Make sure to adjust the ADF guides to match the width of the paper that you are loading.</li> </ul> |  <ul style="list-style-type: none"> <li>• Use the scanner glass for single-page documents, book pages, small items (such as postcards or photos), transparencies, photo paper, or thin media (such as magazine clippings).</li> <li>• Place the document facedown in the corner with the arrow.</li> </ul> |

## Sending a fax

**Note:** Make sure that fax is configured. For more information, see [“Setting up the printer to fax” on page 24](#).

### Using the control panel

- 1 Load an original document into the ADF tray or on the scanner glass.
- 2 From the home screen, touch **Fax**, and then enter the needed information.  
If necessary, adjust the settings.
- 3 Send the fax.

### Using the computer

Before you begin, make sure that the fax driver is installed. For more information, see [“Installing the fax driver” on page 45](#).

#### For Windows users

- 1 From the document that you are trying to fax, open the Print dialog.
- 2 Select the printer, and then click **Properties**, **Preferences**, **Options**, or **Setup**.

- 3 Click **Fax** > **Enable fax** > **Always display settings prior to faxing**, and then enter the recipient number.  
If necessary, configure other fax settings.
- 4 Send the fax.

### For Macintosh users

- 1 With a document open, choose **File** > **Print**.
- 2 Select the printer that has - **Fax** added after its name.
- 3 In the To field, enter the recipient number.  
If necessary, configure other fax settings.
- 4 Send the fax.

## Scheduling a fax

**Note:** Make sure that fax is configured. For more information, see [“Setting up the printer to fax” on page 24](#).

- 1 Load an original document into the ADF tray or on the scanner glass.
- 2 From the home screen, touch **Fax** > **To** > enter the fax number > **Done**.
- 3 Touch **Send Time**, configure the date and time, and then touch **OK**.
- 4 Send the fax.

## Creating a fax destination shortcut

**Note:** Make sure that fax is configured. For more information, see [“Setting up the printer to fax” on page 24](#).

- 1 From the home screen, touch **Fax** > **To**.
- 2 Enter the recipient number, and then touch **Done**.
- 3 Touch .
- 4 Create a shortcut.

## Changing the fax resolution

**Note:** Make sure that fax is configured. For more information, see [“Setting up the printer to fax” on page 24](#).

- 1 Load an original document into the ADF tray or on the scanner glass.
- 2 From the home screen, touch **Fax**, and then enter the needed information.
- 3 Touch **Resolution**, and then adjust the setting.
- 4 Send the fax.

## Adjusting the fax darkness

**Note:** Make sure that fax is configured. For more information, see [“Setting up the printer to fax” on page 24.](#)

- 1 Load an original document into the ADF tray or on the scanner glass.
- 2 From the home screen, touch **Fax**, and then enter the needed information.
- 3 Touch **Darkness**, and then adjust the setting.
- 4 Send the fax.

## Printing a fax log

**Note:** Make sure that fax is configured. For more information, see [“Setting up the printer to fax” on page 24.](#)

- 1 From the home screen, touch **Settings > Reports > Fax**.
- 2 Touch **Fax Job Log** or **Fax Call Log**.

## Blocking junk faxes

**Note:** Make sure that fax is configured. For more information, see [“Setting up the printer to fax” on page 24.](#)

- 1 From the home screen, touch **Settings > Fax > Fax Setup > Fax Receive Settings > Admin Controls**.
- 2 Set Block No Name Fax to **On**.

## Holding faxes

**Note:** Make sure that fax is configured. For more information, see [“Setting up the printer to fax” on page 24.](#)

- 1 Open a web browser, and then type the printer IP address in the address field.

**Notes:**

- View the printer IP address on the printer home screen. The IP address appears as four sets of numbers separated by periods, such as 123.123.123.123.
- If you are using a proxy server, then temporarily disable it to load the web page correctly.

- 2 Click **Settings > Fax > Fax Setup > Fax Receive Settings > Holding Faxes**.
- 3 Select a mode.
- 4 Apply the changes.

## Forwarding a fax

**Note:** Make sure that fax is configured. For more information, see [“Setting up the printer to fax” on page 24.](#)

- 1 Create a destination shortcut.
  - a Open a web browser, and then type the printer IP address in the address field.

**Notes:**

- View the printer IP address on the home screen. The IP address appears as four sets of numbers separated by periods, such as 123.123.123.123.
- If you are using a proxy server, then temporarily disable it to load the web page correctly.

**b** Click **Shortcuts > Add Shortcut**.

**c** Select a shortcut type, and then configure the settings.

**Note:** Take note of the shortcut number.

**d** Apply the changes.

**2** Click **Settings > Fax > Fax Setup > Fax Receive Settings > Admin Controls**.



**3** In the Fax Forwarding menu, select **Forward** or **Print and Forward**.

**4** In the Forward to menu, select the destination type and then type the shortcut number.

**5** Apply the changes.

# Scan

## Using the automatic document feeder and scanner glass

| Automatic document feeder (ADF)   | Scanner glass  |
|---|--|
| <p><b>Note:</b> The ADF is available only in some printer models.</p>  <ul style="list-style-type: none"> <li>• Use the ADF for multiple-page or two-sided documents.</li> <li>• Load an original document faceup. For multiple-page documents, make sure to align the leading edge before loading.</li> <li>• Make sure to adjust the ADF guides to match the width of the paper that you are loading.</li> </ul> |  <ul style="list-style-type: none"> <li>• Use the scanner glass for single-page documents, book pages, small items (such as postcards or photos), transparencies, photo paper, or thin media (such as magazine clippings).</li> <li>• Place the document facedown in the corner with the arrow.</li> </ul> |

## Scanning to a computer

Before you begin, make sure that:

- The printer firmware is updated. For more information, see [“Updating firmware” on page 46](#).
- The computer and the printer are connected to the same network.

### For Windows users

#### Using Lexmark ScanBack Utility

- 1 From the computer, run Lexmark ScanBack Utility, and then click **Next**.

**Note:** To download the utility, go to [www.lexmark.com/downloads](http://www.lexmark.com/downloads).

- 2 Click **Setup**, and then add the printer IP address.

**Note:** View the printer IP address on the printer home screen. The IP address appears as four sets of numbers separated by periods, such as 123.123.123.123.

- 3 Click **Close > Next**.

- 4 Select the size of the original document, and then click **Next**.

- 5 Select a file format and scan resolution, and then click **Next**.

- 6 Type a unique scan profile name, and then click **Next**.

- 7 Browse to the location you want to save the scanned document, create a file name, and then click **Next**.

**Note:** To reuse the scan profile, enable **Create Shortcut**, and then create a unique shortcut name.

- 8 Click **Finish**.
- 9 Load an original document into the automatic document feeder or on the scanner glass.
- 10 From the printer home screen, touch **Scan to Computer**, and then select a scan profile.

**Note:** Make sure that Scan to Computer is enabled. From the home screen, touch **Settings > Device > Visible Home Screen Icons > Scan to Computer > Display**.

### Using Windows Fax and Scan

**Note:** Make sure that the printer is added to the computer. For more information, see [“Adding printers to a computer” on page 45](#).

- 1 Load an original document into the automatic document feeder or on the scanner glass.
- 2 From the computer, open **Windows Fax and Scan**.
- 3 From the Source menu, select a scanner source.
- 4 If necessary, change the scan settings.
- 5 Scan the document.

### For Macintosh users

**Note:** Make sure that the printer is added to the computer. For more information, see [“Adding printers to a computer” on page 45](#).

- 1 Load an original document into the automatic document feeder or on the scanner glass.
- 2 From the computer, do either of the following:
  - Open **Image Capture**.
  - Open **Printers & Scanners**, and then select a printer. Click **Scan > Open Scanner**.
- 3 From the Scanner window, do one or more of the following:
  - Select where you want to save the scanned document.
  - Select the size of the original document.
  - To scan from the ADF, select **Document Feeder** from the Scan Menu or enable **Use Document Feeder**.
  - If necessary, configure the scan settings.
- 4 Click **Scan**.

## Scanning to an FTP server using a shortcut

- 1 Create an FTP shortcut.
  - a Open a web browser, and then type the printer IP address in the address field.

**Notes:**

- View the printer IP address on the home screen. The IP address appears as four sets of numbers separated by periods, such as 123.123.123.123.
- If you are using a proxy server, then temporarily disable it to load the web page correctly.

- b Click **Shortcuts > Add Shortcut**.





**3** Touch **Scan to USB** and adjust the settings if necessary.

**Notes:**

- To save the scanned document to a folder, touch **Scan to**, select a folder, and then touch **Scan Here**.
- If the USB Drive screen does not appear, then touch **USB Drive** on the control panel.

**4** Scan the document.

**Warning—Potential Damage:** To avoid loss of data or printer malfunction, do not touch the flash drive or the printer in the area shown while actively printing, reading, or writing from the memory device.



## Scanning to a Cloud Connector profile

**1** Load an original document into the ADF tray or on the scanner glass.

**2** From the home screen, touch **Cloud Connector**.

**3** Select a cloud service provider, and then select a profile.

**Note:** For more information on creating a Cloud Connector profile, see [“Creating a Cloud Connector profile” on page 23](#).

**4** Touch **Scan**, and then assign a filename and destination folder.

**5** Touch **Scan Here**.

If necessary, change the scan settings.

**6** Scan the document.

# Use printer menus

## Menu map

|  |  |  |
|--|--|--|
| <b>Device</b>  | <ul style="list-style-type: none"> <li>• <a href="#">Preferences</a></li> <li>• <a href="#">Eco-Mode</a></li> <li>• <a href="#">Remote Operator Panel</a></li> <li>• <a href="#">Notifications</a></li> <li>• <a href="#">Power Management</a></li> </ul>              | <ul style="list-style-type: none"> <li>• <a href="#">Anonymous Data Collection</a></li> <li>• <a href="#">Restore Factory Defaults</a></li> <li>• <a href="#">Maintenance</a></li> <li>• <a href="#">Visible Home Screen Icons</a></li> <li>• <a href="#">About this Printer</a></li> </ul>      |
| <b>Print</b>   | <ul style="list-style-type: none"> <li>• <a href="#">Layout</a></li> <li>• <a href="#">Setup</a></li> <li>• <a href="#">Quality</a></li> </ul>   | <ul style="list-style-type: none"> <li>• <a href="#">PostScript</a></li> <li>• <a href="#">PCL</a></li> <li>• <a href="#">Image</a></li> </ul>   |
| <b>Paper</b>   | <ul style="list-style-type: none"> <li>• <a href="#">Tray Configuration</a></li> </ul>   | <ul style="list-style-type: none"> <li>• <a href="#">Media Configuration</a></li> </ul>  |
| <b>Copy</b>  | <a href="#">Copy Defaults</a>  |  |
| <b>Fax<sup>1</sup></b>   | <a href="#">Fax Defaults</a>   |  |
| <b>E-mail</b>  | <ul style="list-style-type: none"> <li>• <a href="#">E-mail Setup</a></li> </ul>   | <ul style="list-style-type: none"> <li>• <a href="#">E-mail Defaults</a></li> </ul>  |
| <b>FTP</b>   | <a href="#">FTP Defaults</a>   |  |
| <b>USB Drive<sup>1</sup></b>   | <ul style="list-style-type: none"> <li>• <a href="#">Flash Drive Scan</a></li> </ul>   | <ul style="list-style-type: none"> <li>• <a href="#">Flash Drive Print</a></li> </ul>  |
| <b>Network/Ports</b>   | <ul style="list-style-type: none"> <li>• <a href="#">Network Overview</a></li> <li>• <a href="#">Wireless</a></li> <li>• <a href="#">Wi-Fi Direct</a></li> <li>• <a href="#">Ethernet</a></li> <li>• <a href="#">TCP/IP</a></li> <li>• <a href="#">SNMP</a></li> </ul> | <ul style="list-style-type: none"> <li>• <a href="#">IPSec</a></li> <li>• <a href="#">802.1x</a></li> <li>• <a href="#">LPD Configuration</a></li> <li>• <a href="#">HTTP/FTP Settings</a></li> <li>• <a href="#">USB</a></li> <li>• <a href="#">Restrict external network access</a></li> </ul> |
| <b>Security</b>  | <ul style="list-style-type: none"> <li>• <a href="#">Login methods<sup>2</sup></a></li> <li>• <a href="#">Certificate Management<sup>2</sup></a></li> <li>• <a href="#">Login Restrictions</a></li> </ul>  | <ul style="list-style-type: none"> <li>• <a href="#">Confidential Print Setup</a></li> <li>• <a href="#">Erase Temporary Data Files</a></li> <li>• <a href="#">Miscellaneous</a></li> </ul>  |
| <b><a href="#">Cloud Connector</a></b>   | Enable/Disable Connectors  |  |
| <b>Reports</b>   | <ul style="list-style-type: none"> <li>• <a href="#">Menu Settings Page</a></li> <li>• <a href="#">Device</a></li> <li>• <a href="#">Print</a></li> </ul>  | <ul style="list-style-type: none"> <li>• <a href="#">Shortcuts</a></li> <li>• <a href="#">Fax</a></li> <li>• <a href="#">Network</a></li> </ul>  |
| <b><a href="#">Troubleshooting</a></b>   | Print Quality Test Pages   | Cleaning the Scanner   |
| <sup>1</sup> Available only in some printer models.<br><sup>2</sup> Appears only in the Embedded Web Server. |  |  |

# Device

## Preferences

| Menu item  | Description  |
|--|--|
| <b>Display Language</b><br>[List of languages]   | Set the language of the text that appears on the display.  |
| <b>Country/Region</b><br>[List of countries or regions]  | Identify the country or region where the printer is configured to operate.   |
| <b>Run initial setup</b><br>No*<br>Yes   | Run the setup wizard.  |
| <b>Keyboard</b><br>Keyboard Type<br>[List of languages]  | Select a language as a keyboard type.<br><b>Note:</b> All the Keyboard Type values may not appear or may require special hardware to appear.                           |
| <b>Displayed information</b><br>Display Text 1 (IP Address*)<br>Display Text 2 (Date/Time*)<br>Custom Text 1<br>Custom Text 2  | Specify the information to appear on the home screen.  |
| <b>Date and Time</b><br>Configure<br>Current Date and Time<br>Manually Set Date and Time<br>Date Format (MM-DD-YYYY*)<br>Time Format (12 hour A.M./P.M.*)<br>Time Zone | Configure the printer date and time.   |
| <b>Date and Time</b><br>Network Time Protocol<br>Enable NTP (On*)<br>NTP Server<br>Enable Authentication   | Configure the settings for Network Time Protocol (NTP).<br><b>Note:</b> When Enable Authentication is set to MD5 key, Key ID and Password appear.                      |
| <b>Paper Sizes</b><br>U.S.*<br>Metric  | Specify the unit of measurement for paper sizes.<br><b>Note:</b> The country or region selected in the initial setup wizard determines the initial paper size setting. |
| <b>Screen Brightness</b><br>20–100% (100*)   | Adjust the brightness of the display.  |
| <b>Flash Drive Access</b><br>Disabled<br>Enabled*  | Enable access to the flash drive.  |
| <b>Note:</b> An asterisk (*) next to a value indicates the factory default setting.  |  |

| Menu item   | Description   |
|---|---|
| <b>One Page Flatbed Scanning</b><br>On<br>Off*                                      | Set copies from the scanner glass to only one page at a time.   |
| <b>Screen Timeout</b><br>5–300 (60*)  | Set the idle time in seconds before the display shows the home screen, or before the printer logs out a user account automatically. |
| <b>Note:</b> An asterisk (*) next to a value indicates the factory default setting. |   |

## Eco-Mode

| Menu item  | Description   |
|--|---|
| <b>Print</b><br>Sides<br>1-Sided*<br>2-Sided   | Specify whether to print on one side or two sides of the paper.             |
| <b>Print</b><br>Pages per Side<br>Off*<br>2 pages per side<br>3 pages per side<br>4 pages per side<br>6 pages per side<br>9 pages per side<br>12 pages per side<br>16 pages per side | Print multiple page images on one side of a sheet of paper.                 |
| <b>Print</b><br>Toner Darkness<br>Light<br>Normal*<br>Dark   | Determine the lightness or darkness of text or images.                      |
| <b>Copy</b><br>Sides<br>1 sided to 1 sided*<br>1 sided to 2 sided  | Specify whether to print on one side or both sides of the paper.            |
| <b>Copy</b><br>Pages per Side<br>Off*<br>2 Portrait pages<br>4 Portrait pages<br>2 Landscape pages<br>4 Landscape pages  | Specify the number of page images to print on one side of a sheet of paper. |
| <b>Note:</b> An asterisk (*) next to a value indicates the factory default setting.  |   |

| Menu item   | Description                               |
|---|---|
| <b>Copy</b><br>Darkness<br>1-9 (5*)   | Adjust the darkness of the scanned image. |
| <b>Note:</b> An asterisk (*) next to a value indicates the factory default setting. |   |

## Remote Operator Panel

| Menu item   | Description   |
|---|---|
| <b>External VNC Connection</b><br>Don't Allow*<br>Allow                             | Connect an external Virtual Network Computing (VNC) client to the remote control panel.   |
| <b>Authentication Type</b><br>None*<br>Standard Authentication                      | Set the authentication type when accessing the VNC client server.   |
| <b>VNC Password</b>   | Specify the password to connect to the VNC client server.<br><b>Note:</b> This menu item appears only if Authentication Type is set to Standard Authentication. |
| <b>Note:</b> An asterisk (*) next to a value indicates the factory default setting. |   |

## Notifications

| Menu item  | Description  |
|--|--|
| <b>ADF Loaded Beep</b><br>Off<br>On*   | Enable a sound when loading paper into the ADF.  |
| <b>Alarm Control</b><br>Off<br>Single*<br>Continuous                                 | Set the number of times that the alarm sounds when the printer requires user intervention. |
| <b>Supplies</b><br>Show Supply Estimates<br>Show estimates*<br>Do not show estimates | Show the estimated status of the supplies.   |
| <b>Supplies</b><br>Cartridge Alarm<br>Off<br>Single*<br>Continuous                   | Set the number of times that the alarm sounds when the cartridge is low.                   |
| <b>Note:</b> An asterisk (*) next to a value indicates the factory default setting.  |  |

| Menu item   | Description  |
|---|--|
| <b>Supplies</b><br>Custom Supply Notifications  | Configure notification settings when the printer requires user intervention.<br><br><b>Note:</b> This menu item appears only in the Embedded Web Server. |
| <b>E-mail Alerts Setup</b><br>E-mail Setup<br>Primary SMTP Gateway                                | Type the IP address or host name of the primary SMTP server for sending e-mail.  |
| <b>E-mail Alerts Setup</b><br>E-mail Setup<br>Primary SMTP Gateway Port<br>1–65535 (25*)          | Enter the port number of the primary SMTP server.  |
| <b>E-mail Alerts Setup</b><br>E-mail Setup<br>Secondary SMTP Gateway                              | Type the server IP address or host name of your secondary or backup SMTP server.   |
| <b>E-mail Alerts Setup</b><br>E-mail Setup<br>Secondary SMTP Gateway Port<br>1–65535 (25*)        | Enter the server port number of your secondary or backup SMTP server.  |
| <b>E-mail Alerts Setup</b><br>E-mail Setup<br>SMTP Timeout<br>5–30 seconds (30*)                  | Specify how long before the printer times out if the SMTP server does not respond.   |
| <b>E-mail Alerts Setup</b><br>E-mail Setup<br>Reply Address                                       | Specify a reply address in the e-mail.   |
| <b>E-mail Alerts Setup</b><br>E-mail Setup<br>Always use SMTP default Reply Address<br>Off*<br>On | Use the SMTP default reply address.  |
| <b>E-mail Alerts Setup</b><br>E-mail Setup<br>Use SSL/TLS<br>Disabled*<br>Negotiate<br>Required   | Send an e-mail using an encrypted link.  |
| <b>E-mail Alerts Setup</b><br>E-mail Setup<br>Require Trusted Certificate<br>On*<br>Off           | Require a trusted certificate when accessing the SMTP server.  |

**Note:** An asterisk (\*) next to a value indicates the factory default setting.

| Menu item  | Description   |
|--|---|
| <b>E-mail Alerts Setup</b><br>E-mail Setup<br>SMTP Server Authentication<br>No authentication required*<br>Login / Plain<br>NTLM<br>CRAM-MD5<br>Digest-MD5<br>Kerberos 5 | Set the authentication type for the SMTP server.  |
| <b>E-mail Alerts Setup</b><br>E-mail Setup<br>Device-Initiated E-mail<br>None*<br>Use Device SMTP Credentials  | Set whether credentials are required for device-initiated e-mails.  |
| <b>E-mail Alerts Setup</b><br>E-mail Setup<br>Device Userid  | Specify the user ID to connect to the SMTP server.  |
| <b>E-mail Alerts Setup</b><br>E-mail Setup<br>Device Password  | Specify the password to connect to the SMTP server.   |
| <b>E-mail Alerts Setup</b><br>E-mail Setup<br>NTLM Domain  | Specify the domain name for the NTLM security protocol.   |
| <b>Error Prevention</b><br>Jam Assist<br>Off<br>On*  | Set the printer to check for jammed paper automatically.  |
| <b>Error Prevention</b><br>Auto Continue<br>Disabled<br>Enabled* (5 seconds)<br>Auto Continue Time   | Let the printer continue processing or printing a job automatically after clearing certain attendance conditions. |
| <b>Error Prevention</b><br>Auto Reboot<br>Auto Reboot<br>Reboot when idle<br>Reboot always*<br>Reboot never  | Set the printer to restart when an error occurs.  |
| <b>Error Prevention</b><br>Auto Reboot<br>Max Auto Reboots (2*)  | Set the number of automatic reboots that the printer can perform.   |
| <b>Note:</b> An asterisk (*) next to a value indicates the factory default setting.  |   |

| Menu item   | Description  |
|---|--|
| <b>Error Prevention</b><br>Auto Reboot<br>Auto Reboot Window (720*)                 | Set the number of seconds before the printer performs an automatic reboot.   |
| <b>Error Prevention</b><br>Auto Reboot<br>Auto Reboot Counter                       | Show a read-only information of the reboot counter.  |
| <b>Error Prevention</b><br>Display Short Paper Error<br>On<br>Auto-clear*           | Set the printer to show a message when a short paper error occurs.<br><br><b>Note:</b> Short paper refers to the size of the paper loaded. |
| <b>Error Prevention</b><br>Page Protect<br>Off*<br>On                               | Set the printer to process the entire page into the memory before printing it.   |
| <b>Jam Content Recovery</b><br>Jam Recovery<br>Off<br>On<br>Auto*                   | Set the printer to reprint jammed pages.   |
| <b>Jam Content Recovery</b><br>Scanner Jam Recovery<br>Job level<br>Page level*     | Specify how to restart a scan job after resolving a paper jam.   |
| <b>Note:</b> An asterisk (*) next to a value indicates the factory default setting. |  |

## Power Management

| Menu item   | Description   |
|---|---|
| <b>Sleep Mode Profile</b><br>Print from Sleep Mode<br>Stay awake after printing<br>Enter Sleep Mode after printing* | Set the printer to stay in Ready mode or return to Sleep mode after printing. |
| <b>Timeouts</b><br>Sleep Mode<br>1–120 minutes (15*)  | Set the idle time before the printer begins operating in Sleep mode.          |
| <b>Note:</b> An asterisk (*) next to a value indicates the factory default setting.                                 |   |



| Menu item   | Description   |
|---|---|
| <b>Timeouts</b><br>Hibernate Timeout<br>Disabled<br>1 hour<br>2 hours<br>3 hours<br>6 hours<br>1 day<br>2 days<br>3 days*<br>1 week<br>2 weeks<br>1 month | Set the time before the printer turns off.  |
| <b>Timeouts</b><br>Hibernate Timeout on Connection<br>Hibernate<br>Do Not Hibernate*  | Set Hibernate Timeout to turn off the printer while an active Ethernet connection exists. |
| <b>Note:</b> An asterisk (*) next to a value indicates the factory default setting.   |   |

### Anonymous Data Collection

| Menu item   | Description  |
|---|--|
| <b>Anonymous Data Collection</b><br>Device Usage and Performance Information<br>None* | Send printer usage and performance information to Lexmark.<br><b>Note:</b> Anonymous Data Send Time appears only when you set Anonymous Data Collection to Device Usage and Performance. |
| <b>Anonymous Data Send Time</b><br>Start Time<br>Stop Time                            |  |
| <b>Note:</b> An asterisk (*) next to a value indicates the factory default setting.   |  |

### Restore Factory Defaults

| Menu item   | Description                                   |
|---|---|
| <b>Restore Settings</b><br>Restore all settings<br>Restore printer settings<br>Restore network settings<br>Restore fax settings | Restore the printer factory default settings. |

## Maintenance

### Config Menu

| Menu item   | Description   |
|---|---|
| <b>USB Configuration</b><br>USB PnP<br>1*<br>2  | Change the USB driver mode of the printer to improve its compatibility with a personal computer.  |
| <b>USB Configuration</b><br>USB Scan to Local<br>On*<br>Off                                       | Set whether the USB device driver enumerates as a USB Simple device (single interface) or as a USB Composite device (multiple interfaces).                            |
| <b>USB Configuration</b><br>USB Speed<br>Full<br>Auto*  | Set the USB port to run at full speed and disable its high-speed capabilities.  |
| <b>Tray Configuration</b><br>Tray Linking<br>Automatic<br>Off*                                    | Set the printer to link the trays that have the same paper type and paper size settings.<br><br><b>Note:</b> This menu item is available only in some printer models. |
| <b>Tray Configuration</b><br>Show Tray Insert Message<br>Off<br>Only for unknown sizes*<br>Always | Display a message to select paper size and type after inserting the tray.   |
| <b>Tray Configuration</b><br>A5 Loading<br>Short Edge<br>Long Edge*                               | Specify the page orientation when loading A5 paper size.  |
| <b>Tray Configuration</b><br>Paper Prompts<br>Auto*<br>Manual Paper                               | Set the paper source that the user fills when a prompt to load paper appears.   |
| <b>Tray Configuration</b><br>Envelope Prompts<br>Auto*<br>Manual Envelope                         | Set the paper source that the user fills when a prompt to load envelope appears.  |
| <b>Note:</b> An asterisk (*) next to a value indicates the factory default setting.               |   |

| Menu item  | Description  |
|--|--|
| <b>Tray Configuration</b><br>Action for Prompts<br>Prompt user*<br>Continue<br>Use current     | Set the printer to resolve paper- or envelope-related change prompts.  |
| <b>Reports</b><br>Menu Settings Page<br>Event Log<br>Event Log Summary                         | Print reports about printer menu settings, status, and event logs.   |
| <b>Supply Usage And Counters</b><br>Clear Supply Usage History                                 | Reset the supply usage history, such as number of pages and days remaining, to the factory shipped level.  |
| <b>Supply Usage And Counters</b><br>Fuser Reset<br>ITM Reset                                   | Reset the counter after installing a new supply.   |
| <b>Printer Emulations</b><br>PPDS Emulation<br>Off*<br>On                                      | Set the printer to recognize and use the PPDS data stream.   |
| <b>Printer Emulations</b><br>PS Emulation<br>On*<br>Off  | Set the printer to recognize and use the PS data stream.   |
| <b>Printer Emulations</b><br>Emulator Security<br>Page Timeout<br>0–60 (60*)                   | Set the page timeout during emulation.   |
| <b>Printer Emulations</b><br>Emulator Security<br>Reset Emulator After Job<br>On<br>Off*       | Reset the emulator after a print job.  |
| <b>Printer Emulations</b><br>Emulator Security<br>Disable Printer Message Access<br>On*<br>Off | Disable access to the printer message during emulation.  |
| <b>Fax Configuration</b><br>Fax Low Power Support<br>Disable Sleep<br>Permit Sleep<br>Auto*    | Set fax to enter Sleep mode whenever the printer determines that it should.<br><br><b>Note:</b> This menu item is available only in some printer models. |
| <b>Note:</b> An asterisk (*) next to a value indicates the factory default setting.            |  |

| Menu item   | Description  |
|---|--|
| <b>Print Configuration</b><br>Black Only Mode<br>Off*<br>On                         | Print color content in grayscale.  |
| <b>Print Configuration</b><br>Color Trapping<br>Off<br>1<br>2*<br>3<br>4<br>5       | Enhance the printed output to compensate for misregistration in the printer.   |
| <b>Print Configuration</b><br>Font Sharpening<br>0–150 (24*)                        | Set a text point-size value below which the high-frequency screens are used when printing font data.<br>For example, if the value is 24, then all fonts sized 24 points or less use the high-frequency screens.  |
| <b>Device Operations</b><br>Quiet Mode<br>On<br>Off*                                | Set the printer to operate in Quiet Mode.<br><b>Note:</b> Enabling this setting slows down the printer performance.  |
| <b>Device Operations</b><br>Panel Menus<br>Enable*<br>Disable                       | Enable access to the control panel menus.  |
| <b>Device Operations</b><br>Safe Mode<br>Off*<br>On                                 | Set the printer to operate in a special mode, in which it attempts to continue offering as much functionality as possible, despite known issues.<br>For example, when set to On, and the duplex motor is nonfunctional, the printer performs one-sided printing of the documents even if the job is two-sided printing.<br><b>Note:</b> This menu item is available only in some printer models. |
| <b>Device Operations</b><br>Clear Custom Status                                     | Erase user-defined strings for the Default or Alternate custom messages.   |
| <b>Device Operations</b><br>Clear all remotely-installed messages                   | Erase messages that were remotely installed.<br><b>Note:</b> This menu item is available only in some printer models.  |
| <b>Device Operations</b><br>Automatically Display Error Screens<br>On*<br>Off       | Show existing error messages on the display after the printer remains inactive on the home screen for a length of time equal to the Screen Timeout setting.  |
| <b>Note:</b> An asterisk (*) next to a value indicates the factory default setting. |  |

| Menu item   | Description   |
|---|---|
| <b>Toner patch sensor setup</b><br>Calibration frequency preference<br>Disabled<br>Fewest color adjustments<br>Fewer color adjustments<br>Normal*<br>Better color accuracy<br>Best color accuracy | Set the default calibration frequency.  |
| <b>Toner patch sensor setup</b><br>Full calibration   | Run the full color calibration.   |
| <b>Toner patch sensor setup</b><br>Print TPS information page   | Print a diagnostic page that contains toner patch sensor calibration.   |
| <b>Scanner Configuration</b><br>Scanner Manual Registration<br>Print Quick Test   | Print a Quick Test target page.<br><b>Note:</b> Make sure that the margin spacing on the target page is uniform all the way around the target. If it is not, then the printer margins may need to be reset. |
| <b>Scanner Configuration</b><br>Scanner Manual Registration<br>Front ADF Registration<br>Rear ADF Registration<br>Flatbed Registration  | Manually register the flatbed and ADF after replacing the ADF, scanner glass, or controller board.  |
| <b>Scanner Configuration</b><br>Edge Erase<br>Flatbed Edge Erase<br>0–6 (3*)<br>ADF Edge Erase<br>0–6 (3*)  | Set the size, in millimeters, of the no-print area around an ADF or flatbed scan job.   |
| <b>Scanner Configuration</b><br>Disable Scanner<br>Enabled*<br>Disabled<br>ADF Disabled   | Disable the scanner when it is not working properly.  |
| <b>Scanner Configuration</b><br>Tiff Byte Order<br>CPU Endianness*<br>Little Endian<br>Big Endian   | Set the byte order of a TIFF-formatted scan output.   |
| <b>Scanner Configuration</b><br>Exact Tiff Rows Per Strip<br>On*<br>Off   | Set the RowsPerStrip tag value of a TIFF-formatted scan output.   |
| <b>Note:</b> An asterisk (*) next to a value indicates the factory default setting.   |   |

## Out of Service Erase

| Menu item  | Description   |
|--|---|
| <b>Sanitize all information on nonvolatile memory</b><br>Erase all printer and network settings<br>Erase all shortcuts and shortcut settings | Clear all settings and applications that are stored in the printer. |

## Visible Home Screen Icons

| Menu  | Description  |
|---|--|
| <b>Copy</b><br><b>E-mail</b><br><b>Fax</b><br><b>Status/Supplies</b><br><b>Job Queue</b><br><b>Change Language</b><br><b>Held Jobs</b><br><b>USB Drive</b><br><b>Bookmarks</b><br><b>Cloud Connector</b><br><b>Scan to Computer</b> | Specify which icons to show on the home screen.<br><b>Note:</b> Fax, USB Drive, and Bookmarks are available only in some printer models. |

## About this Printer

| Menu item   | Description   |
|---|---|
| <b>Asset Tag</b>                                      | Describe the printer. The maximum length is 32 characters.          |
| <b>Printer Location</b>                               | Identify the printer location. The maximum length is 63 characters. |
| <b>Contact</b>  | Personalize the printer name. The maximum length is 63 characters.  |
| <b>Export Configuration File to USB*</b>              | Export configuration files to a flash drive.                        |
| <b>Export Compressed Logs to USB*</b>                 | Export compressed log files to a flash drive.                       |
| <b>Send Logs</b>                                      | Send diagnostic information to Lexmark.                             |
| * This menu item appears only in some printer models. |   |

# Print

## Layout

| Menu item   | Description  |
|---|--|
| <b>Sides</b><br>1-Sided*<br>2-Sided   | Specify whether to print on one side or two sides of the paper.  |
| <b>Flip Style</b><br>Long Edge*<br>Short Edge   | Determine which side of the paper (long edge or short edge) is bound when performing two-sided printing.<br><br><b>Note:</b> Depending on the option selected, the printer automatically offsets each printed information of the page to bind the job correctly. |
| <b>Blank Pages</b><br>Print<br>Do Not Print*  | Print blank pages that are included in a print job.  |
| <b>Collate</b><br>Off [1,1,1,2,2,2]<br>On [1,2,1,2,1,2]*  | Keep the pages of a print job stacked in sequence, particularly when printing multiple copies of the job.  |
| <b>Separator Sheets</b><br>None*<br>Between Copies<br>Between Jobs<br>Between Pages   | Insert blank separator sheets when printing.   |
| <b>Separator Sheet Source</b><br>Tray 1   | Specify the paper source for the separator sheet.  |
| <b>Pages per Side</b><br>Off*<br>2 pages per side<br>3 pages per side<br>4 pages per side<br>6 pages per side<br>9 pages per side<br>12 pages per side<br>16 pages per side | Print multiple page images on one side of a sheet of paper.  |
| <b>Pages per Side Ordering</b><br>Horizontal*<br>Reverse Horizontal<br>Vertical<br>Reverse Vertical   | Specify the positioning of multiple page images when using Pages per Side.<br><br><b>Note:</b> The positioning depends on the number of page images and their page orientation.  |
| <b>Note:</b> An asterisk (*) next to a value indicates the factory default setting.   |  |

| Menu item   | Description  |
|---|--|
| <b>Pages per Side Orientation</b><br>Auto*<br>Landscape<br>Portrait | Specify the orientation of a multiple-page document when using Pages per Side. |
| <b>Pages per Side Border</b><br>None*<br>Solid                      | Print a border around each page image when using Pages per Side.               |
| <b>Copies</b><br>1–9999 (1*)  | Specify the number of copies for each print job.                               |
| <b>Print Area</b><br>Normal*<br>Fit to page<br>Whole Page           | Set the printable area on a sheet of paper.                                    |

**Note:** An asterisk (\*) next to a value indicates the factory default setting.

## Setup

| Menu item   | Description  |
|---|--|
| <b>Printer Language</b><br>PCL Emulation<br>PS Emulation* | Set the printer language.<br><br><b>Note:</b> Setting a printer language default does not prevent a software program from sending print jobs that use another printer language.  |
| <b>Printer Usage</b><br>Max Speed<br>Max Yield*           | Determine how the color print cartridges operate during printing.<br><br><b>Notes:</b> <ul style="list-style-type: none"> <li>• When set to Max Yield, the color print cartridges slow down or stop while printing groups of black-only pages.</li> <li>• When set to Max Speed, the color print cartridges always run while printing, whether color or black pages are being printed.</li> </ul>  |
| <b>Resource Save</b><br>On<br>Off*                        | Determine what the printer does with downloaded resources, such as fonts and macros, when it receives a job that requires more than the available memory.<br><br><b>Notes:</b> <ul style="list-style-type: none"> <li>• When set to Off, the printer retains downloaded resources only until memory is needed. Resources associated with the inactive printer language are deleted.</li> <li>• When set to On, the printer preserves all the permanent downloaded resources across all language switches. When necessary, the printer shows memory full messages instead of deleting permanent resources.</li> </ul> |

**Note:** An asterisk (\*) next to a value indicates the factory default setting.



| Menu item   | Description   |
|---|---|
| <b>Print All Order</b><br>Alphabetical*<br>Newest First<br>Oldest First             | Specify the order in which held and confidential jobs are printed when Print All is selected. |
| <b>Note:</b> An asterisk (*) next to a value indicates the factory default setting. |   |

## Quality

| Menu item   | Description  |
|---|--|
| <b>Print Mode</b><br>Black and White<br>Color*                                      | Set the print mode.  |
| <b>Print Resolution</b><br>4800 CQ*   | Set the resolution for the printed output.<br><b>Note:</b> 4800 CQ provides high-quality output at maximum speed.  |
| <b>Toner Darkness</b><br>Light<br>Normal*<br>Dark                                   | Determine the lightness or darkness of text images.  |
| <b>Halftone</b><br>Normal*<br>Detail  | Enhance the printed output to have smoother lines with sharper edges.  |
| <b>RGB Brightness</b><br>-6 to 6 (0*)   | Adjust the brightness, contrast, and saturation for color output.<br><b>Note:</b> This setting does not affect files where CMYK color specifications are used. |
| <b>RGB Contrast</b><br>0 to 5 (0*)  |  |
| <b>RGB Saturation</b><br>0 to 5 (0*)  |  |
| <b>Note:</b> An asterisk (*) next to a value indicates the factory default setting. |  |

## Advanced Imaging

| Menu item  | Description  |
|--|--|
| <b>Color Balance</b><br>Cyan<br>-5 to 5 (0*)<br>Magenta<br>-5 to 5 (0*)<br>Yellow<br>-5 to 5 (0*)<br>Black<br>-5 to 5 (0*)<br>Reset Defaults | Adjust the amount of toner that is used for each color.  |
| <b>Color Correction</b><br>Color Correction<br>Auto*<br>Off<br>Manual<br><b>Color Correction Content</b>                                     | Modify the color settings used to print documents.<br><br><b>Notes:</b> <ul style="list-style-type: none"> <li>• Off sets the printer to receive the color correction from the software.</li> <li>• Auto sets the printer to apply different color profiles to each object on the printed page.</li> <li>• Manual allows the customization of the RGB or CMYK color conversions applied to each object on the printed page.</li> <li>• Color Correction Content is available only when Color Correction is set to Manual.</li> </ul> |
| <b>Color Adjust</b>  | Calibrate the printer to adjust color variations in the printed output.  |
| <b>Note:</b> An asterisk (*) next to a value indicates the factory default setting.  |  |

## PostScript

| Menu item   | Description  |
|---|--|
| <b>Print PS Error</b><br>On<br>Off*   | Print a page that describes the PostScript® error.<br><br><b>Note:</b> When an error occurs, processing of the job stops, the printer prints an error message, and the rest of the print job is flushed. |
| <b>Minimum Line Width</b><br>1–30 (2*)  | Set the minimum stroke width.<br><br><b>Note:</b> Jobs printed in 4800 CQ use half the value.  |
| <b>Lock PS Startup Mode</b><br>On*<br>Off   | Disable the SysStart file.<br><br><b>Note:</b> The default setting varies depending on the printer model.  |
| <b>Image Smoothing</b><br>On<br>Off*  | Enhance the contrast and sharpness of low-resolution images.<br><br><b>Note:</b> This setting has no effect on images with a resolution of 300 dpi or higher.  |
| <b>Wait Timeout</b><br>Disabled<br>Enabled*   | Enable the printer to wait for more data before canceling a print job.   |
| <b>Note:</b> An asterisk (*) next to a value indicates the factory default setting. |  |

| Menu item   | Description   |
|---|---|
| <b>Wait Timeout Time</b><br>15–65535 (40*)  | Set the time in seconds for the printer to wait for more data before canceling a print job.<br><b>Note:</b> This menu item appears only when Wait Timeout is enabled. |
| <b>Note:</b> An asterisk (*) next to a value indicates the factory default setting. |   |

## PCL

| Menu item   | Description  |
|---|--|
| <b>Font Name</b><br>[List of available fonts] (Courier*)                              | Select a font from the specified font source.  |
| <b>Symbol Set</b><br>[List of available symbol set] (10U PC-8*)                       | Specify the symbol set for each font name.<br><b>Note:</b> A symbol set is a set of alphabetic and numeric characters, punctuation, and special symbols. Symbol sets support the different languages or specific programs such as math symbols for scientific text.  |
| <b>Pitch</b><br>0.08–100.00 (10.00*)  | Specify the pitch for fixed or monospaced fonts.<br><b>Note:</b> Pitch refers to the number of fixed-space characters in a horizontal inch of type.  |
| <b>Orientation</b><br>Portrait*<br>Landscape<br>Reverse Portrait<br>Reverse Landscape | Specify the orientation of text and graphics on the page.  |
| <b>Lines per Page</b><br>1–255  | Specify the number of lines of text for each page printed through the PCL® data stream.<br><b>Notes:</b> <ul style="list-style-type: none"> <li>This menu item activates vertical escapement that causes the selected number of requested lines to print between the default margins of the page.</li> <li>60 is the U.S. factory default setting. 64 is the international factory default setting.</li> </ul> |
| <b>PCL5 Minimum Line Width</b><br>1–30 (2*)   | Set the initial minimum stroke width.  |
| <b>PCLXL Minimum Line Width</b><br>1–30 (2*)  |  |
| <b>A4 Width</b><br>198 mm*<br>203 mm  | Set the width of the logical page on A4-size paper.<br><b>Note:</b> Logical page is the space on the physical page where data is printed.  |
| <b>Note:</b> An asterisk (*) next to a value indicates the factory default setting.   |  |

| Menu item  | Description   |
|--|---|
| <b>Auto CR after LF</b><br>On<br>Off*  | Set the printer to perform a carriage return after a line feed control command.<br><br><b>Note:</b> Carriage return is a mechanism that commands the printer to move the position of the cursor to the first position on the same line. |
| <b>Auto LF after CR</b><br>On<br>Off*  | Set the printer to perform a line feed after a carriage return control command.   |
| <b>Tray Renumber</b><br>Assign Tray [x]<br>Assign Manual Paper<br>Assign Manual Envelope | Configure the printer to work with a different print driver or custom application that uses a different set of source assignments to request a given paper source.  |
| <b>Tray Renumber</b><br>View Factory Defaults  | Show the factory default value assigned for each paper source.  |
| <b>Tray Renumber</b><br>Restore Defaults   | Restore the tray renumber values to their factory defaults.   |
| <b>Print Timeout</b><br>Disabled<br>Enabled*   | Set the printer to end a print job after it has been idle for the specified amount of time in seconds.<br><br><b>Note:</b> Print Timeout Time appears only when Print Timeout is enabled.   |
| <b>Print Timeout Time</b><br>1–255 (90*)   |   |
| <b>Note:</b> An asterisk (*) next to a value indicates the factory default setting.      |   |

## Image

| Menu item  | Description   |
|--|---|
| <b>Auto Fit</b><br>On<br>Off*  | Select the best available paper size and orientation setting for an image.<br><br><b>Note:</b> When set to On, this menu item overrides the scaling and orientation settings for the image. |
| <b>Invert</b><br>Off*<br>On  | Invert bitonal monochrome images.<br><br><b>Note:</b> This menu item does not apply to GIF or JPEG image formats.   |
| <b>Scaling</b><br>Anchor Top Left<br>Best Fit*<br>Anchor Center<br>Fit Height/Width<br>Fit Height<br>Fit Width | Adjust the image to fit the printable area.<br><br><b>Note:</b> When Auto Fit is set to On, Scaling is automatically set to Best Fit.   |
| <b>Note:</b> An asterisk (*) next to a value indicates the factory default setting.                            |   |

| Menu item   | Description   |
|---|---|
| <b>Orientation</b><br>Portrait*<br>Landscape<br>Reverse Portrait<br>Reverse Landscape | Specify the orientation of text and graphics on the page. |
| <b>Note:</b> An asterisk (*) next to a value indicates the factory default setting.   |   |

## Paper

### Tray Configuration

| Menu item   | Description   |
|---|---|
| <b>Default Source</b><br>Tray [x] (1*)<br>Manual Paper<br>Manual Envelope           | Set the paper source for all print jobs.  |
| <b>Paper Size/Type</b><br>Tray [x] (1*)<br>Manual Paper<br>Manual Envelope          | Specify the paper size or paper type loaded in each paper source.   |
| <b>Substitute Size</b><br>Off<br>Letter/A4<br>All Listed*                           | Set the printer to substitute a specified paper size if the requested size is not loaded in any paper source.<br><br><b>Notes:</b> <ul style="list-style-type: none"> <li>• Off prompts the user to load the required paper size.</li> <li>• Letter/A4 prints an A4-size document on letter when loading letter, and letter-size jobs on A4 paper size when loading A4.</li> <li>• All Listed substitutes Letter/A4.</li> </ul> |
| <b>Note:</b> An asterisk (*) next to a value indicates the factory default setting. |   |

### Media Configuration

#### Universal Setup

| Menu item   | Description  |
|---|--|
| <b>Units of Measure</b><br>Inches<br>Millimeters                                    | Specify the unit of measurement for the universal paper.<br><br><b>Note:</b> Inches is the U.S. factory default setting. Millimeters is the international factory default setting. |
| <b>Note:</b> An asterisk (*) next to a value indicates the factory default setting. |  |

| Menu item   | Description   |
|---|---|
| <b>Portrait Width</b><br>3.00–14.17 inches (8.50*)<br>76–360 mm (216*)              | Set the portrait width of the universal paper.  |
| <b>Portrait Height</b><br>3.00–14.17 inches (14*)<br>76–360 mm (356*)               | Set the portrait height of the universal paper.   |
| <b>Feed Direction</b><br>Short Edge*<br>Long Edge                                   | Set the printer to pick paper from the short edge or long edge direction.<br><br><b>Note:</b> Long Edge appears only when the longest edge is shorter than the maximum width supported. |
| <b>Note:</b> An asterisk (*) next to a value indicates the factory default setting. |   |

### Custom Scan Sizes

| Menu item   | Description  |
|---|--|
| <b>Custom Scan Size [x]</b><br>Scan Size Name<br>Width<br>1–8.50 inches (8.50*)<br>25–216 mm (216*)<br>Height<br>1–14 inches (14*)<br>25–356 mm (297*)<br>Orientation<br>Portrait*<br>Landscape<br>2 scans per side<br>Off*<br>On | Assign a scan size name and configure the scan settings. |
| <b>Note:</b> An asterisk (*) next to a value indicates the factory default setting.   |  |

## Media Types

| Menu item   | Description   |
|---|---|
| Plain Paper<br>Card Stock<br>Recycled<br>Glossy<br>Labels<br>Bond<br>Envelope<br>Letterhead<br>Preprinted<br>Colored Paper<br>Light<br>Heavy<br>Rough/Cotton<br>Custom Type [x] | Specify the texture, weight, and orientation of the paper loaded.<br><b>Note:</b> Custom Type is supported only in some printer models. |

## Copy

### Copy Defaults

| Menu item   | Description  |
|---|--|
| <b>Content Type</b><br>Text<br>Text/Photo*<br>Photo<br>Graphics   | Improve the output result based on the content of the original document.   |
| <b>Sides</b><br>1 sided to 1 sided*<br>1 sided to 2 sided<br>2 sided to 1 sided<br>2 sided to 2 sided           | Specify the scanning behavior based on the original document.<br><b>Note:</b> 2 sided to 1 sided and 2 sided to 2 sided appears only in some printer models. |
| <b>Color</b><br>Off<br>On*<br>Auto  | Specify whether to print copies in color.  |
| <b>Pages per Side</b><br>Off*<br>2 Portrait pages<br>4 Portrait pages<br>2 Landscape pages<br>4 Landscape pages | Specify the number of page images to print on one side of a sheet of paper.  |
| <b>Note:</b> An asterisk (*) next to a value indicates the factory default setting.                             |  |

| Menu item   | Description   |
|---|---|
| <b>Print Page Borders</b><br>On<br>Off*   | Place a border around each image when printing multiple pages on a single page.   |
| <b>Collate</b><br>Off [1,1,1,2,2,2]<br>On [1,2,1,2,1,2]*                            | Print multiple copies in sequence.  |
| <b>“Copy from” Size</b><br>[List of paper sizes]                                    | Set the paper size of the original document.<br><b>Note:</b> Letter is the U.S. factory default setting. A4 is the international factory default setting. |
| <b>“Copy to” Source</b><br>Tray [x] (1*)<br>Manual Feeder<br>Auto Size Match        | Specify the paper source for the copy job.  |
| <b>Darkness</b><br>1 to 9 (5*)  | Adjust the darkness of the scanned image.   |
| <b>Number of Copies</b><br>1–9999 (1*)  | Specify the number of copies.   |
| <b>Note:</b> An asterisk (*) next to a value indicates the factory default setting. |   |

### Advanced Imaging

| Menu item   | Description  |
|---|--|
| <b>Color Balance</b><br>Cyan to Red<br>-4 to 4 (0*)<br>Magenta to Green<br>-4 to 4 (0*)<br>Yellow to Blue<br>-4 to 4 (0*) | Adjust the color intensity during scanning.                                  |
| <b>Auto Color Detect</b><br>Color Sensitivity<br>1–9 (5*)<br>Area Sensitivity<br>1–9 (5*)                                 | Set the amount of color that the printer detects from the original document. |
| <b>Note:</b> An asterisk (*) next to a value indicates the factory default setting.                                       |  |



| Menu item   | Description   |
|---|---|
| <b>Contrast</b><br>Best for Content*<br>0<br>1<br>2<br>3<br>4<br>5                  | Specify the contrast of the output.                         |
| <b>Background Removal</b><br>Level<br>-4 to 4 (0*)                                  | Adjust the amount of background visible on a scanned image. |
| <b>Scan Edge to Edge</b><br>On<br>Off*  | Allow edge-to-edge scanning of the original document.       |
| <b>Note:</b> An asterisk (*) next to a value indicates the factory default setting. |   |

### Admin Controls

| Menu item   | Description                             |
|---|---|
| <b>Allow Color Copies</b><br>On*<br>Off   | Print copies in color.                  |
| <b>Allow Save as Shortcut</b><br>On*<br>Off   | Save custom copy settings as shortcuts. |
| <b>Note:</b> An asterisk (*) next to a value indicates the factory default setting. |   |

## Fax

### Fax Defaults

#### Fax Mode

| Menu item  | Description   |
|--|---|
| <b>Fax Mode</b><br>Fax<br>Fax Server<br>Disabled | Select a fax mode.<br><br><b>Note:</b> Depending on your printer model, the factory default setting may vary. |

## Fax Setup

### General Fax settings

| Menu item   | Description  |
|---|--|
| <b>Fax Name</b>   | Identify your fax machine.   |
| <b>Fax Number</b>   | Identify your fax number.  |
| <b>Fax ID</b><br>Fax Name<br>Fax Number*  | Notify fax recipients of your fax name or fax number.  |
| <b>Memory Use</b><br>All receive<br>Mostly receive<br>Equal*<br>Mostly send<br>All send | Set the amount of internal printer memory allocated for faxing.<br><b>Note:</b> This menu item prevents memory buffer conditions and failed faxes.   |
| <b>Cancel Faxes</b><br>Allow*<br>Don't Allow  | Cancel outgoing faxes before they are transmitted, or cancel incoming faxes before they finish printing.   |
| <b>Fax Number Masking</b><br>Off*<br>From Left<br>From Right                            | Specify the format for masking an outgoing fax number.   |
| <b>Digits to Mask</b><br>0–58 (0*)  | Specify the number of digits to mask in an outgoing fax number.  |
| <b>Enable Line Connected Detection</b><br>On*<br>Off                                    | Determine whether a telephone line is connected to the printer.<br><b>Note:</b> Detection takes place when turning on the printer and before each call.  |
| <b>Optimize Fax Compatibility</b>   | Configure the printer fax functionality for optimal compatibility with other fax machines.   |
| <b>Fax Transport</b><br>T.38<br>Analog<br>G.711<br>etherFAX                             | Set the fax transport method.<br><b>Notes:</b> <ul style="list-style-type: none"> <li>• This menu item appears only if an etherFAX or Fax over IP (FoIP) license bundle is installed in the printer.</li> <li>• Depending on your printer model, the factory default settings may vary.</li> </ul> |
| <b>Note:</b> An asterisk (*) next to a value indicates the factory default setting.     |  |

### HTTPS Fax Settings

**Note:** This menu appears only if Fax Transport is set to etherFAX.

| Menu item   | Description  |
|---|--|
| <b>HTTPS service URL</b>  | Specify the etherFAX service URL.                        |
| <b>HTTPS Proxy</b>  | Specify a proxy server URL.                              |
| <b>HTTPS Proxy User</b>   | Specify the user name and password for the proxy server. |
| <b>HTTPS Proxy Password</b>   |  |
| <b>Fax Send Encryption</b><br>Disabled<br>Enabled*<br>Required                      | Enable encryption for outgoing fax messages.             |
| <b>Fax Receive Encryption</b><br>Disabled<br>Enabled*<br>Required                   | Enable encryption for incoming fax messages.             |
| <b>HTTPS Fax Status</b>   | Show the etherFAX communication status.                  |
| <b>Note:</b> An asterisk (*) next to a value indicates the factory default setting. |  |

### Fax Send Settings

| Menu item   | Description   |
|---|---|
| <b>Resolution</b><br>Standard*<br>Fine<br>Super Fine<br>Ultra Fine                  | Set the resolution of the scanned image.<br><b>Note:</b> A higher resolution increases fax transmission time and requires more memory.                            |
| <b>Original Size</b><br>[List of paper sizes] (Mixed Sizes*)                        | Specify the size of the original document.  |
| <b>Orientation</b><br>Portrait*<br>Landscape  | Specify the orientation of the original document.<br><b>Note:</b> This menu item appears only in some printer models.   |
| <b>Sides</b><br>Off*<br>Short Edge<br>Long Edge                                     | Specify the orientation of the original document when scanning on both sides of the document.<br><b>Note:</b> This menu item appears only in some printer models. |
| <b>Content Type</b><br>Text*<br>Text/Photo<br>Photo<br>Graphics                     | Improve the output result based on the content of the original document.  |
| <b>Darkness</b><br>1–9 (5*)   | Adjust the darkness of the scanned image.   |
| <b>Note:</b> An asterisk (*) next to a value indicates the factory default setting. |   |

| Menu item   | Description   |
|---|---|
| <b>Behind a PABX</b><br>On<br>Off*  | Set the printer to dial a fax number without waiting to recognize the dial tone.<br><b>Note:</b> Private Automated Branch Exchange (PABX) is a telephone network that allows a single access number to offer multiple lines to outside callers. |
| <b>Dial Mode</b><br>Tone*<br>Pulse  | Specify the dial mode for incoming or outgoing faxes.   |
| <b>Note:</b> An asterisk (*) next to a value indicates the factory default setting. |   |

### Advanced Imaging

| Menu item  | Description   |
|--|---|
| <b>Color Balance</b><br>Cyan - Red<br>-4 to 4 (0*)<br>Magenta - Green<br>-4 to 4 (0*)<br>Yellow - Blue<br>-4 to 4 (0*) | Adjust the color intensity during scanning.                 |
| <b>Contrast</b><br>Best for Content*<br>0<br>1<br>2<br>3<br>4<br>5   | Set the contrast of the output.                             |
| <b>Background Removal</b><br>Level<br>-4 to 4 (0*)   | Adjust the amount of background visible on a scanned image. |
| <b>Scan Edge to Edge</b><br>On<br>Off*   | Allow edge-to-edge scanning of the original document.       |
| <b>Note:</b> An asterisk (*) next to a value indicates the factory default setting.                                    |   |

### Admin Controls

| Menu item   | Description   |
|---|---|
| <b>Automatic Redial</b><br>0–9 (5*)   | Adjust the number of redial attempts based on the activity levels of recipient fax machines.  |
| <b>Redial Frequency</b><br>1–200 minutes (3*)                                       | Increase the time between redial attempts to increase the chance of sending fax successfully. |
| <b>Note:</b> An asterisk (*) next to a value indicates the factory default setting. |   |

| Menu item  | Description   |
|--|---|
| <b>Enable ECM</b><br>On*<br>Off  | Activate Error Correction Mode (ECM) for fax jobs.<br><b>Note:</b> ECM detects and corrects errors in the fax transmission process caused by telephone line noise and poor signal strength. |
| <b>Enable Fax Scans</b><br>On*<br>Off  | Fax documents that are scanned at the printer.  |
| <b>Driver to Fax</b><br>On*<br>Off   | Allow the print driver to send fax.   |
| <b>Allow Save as Shortcut</b><br>On*<br>Off  | Save fax numbers as shortcuts on the printer.   |
| <b>Max Speed</b><br>33600*<br>14400<br>9600<br>4800<br>2400                                  | Set the maximum speed for sending fax.  |
| <b>Enable Color Fax Scans</b><br>Off by Default*<br>On by Default<br>Never Use<br>Always Use | Enable color scans for fax.   |
| <b>Auto Convert Color Faxes to Mono Faxes</b><br>On*<br>Off                                  | Convert all outgoing color faxes to black and white.  |
| <b>Confirm Fax Number</b><br>Off*<br>On  | Ask the user to confirm the fax number.   |
| <b>Dial Prefix</b>   | Set a dialing prefix.   |
| <b>Note:</b> An asterisk (*) next to a value indicates the factory default setting.          |   |

### Fax Receive Settings

| Menu item   | Description                               |
|---|---|
| <b>Rings to Answer</b><br>1–25 (3*)   | Set the number of rings for incoming fax. |
| <b>Auto Reduction</b><br>On*<br>Off   | Scale incoming fax to fit on the page.    |
| <b>Note:</b> An asterisk (*) next to a value indicates the factory default setting. |   |

| Menu item   | Description  |
|---|--|
| <b>Paper Source</b><br>Tray [X]<br>Auto*  | Set the paper source for printing incoming fax.                                    |
| <b>Sides</b><br>On<br>Off*  | Print on both sides of the paper.  |
| <b>Separator Sheets</b><br>None*<br>Before Job<br>After Job                         | Specify whether to insert blank separator sheets when printing.                    |
| <b>Separator Sheet Source</b><br>Tray [X] (1*)                                      | Specify the paper source for the separator sheet.                                  |
| <b>Fax Footer</b><br>On<br>Off*   | Print the transmission information at the bottom of each page from a received fax. |
| <b>Fax Footer Time Stamp</b><br>Receive*<br>Print                                   | Print the time stamp at the bottom of each page from a received fax.               |
| <b>Note:</b> An asterisk (*) next to a value indicates the factory default setting. |  |

### Admin Controls

| Menu item   | Description  |
|---|--|
| <b>Enable Fax Receive</b><br>On*<br>Off   | Set the printer to receive fax.  |
| <b>Enable Color Fax Receive</b><br>On*<br>Off                                       | Set the printer to receive fax in color.                                       |
| <b>Enable Caller ID</b><br>On<br>Off*   | Show the number that is sending the incoming fax.                              |
| <b>Block No Name Fax</b><br>On<br>Off*  | Block incoming faxes sent from devices with no station ID or fax ID specified. |
| <b>Note:</b> An asterisk (*) next to a value indicates the factory default setting. |  |

| Menu item   | Description  |
|---|--|
| <b>Answer On</b><br>All Rings*<br>Single Ring Only<br>Double Ring Only<br>Triple Ring Only<br>Single or Double Rings Only<br>Single or Triple Rings Only<br>Double or Triple Rings Only | Set a distinctive ring pattern for incoming fax.   |
| <b>Auto Answer</b><br>On*<br>Off  | Set the printer to receive fax automatically.  |
| <b>Fax Forwarding</b><br>Print*<br>Print and Forward<br>Forward   | Specify whether to forward received fax.   |
| <b>Forward To</b><br>Destination 1<br>Destination 2   | Specify where to forward received fax.<br><b>Note:</b> This menu item appears only when Fax Forwarding is set to Print and Forward or Forward. |
| <b>Max Speed</b><br>33600*<br>14400<br>9600<br>4800<br>2400   | Set the maximum speed for transmitting fax.  |
| <b>Note:</b> An asterisk (*) next to a value indicates the factory default setting.   |  |

### Fax Log settings

| Menu item   | Description  |
|---|--|
| <b>Transmission Log Frequency</b><br>Always*<br>Never<br>Only for Error             | Specify how often the printer creates a transmission log.                    |
| <b>Transmission Log Action</b><br>Print<br>Off<br>On*<br>E-mail<br>Off*<br>On       | Print or e-mail a log for successful fax transmission or transmission error. |
| <b>Note:</b> An asterisk (*) next to a value indicates the factory default setting. |  |

| Menu item   | Description   |
|---|---|
| <b>Receive Error Log</b><br>Print Never*<br>Print on Error                          | Print a log for fax-receive failures.                 |
| <b>Auto Print Logs</b><br>On*<br>Off  | Print all fax activity.                               |
| <b>Log Paper Source</b><br>Tray [x] (1*)  | Specify the paper source for printing logs.           |
| <b>Logs Display</b><br>Remote Fax Name*<br>Dialed Number                            | Identify the sender by remote fax name or fax number. |
| <b>Enable Job Log</b><br>On*<br>Off   | View a summary of all fax jobs.                       |
| <b>Enable Call Log</b><br>On*<br>Off  | View a summary of fax dialing history.                |
| <b>Note:</b> An asterisk (*) next to a value indicates the factory default setting. |   |

### Speaker settings

| Menu item   | Description                    |
|---|--------------------------------|
| <b>Speaker Mode</b><br>Always Off*<br>Always On<br>On until Connected               | Set the fax speaker mode.      |
| <b>Speaker Volume</b><br>Low*<br>High   | Adjust the fax speaker volume. |
| <b>Ringer Volume</b><br>Off*<br>On  | Enable the ringer volume.      |
| <b>Note:</b> An asterisk (*) next to a value indicates the factory default setting. |                                |



## Fax Server Setup

### General Fax Settings

| Menu item   | Description  |
|---|--|
| <b>To Format</b>  | Specify a fax recipient.<br><b>Note:</b> If you want to use the fax number, then type the number sign (#) before a number. |
| <b>Reply Address</b>  | Specify a reply address for sending fax.   |
| <b>Subject</b>  | Specify the fax subject and message.   |
| <b>Message</b>  |  |
| <b>Enable analog receive</b><br>Off*<br>On  | Set the printer to receive analog faxes.   |
| <b>Note:</b> An asterisk (*) next to a value indicates the factory default setting. |  |

### Fax Server E-mail Settings

| Menu item   | Description   |
|---|---|
| <b>Use E-mail SMTP Server</b><br>On*<br>Off   | Use the Simple Mail Transfer Protocol (SMTP) settings for e-mail in receiving and sending faxes.<br><b>Note:</b> When set to On, all other settings of the Fax Server E-mail Settings menu are not shown. |
| <b>Primary SMTP Gateway</b>   | Type the IP address or host name of the primary SMTP server.  |
| <b>Primary SMTP Gateway Port</b><br>1–65535 (25*)                                   | Enter the port number of the primary SMTP server.   |
| <b>Secondary SMTP Gateway</b>   | Type the server IP address or host name of your secondary or backup SMTP server.  |
| <b>Secondary SMTP Gateway Port</b><br>1–65535 (25*)                                 | Enter the server port number of your secondary or backup SMTP server.   |
| <b>SMTP Timeout</b><br>5–30 (30*)   | Set the time before the printer times out if the SMTP server does not respond.  |
| <b>Reply Address</b>  | Specify a reply address for sending fax.  |
| <b>Use SSL/TLS</b><br>Disabled*<br>Negotiate<br>Required                            | Specify whether to send fax using an encrypted link.  |
| <b>Require Trusted Certificate</b><br>Off<br>On*                                    | Specify a trusted certificate when accessing the SMTP server.   |
| <b>Note:</b> An asterisk (*) next to a value indicates the factory default setting. |   |

| Menu item  | Description   |
|--|---|
| <b>SMTP Server Authentication</b><br>No authentication required*<br>Login / Plain<br>NTLM<br>CRAM-MD5<br>Digest-MD5<br>Kerberos 5                                  | Set the authentication type for the SMTP server.                              |
| <b>Device-Initiated E-mail</b><br>None*<br>Use Device SMTP Credentials   | Specify whether credentials are required for device-initiated e-mail.         |
| <b>User-Initiated E-mail</b><br>None*<br>Use Device SMTP Credentials<br>Use Session User ID and Password<br>Use Session E-mail address and Password<br>Prompt user | Specify whether credentials are required for user-initiated e-mail.           |
| <b>Use Active Directory Device Credentials</b><br>Off*<br>On   | Enable user credentials and group destinations to connect to the SMTP server. |
| <b>Device Userid</b>   | Specify the user ID and password to connect to the SMTP server.               |
| <b>Device Password</b>   |   |
| <b>Kerberos 5 REALM</b>  | Specify the realm for the Kerberos 5 authentication protocol.                 |
| <b>NTLM Domain</b>   | Specify the domain name for the NTLM security protocol.                       |
| <b>Disable "SMTP server not set up" error</b><br>Off*<br>On  | Hide the "SMTP server not set up" error message.                              |
| <b>Note:</b> An asterisk (*) next to a value indicates the factory default setting.  |   |

### Fax Server Scan Settings

| Menu item   | Description                                    |
|---|--|
| <b>Image Format</b><br>TIFF (.tif)<br>PDF (.pdf)*<br>JPEG (.jpg)                    | Specify the file format for the scanned image. |
| <b>Note:</b> An asterisk (*) next to a value indicates the factory default setting. |  |

| Menu item   | Description   |
|---|---|
| <b>Content Type</b><br>Text*<br>Text/Photo<br>Photo<br>Graphics   | Improve the output result based on the content of the original document.  |
| <b>Content Source</b><br>Black and White Laser<br>Color Laser*<br>Inkjet<br>Photo/Film<br>Magazine<br>Newspaper<br>Press<br>Other | Improve the output result based on the source of the original document.   |
| <b>Fax Resolution</b><br>Standard*<br>Fine<br>Super Fine<br>Ultra Fine  | Set the fax resolution.   |
| <b>Sides</b><br>Off*<br>Short Edge<br>Long Edge   | Specify the orientation of the original document when scanning on both sides of the document.   |
| <b>Darkness</b><br>1–9 (5*)   | Set the darkness of the output.   |
| <b>Orientation</b><br>Portrait*<br>Landscape  | Specify the orientation of text and graphics on the page.   |
| <b>Original Size</b><br>[List of paper sizes]   | Set the paper size of the original document.<br><br><b>Notes:</b> <ul style="list-style-type: none"> <li>• Mixed Sizes is the U.S. factory default setting. A4 is the international factory default setting.</li> <li>• This setting may vary depending on your printer model.</li> </ul> |
| <b>Use Multi-Page TIFF</b><br>Off<br>On*  | Choose between single- and multiple-page TIFF files.  |
| <b>Note:</b> An asterisk (*) next to a value indicates the factory default setting.   |   |

# E-mail

## E-mail Setup

| Menu item   | Description  |
|---|--|
| <b>Primary SMTP Gateway</b>   | Type the IP address or host name of the primary SMTP server for sending e-mail.  |
| <b>Primary SMTP Gateway Port</b><br>1–65535 (25*)   | Enter the port number of the primary SMTP server.                                |
| <b>Secondary SMTP Gateway</b>   | Type the server IP address or host name of your secondary or backup SMTP server. |
| <b>Secondary SMTP Gateway Port</b><br>1–65535 (25*)   | Enter the server port number of your secondary or backup SMTP server.            |
| <b>SMTP Timeout</b><br>5–30 seconds (30*)   | Set the time before the printer times out if the SMTP server does not respond.   |
| <b>Reply Address</b>  | Specify a reply address in the e-mail.   |
| <b>Always use SMTP default Reply Address</b><br>On<br>Off*  | Always use the default reply address in the SMTP server.                         |
| <b>Use SSL/TLS</b><br>Disabled*<br>Negotiate<br>Required  | Specify whether to send e-mail using an encrypted link.                          |
| <b>Require Trusted Certificate</b><br>On*<br>Off  | Require a trusted certificate when accessing the SMTP server.                    |
| <b>SMTP Server Authentication</b><br>No authentication required*<br>Login / Plain<br>NTLM<br>CRAM-MD5<br>Digest-MD5 | Set the authentication type for the SMTP server.                                 |
| <b>Device-Initiated E-mail</b><br>None*<br>Use Device SMTP Credentials  | Specify whether credentials are required for device-initiated e-mail.            |
| <b>Device Userid</b>  | Specify the user ID and password to connect to the SMTP server.                  |
| <b>Device Password</b>  |  |
| <b>NTLM Domain</b>  | Specify the domain name for the NTLM security protocol.                          |
| <b>Note:</b> An asterisk (*) next to a value indicates the factory default setting.                                 |  |

## E-mail Defaults

| Menu item   | Description  |
|---|--|
| <b>Subject</b>  | Specify the e-mail subject and message.  |
| <b>Message</b>  |  |
| <b>File Name</b>  | Specify the filename for the scanned image.  |
| <b>Format</b><br>PDF (.pdf)*<br>TIFF (.tif)<br>JPEG (.jpg)  | Specify the file format for the scanned image.   |
| <b>PDF Settings</b><br>PDF Version<br>1.3<br>1.4<br>1.5*<br>1.6<br>1.7<br>Archival Version<br>A-1a*<br>A-1b<br>Secure<br>Off*<br>On<br>Archival (PDF/A)<br>Off*<br>On | Set the PDF format of the scanned image.<br><b>Note:</b> Archival Version and Archival (PDF/A) appear only if PDF Version is set to 1.4. |
| <b>Content Type</b><br>Text<br>Text/Photo*<br>Photo<br>Graphics   | Improve the output result based on the content of the original document.   |
| <b>Color</b><br>Black and White<br>Gray<br>Color*<br>Auto   | Specify the color when scanning an image.  |
| <b>Resolution</b><br>75 dpi<br>150 dpi*<br>200 dpi<br>300 dpi<br>400 dpi<br>600 dpi   | Set the resolution of the scanned image.   |
| <b>Note:</b> An asterisk (*) next to a value indicates the factory default setting.   |  |

| Menu item   | Description   |
|---|---|
| <b>Darkness</b><br>1–9 (5*)   | Adjust the darkness of the scanned image.   |
| <b>Orientation</b><br>Portrait*<br>Landscape  | Specify the orientation of the original document.<br><b>Note:</b> This menu item appears only in some printer models.   |
| <b>Original Size</b><br>[List of paper sizes]                                       | Set the paper size of the original document.<br><b>Note:</b> Mixed Sizes is the factory default setting.  |
| <b>Sides</b><br>Off*<br>Short Edge<br>Long Edge                                     | Specify the orientation of the original document when scanning on both sides of the document.<br><b>Note:</b> This menu item appears only in some printer models. |
| <b>Note:</b> An asterisk (*) next to a value indicates the factory default setting. |   |

### Advanced Imaging

| Menu item   | Description  |
|---|--|
| <b>Color Balance</b><br>Cyan - Red<br>-4 to 4 (0*)<br>Magenta - Green<br>-4 to 4 (0*)<br>Yellow - Blue<br>-4 to 4 (0*)  | Adjust the color intensity during scanning.                                  |
| <b>Auto Color Detect</b><br>Color Sensitivity<br>1–9 (5*)<br>Area Sensitivity<br>1–9 (5*)<br>E-mail Bit Depth<br>1 bit*<br>8 bit<br>Minimum Scan Resolution<br>75 dpi<br>150 dpi<br>200 dpi<br>300 dpi* | Set the amount of color that the printer detects from the original document. |
| <b>Note:</b> An asterisk (*) next to a value indicates the factory default setting.   |  |

| Menu item   | Description   |
|---|---|
| <b>Contrast</b><br>Best for content*<br>0<br>1<br>2<br>3<br>4<br>5                  | Specify the contrast of the output.                         |
| <b>Background Removal</b><br>Level<br>-4 to 4 (0*)                                  | Adjust the amount of background visible on a scanned image. |
| <b>Scan Edge to Edge</b><br>On<br>Off*  | Allow edge-to-edge scanning of the original document.       |
| <b>Note:</b> An asterisk (*) next to a value indicates the factory default setting. |   |

### Admin Controls

| Menu item   | Description   |
|---|---|
| <b>Max E-mail Size</b><br>0–65535 (0*)  | Set the allowable file size for each e-mail.  |
| <b>Size Error Message</b>   | Specify an error message that the printer sends when an e-mail exceeds its allowable file size.<br><b>Note:</b> You can type up to 1024 characters. |
| <b>Send Me a Copy</b><br>Never appears*<br>On by Default<br>Off by Default<br>Always On | Send a copy of the e-mail to yourself.  |
| <b>Text Default</b><br>5–95 (75*)   | Set the quality of text on a scanned image.   |
| <b>Text/Photo Default</b><br>5–95 (75*)   | Set the quality of text or photo on a scanned image.  |
| <b>Photo Default</b><br>5–95 (50*)  | Set the quality of a photo on a scanned image.  |
| <b>Transmission Log</b><br>Print log*<br>Do Not Print Log<br>Print Only For Error       | Print a log for successful e-mail transmission.   |
| <b>Log Paper Source</b><br>Tray [x] (1*)  | Specify the paper source for printing logs.   |
| <b>Note:</b> An asterisk (*) next to a value indicates the factory default setting.     |   |

| Menu item   | Description  |
|---|--|
| <b>Allow Save as Shortcut</b><br>On*<br>Off   | Save e-mail addresses as shortcuts.<br><b>Note:</b> When set to Off, the Save As Shortcut button does not appear on the e-mail Destination screen. |
| <b>Reset E-mail Information After Sending</b><br>On*<br>Off                         | Restore the default e-mail information after sending an e-mail.  |
| <b>Note:</b> An asterisk (*) next to a value indicates the factory default setting. |  |

## FTP

### FTP Defaults

| Menu item   | Description   |
|---|---|
| <b>Format</b><br>PDF (.pdf)*<br>TIFF (.tif)<br>JPEG (.jpg)  | Specify the file format for the scanned image.  |
| <b>PDF Settings</b><br>PDF Version<br>1.3<br>1.4<br>1.5*<br>1.6<br>1.7<br>Archival Version<br>A-1a*<br>A-1b<br>Secure<br>Off*<br>On<br>Archival (PDF/A)<br>Off*<br>On | Set the PDF format for the scanned image.<br><b>Note:</b> Archival Version and Archival (PDF/A) appear only if PDF Version is set to 1.4. |
| <b>Content Type</b><br>Text<br>Text/Photo*<br>Graphics<br>Photo   | Improve the output result based on the content of the original document.  |
| <b>Note:</b> An asterisk (*) next to a value indicates the factory default setting.   |   |



| Menu item   | Description   |
|---|---|
| <b>Color</b><br>Black and White<br>Gray<br>Color*<br>Auto                           | Specify the color when scanning an image.   |
| <b>Resolution</b><br>75 dpi<br>150 dpi*<br>200 dpi<br>300 dpi<br>400 dpi<br>600 dpi | Set the resolution of the scanned image.  |
| <b>Darkness</b><br>1–9 (5*)   | Adjust the darkness of the scanned image.   |
| <b>Orientation</b><br>Portrait*<br>Landscape  | Specify the orientation of the original document.<br><b>Note:</b> This menu item appears only in some printer models.   |
| <b>Original Size</b><br>[List of paper sizes] (Mixed Sizes*)                        | Set the paper size of the original document.  |
| <b>Sides</b><br>Off*<br>Short Edge<br>Long Edge                                     | Specify the orientation of the original document when scanning on both sides of the document.<br><b>Note:</b> This menu item appears only in some printer models. |
| <b>File Name</b>  | Specify the file name of the scanned image.   |
| <b>Note:</b> An asterisk (*) next to a value indicates the factory default setting. |   |

### Advanced Imaging

| Menu item  | Description                                 |
|--|---|
| <b>Color Balance</b><br>Cyan - Red<br>-4 to 4 (0*)<br>Magenta - Green<br>-4 to 4 (0*)<br>Yellow - Blue<br>-4 to 4 (0*) | Adjust the color intensity during scanning. |
| <b>Note:</b> An asterisk (*) next to a value indicates the factory default setting.                                    |   |

| Menu item  | Description  |
|--|--|
| <b>Auto Color Detect</b><br>Color Sensitivity<br>1–9 (5*)<br>Area Sensitivity<br>1–9 (5*)<br>FTP Bit Depth<br>1 bit*<br>8 bit<br>Minimum Scan Resolution<br>75 dpi<br>150 dpi<br>200 dpi<br>300 dpi* | Set the amount of color that the printer detects from the original document. |
| <b>Contrast</b><br>Best for content*<br>0<br>1<br>2<br>3<br>4<br>5   | Specify the contrast of the output.  |
| <b>Background Removal</b><br>Level<br>-4 to 4 (0*)   | Adjust the amount of background visible on a scanned image.                  |
| <b>Scan Edge to Edge</b><br>On<br>Off*   | Allow edge-to-edge scanning of the original document.                        |
| <b>Note:</b> An asterisk (*) next to a value indicates the factory default setting.  |  |

### Admin Controls

| Menu item   | Description  |
|---|--|
| <b>Text Default</b><br>5–95 (75*)   | Set the quality of text on a scanned image.                |
| <b>Text/Photo Default</b><br>5–95 (75*)   | Set the quality of text or photo image on a scanned image. |
| <b>Photo Default</b><br>5–95(50*)   | Set the quality of a photo image on a scanned image.       |
| <b>Transmission Log</b><br>Print Log*<br>Do Not Print Log<br>Print Only For Error   | Print a log for successful FTP scan transmission.          |
| <b>Note:</b> An asterisk (*) next to a value indicates the factory default setting. |  |

| Menu item   | Description                                     |
|---|---|
| <b>Log Paper Source</b><br>Tray [x] (1*)  | Specify the paper source for printing FTP logs. |
| <b>Note:</b> An asterisk (*) next to a value indicates the factory default setting. |   |

## USB Drive

### Flash Drive Scan

| Menu item   | Description   |
|---|---|
| <b>Format</b><br>PDF (.pdf)*<br>TIFF (.tif)<br>JPEG (.jpg)  | Specify the file format for the scanned image.  |
| <b>PDF Settings</b><br>PDF Version<br>1.3<br>1.4<br>1.5*<br>1.6<br>1.7<br>Archival Version<br>A-1a*<br>A-1b<br>Secure<br>Off*<br>On<br>Archival (PDF/A)<br>Off*<br>On | Set the PDF format for the scanned image.<br><b>Note:</b> Archival Version and Archival (PDF/A) appear only if PDF Version is set to 1.4. |
| <b>Content Type</b><br>Text<br>Text/Photo*<br>Graphics<br>Photo   | Improve the output result based on the content of the original document.  |
| <b>Color</b><br>Black and White<br>Gray<br>Color*<br>Auto   | Specify the color when scanning an image.   |
| <b>Note:</b> An asterisk (*) next to a value indicates the factory default setting.   |   |

| Menu item   | Description   |
|---|---|
| <b>Resolution</b><br>75 dpi<br>150 dpi*<br>200 dpi<br>300 dpi<br>400 dpi<br>600 dpi | Set the resolution of the scanned image.  |
| <b>Darkness</b><br>1–9 (5*)   | Adjust the darkness of the scanned image.   |
| <b>Orientation</b><br>Portrait*<br>Landscape  | Specify the orientation of the original document.<br><b>Note:</b> This menu item appears only in some printer models.   |
| <b>Original Size</b><br>[List of paper sizes] (Mixed Sizes*)                        | Set the paper size of the original document.  |
| <b>Sides</b><br>Off*<br>Short Edge<br>Long Edge                                     | Specify the orientation of the original document when scanning on both sides of the document.<br><b>Note:</b> This menu item appears only in some printer models. |
| <b>File Name</b>  | Specify the file name of the scanned image.   |
| <b>Note:</b> An asterisk (*) next to a value indicates the factory default setting. |   |

### Advanced Imaging

| Menu item   | Description                                 |
|---|---|
| <b>Color Balance</b><br>Cyan to Red<br>-4 to 4 (0*)<br>Magenta to Green<br>-4 to 4 (0*)<br>Yellow to Blue<br>-4 to 4 (0*) | Adjust the color intensity during scanning. |
| <b>Note:</b> An asterisk (*) next to a value indicates the factory default setting.                                       |   |

| Menu item   | Description  |
|---|--|
| <b>Auto Color Detect</b><br>Color Sensitivity<br>1–9 (5*)<br>Area Sensitivity<br>1–9 (5*)<br>Scan Bit Depth<br>1 bit*<br>8 bit<br>Minimum Scan Resolution<br>75 dpi<br>150 dpi<br>200 dpi<br>300 dpi* | Set the amount of color that the printer detects from the original document. |
| <b>Contrast</b><br>Best for content*<br>0<br>1<br>2<br>3<br>4<br>5  | Specify the contrast of the output.  |
| <b>Background Removal</b><br>Level<br>-4 to 4 (0*)  | Adjust the amount of background visible on a scanned image.                  |
| <b>Scan Edge to Edge</b><br>On<br>Off*  | Allow edge-to-edge scanning of the original document.                        |
| <b>Note:</b> An asterisk (*) next to a value indicates the factory default setting.   |  |

### Admin Controls

| Menu item   | Description  |
|---|--|
| <b>Text Default</b><br>5–95 (75*)   | Set the quality of text on a scanned image.          |
| <b>Text/Photo Default</b><br>5–95 (75*)   | Set the quality of text or photo on a scanned image. |
| <b>Photo Default</b><br>5–95 (50*)  | Set the quality of a photo on a scanned image.       |
| <b>Note:</b> An asterisk (*) next to a value indicates the factory default setting. |  |

## Flash Drive Print

| Menu item   | Description  |
|---|--|
| <b>Number of Copies</b><br>1–9999 (1*)  | Set the number of copies.  |
| <b>Paper Source</b><br>Tray [x] (1*)<br>Manual Paper<br>Manual Envelope   | Set the paper source for the print job.  |
| <b>Color</b><br>Off<br>On*  | Print the output in color.   |
| <b>Collate</b><br>1,1,1 - 2,2,2<br>1,2,3 - 1,2,3*   | Print multiple copies in sequence.   |
| <b>Sides</b><br>1-Sided*<br>2-Sided   | Specify whether to print on one side or two sides of the paper.  |
| <b>Flip Style</b><br>Long Edge*<br>Short Edge   | Determine which side of the paper (long edge or short edge) is bound when performing two-sided printing.<br><br><b>Note:</b> Depending on the option selected, the printer automatically offsets each printed information of the page to bind the job correctly. |
| <b>Pages per Side</b><br>Off*<br>2 pages per side<br>3 pages per side<br>4 pages per side<br>6 pages per side<br>9 pages per side<br>12 pages per side<br>16 pages per side | Print multiple page images on one side of a sheet of paper.  |
| <b>Pages per Side Ordering</b><br>Horizontal*<br>Reverse Horizontal<br>Reverse Vertical<br>Vertical   | Specify the positioning of multiple page images when using Pages per Side.<br><br><b>Note:</b> The positioning depends on the number of page images and their page orientation.  |
| <b>Pages per Side Orientation</b><br>Auto*<br>Landscape<br>Portrait   | Specify the orientation of a multiple-page document when using Pages per Side.   |
| <b>Pages per Side Border</b><br>None*<br>Solid  | Print a border around each page image when using Pages per Side.   |
| <b>Note:</b> An asterisk (*) next to a value indicates the factory default setting.   |  |

| Menu item   | Description   |
|---|---|
| <b>Separator Sheets</b><br>Off*<br>Between Copies<br>Between Jobs<br>Between Pages  | Specify whether to insert blank separator sheets when printing. |
| <b>Separator Sheet Source</b><br>Tray [x] (1*)                                      | Specify the paper source for the separator sheet.               |
| <b>Blank Pages</b><br>Do Not Print*<br>Print  | Specify whether to print blank pages in a print job.            |
| <b>Note:</b> An asterisk (*) next to a value indicates the factory default setting. |   |

## Network/Ports

### Network Overview

| Menu item   | Description  |
|---|--|
| <b>Active Adapter</b><br>Auto*<br>Standard Network<br>Wireless                      | Specify the type of the network connection.  |
| <b>Network Status</b>   | Show the connectivity status of the printer network.   |
| <b>Display Network Status on Printer</b><br>Off<br>On*                              | Show the network status on the display.  |
| <b>Speed, Duplex</b>  | Show the speed of the currently active network card.   |
| <b>IPv4</b>   | Show the IPv4 address.   |
| <b>All IPv6 Addresses</b>   | Show all IPv6 addresses.   |
| <b>Reset Print Server</b><br>Start  | Reset all active network connections to the printer.<br><b>Note:</b> This setting removes all network configuration settings.                                  |
| <b>Network Job Timeout</b><br>Disabled<br>Enabled*                                  | Set the time before the printer cancels a network print job.   |
| <b>Network Job Timeout Time</b>   | Specify the timeout value (in seconds) when the Network Job Timeout setting is enabled.<br><b>Note:</b> This feature is available only in some printer models. |
| <b>Note:</b> An asterisk (*) next to a value indicates the factory default setting. |  |

| Menu item   | Description   |
|---|---|
| <b>Banner Page</b><br>Off*<br>On  | Print a banner page.  |
| <b>Scan to PC Port Range</b>  | Specify a valid port range for printers that are behind a port blocking firewall. |
| <b>Enable Network Connections</b><br>Enable*<br>Disable                             | Enable or disable all network connections.  |
| <b>Enable LLDP</b><br>Off*<br>On  | Enable Link Layer Discovery Protocol (LLDP) in the printer.                       |
| <b>Note:</b> An asterisk (*) next to a value indicates the factory default setting. |   |

## Wireless

| Menu item   | Description   |
|---|---|
| <b>Setup Using Mobile App</b>   | Configure the wireless connection using the Lexmark Mobile Assistant app.   |
| <b>Setup On Printer Panel</b><br>Choose Network<br>Add Wi-Fi Network <ul style="list-style-type: none"> <li>• Network Name</li> <li>• Network Mode               <ul style="list-style-type: none"> <li>Infrastructure</li> </ul> </li> <li>• Wireless Security Mode               <ul style="list-style-type: none"> <li>Disabled*</li> <li>WEP</li> <li>WPA2/WPA - Personal</li> <li>WPA2 - Personal</li> </ul> </li> </ul> | Determine the wireless network that the printer connects to.<br><b>Note:</b> This menu item appears as <i>Wireless Connection Setup</i> in the Embedded Web Server.   |
| <b>Wi-Fi Protected Setup</b><br>Start Push Button Method<br>Start PIN Method  | Establish a wireless network and enable network security.<br><b>Notes:</b> <ul style="list-style-type: none"> <li>• Start Push Button Method connects the printer to a wireless network when buttons on both the printer and the access point (wireless router) are pressed within a given time.</li> <li>• Start PIN Method connects the printer to a wireless network when a PIN on the printer is entered into the wireless settings of the access point.</li> </ul> |
| <b>Compatibility</b><br>802.11b/g/n (2.4GHz)<br>802.11a/b/g/n/ac (2.4GHz/5GHz)*<br>802.11a/n/ac (5GHz)  | Specify the wireless standard for the wireless network.<br><b>Note:</b> 802.11a/b/g/n/ac (2.4GHz/5GHz) and 802.11a/n/ac (5GHz) are available only in some printer models.   |



| Menu item  | Description   |
|--|---|
| <b>Wireless Security Mode</b><br>Disabled*<br>WEP<br>WPA2/WPA-Personal<br>WPA2-Personal<br>802.1x - RADIUS | Set the type of security for connecting the printer to wireless devices.  |
| <b>WEP Authentication Mode</b><br>Auto*<br>Open<br>Shared  | Set the type of Wireless Encryption Protocol (WEP) used by the printer.<br><br><b>Note:</b> This menu item appears only if Wireless Security Mode is set to WEP.  |
| <b>Set WEP Key</b>   | Specify a WEP password for secure wireless connection.<br><br><b>Note:</b> This menu item appears only if Wireless Security Mode is set to WEP.   |
| <b>WPA2-Personal</b><br>AES*   | Enable wireless security through WPA2.<br><br><b>Note:</b> This menu item appears only if Wireless Security Mode is set to WPA2-Personal.   |
| <b>Set PSK</b>   | Set the password for secure wireless connection.<br><br><b>Note:</b> This menu item appears only if Wireless Security Mode is set to either WPA2/WPA-Personal or WPA2-Personal.                           |
| <b>WPA2/WPA-Personal</b><br>AES*   | Enable wireless security through WPA2/WPA.<br><br><b>Note:</b> This menu item appears only if Wireless Security Mode is set to WPA2/WPA-Personal.   |
| <b>802.1x Encryption Mode</b><br>WPA+<br>WPA2*   | Enable wireless security through 802.1x standard.<br><br><b>Note:</b> This menu item appears only if Wireless Security Mode is set to 802.1x - Radius.  |
| <b>IPv4</b><br>Enable DHCP<br>On*<br>Off   | Enable Dynamic Host Configuration Protocol (DHCP).<br><br><b>Note:</b> DHCP is a standard protocol that allows a server to distribute IP addressing and configuration information dynamically to clients. |
| <b>IPv4</b><br>Set Static IP Address<br>IP Address<br>Netmask<br>Gateway                                   | Set the static IP address of your printer.  |
| <b>IPv6</b><br>Enable IPv6<br>On*<br>Off   | Enable IPv6 in the printer.   |
| <b>IPv6</b><br>Enable DHCPv6<br>On<br>Off*   | Enable DHCPv6 in the printer.   |

| Menu item  | Description  |
|--|--|
| <b>IPv6</b><br>Stateless Address Autoconfiguration<br>Off<br>On* | Set the network adapter to accept the automatic IPv6 address configuration entries provided by a router.   |
| <b>IPv6</b><br>DNS Address                                       | Specify the DNS server address.  |
| <b>IPv6</b><br>Manually Assigned IPV6 Address                    | Assign the IPv6 address.<br><b>Note:</b> This menu item appears only in some printer models.   |
| <b>IPv6</b><br>Manually Assigned IPV6 Router                     | Assign the IPv6 router address.<br><b>Note:</b> This menu item appears only in some printer models.  |
| <b>IPv6</b><br>Address Prefix<br>0–128 (64*)                     | Specify the address prefix.  |
| <b>IPv6</b><br>All IPv6 Addresses                                | Show all IPv6 addresses.   |
| <b>IPv6</b><br>All IPv6 Router Addresses                         | Show all IPv6 router addresses.  |
| <b>Network Address</b><br>UAA<br>LAA                             | View the network addresses.  |
| <b>PCL SmartSwitch</b><br>On*<br>Off                             | Set the printer to switch automatically to PCL emulation when a print job requires it, regardless of the default printer language.<br><b>Note:</b> If PCL SmartSwitch is off, then the printer does not examine incoming data and uses the default printer language specified in the Setup menu. |
| <b>PS SmartSwitch</b><br>On*<br>Off*                             | Set the printer to switch automatically to PS emulation when a print job requires it, regardless of the default printer language.<br><b>Note:</b> If PS SmartSwitch is off, then the printer does not examine incoming data and uses the default printer language specified in the Setup menu.   |
| <b>Mac Binary PS</b><br>Auto*<br>On<br>Off                       | Set the printer to process Macintosh binary PostScript print jobs.<br><b>Notes:</b> <ul style="list-style-type: none"> <li>• On processes raw binary PostScript print jobs.</li> <li>• Off filters print jobs using the standard protocol.</li> </ul>  |

## Wi-Fi Direct

| Menu item   | Description  |
|---|--|
| <b>Enable Wi-Fi Direct</b><br>On<br>Off*  | Set the printer to connect directly to Wi-Fi devices.  |
| <b>Wi-Fi Direct Name</b>  | Specify the name of the Wi-Fi Direct network.  |
| <b>Wi-Fi Direct Password</b>  | Set the password to authenticate and validate users on a Wi-Fi connection.   |
| <b>Show Password on Setup Page</b><br>Off<br>On*                                    | Show the Wi-Fi Direct Password on the Network Setup Page.  |
| <b>Preferred Channel Number</b><br>1–11<br>Auto*                                    | Set the preferred channel of the Wi-Fi network.  |
| <b>Group Owner IP Address</b>   | Specify the IP address of the group owner.   |
| <b>Auto-Accept Push Button Requests</b><br>Off*<br>On                               | Accept requests to connect to the network automatically.<br><b>Note:</b> Accepting clients automatically is not secured. |
| <b>Note:</b> An asterisk (*) next to a value indicates the factory default setting. |  |

## Ethernet

| Menu item   | Description   |
|---|---|
| <b>Network Speed</b>  | Show the speed of an active network adapter.  |
| <b>IPv4</b><br>Enable DHCP<br>On*<br>Off  | Enable Dynamic Host Configuration Protocol (DHCP).<br><b>Note:</b> DHCP is a standard protocol that allows a server to distribute IP addressing and configuration information to clients in a dynamic manner. |
| <b>IPv4</b><br>Set Static IP Address<br>IP Address<br>Netmask<br>Gateway            | Set the static IP address of your printer.  |
| <b>IPv6</b><br>Enable IPv6<br>Off<br>On*  | Enable IPv6 in the printer.   |
| <b>Note:</b> An asterisk (*) next to a value indicates the factory default setting. |   |

| Menu item   | Description  |
|---|--|
| <b>IPv6</b><br>Enable DHCPv6<br>Off*<br>On  | Enable DHCPv6 in the printer.  |
| <b>IPv6</b><br>Stateless Address<br>Autoconfiguration<br>Off<br>On*                 | Set the network adapter to accept the automatic IPv6 address configuration entries provided by a router.   |
| <b>IPv6</b><br>DNS Address  | Specify the DNS server address.  |
| <b>IPv6</b><br>Manually Assigned IPV6<br>Address                                    | Assign the IPv6 address.<br><b>Note:</b> This menu item appears only in some printer models.   |
| <b>IPv6</b><br>Manually Assigned IPV6 Router  | Assign the IPv6 router address.<br><b>Note:</b> This menu item appears only in some printer models.  |
| <b>IPv6</b><br>Address Prefix<br>0–128 (64*)  | Specify the address prefix.  |
| <b>IPv6</b><br>All IPv6 Addresses   | Show all IPv6 addresses.   |
| <b>IPv6</b><br>All IPv6 Router Addresses  | Show all IPv6 router addresses.  |
| <b>Network Address</b><br>UAA<br>LAA  | Show the printer Media Access Control (MAC) addresses: Locally Administered Address (LAA) and Universally Administered Address (UAA).<br><b>Note:</b> You can change the printer LAA manually.   |
| <b>PCL SmartSwitch</b><br>Off<br>On*  | Set the printer to switch automatically to PCL emulation when a print job requires it, regardless of the default printer language.<br><b>Note:</b> If PCL SmartSwitch is off, then the printer does not examine incoming data and uses the default printer language specified in the Setup menu. |
| <b>PS SmartSwitch</b><br>On*<br>Off*  | Set the printer to switch automatically to PS emulation when a print job requires it, regardless of the default printer language.<br><b>Note:</b> If PS SmartSwitch is off, then the printer does not examine incoming data and uses the default printer language specified in the Setup menu.   |
| <b>Mac Binary PS</b><br>Auto*<br>On<br>Off  | Set the printer to process Macintosh binary PostScript print jobs.<br><b>Notes:</b> <ul style="list-style-type: none"> <li>• On processes raw binary PostScript print jobs.</li> <li>• Off filters print jobs using the standard protocol.</li> </ul>  |
| <b>Note:</b> An asterisk (*) next to a value indicates the factory default setting. |  |

| Menu item   | Description  |
|---|--|
| <b>Energy Efficient Ethernet</b><br>Off<br>On<br>Auto*                              | Reduce power consumption when the printer does not receive data from the Ethernet network. |
| <b>Note:</b> An asterisk (*) next to a value indicates the factory default setting. |  |

## TCP/IP

**Note:** This menu appears only in network printers or printers attached to print servers.

| Menu item   | Description   |
|---|---|
| <b>Set Hostname</b>   | Set the current TCP/IP host name.   |
| <b>Domain Name</b>  | Set the domain name.  |
| <b>Allow DHCP/BOOTP to update NTP server</b><br>On*<br>Off                          | Allow the DHCP and BOOTP clients to update the NTP settings of the printer.   |
| <b>Zero Configuration Name</b>  | Specify a service name for the zero configuration network.  |
| <b>Enable Auto IP</b><br>On*<br>Off   | Assign an IP address automatically.   |
| <b>DNS Address</b>  | Specify the current Domain Name System (DNS) server address.  |
| <b>Backup DNS</b>   | Specify the backup DNS server addresses.  |
| <b>Backup DNS 2</b>   |   |
| <b>Backup DNS 3</b>   |   |
| <b>Domain Search Order</b>  | Specify a list of domain names to locate the printer and its resources that reside in different domains on the network. |
| <b>Enable DDNS</b><br>Off*<br>On  | Update the Dynamic DNS settings.  |
| <b>DDNS TTL</b>   | Specify the current DDNS settings.  |
| <b>Default TTL</b>  |   |
| <b>DDNS Refresh Time</b>  |   |
| <b>Enable mDNS</b><br>On*<br>Off  | Update multicast DNS settings.  |
| <b>WINS Address</b>   | Specify a server address for Windows Internet Name Service (WINS).  |
| <b>Note:</b> An asterisk (*) next to a value indicates the factory default setting. |   |

| Menu item  | Description   |
|--|---|
| <b>Enable BOOTP</b><br>Off*<br>On  | Allow the BOOTP to assign a printer IP address.   |
| <b>Restricted Server List</b>  | Specify an IP address for the TCP connections.<br><b>Notes:</b> <ul style="list-style-type: none"> <li>• This menu item appears only in the Embedded Web Server.</li> <li>• Use a comma to separate each IP address.</li> <li>• You can add up to 50 IP addresses.</li> </ul> |
| <b>Restricted Server List Options</b><br>Block All Ports*<br>Block Printing Only<br>Block Printing and HTTP Only | Specify how the IP addresses in the list can access the printer functionality.<br><b>Note:</b> This menu item appears only in the Embedded Web Server.  |
| <b>MTU</b>   | Specify a maximum transmission unit (MTU) parameter for the TCP connections.  |
| <b>Raw Print Port</b><br>1–65535 (9100*)   | Specify a raw port number for printers connected on a network.  |
| <b>Outbound Traffic Maximum Speed</b><br>Disabled*<br>Enabled  | Enable the printer maximum transfer rate.   |
| <b>Enable TLSv1.0</b><br>On*<br>Off  | Enable the TLSv1.0 protocol.  |
| <b>Enable TLSv1.1</b><br>On*<br>Off  | Enable the TLSv1.1 protocol.  |
| <b>SSL Cipher List</b>   | Specify the cipher algorithms to use for the SSL or the TLS connections.  |
| <b>Note:</b> An asterisk (*) next to a value indicates the factory default setting.                              |   |

## SNMP

**Note:** This menu appears only in network printers or printers that are attached to print servers.

| Menu item   | Description   |
|---|---|
| <p><b>SNMP Versions 1 and 2c</b></p> <ul style="list-style-type: none"> <li>Enabled</li> <li>Off</li> <li>On*</li> <li>Allow SNMP Set</li> <li>Off</li> <li>On*</li> <li>Enable PPM MIB</li> <li>Off</li> <li>On*</li> <li>SNMP Community</li> </ul>  | <p>Configure Simple Network Management Protocol (SNMP) versions 1 and 2c to install print drivers and applications.</p> |
| <p><b>SNMP Version 3</b></p> <ul style="list-style-type: none"> <li>Enabled</li> <li>Off</li> <li>On*</li> <li>Context Name</li> <li>Set Read/Write Credentials                             <ul style="list-style-type: none"> <li>User Name</li> <li>Authentication Password</li> <li>Privacy Password</li> </ul> </li> <li>Set Read-only Credentials                             <ul style="list-style-type: none"> <li>User Name</li> <li>Authentication Password</li> <li>Privacy Password</li> </ul> </li> <li>Authentication Hash                             <ul style="list-style-type: none"> <li>MD5</li> <li>SHA1*</li> </ul> </li> <li>Minimum Authentication Level                             <ul style="list-style-type: none"> <li>No Authentication, No Privacy</li> <li>Authentication, No Privacy</li> <li>Authentication, Privacy*</li> </ul> </li> <li>Privacy Algorithm                             <ul style="list-style-type: none"> <li>DES</li> <li>AES-128*</li> </ul> </li> </ul> | <p>Configure SNMP version 3 to install and update the printer security.</p>   |

**Note:** An asterisk (\*) next to a value indicates the factory default setting.

## IPSec

**Note:** This menu appears only in network printers or printers that are attached to print servers.

| Menu item  | Description  |
|--|--|
| <b>Enable IPsec</b><br>Off*<br>On  | Enable Internet Protocol Security (IPsec).   |
| <b>Base Configuration</b><br>Default*<br>Compatibility<br>Secure   | Set the IPsec base configuration.<br><b>Note:</b> This menu item appears only when Enable IPsec is set to On.  |
| <b>DH (Diffie-Hellman) Group Proposal</b><br>modp2048 (14)*<br>modp3072 (15)<br>modp4069 (16)<br>modp6144 (17) | Set the IPsec encryption.<br><b>Notes:</b> <ul style="list-style-type: none"> <li>DH (Diffie-Hellman) Group Proposal appears only when Base Configuration is set to Compatibility.</li> <li>IKE SA Lifetime (Hours) and IPsec SA Lifetime (Hours) appear only when Base Configuration is set to Secure.</li> </ul> |
| <b>IKE SA Lifetime (Hours)</b><br>1<br>2<br>4<br>8<br>24*  |  |
| <b>IPsec SA Lifetime (Hours)</b><br>1<br>2<br>4<br>8*<br>24  |  |
| <b>Proposed Encryption Method</b><br>3DES<br>AES*  | Specify the encryption and authentication methods to connect to a network securely.<br><b>Note:</b> These menu items appear only when Base Configuration is set to Compatibility.  |
| <b>Proposed Authentication Method</b><br>SHA1<br>SHA256*<br>SHA512   |  |
| <b>IPsec Device Certificate</b>  | Specify an IPsec certificate.<br><b>Note:</b> This menu item appears only when Enable IPsec is set to On.  |
| <b>Note:</b> An asterisk (*) next to a value indicates the factory default setting.                            |  |



| Menu item   | Description  |
|---|--|
| <b>Pre-Shared Key Authenticated Connections</b><br>Host [x]<br>Address<br>Key                 | Configure the authenticated connections of the printer.<br><b>Note:</b> These menu items appear only when Enable IPsec is set to On. |
| <b>Certificate Authenticated Connections</b><br>Host [x] Address[/subnet]<br>Address[/subnet] |  |
| <b>Note:</b> An asterisk (*) next to a value indicates the factory default setting.           |  |

## 802.1x

**Note:** This menu appears only in network printers or printers that are attached to print servers.

| Menu item   | Description   |
|---|---|
| <b>Active</b><br>Off*<br>On   | Let the printer join networks that require authentication before allowing access. |
| <b>Note:</b> An asterisk (*) next to a value indicates the factory default setting. |   |

## LPD Configuration

**Note:** This menu appears only in network printers or printers that are attached to print servers.

| Menu item   | Description   |
|---|---|
| <b>LPD Timeout</b><br>0–65535 seconds (90*)   | Set the time-out value to stop the Line Printer Daemon (LPD) server from waiting indefinitely for hung or invalid print jobs.   |
| <b>LPD Banner Page</b><br>Off*<br>On  | Print a banner page for all LPD print jobs.<br><b>Note:</b> A banner page is the first page of a print job used as a separator of print jobs and to identify the originator of the print job request. |
| <b>LPD Trailer Page</b><br>Off*<br>On   | Print a trailer page for all LPD print jobs.<br><b>Note:</b> A trailer page is the last page of a print job.  |
| <b>LPD Carriage Return Conversion</b><br>Off*<br>On                                 | Enable carriage return conversion.<br><b>Note:</b> Carriage return is a mechanism that commands the printer to move the position of the cursor to the first position on the same line.                |
| <b>Note:</b> An asterisk (*) next to a value indicates the factory default setting. |   |

## HTTP/FTP Settings

| Menu item   | Description  |
|---|--|
| <b>Enable HTTP Server</b><br>Off<br>On*   | Access the Embedded Web Server to monitor and manage the printer.  |
| <b>Enable HTTPS</b><br>Off<br>On*   | Configure the Hypertext Transfer Protocol Secure (HTTPS) settings.   |
| <b>Force HTTPS Connections</b><br>On<br>Off*  | Force the printer to use the HTTPS connections.  |
| <b>Enable FTP/TFTP</b><br>Off<br>On*  | Send files using FTP.  |
| <b>Local Domains</b>  | Specify domain names for HTTP and FTP servers.<br><b>Note:</b> This menu item appears only in the Embedded Web Server. |
| <b>HTTP Proxy IP Address</b>  | Configure the HTTP and FTP server settings.  |
| <b>FTP Proxy IP Address</b>   |  |
| <b>HTTP Default IP Port</b><br>1–65535 (80*)  |  |
| <b>HTTPS Device Certificate</b>   |  |
| <b>FTP Default IP Port</b><br>1–65535 (21*)   |  |
| <b>Timeout for HTTP/FTP Requests</b><br>1–299 (30*)                                 | Specify the amount of time before the server connection stops.   |
| <b>Retries for HTTP/FTP Requests</b><br>1–299 (3*)                                  | Set the number of retries to connect to the HTTP/FTP server.   |
| <b>Note:</b> An asterisk (*) next to a value indicates the factory default setting. |  |

## USB

| Menu item   | Description  |
|---|--|
| <b>PCL SmartSwitch</b><br>Off<br>On*  | Set the printer to switch to PCL emulation when a print job received through a USB port requires it, regardless of the default printer language.<br><b>Note:</b> If PCL SmartSwitch is off, then the printer does not examine incoming data and uses the default printer language specified in the Setup menu. |
| <b>Note:</b> An asterisk (*) next to a value indicates the factory default setting. |  |

| Menu item   | Description   |
|---|---|
| <b>PS SmartSwitch</b><br>Off<br>On*   | Set the printer to switch to PS emulation when a print job received through a USB port requires it, regardless of the default printer language.<br><br><b>Note:</b> If PS SmartSwitch is off, then the printer does not examine incoming data and uses the default printer language specified in the Setup menu.  |
| <b>Mac Binary PS</b><br>On<br>Auto*<br>Off  | Set the printer to process Macintosh binary PostScript print jobs.<br><br><b>Notes:</b> <ul style="list-style-type: none"> <li>• When set to On, the printer processes raw binary PostScript print jobs from computers using the Macintosh operating system.</li> <li>• When set to Auto, the printer processes print jobs from computers using either Windows or Macintosh operating systems</li> <li>• When set to Off, the printer filters PostScript print jobs using the standard protocol.</li> </ul> |
| <b>Enable USB Port</b><br>Disable<br>Enable*  | Enable the standard USB port.   |
| <b>Note:</b> An asterisk (*) next to a value indicates the factory default setting. |   |

## Restrict external network access

| Menu item   | Description  |
|---|--|
| <b>Restrict external network access</b><br>Off*<br>On                               | Restrict access to network sites.                                  |
| <b>External network address</b>   | Specify the network addresses with restricted access.              |
| <b>E-mail address for notification</b>  | Specify an e-mail address to send a notification of logged events. |
| <b>Ping frequency</b><br>1–300 (10*)  | Specify the network query interval in seconds.                     |
| <b>Subject</b>  | Specify the subject and message of the notification e-mail.        |
| <b>Message</b>  |  |
| <b>Note:</b> An asterisk (*) next to a value indicates the factory default setting. |  |

# Security

## Login Methods

### Public

| Menu item  | Description                              |
|--|--|
| <b>Manage Permissions</b><br>Function Access<br>Manage Shortcuts<br>Create Profiles<br>Manage Bookmarks<br>Flash Drive Print<br>Flash Drive Color Printing<br>Flash Drive Scan<br>Copy Function<br>Copy Color Printing<br>E-mail Function<br>Fax Function<br>FTP Function<br>Release Held Faxes<br>Held Jobs Access<br>User Profiles<br>Cancel Jobs at the Device<br>Change Language<br>Internet Printing Protocol (IPP)<br>Initiate Scans Remotely<br>B/W Print<br>Color Print<br>Network Folder - Scan | Control access to the printer functions. |
| <b>Manage Permissions</b><br>Administrative Menus<br>Security Menu<br>Network/Ports Menu<br>Paper Menu<br>Reports Menu<br>Function Configuration Menus<br>Supplies Menu<br>SE Menu<br>Device Menu  | Control access to the printer menus.     |

| Menu item   | Description                                       |
|---|---|
| <b>Manage Permissions</b><br>Device Management<br>Remote Management<br>Firmware Updates<br>Embedded Web Server Access<br>Import / Export All Settings<br>Out of Service Erase | Control access to the printer management options. |

### Local Accounts

| Menu item   | Description   |
|---|---|
| <b>Add User</b><br>User Name/Password<br>User Name<br>Password<br>PIN   | Create local accounts to manage access to the printer functions.                            |
| <b>Manage Groups/Permissions</b><br>Add Group<br>Import Access Controls<br>Function Access<br>Administrative Menus<br>Device Management<br>All Users<br>Import Access Controls<br>Function Access<br>Administrative Menus<br>Device Management<br>Admin<br>Function Access<br>Administrative Menus<br>Device Management | Control group or user access to the printer functions, applications, and security settings. |

### Certificate Management

| Menu item  | Menu item  |
|--|--|
| <b>Configure Certificate Defaults</b><br>Common Name<br>Organization Name<br>Unit Name<br>Country/Region<br>Province Name<br>City Name<br>Subject Alternate Name | Set the default values for generated certificates. |

| Menu item              | Menu item  |
|------------------------|--|
| Device Certificates    | Generate, delete, or view device certificates.                 |
| Manage CA Certificates | Load, delete, or view Certificate Authority (CA) certificates. |

## Schedule USB Devices

| Menu item                            | Description                            |
|--------------------------------------|--|
| <b>Schedules</b><br>Add New Schedule | Schedule access to the front USB port. |

## Login Restrictions

| Menu item   | Description   |
|---|---|
| <b>Login failures</b><br>1–10 (3*)  | Specify the number of failed login attempts before the user gets locked out.          |
| <b>Failure time frame</b><br>1–60 minutes (5*)                                      | Specify the time frame between failed login attempts before the user gets locked out. |
| <b>Lockout time</b><br>1–60 minutes (5*)  | Specify the lockout duration.   |
| <b>Web Login Timeout</b><br>1–120 minutes (10*)                                     | Specify the delay for a remote login before the user is logged off automatically.     |
| <b>Note:</b> An asterisk (*) next to a value indicates the factory default setting. |   |

## Confidential Print Setup

| Menu item   | Description  |
|---|--|
| <b>Max Invalid PIN</b><br>2–10 (0*)   | Set the number of times an invalid PIN can be entered.<br><b>Notes:</b> <ul style="list-style-type: none"> <li>• A value of zero turns off this setting.</li> <li>• When the limit is reached, the print jobs for that user name and PIN are deleted.</li> </ul>   |
| <b>Confidential Job Expiration</b><br>Off*<br>1 Hour<br>4 Hours<br>24 Hours<br>1 Week | Set the expiration time for confidential print jobs.<br><b>Notes:</b> <ul style="list-style-type: none"> <li>• If this menu item is changed while confidential print jobs reside in the printer memory, then the expiration time for those print jobs does not change to the new default value.</li> <li>• If the printer is turned off, then all confidential jobs held in the printer memory are deleted.</li> </ul> |
| <b>Note:</b> An asterisk (*) next to a value indicates the factory default setting.   |  |

| Menu item   | Description   |
|---|---|
| <b>Repeat Job Expiration</b><br>Off*<br>1 Hour<br>4 Hours<br>24 Hours<br>1 Week     | Set the expiration time for a print job that you want to repeat.  |
| <b>Verify Job Expiration</b><br>Off*<br>1 Hour<br>4 Hours<br>24 Hours<br>1 Week     | Set the expiration time that the printer prints a copy for the user to examine its quality, before printing the remaining copies. |
| <b>Reserve Job Expiration</b><br>Off*<br>1 Hour<br>4 Hours<br>24 Hours<br>1 Week    | Set the expiration time that the printer stores print jobs for printing later.  |
| <b>Require All Jobs to be Held</b><br>Off*<br>On                                    | Set the printer to hold all print jobs.   |
| <b>Keep duplicate documents</b><br>Off*<br>On                                       | Allow the storage of documents with the same file name.   |
| <b>Note:</b> An asterisk (*) next to a value indicates the factory default setting. |   |

## Erase Temporary Data Files

| Menu item   | Description                                    |
|---|--|
| <b>Stored in onboard memory</b><br>Off*<br>On                                       | Delete all files stored on the printer memory. |
| <b>Note:</b> An asterisk (*) next to a value indicates the factory default setting. |  |

## Miscellaneous

| Menu item   | Description              |
|---|--------------------------|
| <b>Print Permission</b><br>Off*<br>On   | Allow the user to print. |
| <b>Note:</b> An asterisk (*) next to a value indicates the factory default setting. |                          |

| Menu item   | Description  |
|---|--|
| <b>Default Print Permission Login</b>   | Shows the default permission used for the user to print.<br><b>Note:</b> This setting shows only when one or more Login Methods are created.   |
| <b>Security Reset Jumper</b><br>Enable "Guest" access*<br>No Effect                 | Specify user access to the printer.<br><b>Notes:</b> <ul style="list-style-type: none"> <li>• The jumper is located beside a lock icon on the controller board.</li> <li>• Enable "Guest" access gives anyone access to all aspects of the printer.</li> <li>• No Effect may make access to the printer impossible when the required security information is unavailable.</li> </ul> |
| <b>Minimum Password Length</b><br>0–32  | Specify the password length.   |
| <b>Enable Password/PIN Reveal</b>   | Show the password or personal identification number.   |
| <b>Note:</b> An asterisk (*) next to a value indicates the factory default setting. |  |

## Cloud Connector

| Menu item                        | Description                      |
|----------------------------------|----------------------------------|
| <b>Enable/Disable Connectors</b> | Enable a cloud storage provider. |

## Reports

### Menu Settings Page

| Menu item                 | Description                                     |
|---------------------------|---|
| <b>Menu Settings Page</b> | Print a report that contains the printer menus. |

### Device

| Menu item                 | Description  |
|---------------------------|--|
| <b>Device Information</b> | Print a report that contains information about the printer.            |
| <b>Device Statistics</b>  | Print a report about printer usage and supply status.                  |
| <b>Profile List</b>       | Print a list of profiles that are stored in the printer.               |
| <b>Asset Report</b>       | Print a report that contains the printer serial number and model name. |



## Print

| Menu item   | Description  |
|---|--|
| <b>Print Fonts</b><br>PCL Fonts<br>PostScript Fonts | Print samples and information about the fonts that are available in each printer language. |
| <b>Print Demo</b><br>Demo Page                      | Print a demo page that is used as a diagnostic tool for print problems.                    |

## Shortcuts

| Menu item                       | Description  |
|---------------------------------|--|
| <b>All Shortcuts</b>            | Print a report that lists the shortcuts that are stored in the printer.<br><br><b>Note:</b> Fax Shortcuts appears only in some printer models. |
| <b>Fax Shortcuts</b>            |  |
| <b>Copy Shortcuts</b>           |  |
| <b>E-mail Shortcuts</b>         |  |
| <b>FTP Shortcuts</b>            |  |
| <b>Network Folder Shortcuts</b> |  |

## Fax

**Note:** This menu appears only if Fax is configured, and Enable Job Log is set to On.

| Menu item           | Description   |
|---------------------|---|
| <b>Fax Job Log</b>  | Print a report about the last 200 completed fax jobs.                     |
| <b>Fax Call Log</b> | Print a report about the last 100 attempted, received, and blocked calls. |

## Network

| Menu item                             | Description  |
|---------------------------------------|--|
| <b>Network Setup Page</b>             | Print a page that shows the configured network and wireless settings on the printer.<br><br><b>Note:</b> This menu item appears only in network printers or printers connected to print servers. |
| <b>Wi-Fi Direct Connected Clients</b> | Print a page that shows the list of devices that are connected to the printer using Wi-Fi Direct.<br><br><b>Note:</b> This menu item appears only when Enable Wi-Fi Direct is set to On.         |

## Troubleshooting

| Menu item                       | Description   |
|---------------------------------|---|
| <b>Print Quality Test Pages</b> | Print sample pages to identify and correct print quality defects. |
| <b>Cleaning the Scanner</b>     | Print instructions on how to clean the scanner.                   |

# Maintain the printer

## Checking the status of parts and supplies

- 1 From the home screen, touch **Status/Supplies**.
- 2 Select the parts or supplies that you want to check.

**Note:** You can also access this setting by touching the top section of the home screen.

## Configuring supply notifications

- 1 Open a web browser, and then type the printer IP address in the address field.

**Notes:**

- View the printer IP address on the printer home screen. The IP address appears as four sets of numbers separated by periods, such as 123.123.123.123.
- If you are using a proxy server, then temporarily disable it to load the web page correctly.

- 2 Click **Settings > Device > Notifications**.
- 3 From the Supplies menu, click **Custom Supply Notifications**.
- 4 Select a notification for each supply item.
- 5 Apply the changes.

## Setting up e-mail alerts

Configure the printer to send e-mail alerts when supplies are low, when paper must be changed or added, or when there is a paper jam.

- 1 Open a web browser, and then type the printer IP address in the address field.

**Notes:**

- View the printer IP address on the printer home screen. The IP address appears as four sets of numbers separated by periods, such as 123.123.123.123.
- If you are using a proxy server, then temporarily disable it to load the web page correctly.

- 2 Click **Settings > Device > Notifications > E-mail Alert Setup**, and then configure the settings.

**Note:** For more information on SMTP settings, contact your e-mail provider.

- 3 Click **Setup E-mail Lists and Alerts**, and then configure the settings.
- 4 Apply the changes.

## Viewing reports

- 1 From the home screen, touch **Settings > Reports**.
- 2 Select the report that you want to view.

## Ordering parts and supplies

To order supplies in the U.S., contact Lexmark at 1-800-539-6275 for information about Lexmark authorized supplies dealers in your area. In other countries or regions, go to [www.lexmark.com](http://www.lexmark.com) or contact the place where you purchased the printer.

**Note:** All life estimates for printer supplies assume printing on letter- or A4-size plain paper.

**Warning—Potential Damage:** Failure to maintain optimum printer performance, or to replace parts and supplies, may cause damage to your printer.

## Using genuine Lexmark parts and supplies

Your Lexmark printer is designed to function best with genuine Lexmark parts and supplies. Use of third-party supplies or parts may affect the performance, reliability, or life of the printer and its imaging components. It can also affect warranty coverage. Damage caused by the use of third-party parts and supplies is not covered by the warranty. All life indicators are designed to function with Lexmark parts and supplies, and may deliver unpredictable results if third-party parts and supplies are used. Imaging component usage beyond the intended life may damage your Lexmark printer or its associated components.

**Warning—Potential Damage:** Supplies and parts without Return Program agreement terms may be reset and remanufactured. However, the manufacturer's warranty does not cover any damage caused by non-genuine supplies or parts. Resetting counters on the supply or part without proper remanufacturing can cause damage to your printer. After resetting the supply or part counter, your printer may display an error indicating the presence of the reset item.

## Ordering print cartridges

### Notes:

- The estimated cartridge yield is based on the ISO/IEC 19798 standard.
- Extremely low print coverage for extended periods of time may negatively affect actual yield.

### Lexmark CX331, CX431 Return Program print cartridges

| Item                                   | United States and Canada | European Economic Area | Asia Pacific | Latin America | Rest of Europe, Middle East, and Africa |
|--|--------------------------|------------------------|--------------|---------------|---|
| <b>Return Program print cartridges</b> |                          |                        |              |               |   |
| Cyan                                   | 20N10C0                  | 20N20C0                | 20N30C0      | 20N40C0       | 20N50C0                                 |
| Magenta                                | 20N10M0                  | 20N20M0                | 20N30M0      | 20N40M0       | 20N50M0                                 |
| Yellow                                 | 20N10Y0                  | 20N20Y0                | 20N30Y0      | 20N40Y0       | 20N50Y0                                 |
| Black                                  | 20N10K0                  | 20N20K0                | 20N30K0      | 20N40K0       | 20N50K0                                 |

### High yield Return Program print cartridges<sup>1</sup>

<sup>1</sup> Supported only in the Lexmark CX331 printer model.

<sup>2</sup> Supported only in the Lexmark CX431 printer model.

For more information on countries located in each region, go to [www.lexmark.com/regions](http://www.lexmark.com/regions).

| Item   | United States and Canada | European Economic Area | Asia Pacific | Latin America | Rest of Europe, Middle East, and Africa |
|--|--------------------------|------------------------|--------------|---------------|---|
| Cyan   | 20N1HC0                  | 20N2HC0                | 20N3HC0      | 20N4HC0       | 20N5HC0                                 |
| Magenta  | 20N1HM0                  | 20N2HM0                | 20N3HM0      | 20N4HM0       | 20N5HM0                                 |
| Yellow   | 20N1HY0                  | 20N2HY0                | 20N3HY0      | 20N4HY0       | 20N5HY0                                 |
| Black  | 20N1HK0                  | 20N2HK0                | 20N3HK0      | 20N4HK0       | 20N5HK0                                 |
| <b>Extra high yield Return Program print cartridges<sup>2</sup></b>  |                          |                        |              |               |   |
| Cyan   | 20N1XC0                  | 20N2XC0                | 20N3XC0      | 20N4XC0       | 20N5XC0                                 |
| Magenta  | 20N1XM0                  | 20N2XM0                | 20N3XM0      | 20N4XM0       | 20N5XM0                                 |
| Yellow   | 20N1XY0                  | 20N2XY0                | 20N3XY0      | 20N4XY0       | 20N5XY0                                 |
| Black  | 20N1XK0                  | 20N2XK0                | 20N3XK0      | 20N4XK0       | 20N5XK0                                 |
| <sup>1</sup> Supported only in the Lexmark CX331 printer model.<br><sup>2</sup> Supported only in the Lexmark CX431 printer model.<br>For more information on countries located in each region, go to <a href="http://www.lexmark.com/regions">www.lexmark.com/regions</a> . |                          |                        |              |               |   |

### Lexmark CX331 Regular high yield print cartridges

| Item    | Part number |
|---------|-------------|
| Cyan    | 20N0H20     |
| Magenta | 20N0H30     |
| Yellow  | 20N0H40     |
| Black   | 20N0H10     |

### Lexmark CX431 Regular extra high yield print cartridges

| Item    | Part number |
|---------|-------------|
| Cyan    | 20N0X20     |
| Magenta | 20N0X30     |
| Yellow  | 20N0X40     |
| Black   | 20N0X10     |

### Lexmark MC3224, MC3326, and MC3426 Return Program print cartridges

| Item   | United States and Canada | European Economic Area | Asia Pacific | Latin America Distribution | Rest of Europe, Middle East, and Africa |
|--|--------------------------|------------------------|--------------|----------------------------|---|
| <b>Return Program print cartridges</b>   |                          |                        |              |                            |   |
| Cyan   | C3210C0                  | C3220C0                | C3230C0      | C3240C0                    | C3250C0                                 |
| <sup>1</sup> Supported only in the Lexmark MC3326 printer model.<br><sup>2</sup> Supported only in the Lexmark MC3426 printer model. |                          |                        |              |                            |   |

| Item  | United States and Canada | European Economic Area | Asia Pacific | Latin America Distribution | Rest of Europe, Middle East, and Africa |
|---|--------------------------|------------------------|--------------|----------------------------|---|
| Magenta   | C3210M0                  | C3220M0                | C3230M0      | C3240M0                    | C3250M0                                 |
| Yellow  | C3210Y0                  | C3220Y0                | C3230Y0      | C3240Y0                    | C3250Y0                                 |
| Black   | C3210K0                  | C3220K0                | C3230K0      | C3240K0                    | C3250K0                                 |
| <b>High yield Return Program print cartridges<sup>1</sup></b>       |                          |                        |              |                            |   |
| Cyan  | C331HC0                  | C332HC0                | C333HC0      | C334HC0                    | C335HC0                                 |
| Magenta   | C331HM0                  | C332HM0                | C333HM0      | C334HM0                    | C335HM0                                 |
| Yellow  | C331HY0                  | C332HY0                | C333HY0      | C334HY0                    | C335HY0                                 |
| Black   | C331HK0                  | C332HK0                | C333HK0      | C334HK0                    | C335HK0                                 |
| <b>Extra high yield Return Program print cartridges<sup>2</sup></b> |                          |                        |              |                            |   |
| Cyan  | C341XC0                  | C342XC0                | C343XC0      | C344XC0                    | C345XC0                                 |
| Magenta   | C341XM0                  | C342XM0                | C343XM0      | C344XM0                    | C345XM0                                 |
| Yellow  | C341XY0                  | C342XY0                | C343XY0      | C344XY0                    | C345XY0                                 |
| Black   | C341XK0                  | C342XK0                | C343XK0      | C344XK0                    | C345XK0                                 |
| <sup>1</sup> Supported only in the Lexmark MC3326 printer model.    |                          |                        |              |                            |   |
| <sup>2</sup> Supported only in the Lexmark MC3426 printer model.    |                          |                        |              |                            |   |

### Lexmark MC3224 Regular print cartridges

| Item    | Part number |
|---------|-------------|
| Cyan    | C320020     |
| Magenta | C320030     |
| Yellow  | C320040     |
| Black   | C320010     |

### Lexmark MC3326 Regular high yield print cartridges

| Item    | Part number |
|---------|-------------|
| Cyan    | C330H20     |
| Magenta | C330H30     |
| Yellow  | C330H40     |
| Black   | C330H10     |

### Lexmark MC3426 Regular extra high yield print cartridges

| Item    | Part number |
|---------|-------------|
| Cyan    | C340X20     |
| Magenta | C340X30     |

| Item   | Part number |
|--------|-------------|
| Yellow | C340X40     |
| Black  | C340X10     |

### Lexmark XC2326 Regular print cartridges

| Item    | United States and Canada | Europe, Middle East, Africa, and Mexico |
|---------|--------------------------|---|
| Cyan    | 24B7495                  | 24B7499                                 |
| Magenta | 24B7496                  | 24B7500                                 |
| Yellow  | 24B7497                  | 24B7501                                 |
| Black   | 24B7498                  | 24B7502                                 |

### Ordering a waste toner bottle

| Item               | Part number |
|--------------------|-------------|
| Waste toner bottle | 20NOW00     |

## Replacing parts and supplies

### Replacing a print cartridge

**Note:** If the tray is extended, then remove it before replacing a cartridge.

- 1 Open the front door, and then firmly push it down.

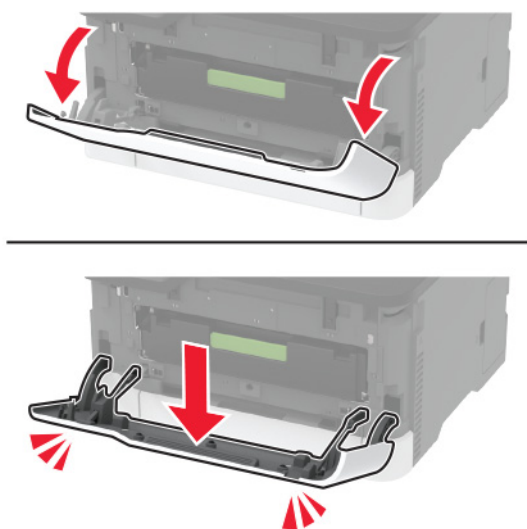

- 2 Pull out the print cartridge tray.



- 3 Remove the used print cartridge.

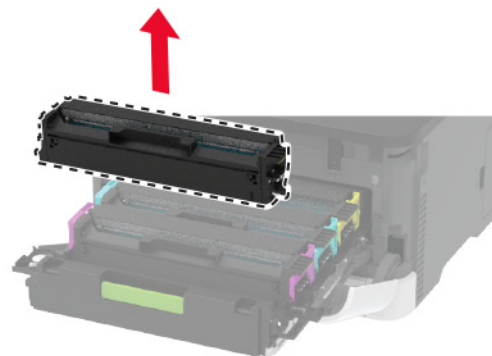
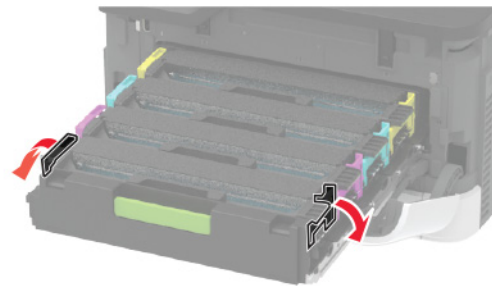

- 4 Unpack the new print cartridge.

**Warning—Potential Damage:** Do not expose the underside of the print cartridge to direct light. Extended exposure to light may cause print quality problems.

**Warning—Potential Damage:** Do not touch the underside of the print cartridge. Doing so may affect the quality of future print jobs.





**5** Insert the new print cartridge.

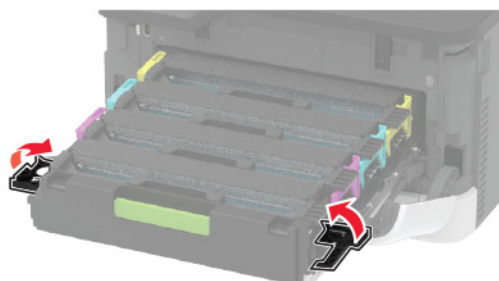
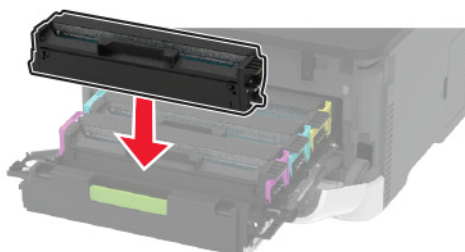

**6** Insert the print cartridge tray, and then close the door.

## Replacing the waste toner bottle

- 1 Remove the used waste toner bottle.

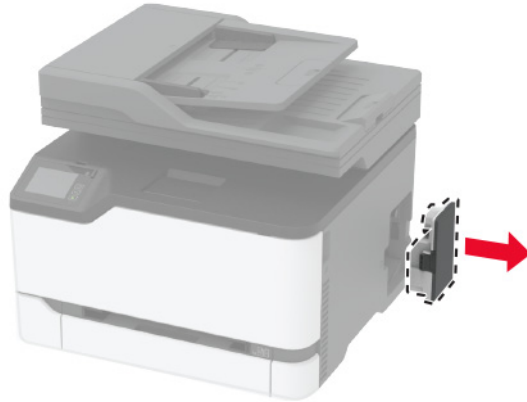

**Note:** To avoid spilling the toner, place the bottle in an upright position.

- 2 Unpack the new waste toner bottle.
- 3 Insert the new waste toner bottle.

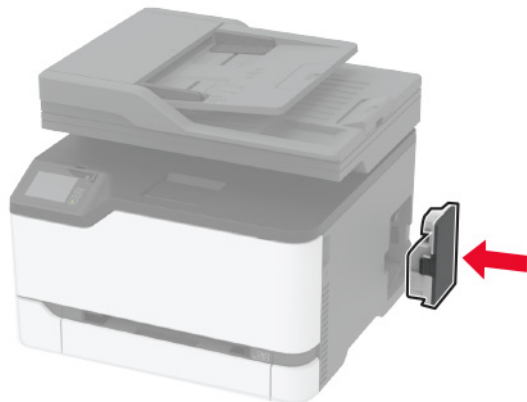

## Replacing the tray

- 1 Remove the used tray.



- 2 Unpack the new tray.
- 3 Insert the new tray.



## Replacing the manual feeder

- 1 Remove the tray.



- 2 Remove the used manual feeder.



- 3 Unpack the new manual feeder.

4 Insert the new manual feeder.

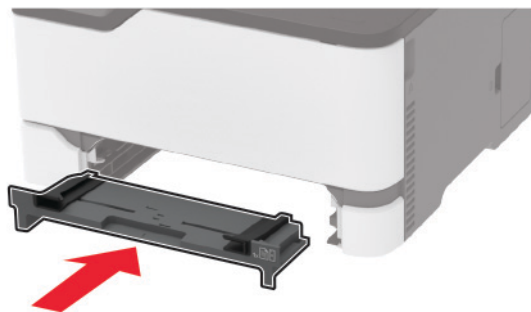

5 Insert the tray.

### Replacing the ADF tray

1 Open the ADF cover.

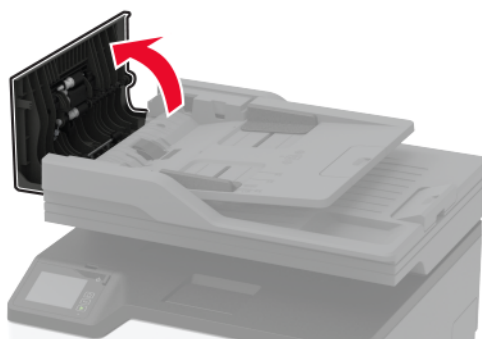

**2** Remove the used ADF tray.

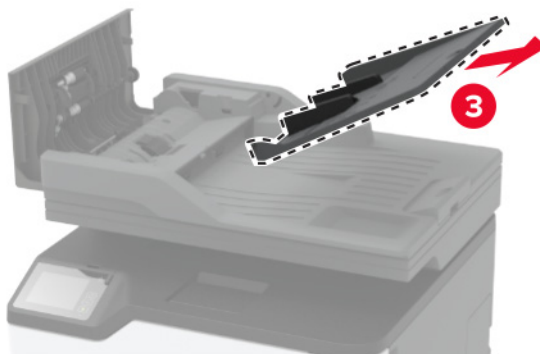
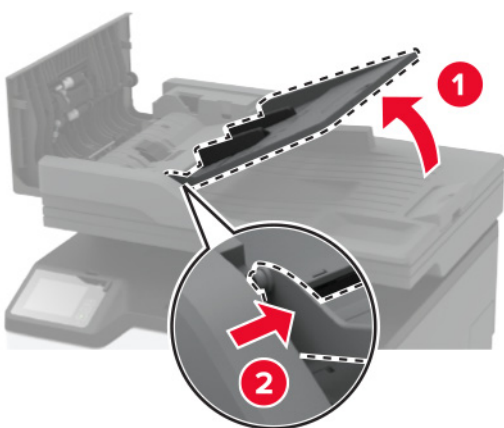
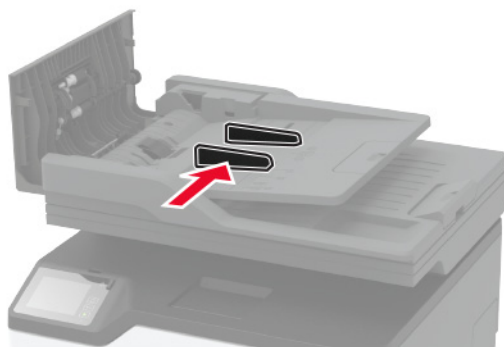

**3** Unpack the new ADF tray.

- 4 Insert the new ADF tray until it *clicks* into place.

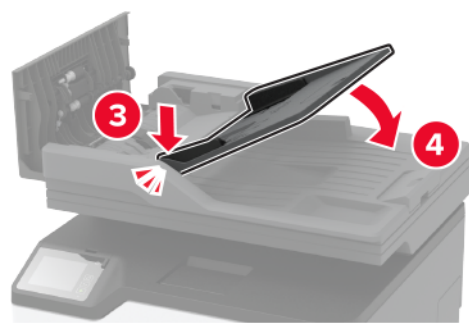
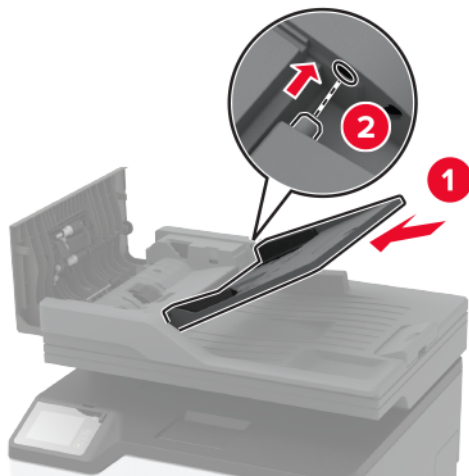

- 5 Close the ADF cover.

## Replacing the pick tires

- 1 Turn off the printer.
- 2 Unplug the power cord from the electrical outlet, and then from the printer.

**3** Open the front door, and then firmly push it down.

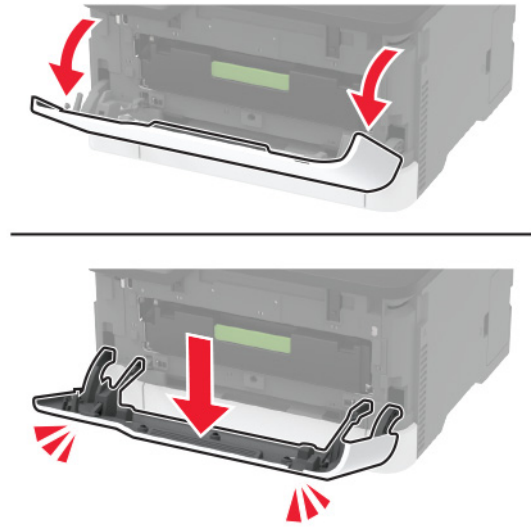

**4** Pull out the print cartridge tray.

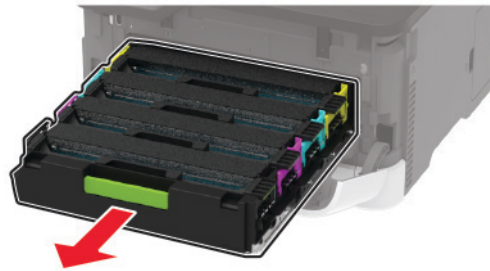

**5** To avoid stray toner contamination, place a sheet of paper on the top of the print cartridge tray, and then insert the print cartridge tray.

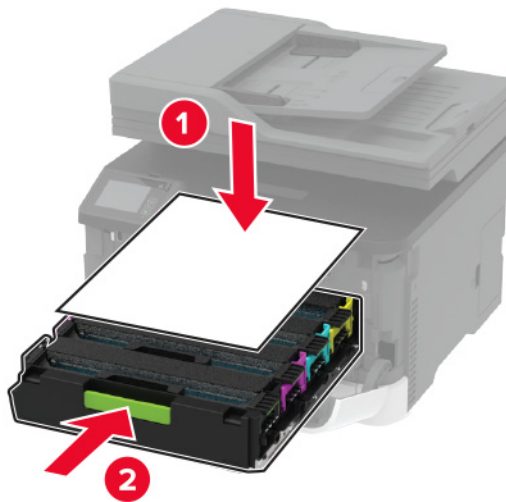

**6** Close the front door.

7 Remove the tray.



8 Remove the waste toner bottle.

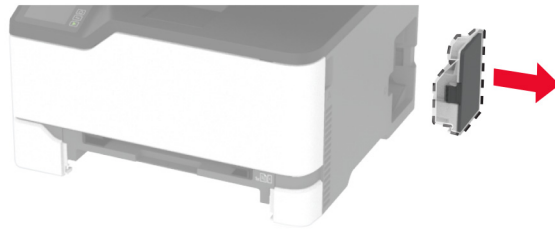

**Note:** To avoid spilling the toner, place the bottle in an upright position.

9 Position the printer on its side.

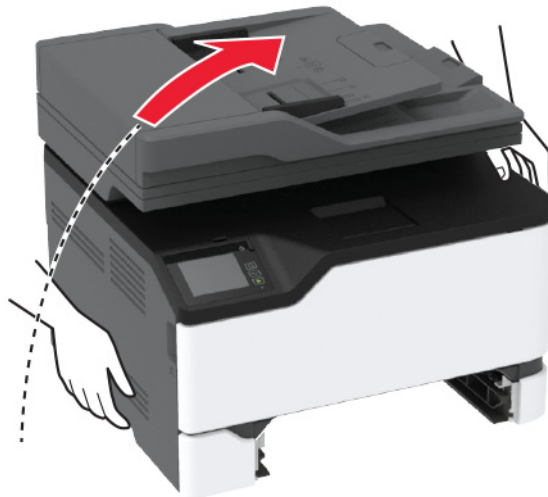



- 10** Remove the used pick tires.

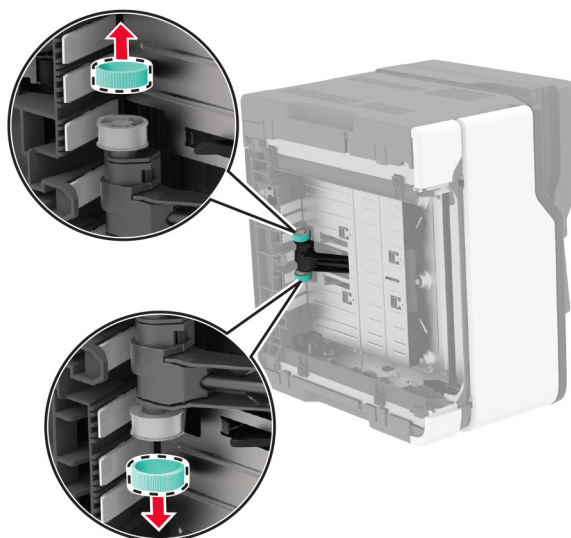
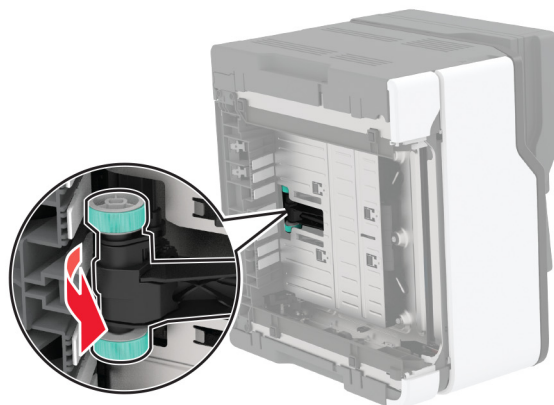

- 11** Unpack the new pick tires.

**Note:** To avoid contamination, make sure that your hands are clean.

**12** Insert the new pick tires.

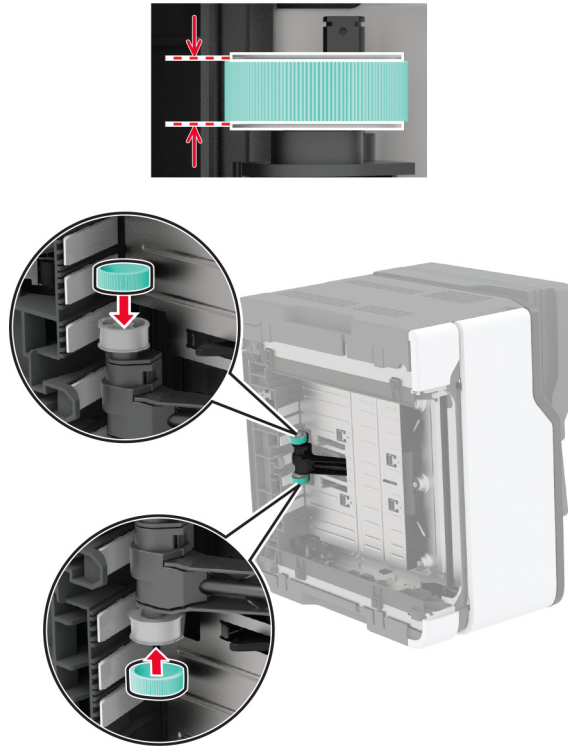

**13** Return the printer to its original position, and then insert the waste toner bottle.

**14** Insert the tray.

**15** Open the front door, and then firmly push it down.

**16** Pull out the print cartridge tray.

**17** Remove the paper, and then insert the print cartridge tray.

**18** Close the front door.

**19** Connect the power cord to the printer, and then to the electrical outlet.

**⚠ CAUTION—POTENTIAL INJURY:** To avoid the risk of fire or electrical shock, connect the power cord to an appropriately rated and properly grounded electrical outlet that is near the product and easily accessible.

**20** Turn on the printer.

## Replacing the ADF separator pad

- 1 Open the ADF cover.

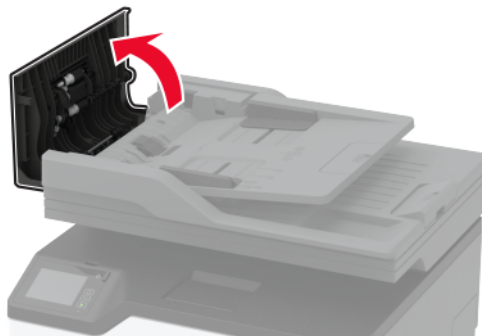

- 2 Remove the used ADF separator pad.

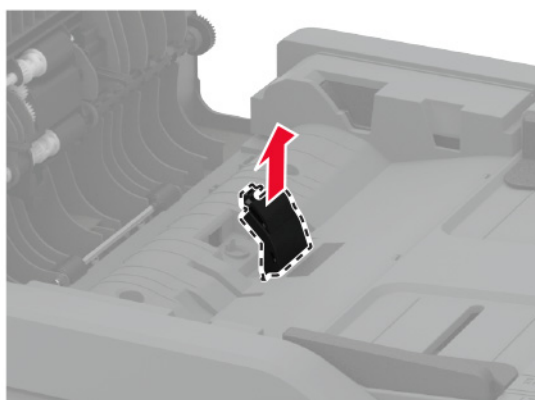
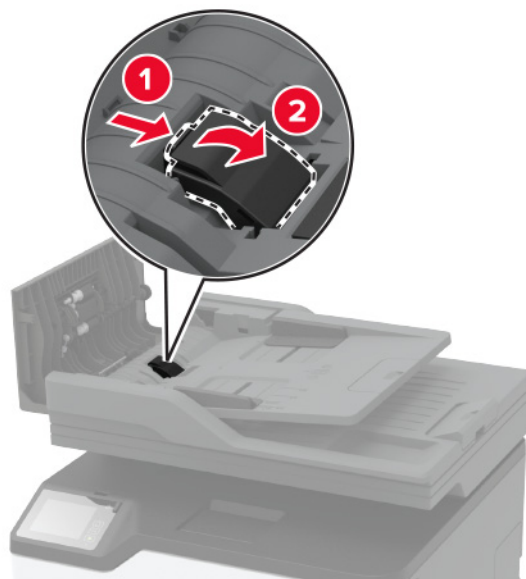

- 3 Unpack the new ADF separator pad.

**4** Insert the new separator pad until it *clicks* into place.

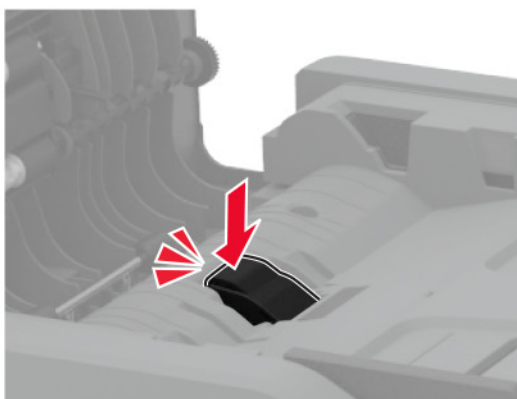
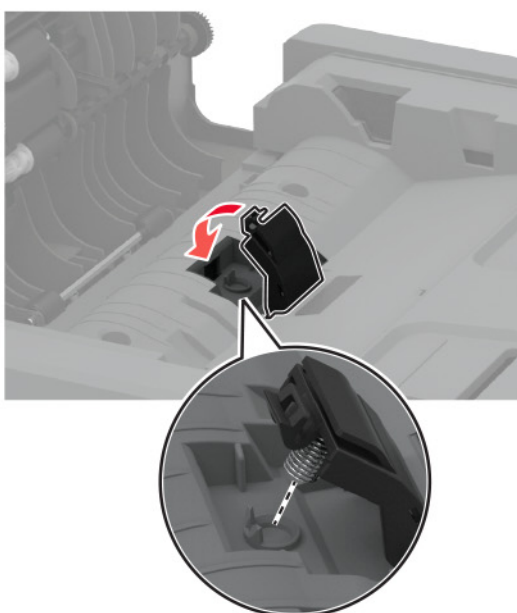
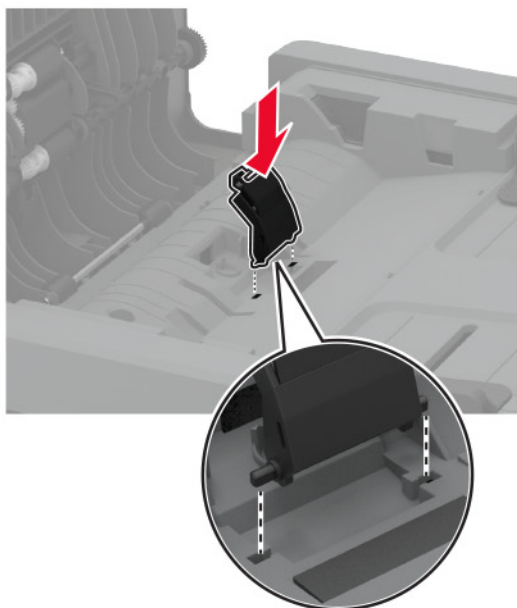

**5** Close the ADF cover.

## Resetting the supply usage counters

- 1 From the home screen, touch **Settings > Device > Maintenance > Config Menu > Supply Usage And Counters**.
- 2 Select the counter that you want to reset.

**Warning—Potential Damage:** Supplies and parts without Return Program agreement terms may be reset and remanufactured. However, the manufacturer's warranty does not cover any damage caused by non-genuine supplies or parts. Resetting counters on the supply or part without proper remanufacturing can cause damage to your printer. After resetting the supply or part counter, your printer may display an error indicating the presence of the reset item.

## Cleaning printer parts

### Cleaning the printer

 **CAUTION—SHOCK HAZARD:** To avoid the risk of electrical shock when cleaning the exterior of the printer, unplug the power cord from the electrical outlet and disconnect all cables from the printer before proceeding.

#### Notes:

- Perform this task after every few months.
- Damage to the printer caused by improper handling is not covered by the printer warranty.

- 1 Turn off the printer, and then unplug the power cord from the electrical outlet.
- 2 Remove paper from the standard bin.
- 3 Remove any dust, lint, and pieces of paper around the printer using a soft brush or vacuum.
- 4 Wipe the outside of the printer with a damp, soft, lint-free cloth.

#### Notes:

- Do not use household cleaners or detergents, as they may damage the finish of the printer.
- Make sure that all areas of the printer are dry after cleaning.

- 5 Connect the power cord to the electrical outlet, and then turn on the printer.

 **CAUTION—POTENTIAL INJURY:** To avoid the risk of fire or electrical shock, connect the power cord to an appropriately rated and properly grounded electrical outlet that is near the product and easily accessible.

### Cleaning the touch screen

 **CAUTION—SHOCK HAZARD:** To avoid the risk of electric shock when cleaning the exterior of the printer, unplug the power cord from the electrical outlet and disconnect all cables from the printer before proceeding.

- 1 Turn off the printer, and then unplug the power cord from the electrical outlet.
- 2 Using a damp, soft, lint-free cloth, wipe the touch screen.

**Notes:**

- Do not use household cleaners or detergents, as they may damage the touch screen.
- Make sure that the touch screen is dry after cleaning.

**3** Connect the power cord to the electrical outlet, and then turn on the printer.

**⚠ CAUTION—POTENTIAL INJURY:** To avoid the risk of fire or electrical shock, connect the power cord to an appropriately rated and properly grounded electrical outlet that is near the product and easily accessible.

## Cleaning the scanner

**1** Open the scanner cover.



**2** Using a damp, soft, lint-free cloth, wipe the following areas:

- ADF glass pad

**Note:** In some printer models, this location has an ADF glass instead of a pad.



- Scanner glass pad



- ADF glass



- Scanner glass



**3** Close the scanner cover.

## Cleaning the pick tires

- 1** Turn off the printer.
- 2** Unplug the power cord from the electrical outlet, and then from the printer.

**3** Open the front door, and then firmly push it down.

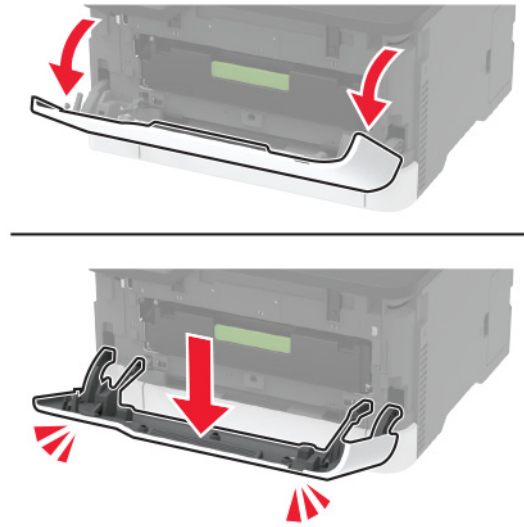

**4** Pull out the print cartridge tray.

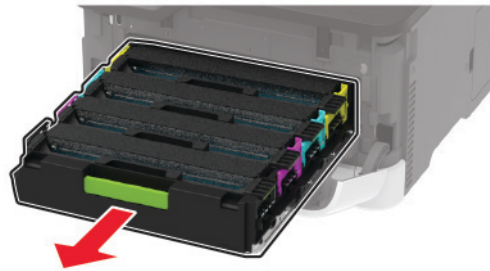

**5** To avoid stray toner contamination, place a sheet of paper on top of the print cartridge tray, and then insert the print cartridge tray.

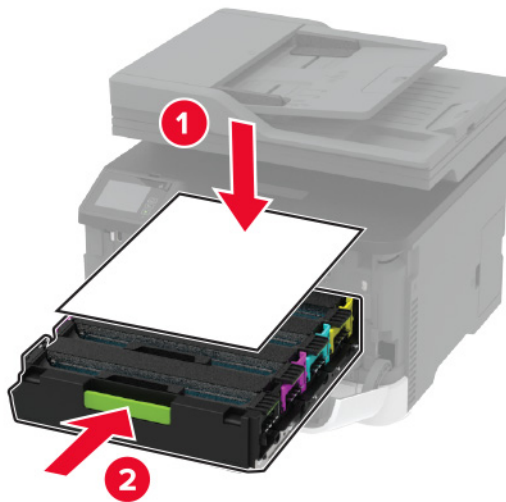

**6** Close the front door.



7 Remove the tray.



8 Remove the waste toner bottle.

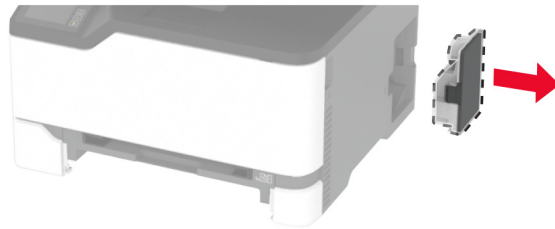

**Note:** To avoid spilling the toner, place the bottle in an upright position.

9 Position the printer on its side.

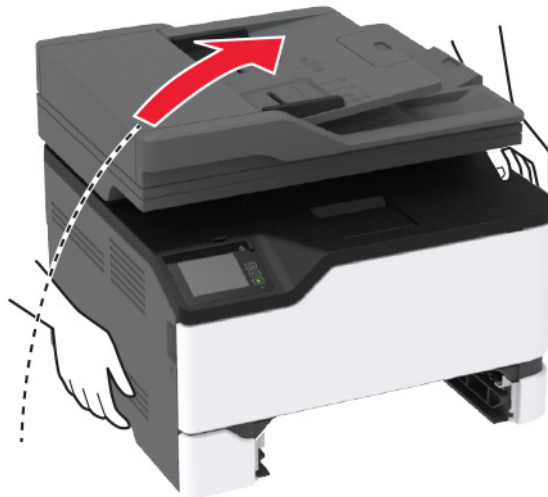

**10** Remove the pick tires.

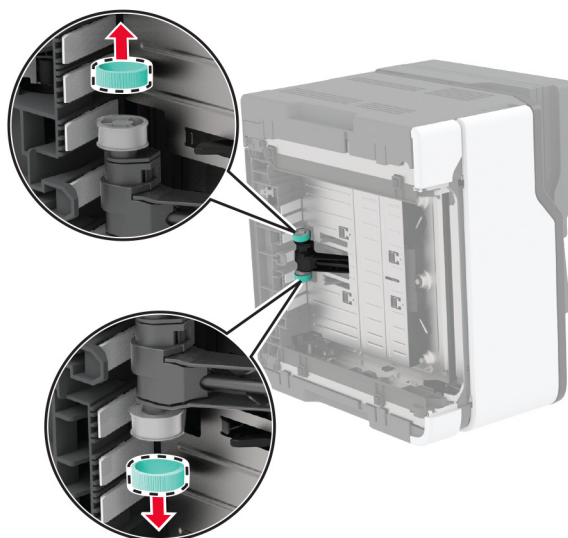
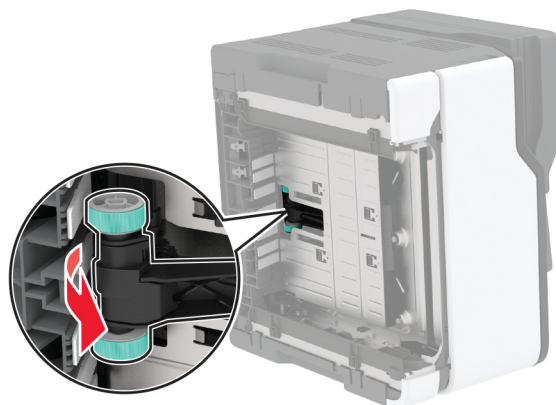

**11** Apply isopropyl alcohol to a soft, lint-free cloth, and then wipe the pick tires.

**12** Insert the pick tires.

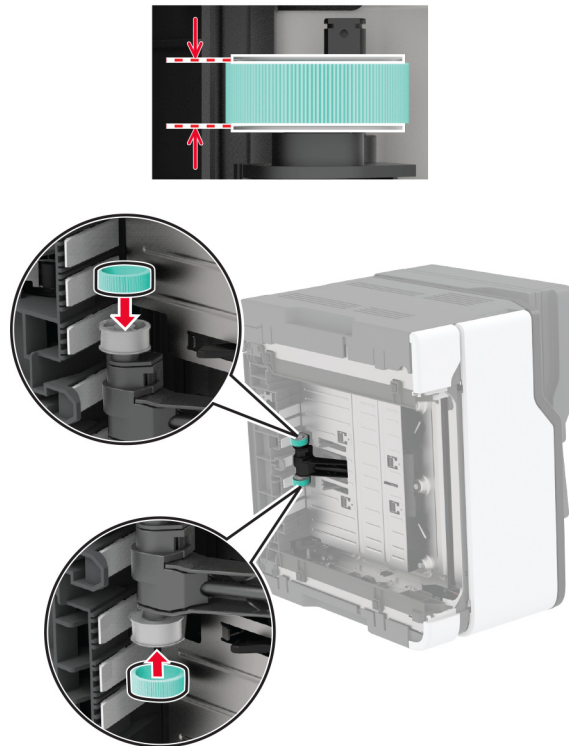

**13** Return the printer to its original position, and then insert the waste toner bottle.

**14** Insert the tray.

**15** Open the front door, and then firmly push it down.

**16** Pull out the print cartridge tray.

**17** Remove the paper, and then insert the print cartridge tray.

**18** Close the front door.

**19** Connect the power cord to the printer, and then to the electrical outlet.

**⚠ CAUTION—POTENTIAL INJURY:** To avoid the risk of fire or electrical shock, connect the power cord to an appropriately rated and properly grounded electrical outlet that is near the product and easily accessible.

**20** Turn on the printer.

# Saving energy and paper

## Configuring the power save mode settings

### Sleep mode

- 1 From the home screen, touch **Settings > Device > Power Management > Timeouts > Sleep Mode**.
- 2 Specify the amount of time that the printer stays idle before it enters Sleep Mode.

### Hibernate mode

- 1 From the home screen, touch **Settings > Device > Power Management > Timeouts > Hibernate Timeout**.
- 2 Select the amount of time that the printer stays idle before it enters Hibernate mode.

#### Notes:

- For Hibernate Timeout to work, set Hibernate Timeout on Connection to Hibernate.
- The Embedded Web Server is disabled when the printer is in Hibernate mode.

## Adjusting the brightness of the printer display

- 1 From the home screen, touch **Settings > Device > Preferences > Screen Brightness**.
- 2 Adjust the setting.

## Conserving supplies

- Print on both sides of the paper.  
**Note:** Two-sided printing is the default setting in the print driver.
- Print multiple pages on a single sheet of paper.
- Use the preview feature to see how the document looks like before printing it.
- Print one copy of the document to check its content and format for accuracy.

## Moving the printer to another location

 **CAUTION—POTENTIAL INJURY:** If the printer weight is greater than 20 kg (44 lb), then it may require two or more people to lift it safely.

 **CAUTION—POTENTIAL INJURY:** To avoid the risk of fire or electrical shock, use only the power cord provided with this product or the manufacturer's authorized replacement.

 **CAUTION—POTENTIAL INJURY:** When moving the printer, follow these guidelines to avoid personal injury or printer damage:

- Make sure that all doors and trays are closed.
- Turn off the printer, and then unplug the power cord from the electrical outlet.
- Disconnect all cords and cables from the printer.

- If the printer has separate floor-standing optional trays or output options attached to it, then disconnect them before moving the printer.
- If the printer has a caster base, then carefully roll it to the new location. Use caution when passing over thresholds and breaks in flooring.
- If the printer does not have a caster base but is configured with optional trays or output options, then remove the output options and lift the printer off the trays. Do not try to lift the printer and any options at the same time.
- Always use the handholds on the printer to lift it.
- Any cart used to move the printer must have a surface able to support the full footprint of the printer.
- Any cart used to move the hardware options must have a surface able to support the dimensions of the options.
- Keep the printer in an upright position.
- Avoid severe jarring movements.
- Make sure that your fingers are not under the printer when you set it down.
- Make sure that there is adequate clearance around the printer.

**Note:** Damage to the printer caused by improper moving is not covered by the printer warranty.

## Shipping the printer

For shipping instructions, go to <http://support.lexmark.com> or contact customer support.

# Troubleshoot a problem

## Print quality problems

Find the image that resembles the print quality problem you are having, and then click the link below it to read problem-solving steps.

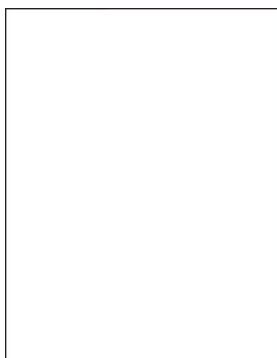

[“Blank or white pages” on page 167](#)

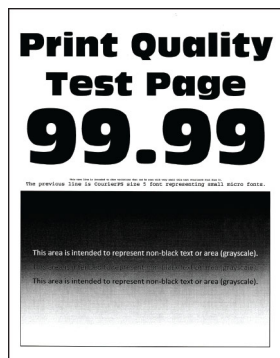

[“Dark print” on page 168](#)



[“Ghost images” on page 170](#)

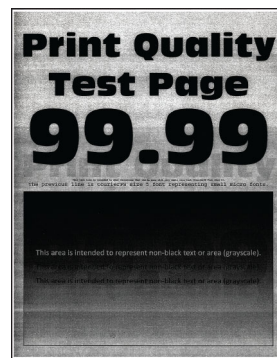

[“Gray or colored background” on page 171](#)



[“Incorrect margins” on page 172](#)

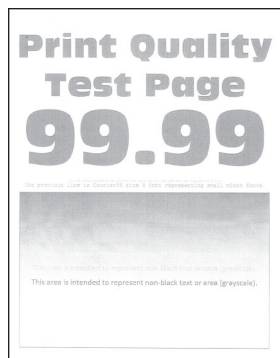

[“Light print” on page 173](#)

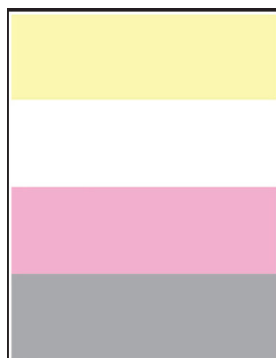

[“Missing colors” on page 175](#)



[“Mottled print and dots” on page 176](#)



[“Paper curl” on page 177](#)



[“Print crooked or skewed” on page 178](#)

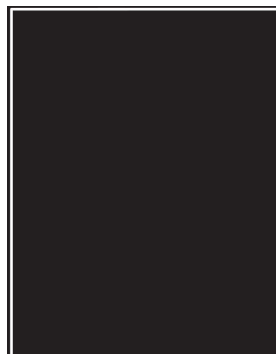

[“Solid color or black images” on page 179](#)

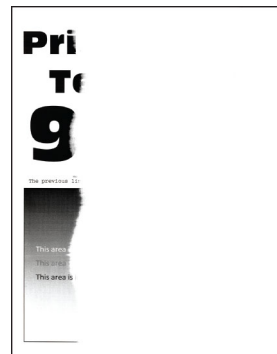

[“Text or images cut off” on page 180](#)



[“Toner easily rubs off” on page 181](#)

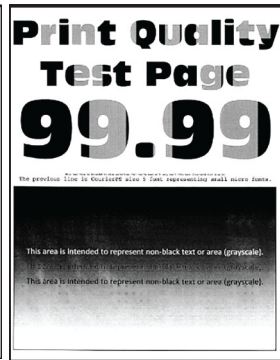

[“Uneven print density” on page 182](#)

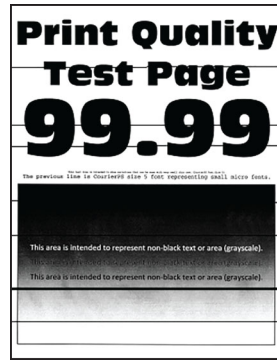

[“Horizontal dark lines” on page 183](#)



[“Vertical dark lines” on page 184](#)

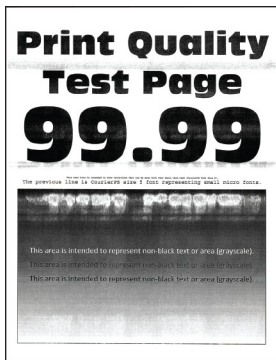

[“Horizontal white lines” on page 185](#)

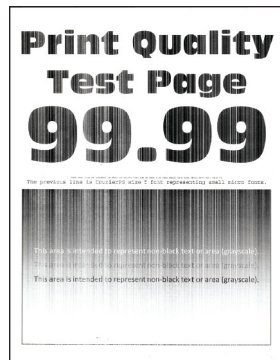

[“Vertical white lines” on page 187](#)



[“Repeating defects” on page 188](#)

## Printing problems

### Print quality is poor

#### Blank or white pages



**Note:** Before solving the problem, print the Print Quality Test Pages. From the control panel, navigate to

**Settings > Troubleshooting > Print Quality Test Pages.** For non-touch-screen printer models, press  to navigate through the settings.

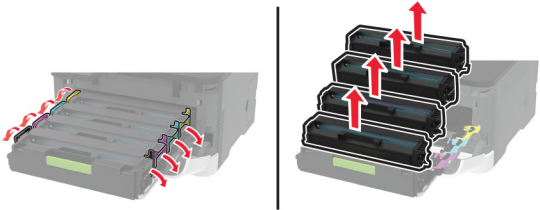
| Action   | Yes  | No                            |
|--|--|-------------------------------|
| <p><b>a</b> Open the front door, and then firmly push it down.<br/> <b>b</b> Pull out the print cartridge tray.<br/> <b>c</b> Remove, and then insert the print cartridges.</p>  <p><b>d</b> Insert the print cartridge tray, and then close the door.<br/> <b>e</b> Print the document.</p> <p>Is the printer printing blank or white pages?</p> | <p>Contact <a href="#">customer support</a>.</p> | <p>The problem is solved.</p> |

### Dark print



**Note:** Before solving the problem, print the Print Quality Test Pages. From the control panel, navigate to **Settings > Troubleshooting > Print Quality Test Pages**. For non-touch-screen printer models, press  to navigate through the settings.

| Action  | Yes                  | No                            |
|---|----------------------|-------------------------------|
| <p><b>Step 1</b></p> <p><b>a</b> Perform Color Adjust.<br/>           From the control panel, navigate to:<br/> <b>Settings &gt; Print &gt; Quality &gt; Advanced Imaging &gt; Color Adjust</b></p> <p><b>b</b> Print the document.</p> <p>Is the print too dark?</p> | <p>Go to step 2.</p> | <p>The problem is solved.</p> |



| Action  | Yes  | No                            |
|---|--|-------------------------------|
| <p><b>Step 2</b></p> <p><b>a</b> Depending on your operating system, reduce toner darkness from the Printing Preferences or Print dialog.</p> <p><b>Note:</b> You can also change the setting on the printer control panel. Navigate to:</p> <p><b>Settings &gt; Print &gt; Quality &gt; Toner Darkness</b></p> <p><b>b</b> Print the document.</p> <p>Is the print too dark?</p>   | <p>Go to step 3.</p>                             | <p>The problem is solved.</p> |
| <p><b>Step 3</b></p> <p><b>a</b> Depending on your operating system, specify the paper type from the Printing Preferences or Print dialog.</p> <p><b>Notes:</b></p> <ul style="list-style-type: none"> <li>• Make sure that the setting matches the paper loaded.</li> <li>• You can also change the setting on the printer control panel. Navigate to:</li> </ul> <p><b>Settings &gt; Paper &gt; Tray Configuration &gt; Paper Size/Type</b></p> <p><b>b</b> Print the document.</p> <p>Is the print too dark?</p> | <p>Go to step 4.</p>                             | <p>The problem is solved.</p> |
| <p><b>Step 4</b></p> <p>Check if the paper has texture or rough finishes.</p> <p>Are you printing on textured or rough paper?</p>   | <p>Go to step 5.</p>                             | <p>Go to step 6.</p>          |
| <p><b>Step 5</b></p> <p><b>a</b> Replace textured or rough paper with plain paper.</p> <p><b>b</b> Print the document.</p> <p>Is the print too dark?</p>  | <p>Go to step 6.</p>                             | <p>The problem is solved.</p> |
| <p><b>Step 6</b></p> <p><b>a</b> Load paper from a fresh package.</p> <p><b>Note:</b> Paper absorbs moisture due to high humidity. Store paper in its original wrapper until you are ready to use it.</p> <p><b>b</b> Print the document.</p> <p>Is the print too dark?</p>   | <p>Contact <a href="#">customer support</a>.</p> | <p>The problem is solved.</p> |

## Ghost images



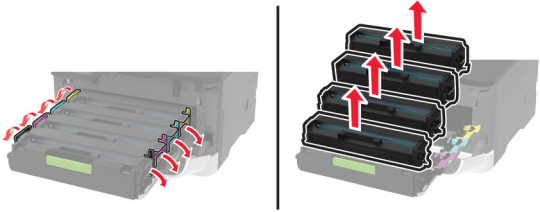

**Note:** Before solving the problem, print the Print Quality Test Pages. From the control panel, navigate to **Settings > Troubleshooting > Print Quality Test Pages**. For non-touch-screen printer models, press **OK** to navigate through the settings.

| Action  | Yes           | No                     |
|---|---------------|------------------------|
| <p><b>Step 1</b></p> <p><b>a</b> Load the tray with the correct paper type.</p> <p><b>b</b> Print the document.</p> <p>Do ghost images appear on prints?</p>  | Go to step 2. | The problem is solved. |
| <p><b>Step 2</b></p> <p><b>a</b> Depending on your operating system, specify the paper type from the Printing Preferences or Print dialog.</p> <p><b>Notes:</b></p> <ul style="list-style-type: none"> <li>• Make sure that the setting matches the paper loaded.</li> <li>• You can also change the setting on the printer control panel. Navigate to <b>Settings &gt; Paper &gt; Tray Configuration &gt; Paper Size/Type</b>.</li> </ul> <p><b>b</b> Print the document.</p> <p>Do ghost images appear on prints?</p> | Go to step 3. | The problem is solved. |
| <p><b>Step 3</b></p> <p><b>a</b> Perform Color Adjust.</p> <p>From the control panel, navigate to:</p> <p><b>Settings &gt; Print &gt; Quality &gt; Advanced Imaging &gt; Color Adjust.</b></p> <p><b>b</b> Print the document.</p> <p>Do ghost images appear on prints?</p>   | Go to step 4. | The problem is solved. |

| Action  | Yes  | No                            |
|---|--|-------------------------------|
| <p><b>Step 4</b></p> <ul style="list-style-type: none"> <li><b>a</b> Open the front door, and then firmly push it down.</li> <li><b>b</b> Pull out the print cartridge tray.</li> <li><b>c</b> Remove, and then insert the print cartridges.</li> </ul>  <ul style="list-style-type: none"> <li><b>d</b> Insert the print cartridge tray, and then close the door.</li> <li><b>e</b> Print the document.</li> </ul> <p>Do ghost images appear on prints?</p> | <p>Contact <a href="#">customer support</a>.</p> | <p>The problem is solved.</p> |

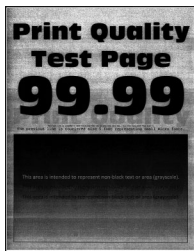
### Gray or colored background



**Note:** Before solving the problem, print the Print Quality Test Pages. From the control panel, navigate to **Settings > Troubleshooting > Print Quality Test Pages**. For non-touch-screen printer models, press  to navigate through the settings.

| Action   | Yes                  | No                            |
|--|----------------------|-------------------------------|
| <p><b>Step 1</b></p> <ul style="list-style-type: none"> <li><b>a</b> Perform Color Adjust.<br/>From the control panel, navigate to:<br/><b>Settings &gt; Print &gt; Quality &gt; Advanced Imaging &gt; Color Adjust.</b></li> <li><b>b</b> Print the document.</li> </ul> <p>Does gray or colored background appear on prints?</p> | <p>Go to step 2.</p> | <p>The problem is solved.</p> |

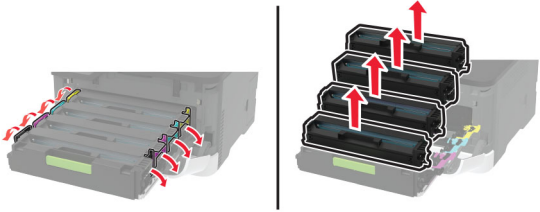
| Action  | Yes  | No                            |
|---|--|-------------------------------|
| <p><b>Step 2</b></p> <p><b>a</b> Open the front door, and then firmly push it down.</p> <p><b>b</b> Pull out the print cartridge tray.</p> <p><b>c</b> Remove, and then insert the print cartridges.</p>  <p><b>d</b> Insert the print cartridge tray, and then close the door.</p> <p><b>e</b> Print the document.</p> <p>Does gray or colored background appear on prints?</p> | <p>Contact <a href="#">customer support</a>.</p> | <p>The problem is solved.</p> |

**Incorrect margins**



| Action  | Yes                           | No                   |
|---|-------------------------------|----------------------|
| <p><b>Step 1</b></p> <p><b>a</b> Adjust the paper guides to the correct position for the paper loaded.</p> <p><b>b</b> Print the document.</p> <p>Are the margins correct?</p>  | <p>The problem is solved.</p> | <p>Go to step 2.</p> |
| <p><b>Step 2</b></p> <p><b>a</b> Set the paper size.</p> <p>From the control panel, navigate to:<br/> <b>Settings &gt; Paper &gt; Tray Configuration &gt; Paper Size/Type</b></p> <p><b>b</b> Print the document.</p> <p>Are the margins correct?</p> | <p>The problem is solved.</p> | <p>Go to step 3.</p> |

| Action  | Yes                           | No   |
|---|-------------------------------|--|
| <p><b>Step 3</b></p> <p><b>a</b> Depending on your operating system, specify the paper size from the Printing Preferences or Print dialog.</p> <p><b>Note:</b> Make sure that the setting matches the paper loaded.</p> <p><b>b</b> Print the document.</p> <p>Are the margins correct?</p> | <p>The problem is solved.</p> | <p>Contact <a href="#">customer support</a>.</p> |

### Light print

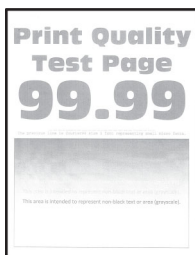

**Note:** Before solving the problem, print the Print Quality Test Pages. From the control panel, navigate to **Settings > Troubleshooting > Print Quality Test Pages**. For non-touch-screen printer models, press  to navigate through the settings.

| Action  | Yes                  | No                            |
|---|----------------------|-------------------------------|
| <p><b>Step 1</b></p> <p><b>a</b> Perform Color Adjust.</p> <p>From the control panel, navigate to:</p> <p><b>Settings &gt; Print &gt; Quality &gt; Advanced Imaging &gt; Color Adjust.</b></p> <p><b>b</b> Print the document.</p> <p>Is the print light?</p>   | <p>Go to step 2.</p> | <p>The problem is solved.</p> |
| <p><b>Step 2</b></p> <p><b>a</b> Depending on your operating system, increase toner darkness from the Printing Preferences or Print dialog.</p> <p><b>Note:</b> You can also change the setting on the printer control panel. Navigate to <b>Settings &gt; Print &gt; Quality &gt; Toner Darkness.</b></p> <p><b>b</b> Print the document.</p> <p>Is the print light?</p> | <p>Go to step 3.</p> | <p>The problem is solved.</p> |

| Action  | Yes           | No                     |
|---|---------------|------------------------|
| <p><b>Step 3</b></p> <p><b>a</b> Turn off Color Saver.<br/>From the control panel, navigate to:<br/><b>Settings &gt; Print &gt; Quality &gt; Color Saver.</b></p> <p><b>b</b> Print the document.</p> <p>Is the print light?</p>  | Go to step 4. | The problem is solved. |
| <p><b>Step 4</b></p> <p><b>a</b> Depending on your operating system, specify the paper type from the Printing Preferences or Print dialog.</p> <p><b>Notes:</b></p> <ul style="list-style-type: none"> <li>• Make sure that the setting matches the paper loaded.</li> <li>• You can also change the setting on the printer control panel. Navigate to <b>Settings &gt; Paper &gt; Tray Configuration &gt; Paper Size/Type.</b></li> </ul> <p><b>b</b> Print the document.</p> <p>Is the print light?</p> | Go to step 5. | The problem is solved. |
| <p><b>Step 5</b></p> <p>Check if paper has texture or rough finishes.</p> <p>Are you printing on textured or rough paper?</p>   | Go to step 6. | Go to step 7.          |
| <p><b>Step 6</b></p> <p><b>a</b> Replace textured or rough paper with plain paper.</p> <p><b>b</b> Print the document.</p> <p>Is the print light?</p>   | Go to step 7. | The problem is solved. |
| <p><b>Step 7</b></p> <p><b>a</b> Load paper from a fresh package.<br/><b>Note:</b> Paper absorbs moisture due to high humidity. Store paper in its original wrapper until you are ready to use it.</p> <p><b>b</b> Print the document.</p> <p>Is the print light?</p>   | Go to step 8. | The problem is solved. |

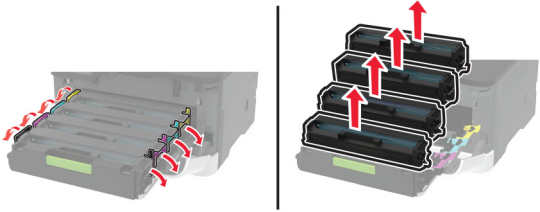
| Action  | Yes  | No                            |
|---|--|-------------------------------|
| <p><b>Step 8</b></p> <p><b>a</b> Open the front door, and then firmly push it down.</p> <p><b>b</b> Pull out the print cartridge tray.</p> <p><b>c</b> Remove, and then insert the print cartridges.</p>  <p><b>d</b> Insert the print cartridge tray, and then close the door.</p> <p><b>e</b> Print the document.</p> <p>Is the print light?</p> | <p>Contact <a href="#">customer support</a>.</p> | <p>The problem is solved.</p> |

**Missing colors**

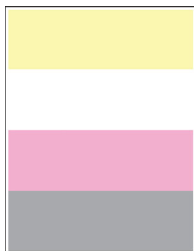

**Note:** Before solving the problem, print the Print Quality Test Pages. From the control panel, navigate to **Settings > Troubleshooting > Print Quality Test Pages**. For non-touch-screen printer models, press  to navigate through the settings.

| Action  | Yes  | No                            |
|---|--|-------------------------------|
| <p><b>a</b> Open the front door, and then firmly push it down.</p> <p><b>b</b> Pull out the print cartridge tray.</p> <p><b>c</b> Remove, and then insert the print cartridge of the missing color.</p> <p><b>d</b> Insert the print cartridge tray, and then close the door.</p> <p><b>e</b> Print the document.</p> <p>Are some colors missing on prints?</p> | <p>Contact <a href="#">customer support</a>.</p> | <p>The problem is solved.</p> |

## Mottled print and dots



**Note:** Before solving the problem, print the Print Quality Test Pages. From the control panel, navigate to **Settings > Troubleshooting > Print Quality Test Pages**. For non-touch-screen printer models, press **OK** to navigate through the settings.

| Action  | Yes           | No   |
|---|---------------|--|
| <p><b>Step 1</b><br/>Check the printer for leaked toner contamination.</p> <p>Is the printer free of leaked toner?</p>  | Go to step 2. | Contact <a href="#">customer support</a> . |
| <p><b>Step 2</b></p> <p><b>a</b> From the control panel, navigate to:<br/><b>Settings &gt; Paper &gt; Tray Configuration &gt; Paper Size/Type</b></p> <p><b>b</b> Check if the paper size and paper type settings match the paper loaded.</p> <p><b>Note:</b> Make sure that paper does not have texture or rough finishes.</p> <p>Do the settings match?</p> | Go to step 4. | Go to step 3.                              |
| <p><b>Step 3</b></p> <p><b>a</b> Depending on your operating system, specify the paper size and paper type from the Printing Preferences or Print dialog.</p> <p><b>Note:</b> Make sure that the settings match the paper loaded.</p> <p><b>b</b> Print the document.</p> <p>Is the print mottled?</p>  | Go to step 4. | The problem is solved.                     |
| <p><b>Step 4</b></p> <p><b>a</b> Load paper from a fresh package.</p> <p><b>Note:</b> Paper absorbs moisture due to high humidity. Store paper in its original wrapper until you are ready to use it.</p> <p><b>b</b> Print the document.</p> <p>Is the print mottled?</p>  | Go to step 5. | The problem is solved.                     |

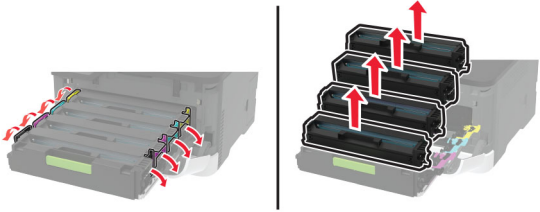

| Action  | Yes  | No                            |
|---|--|-------------------------------|
| <p><b>Step 5</b></p> <ul style="list-style-type: none"> <li><b>a</b> Open the front door, and then firmly push it down.</li> <li><b>b</b> Pull out the print cartridge tray.</li> <li><b>c</b> Remove, and then insert the print cartridges.</li> </ul>  <ul style="list-style-type: none"> <li><b>d</b> Insert the print cartridge tray, and then close the door.</li> <li><b>e</b> Print the document.</li> </ul> <p>Is the print mottled?</p> | <p>Contact <a href="#">customer support</a>.</p> | <p>The problem is solved.</p> |

**Paper curl**



| Action  | Yes                  | No                            |
|---|----------------------|-------------------------------|
| <p><b>Step 1</b></p> <ul style="list-style-type: none"> <li><b>a</b> Adjust the guides in the tray to the correct position for the paper loaded.</li> <li><b>b</b> Print the document.</li> </ul> <p>Is the paper curled?</p> | <p>Go to step 2.</p> | <p>The problem is solved.</p> |

| Action  | Yes  | No                     |
|---|--|------------------------|
| <p><b>Step 2</b></p> <p><b>a</b> Depending on your operating system, specify the paper type from the Printing Preferences or Print dialog.</p> <p><b>Notes:</b></p> <ul style="list-style-type: none"> <li>• Make sure that the setting matches the paper loaded.</li> <li>• You can also change the setting on the printer control panel. Navigate to:</li> </ul> <p><b>Settings &gt; Paper &gt; Tray Configuration &gt; Paper Size/Type</b></p> <p><b>b</b> Print the document.</p> <p>Is the paper curled?</p> | Go to step 3.                              | The problem is solved. |
| <p><b>Step 3</b></p> <p>Print on the other side of the paper.</p> <p><b>a</b> Remove paper, flip it over, and then reload paper.</p> <p><b>b</b> Print the document.</p> <p>Is the paper curled?</p>  | Go to step 4.                              | The problem is solved. |
| <p><b>Step 4</b></p> <p><b>a</b> Load paper from a fresh package.</p> <p><b>Note:</b> Paper absorbs moisture due to high humidity. Store paper in its original wrapper until you are ready to use it.</p> <p><b>b</b> Print the document.</p> <p>Is the paper curled?</p>   | Contact <a href="#">customer support</a> . | The problem is solved. |

### Print crooked or skewed



**Note:** Before solving the problem, print the Print Quality Test Pages. From the control panel, navigate to **Settings > Troubleshooting > Print Quality Test Pages**. For non-touch-screen printer models, press  to navigate through the settings.

| Action   | Yes  | No                     |
|--|--|------------------------|
| <p><b>Step 1</b></p> <p><b>a</b> Adjust the paper guides in the tray to the correct position for the paper loaded.</p> <p><b>b</b> Print the document.</p> <p>Is the print crooked or skewed?</p>  | Go to step 2.                              | The problem is solved. |
| <p><b>Step 2</b></p> <p><b>a</b> Load paper from a fresh package.</p> <p><b>Note:</b> Paper absorbs moisture due to high humidity. Store paper in its original wrapper until you are ready to use it.</p> <p><b>b</b> Print the document.</p> <p>Is the print crooked or skewed?</p> | Go to step 3.                              | The problem is solved. |
| <p><b>Step 3</b></p> <p><b>a</b> Check if the paper loaded is supported.</p> <p><b>Note:</b> If paper is not supported, then load a supported paper.</p> <p><b>b</b> Print the document.</p> <p>Is the print crooked or skewed?</p>  | Contact <a href="#">customer support</a> . | The problem is solved. |

### Solid color or black images

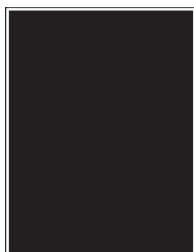

**Note:** Before solving the problem, print the Print Quality Test Pages. From the control panel, navigate to **Settings > Troubleshooting > Print Quality Test Pages**. For non-touch-screen printer models, press  to navigate through the settings.

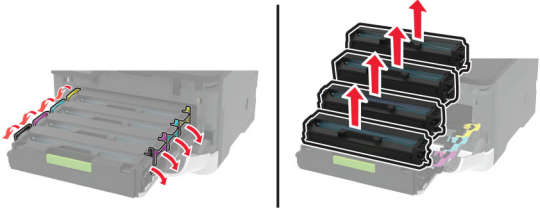
| Action  | Yes  | No                            |
|---|--|-------------------------------|
| <p><b>a</b> Open the front door, and then firmly push it down.<br/> <b>b</b> Pull out the print cartridge tray.<br/> <b>c</b> Remove, and then insert the print cartridges.</p>  <p><b>d</b> Insert the print cartridge tray, and then close the door.<br/> <b>e</b> Print the document.</p> <p>Is the printer printing solid color or black images?</p> | <p>Contact <a href="#">customer support</a>.</p> | <p>The problem is solved.</p> |

**Text or images cut off**



**Note:** Before solving the problem, print the Print Quality Test Pages. From the control panel, navigate to **Settings > Troubleshooting > Print Quality Test Pages**. For non-touch-screen printer models, press  to navigate through the settings.

| Action  | Yes                  | No                            |
|---|----------------------|-------------------------------|
| <p><b>Step 1</b><br/> <b>a</b> Adjust the paper guides in the tray to the correct position for the paper loaded.<br/> <b>b</b> Print the document.</p> <p>Are text or images cut off?</p> | <p>Go to step 2.</p> | <p>The problem is solved.</p> |

| Action  | Yes  | No                            |
|---|--|-------------------------------|
| <p><b>Step 2</b></p> <p><b>a</b> Depending on your operating system, specify the paper size from the Printing Preferences or Print dialog.</p> <p><b>Notes:</b></p> <ul style="list-style-type: none"> <li>• Make sure that the setting matches the paper loaded.</li> <li>• You can also change the setting on the printer control panel. Navigate to <b>Settings &gt; Paper &gt; Tray Configuration &gt; Paper Size/Type.</b></li> </ul> <p><b>b</b> Print the document.</p> <p>Are text or images cut off?</p> | <p>Go to step 3.</p>                             | <p>The problem is solved.</p> |
| <p><b>Step 3</b></p> <p><b>a</b> Open the front door, and then firmly push it down.</p> <p><b>b</b> Pull out the print cartridge tray.</p> <p><b>c</b> Remove, and then insert the print cartridges.</p> <div data-bbox="321 911 854 1117" data-label="Image"> </div> <p><b>d</b> Insert the print cartridge tray, and then close the door.</p> <p><b>e</b> Print the document.</p> <p>Are text or images cut off?</p>  | <p>Contact <a href="#">customer support</a>.</p> | <p>The problem is solved.</p> |

### Toner easily rubs off





**Note:** Before solving the problem, print the Print Quality Test Pages. From the control panel, navigate to

**Settings > Troubleshooting > Print Quality Test Pages.** For non-touch-screen printer models, press  to navigate through the settings.

| Action  | Yes  | No                     |
|---|--|------------------------|
| <p><b>Step 1</b></p> <p><b>a</b> Depending on your operating system, specify the paper type from the Printing Preferences or Print dialog.</p> <p><b>Notes:</b></p> <ul style="list-style-type: none"> <li>• Make sure that the setting matches the paper loaded.</li> <li>• You can also change the setting on the printer control panel. Navigate to:</li> </ul> <p><b>Settings &gt; Paper &gt; Tray Configuration &gt; Paper Size/Type</b></p> <p><b>b</b> Print the document.</p> <p>Does toner easily rub off?</p> | Go to step 2.                              | The problem is solved. |
| <p><b>Step 2</b></p> <p><b>a</b> Check if the paper weight is supported.</p> <p><b>Note:</b> If paper weight is not supported, then load a supported one.</p> <p><b>b</b> Print the document.</p> <p>Does toner easily rub off?</p>   | Go to step 3.                              | The problem is solved. |
| <p><b>Step 3</b></p> <p><b>a</b> Load paper from a fresh package.</p> <p><b>Note:</b> Paper absorbs moisture due to high humidity. Store paper in its original wrapper until you are ready to use it.</p> <p><b>b</b> Print the document.</p> <p>Does toner easily rub off?</p>   | Contact <a href="#">customer support</a> . | The problem is solved. |

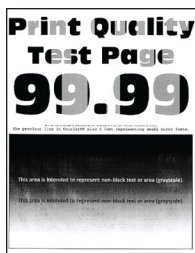
### Uneven print density

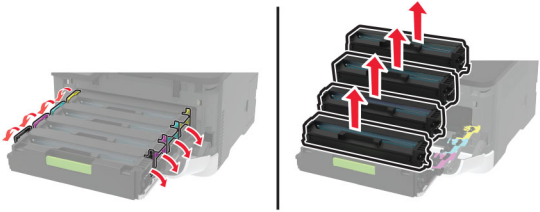

**Note:** Before solving the problem, print the Print Quality Test Pages. From the control panel, navigate to **Settings > Troubleshooting > Print Quality Test Pages**. For non-touch-screen printer models, press  to navigate through the settings.

| Action  | Yes  | No                            |
|---|--|-------------------------------|
| <p><b>a</b> Open the front door, and then firmly push it down.<br/> <b>b</b> Pull out the print cartridge tray.<br/> <b>c</b> Remove, and then insert the print cartridges.</p>  <p><b>d</b> Insert the print cartridge tray, and then close the door.<br/> <b>e</b> Print the document.</p> <p>Is the print density uneven?</p> | <p>Contact <a href="#">customer support</a>.</p> | <p>The problem is solved.</p> |

### Horizontal dark lines



**Notes:**

- Before solving the problem, print the Print Quality Test Pages. From the control panel, navigate to **Settings > Troubleshooting > Print Quality Test Pages**. For non-touch-screen printer models, press  to navigate through the settings.
- If horizontal dark lines keep appearing on the prints, then see the “Repeating defects” topic.

| Action  | Yes                  | No                            |
|---|----------------------|-------------------------------|
| <p><b>Step 1</b></p> <p><b>a</b> Depending on your operating system, specify the paper type from the Printing Preferences or Print dialog.</p> <p><b>Notes:</b></p> <ul style="list-style-type: none"> <li>• Make sure that the setting matches the paper loaded.</li> <li>• You can also change the setting on the printer control panel. Navigate to <b>Settings &gt; Paper &gt; Tray Configuration &gt; Paper Size/Type</b>.</li> </ul> <p><b>b</b> Print the document.</p> <p>Do dark lines appear on prints?</p> | <p>Go to step 2.</p> | <p>The problem is solved.</p> |

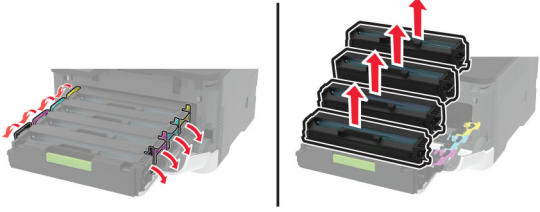
| Action  | Yes  | No                     |
|---|--|------------------------|
| <p><b>Step 2</b></p> <p><b>a</b> Load paper from a fresh package.<br/> <b>Note:</b> Paper absorbs moisture due to high humidity. Store paper in its original wrapper until you use it.</p> <p><b>b</b> Print the document.</p> <p>Do dark lines appear on prints?</p>   | Go to step 3.                              | The problem is solved. |
| <p><b>Step 3</b></p> <p><b>a</b> Open the front door, and then firmly push it down.</p> <p><b>b</b> Pull out the print cartridge tray.</p> <p><b>c</b> Remove, and then insert the print cartridges.</p>  <p><b>d</b> Insert the print cartridge tray, and then close the door.</p> <p><b>e</b> Print the document.</p> <p>Do dark lines appear on prints?</p> | Go to step 4.                              | The problem is solved. |
| <p><b>Step 4</b></p> <p><b>a</b> Perform Color Adjust.<br/>           From the control panel, navigate to:<br/> <b>Settings &gt; Print &gt; Quality &gt; Advanced Imaging &gt; Color Adjust</b></p> <p><b>b</b> Print the document.</p> <p>Do dark lines appear on prints?</p>  | Contact <a href="#">customer support</a> . | The problem is solved. |

**Vertical dark lines**



**Note:** Before solving the problem, print the Print Quality Test Pages. From the control panel, navigate to

**Settings > Troubleshooting > Print Quality Test Pages.** For non-touch-screen printer models, press  to navigate through the settings.



| Action   | Yes  | No                            |
|--|--|-------------------------------|
| <p><b>Step 1</b></p> <p><b>a</b> Depending on your operating system, specify the paper type from the Printing Preferences or Print dialog.</p> <p><b>Notes:</b></p> <ul style="list-style-type: none"> <li>• Make sure that the setting matches the paper loaded.</li> <li>• You can also change the setting on the printer control panel. Navigate to <b>Settings &gt; Paper &gt; Tray Configuration &gt; Paper Size/Type.</b></li> </ul> <p><b>b</b> Print the document.</p> <p>Do vertical dark lines appear on prints?</p> | <p>Go to step 2.</p>                             | <p>The problem is solved.</p> |
| <p><b>Step 2</b></p> <p><b>a</b> Load paper from a fresh package.</p> <p><b>Note:</b> Paper absorbs moisture due to high humidity. Store paper in its original wrapper until you use it.</p> <p><b>b</b> Print the document.</p> <p>Do vertical dark lines appear on prints?</p>   | <p>Go to step 3.</p>                             | <p>The problem is solved.</p> |
| <p><b>Step 3</b></p> <p><b>a</b> Open the front door, and then firmly push it down.</p> <p><b>b</b> Pull out the print cartridge tray.</p> <p><b>c</b> Remove, and then insert the print cartridges.</p> <div data-bbox="321 1199 854 1402" data-label="Image"> </div> <p><b>d</b> Insert the print cartridge tray, and then close the door.</p> <p><b>e</b> Print the document.</p> <p>Do vertical dark lines appear on prints?</p>   | <p>Contact <a href="#">customer support</a>.</p> | <p>The problem is solved.</p> |

### Horizontal white lines

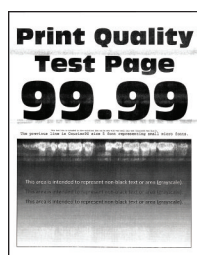

**Notes:**

- Before solving the problem, print the Print Quality Test Pages. From the control panel, navigate to **Settings > Troubleshooting > Print Quality Test Pages**. For non-touch-screen printer models, press  to navigate through the settings.
- If horizontal white lines keep appearing on your prints, then see the “Repeating defects” topic.

| Action  | Yes  | No                            |
|---|--|-------------------------------|
| <p><b>Step 1</b></p> <p><b>a</b> Depending on your operating system, specify the paper type from the Printing Preferences or Print dialog.</p> <p><b>Notes:</b></p> <ul style="list-style-type: none"> <li>• Make sure that the setting matches the paper loaded.</li> <li>• You can also change the setting on the printer control panel. Navigate to <b>Settings &gt; Paper &gt; Tray Configuration &gt; Paper Size/Type</b>.</li> </ul> <p><b>b</b> Print the document.</p> <p>Do horizontal white lines appear on prints?</p> | <p>Go to step 2.</p>                             | <p>The problem is solved.</p> |
| <p><b>Step 2</b></p> <p><b>a</b> Open the front door, and then firmly push it down.</p> <p><b>b</b> Pull out the print cartridge tray.</p> <p><b>c</b> Remove, and then insert the print cartridges.</p> <div data-bbox="321 1144 852 1354" data-label="Image"> </div> <p><b>d</b> Insert the print cartridge tray, and then close the door.</p> <p><b>e</b> Print the document.</p> <p>Do horizontal white lines appear on prints?</p>   | <p>Go to step 3.</p>                             | <p>The problem is solved.</p> |
| <p><b>Step 3</b></p> <p><b>a</b> Perform Color Adjust.<br/>From the control panel, navigate to:<br/><b>Settings &gt; Print &gt; Quality &gt; Advanced Imaging &gt; Color Adjust</b></p> <p><b>b</b> Print the document.</p> <p>Do horizontal white lines appear on prints?</p>  | <p>Contact <a href="#">customer support</a>.</p> | <p>The problem is solved.</p> |

## Vertical white lines



**Note:** Before solving the problem, print the Print Quality Test Pages. From the control panel, navigate to **Settings > Troubleshooting > Print Quality Test Pages**. For non-touch-screen printer models, press **OK** to navigate through the settings.

| Action  | Yes           | No                     |
|---|---------------|------------------------|
| <p><b>Step 1</b></p> <p><b>a</b> Depending on your operating system, specify the paper type from the Printing Preferences or Print dialog.</p> <p><b>Notes:</b></p> <ul style="list-style-type: none"> <li>• Make sure that the setting matches the paper loaded.</li> <li>• You can also change the setting on the printer control panel. Navigate to <b>Settings &gt; Paper &gt; Tray Configuration &gt; Paper Size/Type</b>.</li> </ul> <p><b>b</b> Print the document.</p> <p>Do vertical white lines appear on prints?</p> | Go to step 2. | The problem is solved. |
| <p><b>Step 2</b></p> <p>Check if you are using the recommended paper type.</p> <p><b>a</b> Load the paper source with the recommended paper type.</p> <p><b>b</b> Print the document.</p> <p>Do vertical white lines appear on prints?</p>  | Go to step 3. | The problem is solved. |

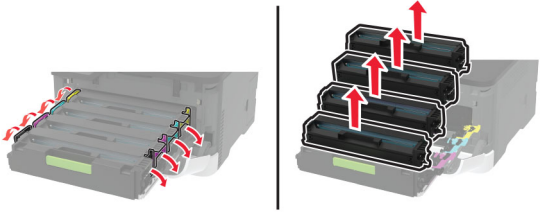
| Action  | Yes  | No                            |
|---|--|-------------------------------|
| <p><b>Step 3</b></p> <ul style="list-style-type: none"> <li><b>a</b> Open the front door, and then firmly push it down.</li> <li><b>b</b> Pull out the print cartridge tray.</li> <li><b>c</b> Remove, and then insert the print cartridges.</li> </ul>  <ul style="list-style-type: none"> <li><b>d</b> Insert the print cartridge tray, and then close the door.</li> <li><b>e</b> Print the document.</li> </ul> <p>Do vertical white lines appear on prints?</p> | <p>Contact <a href="#">customer support</a>.</p> | <p>The problem is solved.</p> |

### Repeating defects



**Note:** Before solving the problem, print the Print Quality Test Pages. From the control panel, navigate to **Settings > Troubleshooting > Print Quality Test Pages**. For non-touch-screen printer models, press  to navigate through the settings.

| Action   | Yes  | No   |
|--|--|--|
| <p><b>a</b> Using the Print Quality Test Pages, measure the distance between the repeating defects on the affected color page.</p> <p><b>b</b> Check if the repeating defects match any of the following measurements:</p> <p><b>Print cartridges</b></p> <ul style="list-style-type: none"> <li>• 25.70 mm (1.01 in.)</li> <li>• 35.30 mm (1.39 in.)</li> <li>• 75.6 mm (2.98 in.)</li> <li>• 26.7 mm (1.05 in.)</li> </ul> <p><b>Fuser</b></p> <ul style="list-style-type: none"> <li>• 56.5 mm (2.22 in.)</li> </ul> <p><b>Transfer module</b></p> <ul style="list-style-type: none"> <li>• 25.10 mm (0.99 in.)</li> <li>• 59.70 mm (2.35 in.)</li> <li>• 28.30 mm (1.11 in.)</li> <li>• 65 mm (2.56 in.)</li> <li>• 44 mm (1.73 in.)</li> </ul> <p>Do the repeating defects match any of the measurements?</p> | <p>Take note of the distance, and then contact <a href="#">customer support</a>.</p> | <p>Take note of the distance, and then contact <a href="#">customer support</a>.</p> |

### Print jobs do not print

| Action  | Yes                           | No                   |
|---|-------------------------------|----------------------|
| <p><b>Step 1</b></p> <p><b>a</b> From the document you are trying to print, open the Print dialog, and then check if you have selected the correct printer.</p> <p><b>b</b> Print the document.</p> <p>Is the document printed?</p> | <p>The problem is solved.</p> | <p>Go to step 2.</p> |
| <p><b>Step 2</b></p> <p><b>a</b> Check if the printer is on.</p> <p><b>b</b> Resolve any error messages that appear on the display.</p> <p><b>c</b> Print the document.</p> <p>Is the document printed?</p>                         | <p>The problem is solved.</p> | <p>Go to step 3.</p> |

| Action  | Yes                    | No   |
|---|------------------------|--|
| <p><b>Step 3</b></p> <p><b>a</b> Check if the ports are working and if the cables are securely connected to the computer and the printer.<br/>For more information, see the setup documentation that came with the printer.</p> <p><b>b</b> Print the document.</p> <p>Is the document printed?</p> | The problem is solved. | Go to step 4.                              |
| <p><b>Step 4</b></p> <p><b>a</b> Turn off the printer, wait for about 10 seconds, and then turn on the printer.</p> <p><b>b</b> Print the document.</p> <p>Is the document printed?</p>   | The problem is solved. | Go to step 5.                              |
| <p><b>Step 5</b></p> <p><b>a</b> Remove, and then reinstall the print driver.</p> <p><b>b</b> Print the document.</p> <p>Is the document printed?</p>   | The problem is solved. | Contact <a href="#">customer support</a> . |

## Slow printing

| Action   | Yes           | No                     |
|--|---------------|------------------------|
| <p><b>Step 1</b></p> <p>Make sure that the printer cable is securely connected to the printer and to the computer, print server, option, or other network device.</p> <p>Is the printer printing slow?</p>   | Go to step 2. | The problem is solved. |
| <p><b>Step 2</b></p> <p><b>a</b> Make sure that the printer is not in Quiet Mode.<br/>From the home screen, touch <b>Settings &gt; Device &gt; Maintenance &gt; Config Menu &gt; Device Operations &gt; Quiet Mode</b>.</p> <p><b>b</b> Print the document.</p> <p>Is the printer printing slow?</p> | Go to step 3. | The problem is solved. |
| <p><b>Step 3</b></p> <p><b>a</b> Depending on your operating system, specify the print resolution from the Printing Preferences or Print dialog.</p> <p><b>b</b> Set the resolution to 4800 CQ.</p> <p><b>c</b> Print the document.</p> <p>Is the printer printing slow?</p>                         | Go to step 4. | The problem is solved. |

| Action   | Yes  | No                            |
|--|--|-------------------------------|
| <p><b>Step 4</b></p> <p><b>a</b> Depending on your operating system, specify the paper type from the Printing Preferences or Print dialog.</p> <p><b>Notes:</b></p> <ul style="list-style-type: none"> <li>• Make sure that the setting matches the paper loaded.</li> <li>• You can also change the setting on the printer control panel. From the home screen, touch <b>Settings &gt; Paper &gt; Tray Configuration &gt; Paper Size/Type</b>.</li> <li>• Heavier paper prints more slowly.</li> <li>• Paper narrower than letter, A4, and legal may print more slowly.</li> </ul> <p><b>b</b> Print the document.</p> <p>Is the printer printing slow?</p> | <p>Go to step 5.</p>                             | <p>The problem is solved.</p> |
| <p><b>Step 5</b></p> <p><b>a</b> Make sure that the printer settings for texture and weight match the paper being loaded.</p> <p>From the home screen, touch <b>Settings &gt; Paper &gt; Media Configuration &gt; Media Types</b>.</p> <p><b>Note:</b> Rough paper texture and heavy paper weight may print more slowly.</p> <p><b>b</b> Print the document.</p> <p>Is the printer printing slow?</p>  | <p>Go to step 6.</p>                             | <p>The problem is solved.</p> |
| <p><b>Step 6</b></p> <p>Remove held jobs.</p> <p>Is the printer printing slow?</p>   | <p>Go to step 7.</p>                             | <p>The problem is solved.</p> |
| <p><b>Step 7</b></p> <p><b>a</b> Make sure that the printer is not overheating.</p> <p><b>Notes:</b></p> <ul style="list-style-type: none"> <li>• Allow the printer to cool down after a long print job.</li> <li>• Observe the recommended ambient temperature for the printer. For more information, see <a href="#">“Selecting a location for the printer” on page 20</a>.</li> </ul> <p><b>b</b> Print the document.</p> <p>Is the printer printing slow?</p>  | <p>Contact <a href="#">customer support</a>.</p> | <p>The problem is solved.</p> |

## Job prints from the wrong tray or on the wrong paper

| Action  | Yes                    | No  |
|---|------------------------|---|
| <p><b>Step 1</b></p> <p><b>a</b> Check if you are printing on the correct paper.</p> <p><b>b</b> Print the document.</p> <p>Is the document printed on the correct paper?</p>   | Go to step 2.          | Load the correct paper size and paper type. |
| <p><b>Step 2</b></p> <p><b>a</b> Depending on your operating system, specify the paper size and paper type from the Printing Preferences or Print dialog.</p> <p><b>Note:</b> You can also change the settings on the printer control panel. Navigate to:</p> <p><b>Settings &gt; Paper &gt; Tray Configuration &gt; Paper Size/Type</b></p> <p><b>b</b> Make sure that the settings match the paper loaded.</p> <p><b>c</b> Print the document.</p> <p>Is the document printed on the correct paper?</p> | The problem is solved. | Go to step 3.                               |
| <p><b>Step 3</b></p> <p><b>a</b> Check if the trays are linked.</p> <p>For more information, see <a href="#">“Linking trays” on page 44</a>.</p> <p><b>b</b> Print the document.</p> <p>Is the document printed from the correct tray?</p>  | The problem is solved. | Contact <a href="#">customer support</a> .  |

## Confidential and other held documents do not print

| Action   | Yes                    | No            |
|--|------------------------|---------------|
| <p><b>Step 1</b></p> <p><b>a</b> From the control panel, check if the documents appear in the Held Jobs list.</p> <p><b>Note:</b> If the documents are not listed, then print the documents using the Print and Hold options.</p> <p><b>b</b> Print the documents.</p> <p>Are the documents printed?</p> | The problem is solved. | Go to step 2. |
| <p><b>Step 2</b></p> <p>The print job may contain a formatting error or invalid data. Delete the print job, and then send it again.</p> <p>Are the documents printed?</p>  | The problem is solved. | Go to step 3. |



| Action   | Yes                           | No   |
|--|-------------------------------|--|
| <p><b>Step 3</b></p> <p>If you are printing from the Internet, then the printer may be reading the multiple job titles as duplicates.</p> <p><b>For Windows users</b></p> <ul style="list-style-type: none"> <li>a Open the Printing Preferences dialog.</li> <li>b From the Print and Hold tab, click <b>Use Print and Hold</b>, and then click <b>Keep duplicate documents</b>.</li> <li>c Enter a PIN, and then save the changes.</li> <li>d Send the print job.</li> </ul> <p><b>For Macintosh users</b></p> <ul style="list-style-type: none"> <li>a Save and name each job differently.</li> <li>b Send the job individually.</li> </ul> <p>Are the documents printed?</p> | <p>The problem is solved.</p> | <p>Go to step 4.</p>                             |
| <p><b>Step 4</b></p> <ul style="list-style-type: none"> <li>a Delete some held jobs to free up printer memory.</li> <li>b Print the documents.</li> </ul> <p>Are the documents printed?</p>  | <p>The problem is solved.</p> | <p>Contact <a href="#">customer support</a>.</p> |

## The printer is not responding

| Action   | Yes   | No                          |
|--|---|-----------------------------|
| <p><b>Step 1</b></p> <p>Check if the power cord is connected to the electrical outlet.</p> <p> <b>CAUTION—POTENTIAL INJURY:</b> To avoid the risk of fire or electrical shock, connect the power cord to an appropriately rated and properly grounded electrical outlet that is near the product and easily accessible.</p> <p>Is the printer responding?</p> | <p>The problem is solved.</p>                   | <p>Go to step 2.</p>        |
| <p><b>Step 2</b></p> <p>Check if the electrical outlet is turned off by a switch or breaker.</p> <p>Is the electrical outlet turned off by a switch or breaker?</p>  | <p>Turn on the switch or reset the breaker.</p> | <p>Go to step 3.</p>        |
| <p><b>Step 3</b></p> <p>Check if the printer is on.</p> <p>Is the printer on?</p>  | <p>Go to step 4.</p>                            | <p>Turn on the printer.</p> |

| Action  | Yes   | No   |
|---|---|--|
| <p><b>Step 4</b><br/>Check if the printer is in Sleep or Hibernate mode.</p> <p>Is the printer in Sleep or Hibernate mode?</p>  | Press the power button to wake the printer. | Go to step 5.                              |
| <p><b>Step 5</b><br/>Check if the cables connecting the printer and the computer are inserted to the correct ports.</p> <p>Are the cables inserted to the correct ports?</p>  | Go to step 6.                               | Insert the cables to the correct ports.    |
| <p><b>Step 6</b><br/>Turn off the printer, install the hardware options, and then turn on the printer.<br/>For more information, see the documentation that came with the option.</p> <p>Is the printer responding?</p> | The problem is solved.                      | Go to step 7.                              |
| <p><b>Step 7</b><br/>Install the correct print driver.</p> <p>Is the printer responding?</p>  | The problem is solved.                      | Go to step 8.                              |
| <p><b>Step 8</b><br/>Turn off the printer, wait for about 10 seconds, and then turn on the printer.</p> <p>Is the printer responding?</p>   | The problem is solved.                      | Contact <a href="#">customer support</a> . |

## Unable to read flash drive

| Action   | Yes                    | No   |
|--|------------------------|--|
| <p><b>Step 1</b><br/>Check if the printer is not busy processing another print, copy, scan, or fax job.</p> <p>Is the printer ready?</p>   | Go to step 2.          | Wait for the printer to finish processing the other job. |
| <p><b>Step 2</b><br/>Check if the flash drive is supported. For more information, see <a href="#">“Supported flash drives and file types” on page 56</a>.</p> <p>Is the flash drive supported?</p> | Go to step 3.          | Insert a supported flash drive.                          |
| <p><b>Step 3</b><br/>Remove, and then insert the flash drive.</p> <p>Does the printer recognize the flash drive?</p>   | The problem is solved. | Contact <a href="#">customer support</a> .               |

## Enabling the USB port

From the home screen, touch **Settings** > **Network/Ports** > **USB** > **Enable USB Port**.

## Network connection problems

### Cannot open Embedded Web Server

| Action   | Yes           | No  |
|--|---------------|---|
| <p><b>Step 1</b><br/>Check if the printer is on.</p> <p>Is the printer on?</p>   | Go to step 2. | Turn on the printer.                                      |
| <p><b>Step 2</b><br/>Make sure that the printer IP address is correct.</p> <p><b>Notes:</b></p> <ul style="list-style-type: none"> <li>• View the IP address on the home screen.</li> <li>• An IP address appears as four sets of numbers separated by periods, such as 123.123.123.123.</li> </ul> <p>Is the printer IP address correct?</p>                | Go to step 3. | Type the correct printer IP address in the address field. |
| <p><b>Step 3</b><br/>Check if you are using a supported browser:</p> <ul style="list-style-type: none"> <li>• Internet Explorer version 11 or later</li> <li>• Microsoft Edge</li> <li>• Safari version 6 or later</li> <li>• Google Chrome™ version 32 or later</li> <li>• Mozilla Firefox version 24 or later</li> </ul> <p>Is your browser supported?</p> | Go to step 4. | Install a supported browser.                              |
| <p><b>Step 4</b><br/>Check if the network connection is working.</p> <p>Is the network connection working?</p>   | Go to step 5. | Contact your administrator.                               |
| <p><b>Step 5</b><br/>Make sure that the cable connections to the printer and print server are secure. For more information, see the documentation that came with the printer.</p> <p>Are the cable connections secure?</p>   | Go to step 6. | Secure the cable connections.                             |

| Action   | Yes                    | No   |
|--|------------------------|--|
| <p><b>Step 6</b><br/>Check if the web proxy servers are disabled.</p> <p>Are the web proxy servers disabled?</p> | Go to step 7.          | Contact your administrator.                |
| <p><b>Step 7</b><br/>Access the Embedded Web Server.</p> <p>Did the Embedded Web Server open?</p>                | The problem is solved. | Contact <a href="#">customer support</a> . |

### Cannot connect the printer to the Wi-Fi network

| Action  | Yes                    | No            |
|---|------------------------|---------------|
| <p><b>Step 1</b><br/>Make sure that Active Adapter is set to Auto.<br/>From the home screen, touch <b>Settings &gt; Network/Ports &gt; Network Overview &gt; Active Adapter &gt; Auto</b>.</p> <p>Can the printer connect to the Wi-Fi network?</p> | The problem is solved. | Go to step 2. |
| <p><b>Step 2</b><br/>Check if the correct Wi-Fi network is selected.<br/><b>Note:</b> Some routers may share the default SSID.</p> <p>Are you connecting to the correct Wi-Fi network?</p>  | Go to step 4.          | Go to step 3. |
| <p><b>Step 3</b><br/>Connect to the correct Wi-Fi network. For more information, see <a href="#">“Connecting the printer to a Wi-Fi network” on page 49</a>.</p> <p>Can the printer connect to the Wi-Fi network?</p>                               | The problem is solved. | Go to step 4. |
| <p><b>Step 4</b><br/>Check the wireless security mode.<br/>From the home screen, touch <b>Settings &gt; Network/Ports &gt; Wireless &gt; Wireless Security Mode</b>.</p> <p>Is the correct wireless security mode selected?</p>                     | Go to step 6.          | Go to step 5. |
| <p><b>Step 5</b><br/>Select the correct wireless security mode.</p> <p>Can the printer connect to the Wi-Fi network?</p>  | The problem is solved. | Go to step 6. |

| Action  | Yes                           | No   |
|---|-------------------------------|--|
| <p><b>Step 6</b><br/>                     Make sure that you entered the correct network password.<br/> <b>Note:</b> Take note of the spaces, numbers, and capitalization in the password.</p> <p>Can the printer connect to the Wi-Fi network?</p> | <p>The problem is solved.</p> | <p>Contact <a href="#">customer support</a>.</p> |

## Issues with supplies

### Replace cartridge, printer region mismatch

To correct this problem, purchase a cartridge with the correct region that matches the printer region, or purchase a worldwide cartridge.

- The first number in the message after 42 indicates the region of the printer.
- The second number in the message after 42 indicates the region of the cartridge.

#### Printer and print cartridge regions

| Region  | Numeric code |
|---|--------------|
| Worldwide or Undefined region   | 0            |
| North America (United States, Canada)                                 | 1            |
| European Economic Area, Western Europe, Nordic countries, Switzerland | 2            |
| Asia Pacific  | 3            |
| Latin America   | 4            |
| Rest of Europe, Middle East, Africa                                   | 5            |
| Australia, New Zealand  | 6            |
| Invalid region  | 9            |

**Note:** To find the region settings of the printer and print cartridge, print the Print Quality Test Pages. From the control panel, navigate to: **Settings > Troubleshooting > Print Quality Test Pages**.

### Non-Lexmark supply

The printer has detected a non-Lexmark supply or part installed in the printer.

Your Lexmark printer is designed to function best with genuine Lexmark supplies and parts. Use of third-party supplies or parts may affect the performance, reliability, or life of the printer and its imaging components.

All life indicators are designed to function with Lexmark supplies and parts and may deliver unpredictable results if third-party supplies or parts are used. Imaging component usage beyond the intended life may damage your Lexmark printer or associated components.



**Warning—Potential Damage:** Use of third-party supplies or parts can affect warranty coverage. Damage caused by the use of third-party supplies or parts may not be covered by the warranty.

To accept any and all of these risks and to proceed with the use of non-genuine supplies or parts in your printer, do either of the following:

For touch-screen printer models, press  twice, and then press  twice.

For non-touch-screen printer models, press and hold **X** and  simultaneously for 15 seconds.

If you do not want to accept these risks, then remove the third-party supply or part from your printer and install a genuine Lexmark supply or part. For more information, see [“Using genuine Lexmark parts and supplies” on page 140](#).

For touch-screen printer models, if the printer does not print after pressing  twice, and then pressing  twice, then reset the supply usage counter.

For non-touch-screen printer models, if the printer does not print after pressing and holding **X** and  simultaneously for 15 seconds, then reset the supply usage counter.



1 From the control panel, navigate to:

**Settings > Device > Maintenance > Config Menu > Supply Usage And Counters**

For non-touch-screen printer models, press  to navigate through the settings.

2 Select the part or supply that you want to reset.

3 To clear the message, do either of the following:

- For touch-screen printer models, press  twice, and then press  twice.
- For non-touch-screen printer models, press and hold **X** and  simultaneously for 15 seconds.

**Note:** If you are unable to reset the supply usage counters, then return the item to the place of purchase.

## Clearing jams

### Avoiding jams

#### Load paper properly

- Make sure that the paper lies flat in the tray.

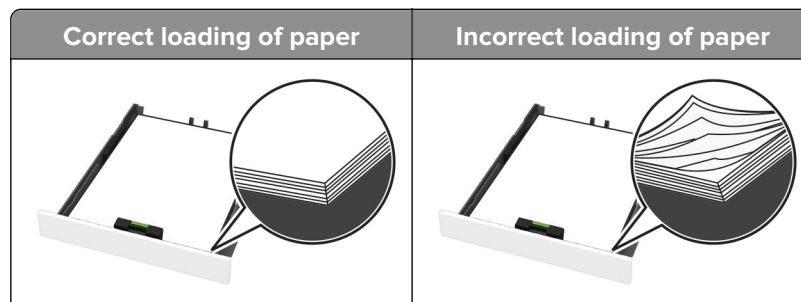

- Do not load or remove a tray while the printer is printing.

- Do not load too much paper. Make sure that the stack height is below the maximum paper fill indicator.
- Do not slide paper into the tray. Load paper as shown in the illustration.



- Make sure that the paper guides are positioned correctly and are not pressing tightly against the paper or envelopes.
- Push the tray firmly into the printer after loading paper.

### Use recommended paper

- Use only recommended paper or specialty media.
- Do not load paper that is wrinkled, creased, damp, bent, or curled.
- Flex, fan, and align the paper edges before loading.

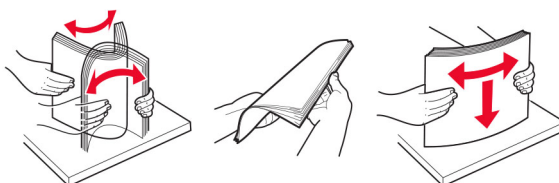

- Do not use paper that has been cut or trimmed by hand.
- Do not mix paper sizes, weights, or types in the same tray.
- Make sure that the paper size and type are set correctly on the computer or printer control panel.
- Store paper according to manufacturer recommendations.

## Identifying jam locations

### Notes:

- When Jam Assist is set to On, the printer might attempt to flush blank pages or pages with partial prints after clearing the jam. Check your printed output for blank pages.
- When Jam Recovery is set to On or Auto, the printer reprints jammed pages.

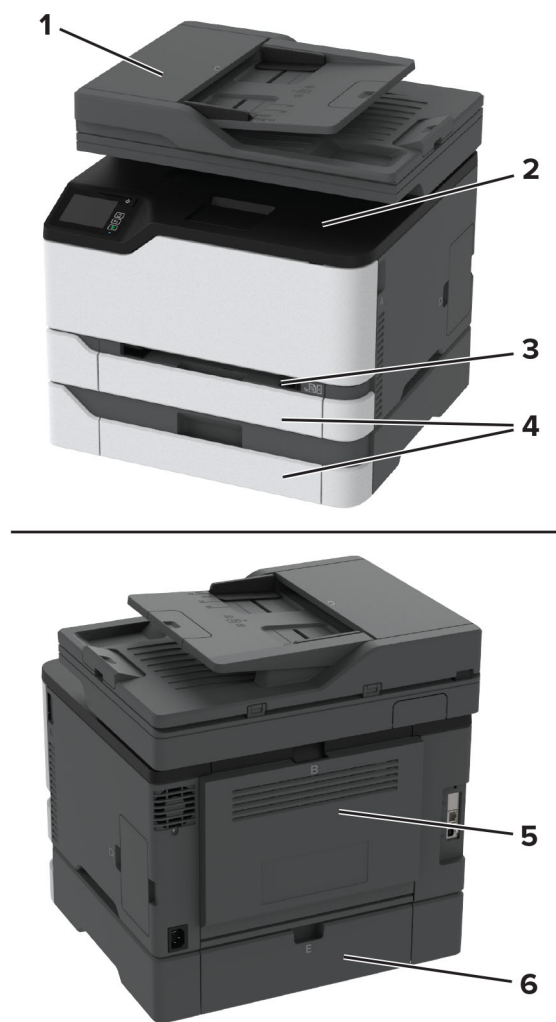

| Jam locations |                                 |
|---------------|---------------------------------|
| 1             | Automatic document feeder (ADF) |
| 2             | Standard bin                    |
| 3             | Manual feeder                   |
| 4             | Trays                           |
| 5             | Door B                          |
| 6             | Door E                          |

### Paper jam in the standard tray

1 Open door B.

 **CAUTION—HOT SURFACE:** The inside of the printer might be hot. To reduce the risk of injury from a hot component, allow the surface to cool before touching it.



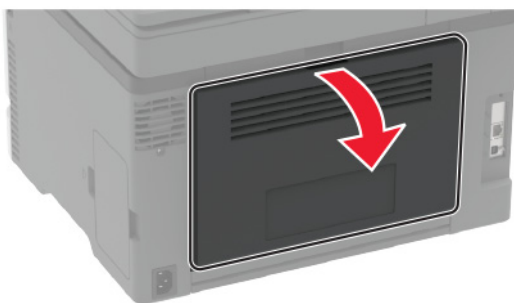

**2** Remove the jammed paper.

**Note:** Make sure that all paper fragments are removed.

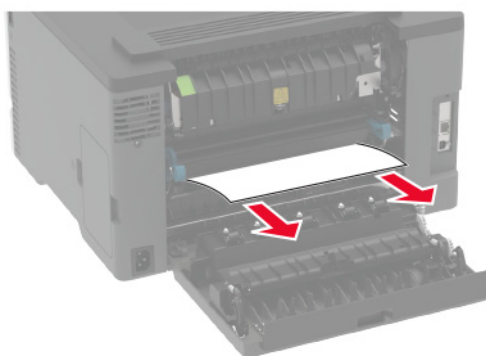

**3** Close the door.

- 4 Remove the tray and the manual feeder.

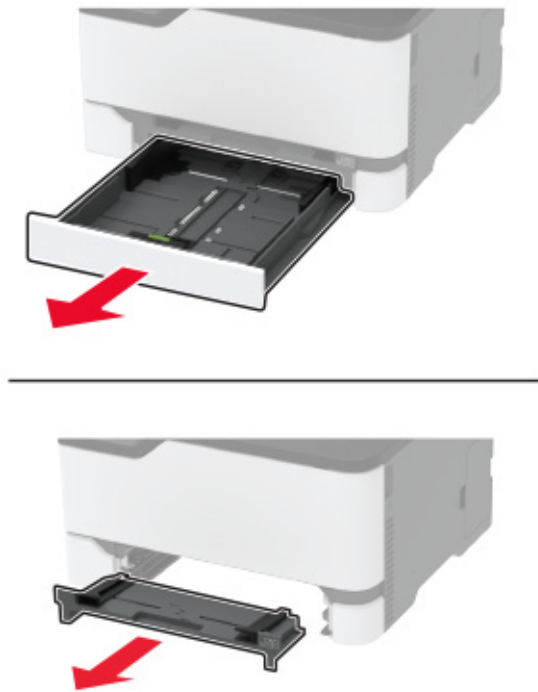

- 5 Remove the jammed paper.

**Note:** Make sure that all paper fragments are removed.

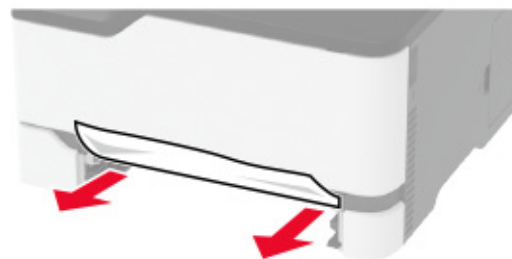

- 6 Insert the manual feeder and the tray.

## Paper jam in the optional tray

- 1 Open door B.

 **CAUTION—HOT SURFACE:** The inside of the printer might be hot. To reduce the risk of injury from a hot component, allow the surface to cool before touching it.

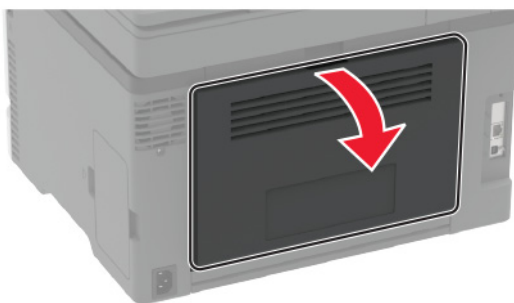

**2** Remove the jammed paper.

**Note:** Make sure that all paper fragments are removed.

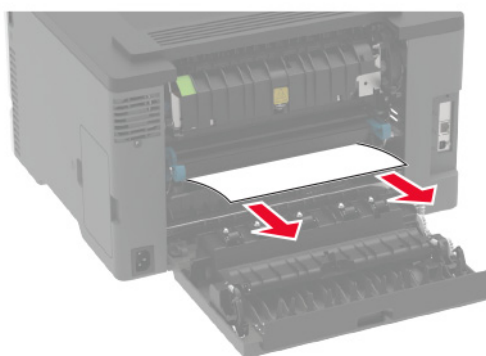

**3** Close the door.

**4** Open door E.

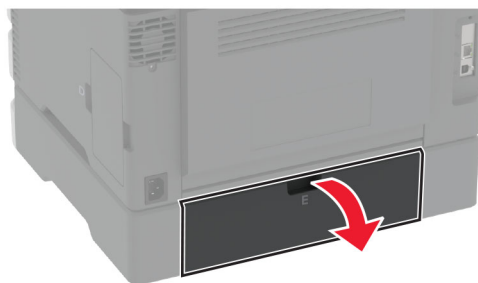

**5** Remove the jammed paper.

**Note:** Make sure that all paper fragments are removed.

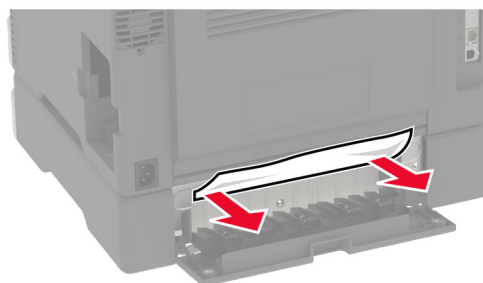

- 6 Close the door.
- 7 Remove the optional tray.



- 8 Remove the jammed paper.
- Note:** Make sure that all paper fragments are removed.



- 9 Insert the tray.

### Paper jam in the standard bin

- 1 Raise the scanner, and then remove the jammed paper.
- Note:** Make sure that all paper fragments are removed.



**2** Lower the scanner.

## Paper jam in the manual feeder

- 1 Remove the tray and the manual feeder.

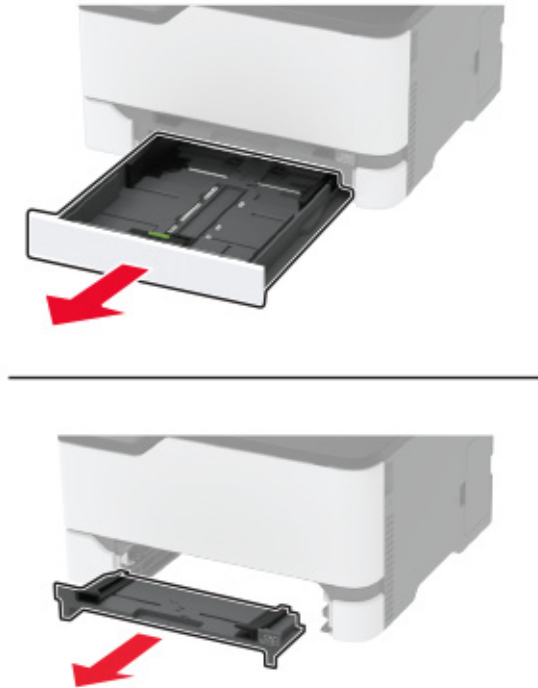

- 2 Remove the jammed paper.

**Note:** Make sure that all paper fragments are removed.

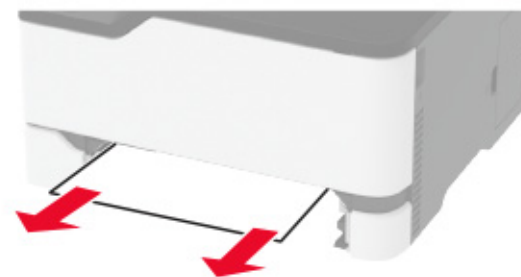

- 3 Insert the manual feeder and the tray.

## Paper jam in door B

- 1 Open door B.

 **CAUTION—HOT SURFACE:** The inside of the printer might be hot. To reduce the risk of injury from a hot component, allow the surface to cool before touching it.

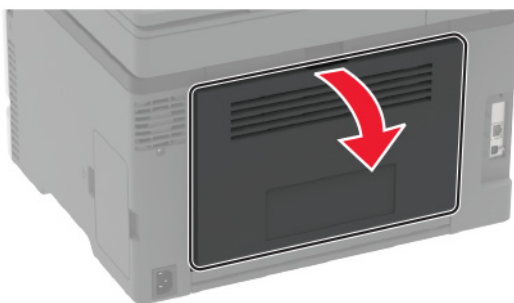

2 Remove the jammed paper from any of the following areas:

**Note:** Make sure that all paper fragments are removed.

- Fuser area

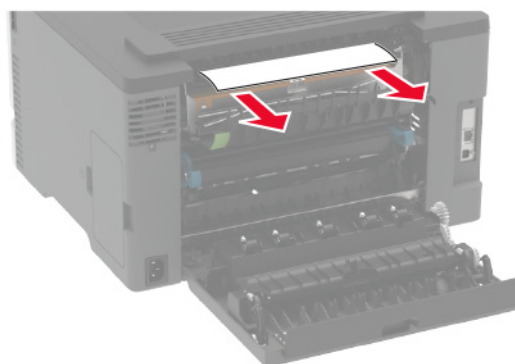
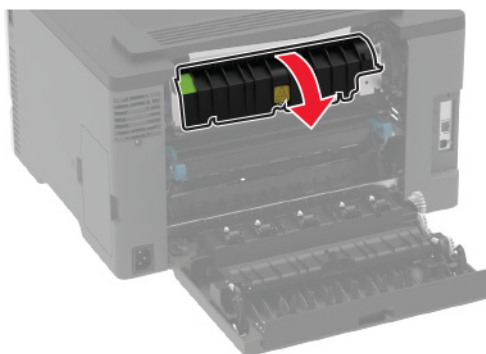

- Below the fuser area

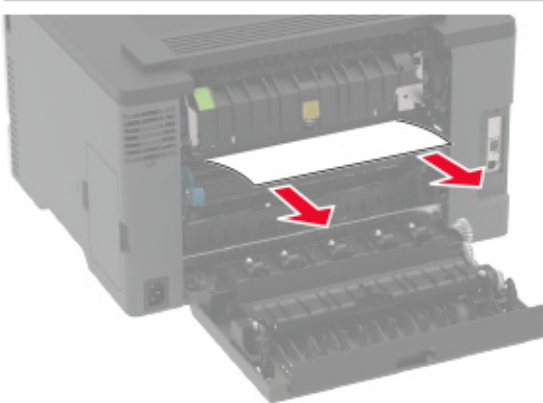
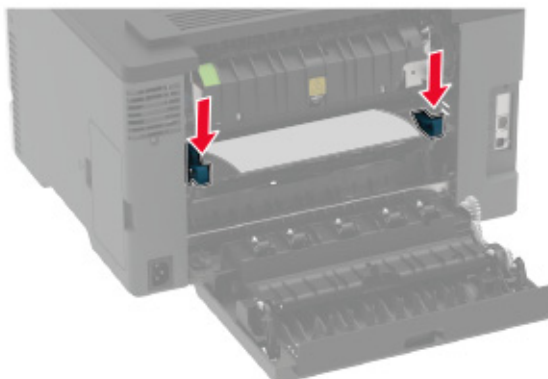

- Duplex unit

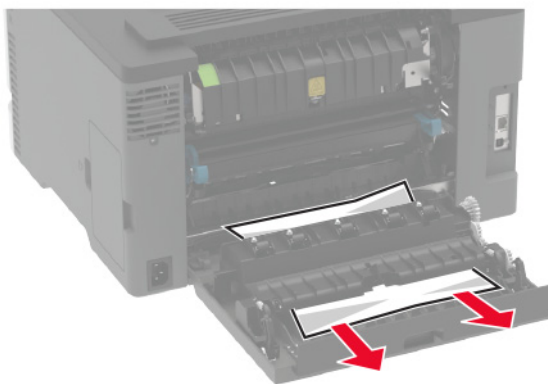

**3** Close the door.



## Paper jam in the automatic document feeder

- 1 Remove all original documents from the ADF tray.
- 2 Open the ADF cover.

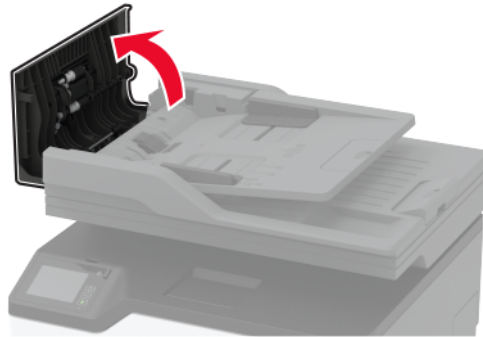

- 3 Remove the jammed paper.

**Note:** Make sure that all paper fragments are removed.

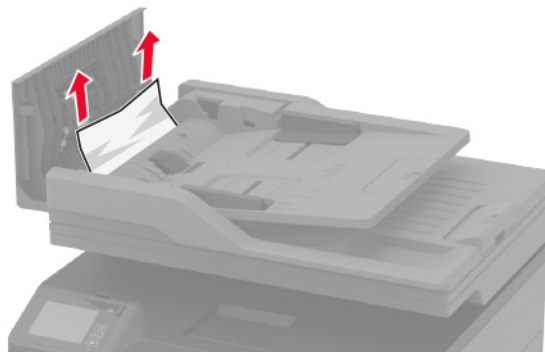

- 4 Close the ADF cover.

## Paper feed problems

### Envelope seals when printing

| Action   | Yes  | No                     |
|--|--|------------------------|
| <p><b>Step 1</b></p> <p><b>a</b> Use an envelope that has been stored in a dry environment.<br/> <b>Note:</b> Printing on envelopes with high moisture content can seal the flaps.</p> <p><b>b</b> Send the print job.</p> <p>Does the envelope seal when printing?</p>                              | Go to step 2.                              | The problem is solved. |
| <p><b>Step 2</b></p> <p><b>a</b> Make sure that paper type is set to Envelope.<br/>           From the control panel, navigate to:<br/> <b>Settings &gt; Paper &gt; Tray Configuration &gt; Paper Size/Type</b></p> <p><b>b</b> Send the print job.</p> <p>Does the envelope seal when printing?</p> | Contact <a href="#">customer support</a> . | The problem is solved. |

### Collated printing does not work

| Action   | Yes                    | No   |
|--|------------------------|--|
| <p><b>Step 1</b></p> <p><b>a</b> From the control panel, navigate to:<br/> <b>Settings &gt; Print &gt; Layout &gt; Collate</b></p> <p><b>b</b> Touch <b>On [1,2,1,2,1,2]</b>.</p> <p><b>c</b> Print the document.</p> <p>Is the document collated correctly?</p> | The problem is solved. | Go to step 2.                              |
| <p><b>Step 2</b></p> <p><b>a</b> From the document that you are trying to print, open the Print dialog, and then select <b>Collate</b>.</p> <p><b>b</b> Print the document.</p> <p>Is the document collated correctly?</p>                                       | The problem is solved. | Go to step 3.                              |
| <p><b>Step 3</b></p> <p><b>a</b> Reduce the number of pages to print.</p> <p><b>b</b> Print the document.</p> <p>Are the pages collated correctly?</p>   | The problem is solved. | Contact <a href="#">customer support</a> . |

### Tray linking does not work

| Action   | Yes                    | No   |
|--|------------------------|--|
| <p><b>Step 1</b></p> <p><b>a</b> Check if the trays contain the same paper size and paper type.</p> <p><b>b</b> Check if the paper guides are positioned correctly.</p> <p><b>c</b> Print the document.</p> <p>Do the trays link correctly?</p>  | The problem is solved. | Go to step 2.                              |
| <p><b>Step 2</b></p> <p><b>a</b> From the home screen, touch <b>Settings &gt; Paper &gt; Tray Configuration &gt; Paper Size/Type</b>.</p> <p><b>b</b> Set the paper size and paper type to match the paper loaded in the linked trays.</p> <p><b>c</b> Print the document.</p> <p>Do the trays link correctly?</p> | The problem is solved. | Go to step 3.                              |
| <p><b>Step 3</b></p> <p><b>a</b> Make sure that Tray Linking is set to Automatic. For more information, see <a href="#">“Linking trays” on page 44</a>.</p> <p><b>b</b> Print the document.</p> <p>Do the trays link correctly?</p>  | The problem is solved. | Contact <a href="#">customer support</a> . |

### Paper frequently jams

| Action   | Yes           | No                     |
|--|---------------|------------------------|
| <p><b>Step 1</b></p> <p><b>a</b> Remove the tray.</p> <p><b>b</b> Check if paper is loaded correctly.</p> <p><b>Notes:</b></p> <ul style="list-style-type: none"> <li>• Make sure that the paper guides are positioned correctly.</li> <li>• Make sure that the stack height is below the maximum paper fill indicator.</li> <li>• Make sure to print on recommended paper size and type.</li> </ul> <p><b>c</b> Insert the tray.</p> <p><b>d</b> Print the document.</p> <p>Do paper jams occur frequently?</p> | Go to step 2. | The problem is solved. |

| Action   | Yes  | No                     |
|--|--|------------------------|
| <p><b>Step 2</b></p> <p><b>a</b> From the control panel, navigate to:<br/> <b>Settings &gt; Paper &gt; Tray Configuration &gt; Paper Size/Type</b></p> <p><b>b</b> Set the correct paper size and type.</p> <p><b>c</b> Print the document.</p> <p>Do paper jams occur frequently?</p> | Go to step 3.                              | The problem is solved. |
| <p><b>Step 3</b></p> <p><b>a</b> Load paper from a fresh package.</p> <p><b>Note:</b> Paper absorbs moisture due to high humidity. Store paper in its original wrapper until you are ready to use it.</p> <p><b>b</b> Print the document.</p> <p>Do paper jams occur frequently?</p>   | Contact <a href="#">customer support</a> . | The problem is solved. |

## Jammed pages are not reprinted

| Action   | Yes                    | No   |
|--|------------------------|--|
| <p><b>a</b> From the control panel, navigate to:<br/> <b>Settings &gt; Device &gt; Notifications &gt; Jam Content Recovery</b></p> <p><b>b</b> In the Jam Recovery menu, select <b>On</b> or <b>Auto</b>.</p> <p><b>c</b> Print the document.</p> <p>Are the jammed pages reprinted?</p> | The problem is solved. | Contact <a href="#">customer support</a> . |

## E-mailing problems

### Disabling the “SMTP server not set up” error message

From the home screen, touch  > **Settings > E-mail > E-mail Setup > Disable “SMTP Server not set up” error > On.**

To prevent the error from happening again, do one or more of the following:

- Update the firmware. For more information, see [“Updating firmware” on page 46](#).
- Configure the e-mail SMTP settings. For more information, see [“Configuring the e-mail SMTP settings” on page 32](#).

## Cannot send e-mails

| Action   | Yes                    | No   |
|--|------------------------|--|
| <p><b>Step 1</b><br/>                     Make sure that the e-mail SMTP settings are configured correctly. For more information, see <a href="#">“Configuring the e-mail SMTP settings” on page 32.</a></p> <p>Can you send an e-mail?</p>  | The problem is solved. | Go to step 2.                              |
| <p><b>Step 2</b><br/>                     Make sure that you are using the correct password. Depending on your e-mail service provider, use your account password, app password, or authentication password. For more information, see <a href="#">“Configuring the e-mail SMTP settings” on page 32.</a></p> <p>Can you send an e-mail?</p> | The problem is solved. | Go to step 3.                              |
| <p><b>Step 3</b><br/>                     Make sure that the printer is connected to a network and that the network is connected to the Internet.</p> <p>Can you send an e-mail?</p>   | The problem is solved. | Contact <a href="#">customer support</a> . |

## Faxing problems

### Caller ID is not shown

**Note:** These instructions apply only to printers that support analog fax. For more information, see [“Setting up the printer to fax” on page 24.](#)

| Action   | Yes                    | No   |
|--|------------------------|--|
| <p>Enable caller ID.<br/>                     From the home screen, touch <b>Settings &gt; Fax &gt; Fax Setup &gt; Fax Receive Settings &gt; Admin Controls &gt; Enable Caller ID.</b></p> <p>Does the caller ID appear?</p> | The problem is solved. | Contact <a href="#">customer support</a> . |

## Cannot set up etherFAX

| Action  | Yes                    | No  |
|---|------------------------|---|
| <p><b>Step 1</b><br/>Check the printer connectivity.</p> <p><b>a</b> Print the Network Setup Page. From the home screen, touch <b>Settings &gt; Reports &gt; Network &gt; Network Setup Page</b>.</p> <p><b>b</b> Check the network status.</p> <p>Is the printer connected to the network?</p> | Go to step 3.          | Go to step 2.   |
| <p><b>Step 2</b><br/>Make sure that the printer is connected to a network and that the network is connected to the Internet.</p> <p>Can you set up etherFAX?</p>  | The problem is solved. | Go to step 3.   |
| <p><b>Step 3</b><br/>Make sure that etherFAX is set up correctly. For more information, see <a href="#">“Setting up the fax function using etherFAX” on page 26</a>.</p> <p>Can you set up etherFAX?</p>  | The problem is solved. | Go to <a href="https://www.etherfax.net/lexmark">https://www.etherfax.net/lexmark</a> . |

## Cannot send or receive faxes using analog fax

| Action   | Yes                    | No            |
|--|------------------------|---------------|
| <p><b>Step 1</b><br/>Resolve any error messages that appear on the display.</p> <p>Can you send or receive a fax?</p>  | The problem is solved. | Go to step 2. |
| <p><b>Step 2</b><br/>Make sure that the cable connections for the following equipment are secure:</p> <ul style="list-style-type: none"> <li>• Telephone</li> <li>• Handset</li> <li>• Answering machine</li> </ul> <p>Can you send or receive a fax?</p>  | The problem is solved. | Go to step 3. |
| <p><b>Step 3</b><br/>Check for a dial tone.</p> <ul style="list-style-type: none"> <li>• Call the fax number to check if it is working properly.</li> <li>• If you are using the On Hook Dial feature, then turn up the volume to check if you hear a dial tone.</li> </ul> <p>Can you hear a dial tone?</p> | Go to step 5.          | Go to step 4. |

| Action  | Yes                           | No   |
|---|-------------------------------|--|
| <p><b>Step 4</b></p> <p>Check the telephone wall jack.</p> <ul style="list-style-type: none"> <li><b>a</b> Connect the analog telephone directly to the wall jack.</li> <li><b>b</b> Listen for a dial tone.</li> <li><b>c</b> If you do not hear a dial tone, then use a different telephone cable.</li> <li><b>d</b> If you still do not hear a dial tone, then connect the analog telephone to a different wall jack.</li> <li><b>e</b> If you hear a dial tone, then connect the printer to that wall jack.</li> </ul> <p>Can you send or receive a fax?</p>  | <p>The problem is solved.</p> | <p>Go to step 5.</p>                             |
| <p><b>Step 5</b></p> <p>Check if the printer is connected to an analog phone service or to the correct digital connector.</p> <ul style="list-style-type: none"> <li>• If you are using an Integrated Services for Digital Network (ISDN) telephone service, then connect to an analog telephone port of an ISDN terminal adapter. For more information, contact your ISDN provider.</li> <li>• If you are using DSL, then connect to a DSL filter or router that supports analog use. For more information, contact your DSL provider.</li> <li>• If you are using a private branch exchange (PBX) telephone service, then make sure that you are connecting to an analog connection on the PBX. If none exists, then consider installing an analog telephone line for the fax machine.</li> </ul> <p>Can you send or receive a fax?</p> | <p>The problem is solved.</p> | <p>Go to step 6.</p>                             |
| <p><b>Step 6</b></p> <p>Temporarily disconnect other equipment and disable other telephone services.</p> <ul style="list-style-type: none"> <li><b>a</b> Disconnect other equipment (such as answering machines, computers, modems, or telephone line splitters) between the printer and the telephone line.</li> <li><b>b</b> Disable call waiting and voice mail. For more information, contact your telephone company.</li> </ul> <p>Can you send or receive a fax?</p>  | <p>The problem is solved.</p> | <p>Go to step 7.</p>                             |
| <p><b>Step 7</b></p> <p>Scan the original document one page at a time.</p> <ul style="list-style-type: none"> <li><b>a</b> Dial the fax number.</li> <li><b>b</b> Scan the document.</li> </ul> <p>Can you send or receive a fax?</p>   | <p>The problem is solved.</p> | <p>Contact <a href="#">customer support</a>.</p> |

### Cannot send or receive faxes using etherFAX

| Action  | Yes                    | No  |
|---|------------------------|---|
| <p><b>Step 1</b><br/>                     Make sure that the printer is connected to a network and that the network is connected to the Internet.</p> <p>Can you send or receive faxes using etherFAX?</p>  | The problem is solved. | Go to step 2.   |
| <p><b>Step 2</b></p> <p><b>a</b> From the home screen, touch <b>Settings &gt; Fax &gt; Fax Setup &gt; General Fax Settings</b>.</p> <p><b>b</b> Make sure that you have the correct fax number.</p> <p><b>c</b> Make sure that Fax Transport is set to etherFAX.</p> <p>Can you send or receive faxes using etherFAX?</p> | The problem is solved. | Go to step 3.   |
| <p><b>Step 3</b><br/>                     Split large documents into smaller file sizes.</p> <p>Can you send or receive faxes using etherFAX?</p>   | The problem is solved. | Go to <a href="https://www.etherfax.net/lexmark">https://www.etherfax.net/lexmark</a> . |

### Can receive but not send faxes using analog fax

| Action   | Yes                    | No   |
|--|------------------------|--|
| <p><b>Step 1</b><br/>                     Load an original document properly into the ADF tray or on the scanner glass.</p> <p>Can you send faxes?</p>   | The problem is solved. | Go to step 2.                              |
| <p><b>Step 2</b><br/>                     Set up the shortcut number properly.</p> <ul style="list-style-type: none"> <li>• Check if the shortcut number is set for the telephone number that you want to dial.</li> <li>• Dial the telephone number manually.</li> </ul> <p>Can you send faxes?</p> | The problem is solved. | Contact <a href="#">customer support</a> . |



### Can send but not receive faxes using analog fax

| Action  | Yes                    | No   |
|---|------------------------|--|
| <p><b>Step 1</b><br/>Make sure that the paper source is not empty.</p> <p>Can you receive faxes?</p>  | The problem is solved. | Go to step 2.                              |
| <p><b>Step 2</b><br/>Check the ring count delay settings.<br/>From the home screen, touch <b>Settings &gt; Fax &gt; Fax Setup &gt; Fax Receive Settings &gt; Rings to Answer</b>.</p> <p>Can you receive faxes?</p> | The problem is solved. | Go to step 3.                              |
| <p><b>Step 3</b><br/>If the printer is printing blank pages, then see <a href="#">“Blank or white pages” on page 167</a>.</p> <p>Can you receive faxes?</p>   | The problem is solved. | Contact <a href="#">customer support</a> . |

### Poor fax print quality

| Action  | Yes                    | No   |
|---|------------------------|--|
| <p><b>Step 1</b><br/>Make sure that there are no print quality defects.</p> <p><b>a</b> From the control panel, touch <b>Settings &gt; Troubleshooting &gt; Print Quality Test Pages</b>.</p> <p><b>b</b> Correct any print quality defects. For more information, see <a href="#">“Print quality is poor” on page 167</a>.</p> <p>Is the fax print quality satisfactory?</p> | The problem is solved. | Go to step 2.                              |
| <p><b>Step 2</b><br/>Decrease the incoming fax transmission speed.</p> <p><b>a</b> From the control panel, touch <b>Settings &gt; Fax &gt; Fax Setup &gt; Fax Receive Settings &gt; Admin Controls</b>.</p> <p><b>b</b> In the Max Speed menu, select a lower transmission speed.</p> <p>Is the fax print quality satisfactory?</p>   | The problem is solved. | Contact <a href="#">customer support</a> . |

## Missing information on the fax cover page

| Action  | No                     | Yes  |
|---|------------------------|--|
| <p><b>a</b> Turn off the printer, wait for about 10 seconds, and then turn on the printer.</p> <p><b>b</b> Send or retrieve the fax.</p> <p>Is there missing information on the fax cover page?</p> | The problem is solved. | Contact <a href="#">customer support</a> . |

## Cannot send the fax cover page from the computer

| Action  | Yes                    | No   |
|---|------------------------|--|
| <p><b>Step 1</b></p> <p><b>a</b> Make sure that the print driver is updated. For more information, see <a href="#">“Installing the printer software” on page 44</a>.</p> <p><b>b</b> Send the fax.</p> <p>Can you send the fax cover page?</p>  | The problem is solved. | Go to step 2.                              |
| <p><b>Step 2</b></p> <p><b>a</b> From the document that you are trying to fax, open the Print dialog.</p> <p><b>b</b> Select the printer, and then click <b>Properties, Preferences, Options,</b> or <b>Setup</b>.</p> <p><b>c</b> Click <b>Fax</b>, and then clear the <b>Always display settings prior to faxing</b> setting.</p> <p><b>d</b> Send the fax.</p> <p>Can you send the fax cover page?</p> | The problem is solved. | Contact <a href="#">customer support</a> . |

## Scanning problems

### Cannot scan to a computer

| Action   | Yes                    | No            |
|--|------------------------|---------------|
| <p><b>Step 1</b></p> <p>Perform a copy job.</p> <p>Is the copy job successful?</p>   | Go to step 3.          | Go to step 2. |
| <p><b>Step 2</b></p> <p><b>a</b> Turn off the printer, wait for about 10 seconds, and then turn it back on.</p> <p><b>b</b> Scan the document.</p> <p>Can you scan the document to a computer?</p> | The problem is solved. | Go to step 3. |

| Action  | Yes                    | No   |
|---|------------------------|--|
| <p><b>Step 3</b><br/>Check the printer connectivity.</p> <ul style="list-style-type: none"> <li><b>a</b> Print the Network Setup Page. From the control panel, navigate to:<br/><b>Settings &gt; Reports &gt; Network &gt; Network Setup Page.</b></li> <li><b>b</b> Check the network status.</li> </ul> <p>Is the printer connected to the network?</p> | Go to step 5.          | Go to step 4.                              |
| <p><b>Step 4</b><br/><b>a</b> Connect the printer to the network.<br/><b>b</b> Scan the document.</p> <p>Can you scan the document to a computer?</p>   | The problem is solved. | Go to step 5.                              |
| <p><b>Step 5</b><br/><b>a</b> Make sure that the printer and the computer are connected to the same network.<br/><b>b</b> Scan the document.</p> <p>Can you scan the document to a computer?</p>  | The problem is solved. | Contact <a href="#">customer support</a> . |

### Cannot scan to a network folder

| Action   | Yes                    | No            |
|--|------------------------|---------------|
| <p><b>Step 1</b><br/><b>a</b> Create a network folder shortcut.<br/><b>b</b> Scan a document using the shortcut. For more information, see <a href="#">“Scanning to a network folder using a shortcut” on page 72.</a></p> <p>Can you scan a document and save it to a network folder?</p> | The problem is solved. | Go to step 2. |
| <p><b>Step 2</b><br/>Make sure that the network folder path and format are correct. For example, <code>//server_hostname/foldername/path</code>, where <b>server_hostname</b> is a fully qualified domain (FQDN) or IP address.</p> <p>Is the network folder path and format correct?</p>  | Go to step 3.          | Go to step 4. |
| <p><b>Step 3</b><br/>Make sure that you have a write access permission to the network folder.</p> <p>Can you scan a document and save it to a network folder?</p>  | The problem is solved. | Go to step 4. |

| Action  | Yes                           | No   |
|---|-------------------------------|--|
| <p><b>Step 4</b><br/>Update the network folder shortcut.</p> <p><b>a</b> Open a web browser, and then type the printer IP address in the address field.</p> <p><b>Notes:</b></p> <ul style="list-style-type: none"> <li>View the printer IP address on the home screen. The IP address appears as four sets of numbers separated by periods, such as 123.123.123.123.</li> <li>If you are using a proxy server, then temporarily disable it to load the web page correctly.</li> </ul> <p><b>b</b> Click <b>Shortcuts</b>, and then select a shortcut.</p> <p><b>Note:</b> If you have multiple shortcut types, then select Network Folder.</p> <p><b>c</b> In the Share Path field, type the network folder path.</p> <p><b>Notes:</b></p> <ul style="list-style-type: none"> <li>If your share path is <code>\\server_hostname\foldername\path</code>, then type <code>//server_hostname/foldername/path</code>.</li> <li>Make sure that you use forward slashes when typing the share path.</li> </ul> <p><b>d</b> From the Authentication menu, select your authentication method.</p> <p><b>Note:</b> If Authentication is set to “Use assigned username and password,” then in the User Name and Password fields, type your credentials.</p> <p><b>e</b> Click <b>Save</b>.</p> <p>Can you scan a document and save it to a network folder?</p> | <p>The problem is solved.</p> | <p>Go to step 5.</p>                             |
| <p><b>Step 5</b><br/>Make sure that the printer and the network folder are connected to the same network.</p> <p>Can you scan a document and save it to a network folder?</p>   | <p>The problem is solved.</p> | <p>Contact <a href="#">customer support</a>.</p> |

### Partial copies of document or photo

| Action  | Yes                           | No                   |
|---|-------------------------------|----------------------|
| <p><b>Step 1</b></p> <p><b>a</b> Make sure that the document or photo is loaded facedown on the upper left corner of the scanner glass.</p> <p><b>b</b> Copy the document or photo.</p> <p>Is the document or photo copied correctly?</p> | <p>The problem is solved.</p> | <p>Go to step 2.</p> |

| Action  | Yes                           | No   |
|---|-------------------------------|--|
| <p><b>Step 2</b></p> <p><b>a</b> Match the paper size setting and the paper loaded in the tray.</p> <p><b>b</b> Copy the document or photo.</p> <p>Is the document or photo copied correctly?</p> | <p>The problem is solved.</p> | <p>Contact <a href="#">customer support</a>.</p> |

### Scan job was not successful

| Action   | Yes                           | No   |
|--|-------------------------------|--|
| <p><b>Step 1</b></p> <p>Check the cable connections.</p> <p><b>a</b> Make sure that the Ethernet or USB cable is securely connected to the computer and the printer.</p> <p><b>b</b> Resend the scan job.</p> <p>Is the scan job successful?</p>   | <p>The problem is solved.</p> | <p>Go to step 2.</p>                             |
| <p><b>Step 2</b></p> <p>Check the file you want to scan.</p> <p><b>a</b> Make sure that the file name is not already used in the destination folder.</p> <p><b>b</b> Make sure that the document or photo you want to scan is not open in another application.</p> <p><b>c</b> Resend the scan job.</p> <p>Is the scan job successful?</p> | <p>The problem is solved.</p> | <p>Go to step 3.</p>                             |
| <p><b>Step 3</b></p> <p><b>a</b> Make sure that the <b>Append time stamp</b> or the <b>Overwrite existing file</b> check box is selected in the destination configuration settings.</p> <p><b>b</b> Resend the scan job.</p> <p>Is the scan job successful?</p>  | <p>The problem is solved.</p> | <p>Contact <a href="#">customer support</a>.</p> |

### Poor copy quality

| Action   | Yes                           | No   |
|--|-------------------------------|--|
| <p><b>Step 1</b></p> <p><b>a</b> Clean the scanner glass and the ADF glass with a damp, soft, lint-free cloth. If your printer has a second ADF glass inside the ADF, then also clean that glass.</p> <p>For more information, see <a href="#">“Cleaning the scanner” on page 158</a>.</p> <p><b>b</b> Make sure that the document or photo is loaded facedown on the upper left corner of the scanner glass.</p> <p><b>c</b> Copy the document or photo.</p> <p>Is the copy quality satisfactory?</p> | <p>The problem is solved.</p> | <p>Go to step 2.</p>                             |
| <p><b>Step 2</b></p> <p><b>a</b> Check the quality of the original document or photo.</p> <p><b>b</b> Adjust the scan quality settings.</p> <p><b>c</b> Copy the document or photo.</p> <p>Is the copy quality satisfactory?</p>   | <p>The problem is solved.</p> | <p>Contact <a href="#">customer support</a>.</p> |

### Vertical dark streaks on output when scanning from the ADF

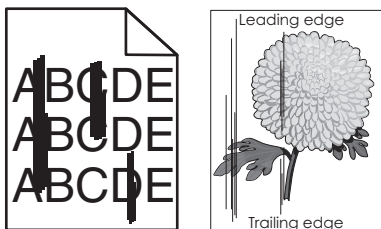

| Action  | Yes  | No                            |
|---|--|-------------------------------|
| <p><b>a</b> Open the scanner cover.</p> <p><b>b</b> Using a damp, soft, lint-free cloth, wipe the ADF glass pad.</p> <p><b>Note:</b> In some printer models, this location has an ADF glass instead of a pad.</p> <p><b>c</b> Close the scanner cover.</p> <p><b>d</b> Scan the document.</p> <p>Do vertical streaks appear on scanned documents?</p> | <p>Contact <a href="#">customer support</a>.</p> | <p>The problem is solved.</p> |

### Jagged image or text when scanning from the ADF

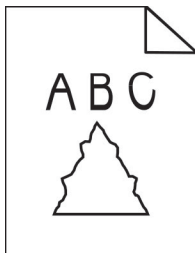

| Action  | Yes  | No                            |
|---|--|-------------------------------|
| <p><b>a</b> Load 50 sheets of clean, plain paper into the ADF.</p> <p><b>Note:</b> The plain paper helps clean or remove dust and other coating from the ADF feed rollers.</p> <p><b>b</b> From the control panel, press .</p> <p><b>c</b> Load an original document into the ADF.</p> <p><b>d</b> Scan the document.</p> <p>Do jagged images or texts appear on the output?</p> | <p>Contact <a href="#">customer support</a>.</p> | <p>The problem is solved.</p> |

### Scanner does not close

| Action   | Yes                           | No   |
|--|-------------------------------|--|
| <p>Remove obstructions that keep the scanner cover open.</p> <p>Did the scanner cover close correctly?</p> | <p>The problem is solved.</p> | <p>Contact <a href="#">customer support</a>.</p> |

### Scanning takes too long or freezes the computer

| Action   | Yes  | No                            |
|--|--|-------------------------------|
| <p>Close all applications that are interfering with the scan.</p> <p>Does scanning take too long or freeze the computer?</p> | <p>Contact <a href="#">customer support</a>.</p> | <p>The problem is solved.</p> |

## Scanner does not respond

| Action  | Yes                    | No   |
|---|------------------------|--|
| <p><b>Step 1</b></p> <p><b>a</b> Check if the power cord is connected properly to the printer and the electrical outlet.</p> <p> <b>CAUTION—POTENTIAL INJURY:</b> To avoid the risk of fire or electrical shock, connect the power cord to an appropriately rated and properly grounded electrical outlet that is near the product and easily accessible.</p> <p><b>b</b> Copy or scan the document.</p> <p>Is the scanner responding?</p> | The problem is solved. | Go to step 2.                              |
| <p><b>Step 2</b></p> <p><b>a</b> Check if the printer is turned on.</p> <p><b>b</b> Resolve any error messages that appear on the display.</p> <p><b>c</b> Copy or scan the document.</p> <p>Is the scanner responding?</p>   | The problem is solved. | Go to step 3.                              |
| <p><b>Step 3</b></p> <p><b>a</b> Turn off the printer, wait for about 10 seconds, and then turn the printer on.</p> <p><b>b</b> Copy or scan the document.</p> <p>Is the scanner responding?</p>  | The problem is solved. | Contact <a href="#">customer support</a> . |

## Adjusting scanner registration

- 1 From the control panel, navigate to:  
**Settings > Device > Maintenance > Config Menu > Scanner Configuration > Scanner Manual Registration**
- 2 Touch **Print Quick Test**.
- 3 Place the Print Quick Test page on the scanner glass, and then touch **Flatbed Registration**.
- 4 Touch **Copy Quick Test**.
- 5 Compare the Copy Quick Test page with the original document.  
**Note:** If the margins of the test page are different from the original document, then adjust Left Margin and Top Margin.
- 6 Repeat [step 4](#) and [step 5](#) until the margins of the Copy Quick Test page closely match the original document.



## Adjusting ADF registration

- 1 From the control panel, navigate to:  
**Settings > Device > Maintenance > Config Menu > Scanner Configuration > Scanner Manual Registration**
- 2 Touch **Print Quick Test**.
- 3 Place the Print Quick Test page on the ADF tray.
- 4 Touch **Front ADF Registration** or **Rear ADF Registration**.

**Notes:**

- To align Front ADF Registration, place the test page faceup, short edge first into the ADF.
- To align Rear ADF Registration, place the test page facedown, short edge first into the ADF.

- 5 Touch **Copy Quick Test**.
- 6 Compare the Copy Quick Test page with the original document.  
**Note:** If the margins of the test page are different from the original document, then adjust Horizontal Adjust and Top Margin.
- 7 Repeat [step 5](#) and [step 6](#) until the margins of the Copy Quick Test page closely match the original document.

## Color quality problems

### Modifying the colors in printed output

- 1 From the home screen, touch **Settings > Print > Quality > Advanced Imaging > Color Correction**.
- 2 In the Color Correction menu, touch **Manual > Color Correction Content**.
- 3 Choose the appropriate color conversion setting.

| Object type                           | Color conversion tables  |
|---------------------------------------|--|
| RGB Image<br>RGB Text<br>RGB Graphics | <ul style="list-style-type: none"> <li>• Vivid—Produces brighter, more saturated colors and may be applied to all incoming color formats.</li> <li>• sRGB Display—Produces an output that approximates the colors shown on a computer monitor. Black toner usage is optimized for printing photographs.</li> <li>• Display-True Black—Produces an output that approximates the colors shown on a computer monitor. This setting uses only black toner to create all levels of neutral gray.</li> <li>• sRGB Vivid—Provides an increased color saturation for the sRGB Display color correction. Black toner usage is optimized for printing business graphics.</li> <li>• Off</li> </ul> |

| Object type                              | Color conversion tables   |
|--|---|
| CMYK Image<br>CMYK Text<br>CMYK Graphics | <ul style="list-style-type: none"> <li>• US CMYK—Applies color correction to approximate the Specifications for Web Offset Publishing (SWOP) color output.</li> <li>• Euro CMYK—Applies color correction to approximate Euroscale color output.</li> <li>• Vivid CMYK—Increases the color saturation of the US CMYK color correction setting.</li> <li>• Off</li> </ul> |

## FAQ about color printing

### What is RGB color?

RGB color is a method of describing colors by indicating the amount of red, green, or blue used to produce a certain color. Red, green, and blue light can be added in various amounts to produce a large range of colors observed in nature. Computer screens, scanners, and digital cameras use this method to display colors.

### What is CMYK color?

CMYK color is a method of describing colors by indicating the amount of cyan, magenta, yellow, and black used to reproduce a particular color. Cyan, magenta, yellow, and black inks or toners can be printed in various amounts to produce a large range of colors observed in nature. Printing presses, inkjet printers, and color laser printers create colors in this manner.

### How is color specified in a document to be printed?

Software programs are used to specify and modify the document color using RGB or CMYK color combinations. For more information, see the software program Help topics.

### How does the printer know what color to print?

When printing a document, information describing the type and color of each object is sent to the printer and is passed through color conversion tables. Color is translated into the appropriate amounts of cyan, magenta, yellow, and black toner used to produce the color you want. The object information determines the application of color conversion tables. For example, it is possible to apply one type of color conversion table to text while applying a different color conversion table to photographic images.

### What is manual color correction?

When manual color correction is enabled, the printer employs user-selected color conversion tables to process objects. Manual color correction settings are specific to the type of object being printed (text, graphics, or images). It is also specific to how the color of the object is specified in the software program (RGB or CMYK combinations). To apply a different color conversion table manually, see [“Modifying the colors in printed output” on page 225](#).

If the software program does not specify colors with RGB or CMYK combinations, then manual color correction is not useful. It is also not effective if the software program or the computer operating system controls the adjustment of colors. In most situations, setting the Color Correction to Auto generates preferred colors for the documents.

### How can I match a particular color (such as a corporate logo)?

From the printer Quality menu, nine types of Color Samples sets are available. These sets are also available from the Color Samples page of the Embedded Web Server. Selecting any sample set generates multiple-page prints consisting of hundreds of colored boxes. Each box contains a CMYK or RGB combination, depending on the table selected. The observed color of each box is obtained by passing the CMYK or RGB combination labeled on the box through the selected color conversion table.

By examining Color Samples sets, you can identify the box with color closest to the color being matched. The color combination labeled on the box can then be used for modifying the color of the object in a software program. For more information, see the software program Help topics. Manual color correction may be necessary to use the selected color conversion table for the particular object.

Selecting which Color Samples set to use for a particular color-matching problem depends on:

- The Color Correction setting being used (Auto, Off, or Manual)
- The type of object being printed (text, graphics, or images)
- How the color of the object is specified in the software program (RGB or CMYK combinations)

If the software program does not specify colors with RGB or CMYK combinations, then the Color Samples pages are not useful. Additionally, some software programs adjust the RGB or CMYK combinations specified in the program through color management. In these situations, the printed color may not be an exact match of the Color Samples pages.

### The print appears tinted

| Action  | Yes  | No                     |
|---|--|------------------------|
| <p><b>Step 1</b><br/>Perform Color Adjust.</p> <p><b>a</b> From the home screen, touch <b>Settings &gt; Print &gt; Quality &gt; Advanced Imaging &gt; Color Adjust.</b></p> <p><b>b</b> Print the document.</p> <p>Does the print appear tinted?</p>  | Go to step 2.                              | The problem is solved. |
| <p><b>Step 2</b><br/>Perform Color Balance.</p> <p><b>a</b> From the home screen, touch <b>Settings &gt; Print &gt; Quality &gt; Advanced Imaging &gt; Color Balance.</b></p> <p><b>b</b> Adjust the settings.</p> <p><b>c</b> Print the document.</p> <p>Does the print appear tinted?</p> | Contact <a href="#">customer support</a> . | The problem is solved. |

### Contacting customer support

Before contacting customer support, make sure to have the following information:

- Printer problem
- Error message
- Printer model type and serial number

Go to <http://support.lexmark.com> to receive e-mail or chat support, or browse through the library of manuals, support documentation, drivers, and other downloads.

Technical support via telephone is also available. In the U.S. or Canada, call 1-800-539-6275. For other countries or regions, go to <http://support.lexmark.com>.

# Recycle and dispose

## Recycling Lexmark products

To return Lexmark products for recycling:

- 1 Go to [www.lexmark.com/recycle](http://www.lexmark.com/recycle).
- 2 Select the product you want to recycle.

**Note:** Printer supplies and hardware not listed in the Lexmark Collection and Recycling Program may be recycled through your local recycling center.

## Recycling Lexmark packaging

Lexmark continually strives to minimize packaging. Less packaging helps to ensure that Lexmark printers are transported in the most efficient and environmentally sensitive manner and that there is less packaging to dispose of. These efficiencies result in fewer greenhouse emissions, energy savings, and natural resource savings. Lexmark also offers recycling of packaging components in some countries or regions. For more information, go to [www.lexmark.com/recycle](http://www.lexmark.com/recycle), and then choose your country or region. Information on available packaging recycling programs is included with the information on product recycling.

Lexmark cartons are 100% recyclable where corrugated recycling facilities exist. Facilities may not exist in your area.

The foam used in Lexmark packaging is recyclable where foam recycling facilities exist. Facilities may not exist in your area.

When you return a cartridge to Lexmark, you can reuse the box that the cartridge came in. Lexmark recycles the box.

# Notices

## Product information

Product name:

Lexmark CX331adwe; Lexmark CX431adw, Lexmark CX431dw; Lexmark MC3224adwe, Lexmark MC3224dwe, Lexmark MC3224i; Lexmark MC3326adwe, Lexmark MC3326i; Lexmark MC3426adw, Lexmark MC3426i, Lexmark XC2326 MFPs

Machine type:

3500

Models:

285, 485, 685, 876, 8c6, 8c9

## Edition notice

September 2021

**The following paragraph does not apply to any country where such provisions are inconsistent with local law:** LEXMARK INTERNATIONAL, INC., PROVIDES THIS PUBLICATION "AS IS" WITHOUT WARRANTY OF ANY KIND, EITHER EXPRESS OR IMPLIED, INCLUDING, BUT NOT LIMITED TO, THE IMPLIED WARRANTIES OF MERCHANTABILITY OR FITNESS FOR A PARTICULAR PURPOSE. Some states do not allow disclaimer of express or implied warranties in certain transactions; therefore, this statement may not apply to you.

This publication could include technical inaccuracies or typographical errors. Changes are periodically made to the information herein; these changes will be incorporated in later editions. Improvements or changes in the products or the programs described may be made at any time.

References in this publication to products, programs, or services do not imply that the manufacturer intends to make these available in all countries in which it operates. Any reference to a product, program, or service is not intended to state or imply that only that product, program, or service may be used. Any functionally equivalent product, program, or service that does not infringe any existing intellectual property right may be used instead. Evaluation and verification of operation in conjunction with other products, programs, or services, except those expressly designated by the manufacturer, are the user's responsibility.

For Lexmark technical support, go to <http://support.lexmark.com>.

For information on Lexmark's privacy policy governing the use of this product, go to [www.lexmark.com/privacy](http://www.lexmark.com/privacy).

For information on supplies and downloads, go to [www.lexmark.com](http://www.lexmark.com).

© 2019 Lexmark International, Inc.

All rights reserved.

## GOVERNMENT END USERS

The Software Program and any related documentation are "Commercial Items," as that term is defined in 48 C.F.R. 2.101, "Computer Software" and "Commercial Computer Software Documentation," as such terms are used in 48 C.F.R. 12.212 or 48 C.F.R. 227.7202, as applicable. Consistent with 48 C.F.R. 12.212 or 48 C.F.R.

227.7202-1 through 227.7207-4, as applicable, the Commercial Computer Software and Commercial Software Documentation are licensed to the U.S. Government end users (a) only as Commercial Items and (b) with only those rights as are granted to all other end users pursuant to the terms and conditions herein.

## Trademarks

Lexmark, the Lexmark logo, and MarkNet are trademarks or registered trademarks of Lexmark International, Inc. in the United States and/or other countries.

Gmail, Android, Google Play, and Google Chrome are trademarks of Google LLC.

Macintosh, Safari, and AirPrint are trademarks of Apple Inc., registered in the U.S. and other countries. App Store and iCloud are service marks of Apple Inc., registered in the U.S. and other countries. Use of the Works with Apple badge means that an accessory has been designed to work specifically with the technology identified in the badge and has been certified by the developer to meet Apple performance standards.

The Mopria® word mark is a registered and/or unregistered trademark of Mopria Alliance, Inc. in the United States and other countries. Unauthorized use is strictly prohibited.

PCL® is a registered trademark of the Hewlett-Packard Company. PCL is Hewlett-Packard Company's designation of a set of printer commands (language) and functions included in its printer products. This printer is intended to be compatible with the PCL language. This means the printer recognizes PCL commands used in various application programs, and that the printer emulates the functions corresponding to the commands.

PostScript is a registered trademark of Adobe Systems Incorporated in the United States and/or other countries.

Wi-Fi® and Wi-Fi Direct® are registered trademarks of Wi-Fi Alliance®.

All other trademarks are the property of their respective owners.

## Licensing notices

All licensing notices associated with this product can be viewed from the CD:\NOTICES directory of the installation software CD.

## Noise emission levels

The following measurements were made in accordance with ISO 7779 and reported in conformance with ISO 9296.

**Note:** Some modes may not apply to your product.

| 1-meter average sound pressure, dBA |   |
|-------------------------------------|---|
| Printing                            | One-sided, mono: 49 (MC3224); 50 (CX331adwe, MC3326a); 51 (CX431, MC3426, XC2326)<br>One-sided, color: 51 (CX331, MC3224, MC3326a); 52 (CX431, MC3426, XC2326)<br>Two-sided, mono: 49 (CX331, MC3224, MC3326); 50 (CX431, MC3426, XC2326)<br>Two-sided, color: 50 (MC3224); 51 (CX331, MC3326); 52 (CX431, MC3426, XC232) |
| Scanning                            | Mono: 46 (MC3224dwe); 50 (CX331, MC3224adwe, MC3224i, MC3326); 55 (CX431, MC3426, XC2326)<br>Color: 40 (MC3224dwe); 44 (CX331, MC3224adwe, MC3224i, MC3326); 51 (CX431, MC3426, XC2326)   |
| Copying                             | Mono: 50 (MC3224dwe); 53 (CX331, MC3224adwe, MC3224i, MC3326); 56 (CX431, MC3426a, XC2326)<br>Color: 49 (MC3224); 50 (CX331adwe, MC3326); 54 (CX431, MC3426, XC2326)  |
| Ready                               | 14  |

Values are subject to change. See [www.lexmark.com](http://www.lexmark.com) for current values.

## Waste from Electrical and Electronic Equipment (WEEE) directive



The WEEE logo signifies specific recycling programs and procedures for electronic products in countries of the European Union. We encourage the recycling of our products.

If you have further questions about recycling options, visit the Lexmark Web site at [www.lexmark.com](http://www.lexmark.com) for your local sales office phone number.



## India E-Waste notice

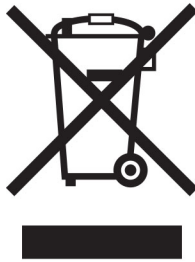

This product including components, consumables, parts and spares complies with the “India E-Waste Rules” and prohibits use of lead, mercury, hexavalent chromium, polybrominated biphenyls or polybrominated diphenyl ethers in concentrations exceeding 0.1% by weight and 0.01% by weight for cadmium, except for the exemption set in the Rule.

## Lithium-ion rechargeable battery

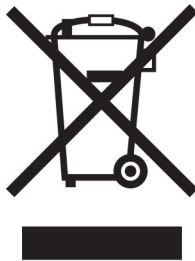

This product may contain a coin-cell, lithium-ion rechargeable battery, which should only be removed by a trained technician. Crossed-out wheeled bin means the product should not be discarded as unsorted waste but must be sent to separate collection facilities for recovery and recycling. In the event the battery is removed, do not dispose of the battery in your household waste. There may be separate collection systems for batteries in your local community, such as a battery-recycling drop-off location. The separate collection of waste batteries assures appropriate treatment of waste including reuse and recycling and prevents any potential negative effects on human health and environment. Please responsibly dispose of the batteries.

## Product disposal

Do not dispose of the printer or supplies in the same manner as normal household waste. Consult your local authorities for disposal and recycling options.

## EU battery directive

This product may contain a coin-cell lithium rechargeable battery. This product is in compliance with EU Directive 2006/66/EC as amended by Directive 2008/12/EC, 2008/103/EC, and 2013/56/EU.

## Returning Lexmark cartridges for reuse or recycling

The Lexmark Cartridge Collection Program allows you to return used cartridges for free to Lexmark for reuse or recycling. One hundred percent of the empty cartridges returned to Lexmark are either reused or demanufactured for recycling. The boxes used to return the cartridges are also recycled.

To return Lexmark cartridges for reuse or recycling, do the following:

- 1 Go to [www.lexmark.com/recycle](http://www.lexmark.com/recycle).
- 2 Select the product that you want to recycle.

## Static sensitivity notice

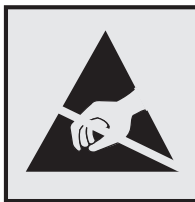

This symbol identifies static-sensitive parts. Do not touch the areas near these symbols without first touching a metal surface in an area away from the symbol.

To prevent damage from electrostatic discharge when performing maintenance tasks such as clearing paper jams or replacing supplies, touch any exposed metal frame of the printer before accessing or touching interior areas of the printer even if the symbol is not present.

## ENERGY STAR

Any Lexmark product bearing the ENERGY STAR® emblem on the product or on a start-up screen is certified to comply with Environmental Protection Agency (EPA) ENERGY STAR requirements as of the date of manufacture.



## Temperature information

|   |  |
|---|--|
| Operating temperature and relative humidity   | 10 to 32.2°C (50 to 90°F) and 15 to 80% RH<br>15.6 to 32.2°C (60 to 90°F) and 8 to 80% RH<br>Maximum wet-bulb temperature <sup>2</sup> : 22.8°C (73°F)<br>Non-condensing environment |
| Printer / cartridge / imaging unit long-term storage <sup>1</sup>   | 15.6 to 32.2°C (60 to 90°F) and 8 to 80% RH<br>Maximum wet-bulb temperature <sup>2</sup> : 22.8°C (73°F)   |
| Printer / cartridge / imaging unit short-term shipping  | -40 to 40°C (-40 to 104°F)   |
| <p><sup>1</sup> Supplies shelf life is approximately 2 years. This is based on storage in a standard office environment at 22°C (72°F) and 45% humidity.</p> <p><sup>2</sup> Wet-bulb temperature is determined by the air temperature and the relative humidity.</p> |  |

## Laser notice

The printer is certified in the U.S. to conform to the requirements of DHHS 21 CFR, Chapter I, Subchapter J for Class I (1) laser products, and elsewhere is certified as a Class I laser product conforming to the requirements of IEC 60825-1: 2014.

Class I laser products are not considered to be hazardous. The laser system and printer are designed so there is never any human access to laser radiation above a Class I level during normal operation, user maintenance, or prescribed service conditions. The printer has a non-serviceable printhead assembly that contains a laser with the following specifications:

Class: IIIb (3b) AlGaAs

Nominal output power (milliwatts): 8

Wavelength (nanometers): 770–800

## Power consumption

### Product power consumption

The following table documents the power consumption characteristics of the product.

**Note:** Some modes may not apply to your product.

| Mode     | Description   | Power consumption (Watts)  |
|----------|---|--|
| Printing | The product is generating hard-copy output from electronic inputs.            | One-sided: 385 (MC3224); 395 (CX331, MC3326); 400 (CX431, MC3426, XC2326)<br>Two-sided: 260 (MC3224); 275 (CX331, CX431, MC3326, MC3426, XC2326) |
| Copy     | The product is generating hard-copy output from hard-copy original documents. | 385 (CX331, MC3224, MC3326); 395 (CX431, MC3426, XC2326)   |

| Mode       | Description   | Power consumption (Watts)  |
|------------|---|--|
| Scan       | The product is scanning hard-copy documents.  | 22 (MC3224adwe, MC3224i); 24 (CX331, MC3324); 21 (CX431, MC3426, XC2326) |
| Ready      | The product is waiting for a print job.   | 17 (CX331, MC3224, MC3326); 17.5 (CX431, MC3426, XC2326)                 |
| Sleep Mode | The product is in a high-level energy-saving mode.                                    | 1.1 (CX331, MC3224, MC3326); 1.3 (CX431, MC3426, XC2326)                 |
| Hibernate  | The product is in a low-level energy-saving mode.                                     | N/A  |
| Off        | The product is plugged into an electrical outlet, but the power switch is turned off. | 0.1  |

The power consumption levels listed in the previous table represent time-averaged measurements. Instantaneous power draws may be substantially higher than the average.

Values are subject to change. See [www.lexmark.com](http://www.lexmark.com) for current values.

### Sleep Mode

This product is designed with an energy-saving mode called *Sleep Mode*. The Sleep Mode saves energy by lowering power consumption during extended periods of inactivity. The Sleep Mode is automatically engaged after this product is not used for a specified period of time, called the *Sleep Mode Timeout*.

|   |    |
|---|----|
| Factory default Sleep Mode Timeout for this product (in minutes): | 15 |
|---|----|

By using the configuration menus, the Sleep Mode Timeout can be modified between 1 minute and 120 minutes. If the print speed is less than or equal to 30 pages per minute, then you can set the timeout only up to 60 minutes. Setting the Sleep Mode Timeout to a low value reduces energy consumption, but may increase the response time of the product. Setting the Sleep Mode Timeout to a high value maintains a fast response, but uses more energy.

### Hibernate Mode

This product is designed with an ultra-low power operating mode called *Hibernate mode*. When operating in Hibernate Mode, all other systems and devices are powered down safely.

The Hibernate mode can be entered in any of the following methods:

- Using the Hibernate Timeout
- Using the Schedule Power modes

|  |        |
|--|--------|
| Factory default Hibernate Timeout for this product in all countries or regions | 3 days |
|--|--------|

The amount of time the printer waits after a job is printed before it enters Hibernate mode can be modified between one hour and one month.

### Notes on EPEAT-registered imaging equipment products:

- Standby power level occurs in Hibernate or Off mode.
- The product shall automatically power down to a standby power level of  $\leq 1$  W. The auto standby function (Hibernate or Off) shall be enabled at product shipment.

## Off mode

If this product has an off mode which still consumes a small amount of power, then to completely stop product power consumption, disconnect the power supply cord from the electrical outlet.

## Total energy usage

It is sometimes helpful to estimate the total product energy usage. Since power consumption claims are provided in power units of Watts, the power consumption should be multiplied by the time the product spends in each mode in order to calculate energy usage. The total product energy usage is the sum of each mode's energy usage.

## Applicability of Regulation (EU) 2019/2015 and (EU) 2019/2020

Per Commission Regulation (EU) 2019/2015 and (EU) 2019/2020, the light source contained within this product or its component is intended to be used for Image Capture or Image Projection only, and is not intended for use in other applications.

## Regulatory notices for telecommunication terminal equipment

This section contains regulatory information pertaining to products that contain the analog facsimile card:

Lexmark Regulatory Type/Model Number:

LEX-M14-002

## Notice to users of the US telephone network: FCC requirements

This equipment complies with Part 68 of the FCC rules and the requirements adopted by the Administrative Council for Terminal Attachments (ACTA). On the back of this equipment is a label that contains, among other information, a product identifier in the format US:AAAEQ##TXXXX. If requested, this number must be provided to your telephone company.

This equipment uses the RJ-11C Universal Service Order Code (USOC) jack.

A plug and jack used to connect this equipment to the premises' wiring and telephone network must comply with the applicable FCC Part 68 rules and requirements adopted by the ACTA. Use a compliant telephone cord (RJ-11) that is 26 AWG or larger when connecting this product to the public switched telephone network. See your setup documentation for more information.

The Ringer Equivalence Number (REN) is used to determine the number of devices that may be connected to a telephone line. Excessive RENs on a telephone line may result in the devices not ringing in response to an incoming call. In most but not all areas, the sum of RENs should not exceed five (5.0). To be certain of the number of devices that may be connected to a line, as determined by the total RENs, contact your local telephone company. For products approved after July 23, 2001, the REN for this product is part of the product identifier that has the format US:AAAEQ##TXXXX. The digits represented by ## are the REN without a decimal point (for example, 03 is a REN of 0.3). For earlier products, the REN is shown separately on the label.

If this equipment causes harm to the telephone network, the telephone company will notify you in advance that temporary discontinuance of service may be required. If advance notice is not practical, the telephone company will notify the customer as soon as possible. You will also be advised of your right to file a complaint with the FCC.

The telephone company may make changes in its facilities, equipment, operations or procedures that could affect the operation of this equipment. If this happens, the telephone company will provide advance notice in order for you to make necessary modifications to maintain uninterrupted service.

If you experience trouble with this equipment, for repair or warranty information, contact Lexmark International, Inc. at [www.lexmark.com](http://www.lexmark.com) or your Lexmark representative. If the equipment is causing harm to the telephone network, the telephone company may request that you disconnect the equipment until the problem is resolved.

This equipment contains no user serviceable parts. For repair and warranty information, contact Lexmark International, Inc. See the previous paragraph for contact information.

Connection to party line service is subject to state tariffs. Contact the state public utility commission, public service commission, or corporation commission for information.

If your home has specially wired alarm equipment connected to the telephone line, ensure the installation of this equipment does not disable your alarm equipment. If you have questions about what will disable alarm equipment, consult your telephone company or a qualified installer.

The Telephone Consumer Protection Act of 1991 makes it unlawful for any person to use a computer or other electronic device, including fax machines, to send any message unless said message clearly contains in a margin at the top or bottom of each transmitted page or on the first page of the transmission, the date and time it is sent and an identification of the business or other entity, or other individual sending the message, and the telephone number of the sending machine or such business, other entity, or individual. (The telephone number provided may not be a 900 number or any other number for which charges exceed local or long-distance transmission charges.)

See your user documentation in order to program this information into your fax machine.

## **Notice to users of the Canadian telephone network**

This product meets the applicable Innovation, Science and Economic Development Canada technical specifications.

The Ringer Equivalence Number (REN) indicates the maximum number of devices allowed to be connected to a telephone interface. The termination of an interface may consist of any combination of devices subject only to the requirement that the sum of the RENs of all the devices not exceed five. The REN is located on the product label.

This equipment uses CA11A telephone jacks.

## **Avis réservé aux utilisateurs du réseau téléphonique du Canada**

Ce produit est conforme aux spécifications techniques d'Innovation, Sciences et Développement économique Canada.

Le numéro REN (ringer equivalence number : numéro d'équivalence de sonnerie) indique le nombre maximum d'appareils pouvant être connectés à l'interface téléphonique. En bout de ligne, le nombre d'appareils qui peuvent être connectés n'est pas directement limité, mais la somme des REN de ces appareils ne doit pas dépasser cinq. Le numéro REN est indiqué sur l'étiquette produit.

Cet équipement utilise des prises de téléphone CA11A.

## Notice to users of the New Zealand telephone network

The following are special conditions for the Facsimile User Instructions. The grant of a telepermit for any item of terminal equipment indicates only that Spark has accepted that the item complies with minimum conditions for connection to its network. It indicates no endorsement of the product by Spark, nor does it provide any sort of warranty. Above all, it provides no assurance that any item will work correctly in all respects with another item of telepermitted equipment of a different make or model, nor does it imply that any product is compatible with all of Spark's network services.

This equipment shall not be set up to make automatic calls to the Spark "111" Emergency Service.

This equipment may not provide for the effective hand-over of a call to another device connected to the same line.

This equipment should not be used under any circumstances that may constitute a nuisance to other Spark customers.

This equipment is not capable, under all operating conditions, of correct operation at the higher speeds for which it is designed. Spark will accept no responsibility should difficulties arise in such circumstances.

The decadic (or pulse) dialing on this device is unsuitable for use on the Spark network in New Zealand.

For correct operation, the total of all the Ringer Equivalence Numbers (RENs) of all parallel devices connected to the same telephone line may not exceed 5. The REN of this device is located on the label.

This device uses an RJ-11C modular connector. Contact your point of purchase if a BT adapter is required. The Lexmark part number is 80D1873.

Some parameters required for compliance with Spark's telepermit requirements are dependent on the equipment associated with this device. The associated equipment shall be set to operate within the following limits for compliance to Spark's specifications:

- There shall be no more than 10 call attempts to the same number within any 30 minute period for any single manual call initiation, and
- The equipment shall go on-hook for a period of not less than 30 seconds between the end of one attempt and the beginning of the next call attempt.
- The equipment shall be set to ensure that automatic calls to different numbers are spaced such that there is not less than 5 seconds between the end of one call attempt and the beginning of another.

## Japanese telecom notice

The installed optional modem is in compliance with Japanese Telecommunication Law and has been Certified by JATE, with the following Certification Number:

A18-0046001

|   |                             |
|---|-----------------------------|
|  | Lexmark International, Inc. |
|   | LEX-M14-002                 |
|   | A18-0046001                 |

## Using this product in Switzerland

This product requires a Swiss billing tone filter (Lexmark part number 80D1877) to be installed on any line which receives metering pulses in Switzerland.

## Utilisation de ce produit en Suisse

Cet appareil nécessite l'utilisation d'un filtre de tonalité de facturation suisse (n° de référence Lexmark : 80D1877) devant être installé sur toute ligne recevant des impulsions de comptage en Suisse.

## Verwendung dieses Produkts in der Schweiz

Für dieses Produkt muss ein schweizerischer Billing Tone Filter zur Zählzeichenübertragung (Lexmark Teilenummer 80D1877) für jede Leitung installiert werden, über die in der Schweiz Zeitsteuertakte übertragen werden.

## Uso del prodotto in Svizzera

Questo prodotto richiede un filtro toni Billing svizzero, (codice Lexmark 80D1877) da installare su tutte le linee che ricevono impulsi remoti in Svizzera.

## Regulatory notices for wireless products

This section contains regulatory information that applies only to wireless models.

If in doubt as to whether your model is a wireless model, go to <http://support.lexmark.com>.

## Modular component notice

Wireless models contain one of the following modular components:

Lexmark Regulatory Type/Model Number LEX-M07-001; FCC ID:IYLLEXM07001; IC:2376A-LEXM07001

Lexmark Regulatory Type/Model Number LEX-M08-001; FCC ID:IYLLEXM08001; IC:2376A-LEXM08001

To determine which modular components are installed in your particular product, refer to the labeling on your actual product.

## Exposure to radio frequency radiation

The radiated output power of this device is far below the radio frequency exposure limits of the FCC and other regulatory agencies. A minimum separation of 20 cm (8 inches) must be maintained between the antenna and any persons for this device to satisfy the RF exposure requirements of the FCC and other regulatory agencies.



## Innovation, Science and Economic Development Canada

This device complies with Innovation, Science and Economic Development Canada license-exempt RSS standards. Operation is subject to the following two conditions: (1) this device may not cause interference, and (2) this device must accept any interference, including interference that may cause undesired operation of the device.

## Innovation, Sciences et Développement économique Canada

Cet appareil est conforme aux normes RSS exemptes de licence d'Innovation, Sciences et Développement économique Canada. Son fonctionnement est soumis aux deux conditions suivantes : (1) cet appareil ne doit pas causer d'interférences et (2) il doit accepter toutes les interférences, y compris les celles qui peuvent entraîner un fonctionnement indésirable.

## Singapore IMDA statement

This product is approved for use in Singapore.

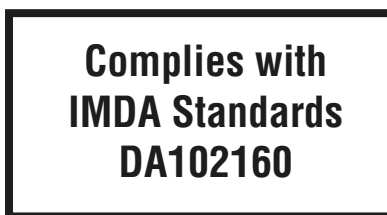

## European Community (EC) directives conformity

This product is in conformity with the protection requirements of EC Council directive 2014/53/EU on the approximation and harmonization of the laws of the Member States relating to radio equipment.

The manufacturer of this product is: Lexmark International, Inc., 740 West New Circle Road, Lexington, KY, 40550 USA. The EEA/EU authorized representative is: Lexmark International Technology Hungária Kft., 8 Lechner Ödön fasor, Millennium Tower III, 1095 Budapest HUNGARY. The EEA/EU Importer is: Lexmark International Technology S.à.r.l. 20, Route de Pré-Bois, ICC Building, Bloc A, CH-1215 Genève, Switzerland. A declaration of conformity to the requirements of the Directives is available upon request from the Authorized Representative or may be obtained at [www.lexmark.com/en\\_us/about/regulatory-compliance/european-union-declaration-of-conformity.html](http://www.lexmark.com/en_us/about/regulatory-compliance/european-union-declaration-of-conformity.html).

Compliance is indicated by the CE marking:



## Restrictions

This radio equipment is restricted to indoor use only. Outdoor use is prohibited. This restriction applies to all the countries listed in the table below:



|    |    |    |    |    |         |    |    |    |
|----|----|----|----|----|---------|----|----|----|
| AT | BE | BG | CH | CY | CZ      | DE | DK | EE |
| EL | ES | FI | FR | HR | HU      | IE | IS | IT |
| LI | LT | LU | LV | MT | NL      | NO | PL | PT |
| RO | SE | SI | SK | TR | UK (NI) |    |    |    |

**EU and other countries statement of radio transmitter operational frequency bands and maximum RF power**

This radio product transmits in either the 2.4GHz (2.412–2.472 GHz in the EU) or 5GHz (5.15–5.35, 5.47–5.725 in the EU) bands. The maximum transmitter EIRP power output, including antenna gain, is ≤ 20dBm for both bands.

**United Kingdom (UK) conformity**

This product is in conformity with the protection requirements of the Radio Equipment Regulations 2017.

The manufacturer of this product is: Lexmark International, Inc., 740 West New Circle Road, Lexington, KY, 40550 USA. The UK Importer is: Lexmark International Ltd, Highfield House, Foundation Park - 8 Roxborough Way, Maidenhead Berkshire - SL6 3UD, United Kingdom. A declaration of conformity is available upon request from the UK Importer or may be obtained at [www.lexmark.com/en\\_us/about/regulatory-compliance/uk-declaration-of-conformity.html](http://www.lexmark.com/en_us/about/regulatory-compliance/uk-declaration-of-conformity.html).

Compliance is indicated by the UKCA marking:



**Restrictions or requirements in the UK**

This radio equipment is restricted to indoor use only. Outdoor use is prohibited.

**UK statement of radio transmitter operational frequency bands and maximum RF power**

This radio product transmits in either the 2.4GHz (2.412–2.472 GHz in the UK) or 5GHz (5.15–5.35, 5.47–5.725 in the UK) bands. The maximum transmitter EIRP power output, including antenna gain, is ≤ 20dBm for both bands.

## **Federal Communications Commission (FCC) compliance information statement**

This product has been tested and found to comply with the limits for a Class B digital device, pursuant to Part 15 of the FCC Rules. Operation is subject to the following two conditions: (1) this device may not cause harmful interference, and (2) this device must accept any interference received, including interference that may cause undesired operation.

The FCC Class B limits are designed to provide reasonable protection against harmful interference when the equipment is operated in a residential installation. This equipment generates, uses, and can radiate radio frequency energy and, if not installed and used in accordance with the instructions, may cause harmful interference to radio communications. However, there is no guarantee that interference will not occur in a particular installation. If this equipment does cause harmful interference to radio or television reception, which can be determined by turning the equipment off and on, the user is encouraged to try to correct the interference by one or more of the following measures:

- Reorient or relocate the receiving antenna.
- Increase the separation between the equipment and receiver.
- Connect the equipment into an outlet on a circuit different from that to which the receiver is connected.
- Consult your point of purchase or service representative for additional suggestions.

The manufacturer is not responsible for radio or television interference caused by using other than recommended cables or by unauthorized changes or modifications to this equipment. Unauthorized changes or modifications could void the user's authority to operate this equipment.

**Note:** To assure compliance with FCC regulations on electromagnetic interference for a Class B computing device, use a properly shielded and grounded cable such as Lexmark part number 1021231 for parallel attach or 1021294 for USB attach. Use of a substitute cable not properly shielded and grounded may result in a violation of FCC regulations.

Any questions regarding this compliance information statement should be directed to:

Director of Lexmark Technology & Services  
Lexmark International, Inc.  
740 West New Circle Road  
Lexington, KY 40550  
Telephone: (859) 232-2000  
E-mail: [regulatory@lexmark.com](mailto:regulatory@lexmark.com)

## **Innovation, Science and Economic Development Canada compliance statement**

This Class B digital apparatus meets all requirements of the Canadian Interference-Causing Equipment Standard ICES-003.

## **Avis de conformité aux normes de l'Innovation, Sciences et Développement économique Canada**

Cet appareil numérique de classe B est conforme aux exigences de la norme canadienne relative aux équipements pouvant causer des interférences NMB-003.

## 日本の VCCI 規定

製品にこのマークが表示されている場合、次の要件を満たしています。



この装置は、クラス B 情報技術装置です。この装置は、家庭環境で使用することを目的としていますが、この装置がラジオやテレビジョン受信機に近接して使用されると、受信障害を引き起こすことがあります。

取扱説明書に従って正しい取り扱いをしてください。

VCCI-B

## European Community (EC) directives conformity

This product is in conformity with the protection requirements of EC Council directives 2014/30/EU, 2014/35/EU, 2009/125/EC, and 2011/65/EU as amended by (EU) 2015/863 on the approximation and harmonization of the laws of the Member States relating to electromagnetic compatibility, safety of electrical equipment designed for use within certain voltage limits, the ecodesign of energy-related products, and on the restrictions of use of certain hazardous substances in electrical and electronic equipment.

The manufacturer of this product is: Lexmark International, Inc., 740 West New Circle Road, Lexington, KY, 40550 USA. The EEA/EU authorized representative is: Lexmark International Technology Hungária Kft., 8 Lechner Ödön fasor, Millennium Tower III, 1095 Budapest HUNGARY. The EEA/EU Importer is: Lexmark International Technology S.à.r.l. 20, Route de Pré-Bois, ICC Building, Bloc A, CH-1215 Genève, Switzerland. A declaration of conformity to the requirements of the Directives is available upon request from the Authorized Representative or may be obtained at

[www.lexmark.com/en\\_us/about/regulatory-compliance/european-union-declaration-of-conformity.html](http://www.lexmark.com/en_us/about/regulatory-compliance/european-union-declaration-of-conformity.html).

This product satisfies the Class B limits of EN 55032 and safety requirements of EN 62368-1.

## United Kingdom (UK) conformity

This product is in conformity with the protection requirements of the Electromagnetic Compatibility Regulations 2016, the Electrical Equipment (Safety) Regulations 2016, the Ecodesign for Energy-Related Products and Energy Information (Amendment) (EU Exit) Regulations 2019, and the Restriction of the Use of Certain Hazardous Substances in Electrical and Electronic Equipment Regulations 2012.

The manufacturer of this product is: Lexmark International, Inc., 740 West New Circle Road, Lexington, KY, 40550 USA. The UK Importer is: Lexmark International Ltd, Highfield House, Foundation Park - 8 Roxborough Way, Maidenhead Berkshire - SL6 3UD, United Kingdom. A declaration of conformity is available upon request from the UK Importer or may be obtained at

[www.lexmark.com/en\\_us/about/regulatory-compliance/uk-declaration-of-conformity.html](http://www.lexmark.com/en_us/about/regulatory-compliance/uk-declaration-of-conformity.html).

This product satisfies the Class B limits of BS EN 55032 and safety requirements of BS EN 62368-1.

## **STATEMENT OF LIMITED WARRANTY FOR LEXMARK LASER PRINTERS, LEXMARK LED PRINTERS, AND LEXMARK MULTIFUNCTION LASER PRINTERS**

### **Lexmark International, Inc., Lexington, KY**

This limited warranty applies to the United States and Canada. For customers outside the U.S., refer to the country-specific warranty information that came with your product.

This limited warranty applies to this product only if it was originally purchased for your use, and not for resale, from Lexmark or a Lexmark Remarketer, referred to in this statement as “Remarketer.”

### **Limited warranty**

Lexmark warrants that this product:

- Is manufactured from new parts, or new and serviceable used parts, which perform like new parts
- Is, during normal use, free from defects in material and workmanship

If this product does not function as warranted during the warranty period, contact a Remarketer or Lexmark for repair or replacement (at Lexmark's option).

If this product is a feature or option, this statement applies only when that feature or option is used with the product for which it was intended. To obtain warranty service, you may be required to present the feature or option with the product.

If you transfer this product to another user, warranty service under the terms of this statement is available to that user for the remainder of the warranty period. You should transfer proof of original purchase and this statement to that user.

### **Limited warranty service**

The warranty period starts on the date of original purchase as shown on the purchase receipt and ends 12 months later provided that the warranty period for any supplies and for any maintenance items included with the printer shall end earlier if it, or its original contents, are substantially used up, depleted, or consumed. Fuser Units, Transfer/Transport Units, Paper Feed items, if any, and any other items for which a Maintenance Kit is available are substantially consumed when the printer displays a “Life Warning” or “Scheduled Maintenance” message for such item.

To obtain warranty service you may be required to present proof of original purchase. You may be required to deliver your product to the Remarketer or Lexmark, or ship it prepaid and suitably packaged to a Lexmark designated location. You are responsible for loss of, or damage to, a product in transit to the Remarketer or the Lexmark designated location.

When warranty service involves the exchange of a product or part, the item replaced becomes the property of the Remarketer or Lexmark. The replacement may be a new or repaired item.

The replacement item assumes the remaining warranty period of the original product.

Replacement is not available to you if the product you present for exchange is defaced, altered, in need of a repair not included in warranty service, damaged beyond repair, or if the product is not free of all legal obligations, restrictions, liens, and encumbrances.

As part of your warranty service and/or replacement, Lexmark may update the firmware in your printer to the latest version. Firmware updates may modify printer settings and cause counterfeit and/or unauthorized products, supplies, parts, materials (such as toners and inks), software, or interfaces to stop working. Authorized use of genuine Lexmark products will not be impacted.

Before you present this product for warranty service, remove all print cartridges, programs, data, and removable storage media (unless directed otherwise by Lexmark).

For further explanation of your warranty alternatives and the nearest Lexmark authorized servicer in your area contact Lexmark on the World Wide Web.

Remote technical support is provided for this product throughout its warranty period. For products no longer covered by a Lexmark warranty, technical support may not be available or only be available for a fee.

### **Extent of limited warranty**

Lexmark does not warrant uninterrupted or error-free operation of any product or the durability or longevity of prints produced by any product.

Warranty service does not include repair of failures caused by:

- Modification or unauthorized attachments
- Accidents, misuse, abuse or use inconsistent with Lexmark user's guides, manuals, instructions or guidance
- Unsuitable physical or operating environment
- Maintenance by anyone other than Lexmark or a Lexmark authorized servicer
- Operation of a product beyond the limit of its duty cycle
- Use of printing media outside of Lexmark specifications
- Refurbishment, repair, refilling or remanufacture by a third party of products, supplies or parts
- Products, supplies, parts, materials (such as toners and inks), software, or interfaces not furnished by Lexmark

**TO THE EXTENT PERMITTED BY APPLICABLE LAW, NEITHER LEXMARK NOR ITS THIRD PARTY SUPPLIERS OR REMARKETERS MAKE ANY OTHER WARRANTY OR CONDITION OF ANY KIND, WHETHER EXPRESS OR IMPLIED, WITH RESPECT TO THIS PRODUCT, AND SPECIFICALLY DISCLAIM THE IMPLIED WARRANTIES OR CONDITIONS OF MERCHANTABILITY, FITNESS FOR A PARTICULAR PURPOSE, AND SATISFACTORY QUALITY. ANY WARRANTIES THAT MAY NOT BE DISCLAIMED UNDER APPLICABLE LAW ARE LIMITED IN DURATION TO THE WARRANTY PERIOD. NO WARRANTIES, EXPRESS OR IMPLIED, WILL APPLY AFTER THIS PERIOD. ALL INFORMATION, SPECIFICATIONS, PRICES, AND SERVICES ARE SUBJECT TO CHANGE AT ANY TIME WITHOUT NOTICE.**

### **Limitation of liability**

Your sole remedy under this limited warranty is set forth in this document. For any claim concerning performance or nonperformance of Lexmark or a Remarketer for this product under this limited warranty, you may recover actual damages up to the limit set forth in the following paragraph.

Lexmark's liability for actual damages from any cause whatsoever will be limited to the amount you paid for the product that caused the damages. This limitation of liability will not apply to claims by you for bodily injury or damage to real property or tangible personal property for which Lexmark is legally liable. **IN NO EVENT WILL LEXMARK BE LIABLE FOR ANY LOST PROFITS, LOST SAVINGS, INCIDENTAL DAMAGE, OR OTHER ECONOMIC OR CONSEQUENTIAL DAMAGES.** This is true even if you advise Lexmark or a Remarketer of the possibility of such damages. Lexmark is not liable for any claim by you based on a third party claim.

---

This limitation of remedies also applies to claims against any Suppliers and Remarketers of Lexmark. Lexmark's and its Suppliers' and Remarketers' limitations of remedies are not cumulative. Such Suppliers and Remarketers are intended beneficiaries of this limitation.

**Additional rights**

Some states do not allow limitations on how long an implied warranty lasts, or do not allow the exclusion or limitation of incidental or consequential damages, so the limitations or exclusions contained above may not apply to you.

This limited warranty gives you specific legal rights. You may also have other rights that vary from state to state.

# Index

## A

- adapter plug 29
- adding a shortcut
  - copy 63
- adding hardware options
  - print driver 47
- adding internal options
  - print driver 47
- adding printers to a computer 45
- adding shortcut
  - e-mail 65
  - fax destination 67
- ADF
  - using 61, 64, 66, 70
- ADF registration
  - adjusting 225
- ADF separator pad
  - replacing 155
- ADF tray
  - replacing 148
- adjusting ADF registration 225
- adjusting fax darkness 68
- adjusting scanner registration 224
- adjusting the brightness
  - printer display 164
- adjusting the brightness of the printer display 164
- adjusting toner darkness 60
- AirPrint
  - using 54
- analog fax
  - setting up 25
- answering machine
  - setting up 27
- assigning printer to a ring pattern 31
- attaching cables 21
- automatic document feeder (ADF)
  - using 61, 64, 66, 70
- avoiding paper jams 198

## B

- black images 179
- blank or white pages 167
- blocking junk faxes 68

- bookmarks
  - creating 23
  - creating folders for 24

## C

- canceling a print job
  - from the computer 59
  - from the printer control panel 59
- cannot connect printer to Wi-Fi 196
- cannot open Embedded Web Server 195
- cannot receive faxes using analog fax 217
- cannot scan to a network folder 219
- cannot send e-mails 213
- cannot send or receive faxes using analog fax 214
- cannot send or receive faxes using etherFAX 216
- cannot send the fax cover page from the computer 218
- cards
  - copying 63
- changing resolution
  - fax 67
- checking the status of parts and supplies 139
- cleaning
  - pick tires 159
- cleaning the pick tires 159
- cleaning the printer 157
- Cleaning the Scanner 138
- cleaning the scanner 158
- cleaning the touch screen 157
- clearances around the printer 20
- clearing jam
  - in door B 206
  - in the duplex unit 206
  - in the fuser area 206
  - in the manual feeder 206
  - in the optional tray 202
  - in the standard tray 200
- clearing jams
  - in the standard bin 204
- Cloud Connector profile
  - creating 23
  - printing from 59
  - scanning to 73
- collated printing does not work 210
- collating copies 62
- color correction 225
- color quality, troubleshooting
  - print appears tinted 227
- colored background on prints 171
- computer
  - connecting to the printer 52
- computer, scanning to 70
- confidential documents do not print 192
- confidential print jobs
  - configuring 57
  - printing 58
- configuring daylight saving time 32
- configuring fax speaker settings 32
- configuring supply notifications 139
- configuring the e-mail server settings 32
- configuring Wi-Fi Direct 51
- connecting a computer to the printer 52
- connecting mobile device to printer 51
- connecting printer to distinctive ring service 31
- connecting the printer
  - to a wireless network 49
- connecting to a wireless network
  - using PIN method 50
  - using Push Button method 50
- conserving supplies 164
- contacting customer support 227
- control panel
  - using 13
- copy troubleshooting
  - partial copies of documents or photos 220
  - poor copy quality 222



- scanner does not respond 224
- copying
  - cards 63
  - on both sides of the paper 62
  - on letterhead 62
  - photos 61
  - using the automatic document feeder (ADF) 61
  - using the scanner glass 61
- copying different paper sizes 61
- copying from
  - selected tray 61
- copying multiple pages
  - onto a single sheet 62
- creating a Cloud Connector profile 23
- creating a shortcut
  - copy 63
- creating bookmarks 23
- creating folders
  - for bookmarks 24
- creating shortcut
  - e-mail 65
  - fax destination 67
- customer support
  - contacting 227

## D

- date and time
  - fax settings 32
- daylight saving time
  - configuring 32
- deactivating the Wi-Fi network 52
- different paper sizes, copying 61
- disabling SMTP server not set up error 212
- distinctive ring service, fax
  - enabling 31
- documents, printing
  - from a computer 54
  - from a mobile device 54
- dots on print 176

## E

- emission notices 231, 240, 244
- enabling the USB port 195
- enabling Wi-Fi Direct 51
- enlarging copies 62
- envelopes
  - loading 43

- environmental settings 164
- erasing printer memory 53
- etherFAX, using
  - setting up fax function 26
- Ethernet port 21
- exporting a configuration file
  - using the Embedded Web Server 46
- EXT port 21
- e-mail
  - sending 64
- e-mail alerts
  - setting up 139
- e-mail function
  - setting up 32
- e-mail server
  - configuring 32
- e-mail service providers 32
- e-mail shortcut
  - creating 65
- e-mail troubleshooting
  - cannot send e-mails 213
- e-mailing
  - using the automatic document feeder (ADF) 64
  - using the scanner glass 64

## F

- factory default settings
  - restoring 53
- FAQ about color printing 226
- fax
  - forwarding 68
  - scheduling send time and date 67
  - sending 66
  - supported 24
- fax darkness
  - adjusting 68
- fax destination shortcut
  - creating 67
- fax driver
  - installing 45
- fax log
  - viewing 68
- fax resolution
  - changing 67
- fax server, using
  - setting up the fax function 27
- fax setup
  - country- or region-specific 29

- standard telephone line
  - connection 27
- fax speaker settings
  - configuring 32
- fax troubleshooting
  - caller ID is not shown 213
  - can send but not receive faxes
    - using analog fax 217
  - cannot send faxes using analog fax 216
  - cannot send or receive faxes
    - using analog fax 214
  - cannot send or receive faxes
    - using etherFAX 216
  - cannot send the fax cover page
    - from the computer 218
  - cannot set up etherFAX 214
  - missing information on the fax cover page 218
  - poor print quality 217
- faxes
  - holding 68
- faxing
  - setting the date and time 32
  - using the automatic document feeder (ADF) 66
  - using the scanner glass 66
- FCC notices 240
- file types
  - supported 56
- finding printer information 9
- finding the printer serial number 10
- firmware, updating 46
- flash drive
  - printing from 55
  - scanning to 72
- flash drives
  - supported 56
- font sample list
  - printing 59
- forwarding fax 68
- FTP server
  - scanning to 71

## G

- genuine Lexmark parts and supplies 140
- genuine parts and supplies 140
- ghost images on prints 170
- gray background on prints 171

**H**

- hardware options
  - trays 22
- hardware options, adding
  - print driver 47
- held documents do not print 192
- held jobs 57
  - printing 58
- Hibernate mode
  - configuring 164
- holding faxes 68
- home screen
  - customizing 13
- home screen icons
  - displaying 13
- horizontal dark lines 183
- horizontal white lines 185
- humidity around the printer 235

**I**

- icons on the home screen
  - showing 13
- identifying jam locations 199
- images cut off on print 180
- importing a configuration file
  - using the Embedded Web Server 46
- incorrect margins 172
- indicator light
  - understanding the status 14
- installing the fax driver 45
- installing the print driver 44
- installing the printer software 44
- installing the wireless print server 48
- installing trays 22
- internal options, adding
  - print driver 47

**J**

- jagged image
  - scanning from the ADF 223
- jagged text
  - scanning from the ADF 223
- jams
  - avoiding 198
- jams, clearing
  - in the automatic document feeder 209
- junk faxes
  - blocking 68

**K**

- keyboard on the display
  - changing the language 13

**L**

- language, changing the
  - keyboard on the display 13
- letterhead
  - copying on 62
  - loading 43
  - selecting 15
- Lexmark Mobile Print
  - using 54
- Lexmark ScanBack Utility
  - using 70
- light print 173
- LINE port 21
- linking trays 44
- loading trays 41
- locating jam areas 199

**M**

- making copies 61
- manual color correction 225
- manual feeder
  - loading 43
  - replacing 147
- memory
  - types installed on printer 53
- menu
  - 802.1x 129
  - About this Printer 86
  - Anonymous Data Collection 81
  - Certificate Management 133
  - Cloud Connector 136
  - Confidential Print Setup 134
  - Config Menu 82
  - Copy Defaults 95
  - Custom Scan Sizes 94
  - Device 136
  - Eco-Mode 76
  - Erase Temporary Data Files 135
  - Ethernet 123
  - E-mail Defaults 109
  - E-mail Setup 108
  - Fax 137
  - Fax Mode 97
  - Fax Server Setup 105
  - Fax Setup 98
  - Flash Drive Print 118
  - Flash Drive Scan 115

- FTP Defaults 112
- HTTP/FTP Settings 130
- Image 92
- IPSec 127
- Layout 87
- Local Accounts 133
- Login Restrictions 134
- LPD Configuration 129
- Media Types 95
- Menu Settings Page 136
- Miscellaneous 135
- Network 137
- Network Overview 119
- Notifications 77
- Out of Service Erase 86
- PCL 91
- PostScript 90
- Power Management 80
- Preferences 75
- Print 137
- Public 132
- Quality 89
- Remote Operator Panel 77
- Restore Factory Defaults 81
- Restrict external network
  - access 131
- Schedule USB Devices 134
- Setup 88
- Shortcuts 137
- SNMP 126
- TCP/IP 125
- Tray Configuration 93
- Troubleshooting 138
- Universal Setup 93
- USB 130
- Visible Home Screen Icons 86
- Wireless 120
- Wi-Fi Direct 123
- Menu Settings Page
  - printing 52
- missing colors 175
- missing information on the fax cover page 218
- mobile device
  - connecting to printer 51
  - printing from 54, 55
- modifying color output 225
- Mopria Print Service 54
- mottled print 176
- moving the printer 164

**N**

- network folder
  - scanning to 72
- network setup page
  - printing 52
- noise emission levels 231
- Non-Lexmark supply 197
- non-volatile memory 53
  - erasing 53
- notices 231, 233, 235, 236, 237, 240, 244

**O**

- ordering supplies
  - print cartridge 140
  - waste toner bottle 143

**P**

- paper
  - letterhead 15
  - preprinted forms 15
  - selecting 14
  - unacceptable 15
  - Universal size setting 40
- paper characteristics 14
- paper guidelines 14
- paper jam
  - in the optional tray 202
  - in the standard tray 200
- paper jam in door B 206
- paper jam in the automatic document feeder 209
- paper jam in the manual feeder 206
- paper jam in the standard bin 204
- paper jam, clearing
  - in the automatic document feeder 209
  - in the standard bin 204
- paper jams
  - avoiding 198
  - location 199
- paper sizes
  - supported 16
- paper types
  - supported 18
- paper weights
  - supported 19
- parts status
  - checking 139
- personal identification number method 50
- photos
  - copying 61
- pick tires
  - cleaning 159
  - replacing 150
- placing separator sheets 59
- poor fax print quality 217
- power cord socket 21
- power save modes
  - configuring 164
- preprinted forms
  - selecting 15
- print appears tinted 227
- print cartridge
  - ordering 140
  - replacing 143
- print driver
  - hardware options, adding 47
  - installing 44
- print job
  - canceling from the computer 59
  - canceling from the printer control panel 59
- print jobs
  - storing 57
- print jobs not printed 189
- Print Quality Test Pages 138
- print quality troubleshooting
  - blank pages 167
  - crooked print 178
  - dark print 168
  - ghost images on prints 170
  - gray or colored background 171
  - horizontal dark lines 183
  - horizontal white lines 185
  - light print 173
  - missing colors 175
  - mottled print and dots 176
  - paper curl 177
  - repeating defects 188
  - skewed print 178
  - solid color or black images 179
  - text or images cut off 180
  - toner easily rubs off 181
  - uneven print density 182
  - vertical dark lines 184
  - vertical white lines 187
  - white pages 167

- print troubleshooting
  - collated printing does not work 210
  - confidential and other held documents do not print 192
  - envelope seals when printing 210
  - incorrect margins 172
  - jammed pages are not reprinted 212
  - job prints from the wrong tray 192
  - job prints on the wrong paper 192
  - paper frequently jams 211
  - print jobs do not print 189
  - slow printing 190
  - tray linking does not work 211
  - unable to read flash drive 194
- printer
  - shipping 165
- printer configurations 11
- printer display
  - adjusting the brightness 164
- printer information
  - finding 9
- printer is not responding 193
- printer location
  - selecting 20
- printer memory
  - erasing 53
- printer menus 74
- printer messages
  - Non-Lexmark supply 197
  - Replace cartridge, printer region mismatch 197
- printer parts
  - cleaning 157
- printer ports 21
- printer settings
  - restoring factory default 53
- printer software
  - installing 44
- printer status 14
- printing
  - confidential print jobs 58
  - font sample list 59
  - from a Cloud Connector profile 59
  - from a computer 54
  - from a flash drive 55
  - from a mobile device 54, 55

- held jobs 58
- Menu Settings Page 52
- network setup page 52
- using Mopria Print Service 54
- using Wi-Fi Direct 55
- printing a font sample list 59
- printing a network setup page 52
- printing from a computer 54
- printing from a flash drive 55
- Push Button method 50

## R

- recycling
  - Lexmark packaging 229
  - Lexmark products 229
- reducing copies 62
- removing paper jam
  - in the duplex unit 206
  - in the fuser area 206
  - in the manual feeder 206
  - in the optional tray 202
  - in the standard tray 200
- repeat print jobs 57
- repeating defects on print 188
- Replace cartridge, printer region mismatch 197
- replacing parts
  - ADF separator pad 155
  - ADF tray 148
  - manual feeder 147
  - pick tires 150
  - tray 146
- replacing supplies
  - print cartridge 143
  - waste toner bottle 146
- reports
  - printer status 139
  - printer usage 139
- resetting
  - supply usage counters 197
- resetting supply usage counters 157
- restoring factory default settings 53
- RJ-11 adapter 29

## S

- safety information 7, 8
- saving paper 62
- saving toner 62

- scan troubleshooting
  - cannot scan to a computer 218
  - cannot scan to network folder 219
  - jagged image when scanning from the ADF 223
  - jagged text when scanning from the ADF 223
  - partial copies of documents or photos 220
  - poor copy quality 222
  - scan job was not successful 221
  - scanner does not respond 224
  - scanning freezes the computer 223
  - scanning takes too long 223
  - vertical dark streaks on output when scanning from the ADF 222
- scanner
  - cleaning 158
- scanner does not close 223
- scanner glass
  - using 61, 64, 66, 70
- scanner registration
  - adjusting 224
- scanning
  - to a Cloud Connector profile 73
  - to a computer 70
  - to a network folder 72
  - to an FTP server 71
  - to flash drive 72
  - using the automatic document feeder (ADF) 70
  - using the scanner glass 70
- scanning from ADF
  - jagged image 223
  - jagged text 223
- scanning quality problem 222
- scheduling a fax 67
- selecting a location for the printer 20
- sending e-mail 64
- sending fax 66
- separator sheets
  - placing 59
- serial number, printer
  - finding 10
- setting the paper size 40
- setting the paper type 40

- setting the Universal paper size 40
- setting up
  - analog fax 25
- setting up e-mail alerts 139
- setting up fax
  - country- or region-specific 29
  - standard telephone line connection 27
- setting up fax function using etherFAX 26
- setting up the fax function using fax server 27
- shipping the printer 165
- shortcut, creating
  - e-mail 65
  - fax destination 67
- shortcut, creating a copy 63
- Sleep mode
  - configuring 164
- slow printing 190
- SMTP server not set up error
  - disabling 212
- SMTP settings
  - configuring 32
- solid color 179
- sorting multiple copies 62
- statement of volatility 53
- storing paper 16
- supplies
  - conserving 164
- supplies status
  - checking 139
- supply notifications
  - configuring 139
- supply usage counters
  - resetting 157, 197
- supported fax 24
- supported file types 56
- supported flash drives 56
- supported paper sizes 16
- supported paper types 18
- supported paper weights 19

## T

- temperature around the printer 20, 235
- text cut off on print 180
- toner darkness
  - adjusting 60

- touch screen
    - cleaning 157
  - trays
    - installing 22
    - linking 44
    - loading 41
    - replacing 146
    - unlinking 44
  - troubleshooting
    - cannot connect printer to
      - Wi-Fi 196
    - cannot open Embedded Web Server 195
    - FAQ about color printing 226
    - printer is not responding 193
    - SMTP server not set up error 212
  - troubleshooting, color quality
    - print appears tinted 227
  - troubleshooting, copy
    - partial copies of documents or photos 220
    - poor copy quality 222
    - scanner does not close 223
    - scanner does not respond 224
  - troubleshooting, e-mail
    - cannot send e-mails 213
  - troubleshooting, fax
    - caller ID is not shown 213
    - can send but not receive faxes
      - using analog fax 217
    - cannot send faxes using analog fax 216
    - cannot send or receive faxes
      - using analog fax 214
    - cannot send or receive faxes
      - using etherFAX 216
    - cannot send the fax cover page from the computer 218
    - cannot set up etherFAX 214
    - missing information on the fax cover page 218
    - poor print quality 217
  - troubleshooting, print
    - collated printing does not work 210
    - confidential and other held documents do not print 192
    - envelope seals when printing 210
    - incorrect margins 172
    - jammed pages are not reprinted 212
    - job prints from the wrong tray 192
    - job prints on the wrong paper 192
    - paper frequently jams 211
    - print jobs do not print 189
    - slow printing 190
    - tray linking does not work 211
  - troubleshooting, print quality
    - blank pages 167
    - crooked print 178
    - dark print 168
    - ghost images on prints 170
    - gray or colored background 171
    - horizontal dark lines 183
    - horizontal white lines 185
    - light print 173
    - missing colors 175
    - mottled print and dots 176
    - paper curl 177
    - repeating defects 188
    - skewed print 178
    - solid color or black images 179
    - text or images cut off 180
    - toner easily rubs off 181
    - uneven print density 182
    - vertical dark lines 184
    - vertical white lines 187
    - white pages 167
  - troubleshooting, scan
    - cannot scan to a computer 218
    - cannot scan to a network folder 219
    - jagged image when scanning from the ADF 223
    - jagged text when scanning from the ADF 223
    - partial copies of documents or photos 220
    - poor copy quality 222
    - scan job was not successful 221
    - scanner does not close 223
    - scanner does not respond 224
    - vertical dark streaks on output when scanning from the ADF 222
  - two-sided copying 62
- ## U
- unable to read flash drive
    - troubleshooting, print 194
  - uneven print density 182
  - Universal paper size
    - setting 40
  - unlinking trays 44
  - updating firmware 46
  - USB port
    - enabling 195
  - USB printer port 21
  - using genuine Lexmark parts and supplies 140
  - using the ADF
    - copying 61
  - using the control panel 13
  - using the scanner glass
    - copying 61
- ## V
- verify print jobs 57
  - vertical dark lines 184
  - vertical dark streaks on output when scanning from the ADF 222
  - vertical white lines 187
  - viewing a fax log 68
  - viewing reports 139
  - volatile memory 53
    - erasing 53
  - volatility
    - statement of 53
- ## W
- waste toner bottle
    - ordering 143
    - replacing 146
  - wireless network
    - connecting the printer to 49
    - Wi-Fi Protected Setup 50
  - wireless networking 49
  - wireless option 47
  - wireless print server
    - installing 48
  - Wi-Fi Direct
    - configuring 51
    - enabling 51
    - printing from a mobile device 55
  - Wi-Fi network
    - deactivating 52

Wi-Fi Protected Setup  
wireless network 50