



# User Guide

*OpenFlex™ F3100 and E3000*

*1ET2050*

*Version 1.0*

*October 2019*

**Western Digital.**

# Table of Contents

---

Copyright.....	iv
Points of Contact.....	v
<b>Chapter 1. Overview.....</b>	<b>1</b>
OpenFlex™ F3100 and E3000.....	2
Servicing Features.....	3
Composable Infrastructures.....	3
NVMe-oF.....	4
Supported SKUs.....	4
List of Compatible Devices.....	4
System Architecture Overview.....	5
System High Speed Data Ingest Architecture.....	5
System Thermal and Cooling.....	5
OpenFlex F3100 and E3000 Specification Summary.....	7
Physical Design.....	10
LEDs.....	12
Cables.....	16
Restrictions and Limitations.....	16
Site Requirements.....	17
Power Requirements.....	17
Rack Requirements.....	17
Thermal and Cooling Requirements.....	18
Servicing Requirements.....	18
<b>Chapter 2. Components.....</b>	<b>20</b>
Chassis.....	21
Chassis Specifications.....	21
PSU.....	22
PSU Specifications.....	22
Fan Module.....	23
Fan Module Specifications.....	23
BMC Module.....	24
BMC Module Specifications.....	24
Rails.....	25
Rails Specifications.....	25

OpenFlexF3100.....	26
OpenFlexF3100 Specifications.....	26
OpenFlex E3000 Fabric Device Blank.....	27
OpenFlex E3000 Fabric Device Blank Specifications.....	27
List of Field/Customer Replaceable Units.....	28
<b>Chapter 3. Management.....</b>	<b>29</b>
OCGUI.....	30
Login Page.....	30
Dashboard.....	30
Storage Device Page.....	35
Chassis Device Page.....	42
Basic Operational Functions.....	49
Power Cycling.....	74
Firmware Upgrade.....	75
Part Replacement.....	81
Fan Module Replacement.....	82
PSU Replacement.....	84
BMC Module Replacement.....	88
OpenFlexF3100 Replacement.....	91
Rails Replacement.....	95
Chassis Replacement.....	113
<b>Chapter 4. Safety.....</b>	<b>135</b>
Electrostatic Discharge.....	136
Optimizing Location.....	136
Power Connections.....	136
Power Cords.....	136
Rackmountable Systems.....	137
Restricted Access Location.....	137
Safety and Service.....	137
Safety Warnings and Cautions.....	138
<b>Chapter 5. Regulatory.....</b>	<b>139</b>
Europe (CE Declaration of Conformity).....	140
FCC Class A Notice.....	140
ICES-003 Class A Notice—Avis NMB-003, Classe A.....	140
Japanese Compliance Statement, Class A ITE.....	140

KCC Notice (Republic of Korea Only), Class A ITE..... 140  
Taiwan Warning Label Statement, Class A ITE.....141

## Copyright

---

**The following paragraph does not apply to the United Kingdom or any country where such provisions are inconsistent with local law: Western Digital a Western Digital company PROVIDES THIS PUBLICATION "AS IS" WITHOUT WARRANTY OF ANY KIND, EITHER EXPRESS OR IMPLIED, INCLUDING, BUT NOT LIMITED TO, THE IMPLIED WARRANTIES OF MERCHANTABILITY OR FITNESS FOR A PARTICULAR PURPOSE. Some states do not allow disclaimer or express or implied warranties in certain transactions, therefore, this statement may not apply to you.**

This publication could include technical inaccuracies or typographical errors. Changes are periodically made to the information herein; these changes will be incorporated in new editions of the publication. Western Digital may make improvements or changes in any products or programs described in this publication at any time.

It is possible that this publication may contain reference to, or information about, Western Digital products (machines and programs), programming, or services that are not announced in your country. Such references or information must not be construed to mean that Western Digital intends to announce such Western Digital products, programming, or services in your country.

Technical information about this product is available by contacting your local Western Digital representative or on the Internet at: [support@wdc.com](mailto:support@wdc.com)

Western Digital may have patents or pending patent applications covering subject matter in this document. The furnishing of this document does not give you any license to these patents.

Long Live Data™ is a trademark of Western Digital, Inc. and its affiliates in the United States and/or other countries.

Western Digital trademarks are authorized for use in countries and jurisdictions in which Western Digital has the right to use, market and advertise the brands. Other product names are trademarks or registered trademarks of their respective owners.

One MB is equal to one million bytes, one GB is equal to one billion bytes, one TB equals 1,000GB (one trillion bytes) and one PB equals 1,000TB when referring to storage capacity. Usable capacity will vary from the raw capacity due to object storage methodologies and other factors.

References in this publication to Western Digital products, programs or services do not imply that Western Digital intends to make these available in all countries in which Western Digital operates.

Product information is provided for information purposes only and does not constitute a warranty.

Information is true as of the date of publication and is subject to change. Actual results may vary. This publication is for general guidance only. Photographs may show design models.

Western Digital  
5601 Great Oaks Parkway  
San Jose, CA 95119

© 2019 Western Digital Corporation or its affiliates.

## Points of Contact

---

For further assistance with a Western Digital product, contact Platform Engineering technical support. Please be prepared to provide the following information: part number (P/N), serial number (S/N), product name and/or model number, and a brief description of the issue.

**Email:**

[support@wdc.com](mailto:support@wdc.com)

**Website:**

<https://portal.wdc.com/Support/s/>

# Overview

## In This Chapter:

- OpenFlex™ F3100 and E3000..... 2
- System Architecture Overview..... 5
- OpenFlex F3100 and E3000 Specification  
Summary..... 7
- Physical Design..... 10
- Restrictions and Limitations..... 16
- Site Requirements..... 17



## 1.1 OpenFlex™ F3100 and E3000

The OpenFlex™ F3100 and E3000 is a 3U rack mounted data storage enclosure built on the OpenFlex platform. OpenFlex is Western Digital's architecture that supports Open Composable Infrastructure (OCI). The OpenFlex F3100 and E3000 are fabric devices that leverage this OCI approach in the form of disaggregated data storage using NVMe-over-Fabrics (NVMe-oF). NVMe-oF is a networked storage protocol that allows storage to be disaggregated from compute to make that storage widely available to multiple applications and servers. By enabling applications to share a common pool of storage capacity, data can be easily shared between applications, or needed capacity can be allocated to an application regardless of location. Exploiting NVMe device-level performance, NVMe-oF promises to deliver the lowest end-to-end latency from application to shared storage. NVMe-oF enables composable infrastructures to deliver the data locality benefits of NVMe DAS (low latency, high performance) while providing the agility and flexibility of sharing storage and compute.



The maximum data storage capacity is 614TB\* when leveraging a full set of 10 F3100 fabric devices. The enclosure runs on an input voltage of 200V - 240V and consumes ~1400W of power under typical conditions. It requires a maximum of 1600W at full load.

### Composable Infrastructure

An emerging category of datacenter infrastructure that seeks to disaggregate compute, storage, and networking fabric resources into shared resource pools that can be available for on-demand allocation (i.e., "composable"). Composability occurs at the software level, disaggregation occurs at the hardware level using NVMe™-over-Fabric—will vastly improve compute and storage utilization, performance, and agility in the data center.

- 614TB\*
- 12GBps NVMe-oF over QSFP28 Cables
- 68.5 kg / 151.1 lbs.

### OpenFlex

OpenFlex is Western Digital's architecture that supports Open Composable Infrastructure through storage disaggregation – both disk and flash natively attached to a scalable fabric. OpenFlex does not rule out multiple fabrics, but whenever possible, Ethernet will be used as a unifying connect for both flash and disk because of its broad applicability and availability.

- 200V - 240V Input Voltages
- 3U Form Factor
- Hot-swappable PSUs and Fans

### Open Composable API

Western Digital's new Open Composable API is designed for data center composability. It builds upon existing industry standards utilizing the best features of those standards as well as practices from proprietary management protocols.

- Dual 1600W PSUs
- Operational Temperature: 5°C to 35°C
- Dynamic Provisioning Supported

\* Max storage capacity depends on device version and device configuration.



## 1.1.1 Servicing Features

The OpenFlex F3100 and E3000 are equipped with several features that make servicing simpler and safer. Every CRU component has been designed with toolless removal features.

The BMC Module, Fan Module, PSU, and F3100 devices are all hotswappable components. This document provides full instructions on how these features operate in the [Management \(page 29\)](#) section.

## 1.1.2 Composable Infrastructures

An emerging category of datacenter infrastructure that seeks to disaggregate compute, storage, and networking fabric resources into shared resource pools that can be available for on-demand allocation (i.e., "composable"). Composable occurs at the software level, disaggregation occurs at the hardware level.

Western Digital's vision for Open Composable Infrastructures is based on four key pillars:

- Open
  - Open in both API and form factor
  - Designed for robust interoperability of multi-vendor solutions
- Scalable
  - Ability to compose solutions at the width of the network
  - Enable self-organizing systems of composable elements that communicate horizontally
- Disaggregated
  - Pools of resources available for any use case that is defined at run time
  - Independent scaling of compute & storage elements to maximize efficiency & agility
- Extensible
  - Inclusive of both disk and flash
  - Entire ecosystem of composable elements managed & orchestrated using a common API framework
  - Prepared for yet-to-come composable elements – e.g., memory, accelerators

### 1.1.2.1 Open Composable

The Western Digital Open Composable Infrastructure (OCI) uses a common API to manage and coordinate with all fabric-attached storage including pools of flash and disk. The infrastructure also supports the management of networking and compute resources. The API is used for all managed elements to accelerate the ability to use disaggregated resources where components are no longer sub-components, but core elements connected to the network.

### 1.1.2.2 Open Composable API (OCAPI)

Western Digital's Open Composable API is a RESTful interface for OpenFlex that enables a Unified Fabric Control Plane for Storage Fabric Devices. This allows for composing disaggregated storage resources—with compute, networking, and memory—into virtual systems in the future. These virtual systems will be dynamically provided to the right application at the right time, ensuring SLAs can be met automatically.

- Volume management (create / modify / delete namespaces, format media)

- Monitor hardware sensors (temperatures, voltages, fan speeds, hardware state)
- Configure hardware (update firmware, reboot individual components or systems, assert LEDs)
- Monitor performance (statistics, bandwidth, IOPS, latency)
- Capture inventory data (serial number, part number, etc.)
- Capture log information
- Configure policies (user access lists, authentication, LUN masking, HTTPS/TLS encryption/security with certificate/key settings)
- Self-discovery of other locally-available resources configurable using the Open Composable API for OpenFlex

### 1.1.2.3 OCGUI

The Open Composable Graphical User Interface (OCGUI) is the graphical representation of all of the data shared up to the fabric by the OCAPI. This GUI is presented to the user by browsing to the IP address of any device on the fabric. The GUI has a "command-center" design layout that presents all vital health, utilization, and performance statistics related to devices on the network at a glance.

### 1.1.3 NVMe-oF

Non-Volatile Memory Express over Fabric (NVMe-oF) is one of the primary enabling technologies for the OpenFlex platform. NVMe-oF enables the high-speed, low-latency storage performance of NVMe over a fabric switching network. OpenFlex products drive network communications across the fabric using 100Gb/s Ethernet protocol. This allows for a complex network of computing devices to all share the same storage resources with very high performance.

### 1.1.4 Supported SKUs

The following table lists the versions of this Western Digital product that are supported by this document.

**Table 1:** List of Supported SKUs

Component	Capacity	SKU
OpenFlex E3000 Chassis 3U10 Enclosure	N/A	1ES1778
OpenFlex F3100 Fabric Device 2x50GbE nTAA PCIe RI-2DW/D ISE	12.8TB	1EX2413
OpenFlex F3100 Fabric Device 2x50GbE nTAA PCIe RI-0.8DW/D ISE	15.36TB	1EX2416
OpenFlex F3100 Fabric Device 2x50GbE nTAA PCIe RI-2DW/D ISE	25.6TB	1EX2414
OpenFlex F3100 Fabric Device 2x50GbE nTAA PCIe RI-0.8DW/D ISE	30.72TB	1EX2417
OpenFlex F3100 Fabric Device 2x50GbE nTAA PCIe RI-2DW/D ISE	51.2TB	1EX2415
OpenFlex F3100 Fabric Device 2x50GbE nTAA PCIe RI-0.8DW/D ISE	61.44TB	1EX2418

### 1.1.5 List of Compatible Devices

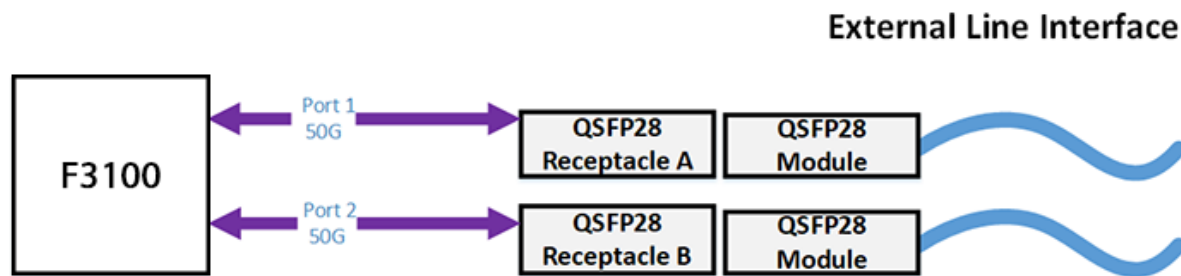
**Table 2:** Devices

Device	Volume	Bandwidth*	Drive Writes	Encryption	Part Number
OpenFlex F3100 Fabric Device	12.8TB	12GB/s	RI-2DW/D	ISE	1EX2413
OpenFlex F3100 Fabric Device	15.36TB	12GB/s	RI-0.8DW/D	ISE	1EX2416
OpenFlex F3100 Fabric Device	25.6TB	12GB/s	RI-2DW/D	ISE	1EX2414
OpenFlex F3100 Fabric Device	30.72TB	12GB/s	RI-0.8DW/D	ISE	1EX2417
OpenFlex F3100 Fabric Device	51.2TB	12GB/s	RI-2DW/D	ISE	1EX2415
OpenFlex F3100 Fabric Device	61.44TB	12GB/s	RI-0.8DW/D	ISE	1EX2418

## 1.2 System Architecture Overview

### 1.2.1 System High Speed Data Ingest Architecture

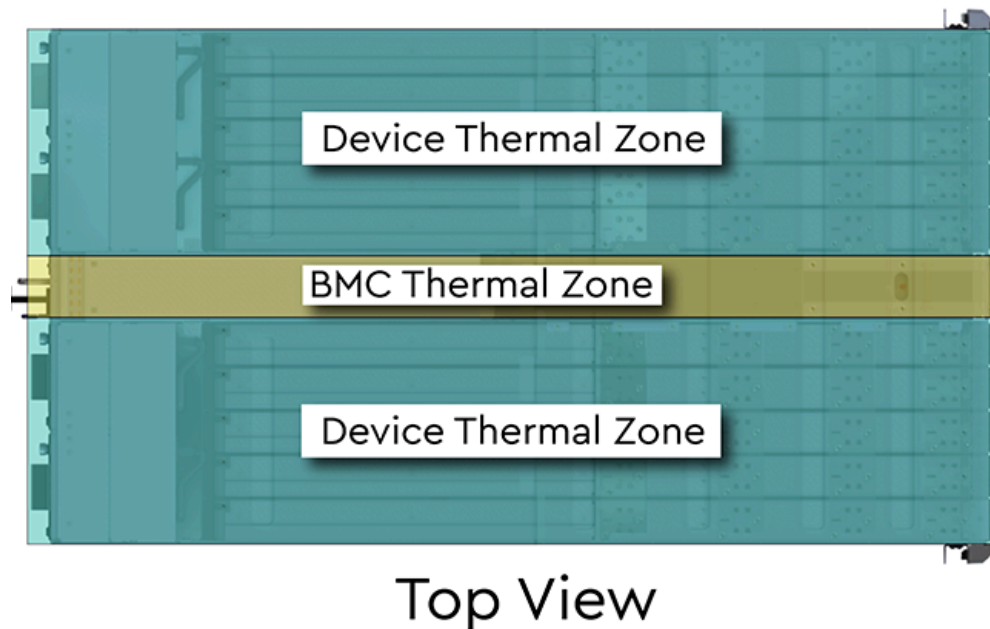
The system main data ingest architecture uses two separate 50G Ethernet connections each on a dual QSFP28 connector on the rear I/O of the chassis. This completes the connection from the device that is inserted into a chassis slot, through the backplane into the QSFP connectors. The architecture supports the hot swap nature of the devices and do not require any sort of shut down or disconnection before servicing. Each 100G Ethernet connection is split in half at the QSFP28 connectors resulting in 50G per connector allowing for dual port functionality with the device.

**Figure 2:** System High Speed Data Ingest

### 1.2.2 System Thermal and Cooling

The following image displays the thermal zones as viewed from the top of the enclosure. When viewing the enclosure from the front, the right device zone is on the right-hand side and the left device zone is on the left-hand side. When viewing the enclosure from the rear, the order is reversed. Each of the two thermal zones contains major components that are thermally maintained within their specific zone.

\* Bandwidth obtained by sequential read

**Figure 3:** System Thermal Zones

The E3000 uses a base algorithm, called a thermal algorithm, to control the overall thermal environment of the system. The system is mechanically separated into two thermal zones to support efficient cooling of the system components in order to achieve the intended performance of the system. The thermal zones are split into device zones (the left and right side of the enclosure) and center zone when standing at the front of the system. The device thermal zones contain up to ten devices or device blanks each that are cooled by four fan modules that are located directly behind the devices. The four fan modules behind the devices maintain the cooling for devices contained within the device slot installed into A through J. The center thermal zone contains the BMC module that is cooled by the fans contained in the redundant PSUs that are located directly behind the BMC module. The different thermal zones are designed to maintain proper thermal cooling across the entire system. During servicing the system increases the speed of the fan modules and PSU fans to maintain a balanced thermal load.

### 1.2.2.1 System Thermal Algorithm

The System Thermal Algorithm is designed to use temperature sensors and defined thresholds to determine if the algorithm will select critical, increase, decrease, or no change as the device decision.

The System Thermal Algorithm uses the concept of priorities to ensure the proper function of the system. As a result, any critical fault results in the system ramping the fans to maximum RPMs to protect the hardware for the duration of the fault. The fault will remain in a critical state until the fault is fully resolved and by bringing the temperature back within the specified defined thresholds.

The System Thermal Algorithm contains minimum and maximum thresholds related to the ambient temperature of the system. The system is designed to maintain a maximum ambient temperature of 35°C. Exceeding 35°C may result in damage to the hardware and potentially void the product warranty. These thresholds allow for the best possible operating conditions. If the system goes outside of the minimum or maximum threshold window, the BMC will adjust the fan speed to accommodate the issue and a fault will be reported. The following table lists the Thermal Algorithm Thresholds along with the related fault levels and threshold values.

The following table lists the different severity of thermal algorithm critical faults that are reported to the user.

**Table 3:** Thermal Algorithm Critical Faults

Component	Critical Faults
Device	Any sensor >= critical
BMC	Not installed FAN
	Not installed PSU
	Not installed Device or Blank
	Not installed BMC
PSU	Any sensor >= critical
	Any critical status on SMBus

The following table lists the device decision values that the system chooses from during operation. It describes how the pulse width modulation (PWM) of the power that is being distributed to the cooling fans reacts to different fault types. The fault will be reported based on the severity of the thermal issue.

**Table 4:** Thermal Algorithm Device Decision for Fan Control

Fault	Sensor Value	Fan Response
Critical	Sensor >= Critical	100% PWM
Increase	Sensor >= Max	PWM + increase step
Decrease	Sensor <= Min	PWM - decrease step
No Change	Min < Sensor < Max	Hold PWM

## 1.3 OpenFlex F3100 and E3000 Specification Summary

**Table 5:** Environmental Specifications

Specification	Non-Operational	Operational
Temperature	-30°C to 60°C	5°C to 35°C
Temperature Gradient	30°C per hour max	20°C per hour max
Temperature De-rating	1°C per 300m above 3000m	1°C per 175m above 950m
Relative Humidity	5-95% Non-Condensing	8-85% Non-Condensing
Relative Humidity Gradient	30% per hour maximum	30% per hour maximum
Altitude	-300m to 12,000m / -984 ft. to 39,370 ft	-300m to 3048m / -984 ft. to 10,000 ft.

## 1.3 OpenFlex F3100 and E3000 Specification Summary

Specification	Non-Operational	Operational
Cooling	N/A	4 Fan Modules (N+1 Supported), containing two fans per module

**Table 6:** Electrical Specifications

Specification	Value
Max Power Consumption	1600W
Typical Power Consumption	~1400W
Input Voltage	200V - 240V
PSU Connector Type	C16
Inrush Current Maximum (per PSU)	AC line inrush current shall not exceed 40A peak, for up to one-quarter of the AC cycle after which, the input current should be no more than the specified maximum input current.
PSU Efficiency	80 PLUS Platinum

**Table 7:** Mechanical Specifications

Specification	Non-Operational	Operational
Shock	20G, 7ms half sine; 3 positive and 3 negative pulses in each axis Z and Y. X axis- 15G, 7ms half sine, 3 positive and 3 negative pulses	5G, 11ms half sine; 3 positive and 3 negative pulses in each axis- minimum 6 seconds between shocks
Vibration	<p><b>Linear Random:</b> 0.50Grms; 5-500Hz; 10 minutes each axis in X, Y, and Z</p> <p><b>Linear Random:</b> 0.54Grms; 1-200Hz; 60 minutes in Z axis.</p> <p><b>Linear Random:</b> 0.80Grms; 2 - 200Hz; 15 minutes in Z axis</p> <p><b>Swept Sine:</b> 0.50G, 0 - peak swept sine; 5 - 500Hz; 1 complete sweep @ 1/2 octave per minute</p>	<p><b>Linear Random:</b> 0.15 Grms 5-500 Hz 10 minutes each axis in X, Y and Z</p> <p><b>Swept Sine:</b> 0.17 G, 0 - peak, 5-500 Hz 0.5 octaves/min, approx. 13 minutes each axis</p>
Weight	68.5 kg / 151.1 lbs.	
Dimensions	<b>W:</b> 447.2 mm x <b>L:</b> 828.04 mm x <b>H:</b> 130.9 mm / <b>W:</b> 17.6 in. x <b>L:</b> 32.6 in. x <b>H:</b> 5.2 in.	
System Installation Length	778 mm / 30.6 in. from the front rack chassis mounts to the rear of the system	
Required Rack Depth	1000 mm (39.4 in.) of usable rack space, frame to frame	
Required Rack Width	450mm (17.72in.) with 465mm (18.31in.) ± 1.5mm nominal hole spacing. See EIA-310 Rack Standard	

## 1.3 OpenFlex F3100 and E3000 Specification Summary

Specification	Non-Operational	Operational
Rack Units (U)	3U	
Vertical Rack Rail Spacing	718 mm – 850 mm / 28.26 in. – 33.46 in.	

**Table 8:** Performance Specifications

Specification	Value
Number of Device Slots	10 Dual-port Fabric Device Bays
Data Transfer Rates	12GBps NVMe-oF
Max Raw Data Storage Capacity	614TB*
Ethernet Ports	20 x 50Gbps QSFP28 ( 2 per Fabric Device) 1 x 10/100/1G Ethernet

**Table 9:** Performance Specifications by CRU P/N

CRU P/N	1EX2413	1EX2416	1EX2414	1EX2417	1EX2415	1EX2418
Capacity/ Endurance	12.8TB 1-2DWPD	15.36TB 0.8DWPD	25.6TB 2DWPD	30.72TB 0.8DWPD	51.2TB 0.8DWPD	61.44TB 0.8DWPD
Random Read (4KB, QD=1024)	2199K IOPs	2111K IOPs	2164K IOPs	2160K IOPs	2176K IOPs	2191K IOPs <sup>1</sup>
Random Write (4KB, QD=1024)	1493K IOPs	1433K IOPs	1431K IOPs	1397K IOPs	1464K IOPs	1400K IOPs <sup>1</sup>
Random Mixed 70R/30W (4KB, QD=1024)	2199K IOPs	2137K IOPs	2183K IOPs	2188K IOPs	2227K IOPs	2251K IOPs
Sequential Read (128KB, QD=320)	11.8 GB/s	11.7 GB/s	11.7 GB/s	11.7 GB/s	11.7	11.7 GB/s
Sequential Write (128KB, QD=320)	9.9 GB/s	9.9 GB/s	9.9 GB/s	9.4 GB/s	9.4 GB/s	9.9 GB/s
Random Write Latency (4KB, QD=1, 99.99%)	33.9 us	33.7 us	33.7 us	33.9 us	33.7	33.5 us

**Notes on Testing:**

- Latency measured through a single Mellanox SN2700 switch
- K IOPs = IOPs x 1000
- Devices pre-conditioned with 2 full sequential fills

\* Max storage capacity depends on device version and device configuration.

**Table 10:** Acoustic Specifications

Quantities Declared	Idle Mode	Operating Mode	Fan Fail Mode <sup>5</sup>	Max Fan Mode
A-weighted sound power level <sup>1</sup> , $L_{WA_d}$ {1 B = 10 dB}	8.5	8.5	9.6	9.6
Average A-weighted emission sound pressure level <sup>2</sup> , $L_{pAm}$ (dB) {bystander position <sup>3</sup> }	66.0	66.0	74.9	76.2
Statistical adder for verification <sup>4</sup> , $K$ (dB)	2.5	2.5	2.5	2.5

**Notes on Acoustic Testing Methodology and Environment:**

<sup>1</sup> Declared A-weighted sound power level for a single machine, calculated per section 4.4.2 of ISO 9296-1988 and measured per ISO 3744

<sup>2</sup> Declared A-weighted sound pressure level for a single machine, calculated per section 4.4.4 of ISO-9296-1988 and measured per ISO 3744

<sup>3</sup> The front and rear of the UUT were selected for the bystander location, due to access typically from the cool or hot aisle in a data center. This does not meet the four bystander positions as specified in ECMA-74 2012, but the microphones were adjusted to the preferred location.

<sup>4</sup> The statistical adder,  $K$ , accounts for random measurement error, and is equal to 2.5 dB, which is appropriate for a 5% risk of rejection for  $SR = 1.5$  dB per section 4.4.2 of ISO 9296-1988.

<sup>5</sup> At steady state condition, system/PSU fans reached 100% pwm speeds during fan fail mode testing.

- Background noise: <7dBA
- Environmental test conditions: ~23° C, 57% RH, 101.3 kPa
- Tested configuration: 3U NVMeOF VBOF device with 10 devices installed.

## 1.4 Physical Design

---

The OpenFlex F3100 and E3000 physical design emphasizes easy access to hot-swappable components, maximization of data storage capacity in the rack, and bold aesthetic design.

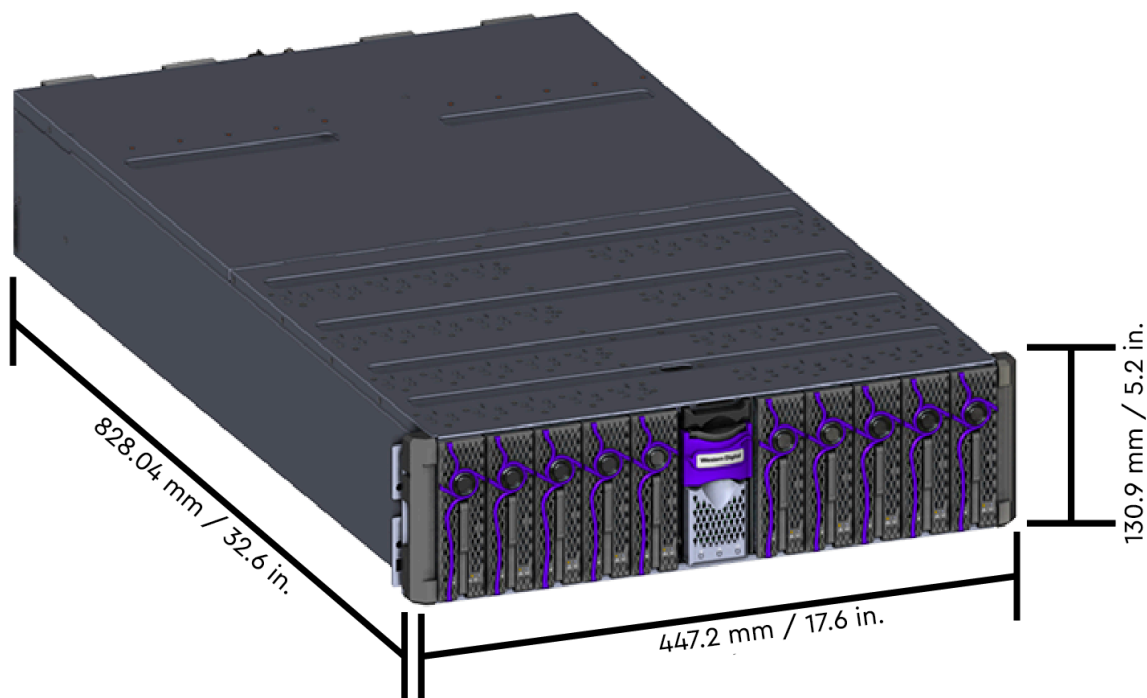


**Figure 4:** OpenFlex F3100 and E3000 Layout



The enclosure measures 447.2 mm/17.6 in. wide by 828.04 mm/32.6 in. long. It's height is 130.9 mm/5.2 in. or 3U. The chassis installation length is 778 mm / 30.6 in. from the front rack chassis mounts to the rear of the system.

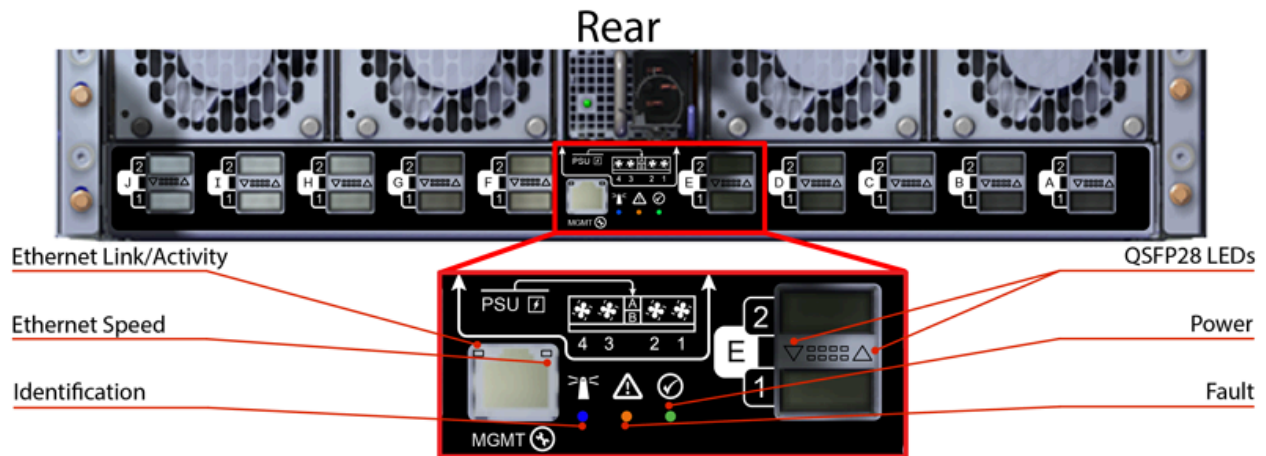
**Figure 5:** OpenFlex F3100 and E3000 Dimensions



### 1.4.1 LEDs

#### Chassis LEDs

**Figure 6:** Chassis Rear IO LEDs



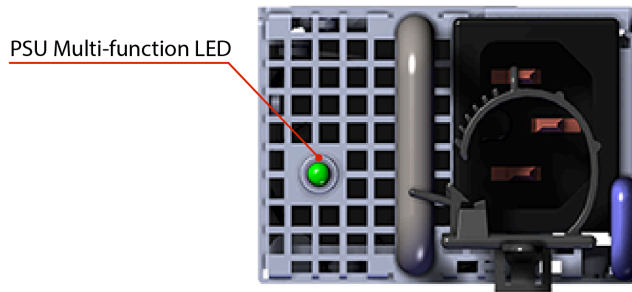
**Table 11:** Chassis Rear IO LED Flash Patterns

LED Name	Color	Behavior
Ethernet Link/Activity	Green	<b>Off:</b> No Connection <b>Solid:</b> Connected <b>Blink:</b> Activity
Ethernet Speed	Green	<b>Off:</b> Operating at 10 Mbps <b>Solid:</b> Operating at 100 Mbps
	Amber	<b>Off:</b> Operating at 10 Mbps <b>Solid:</b> Operating at 1Gbps
Identification	Blue	<b>Blink @ 1 Hz:</b> Blinks only when Identification has been activated. Will blink when <b>any</b> component is identified, e.g. Fans, PSUs, etc.
		<b>Off:</b> Enclosure not being identified/located
QSFP28 LED	Green	<b>Solid:</b> Link operating at maximum speed <b>Blink (3Hz):</b> Link activity
		<b>Off:</b> Default state
	Amber	<b>Solid:</b> Link operating at a lower speed, 50G or less <b>Blink (3Hz):</b> Low speed link activity <b>Blink (1Hz):</b> On/Off - Identify

LED Name	Color	Behavior
Power	Green	<b>Solid:</b> Enclosure is powered on <b>Off:</b> Enclosure is powered off
Fault	Amber	<b>Blink @ 2 Hz:</b> Enclosure has a fault <b>Off:</b> Enclosure has no fault

**PSU LED**

**Figure 7:** PSU LED

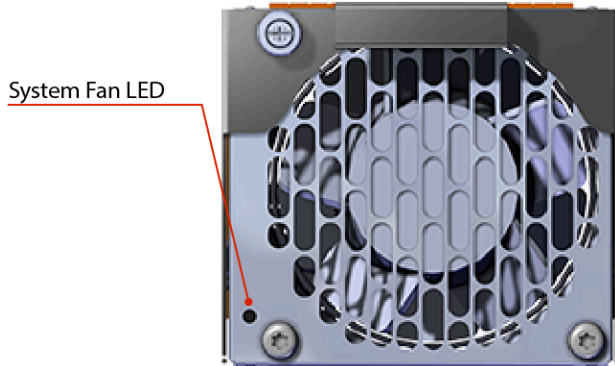


**Table 12:** PSU LED Flash Patterns

LED Name	Color	Behavior
Multi-function LED	Green	<b>Solid:</b> PSU is on and reporting no faults <b>Blinking @ 2Hz:</b> PSU in firmware update mode <b>Off:</b> PSU is disconnected from power
	Amber	<b>Solid:</b> PSU is disconnected from power or critical fault causing a shutdown failure <b>Blinking @ 0.5Hz:</b> PSU reporting warnings <b>Off:</b> PSU is reporting no faults

**Fan Module LED**

**Figure 8:** Fan Module LED

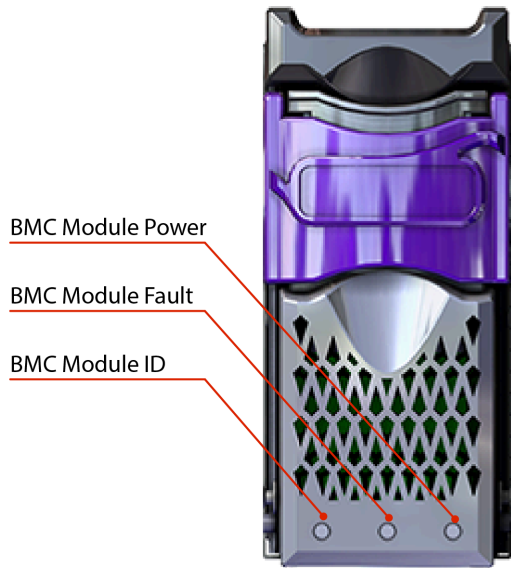


**Table 13:** Fan Module LED Flash Patterns

LED Name	Color	Behavior
LED	Amber	<b>Blinking @ 2 Hz:</b> Fan is reporting a fault <b>Blinking @ 1 Hz:</b> Fan is being identified <b>Off:</b> Fan is on and reporting no faults

**BMC Module LEDs**

**Figure 9:** BMC Module LEDs



**Table 14:** BMC Module LED Flash Patterns

LED Name	Color	Behavior
Identification	Blue	<b>Blink @ 1 Hz:</b> Blinks only when Identification has been activated. Will blink when <b>any</b> component is identified.
Fault	Amber	<b>Blink @ 2 Hz:</b> Enclosure has a fault <b>Off:</b> Default State
Power	Green	<b>Solid:</b> Powered On

OpenFlex F3100 LEDs

Figure 10: OpenFlex F3100 LEDs

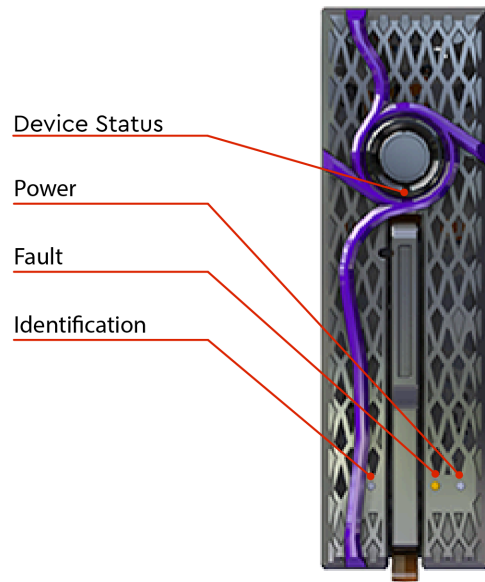


Table 15: OpenFlex F3100 LED Flash Patterns

LED Name	Color	Behavior
Device Status	White	<b>Solid:</b> On and Connected <b>Off:</b> Not Ready or Powered down
	Blue	<b>Blink @ 1 Hz:</b> OpenFlexF3100 is flushing the cache <b>Off:</b> Default State
Power	Green	<b>On:</b> Device is Powered On <b>Off:</b> Device is Powered Down
Fault	Amber	<b>Blink @ 1 Hz:</b> Device has a fault <b>Solid:</b> Device is Powered Down <b>Off:</b> Device has no fault
Identification	Blue	<b>Blink @ 1 Hz:</b> Blinks only when Identification has been activated. <b>Off:</b> Device is not being identified.

## 1.4.2 Cables

The following table displays the power cable supported by Western Digital:

**Table 16:** Approved Power Cables

Type	Part Number	Length
IEC C14 to IEC C15 Heavy Duty 15A Power Cable	(Provided in Accessory Kit)	6 ft.

The following table displays the Ethernet cables approved by Western Digital:



**Note:** These cables are approved, but not provided by Western Digital.

**Table 17:** Approved Ethernet Cables

Vendor	Active/Passive	Vendor Model Number	Western Digital Part Number
Mellanox	Passive	MCP1600-C001	
	Passive	MCP1600-C002	
	Passive	MCP1600-C003	
	Active	MFA1A00-C005	
Amphenol	Passive	NDARHG-0001	
	Passive	NDARHG-0004	
	Passive	NDARHF0002	
	Passive	NDARHJ0003	

## 1.5 Restrictions and Limitations

The OpenFlex F3100 and E3000 have the following restrictions and limitations on functionality:

- All E3000 chassis must be full for proper airflow. This means that if there is only one device installed, the rest of the device slots must be filled with device blanks.
- If the BMC Module is not installed in the E3000 chassis, F3100 devices cannot be added or slot swapped.
- Only hot-swap a single component at a time. Never remove more than one at a time.
- VLAN tagging is not supported.
- RoCE v1 is not supported. F3100 will support RoCE v2 only.

- To power off an F3100, browse directly to the F3100. Power off cannot be done from the E3000. To power back on the F3100, browse to the E3000.
- IPv4 networking only.
- Only one browser session allowed to an individual F3100 device.
- Enforced maximum limits on configuration
  - 256 Volumes
  - 256 Hosts
  - 2048 Queue Pairs
  - 128 Queue Pairs (1 Admin, 127 IO) per connection
  - 64 max queue depth per IO Queue Pair

## 1.6 Site Requirements

### 1.6.1 Power Requirements

The E3000 is equipped with redundant PSU units. The PSUs are hot-swappable and are located at the rear of the chassis. The following is a specification summary. Note that the system does not support lowline voltage.

**Table 18:** Power Specification

Specification	Value
Power Output	1600W
Input Voltage	200V - 240V
80 PLUS Standard	Platinum
Connector Type	C16

### 1.6.2 Rack Requirements

The E3000 is designed to be installed into a rack that meets the EIA-310 standard with a minimum of 1000 mm (39.4 in.) of usable rack space, frame to frame. The vertical rack rails must be set between 718 mm – 850 mm / 28.26 in. – 33.46 in. to support the enclosure. It requires 3U of rack space, and it should be installed into the rack at the lowest possible U height to keep the load on the rack balanced.

**Table 19:** Required Rack Specifications

Parameter	Requirement
Rack Depth	1000 mm (39.4 in.) of usable rack space, frame to frame
Rack Width	450mm (17.72in.) with 465mm (18.31in.) ± 1.5mm nominal hole spacing. See EIA-310 Rack Standard
Rack Units (U)	3U
Vertical Rack Rail Spacing	718 mm – 850 mm / 28.26 in. – 33.46 in.

Parameter	Requirement
Static Load Rating	Rack meets ISTA 3E or 3B test requirements and regulations when mounted to the shipping pallet
Dynamic Load Rating	Rack meets ISTA 3E or 3B test requirements and regulations when mounted to the shipping pallet

### 1.6.3 Thermal and Cooling Requirements

The thermal output of the OpenFlex F3100 and E3000 depends on the number of F3100s that are populated in the E3000. Use the following table to determine how many BTUs of heat will exhaust from the rear of the unit.

**Table 20:** BTU Exhaust per Component

Condition	Typical BTU Output	Max BTU Output
Single E3000 w/ BMC Module	768 BTU/hr = 225 W (25C/77F, fans at 50%)	1177 BTU/hr = 345 W (35C/95F, fans at 100%)
Single F3100	409 BTU/hr = 120 W (25C/77F, Workload: Random Read/Write, queue depth 32, 80% internal processors dedicated to workload)	546 BTU/hr = 160 W (35C/95F, workload: Highest throughput to drives – Seq Write, queue depth 32, all internal processors at 100%)
E3000 Fully Populated with F3100s	5244 BTU/hr = 1537 W (25C/77F, fans at 50%)	5884 BTU/hr = 1725 W (35C/95F, fans at 100%)

### 1.6.4 Servicing Requirements

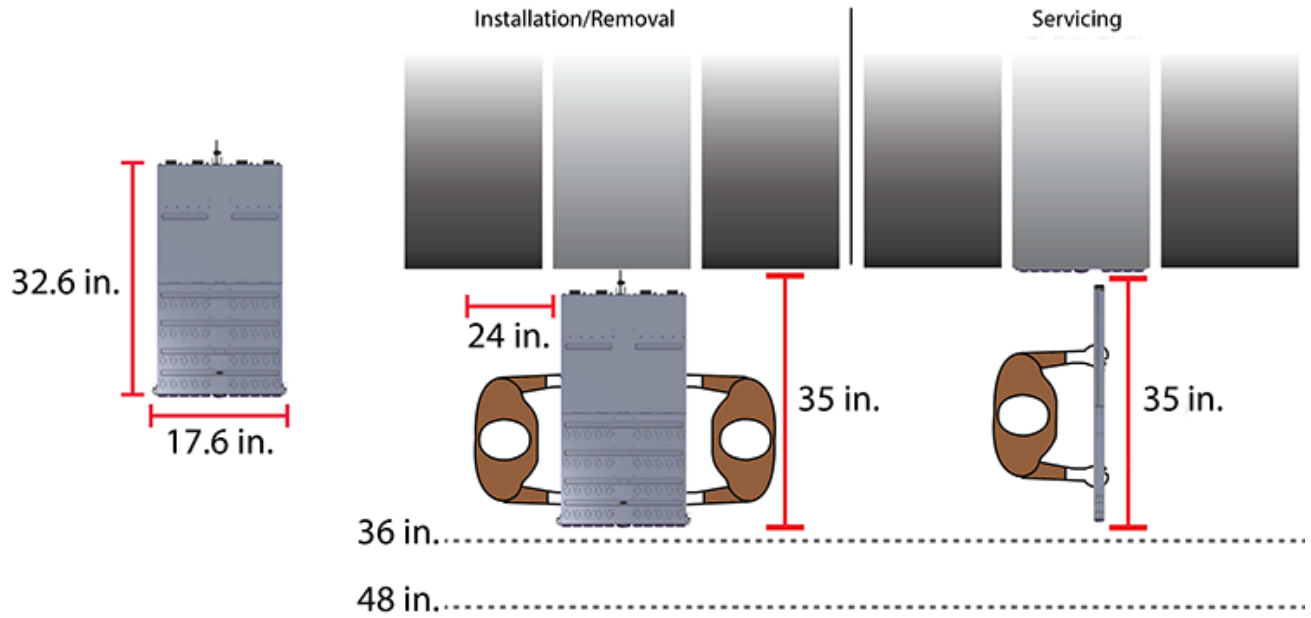
#### Space Requirements

The installation of the OpenFlex F3100 and E3000 will require enough space in front of the rack for two people to perform a safe installation. The recommended forward clearance is 889 mm / 35 in. from the front of the rack and 609.6 mm / 24 in. on both sides of the enclosure. It is also recommended to make considerations for any carts or lift equipment that might be used to perform the installation.\* The servicing of the enclosure requires one person and a minimum of 508 mm / 20 in. of space in front of the rack to allow enough clearance to remove an F3100 from the enclosure. See the following diagram for details.

\* The weight of the enclosure during installation will vary, depending on the number of F3100 devices and blanks contained in the E3000. In some situations, carts or lift equipment may be required.



**Figure 11:** Installation and Servicing Space





# Components

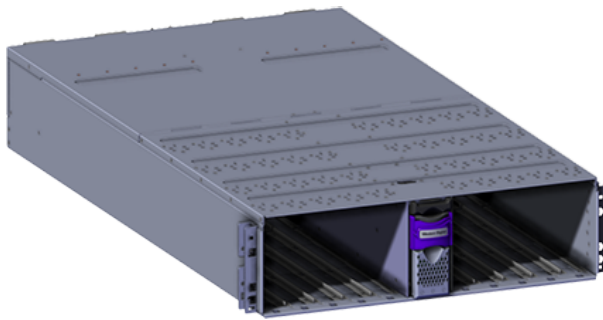
## In This Chapter:

- Chassis..... 21
- PSU.....22
- Fan Module.....23
- BMC Module.....24
- Rails.....25
- OpenFlex F3100..... 26

## 2.1 Chassis

The OpenFlex E3000 chassis is the primary housing that contains and connects all of the system components that comprise the OpenFlex F3100 and E3000. The chassis contains one BMC Module in the front, and the rear contains two redundant PSUs and four Fan Modules that come preinstalled in the chassis. The chassis also contains ten device slots that can be populated with approved OpenFlex™ components. The E3000 is installed and secured onto shelf style rail mounts. The rear IO houses the primary connections such as power and QSFP28 ports and the status LEDs for all of the components.

### 2.1.1 Chassis Specifications



**Table 21:** Chassis Specification Summary

Specification	Value
Rack Units	3U
Number of Device Slots	10
Number of BMC Slots	1
Part Number	1EX1919
Hot Swappable?	No
Dimensions	<b>W:</b> 447.2 mm x <b>L:</b> 828.04 mm x <b>H:</b> 130.9 mm / <b>W:</b> 17.6 in. x <b>L:</b> 32.6 in. x <b>H:</b> 5.2 in.
Weight	38.2 lbs / 17.32 kg

## 2.2 PSU

The OpenFlex E3000 chassis contains toolless redundant 1600W Power Supply Units (PSU). Each PSU requires an input voltage of between 200V - 240V. The PSUs are certified 80 PLUS Platinum and use the C16 connector type. Due to the redundant nature of the PSUs, they may be serviced or replaced, one at a time, while the enclosure is powered on.

### 2.2.1 PSU Specifications



**Table 22:** PSU Specification Summary

Specification	Value
Power Output	1600W
Input Voltage	200V - 240V
80 PLUS Standard	Platinum
Connector Type	C16
Internal Fan Speed	Up to 25,000 RPM
Number per Enclosure	2
Part Number	1EX1916
Hot Swappable?	Yes
Service Window	5 minutes
Dimensions	<b>W:</b> 54.5 mm x <b>L:</b> 321.5 mm x <b>H:</b> 40.1 mm <b>W:</b> 2.15 in. x <b>L:</b> 12.66 in. x <b>H:</b> 1.58 in.
Weight	2.31 lbs. / 1.05 kg

## 2.3 Fan Module

The OpenFlex E3000 contains four toolless Fan Modules to maintain the cooling across the entire system. The Fan Modules are connected to the rear of the Chassis using a handle to seat the module in place and captive screw to secure the Fan Module into the fan bay. Due to the redundant nature of the Fan Modules, they may be serviced or replaced, one at a time, while the enclosure is powered on. The Fan Modules will accelerate to maximum RPM while the BMC Module or devices are removed during servicing or replacement.

### 2.3.1 Fan Module Specifications



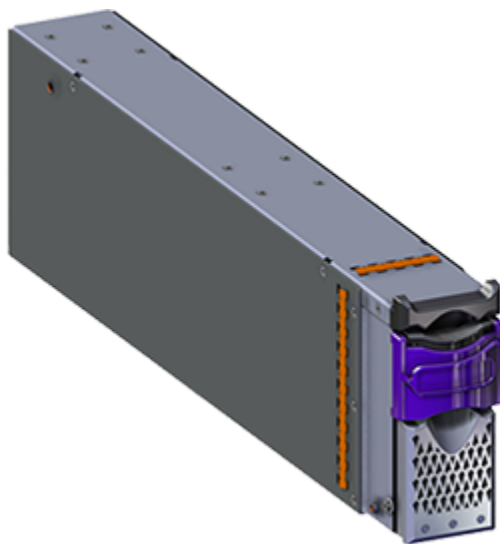
**Table 23:** Fan Module Specification Summary

Specification	Value
Rated Voltage	12V
Fan Speed	12000 RPM
Acoustics	76 dB measured at 1 meter from the fan inlet
Number per Enclosure	4 Fan Modules containing two rotors per module
Part Number	1EX1915
Hot Swappable?	Yes
Service Window	5 minutes
Dimensions	<b>W:</b> 92.74 mm x <b>L:</b> 127.2 mm x <b>H:</b> 85.2 mm <b>W:</b> 3.65 in x <b>L:</b> 5.01 in x <b>H:</b> 3.35 in
Weight	1.76 lbs. / 0.8 kg

## 2.4 BMC Module

The OpenFlex E3000 contains a toolless BMC Module that is installed into the center slot at the front of the Chassis. The BMC Module is accessed using a 1GbE Ethernet management RJ45 port on the rear IO of the Chassis. The BMC Module enables out of band management (OOBM) using a RESTful interface (via HTTP or HTTPS). OOBM controls the actions between devices and the BMC Module for powering down, setting system configurations, and the cooling algorithm for the Fan Modules. The BMC Module may be serviced or replaced while the enclosure is powered on as long as it is replaced within five minutes of removing it from the slot. Replacing a BMC module will not effect data flow to devices.

### 2.4.1 BMC Module Specifications



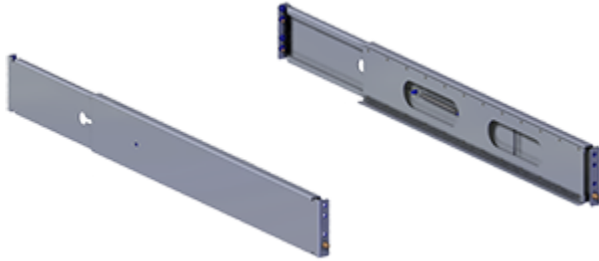
**Table 24:** BMC Module Specification Summary

Specification	Value
Input Current	2A Maximum
Input Power	25W
Rated Voltage	12V +/- 10%
Number per Enclosure	1 installed in the center device slot
Part Number	1EX1917
Hot Swappable?	Yes
Service window	5 minutes
Dimensions	<b>W:</b> 55.6 mm x <b>L:</b> 459.12 mm x <b>H:</b> 126.94 mm <b>W:</b> 2.19 in x <b>L:</b> 18.08 in x <b>H:</b> 5 in
Weight	3.26 lbs. / 1.48 kg

## 2.5 Rails

The E3000 is installed onto shelf style rails. The rail length can be adjusted between 850.31 mm / 33.47 in (max) and 693.69 mm / 27.31 in. (min) in order to fit into different vertical rack rail settings. Once the enclosure is installed onto the rails, it may be secured to the rails using the provided M5 screws.

### 2.5.1 Rails Specifications



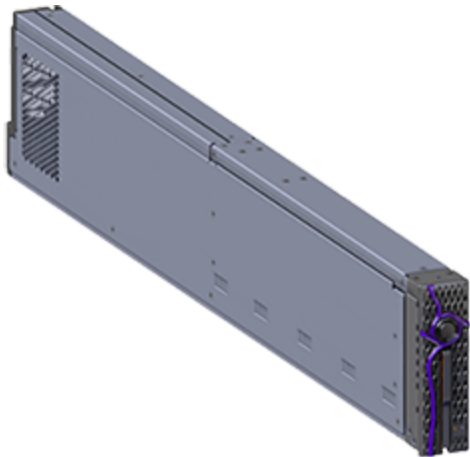
**Table 25:** Rails Specification Summary

Specification	Value
Length	693.69 mm / 27.31 in. (min) 850.31 mm / 33.47 in (max)
Part Number	1EX2198
Hot Swappable?	No
Dimensions	<b>W:</b> 34.4 mm x <b>L:</b> 693.69 mm x <b>H:</b> 89.65 mm <b>W:</b> 1.35 in. x <b>L:</b> 27.31 in. x <b>H:</b> 3.53 in.
Weight	5.08 kg / 11.2 lbs (both rails)

## 2.6 OpenFlex F3100

The F3100 is a fabric device that contains a maximum of 61.4TB of raw data storage capacity per device. The device supports Open Composable Infrastructure (OCI) through storage disaggregation using NVMe-over-Fabrics (NVMe-oF). The front of the F3100 contains a button latch release system and status LEDs and the rear contains the device connector.

### 2.6.1 OpenFlex F3100 Specifications



**Table 26:** OpenFlex F3100 Specification Summary

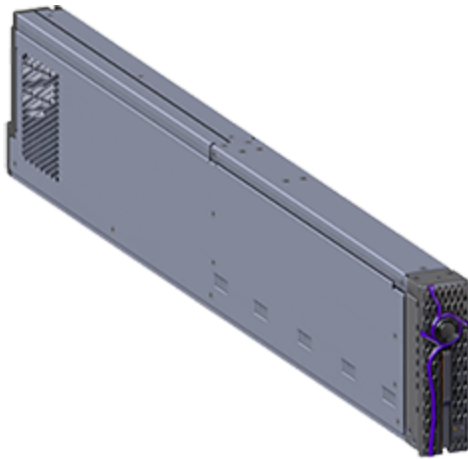
Specification	Value
Max Raw Data Storage Capacity per device	61.4 TB
Data Ingest Capability	2x 50G Ethernet (see <a href="#">System High Speed Data Ingest Architecture (page 5)</a> )
Data Transfer Rates	12 GBps*
Number per enclosure	Up to 10
Part Numbers	See the <a href="#">List of Compatible Devices (page 4)</a> to find the specific part number required.
Hot Swappable?	Yes
Service Window	5 minutes
Dimensions	<b>W:</b> 37.53 mm x <b>L:</b> 694.4 mm x <b>H:</b> 124.11 mm <b>W:</b> 1.48 in x <b>L:</b> 27.34 in x <b>H:</b> 4.89 in
Weight	4.44 kg / 9.8 lbs



## 2.7 OpenFlex E3000 Fabric Device Blank

The OpenFlex E3000 chassis may contain up to 9 OpenFlex E3000 Fabric Device Blanks\*. The chassis must contain at least one device, and the remaining slots must be populated with either devices or device blanks to avoid compromising the cooling of the enclosure. Each OpenFlex E3000 Fabric Device Blank may be replaced with a device as the enclosure is scaled up. The OpenFlex E3000 Fabric Device Blank may be serviced or replaced one at a time while the enclosure is powered on.

### 2.7.1 OpenFlex E3000 Fabric Device Blank Specifications



**Table 27:** OpenFlex E3000 Fabric Device Blank Specification Summary

Specification	Value
Number per enclosure	Up to 9
Part Number	1EX1918
Hot Swappable?	Yes
Service Window	5 minutes
Dimensions	<b>W:</b> 37.53 mm x <b>L:</b> 694.4 mm x <b>H:</b> 124.11 mm <b>W:</b> 1.48 in x <b>L:</b> 27.34 in x <b>H:</b> 4.89 in
Weight	4.12 lbs. / 1.87 kg

\* The form factor of the fabric device blank is compatible with all F-Series devices.

## 2.8 List of Field/Customer Replaceable Units

---

The following table lists the replaceable components and their part numbers.

**Table 28:** List of Field/Customer Replaceable Components

Component	Part Number
Chassis	1EX1919
PSU	1EX1916
Fan Module	1EX1915
BMC Module	1EX1917
Rails	1EX2198
Accessory Kit	1EX2199
OpenFlex E3000 Fabric Device Blank	1EX1918
OpenFlex F3100 Fabric Device	See <a href="#">Supported SKUs</a> (page 4)

# Management

## In This Chapter:

- OCGUI.....30
- Part Replacement..... 81



## 3.1 OCGUI

---

### 3.1.1 Login Page

**Login - EUP9**  
Sign In to your account

Username

Password

Login - EUP9

**Login ?**  
You will need to login first to access the system.

EUP9

Type - Storage  
ID - 000af7958cad  
Device OS Version - 0.4.0  
Manufacturer - WDC  
Model - OpenFlex F3000  
Status - OK

Apr 24th 19, 1:39:40 pm  
© 2019 Western Digital Corporation

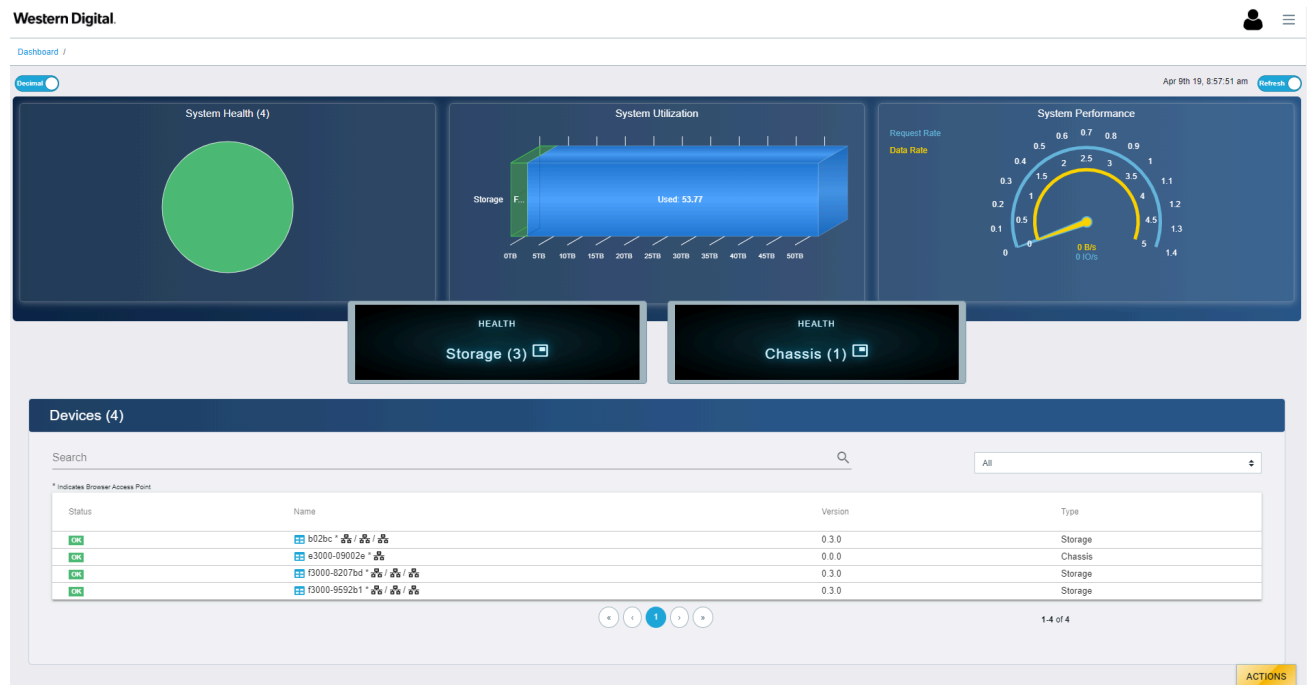
The login page displays two panels. The left panel provides username and password fields for logging into the enclosure. The right panel lists basic information about the enclosure itself, including the type of device, the OS version, and its status.



**Note:** For instructions on navigating to the login page, see [Navigating to a Device Using the OCGUI](#) (page 49).

### 3.1.2 Dashboard

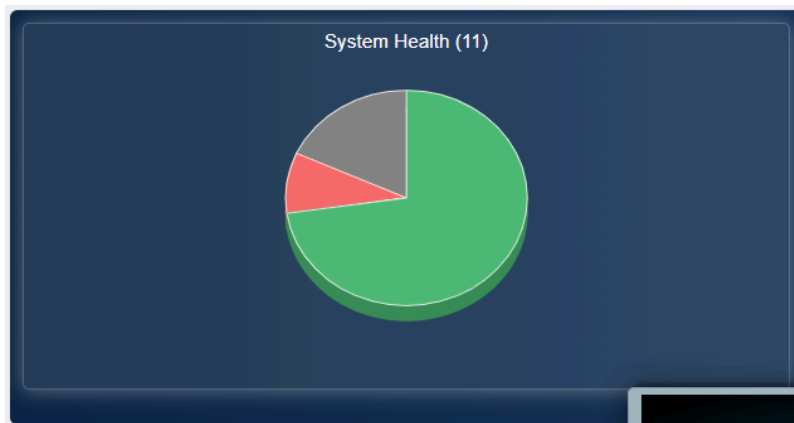
**Figure 20:** Dashboard



The dashboard provides vital statistics on the health and performance of all of the devices on the fabric. It is the first page that will load when one logs into any of the fabric-attached devices. The dashboard has a list of all the devices on the fabric, and clicking through this section will link to the device page for that device.

### 3.1.2.1 System Health View

**Figure 21:** System Health View

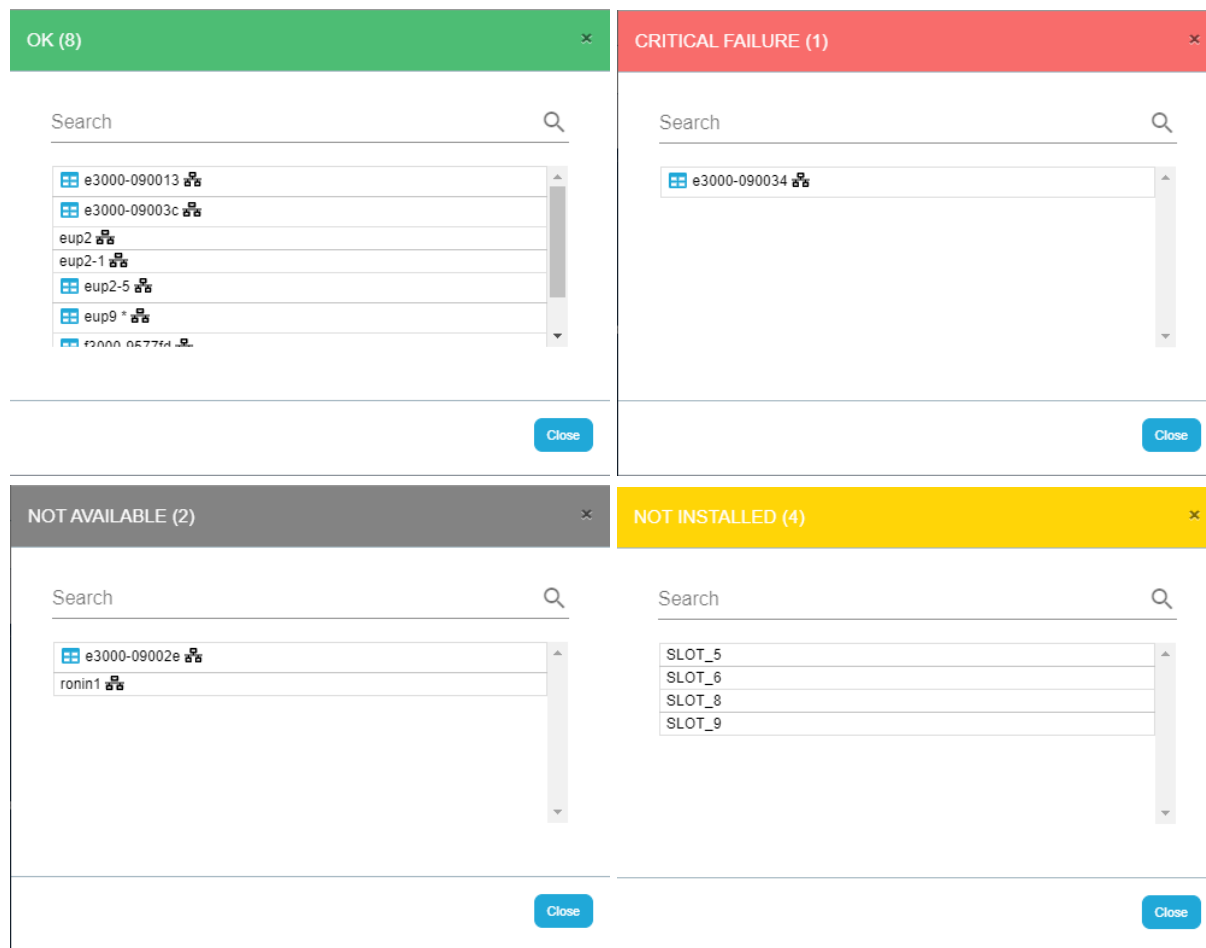


The system health view provides an overview of the health of the fabric network. All of the devices on the fabric are queried when the page loads, and this view is updated. If there are fabric devices that are flagging errors or faults, the system health view will respond accordingly. The following images demonstrate the various states that the system health pie chart can present.

**Figure 22:** System Health View States

The following states correspond to the health status definitions presented by the devices through the OCAP:

- OK
- Critical Failure
- Not Available
- Not Installed

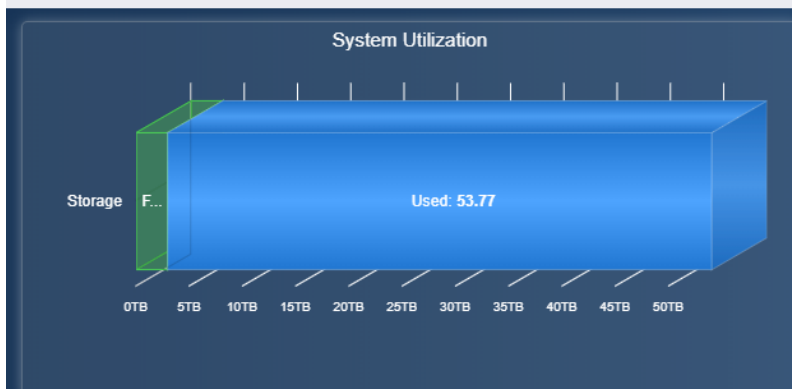


### 3.1.2.2 System Performance View

**Figure 23:** System Performance View

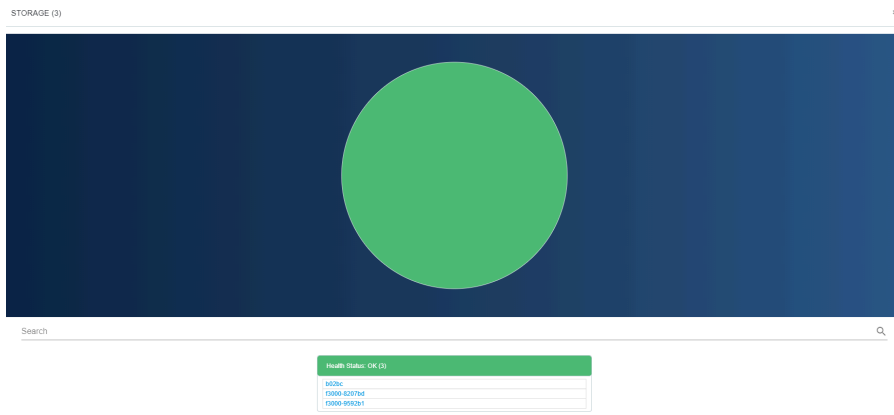
The System Performance View provides general, bitwise system performance information that relates to all devices on the fabric.

### 3.1.2.3 System Utilization View

**Figure 24:** System Utilization View

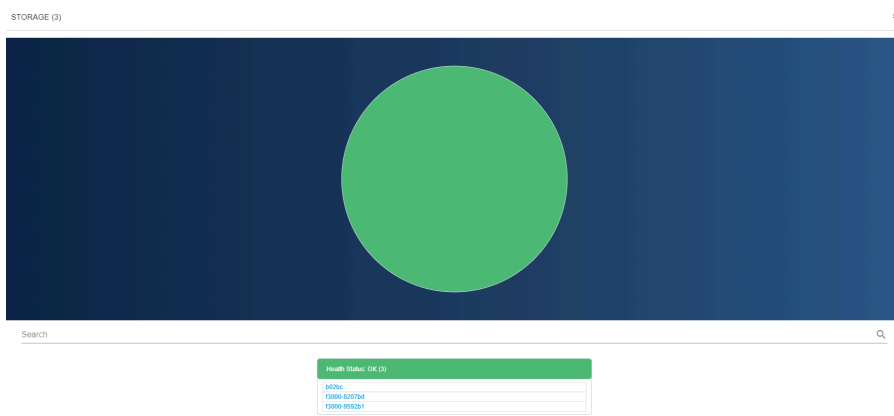
The System Utilization View displays the overall level of storage that is being used on the fabric in TB.

### 3.1.2.4 Storage Health Modal

**Figure 25:** Storage Health Modal

The storage health modal provides an overview of the health of all of the storage devices that are present on the fabric. The modal will provide separate tables for fabric devices that are presenting different health states up to the OCGUI.

### 3.1.2.5 Chassis Health Modal

**Figure 26:** Chassis Health Modal

The chassis health modal provides an overview of the health of all of the chassis devices that are present on the fabric. This status comes from the BMC module installed in the chassis. The modal will provide separate tables for fabric devices that are presenting different health states up to the OCGUI.

### 3.1.2.6 Device List



**Figure 27:** Device List

Status	Name	Version	Type
OK	b02bc * / /	0.4.0	Storage
OK	b07bc * / /	0.4.0	Storage
OK	e3000-09002e *	0.0.0	Chassis
OK	f3000-9592b1 * / /	0.4.0	Storage

The device list provides summary details about all of the devices that are present on the fabric. Users can also link to the device page for the OpenFlex device of their choosing for management purposes. Vital information such as the version of firmware code that is loaded on each device, the type of device that was discovered, and the UUID. This list will be updated with each refresh of the page as a query command is sent across the fabric network to discover OpenFlex devices.

### 3.1.3 Storage Device Page

**Figure 28:** Storage Device Page

**Western Digital**

Dashboard / Device

Apr 8th 19, 5:35:24 pm

**Device Health**

Storage

F3000-9592B1

**Device Utilization**

Used: 7.68

Pool 0: 0.00TB of 7.68TB

0.3.0

Vendor Firmware

**Device Performance**

Request Rate

Data Rate

0 Bytes/s

0 IOPS

Avg Read Latency: -- μs

Avg Write Latency: -- μs

Up Time

1 DAY 8 HOUR 55 MIN 26 SEC

Administration

Maintenance

REBOOT SHUTDOWN

FACTORY RESET INITIALIZE

Settings

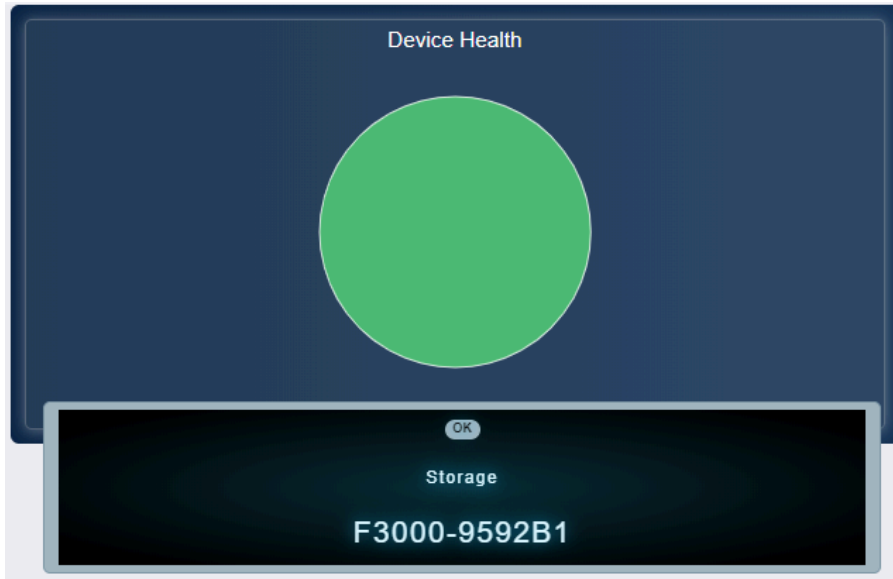
CERTIFICATE & KEY UPLOAD

© 2019 Western Digital Corporation ver 0.19.48.19.06 Powered by OpenFlex™

The storage device page presents all of the vital information related to a specific storage resource.

### 3.1.3.1 Storage Device Health Panel

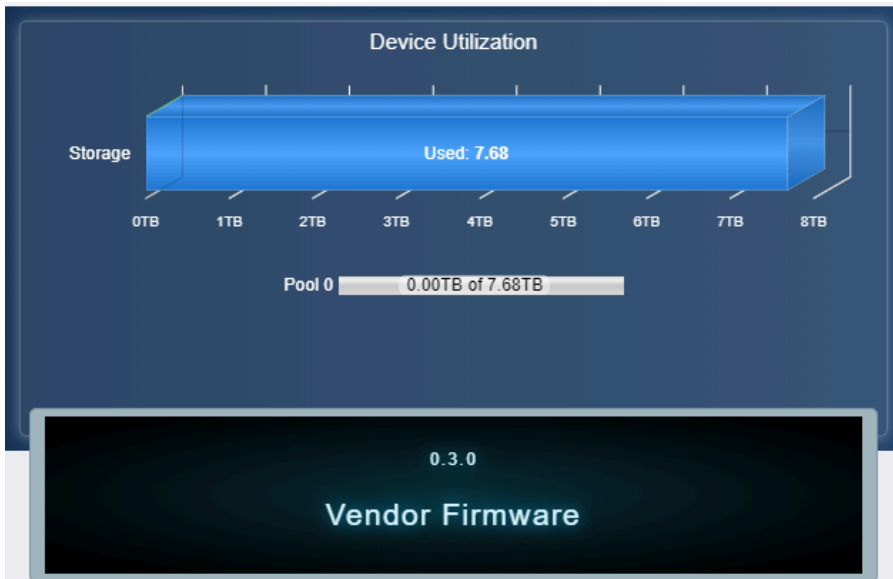
**Figure 29:** Storage Device Health Panel



The Device Health Panel shows a visual summary of the general health of devices on the network.

### 3.1.3.2 Storage Device Utilization Panel

**Figure 30:** Storage Device Utilization Panel



The Device Utilization panel provides a visual summary of the amount of storage that is available or that has been consumed on this device.

### 3.1.3.3 Storage Device Performance Panel

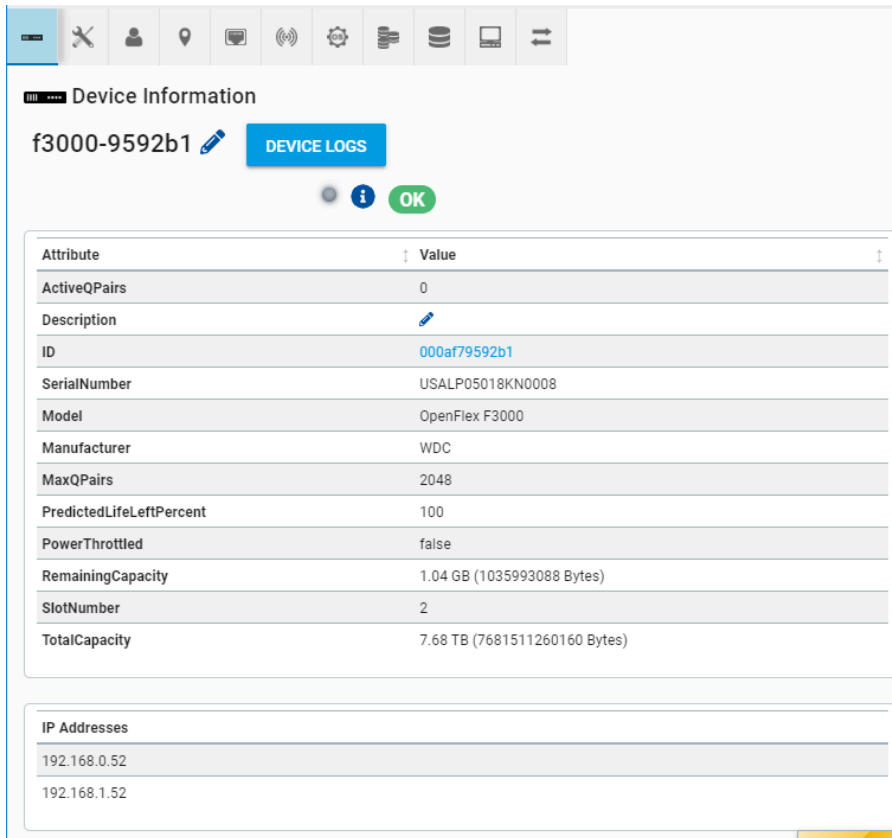
**Figure 31:** Storage Device Performance Panel



The Device Performance panel provides a visual summary of the current IO performance of the device.

### 3.1.3.4 Device Information

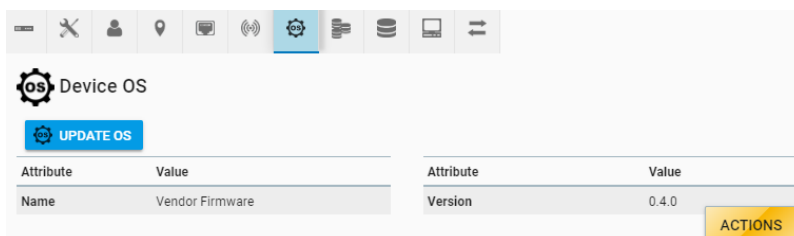
**Figure 32:** Device Information Panel - Storage



The Device Information panel provides information about the device itself, such as the ID and Serial Number, as well as performance statistics related to this device.

### 3.1.3.5 Operating System (Device Firmware)

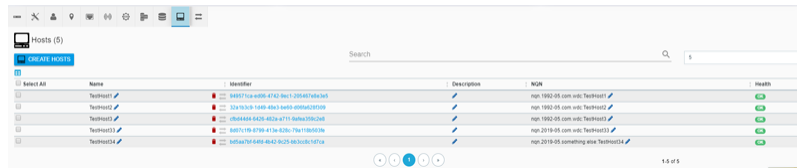
**Figure 33:** Operating System Info (Device Firmware)



The Device OS panel displays the firmware version. Use this panel to upgrade firmware.

### 3.1.3.6 Hosts

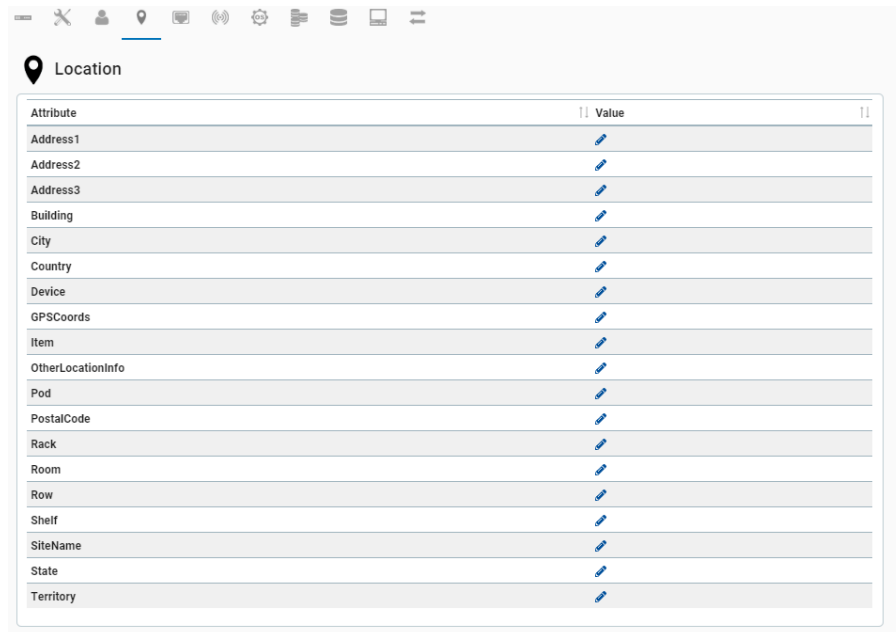
**Figure 34:** Hosts Configuration



The Hosts panel provides information on the Hosts that are available to be connected to storage and allows configuration of those hosts on the fabric.

### 3.1.3.7 Location

**Figure 35:** Location Information



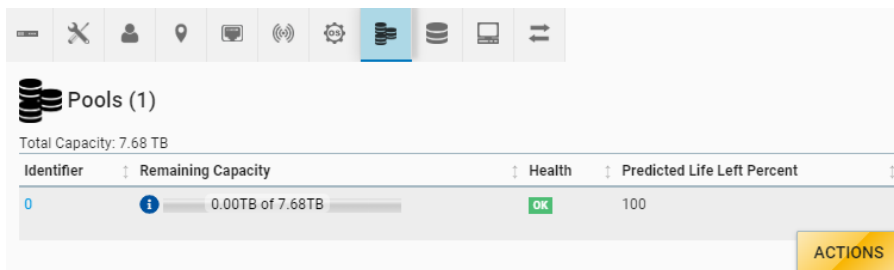
The Location panel provides information regarding the physical location of the device.

### 3.1.3.8 Paths

**Figure 36:** Paths Configuration

The Paths panel lists all of the current paths that are available to the storage volumes. Paths connect storage to hosts.

### 3.1.3.9 Pools

**Figure 37:** Pools Configuration

The Pools panel shows all of the pools that are configured on this storage device. The number of pools can be set to 1, 2, 4, or 8.

### 3.1.3.10 Ports

**Figure 38:** Ports Information (Network Settings)

The screenshot shows the 'Ports (2)' section of the OCGUI. It contains a table with the following data:

Name	Identifier	Health (Link)	MTU Bytes	TransceiverMode	IP IPv4 Address	IP Gateway	MAC Address	Addr Origin
fabric1	00_0a_f7_95_92_b1	OK Up	1500	Consortium-Based:No FEC:None	192.168.0.52/24		00:0a:f7:95:92:b1	DHC
fabric2	00_0a_f7_95_92_b2	OK Up	1500	Consortium-Based:No FEC:None	192.168.1.52/24	192.168.0.1	00:0a:f7:95:92:b2	STAT

Below the table are two configuration panels:

- DSCP-Based Priority Flow Control:** PFC is Enabled. The selected PFC Class of Service / Pause Priority is 3:24. Other options include 0:0, 1:8, 2:16, 4:32, 5:40, 6:48, and 7:56.
- Explicit Congestion Notification:** ECN is Disabled. The selected CNP Class of Service / CNP Priority is 6:48. Other options include 0:0, 1:8, 2:16, 3:24, 4:32, 5:40, and 7:56.

At the bottom, there is a 'RESET' button and an 'ACTIONS' button.

The Ports panel provides access to the networking settings for the ports that exist on the device.

### 3.1.3.11 Sensors

**Figure 39:** Sensors Information

The screenshot shows the 'Sensors (1)' section of the OCGUI. It contains a table with the following data:

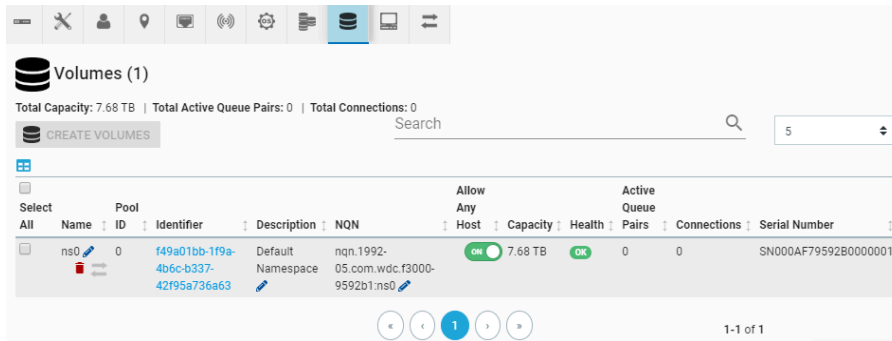
Identifier	Type	Current Reading
DeviceTemperature	Temperature	51 Degrees C

At the bottom right, there is an 'ACTIONS' button.

The Sensors panel lists all of the sensors that are present on the device hardware and reports the status readings that the sensors are taking.

### 3.1.3.12 Volumes

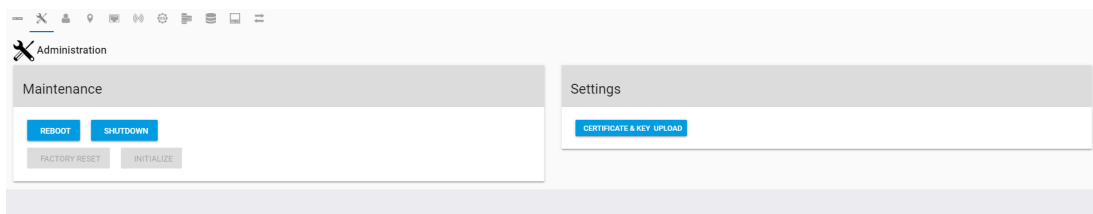
**Figure 40:** Volumes Configuration



The Volumes panel displays all of the volumes that have been configured on the device and allows for volumes to be added, modified, or deleted.

### 3.1.3.13 Administration

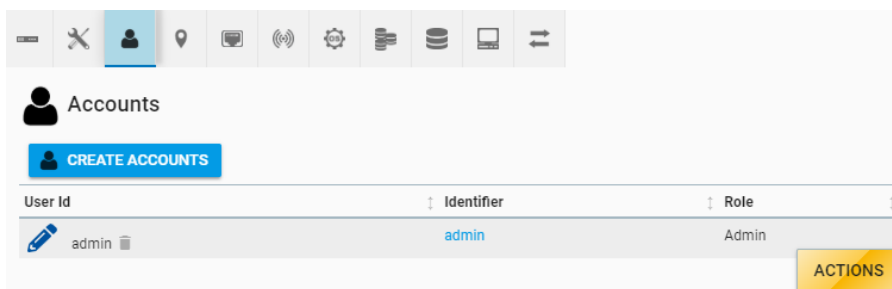
**Figure 41:** Administration



The Administration panel allows system administrators to perform important management functions to the device.

### 3.1.3.14 Accounts

**Figure 42:** Account Information

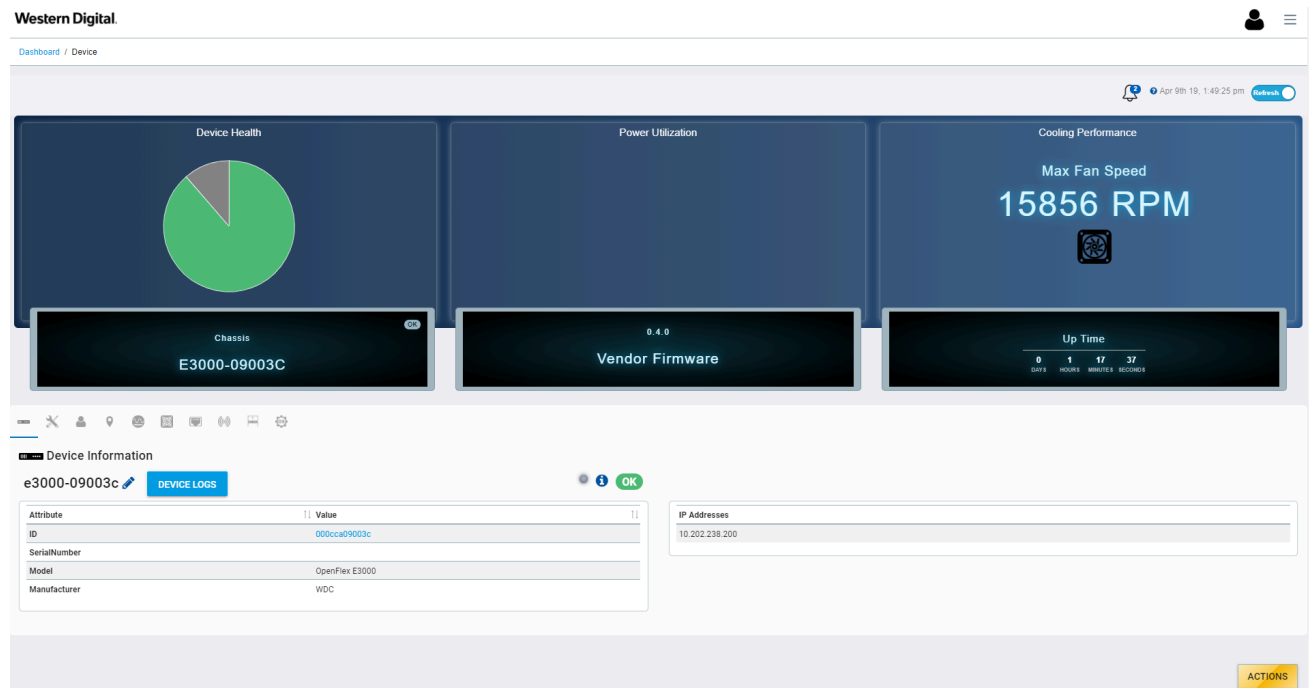


The Accounts panel provides a list of all the accounts that can access this device.

## 3.1.4 Chassis Device Page



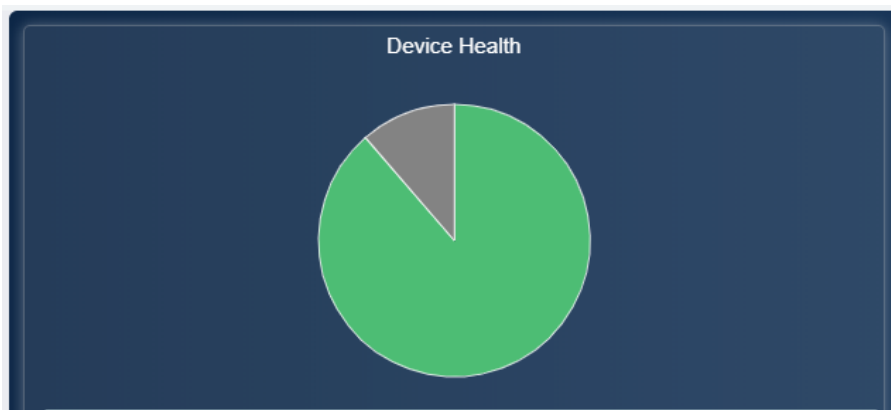
**Figure 43:** Chassis Device Page



The chassis device page presents all of the vital information related to a specific chassis resource.

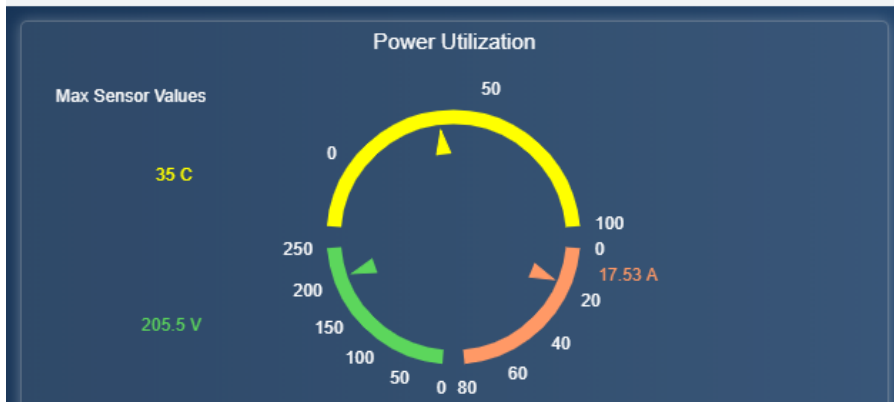
### 3.1.4.1 Chassis Device Health Panel

**Figure 44:** Device Health Panel



This Device Health Panel shows a visual summary of the general health of devices on the network.

### 3.1.4.2 Chassis Device Power Utilization

**Figure 45:** Chassis Device Power Utilization

The Power Utilization Panel gives a summary of the sensor data that is being reported by the power supplies. Charts displays the current amps and volts being consumed by the system, as well as the temperature.

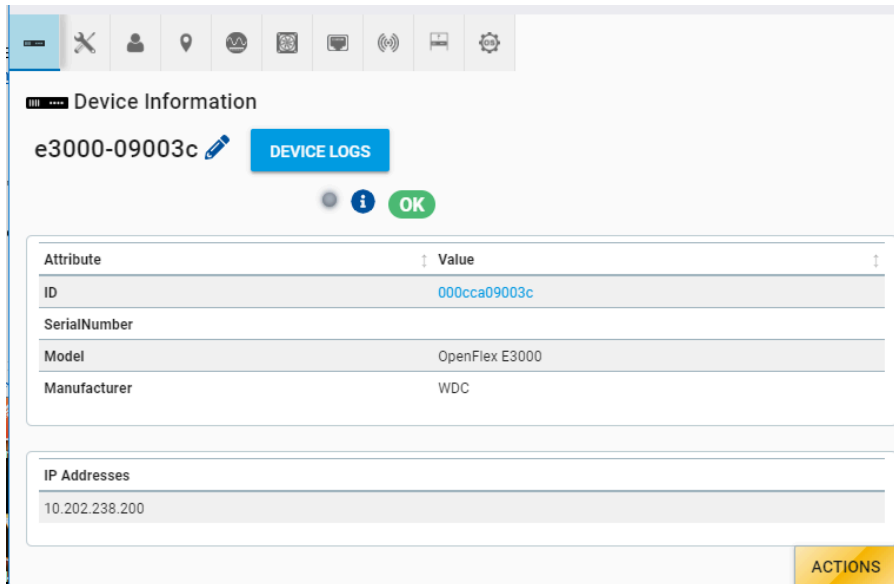
### 3.1.4.3 Chassis Device Performance

**Figure 46:** Chassis Device Cooling Performance

The cooling performance panel displays the current RPMs at which the onboard cooling fans are operating.

### 3.1.4.4 Device Information

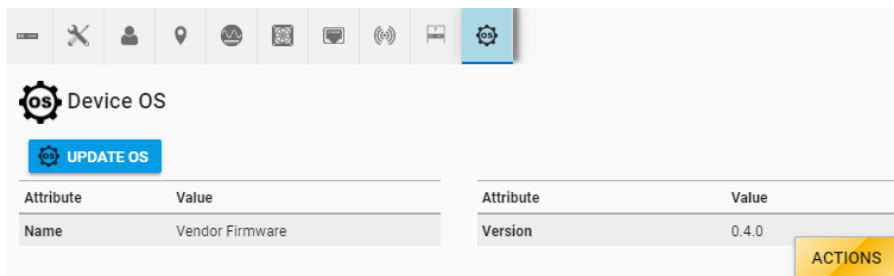
**Figure 47:** Chassis Device Information



The Device Information panel provides information about the device itself, such as the ID and Serial Number.

### 3.1.4.5 Operating System (Device Firmware)

**Figure 48:** Operating System (Device Firmware)



The Device OS panel displays the firmware version. Use this panel to upgrade firmware.

### 3.1.4.6 Fans

**Figure 49:** Chassis Fan Information

Identifier	Current Speed	Health	Locator LED	Removal Conditions
FAN_ENCL_0	11952 RPM	OK	●	Removable when on or off
FAN_ENCL_1	11184 RPM	OK	●	Removable when on or off
FAN_ENCL_2	11952 RPM	OK	●	Removable when on or off
FAN_ENCL_3	11152 RPM	OK	●	Removable when on or off
FAN_ENCL_4	11664 RPM	OK	●	Removable when on or off
FAN_ENCL_5	10976 RPM	OK	●	Removable when on or off
FAN_ENCL_6	11904 RPM	OK	●	Removable when on or off
FAN_ENCL_7	11024 RPM	OK	●	Removable when on or off
FAN_PSU_A	864 RPM	OK	●	Removable when on or off
FAN_PSU_B	928 RPM	OK	●	Removable when on or off

The fans panel shows that status and health of all of the fans installed in the device.

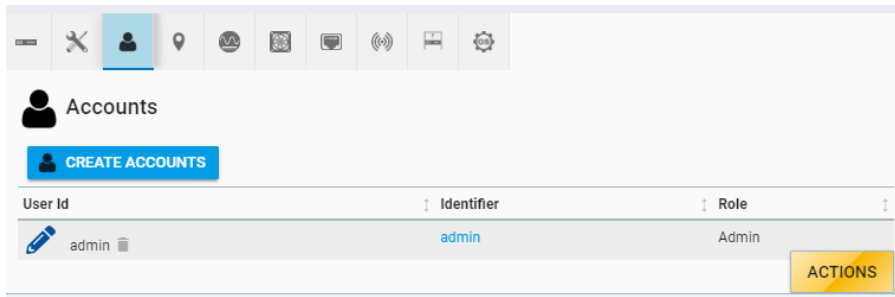
### 3.1.4.7 Admin

**Figure 50:** Administration Panel

The Administration panel provides access to maintenance and system administration functions.

### 3.1.4.8 Accounts

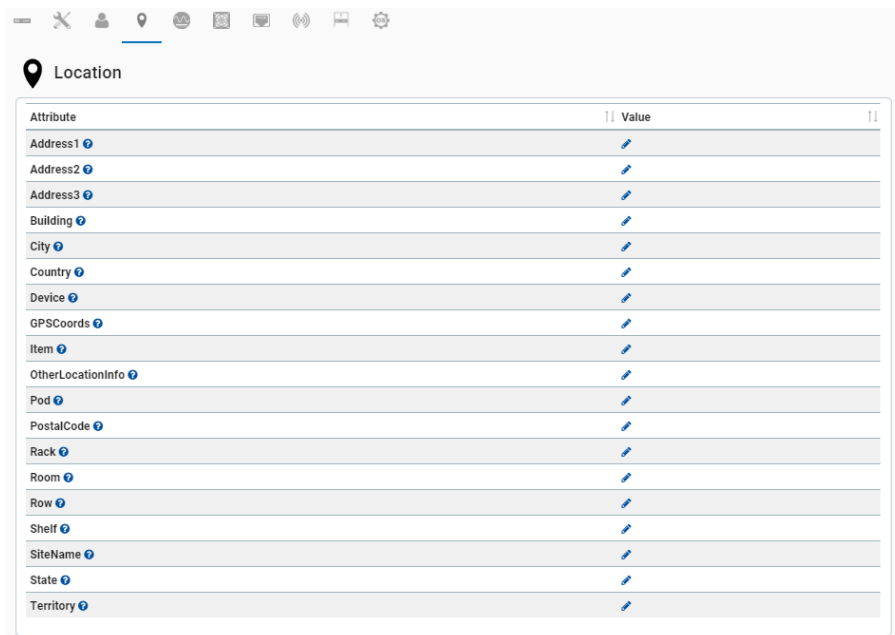
**Figure 51:** Account Configuration



The Accounts panel provides a list of all the accounts that can access this device.

### 3.1.4.9 Location

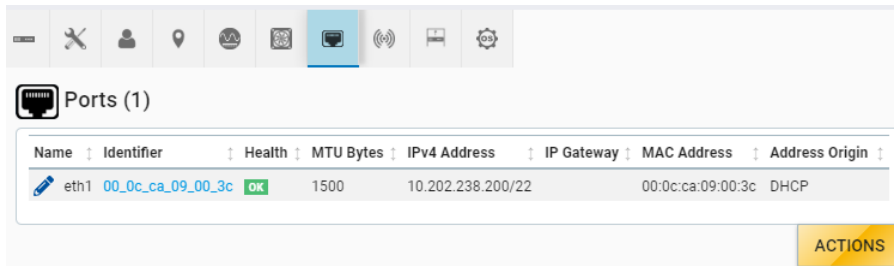
**Figure 52:** Location Information



The Location panel provides information regarding the physical location of the device.

### 3.1.4.10 Ports

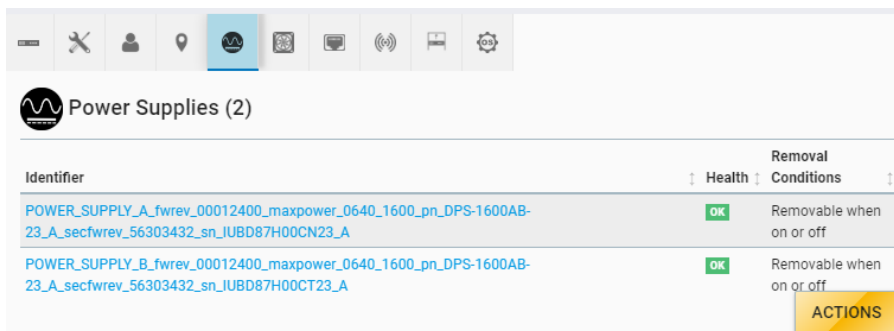
**Figure 53:** Chassis Ports Configuration



The Ports panel provides access to the networking settings for the ports that exist on the device.

### 3.1.4.11 PSUs

**Figure 54:** Chassis Power Supplies Information



The Power Supplies panel provides health and status information of the power supplies installed in the device.

### 3.1.4.12 Slots

**Figure 55:** Chassis Slots Information

Identifier	Health	Locator LED
BLANK_0	Slot disabled	
DEVICE_1_sn_THCLS04614PS0193	OK	
BLANK_2	Slot disabled	
SLOT_3	Not installed	
DEVICE_4_sn_THCLS04614PS0193	OK	
DEVICE_5	OK	
DEVICE_6	OK	
BLANK_7	Slot disabled	
BLANK_8	Slot disabled	
BLANK_9	Slot disabled	

The Slots panel gives information on the devices that are installed in each slot.

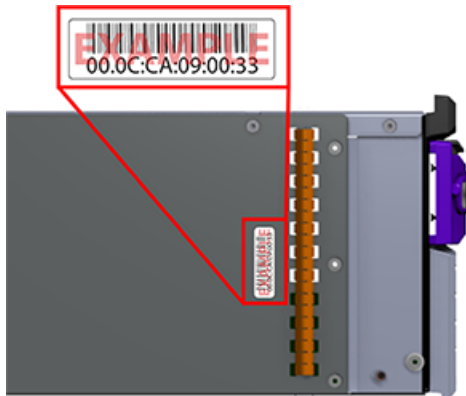
## 3.1.5 Basic Operational Functions

For the OpenFlex F3100 and E3000, the basic operational functions are the tasks needed to begin the initial operation of the system, e.g. check system health, create a user account, etc.

### 3.1.5.1 Navigating to a Device Using the OCGUI

This task provides instructions for using the OCGUI to navigate to a device's dashboard through any other fabric-connected device.

The BMC's MAC address is listed on a label affixed to the module's side. This MAC address can be used to determine the IP addresses assigned via DHCP to the OpenFlex™ E3000 chassis and the F3100 storage devices contained within it.

**Figure 56:** BMC Module MAC Address Label

**Step 1:** Open a browser and enter the IP address for any fabric-connected device into the **address bar**.

The login page for the device appears.

**Step 2:** Enter a valid username and password, and click the **Login** button.



The device's dashboard appears. In addition, the **Devices** banner provides access to all other fabric-connected devices.





**Step 3:** Click the **Devices** banner to view a list of all connected devices:

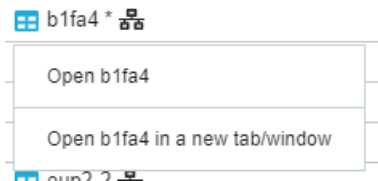


**Step 4:** Locate the new device in the list.

**Step 5:** Click the **Device Actions** icon:



**Step 6:** Click the **Open in a new tab/window** option to open the device page in a new window. This will keep the existing dashboard live in the current window.



The new device's dashboard appears.

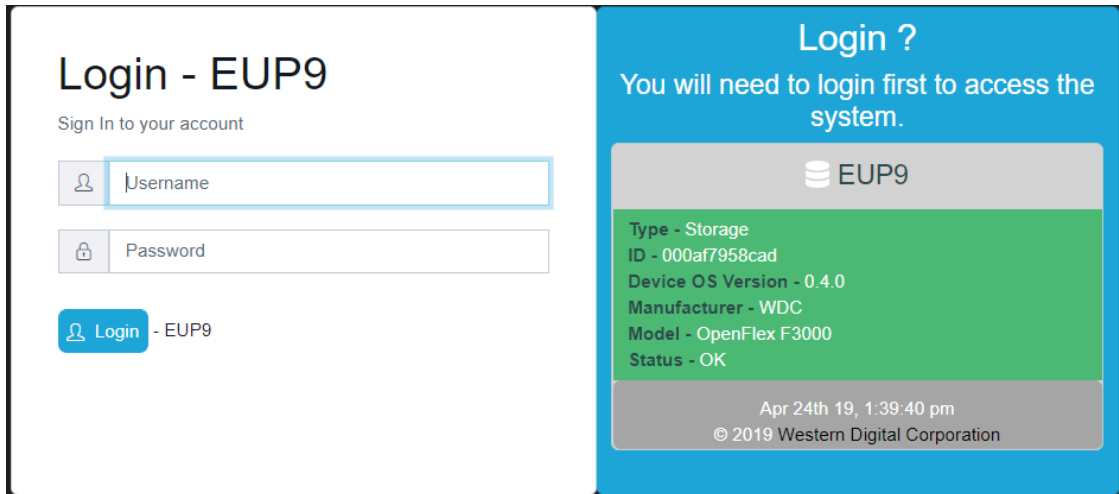
### 3.1.5.2 Checking System Health Using the OCGUI

This task provides steps that should be followed to check the health of the system and system components using the OCGUI.

This health check will cover the following:

- Device Information
- Device Logs
- PSUs
- Fans
- Ports
- Sensors
- Slots

**Step 1:** Enter a valid username and password, and click the **Login** button:



**Note:** The default username/password is admin/admin.

The system dashboard appears:



**Step 2:** Click the **Devices** banner to view a list of all connected devices:

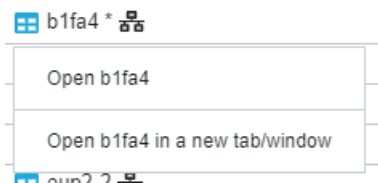


**Step 3:** Locate the system that will be checked for health status in the list.

**Step 4:** Click the **Device Actions** icon:

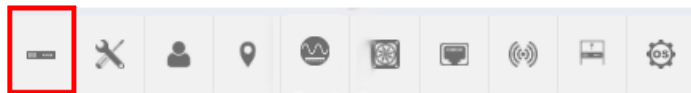


**Step 5:** Click the **Open in a new tab/window** option to open the device page in a new window. This will keep the existing dashboard live in the current window.



The new device's dashboard appears.

**Step 6:** Click the **Device Information** icon:

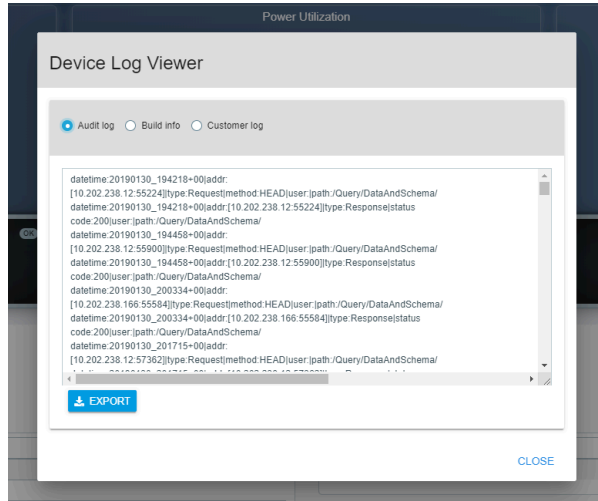


**Step 7:** After clicking device information, the status of device will appear at the bottom of the GUI. Review the health information related to the devices.

**Step 8:** Click the **Device Logs** button:



**Step 9:** Select one of the logs by clicking the radio button next to an option in the Device Log Viewer. The log can be exported by clicking export at the bottom of the viewer.



**Step 10:** Click the **Power Supplies** icon:



**Step 11:** After clicking power supplies, the status of power supplies will appear at the bottom of the GUI. Review the health information related to each of the power supplies.

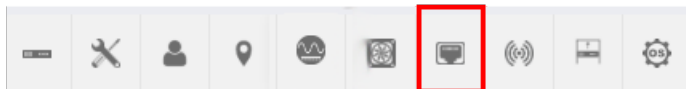
Power Supplies (2)		Health	Removal Conditions
Identifier			
POWER_SUPPLY_A_fwrev_00012400_maxpower_0640_1600_pn_DPS-1600AB-23_A_secfwrev_56303432_sn_IUBD87H00CN23_A		OK	Removable when on or off
POWER_SUPPLY_B_fwrev_00012400_maxpower_0640_1600_pn_DPS-1600AB-23_A_secfwrev_56303432_sn_IUBD87H00CT23_A		OK	Removable when on or off

**Step 12:** Click the **Fans** icon:



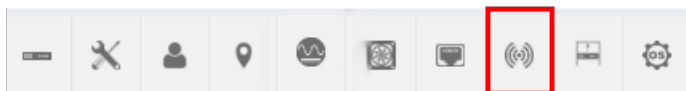
**Step 13:** After clicking fans, the status of fans will appear at the bottom of the GUI. Review the health information related to each of the fans. If there is an issue reported on a fan, the physical LED may be turned on by clicking the Locator LED next to the fan health column.

**Step 14:** Click the **Ports** icon:



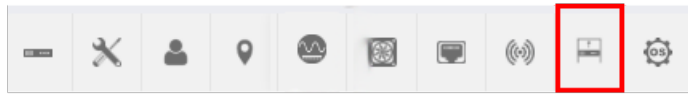
**Step 15:** After clicking ports, the status of ports will appear at the bottom of the GUI. Review the health information related to each of the ports.

**Step 16:** Click the **Sensors** icon:



**Step 17:** After clicking sensors, the status of sensor will appear at the bottom of the GUI. Review the health information related to each of the sensors. Each of the sensors reports a current reading related to temperature, volts, or amps.

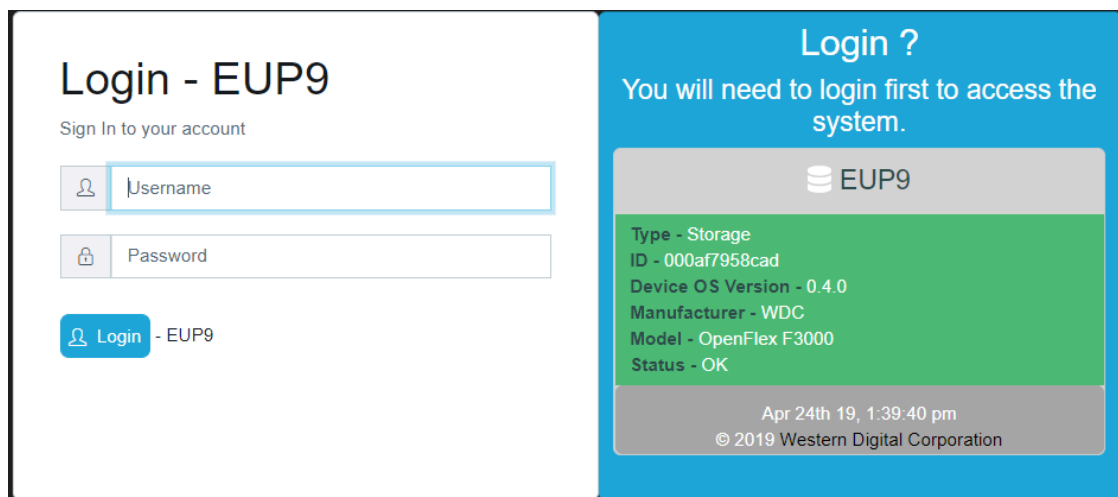
**Step 18:** Click the **Slots** icon:



**Step 19:** After clicking slots, the health status of the slot the will appear above the top right corner of the device table.

### 3.1.5.3 Establishing a Location Using the OCGUI

**Step 1:** Enter a valid username and password, and click the **Login** button:



**Note:** The default username/password is admin/admin.

The system dashboard appears:



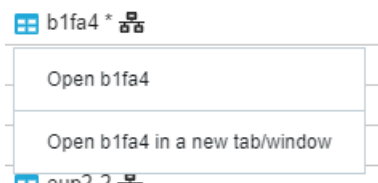
**Step 2:** Click the **Devices** banner to view a list of all connected devices:



**Step 3:** Click the **Device Actions** icon:

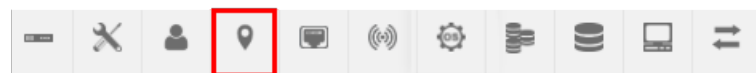


**Step 4:** Click the **Open in a new tab/window** option to open the device page in a new window. This will keep the existing dashboard live in the current window.

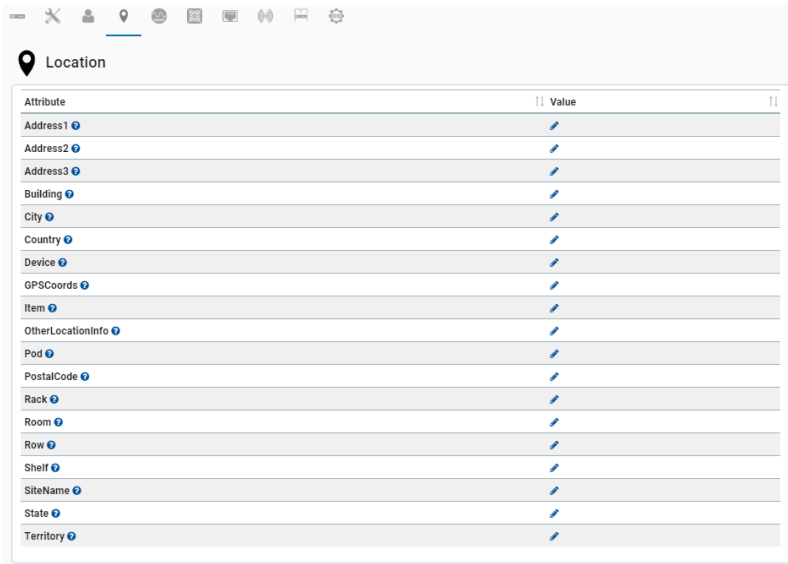


The new device's dashboard appears.

**Step 5:** Click the **Location** icon:



**Step 6:** After clicking location, the location information related to the device will appear at the bottom of the GUI. Each attribute can be assigned a value by clicking the pencil button and adding text to the field and clicking the check mark to save the value. Complete all of the values that apply.



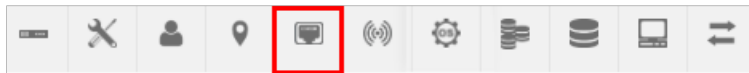
Attribute	Value
Address1	
Address2	
Address3	
Building	
City	
Country	
Device	
GPSCoords	
Item	
OtherLocationInfo	
Pod	
PostalCode	
Rack	
Room	
Row	
Shelf	
SiteName	
State	
Territory	

#### 3.1.5.4 Editing Port Information Using the OCGUI

This task provides instructions for editing the port information of a device using the OCGUI.

**Step 1:** Navigate to the device's dashboard.

**Step 2:** Click the **Ports** icon:



The device's port information appears:

**Ports (2)**

Name	Identifier	Health (Link)	MTU Bytes	TransceiverMode	IPv4 Address	IP Gateway	MAC Address	Addr Origin
fabric1	00_0a_f7_95_92_b1	OK Up	1500	Consortium- Based:No FEC:None	192.168.0.52/24		00:0a:f7:95:92:b1	DHC
fabric2	00_0a_f7_95_92_b2	OK Up	1500	Consortium- Based:No FEC:None	192.168.1.52/24	192.168.0.1	00:0a:f7:95:92:b2	STAT

**DSCP-Based Priority Flow Control**

PFC  Enabled

PFC Class of Service / Pause Priority : DSCP Value

0:0  
  1:8  
  2:16  
  3:24  
  4:32  
 5:40  
  6:48  
  7:56

**Explicit Congestion Notification**

ECN  Disabled

CNP Class of Service / CNP Priority : DSCP Value

0:0  
  1:8  
  2:16  
  3:24  
  4:32  
 5:40  
  6:48  
  7:56

← RESET ?
ACTIONS

**Step 3:** Click on the **Pencil** icon to edit the port information for a device on the list. The first **Update Port: management** window appears.



### Update Port: management

1 Address Type, IP, MTUBytes ————— 2 Confirmation

DHCP

IP Address / CIDR ? !  
10.202.238.142/22  
-----  
nnn.nnn.nnn.nnn(/nn)  
Netmask: 255.255.252.0

MTU Bytes ?  
1500  
Range: 60-9216 (Default: 1500)

IP Gateway (optional) ?  
-----  
nnn.nnn.nnn.nnn

Unknown ?

**NEXT**

[CANCEL](#)

**Step 4:** Edit the port information for the device and click the **Next** button.

**NEXT**

The second **Update Port: management** window appears.

### Update Port: management

1 Address Type, IP, MTUBytes ————— 2 Confirmation

Address Origin: DHCP

Please Confirm

UPDATE    BACK    START OVER

CANCEL

**Step 5:** Select the **checkbox** to confirm the edits.

### Update Port: management

1 Address Type, IP, MTUBytes ————— 2 Confirmation

Address Origin: DHCP

Please Confirm

**UPDATE** **BACK** **START OVER**

[CANCEL](#)

**Step 6:** Click the **Update** button to save the updates.



### 3.1.5.5 Creating Accounts Using the OCGUI

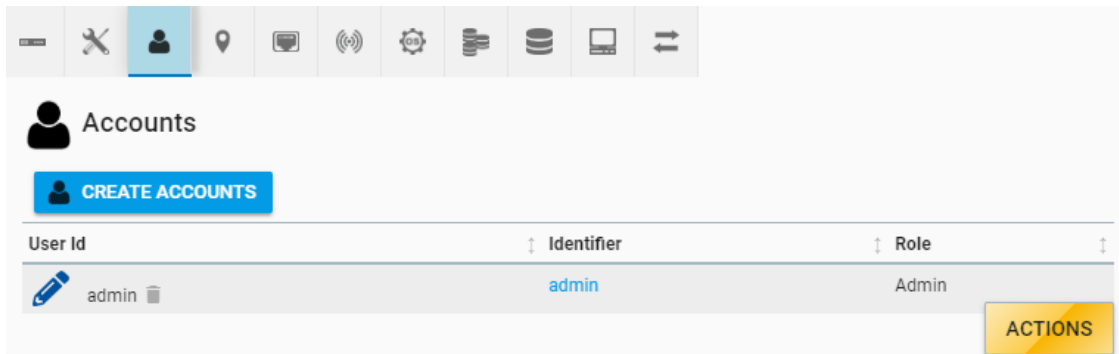
This task provides instructions for creating a user account for a device using the OCGUI.

**Step 1:** Navigate to the device's dashboard.

**Step 2:** Click the **Accounts** icon:



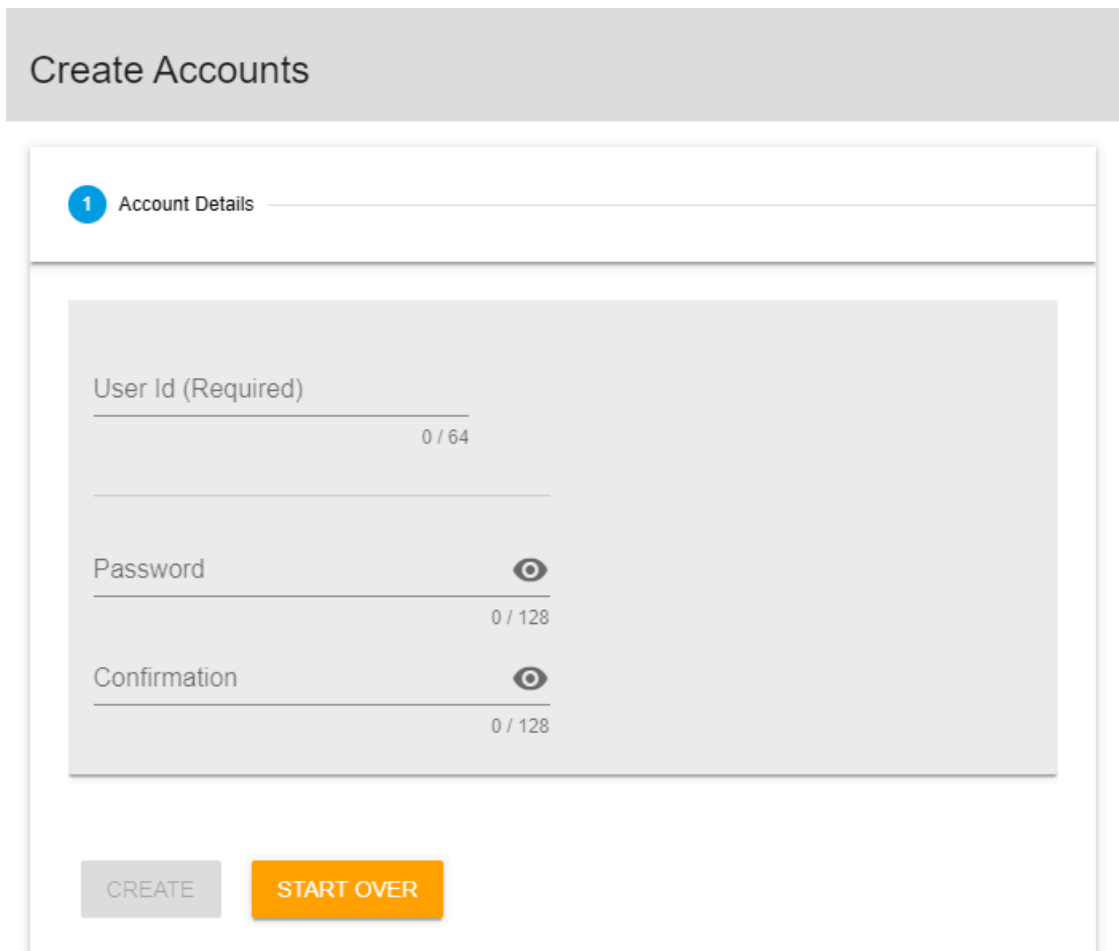
The device's account information appears:



**Step 3:** Click the **Create Accounts** button:



The **Create Accounts** window appears:




[CLOSE](#)


**Step 4:** Enter an ID in the **User ID** field and a password in both the **Password** and **Confirmation** fields.

## Create Accounts

1 Account Details

User Id (Required)  
test  
4 / 64

Password  
.... X   
4 / 128

Confirmation  
.... X   
4 / 128

[CREATE](#) [START OVER](#)

[CLOSE](#)

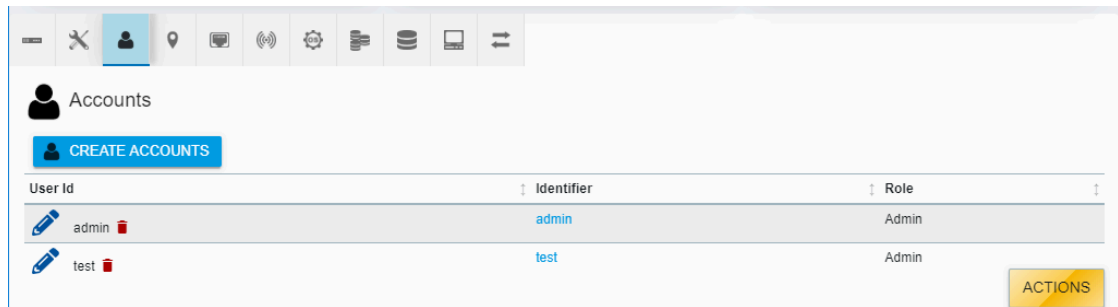
**Step 5:** Click the **Create** button to create the account.

[CREATE](#)

**Step 6:** Click **Close** to close the **Create Accounts** window.

[CLOSE](#)

The device's account information appears, showing the newly created account.

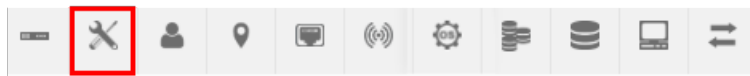


### 3.1.5.6 Creating a Secure HTTPS Connection Using the OCGUI

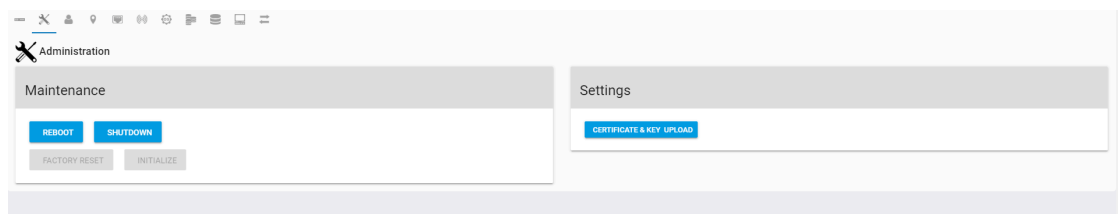
The OCGUI provides a feature for uploading a customer-generated SSL/TLS certificate and key, based on the IP address and/or DNS name, to create a fully-secure HTTPS connection to a device.

**Step 1:** Navigate to the device's dashboard.

**Step 2:** Click the **Administration** icon:



The device's administration information appears:



**Step 3:** Click the **Certificate & Key Upload** button:



The **TLS Certificate & Key Pair** window appears:

### TLS Certificate & Key Pair

1 Browse & Select Certificate & Key Pair ————— 2 Upload TLS Certificate & Key Pair

**SELECT FILE** Certificate File

**SELECT FILE** Key File

NEXT

CLOSE

**Step 4:** Click the **Select File** button:

**SELECT FILE**

**Step 5:** Navigate to the location of the appropriate PEM files for the **Certificate File** and **Key File** fields.



**Note:** The files are not validated. It is up to the user to ensure that the correct file is chosen for the appropriate field. If the chosen files are not valid, the OCGUI will reuse the defaults already on the system.

## TLS Certificate &amp; Key Pair

1 Browse & Select Certificate & Key Pair ————— 2 Upload TLS Certificate & Key Pair

<a href="#">SELECT FILE</a>	Certificate File cert.pem	0.81 KB
Certificate File Staged Successfully; Ready for Upload		
<a href="#">SELECT FILE</a>	Key File key.pem	0.23 KB
Key File Staged Successfully; Ready for Upload		

[NEXT](#)

[CLOSE](#)

**Step 6:** Click the **Next** button:

[NEXT](#)

The **TLS Certificate & Key Pair** confirmation window appears:



### TLS Certificate & Key Pair

✓ Browse & Select Certificate & Key Pair
 2 Upload TLS Certificate & Key Pair

Certificate: cert.pem  
Key: key.pem

Please Confirm

UPLOAD CERTIFICATE & KEY

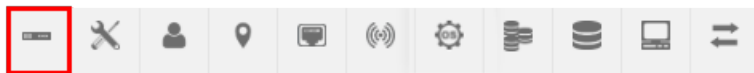
BACK
START OVER

CLOSE

**Step 7:** Confirm that the correct files are listed for **Certificate** and **Key**. If so, select the **Please Confirm** checkbox and click the **Upload Certificate & Key** button.

The **TLS Certificate & Key Pair** confirmation window closes, and the device's dashboard appears.

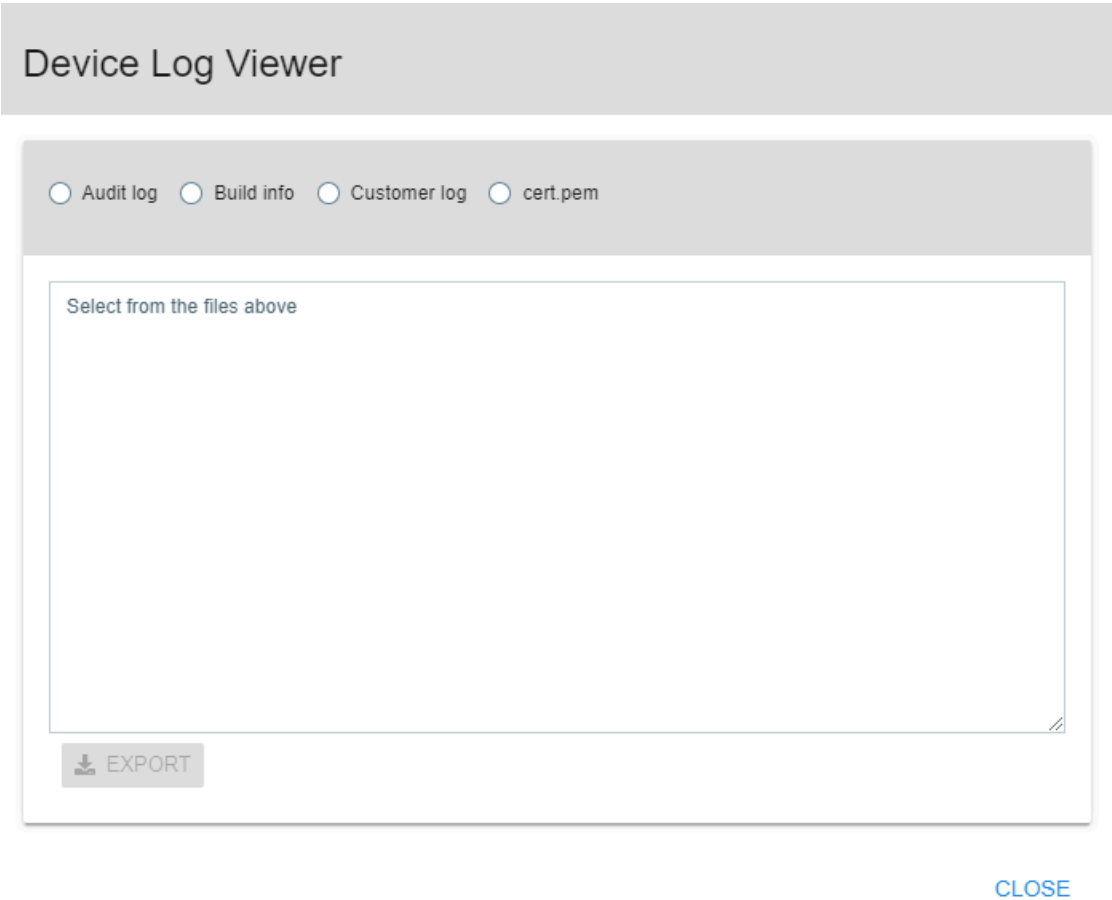
**Step 8:** Click the **Device Info** icon:



**Step 9:** Click the **Device Logs** button:



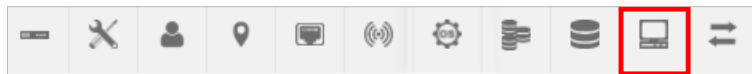
**Step 10:** Confirm that the chosen certificate file is one of the selectable options listed in the **Device Log Viewer** window.



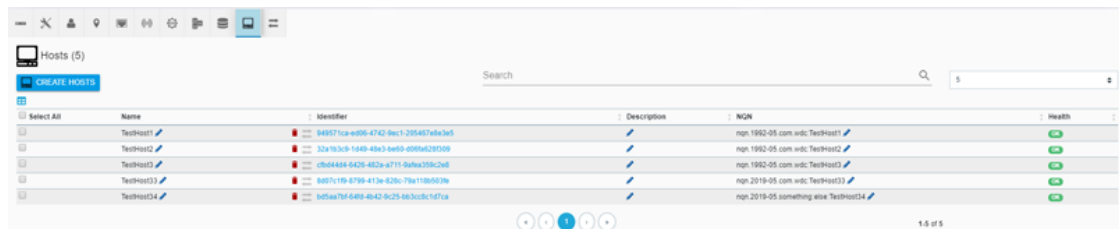
### 3.1.5.7 Configuring a Host Using the OCGUI

This task provides instructions for configuring a host using the OCGUI.

- Step 1:** Navigate to the device's dashboard (see [Navigating to a Device Using the OCGUI](#) (page 49)).
- Step 2:** Click the **Hosts** icon:



The storage device's **Hosts** page appears:



**Step 3:** Click the **Create Hosts** button:



The **Create Hosts** dialog box appears:

## Create Hosts

1 Name & Description2 Confirmation

Host Name <span style="float: right;">0 / 32</span>	NQN (Optional) <span style="float: right;">0 / 223</span> <small>nqn.YYYY-MM.com.company:text</small>
Description <span style="float: right;">0 / 256</span>	

NEXT

[CLOSE](#)

**Step 4:** In the **Host Name** and **Description** fields, type a name and description for the host.

**Step 5:** Click the **Next** button:



The **Confirmation** step of the **Create Hosts** dialog appears:

**Create Hosts**

1 Name & Description ————— 2 Confirmation

Name: test  
Description: test

Please Confirm

CREATE BACK START OVER

CLOSE

**Step 6:** Click the checkbox next to **Please Confirm**, and then click the **Create** button:



The newly created host will appear in the list on the device's **Hosts** page.

### 3.1.5.8 Configuring a Path Using the OCGUI

This task provides instructions for configuring a Path between a Host and Volume using the OCGUI.



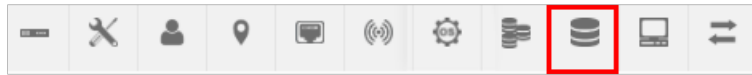
**Note:** A Path is a dedicated line of communications between a Host and a Volume, which cannot be established until both the Host and Volume have been created.



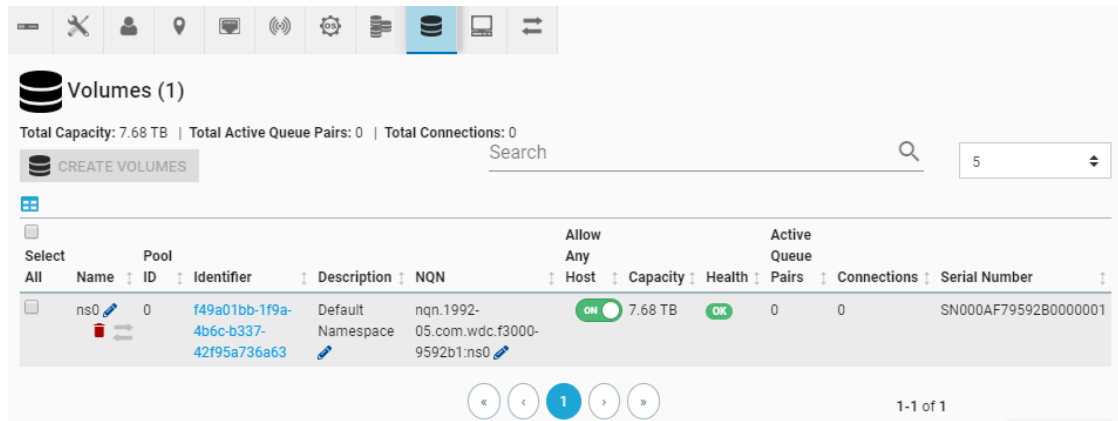
**Note:** The following instructions define how to create a Path to a Host through the device's **Volumes** page. That same path may also be created from the other direction—to a Volume through the device's **Hosts** page.

**Step 1:** Navigate to the device's dashboard (see [Navigating to a Device Using the OCGUI](#) (page 49)).

**Step 2:** Click the **Volumes** icon:



The storage device's **Volumes** page appears:



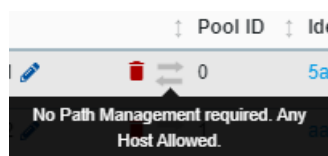
**Step 3:** From the list of available volumes, identify the one that will be used to create the path.

If that volume has been configured to allow any host, a dedicated path cannot be established between it and a specific host. If this is the case, it will be indicated by the following:

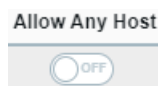
- The **Allow Any Host** setting will be toggled to the **ON** (enabled) position:



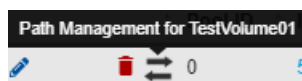
- The path arrows beside the **Pool ID** will be grayed-out, and when the user hovers over them, the tooltip will indicate that any host is allowed:



**Step 4:** Disable the **Allow Any Host** setting for that volume by clicking the on/off toggle switch:



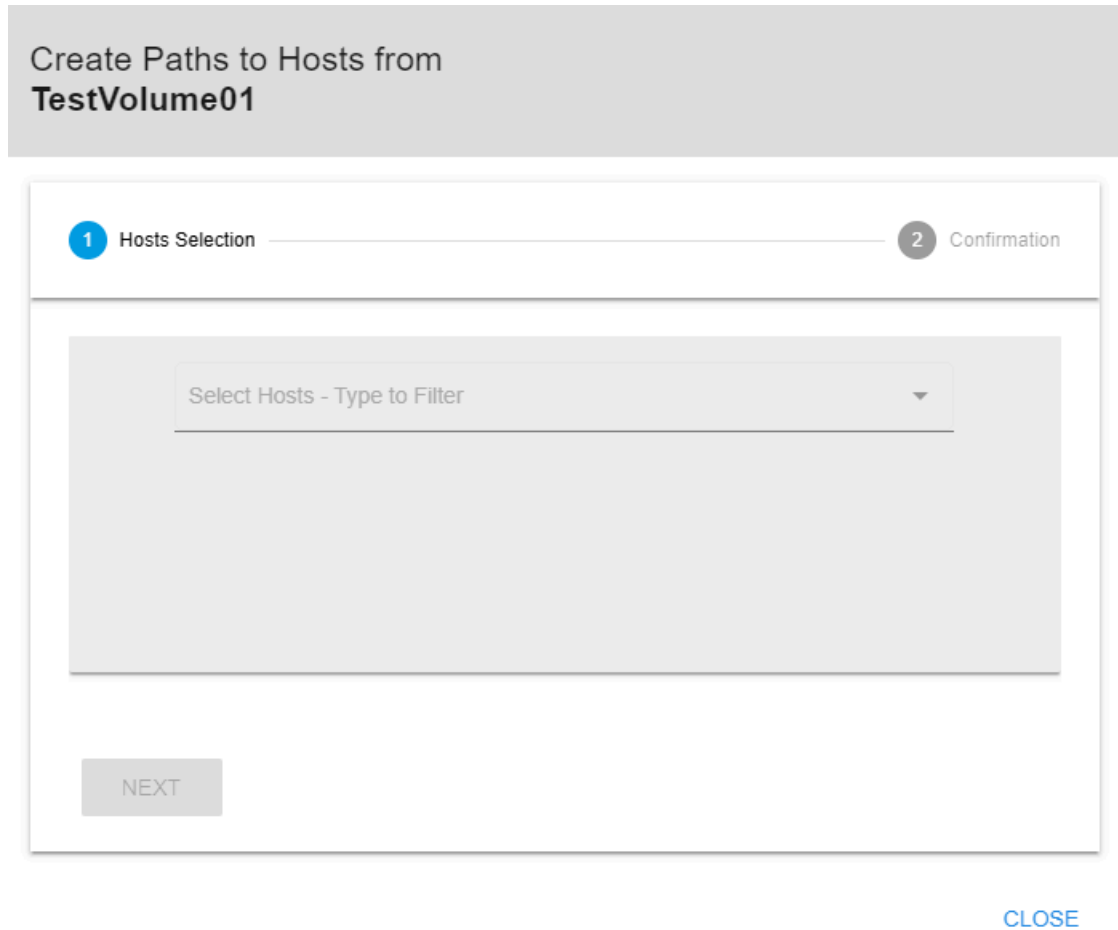
The path arrows beside the **Pool ID** will turn black, and when the user hovers over them, the tooltip will indicate that path management is now available:



**Step 5:** Click the path arrows beside the **Pool ID**:



The **Create Paths to Hosts** dialog box opens, displaying the **Hosts Selection** step:



**Step 6:** From the **Select Hosts** drop-down list, select one or more hosts to be connected to this volume. Then click the **Next** button:



The **Confirmation** step appears, displaying the chosen host(s):

## Create Paths to Hosts from TestVolume01

1 Hosts Selection ————— 2 Confirmation

These hosts will be mapped to "TestVolume01"

TestHost1: 949571ca-ed06-4742-9ec1-205467e8e3e5

Please Confirm

MAP HOSTS    BACK    START OVER

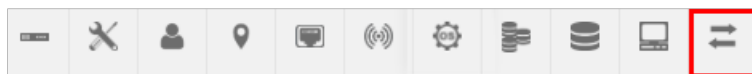
CLOSE

**Step 7:** Select the checkbox beside **Please Confirm**, and then click the **Map Hosts** button:

MAP HOSTS

A dedicated path between the selected volume and host(s) is created.

**Step 8:** To verify that the path was created, click the **Paths** icon:



The device's **Paths** page appears:



**Step 9:** Review the listed paths to identify the one referencing the previously selected volume and host(s); the names and NQNs will be listed under the **Volume NQN** and **Host NQN** columns.

## 3.1.6 Power Cycling

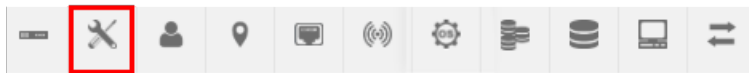
For the OpenFlex F3100 and E3000, power cycling is accomplished by powering-off an individual storage device from its **Administration** page in the OCGUI. Once powered-off, the storage device is no longer responsive, and must be powered-on from the **Slots** page of the chassis that encloses the storage device.

### 3.1.6.1 Power Cycling a Storage Device Using the OCGUI

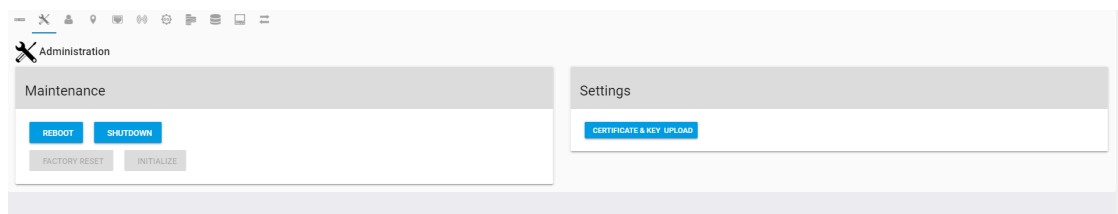
This task provides instructions for power cycling a storage device using the OCGUI.

**Step 1:** Navigate to the device's dashboard.

**Step 2:** Click the **Administration** icon:



The device's administration information appears:

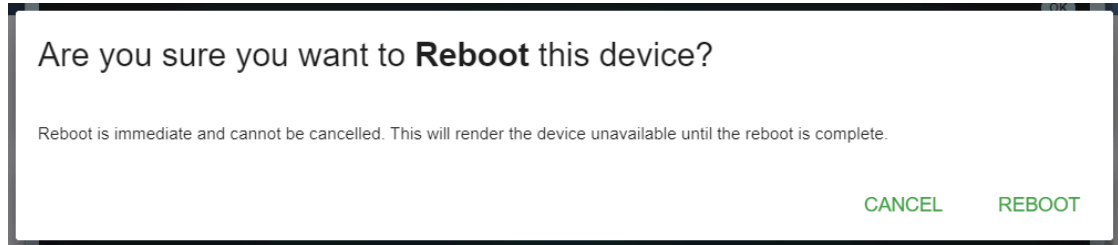


**Step 3:** Click the **Reboot** button:



**Step 4:** Click **Reboot**:





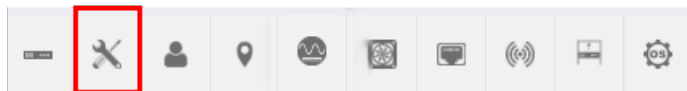
**Step 5:** The Device will reboot and the connection to the device will be lost until the reboot is complete.

### 3.1.6.2 Power Cycling a Chassis Device Using the OCGUI

This task provides instructions for power cycling a chassis device using the OCGUI.

**Step 1:** Navigate to the device's dashboard.

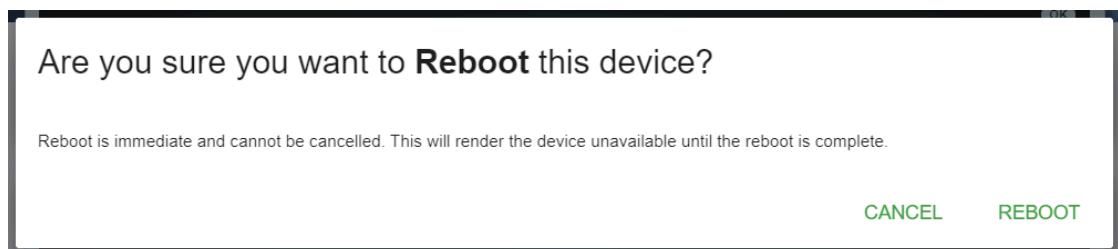
**Step 2:** Click the **Administration** icon:



**Step 3:** Click the **Reboot** button:



**Step 4:** Click **Reboot**:



**Step 5:** The chassis device will reboot and the connection to the chassis device will be lost until the reboot is complete. When the chassis device is being rebooted the installed devices will remain functional.

## 3.1.7 Firmware Upgrade

### 3.1.7.1 Upgrading Device Firmware Using the OCGUI

This task provides steps that should be followed to upgrade the firmware of devices using the OCGUI.

**Step 1:** Open a web browser and go to: <https://portal.wdc.com/Support/s/>.

The Western Digital Enterprise Support Center will appear.

**Step 2:** Log in to the Western Digital enterprise support center using a Email and password.

You will be logged into the Western Digital Enterprise Support Center and several support options will appear on the page.

**Figure 82:** Logged into the Western Digital Enterprise Support Center

Sign in to  
SUPPORT PORTAL

The screenshot shows a login interface with two input fields: 'Email' and 'Password'. Below these fields is a prominent blue button labeled 'LOGIN'.

**Step 3:** Click the **Downloads** option.

The Western Digital downloads page will appear.

**Step 4:** Locate and download the firmware update for your product.

- a. From the Identify Product section, select the Product, Operating System / Type, and Release Version.

**Figure 83:** Identify Product section

The screenshot displays the 'Identify Product' section with three numbered steps: 1. Identify Product, 2. Select Files for Download, and 3. Review & Download Files. Under 'Pick Product Options', there are three dropdown menus: 'Select Product...', 'Select OS / Type', and 'Release Version'. The 'Available Downloads' section contains a message: 'Please select your options on the left.' To the right, there is an 'Expand All' link and a 'Custom Download List' box showing 'Files: 0' and 'Total Size: 0b'.

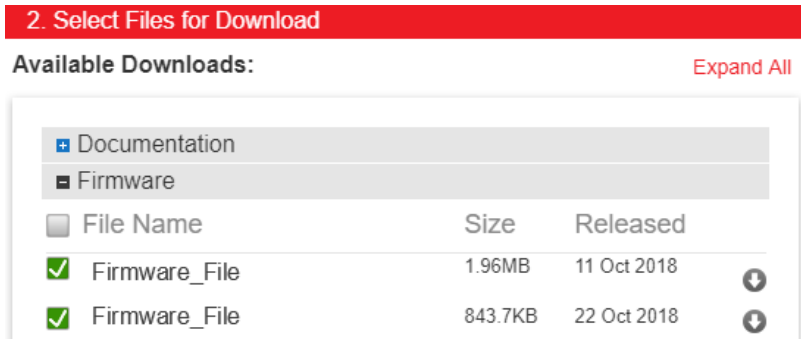
- b. From the Select Files for Download section, expand the Firmware section and select the check box for the firmware file(s).

**Figure 84:** Select Files for Download section

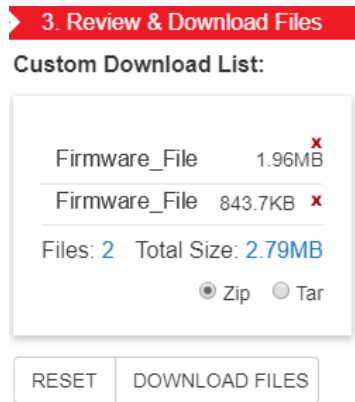
The screenshot shows the 'Select Files for Download' section. The 'Available Downloads' list now includes 'Documentation' and 'Firmware', both with checkboxes. The 'Custom Download List' box still shows 'Files: 0' and 'Total Size: 0b'.

- c. From the Review & Download Files section, review the selected files and click **DOWNLOAD FILES** to download the entire file selection from that section.

**Figure 85:** Review & Download Files section

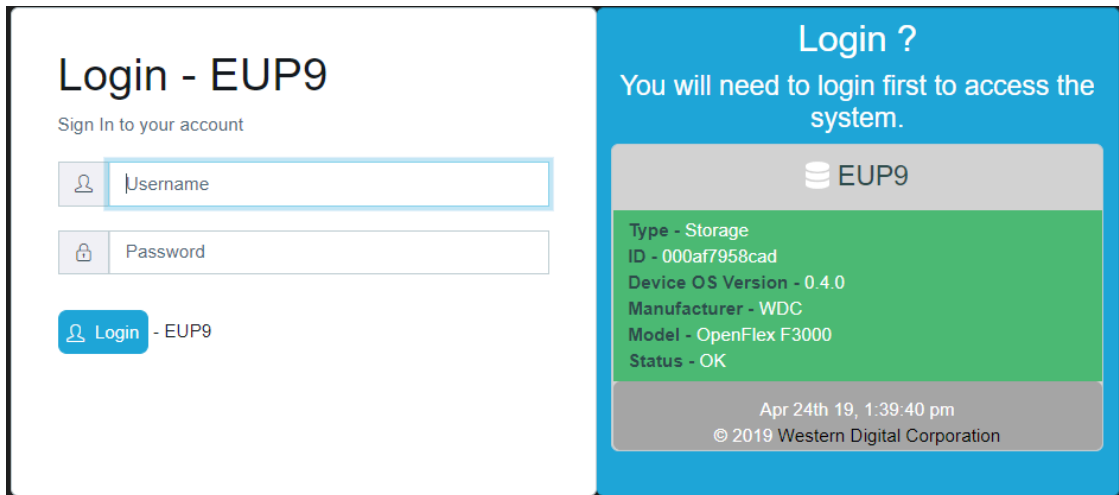


**Figure 86:** Download Files



**Step 5:** Extract the file by unzipping the downloaded file to the desktop.

**Step 6:** Enter a valid username and password, and click the **Login** button:



**Note:** The default username/password is admin/admin.

The system dashboard appears:



**Step 7:** Click the **Devices** banner to view a list of all connected devices:

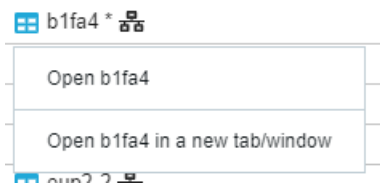


**Step 8:** Locate the device that will be upgraded in the list.

**Step 9:** Click the **Device Actions** icon:



**Step 10:** Click the **Open in a new tab/window** option to open the device page in a new window. This will keep the existing dashboard live in the current window.



The new device's dashboard appears.

**Step 11:** Click the **OS** icon:

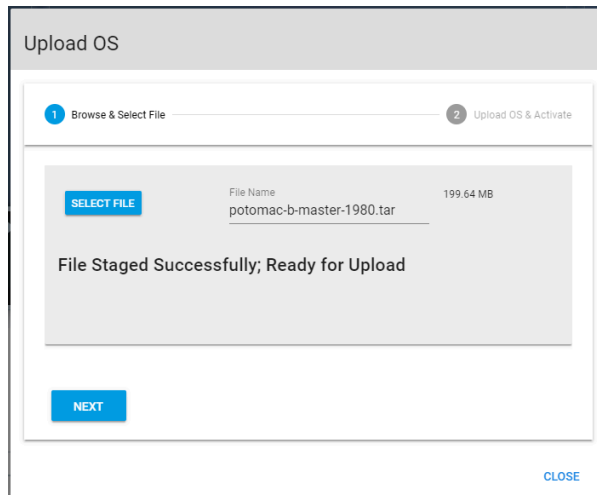


**Step 12:** Click the **Update OS** button:



**Step 13:** Click on the **Select File** button and choose the filepath to the firmware upgrade file that was downloaded previously.

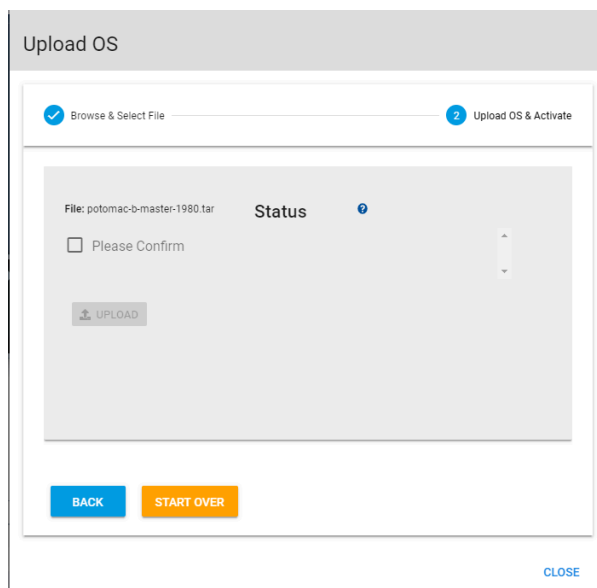
**Figure 88:** Firmware Staging Complete



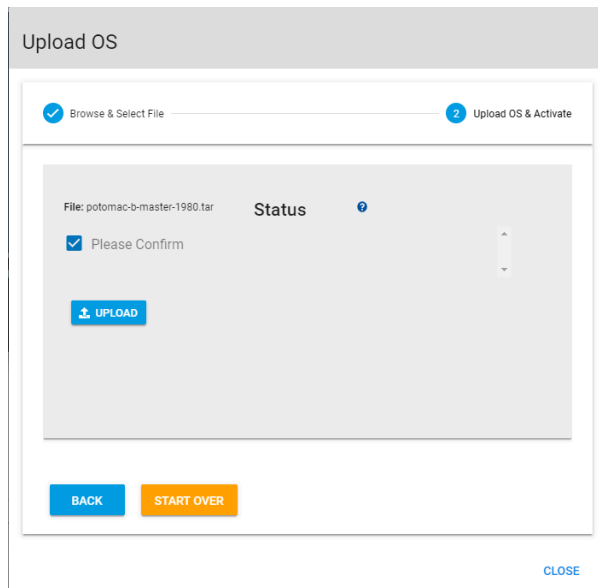
Click **Next** to proceed.

**Step 14:** After the file has been staged by the device, click the checkbox next to **Please Confirm**.

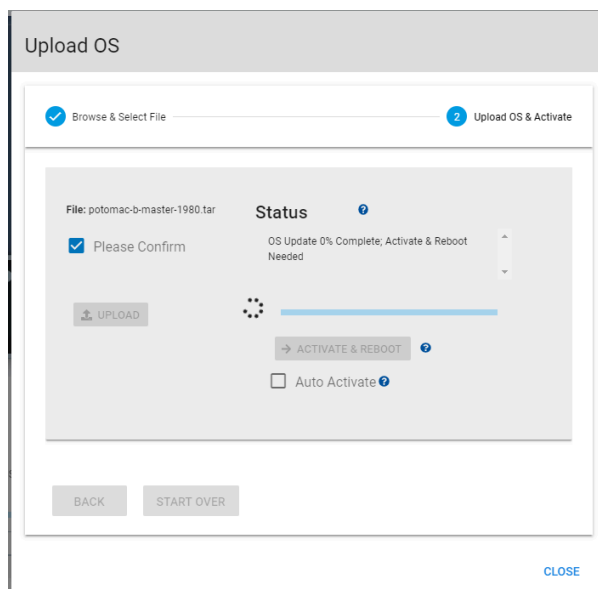
**Figure 89:** Confirm the Upload



**Step 15:** Click the **Upload** button to commence the firmware upload to the device.

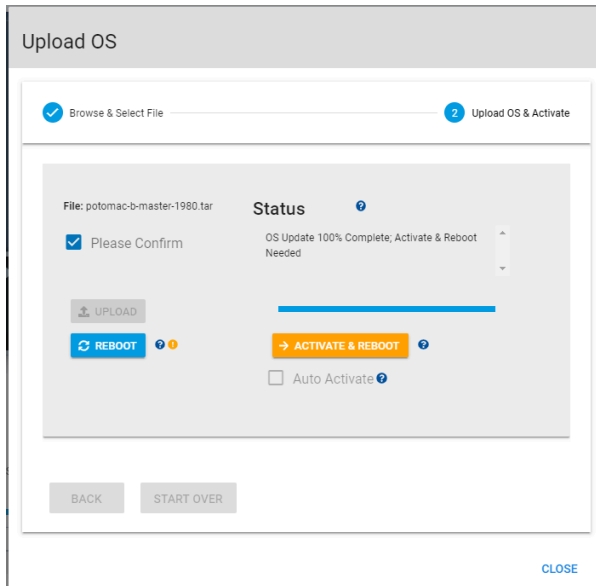
**Figure 90:** Click Upload

**Step 16:** After clicking upload, the upload status will appear. The upload should take less than 5 minutes. After the upload completes an activation and reboot cycle is required. This can be done manually or automatically by clicking the **Auto Activate** check box.

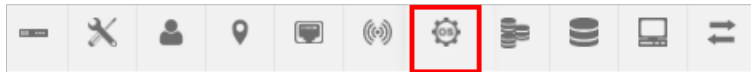
**Figure 91:** Status of Upload

**Step 17:** If **Auto Activate** was not selected and the upload has finished, click the **Activate and Reboot** button to reboot the device and finalize the firmware upgrade.

**Figure 92:** Activate and Reboot the Device



**Step 18:** Click the **OS** icon:



**Step 19:** Verify the change was effective by checking the device firmware listed on the OS Information page.

## 3.2 Part Replacement



**Caution:** In the event of multiple/simultaneous part failures, the order of hot replacement should be as follows:

1. Fans
2. PSUs
3. All other CRUs

**Table 29:** Summary of Part Replacement Times

Part Name	Replacement Time
Fan Module	2 minutes
PSU	3 minutes
BMC Module	2 minutes
OpenFlex F3100	2 minutes
Rails	65 minutes

Part Name	Replacement Time
Chassis	60 minutes

### 3.2.1 Fan Module Replacement

**i Important:** If more than one Fan Module has failed, each Fan Module must be replaced one at a time. Replacing more than one Fan Module at a time may cause the enclosure to go into thermal shutdown.

**Table 30:** Replacement Procedure Info

Required Tools	# of People Required	Time Required
None	1	2 minutes

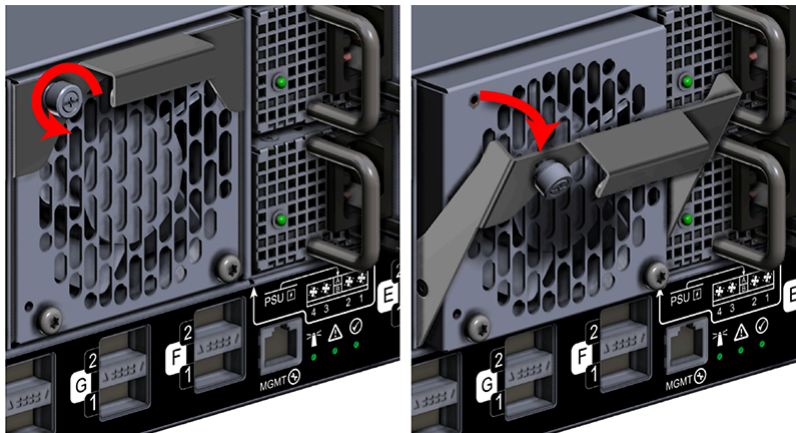
**Step 1:** Unpack and inspect the new Fan Module for damage.

- Inspect the packaging that the Fan Module replacement was shipped in and record any damage to the box. Large cuts, open boxes, and crushed corners should be reported.
- Remove the Fan Module from the packaging and verify that there is no damage to the Fan Module. Dents, scratches, and broken parts should be reported. If major damage has occurred to the Fan Module, DO NOT use the replacement part.
- Store in a safe location until the Fan Module is needed for installation.

**Step 2:** Uninstall the Fan Module from the enclosure.

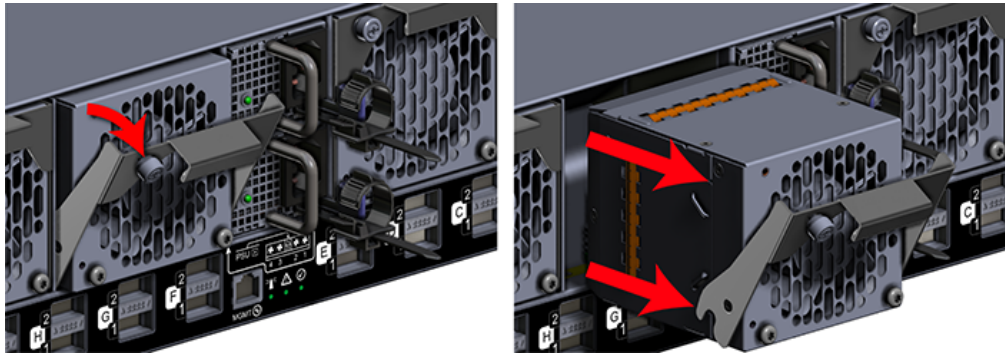
- From the rear of the rack, unlock the Fan Module by turning the thumbscrew counterclockwise until the screw threads are not engaged any longer. The location of the thumbscrew is shown in the following image.

**Figure 93:** Fan Module Release Handle Unlocked



- Pull the release handle out until the Fan Module is unseated and can be removed from the fan bay.

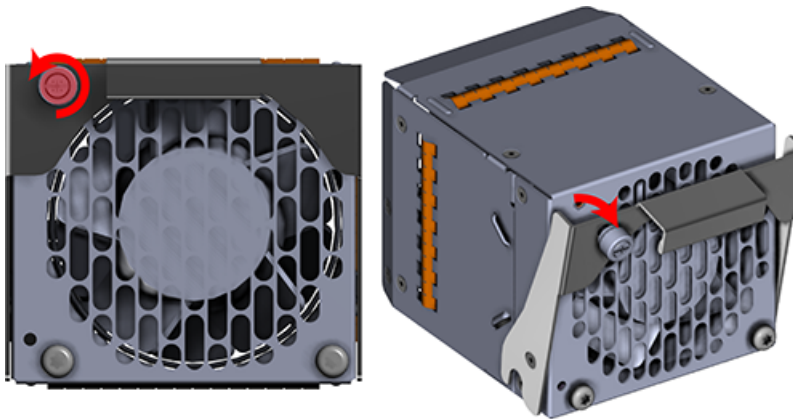


**Figure 94:** Uninstall Fan Module

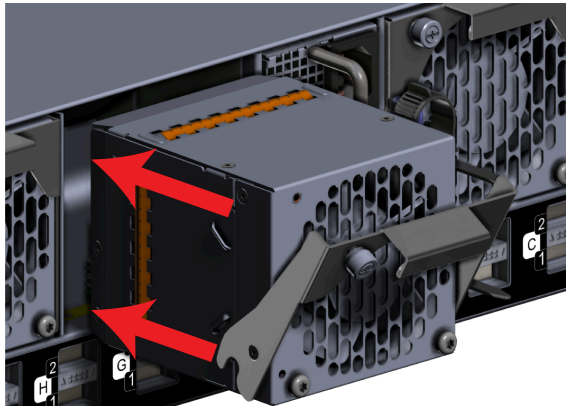
- c. Uninstall each Fan Module in the same way the first was uninstalled.

**Step 3:** Install the new Fan Module into the enclosure.

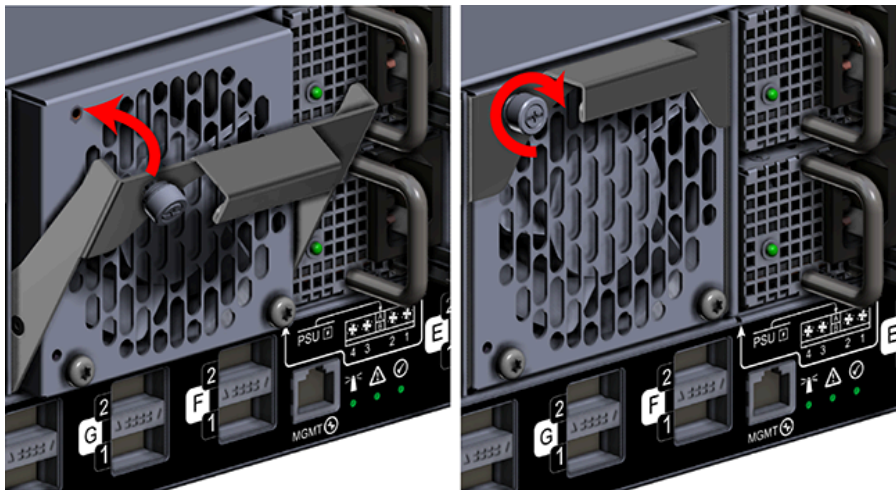
- a. Unlock the Fan Module by turning the thumbscrew counterclockwise until the screw threads are not engaged any longer. The location of the thumbscrew is shown in the following image.

**Figure 95:** Prepare Fan Module

- b. Gently slide the Fan Module into the fan bay until the release handle is engaged with the chassis. When the handle lifts up slightly, it is an indicator that the release handle is engaged with the chassis.

**Figure 96:** Fan Module Engaged

- c. Press the release handle into the Fan Module and secure it in place by turning the thumbscrew clockwise until it is tight.

**Figure 97:** Fan Module Secure

- d. Verify that the Fan Module is securely latched into the chassis by pulling on the release handle and ensuring the Fan Module does not move when pulled. Reinstall the Fan Module if it is not securely installed into the chassis.

### 3.2.2 PSU Replacement

Be careful not to remove both power cables if performing a hot-swap of a PSU. The system needs one PSU running to prevent data disruption.

**Table 31:** Replacement Procedure Info

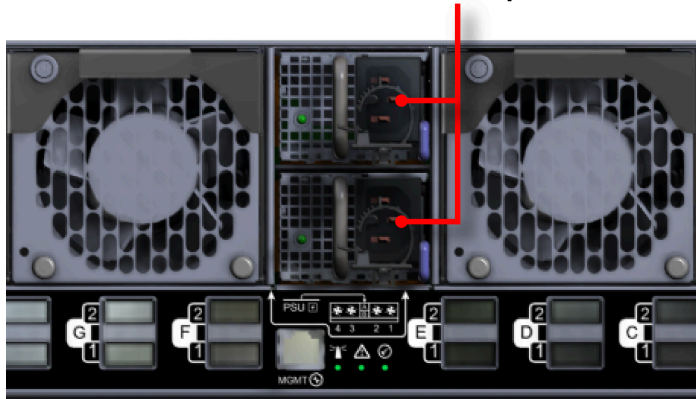
Required Tools	# of People Required	Time Required
None	1	3 minutes

**Step 1:** Unpack and inspect the new PSU for damage.

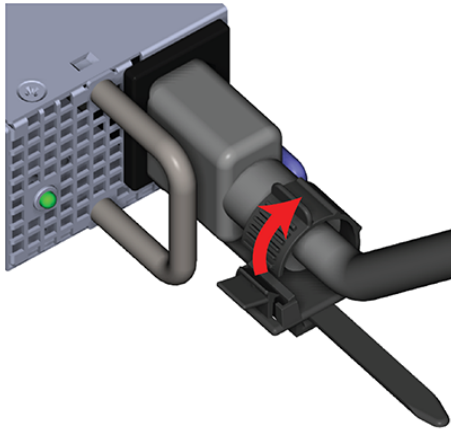
- a. Inspect the packaging that the PSU replacement was shipped in and record any damage to the box. Large cuts, open boxes, and crushed corners should be reported.
- b. Remove the PSU from the packaging and verify that there is no damage to the PSU. Dents, scratches, and broken parts should be reported. If major damage has occurred to the PSU, DO NOT use the replacement part.
- c. Store in a safe location until the PSU is needed for installation.

**Step 2:** Disconnect the power cable from the failed PSU.

**Figure 98:** Enclosure Power and Data Connections  
Power Receptacles

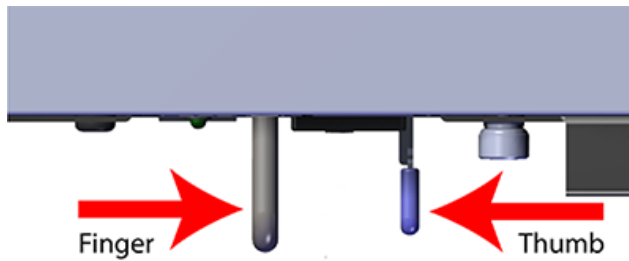


- a. Move to the rear of the rack and open the cable retention clip on the PSU and disconnect the power cable from the PSU.

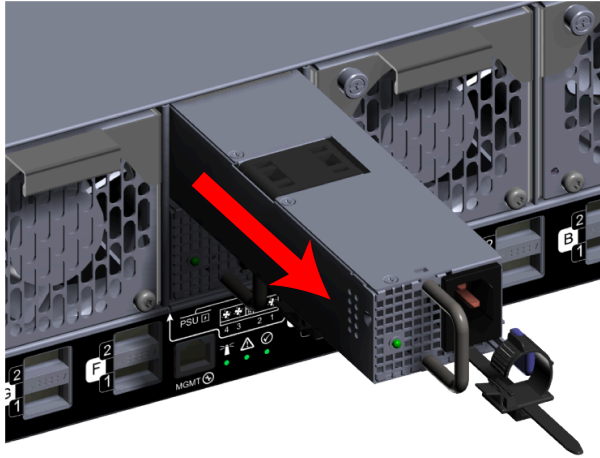
**Figure 99:** Cable Retention Clip Operation

**Step 3:** Uninstall the PSU from the enclosure.

- a. With your left hand, grasp the metal ring handle with your fingers and use your thumb to press the latch release using a pinching motion.

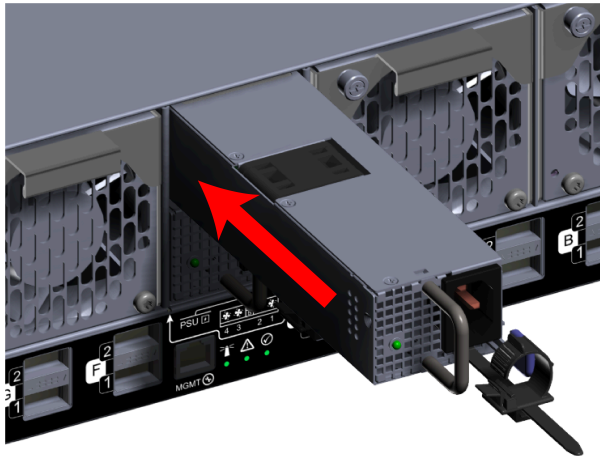
**Figure 100:** PSU Release Latch Operation (Top View)

- b. Carefully pull the PSU out of the PSU Bay.

**Figure 101:** Uninstall PSU

**Step 4:** Install the new PSU into the enclosure.

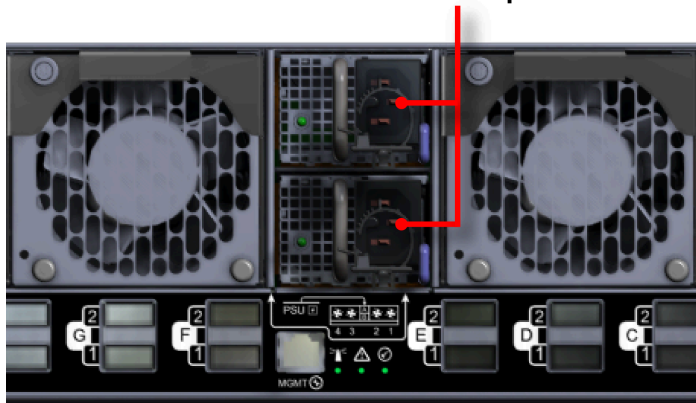
- a. Orient the PSU with the power socket oriented to the side shown in the image and insert it into the PSU slot.

**Figure 102:** PSU Installation

- b. Verify that the PSU is fully seated and latched into the PSU slot by gently pulling on the handle.

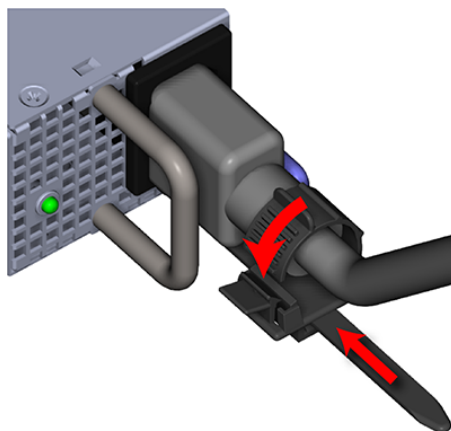
**Step 5:** Connect the power cable into the new PSU.

**Figure 103:** Enclosure Power Connections  
Power Receptacles



- a. Open the cable retention clip on the PSU and connect the power cable into power receptacle on the PSU.

**Figure 104:** Cable Retention Clip Operation



- b. Slide the retention clip forward on the PSUs until it stops near the cable connectors. Doing this will ensure that the retention clips function properly in the event the cable is pulled on.

### 3.2.3 BMC Module Replacement

**Table 32:** Replacement Procedure Info

Required Tools	# of People Required	Time Required
None	1	2 minutes

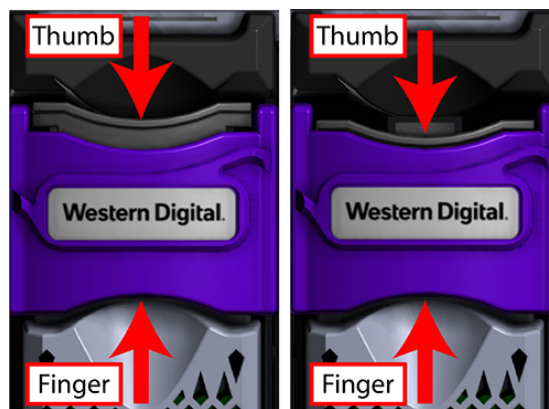
**Step 1:** Unpack and inspect the new BMC Module for damage.

- a. Inspect the packaging that the BMC Module replacement was shipped in and record any damage to the box. Large cuts, open boxes, and crushed corners should be reported.
- b. Remove the BMC Module from the packaging and verify that there is no damage to the BMC Module. Dents, scratches, and broken parts should be reported. If major damage has occurred to the BMC Module, DO NOT use the replacement part.
- c. Store in a safe location until the BMC Module is needed for installation.

**Step 2:** Uninstall the BMC Module from the enclosure.

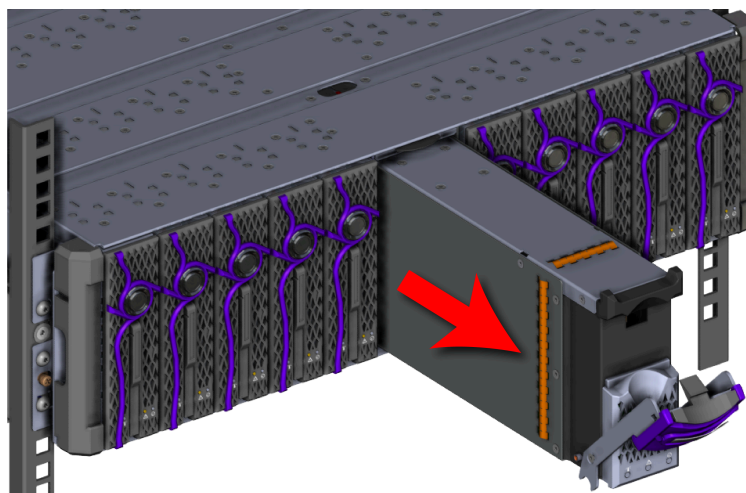
- a. From the front of the rack, grasp the release handle with your forefinger on the bottom and thumb on the top of the release latch and press the release latch with your thumb. The handle will eject from the front of the BMC Module.

**Figure 105:** BMC Module Release Handle Operation



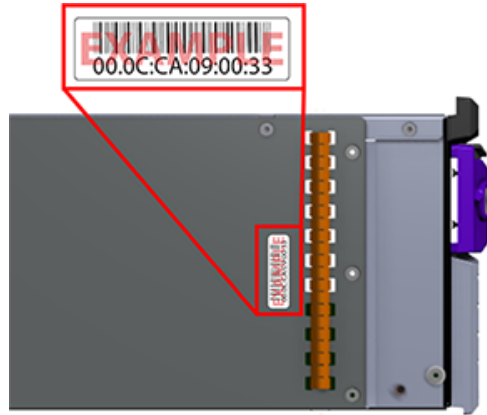
- b. Lower the release handle until the BMC module is fully unseated (this occurs at about 60°) and pull the BMC module out of the chassis ensuring that you support the under side of the BMC module with your other hand.

**Figure 106:** Uninstall BMC Module



- c. Locate the sticker on the side of the BMC Module that lists the mac address for that module and record it somewhere for later use. The mac address of the BMC module will be used to later to navigate to the BMC GUI in order to access the storage.

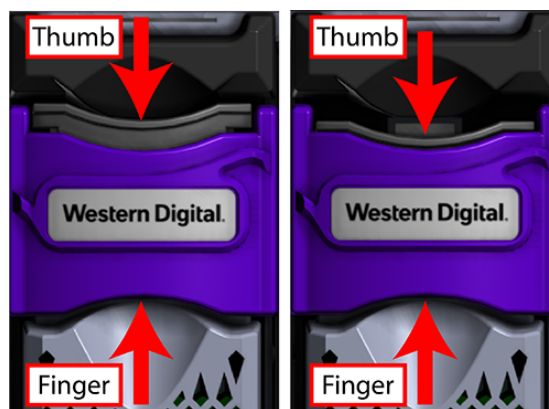
**Figure 107:** BMC Module MAC Address Label



**Step 3:** Install the new BMC Module into the enclosure.

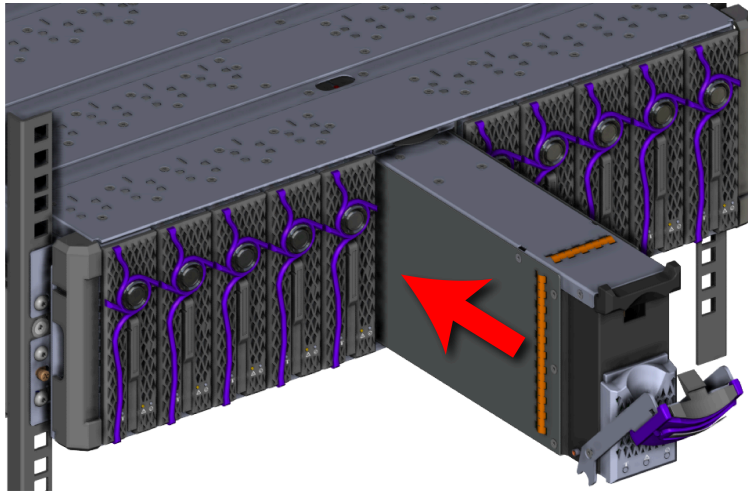
- a. Grasp the release handle with your forefinger on the bottom and thumb on the top of the release latch and press the release latch with your thumb. The handle will eject from the front of the BMC module.

**Figure 108:** BMC Module Release Handle Operation

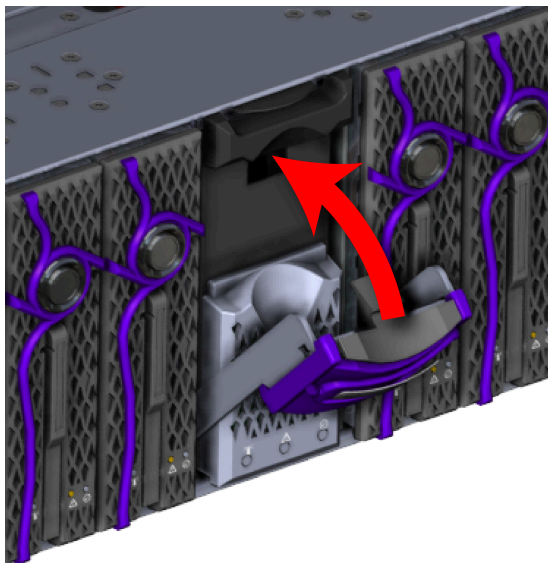


- b. Gently slide the BMC module into the center chassis slot until the release handle is engaged with the chassis. When the handle lifts up slightly, it is an indicator that the release handle is engaged with the chassis.



**Figure 109:** BMC Module Installation

- c. Lift the release handle up and press it into the BMC module to secure it into the slot.

**Figure 110:** Secure BMC Module

- d. Verify that the BMC module is securely latched into the chassis by pulling on the latch and ensuring the BMC module does not move when pulled. Reinstall the BMC module if it is not securely installed into the chassis.

### 3.2.4 OpenFlex F3100 Replacement



**Note:** Both PSUs and the BMC Module must be operational before replacing an OpenFlex F3100 device.

**Table 33:** Replacement Procedure Info

Required Tools	# of People Required	Time Required
None	1	2 minutes

**Step 1:** Unpack and inspect the new OpenFlex F3100 for damage.

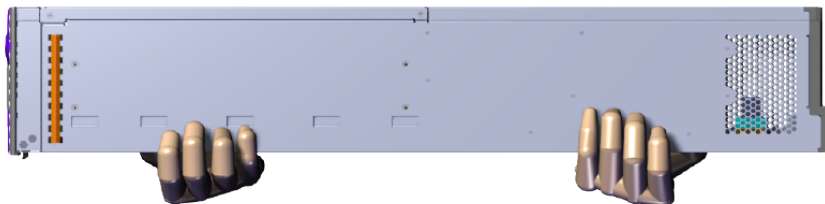
- Inspect the packaging that the OpenFlex F3100 replacement was shipped in and record any damage to the box. Large cuts, open boxes, and crushed corners should be reported.
- Remove the OpenFlex F3100 from the packaging and verify that there is no damage to the OpenFlex F3100. Dents, scratches, and broken parts should be reported. If major damage has occurred to the OpenFlex F3100, DO NOT use the replacement part.
- Store in a safe location until the OpenFlex F3100 is needed for installation.

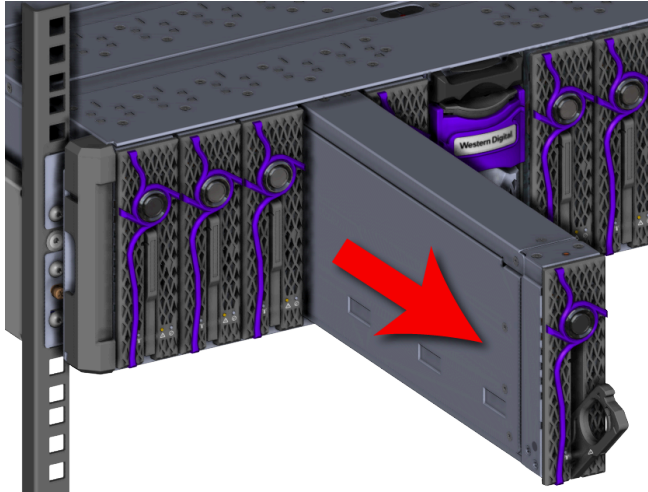
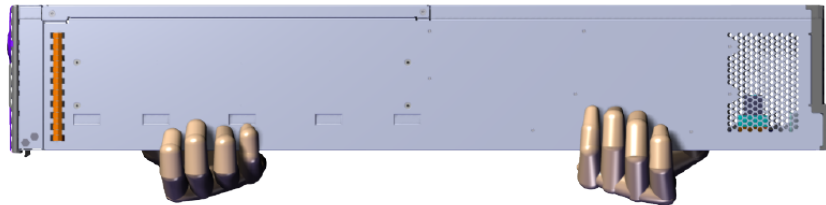
**Step 2:** Uninstall the OpenFlex F3100 from the enclosure.

- From the front of the rack, press the release button on the front of the OpenFlex F3100. The release handle will eject outward.

**Figure 111:** OpenFlex F3100 Release Operation

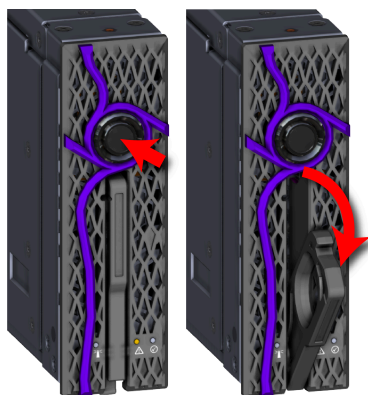
- Use the release handle to pull the OpenFlex F3100 out of the enclosure part way. Then grasp the OpenFlex F3100 from the underside to support it as you pull it the rest of the way out of the enclosure. See the hand placement in the image.



**Figure 112:** Uninstall OpenFlex F3100**Figure 113:** OpenFlex F3100 Hand Placement

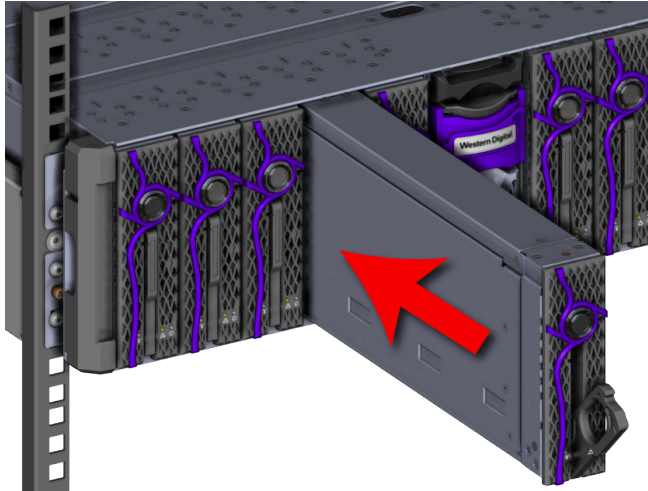
**Step 3:** Install the new OpenFlex F3100 into the enclosure.

- a. Press the release button on the front of the OpenFlex F3100. The release handle will eject outward.

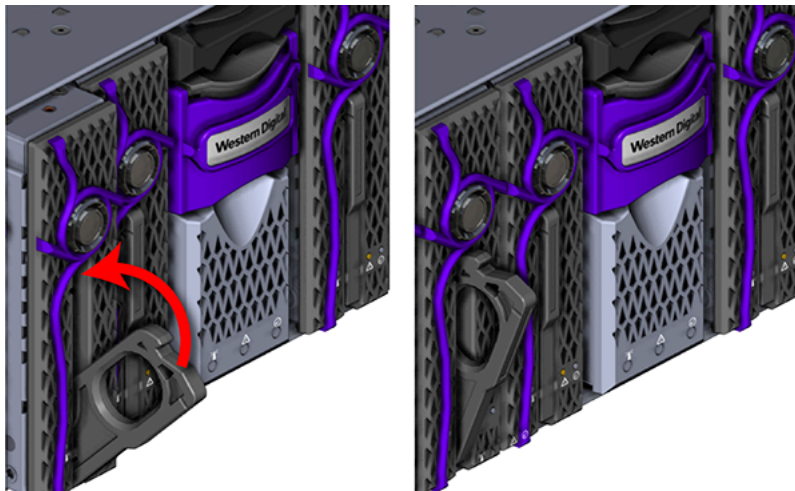
**Figure 114:** OpenFlex F3100 Release Operation

- b. Gently slide the F3100 into the E3000 slot until the release handle is engaged with the chassis. When the handle lifts up slightly, it is an indicator that the release handle is engaged with the chassis.

**Figure 115:** OpenFlex F3100 Install



**Figure 116:** Release Handle Engage



- c. Rotate the release handle up and press it into the OpenFlex F3100 to secure it into the slot. When it is fully installed the user will feel the handle snap and lock into place.

**Figure 117:** Secure OpenFlex F3100

- d. Verify that the F3100 is securely latched into the chassis by pulling on the latch and ensuring the device does not move when pulled. Reinstall the device if it is not securely installed into the chassis.



**Note:** The blue and yellow LEDs will illuminate followed shortly by the green LED. All three LEDs will remain illuminated for just over a minute until the device is initialized. Once the device are initialized, the yellow and blue LEDs will turn off and the Device Status LED that encircles the device release button will illuminate indicating that the SPDK services are running. Wait time is **not** required between the installation of multiple OpenFlex F3100 devices.

### 3.2.5 Rails Replacement

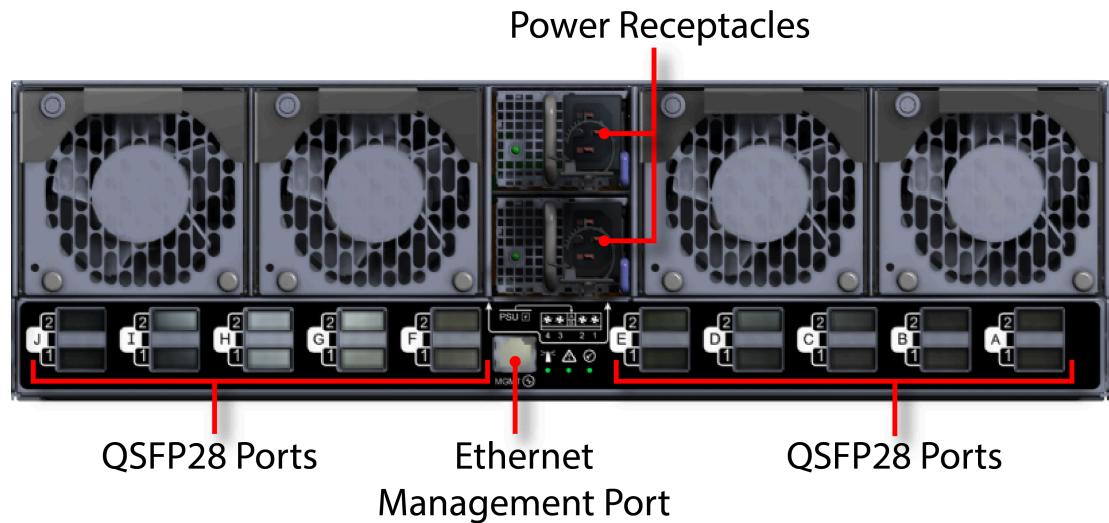
**Table 34:** Replacement Procedure Info

Required Tools	# of People Required	Time Required
T15 Torx screwdriver	2	65 minutes

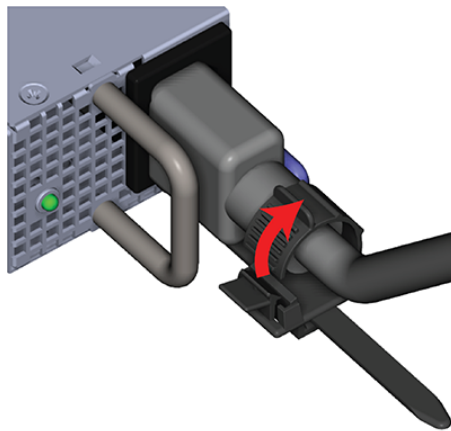
**Step 1:** Unpack and inspect the new Rack Mount Rails for damage.

- a. Inspect the packaging that the Rack Mount Rails replacement was shipped in and record any damage to the box. Large cuts, open boxes, and crushed corners should be reported.
- b. Remove the Rack Mount Rails from the packaging and verify that there is no damage to the Rack Mount Rails. Dents, scratches, and broken parts should be reported. If major damage has occurred to the Rack Mount Rails, DO NOT use the replacement part.
- c. Store in a safe location until the Rack Mount Rails is needed for installation.

**Step 2:** Disconnect the power and data cables from the enclosure.

**Figure 118:** Enclosure Power and Data Connections

- a. Move to the rear of the rack and open the cable retention clip on both of the PSUs and disconnect the power cables from each of the two PSUs.

**Figure 119:** Cable Retention Clip Operation

- b. Disconnect the Ethernet Cable from the Ethernet Management port.
- c. Disconnect the QSF28 Ethernet cables from all of the QSF28 ports.

**Step 3: (Optional)** Uninstall the device blanks from the enclosure.

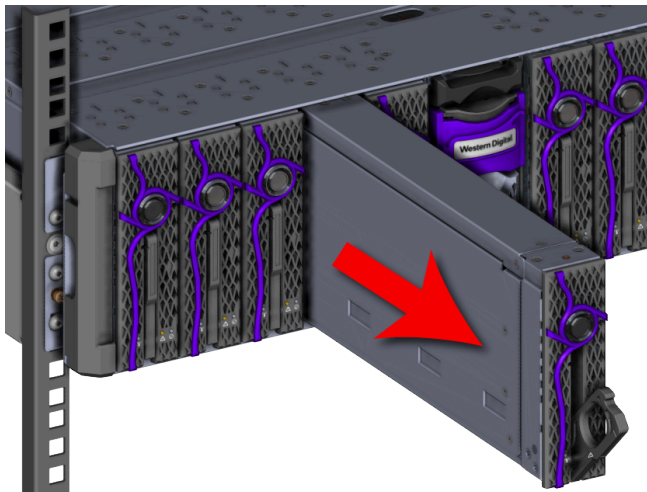


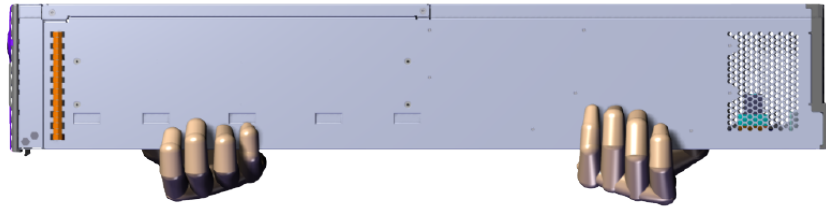
**Attention:** This step is optional because not all configurations contain device blanks. If the configuration contains a device blank, this step will be required. Blanks must be installed in any empty slots to ensure proper cooling.

- a. From the front of the rack, press the release button on the front of the device blank. The release handle will eject outward.

**Figure 120:** Device Blank Release Operation

- b.** Use the release handle to pull the device blank out of the enclosure part way. Then grasp the device blank from the underside to support it as you pull it the rest of the way out of the enclosure.

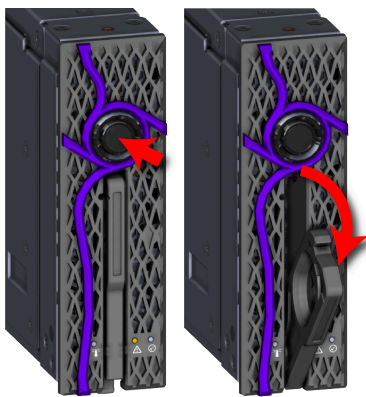
**Figure 121:** Uninstall Device Blank

**Figure 122:** Device Blank Hand Placement

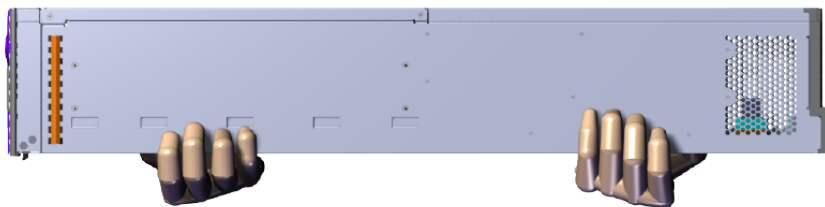
- c. Uninstall each device blank in the same way the first was uninstalled.

**Step 4:** Uninstall the OpenFlex F3100 s from the enclosure.

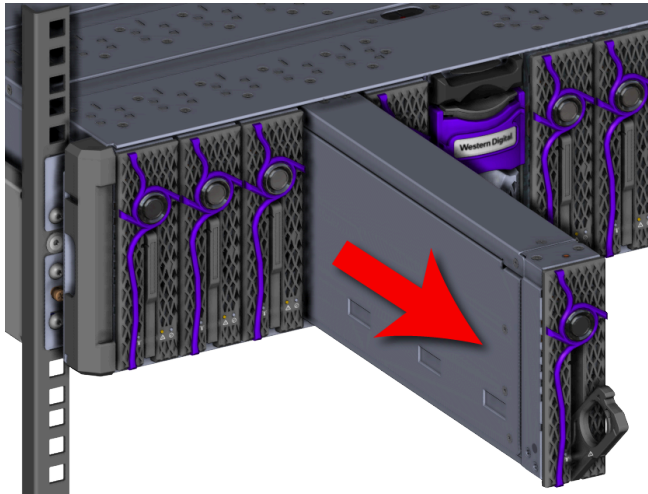
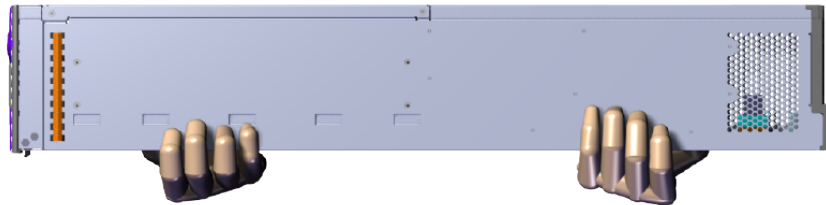
- a. Press the release button on the front of the OpenFlex F3100 . The release handle will eject outward.

**Figure 123:** OpenFlex F3100 Release Operation

- b. Use the release handle to pull the OpenFlex F3100 out of the enclosure part way. Then grasp the OpenFlex F3100 from the underside to support it as you pull it the rest of the way out of the enclosure. See the hand placement in the image.





**Figure 124:** Uninstall OpenFlex F3100**Figure 125:** OpenFlex F3100 Hand Placement

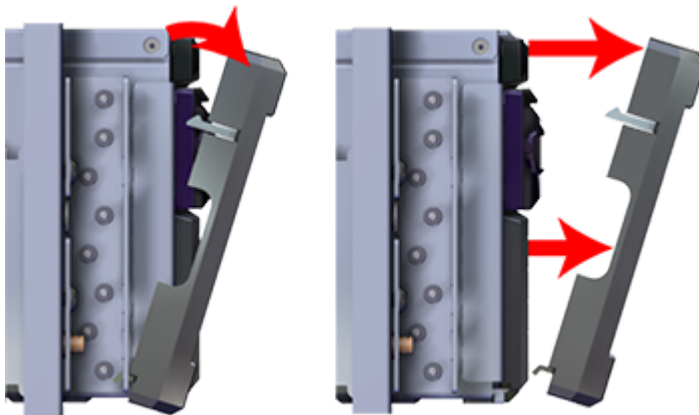
- c. Uninstall each OpenFlex F3100 in the same way the first was uninstalled.

**Step 5:** Uninstall the Chassis from the rack.



**Tip:** A T15 Torx screwdriver is required for this step.

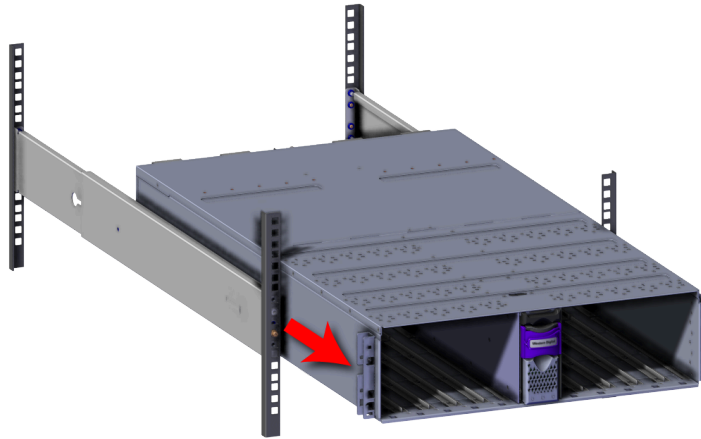
- a. Uninstall the rack ear covers from both of the chassis mounts.

**Figure 126:** Uninstall Rack Ear Covers

- b. Using the #2 Phillips Head screwdriver, remove the two M5 screws that secure the chassis to the rail. Repeat this step to remove the two M5 screws that secure the chassis to the remaining rail.

**Figure 127:** Chassis Screw Removal

- c. Carefully pull the chassis out of the rack ensuring that you take extra care to support the weight of the chassis when the chassis is clear of the rack mount rails.

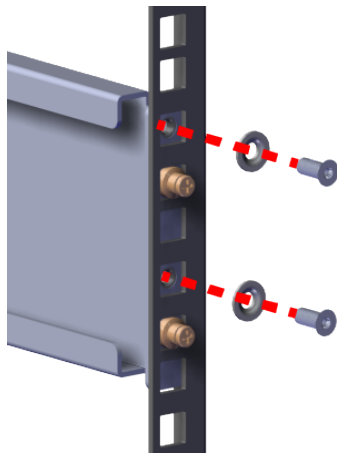
**Figure 128:** Uninstall Chassis

**Step 6:** Uninstall the Rack Mount Rails.

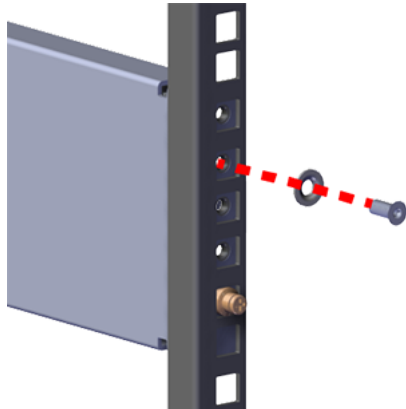


**Tip:** A T15 Torx screwdriver with torque measuring capabilities is recommended for this step.

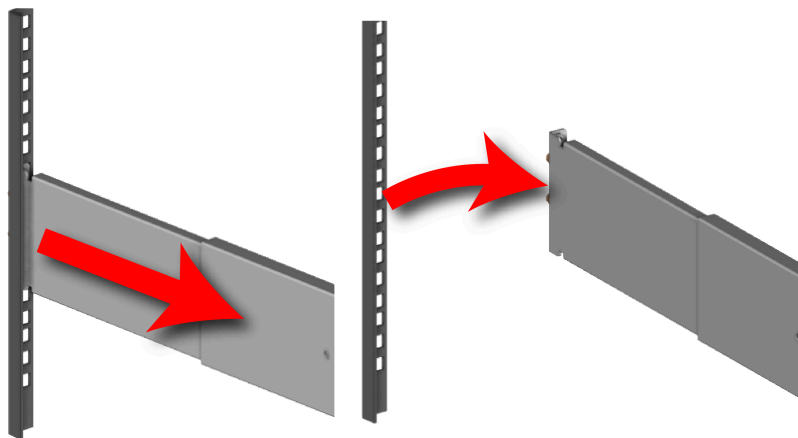
- a. Move to the rear of the rack and using the T15 Torx screwdriver, remove the two T15 screws that secure the rail to the vertical rack rails. Repeat this step to remove the two T15 screws that secure the remaining rail to the vertical rack rail.

**Figure 129:** Rear Rack Mount Rail Screw Removal

- b. Move to the front of the rack and using the T15 Torx screwdriver, remove the T15 screw that secure the rail to the vertical rack rails. Repeat this step to remove the remaining T15 screw that secure the remaining rail to the vertical rack rail.

**Figure 130:** Front Rack Mount Rail Screw Removal

- c. Remove the rails from the rack by sliding the rail mounts out of the vertical rack rail. The rail uses a spring loaded mechanism to secure the rails into the rack before securing them with the provided screws.

**Figure 131:** Rack Mount Rail Removal

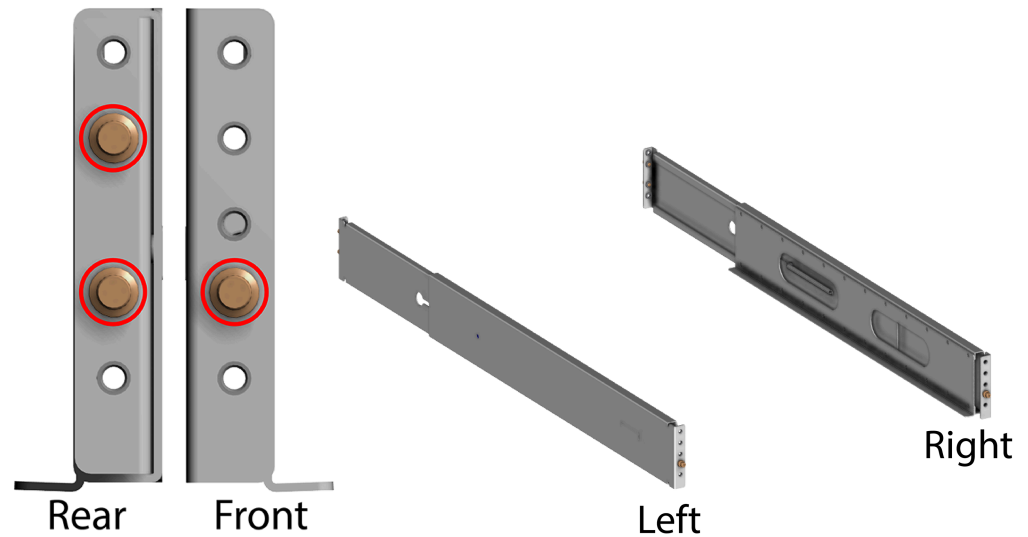
- d. Uninstall the remaining rail in the same way the first was Uninstalled.

**Step 7:** Install the new Rack Mount Rails.

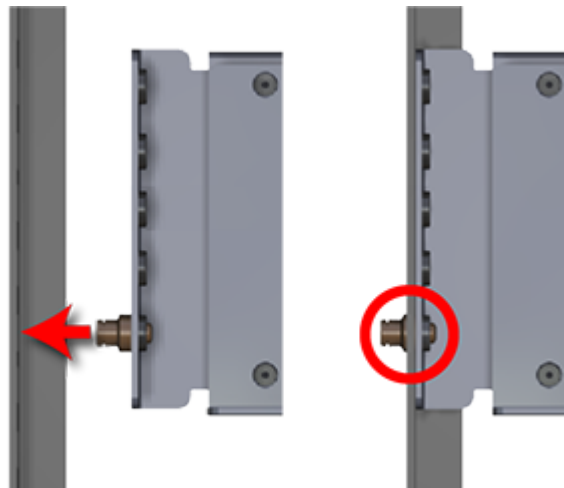


**Tip:** A T15 Torx screwdriver with torque measuring capabilities is recommended for this step.

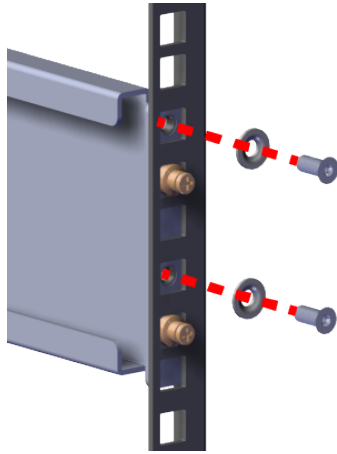
- a. Determine which of the rails is the right and which is the left. From the front of the rack, the rails will need to be installed into the right and left sides. The front of the rail can be identified by the single rack mount pin and the rear of the rail can be identified by the two rack mount pins as shown in the following image. Another way to orient the rails correctly is to make sure that the shelf-flanges that support the enclosure are facing the inside of the rack where the enclosure will reside.

**Figure 132:** Rails Identification

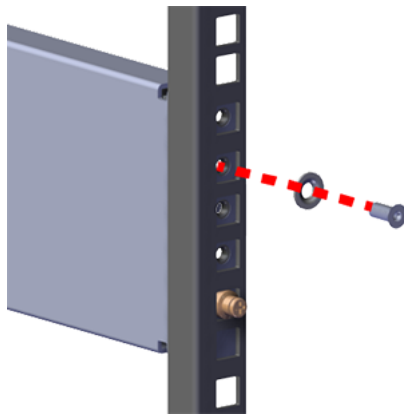
- b.** Insert the front pin into the front vertical rack rail and slide the spring loaded rail until the rear pins line up with the rear vertical rack rail.

**Figure 133:** Rail Pin Installation

- c.** From the rear of the rack use the T15 Torx screwdriver to install the two T15 screws into the rail kits to secure the rail to the vertical rack rails.

**Figure 134:** Rear Rack Mount Rail Screw Installation

- d. From the front of the rack, use the T15 Torx screwdriver to install the flat head T15 screws to secure the rail to the vertical rack rails.

**Figure 135:** Front Rack Mount Rail Screw Installation

- e. Install the remaining rail in the same way the first was installed.
- f. The following must be completed to verify that the rails have been properly installed:
- Both rails have been installed into the rack unit space and are level
  - Both of the front rails contain one T15 screw in each rail mount
  - Both of the rear rails contain two T15 screw in each rail mount

**Step 8:** Install the Chassis into the rack.

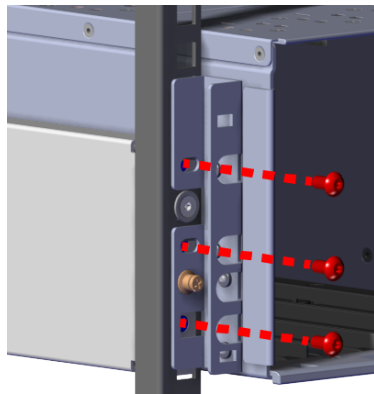


**Tip:** A T15 Torx screwdriver is required for this step.

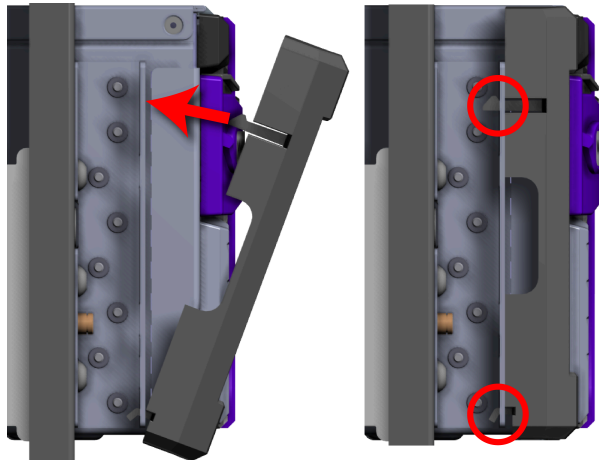
- a. Carefully slide the chassis onto the rails until the chassis mounts are flush with the mounts on the rails.

**Figure 136:** Chassis Installation

- b.** Use a T15 Torx screwdriver to install the three M5 screws that secure the chassis rack ears to the vertical rack rail. Do this to both rack ears to fully secure the enclosure.

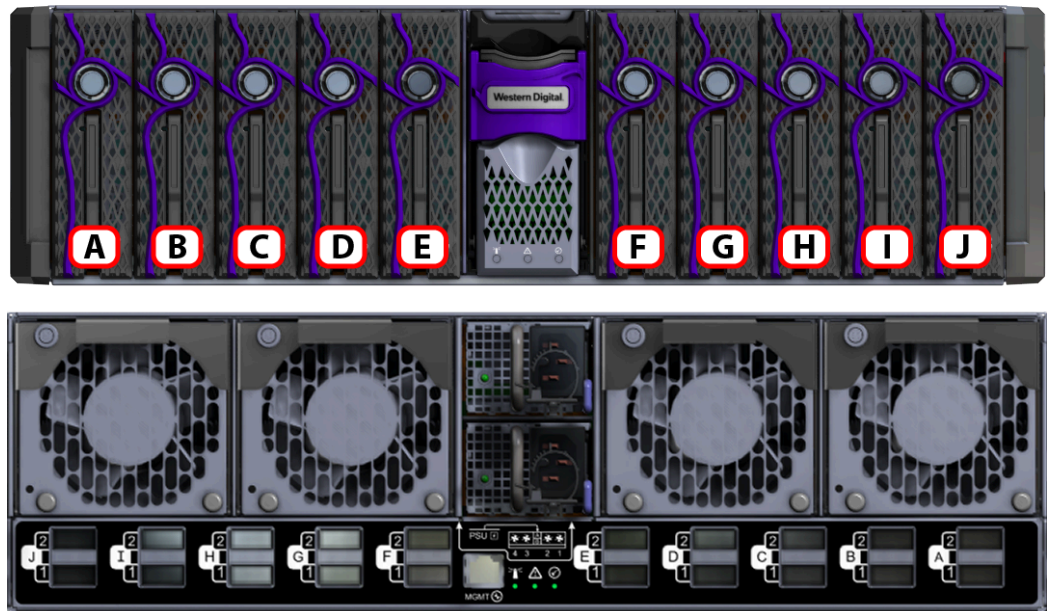
**Figure 137:** Chassis Screw Installation

- c.** Verify that the Chassis is secured to the rails and does not move when pulled. Remove the screws and try again if the enclosure is not secured to the rack.
- d.** Install the rack ear covers onto both of the chassis mounts.

**Figure 138:** Rack Ear Cover Installation

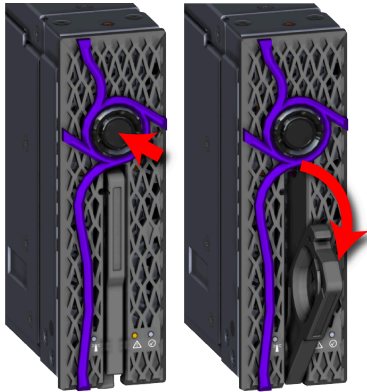
**Step 9:** Install the OpenFlex F3100 s into the enclosure.

- a. Determine and record what slots are physically populated with an OpenFlex F3100 . The slots are assigned letters A through J, from left to right, when facing the front of the enclosure. These slot assignments coincide with the QSFP28 ports on the rear of the enclosure. This information will be utilized during the connection of the QSFP28 ports.

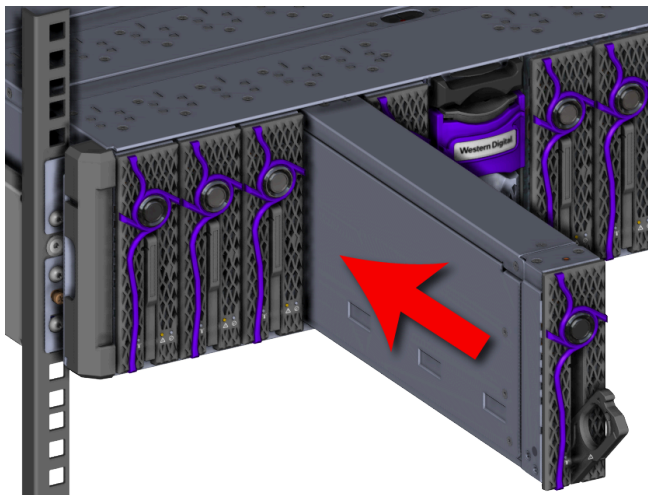
**Figure 139:** OpenFlex F3100 Slot Identification

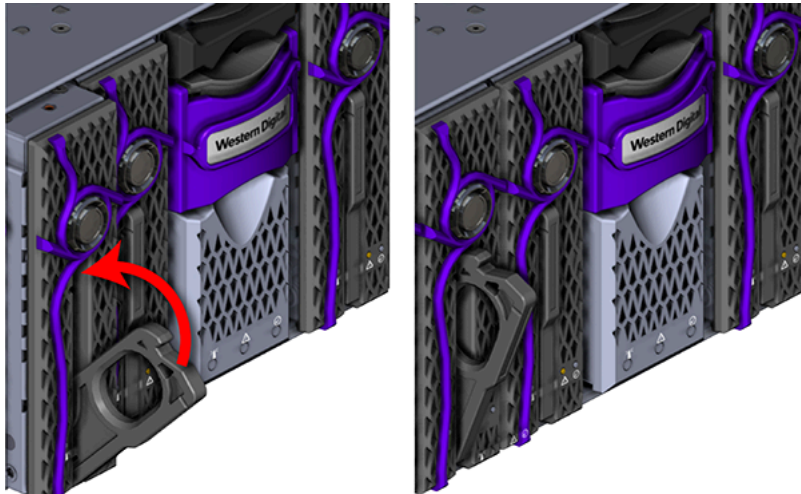
- b. Press the release button on the front of the OpenFlex F3100 . The release handle will eject outward.



**Figure 140:** OpenFlex F3100 Release Operation

- c. Gently slide the F3100 into the E3000 slot until the release handle is engaged with the chassis. When the handle lifts up slightly, it is an indicator that the release handle is engaged with the chassis.

**Figure 141:** OpenFlex F3100 Install

**Figure 142:** Release Handle Engage

- d. Rotate the release handle up and press it into the OpenFlex F3100 to secure it into the slot. When it is fully installed the user will feel the handle snap and lock into place.

**Figure 143:** Secure OpenFlex F3100

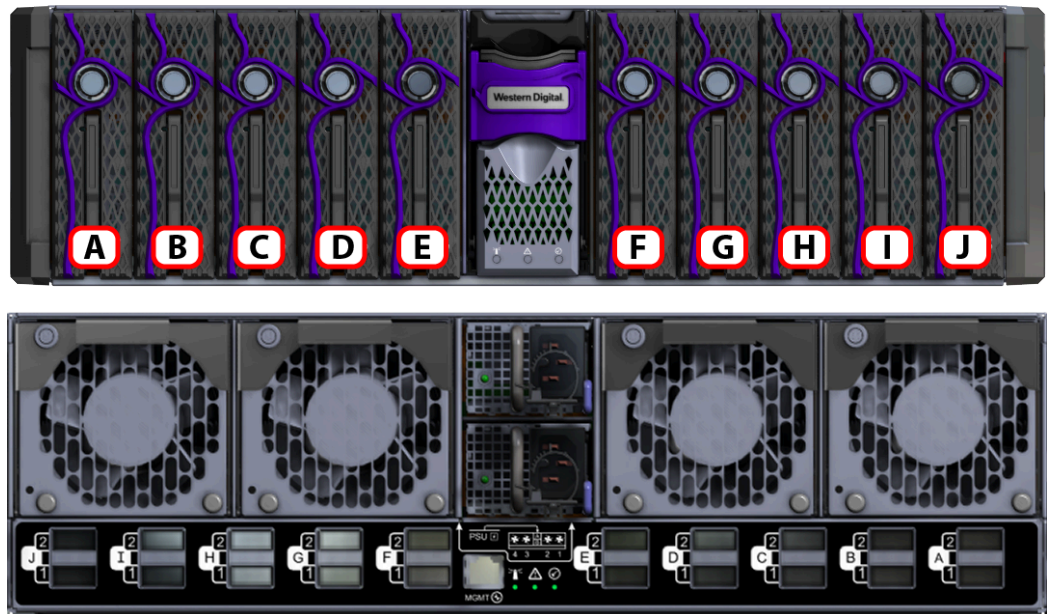
- e. Verify that the F3100 is securely latched into the chassis by pulling on the latch and ensuring the device does not move when pulled. Reinstall the device if it is not securely installed into the chassis.



**Note:** The blue and yellow LEDs will illuminate followed shortly by the green LED. All three LEDs will remain illuminated for just over a minute until the device is initialized. Once the device are initialized, the yellow and blue LEDs will turn off and the Device Status LED that encircles the device release button will illuminate indicating that the SPDK services are running. Wait time is **not** required between the installation of multiple OpenFlex F3100 devices.

- f. Install each device in the same way the first was installed, and be sure to follow the installation order depicted in the following figure.

**Figure 144:** OpenFlex F3100 Slot Identification

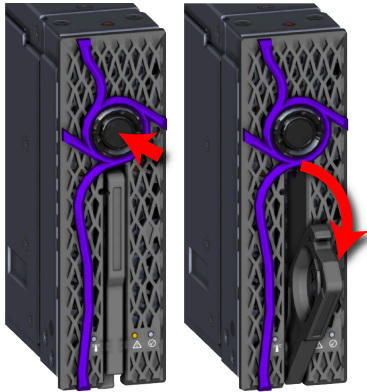


**Step 10: (Optional)** Install the device blanks into the enclosure.

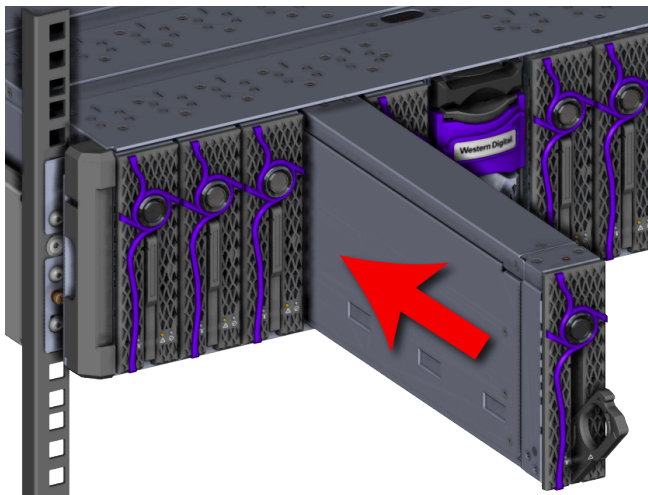


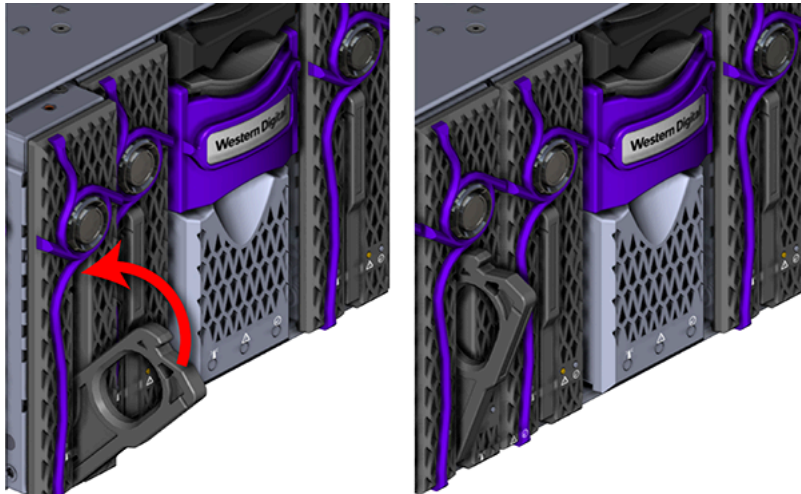
**Attention:** This step is optional because not all configurations contain device blanks. If the configuration contains a device blank, this step will be required. Blanks must be installed in any empty slots to ensure proper cooling.

- a. Press the release button on the front of the OpenFlex F3100. The release handle will eject outward.

**Figure 145:** OpenFlex F3100 Release Operation

- b. Gently slide the device blank into a chassis device blank slot until the release handle is engaged with the chassis. When the handle lifts up slightly, it is an indicator that the release handle is engaged with the chassis.

**Figure 146:** Device Blank Install

**Figure 147:** Release Handle Engage

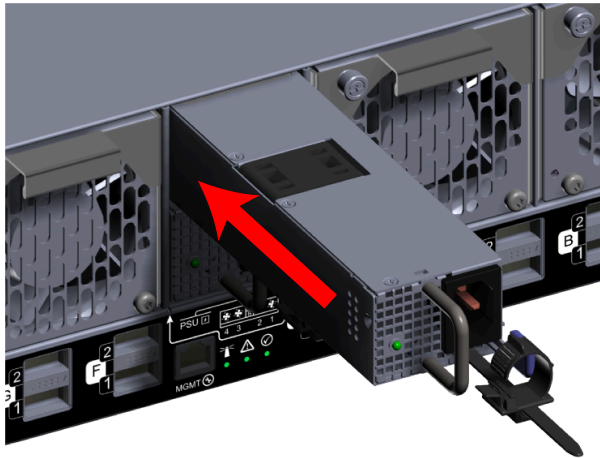
- c. Lift the release handle up and press it into the device blank to secure it into the slot.

**Figure 148:** Secure Device Blank

- d. Verify that the device blank is securely latched into the chassis by pulling on the release handle and ensuring the device blank does not move when pulled. Reinstall the device blank if it is not securely installed into the chassis.
- e. Install each device blank in the same way the first was installed.

**Step 11:** Install the PSUs into the enclosure.

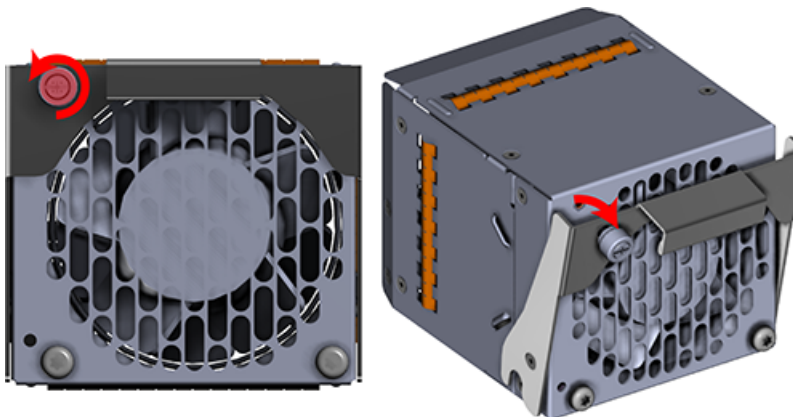
- a. Move to the rear of the rack, orient the PSU with the power socket located on the bottom and insert it into the PSU slot.

**Figure 149:** PSU Installation

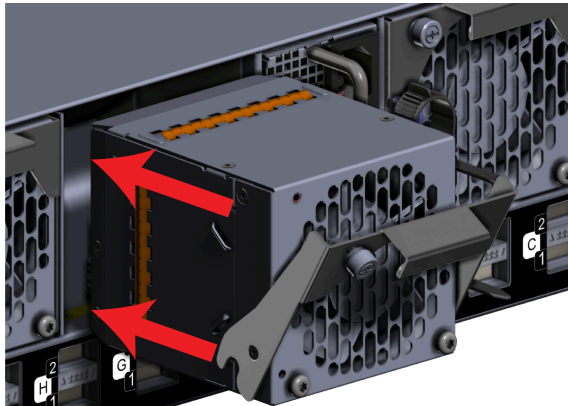
- b. Verify that the PSU is fully seated and latched into the PSU slot by gently pulling on the handle.
- c. Install the remaining PSU in the same way the first was installed.

**Step 12:** Install the Fan Modules into the enclosure.

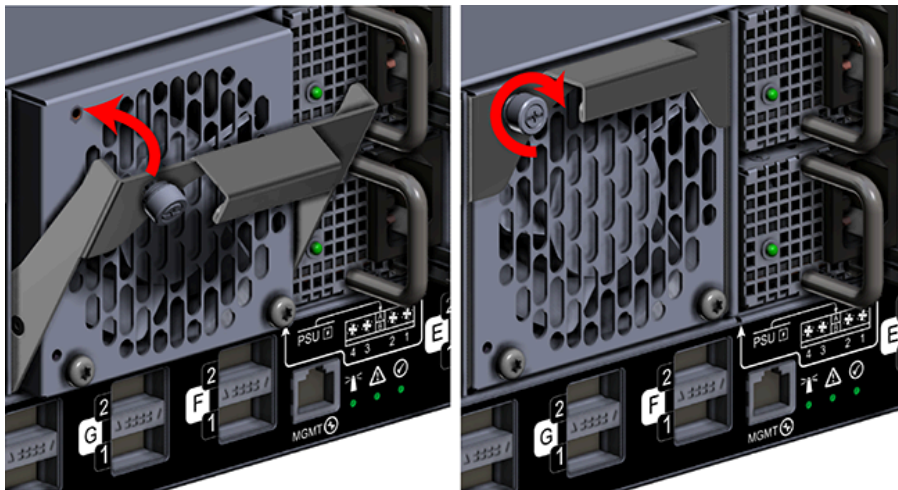
- a. Unlock the Fan Module by turning the thumbscrew counterclockwise until the screw threads are not engaged any longer. The location of the thumbscrew is shown in the following image.

**Figure 150:** Prepare Fan Module

- b. Gently slide the Fan Module into the fan bay until the release handle is engaged with the chassis. When the handle lifts up slightly, it is an indicator that the release handle is engaged with the chassis.

**Figure 151:** Fan Module Engaged

- c. Press the release handle into the Fan Module and secure it in place by turning the thumbscrew clockwise until it is tight.

**Figure 152:** Fan Module Secure

- d. Verify that the Fan Module is securely latched into the chassis by pulling on the release handle and ensuring the Fan Module does not move when pulled. Reinstall the Fan Module if it is not securely installed into the chassis.
- e. Install each Fan Module in the same way the first was installed.

**Step 13:** Connect the power and data cables to the enclosure.

### 3.2.6 Chassis Replacement

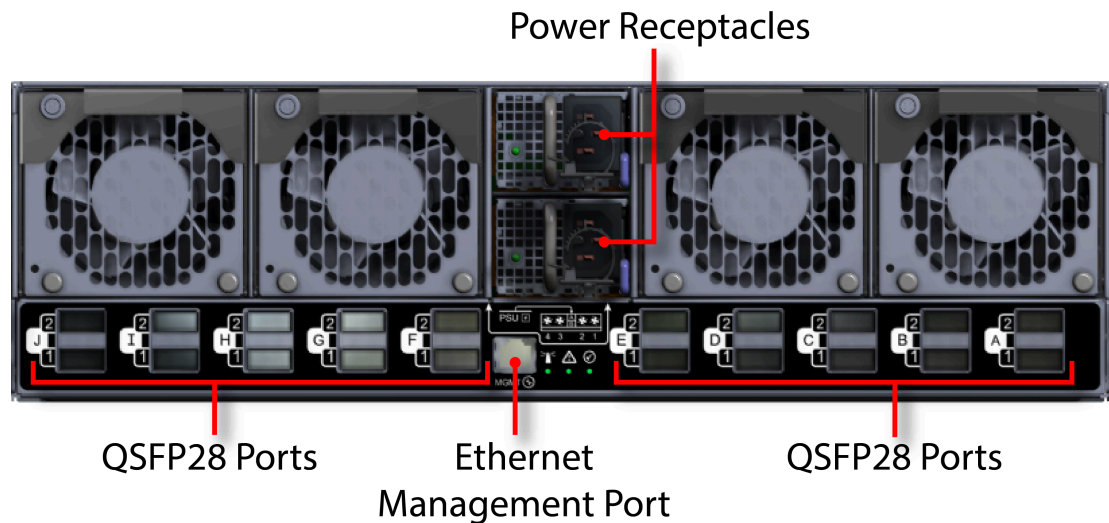
**Table 35:** Replacement Procedure Info

Required Tools	# of People Required	Time Required
#2 Phillips Head screwdriver	2	60 minutes

**Step 1:** Unpack and inspect the new Chassis for damage.

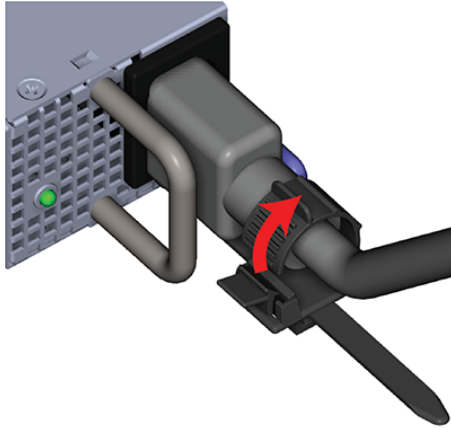
- a. Inspect the packaging that the Chassis replacement was shipped in and record any damage to the box. Large cuts, open boxes, and crushed corners should be reported.
- b. Remove the Chassis from the packaging and verify that there is no damage to the Chassis. Dents, scratches, and broken parts should be reported. If major damage has occurred to the chassis, DO NOT use the replacement part.
- c. Store in a safe location until the Chassis is needed for installation.

**Step 2:** Disconnect the power and data cables from the enclosure.

**Figure 153:** Enclosure Power and Data Connections

- a. Move to the rear of the rack and open the cable retention clip on both of the PSUs and disconnect the power cables from each of the two PSUs.

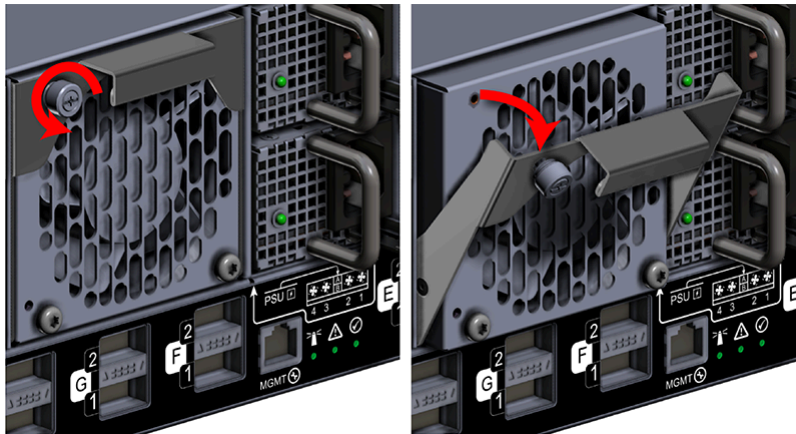


**Figure 154:** Cable Retention Clip Operation

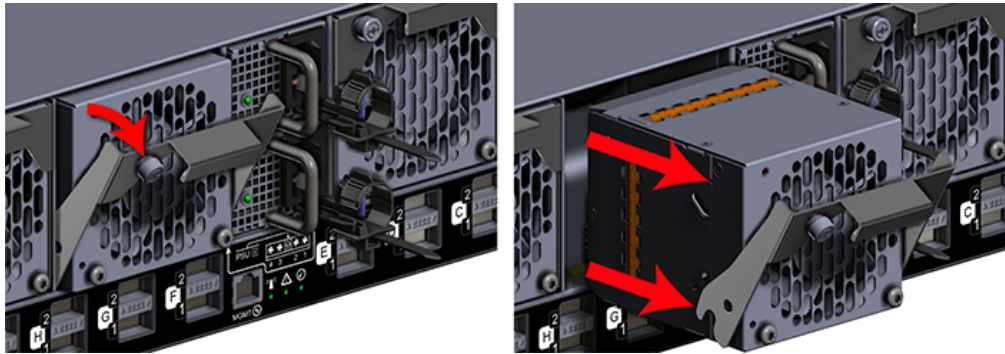
- b. Disconnect the Ethernet Cable from the Ethernet Management port.
- c. Disconnect the QSFP28 Ethernet cables from all of the QSFP28 ports.

**Step 3:** Uninstall the Fan Modules from the enclosure.

- a. Unlock the Fan Module by turning the thumbscrew counterclockwise until the screw threads are not engaged any longer. The location of the thumbscrew is shown in the following image.

**Figure 155:** Fan Module Release Handle Unlocked

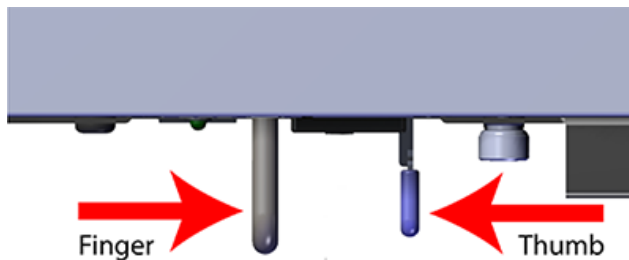
- b. Pull the release handle out until the Fan Module is unseated and can be removed from the fan bay.

**Figure 156:** Uninstall Fan Module

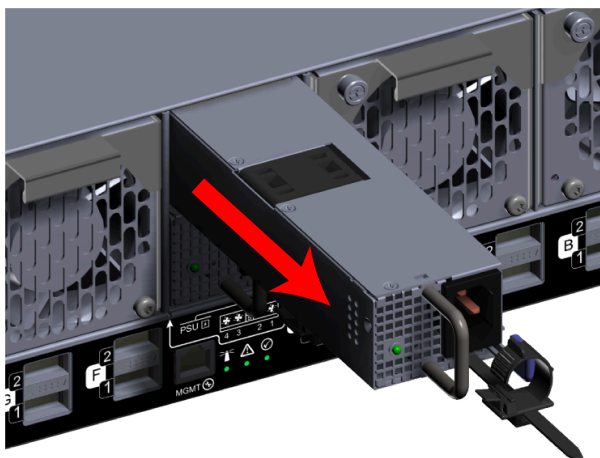
- c. Uninstall each Fan Module in the same way the first was uninstalled.

**Step 4:** Uninstall the PSUs from the enclosure.

- a. With your left hand, grasp the metal ring handle with your fingers and use your thumb to press the latch release using a pinching motion.

**Figure 157:** PSU Release Latch Operation (Top View)

- b. Carefully pull the PSU out of the PSU Bay.

**Figure 158:** Uninstall PSU

- c. Uninstall the remaining PSU in the same way the first was uninstalled.

**Step 5: (Optional)** Uninstall the device blanks from the enclosure.

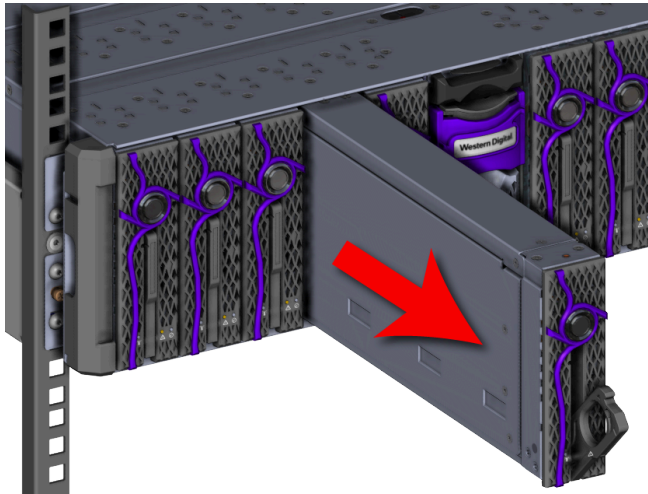
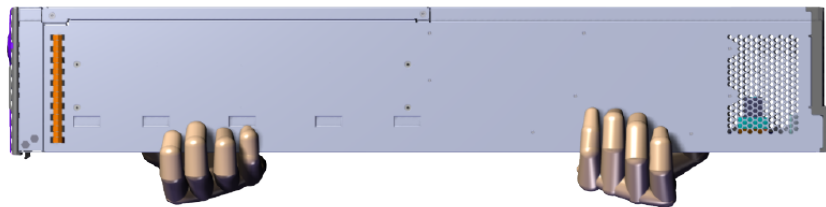
**i** **Attention:** This step is optional because not all configurations contain device blanks. If the configuration contains a device blank, this step will be required. Blanks must be installed in any empty slots to ensure proper cooling.

- a. From the front of the rack, press the release button on the front of the device blank. The release handle will eject outward.

**Figure 159:** Device Blank Release Operation



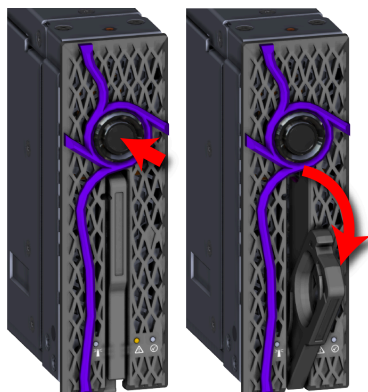
- b. Use the release handle to pull the device blank out of the enclosure part way. Then grasp the device blank from the underside to support it as you pull it the rest of the way out of the enclosure.

**Figure 160:** Uninstall Device Blank**Figure 161:** Device Blank Hand Placement

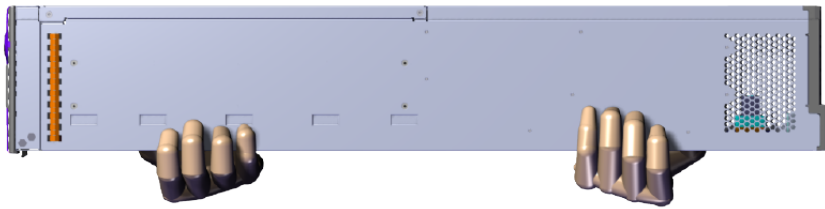
- c. Uninstall each device blank in the same way the first was uninstalled.

**Step 6:** Uninstall the OpenFlex F3100 s from the enclosure.

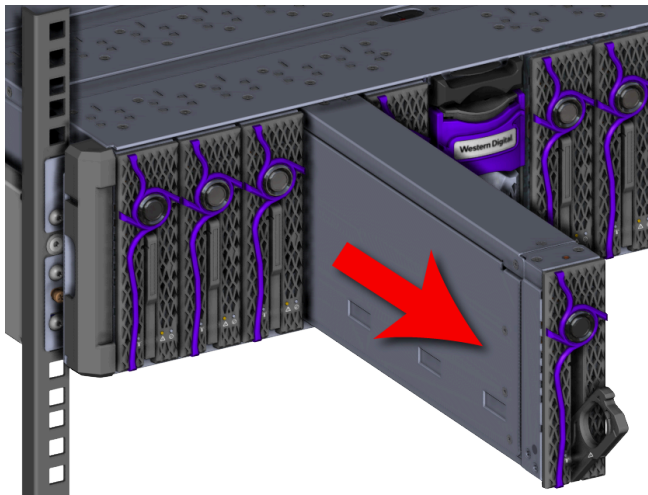
- a. Press the release button on the front of the OpenFlex F3100 . The release handle will eject outward.

**Figure 162:** OpenFlex F3100 Release Operation

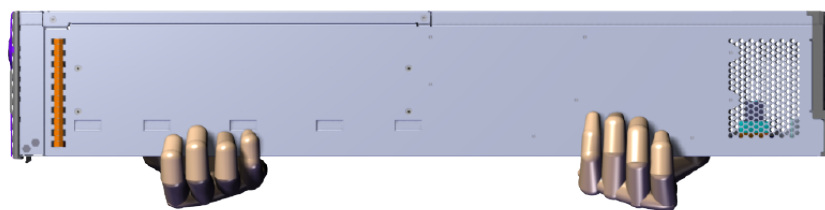
- b. Use the release handle to pull the OpenFlex F3100 out of the enclosure part way. Then grasp the OpenFlex F3100 from the underside to support it as you pull it the rest of the way out of the enclosure. See the hand placement in the image.



**Figure 163:** Uninstall OpenFlex F3100



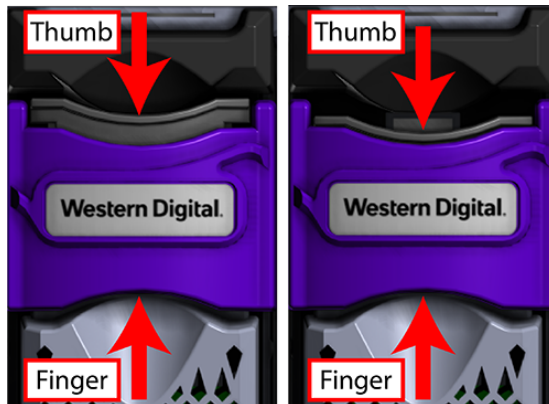
**Figure 164:** OpenFlex F3100 Hand Placement



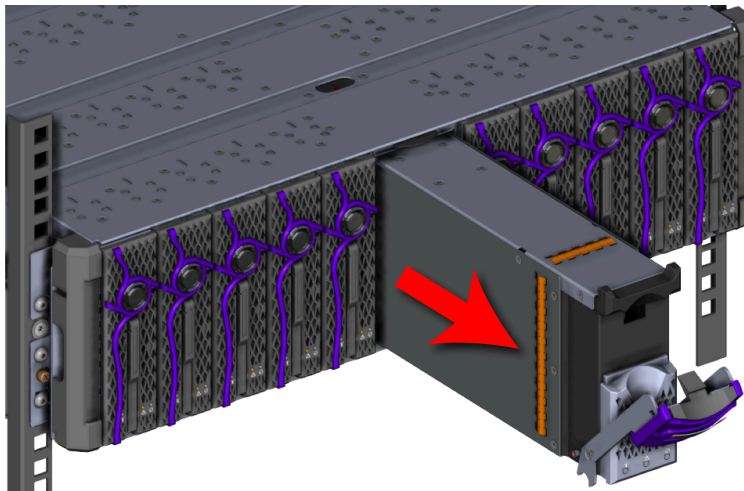
- c. Uninstall each OpenFlex F3100 in the same way the first was uninstalled.

**Step 7:** Uninstall the BMC module from the enclosure.

- a. Grasp the release handle with your forefinger on the bottom and thumb on the top of the release latch and press the release latch with your thumb. The handle will eject from the front of the BMC module.

**Figure 165:** BMC Module Release Handle Operation

- b. Lower the release handle until the BMC module is fully unseated (this occurs at about 60°) and pull the BMC module out of the chassis ensuring that you support the under side of the BMC module with your other hand.

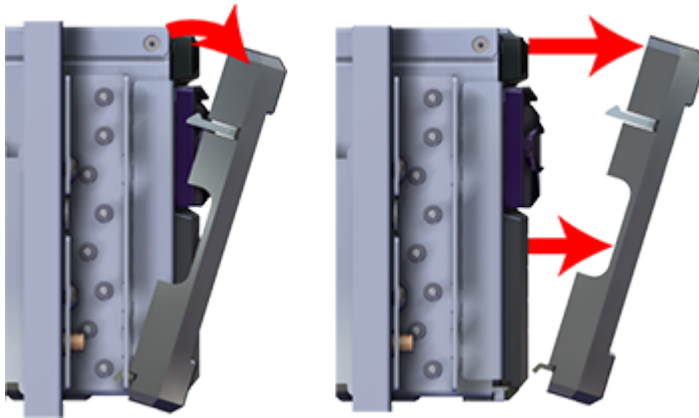
**Figure 166:** Uninstall BMC Module

**Step 8:** Uninstall the Chassis from the rack.



**Tip:** A T15 Torx screwdriver is required for this step.

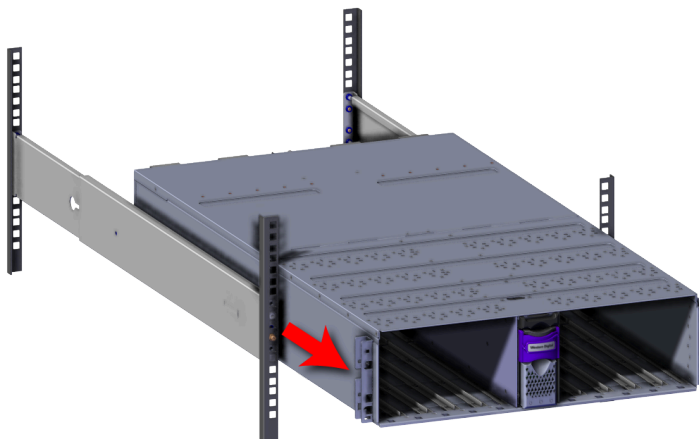
- a. Uninstall the rack ear covers from both of the chassis mounts.

**Figure 167:** Uninstall Rack Ear Covers

- b. Using the #2 Phillips Head screwdriver, remove the two M5 screws that secure the chassis to the rail. Repeat this step to remove the two M5 screws that secure the chassis to the remaining rail.

**Figure 168:** Chassis Screw Removal

- c. Carefully pull the chassis out of the rack ensuring that you take extra care to support the weight of the chassis when the chassis is clear of the rack mount rails.

**Figure 169:** Uninstall Chassis

**Step 9:** Install the new Chassis into the rack.



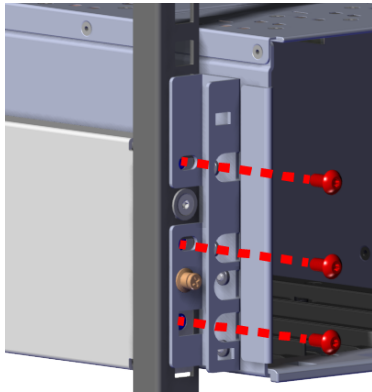
**Tip:** A T15 Torx screwdriver is required for this step.

- a. Carefully slide the chassis onto the rails until the chassis mounts are flush with the mounts on the rails.

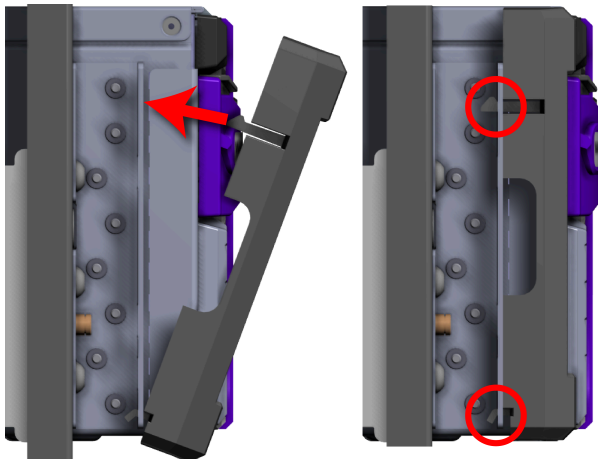
**Figure 170:** Chassis Installation

- b. Use a T15 Torx screwdriver to install the three M5 screws that secure the chassis rack ears to the vertical rack rail. Do this to both rack ears to fully secure the enclosure.



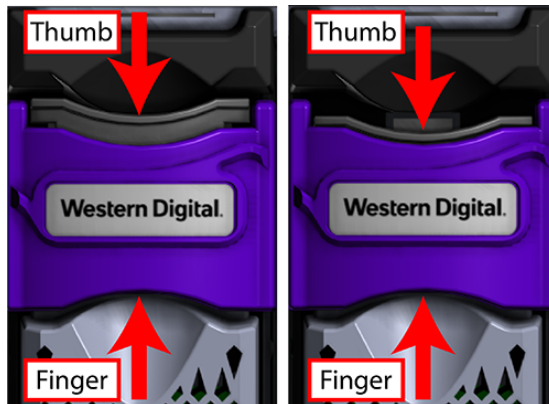
**Figure 171:** Chassis Screw Installation

- c. Verify that the Chassis is secured to the rails and does not move when pulled. Remove the screws and try again if the enclosure is not secured to the rack.
- d. Install the rack ear covers onto both of the chassis mounts.

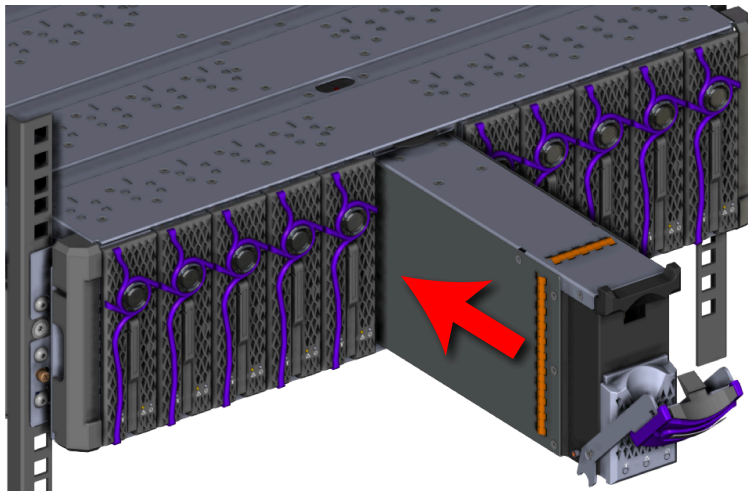
**Figure 172:** Rack Ear Cover Installation

**Step 10:** Install the BMC module into the enclosure.

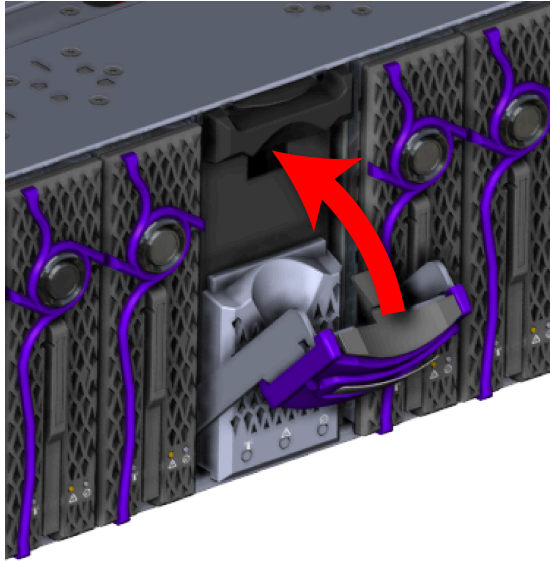
- a. Grasp the release handle with your forefinger on the bottom and thumb on the top of the release latch and press the release latch with your thumb. The handle will eject from the front of the BMC module.

**Figure 173:** BMC Module Release Handle Operation

- b. Gently slide the BMC module into the center chassis slot until the release handle is engaged with the chassis. When the handle lifts up slightly, it is an indicator that the release handle is engaged with the chassis.

**Figure 174:** BMC Module Installation

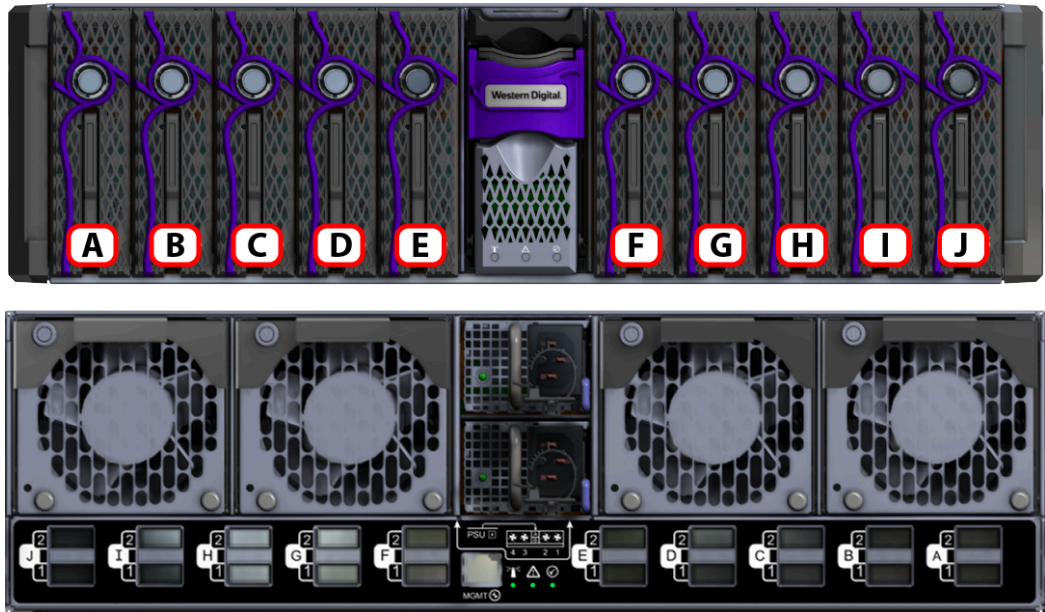
- c. Lift the release handle up and press it into the BMC module to secure it into the slot.

**Figure 175:** Secure BMC Module

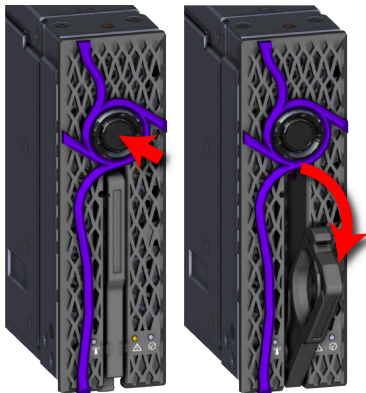
- d. Verify that the BMC module is securely latched into the chassis by pulling on the latch and ensuring the BMC module does not move when pulled. Reinstall the BMC module if it is not securely installed into the chassis.

**Step 11:** Install the OpenFlex F3100 s into the enclosure.

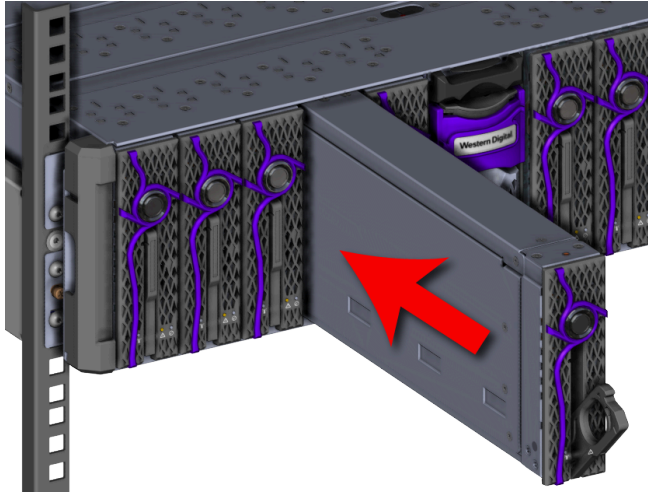
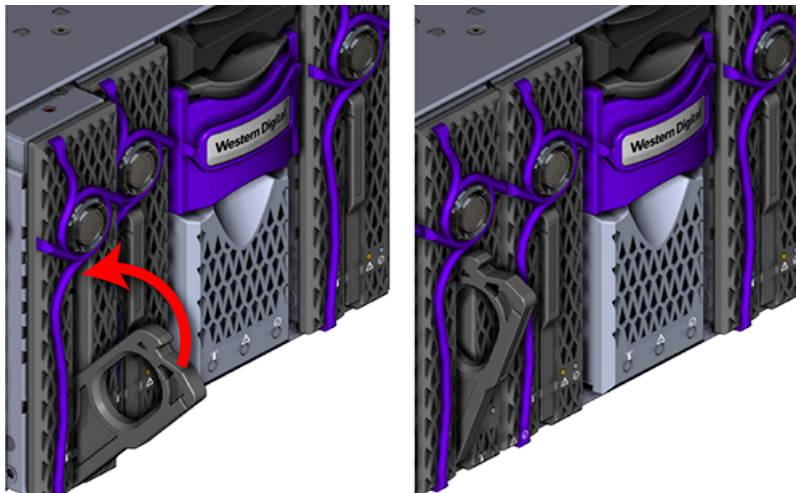
- a. Determine and record what slots are physically populated with an OpenFlex F3100 . The slots are assigned letters A through J, from left to right, when facing the front of the enclosure. These slot assignments coincide with the QSFP28 ports on the rear of the enclosure. This information will be utilized during the connection of the QSFP28 ports.

**Figure 176:** OpenFlex F3100 Slot Identification

- b. Press the release button on the front of the OpenFlex F3100 . The release handle will eject outward.

**Figure 177:** OpenFlex F3100 Release Operation

- c. Gently slide the F3100 into the E3000 slot until the release handle is engaged with the chassis. When the handle lifts up slightly, it is an indicator that the release handle is engaged with the chassis.

**Figure 178:** OpenFlex F3100 Install**Figure 179:** Release Handle Engage

- d. Rotate the release handle up and press it into the OpenFlex F3100 to secure it into the slot. When it is fully installed the user will feel the handle snap and lock into place.

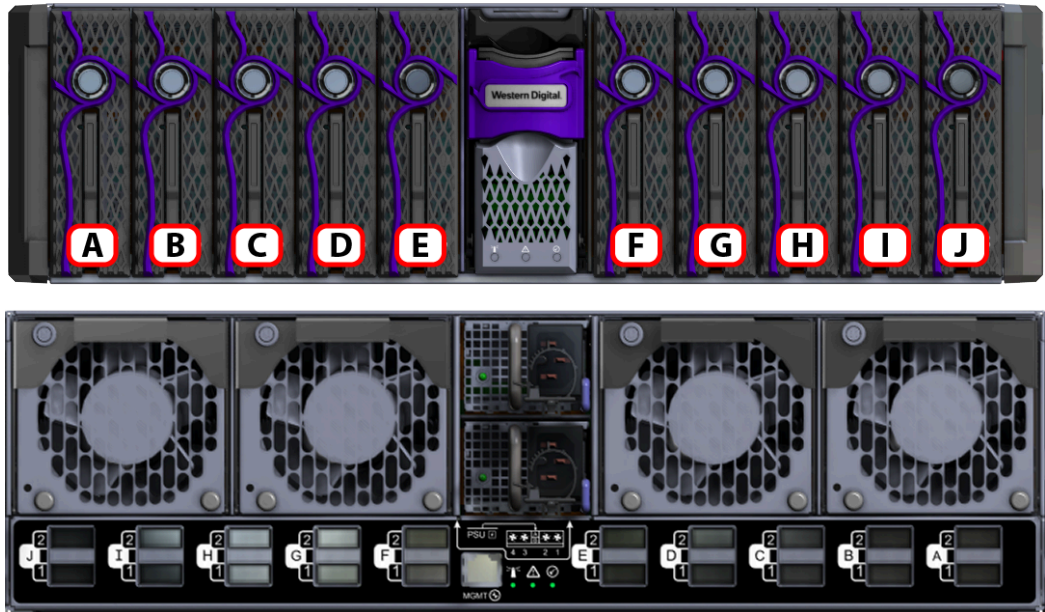
**Figure 180:** Secure OpenFlex F3100

- e. Verify that the F3100 is securely latched into the chassis by pulling on the latch and ensuring the device does not move when pulled. Reinstall the device if it is not securely installed into the chassis.



**Note:** The blue and yellow LEDs will illuminate followed shortly by the green LED. All three LEDs will remain illuminated for just over a minute until the device is initialized. Once the device are initialized, the yellow and blue LEDs will turn off and the Device Status LED that encircles the device release button will illuminate indicating that the SPDK services are running. Wait time is **not** required between the installation of multiple OpenFlex F3100 devices.

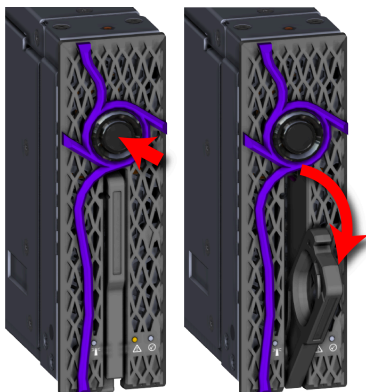
- f. Install each device in the same way the first was installed, and be sure to follow the installation order depicted in the following figure.

**Figure 181:** OpenFlex F3100 Slot Identification

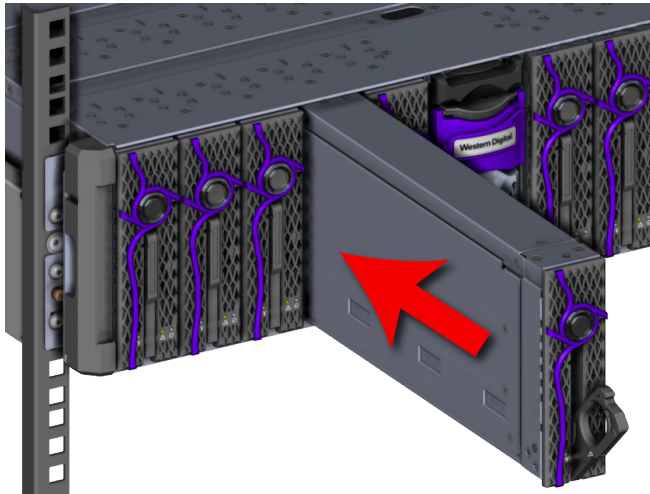
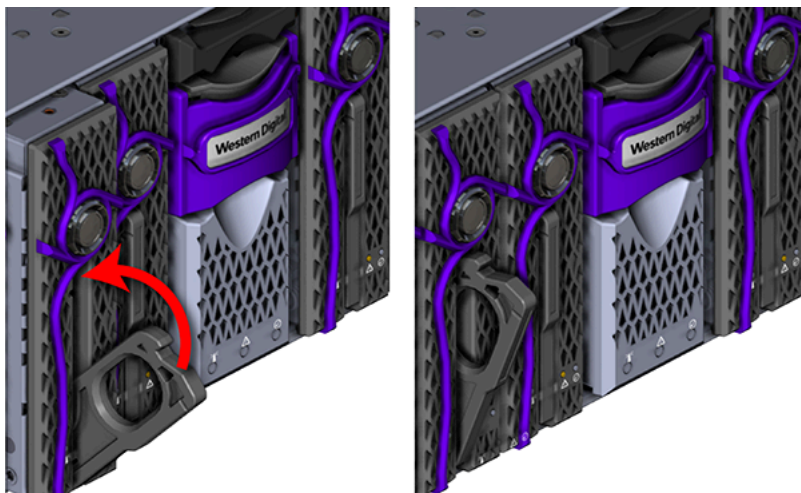
**Step 12: (Optional)** Install the device blanks into the enclosure.

**i Attention:** This step is optional because not all configurations contain device blanks. If the configuration contains a device blank, this step will be required. Blanks must be installed in any empty slots to ensure proper cooling.

- a. Press the release button on the front of the OpenFlex F3100 . The release handle will eject outward.

**Figure 182:** OpenFlex F3100 Release Operation

- b. Gently slide the device blank into a chassis device blank slot until the release handle is engaged with the chassis. When the handle lifts up slightly, it is an indicator that the release handle is engaged with the chassis.

**Figure 183:** Device Blank Install**Figure 184:** Release Handle Engage

- c. Lift the release handle up and press it into the device blank to secure it into the slot.

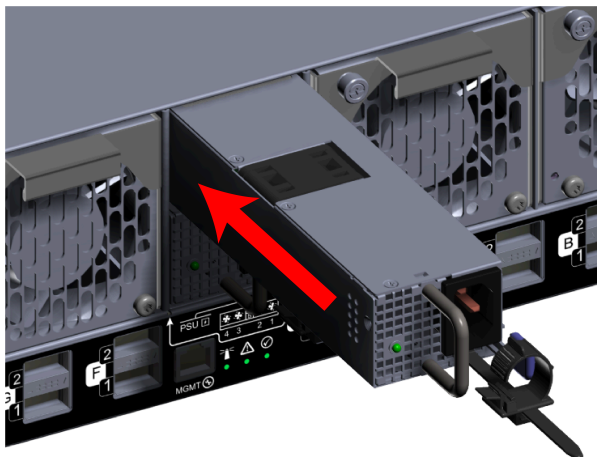


**Figure 185:** Secure Device Blank

- d. Verify that the device blank is securely latched into the chassis by pulling on the release handle and ensuring the device blank does not move when pulled. Reinstall the device blank if it is not securely installed into the chassis.
- e. Install each device blank in the same way the first was installed.

**Step 13:** Install the PSUs into the enclosure.

- a. Move to the rear of the rack, orient the PSU with the power socket located on the bottom and insert it into the PSU slot.

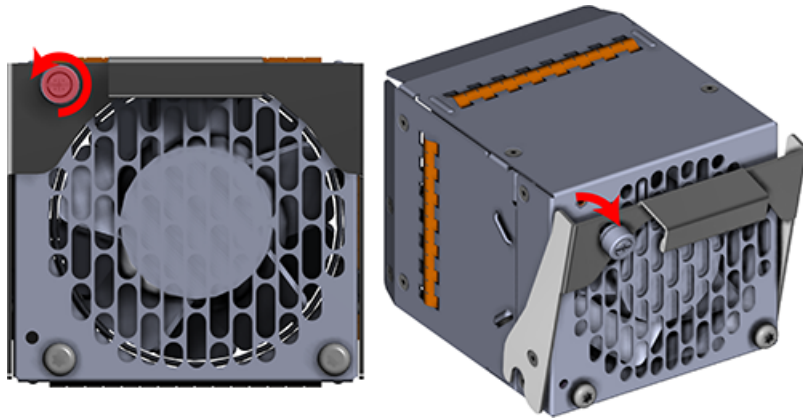
**Figure 186:** PSU Installation

- b. Verify that the PSU is fully seated and latched into the PSU slot by gently pulling on the handle.
- c. Install the remaining PSU in the same way the first was installed.

**Step 14:** Install the Fan Modules into the enclosure.

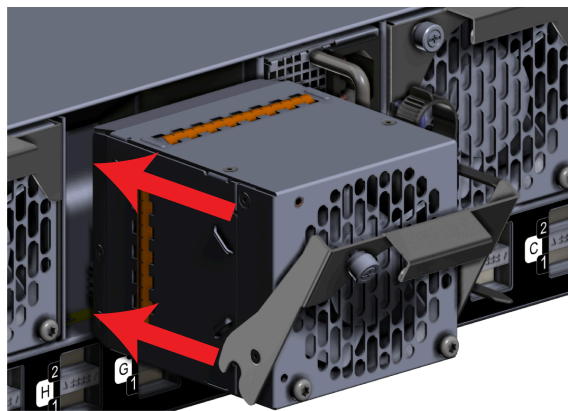
- a. Unlock the Fan Module by turning the thumbscrew counterclockwise until the screw threads are not engaged any longer. The location of the thumbscrew is shown in the following image.

**Figure 187:** Prepare Fan Module

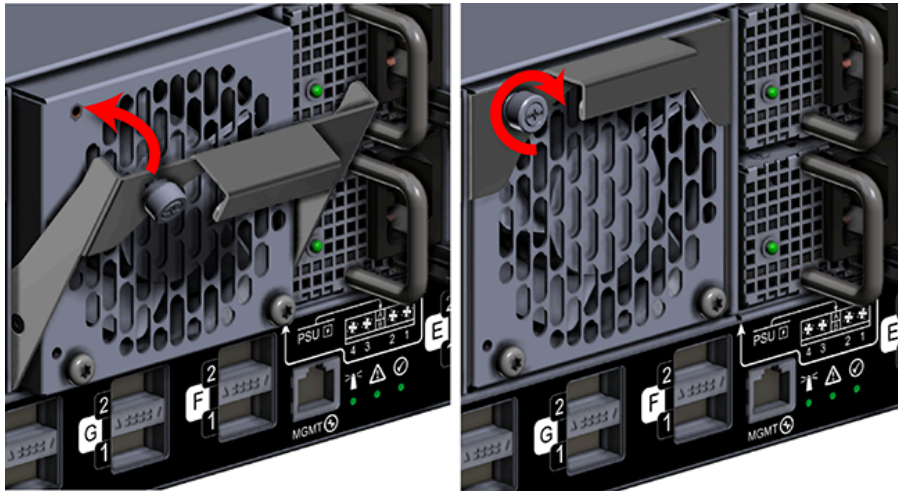


- b. Gently slide the Fan Module into the fan bay until the release handle is engaged with the chassis. When the handle lifts up slightly, it is an indicator that the release handle is engaged with the chassis.

**Figure 188:** Fan Module Engaged

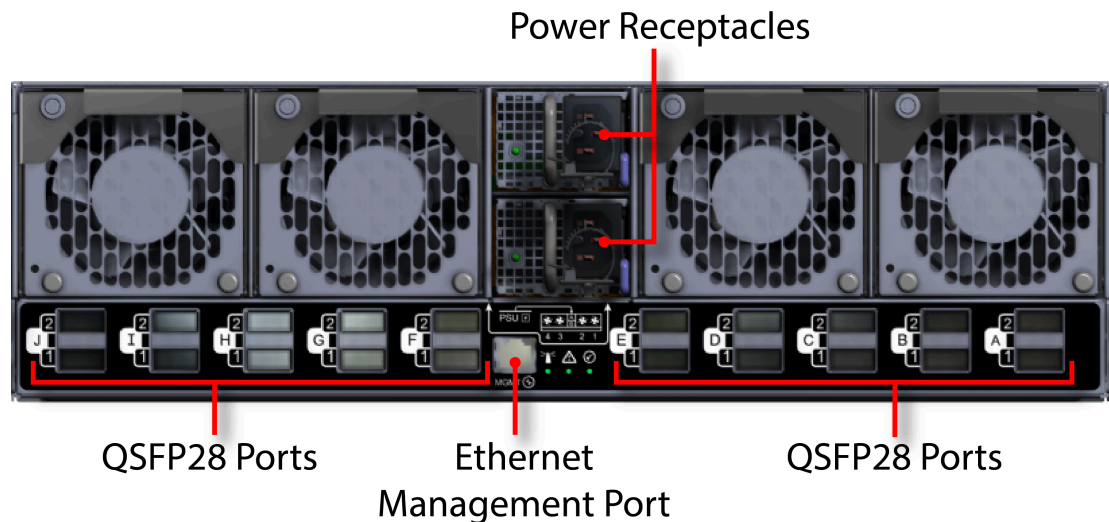


- c. Press the release handle into the Fan Module and secure it in place by turning the thumbscrew clockwise until it is tight.

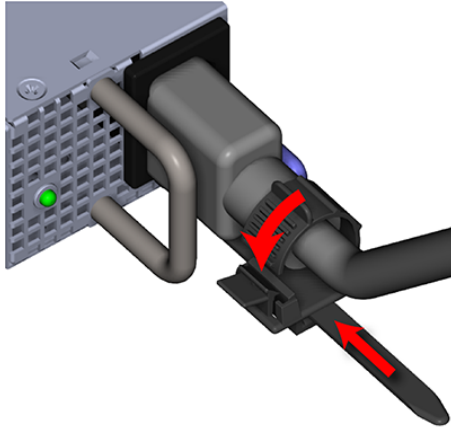
**Figure 189:** Fan Module Secure

- d. Verify that the Fan Module is securely latched into the chassis by pulling on the release handle and ensuring the Fan Module does not move when pulled. Reinstall the Fan Module if it is not securely installed into the chassis.
- e. Install each Fan Module in the same way the first was installed.

**Step 15:** Power up the E3000.

**Figure 190:** Enclosure Power and Data Connections

- a. Connect the power cables into each of the PSUs at the rear of the unit. The BMC Module, PSUs, and Fan Modules should all power on.
- b. Verify the LEDs are illuminated on the PSUs.
- c. Tighten the cable retention clips by sliding the retention clip forward on the PSUs until it stops near the cable connectors. Doing this will ensure that the retention clips function properly in the event the cable is pulled on.

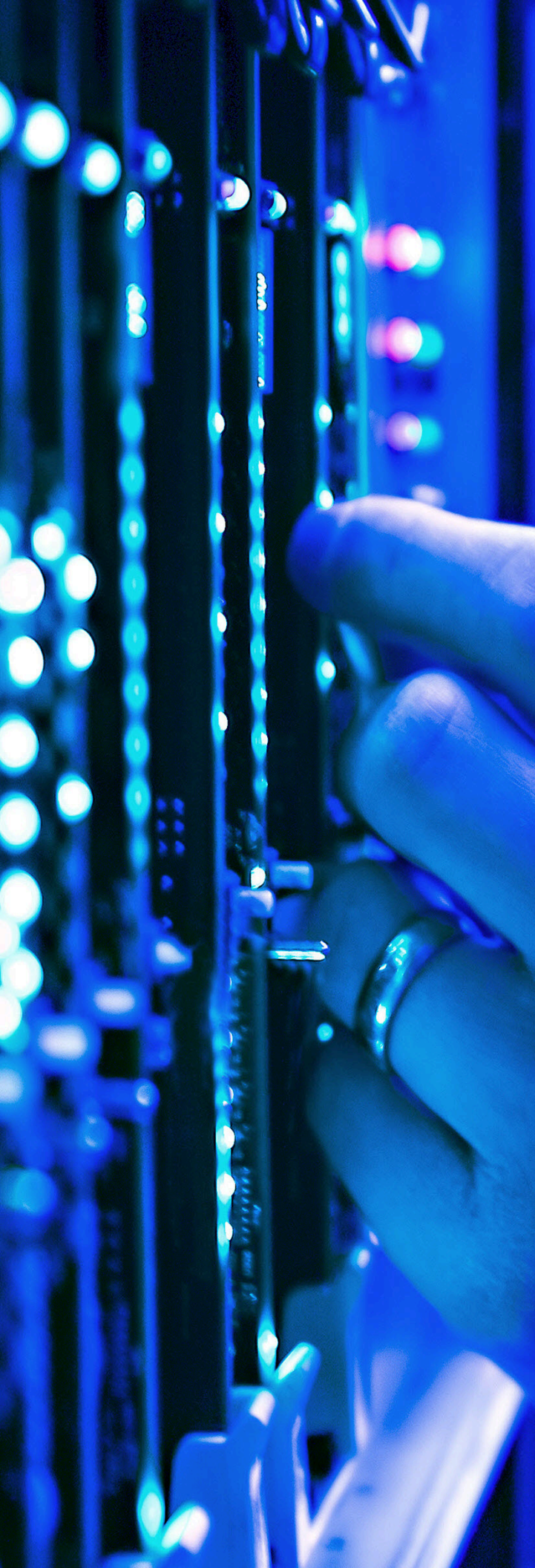
**Figure 191:** Cable Retention Clip Operation

- Step 16:** Verify the status of E3000 powerup by checking the operational status of the enclosure components in the management GUI.
- Step 17:** Connect the power and data cables to the enclosure.

# Safety

## In This Chapter:

- Electrostatic Discharge..... 136
- Optimizing Location..... 136
- Power Connections..... 136
- Power Cords..... 136
- Rackmountable Systems..... 137
- Restricted Access Location.....137



## 4.1 Electrostatic Discharge

---



**CAUTION:** Electrostatic discharge can harm delicate components inside Western Digital products.

Electrostatic discharge (ESD) is a discharge of stored static electricity that can damage equipment and impair electrical circuitry. It occurs when electronic components are improperly handled and can result in complete or intermittent failures.

Wear an ESD wrist strap for installation, service and maintenance to prevent damage to components in the product. Ensure the antistatic wrist strap is attached to a chassis ground (any unpainted metal surface). If possible, keep one hand on the frame when you install or remove an ESD-sensitive part.

Before moving ESD-sensitive parts, place them in ESD static-protective bags until you are ready to install the part.

## 4.2 Optimizing Location

---

Failure to recognize the importance of optimally locating your product, and failure to protect against electrostatic discharge (ESD) when handling your product, can result in lowered system performance or system failure.

Do not position the unit in an environment that has extreme high temperatures or extreme low temperatures. Be aware of the proximity of the unit to heaters, radiators, and air conditioners.

Position the unit so that there is adequate space around it for proper cooling and ventilation. Consult the product documentation for spacing information.

Keep the unit away from direct strong magnetic fields, excessive dust, and electronic/electrical equipment that generate electrical noise.

## 4.3 Power Connections

---

Be aware of the ampere limit on any power supply or extension cables being used. The total ampere rating being pulled on a circuit by all devices combined should not exceed 80% of the maximum limit for the circuit.

**CAUTION:** The power outlet must be easily accessible close to the unit.



Always use properly grounded, unmodified electrical outlets and cables. Ensure all outlets and cables are rated to supply the proper voltage and current.



This unit has more than one power supply connection; both power cords must be removed from the power supplies to completely remove power from the unit. There is no switch or other disconnect device.

## 4.4 Power Cords

---



Use only tested and approved power cords to connect to properly grounded power outlets or insulated sockets of the rack's internal power supply.

If an AC power cord was not provided with your product, purchase one that is approved for use in your country or region.

**CAUTION:** To avoid electrical shock or fire, check the power cord(s) that will be used with the product as follows:

- The power cord must have an electrical rating that is greater than that of the electrical current rating marked on the product.
- Do not attempt to modify or use the AC power cord(s) if they are not the exact type required to fit into the grounded electrical outlets.
- The power supply cord(s) must be plugged into socket-outlet(s) that is / are provided with a suitable earth ground.
- The power supply cord(s) is / are the main disconnect device to AC power. The socket outlet(s) must be near the equipment and readily accessible for disconnection.

## 4.5 Rackmountable Systems

---

**CAUTION:** Always install rack rails and storage enclosure according to OpenFlex F3100 and E3000 product documentation. Follow all cautions, warnings, labels, and instructions provided within the rackmount instructions.

Reliable grounding of rack-mounted equipment should be maintained.

If installed in a closed or multi-unit rack assembly, the operating ambient temperature of the rack environment may be greater than room ambient. Therefore, consideration should be given to installing the equipment in an environment compatible with the maximum ambient temperature (T<sub>ma</sub>) specified by the manufacturer.

Observe the maximum rated ambient temperature, which is specified in the product documentation.

**For safe operation of the equipment, installation of the equipment in a rack should be such that the amount of air flow is not impeded so that the safe operation of the equipment is not compromised.**

## 4.6 Restricted Access Location

---

The OpenFlex F3100 and E3000 are intended for installation in a server room or computer room where at least one of the following conditions apply:

- access can only be gained by **skilled** or **service persons** or by **instructed persons** who have been instructed about the restrictions applied to the location and about any precautions that shall be taken and/or
- access is through the use of a **tool** or lock and key, or other means of security, and is controlled by the authority responsible for the location.

## 4.7 Safety and Service

---



All maintenance and service actions appropriate to the end-users are described in the product documentation. All other servicing should be referred to an Western Digital-authorized service technician.



To avoid shock hazard, turn off power to the unit by unplugging both power cords before servicing the unit. Use extreme caution around the chassis because potentially harmful voltages are present.



When replacing a hot-plug power supply, unplug the power cord to the power supply being replaced before removing it from the OpenFlex F3100 and E3000 .



The power supply in this product contains no user-serviceable parts. Do not open the power supply. Hazardous voltage, current and energy levels are present inside the power supply. Return to manufacturer for servicing.



Use caution when accessing part of the product that are labeled as potential shock hazards, hazardous access to moving parts such as fan blades.

## 4.8 Safety Warnings and Cautions

To avoid personal injury or property damage, before you begin installing the product, read, observe, and adhere to all of the following safety instructions and information. The following safety symbols may be used throughout the documentation and may be marked on the product and/or the product packaging.

**CAUTION:** Indicates the presence of a hazard that may cause minor personal injury or property damage if the CAUTION is ignored.

**WARNING:** Indicates the presence of a hazard that may result in serious personal injury if the WARNING is ignored.



Indicates potential hazard if indicated information is ignored.



Indicates shock hazards that result in serious injury or death if safety instructions are not followed.



Indicates do not touch fan blades, may result in injury.



Indicates disconnect all power sources before servicing.



# Regulatory

## In This Chapter:

- Europe (CE Declaration of Conformity).... 140
- FCC Class A Notice..... 140
- ICES-003 Class A Notice—Avis NMB-003, Classe A..... 140
- Japanese Compliance Statement, Class A ITE..... 140
- KCC Notice (Republic of Korea Only), Class A ITE..... 140
- Taiwan Warning Label Statement, Class A ITE..... 141

## 5.1 Europe (CE Declaration of Conformity)

---

Marking by the symbol indicates compliance of this system to the applicable Council Directives of the European Union, including the Electromagnetic Compatibility Directive (2014/30/EU) and the Low Voltage Directive (2014/30/EU). A "Declaration of Conformity" in accordance with the applicable directives has been made and is on file at HGST Europe.

## 5.2 FCC Class A Notice

---

This device complies with Part 15 of the FCC Rules. Operation is subject to the following two conditions:

1. This device may not cause harmful interference.
2. This device must accept any interference received, including interference that may cause undesired operation.



**Note:** This equipment has been tested and found to comply with the limits for a Class A digital device, pursuant to Part 15 of the FCC Rules. These limits are designed to provide reasonable protection against harmful interference when the equipment is operated in a commercial environment. This equipment generates, uses, and can radiate radio frequency energy, and if it is not installed and used in accordance with the instruction manual, it may cause harmful interference to radio communications. Any modifications made to this device that are not approved by HGST may void the authority granted to the user by the FCC to operate equipment.

## 5.3 ICES-003 Class A Notice—Avis NMB-003, Classe A

---

This Class A digital apparatus complies with Canadian ICES-003. Cet appareil numérique de la classe A est conforme à la norme NMB-003 du Canada.

## 5.4 Japanese Compliance Statement, Class A ITE

---

The following Japanese compliance statement pertains to VCCI EMI regulations:

この装置は、クラスA機器です。この装置を住宅環境で使用すると電波妨害を引き起こすことがあります。この場合には使用者が適切な対策を講ずるよう要求されることがあります。

VCCI – A

### English translation:

This is a Class A product based on the Technical Requirement of the Voluntary Control Council for Interference by Information Technology (VCCI). In a domestic environment, this product may cause radio interference, in which case the user may be required to take corrective actions.

## 5.5 KCC Notice (Republic of Korea Only), Class A ITE

---

기종별	사용자안내문
A급기기 (업무용 정보통신기기)	이 기기는 업무용으로 전자파허용등록을 한 기기이오니 판매자 또는 사용자는 이 점을 주의하시기 바라며 만약 잘못 판매 또는 구입하였을 때에는 가정용으로 교환하시기 바랍니다.

**English translation:**

Please note that this device has been approved for business purposes with regard to electromagnetic interference. If you find that this device is not suitable for your use, you may exchange it for a non-business device.

## 5.6 Taiwan Warning Label Statement, Class A ITE

---

**警告使用者:**

此為甲類資訊技術設備，於居住環境中使用時，  
可能會造成射頻擾動，在此種情況下，使用者會  
被要求採取某些適當的對策。

**English translation:**

This is a Class A product. In a domestic environment, this product may cause radio interference, in which case, the user may be required to take adequate measures.