



**KVM over IP Matrix Series:
KVM over IP Extender &
CCKM KE Matrix Manager Software
User Manual**



EMC Information

FEDERAL COMMUNICATIONS COMMISSION INTERFERENCE

STATEMENT: This equipment has been tested and found to comply with the limits for a Class A digital device, pursuant to Part 15 of the FCC Rules. These limits are designed to provide reasonable protection against harmful interference when the equipment is operated in a commercial environment. This equipment generates, uses, and can radiate radio frequency energy and, if not installed and used in accordance with the instruction manual, may cause harmful interference to radio communications. Operation of this equipment in a residential area is likely to cause harmful interference in which case the user will be required to correct the interference at his own expense.

The device complies with Part 15 of the FCC Rules. Operation is subject to the following two conditions: (1) this device may not cause harmful interference, and (2) this device must accept any interference received, including interference that may cause undesired operation.

FCC Caution: Any changes or modifications not expressly approved by the party responsible for compliance could void the user's authority to operate this equipment.

Warning: Operation of this equipment in a residential environment could cause radio interference.

KCC Statement

이 기기는 업무용 (A 급) 전자파 적합기기로서 판매자 또는 사용자는 이 점을 주의하시기 바라며, 가정외의 지역에서 사용하는 것을 목적으로 합니다.

RoHS

This product is RoHS compliant.



User Information

Online Registration

Be sure to register your product at our online support center:

International	http://eservice.aten.com
---------------	---

Telephone Support

For telephone support, call this number:

International	886-2-8692-6959
China	86-400-810-0-810
Japan	81-3-5615-5811
Korea	82-2-467-6789
North America	1-888-999-ATEN ext 4988 1-949-428-1111

User Notice

All information, documentation, and specifications contained in this manual are subject to change without prior notification by the manufacturer. The manufacturer makes no representations or warranties, either expressed or implied, with respect to the contents hereof and specifically disclaims any warranties as to merchantability or fitness for any particular purpose. Any of the manufacturer's software described in this manual is sold or licensed *as is*. Should the programs prove defective following their purchase, the buyer (and not the manufacturer, its distributor, or its dealer), assumes the entire cost of all necessary servicing, repair and any incidental or consequential damages resulting from any defect in the software.

The manufacturer of this system is not responsible for any radio and/or TV interference caused by unauthorized modifications to this device. It is the responsibility of the user to correct such interference.

The manufacturer is not responsible for any damage incurred in the operation of this system if the correct operational voltage setting was not selected prior to operation. PLEASE VERIFY THAT THE VOLTAGE SETTING IS CORRECT BEFORE USE.

About This Manual

This User Manual is provided to help you get the most from your KVM over IP Matrix System. It covers all aspects of installation, configuration and operation. An overview of the information found in the manual is provided below.

The KVM over IP Extender models covered in this user manuals are:

Models	Product Names
KE6900	DVI Single Display KVM over IP Extender (Transmitter & Receiver)
KE6900A	DVI-I Single Display KVM over IP Extender (Transmitter & Receiver)
KE6900ST	DVI KVM over IP Extender Lite
KE6910	DVI-D Dual Link KVM over IP Extender (Transmitter & Receiver)
KE6912	DVI-D Dual Link KVM over IP Extender (Transmitter & Receiver) with PoE
KE6920	DVI-D Dual Link KVM over IP Extender (Transmitter & Receiver) with Dual SFP
KE6922	DVI-D Dual Link KVM over IP Extender (Transmitter & Receiver) with Dual SFP & PoE
KE6940	DVI Dual Display KVM over IP Extender (Transmitter & Receiver)
KE6940A	DVI-I Dual Display KVM over IP Extender (Transmitter & Receiver)
KE8900S	Slim HDMI KVM over IP Extender (Transmitter & Receiver)
KE8950	4K HDMI Single Display KVM over IP Extender (Transmitter & Receiver)
KE8952	4K HDMI Single Display KVM over IP Extender (Transmitter & Receiver) with PoE
KE9900ST	Slim DisplayPort KVM over IP Extender (Transmitter)
KE9950	4K DisplayPort KVM over IP Extender (Transmitter & Receiver)
KE9952	4K DisplayPort KVM over IP Extender (Transmitter & Receiver) with PoE

Copyright © 2020 ATEN® International Co., Ltd.
Manual Date: 2020-06-23

Altusen and the ATEN logo are registered trademarks of ATEN International Co., Ltd. All rights reserved. All other brand names and trademarks are the registered property of their respective owners.

Chapter 1, Introduction, introduces you to the KVM over IP Matrix System. Its purpose, features and benefits are presented, and its front and back panel components are described.

Chapter 2, Hardware Setup, provides step-by-step instructions for setting up your installation, and explains some basic operation procedures.

Chapter 3, OSD Operation, explains the fundamental concepts involved in operating the KE6900 / KE6900A / KE6900ST / KE6910 / KE6912 / KE6920 / KE6922 / KE6940 / KE6940A / KE8900S / KE8950 / KE8952 / KE9900ST / KE9950 / KE9952, and provides a complete description of the On Screen Displays (OSDs) and how to work with them.

Chapter 4, Software Installation, explains the administrative procedures that are required to download and install the KE Matrix Manager software on Windows and Linux computers.

Chapter 5, Browser / Telnet Operation, explains how to log in to the KE Matrix Manager with a web browser, and describes the features, functions, and how to work with the browser's main interface.

Chapter 6, System Status, explains how to use the KE Matrix Manager's System Status panel to manage Transmitters, Receivers, Users, Profiles and Logs.

Chapter 7, System Settings, explains the KE Matrix Manager's system settings, which include the General, ANMS, LDAP/AD, RADIUS, TACACS+ authentication, F/W Upgrade, Redundancy, Backup/Restore, Certificates, and Sessions tabs.

Chapter 8, Connections, describes how to use the KE Matrix Manager's Connections panel to view and disconnect Transmitter and Receiver connections.

Chapter 9, Scheduled Profile, describes how to use the KE Matrix Manager's Scheduled Profile panel to view active profile schedules.

Chapter 10, Sessions, describes how to use the KE Matrix Manager's Sessions panel to view and disconnect user sessions.

Chapter 11, Firmware Upgrade Utility, explains how to download and use the Firmware Upgrade Utility to install new firmware on the devices.

Chapter 12, CLI Commands, provides a complete list of the serial protocol and TCP/IP commands used when utilizing the RS-232 Serial Port or a network connection to configure the KE devices.

An Appendix, at the end of the manual provides technical and troubleshooting information.

Contents

EMC Information	ii
RoHS	ii
User Information	iii
Online Registration	iii
Telephone Support	iii
User Notice	iii
About This Manual	iv
Contents	vii
Package Contents	xv
KE6900 / KE6940	xv
KE6900A / KE6940A	xv
KE6900ST	xvi
KE6910 / KE6912	xvi
KE6920 / KE6922	xvi
KE8900S	xvii
KE8950 / KE8952	xviii
KE9900ST	xviii
KE9950 / KE9952	xviii
Conventions	xx
Product Information	xx

Chapter 1. Introduction

Overview	1
Features	4
Supported Video Resolutions	6
Requirements	7
Console	7
Computers	7
Cables	7
Minimum Hardware/Software Requirements	7
Components	9
KE6900T (Transmitter) Front View	9
KE6900T (Transmitter) Rear View	10
KE6900R (Receiver) Front View	12
KE6900R (Receiver) Rear View	14
KE6900AT (Transmitter) Front View	16
KE6900AT (Transmitter) Rear View	17
KE6900AR (Receiver) Front View	19
KE6900AR (Receiver) Rear View	21
KE6910T / KE6912T (Transmitter) Front View	23
KE6910T / KE6912T (Transmitter) Rear View	24
KE6910R / KE6912R (Receiver) Front View	26
KE6910R / KE6912R (Receiver) Rear View	27
KE6920T / KE6922T (Transmitter) Front View	29

KE6920T / KE6922T (Transmitter) Rear View	30
KE6920R / KE6922R (Receiver) Front View	32
KE6920R / KE6922R (Receiver) Rear View	33
KE6940T (Transmitter) Front View	35
KE6940T (Transmitter) Rear View	36
KE6940R (Receiver) Front View	38
KE6940R (Receiver) Rear View	40
KE6940AT (Transmitter) Front View	42
KE6940AT (Transmitter) Rear View	43
KE6940AR (Receiver) Front View	45
KE6940AR (Receiver) Rear View	47
KE6900ST (Transmitter) Front, Rear and Top View	49
KE8950T / KE8952T (Transmitter) Front View	51
KE8950T / KE8952T (Transmitter) Rear View	52
KE8950R / KE8952R (Receiver) Front View	54
KE8950R / KE8952R (Receiver) Rear View	56
KE8900ST (Transmitter) Front, Rear and Side View	58
KE8900SR (Receiver) Front, Rear and Side View	60
KE9900ST (Transmitter) Front, Rear and Side View	62
KE9950T / KE9952T (Transmitter) Front View	64
KE9950T / KE9952T (Transmitter) Rear View	65
KE9950R / KE9952R (Receiver) Front View	67
KE9950R / KE9952R (Receiver) Rear View	68
PoE Power Redundancy	69

Chapter 2. Hardware Setup

Mounting	71
Attaching the Bracket	72
Non-Slim Transmitters	72
Slim Transmitters - KE6900ST	73
Slim Transmitters - KE8900ST / KE9900ST	73
Rack Mount	75
Non-Slim Transmitters	75
Slim Transmitters - KE6900ST	76
Slim Transmitters - KE8900ST / KE9900ST	76
Wall Mounting	77
Non-Slim Transmitters	77
Slim Transmitters - KE6900ST	78
Slim Transmitters - KE8900ST / KE9900ST	78
KE6900 / KE6940 Point-to-Point Installation	79
KE6900 / KE6940 Point-to-Point Installation 1 of 2	80
KE6900 / KE6940 Point-to-Point Installation 2 of 2	81
KE6900A / KE6940A Point-to-Point Installation	82
KE6900A / KE6940A Point-to-Point Installation 1 of 2	83
KE6900A / KE6940A Point-to-Point Installation 2 of 2	84
KE6910 / KE6912 Point-to-Point Installation	85

KE6910 / KE6912 Point-to-Point Installation 1 of 2	86
KE6910 / KE6912 Point-to-Point Installation 2 of 2	87
KE6920 / KE6922 Point-to-Point Installation	88
KE6920 / KE6922 Point-to-Point Installation 1 of 2	89
KE6920 / KE6922 Point-to-Point Installation 2 of 2	90
KE8950 / KE8952 Point-to-Point Installation	91
KE8950 / KE8952 Point-to-Point Installation 1 of 2	92
KE8950 / KE8952 Point-to-Point Installation 2 of 2	93
KE6900ST Point-to-Point Installation	94
Setting up a LAN Installation	94
KE8900S Point-to-Point Installation	96
Setting up a LAN Installation	96
KE9900ST Point-to-Point Installation	98
Setting up a LAN Installation	98
KE9950 / KE9952 Point-to-Point Installation	100
KE9950 / KE9952 Point-to-Point Installation 1 of 2	101
KE9950 / KE9952 Point-to-Point Installation 2 of 2	102
KE6900 / KE6940 LAN Installation	103
KE6900 / KE6940 Network Installation Diagram 1 of 2	105
KE6900 / KE6940 Network Installation Diagram 2 of 2	106
KE6900A / KE6940A LAN Installation	107
KE6900A / KE6940A Network Installation Diagram 1 of 2	109
KE6900A / KE6940A Network Installation Diagram 2 of 2	110
KE6910 / KE6912 LAN Installation	111
KE6910 / KE6912 Network Installation Diagram 1 of 2	112
KE6910 / KE6912 Network Installation Diagram 2 of 2	113
KE6920 / KE6922 LAN Installation	114
KE6920 / KE6922 Network Installation Diagram 1 of 2	116
KE6920 / KE6922 Network Installation Diagram 2 of 2	117
KE8950 / KE8952 LAN Installation	118
KE8950 / KE8952 Network Installation Diagram 1 of 2	120
KE8950 / KE8952 Network Installation Diagram 2 of 2	121
KE9950 / KE9952 LAN Installation	122
KE9950 / KE9952 Network Installation Diagram 1 of 2	123
KE9950 / KE9952 Network Installation Diagram 2 of 2	124
Network Configuration	125
Exit OSD	126
Default IP Addresses	126
KE I/O Ports	127
LED Display	128
Authentication Lock (KE6910 / KE6912 only)	128

Chapter 3.OSD Operation

Overview	129
Invoking the OSD	129
Touch Screen Calibration	129

OSD Hotkeys	130
Microphone Hotkey	130
OSD Interface	131
Receiver Configuration	132
Network	132
Properties	133
Regular Version	133
Slim Version	136
System	139
Transmitter Configuration	140
Network	140
Properties	141
System	144
User Preferences	145
Connecting	146
Logging in for the First Time	147
Connections Page	148
List Mode	148
Array Mode	151
Profile Page	153
Push Content	154
Pull Content	156

Chapter 4. Software Installation

Overview	159
Download - Trial Version	159
KE Matrix Manager Software Install	161
Upgrading Trial Version	164
Linux Installation	165

Chapter 5. Browser / Telnet Operation

Overview	169
Logging In	169
The KE Matrix Manager Main Page	171
Web Components	171
Installation Wizard	173
Instant Link	176
RS-232 / Telnet	178
Telnet	178
RS-232	179
Configuration Menu	180
Main Menu	180
1. Network	181
2. Properties	181
3. System	182

Chapter 6. System Status

Overview	183
System Status	184
Transmitter	186
Transmitter Configuration	188
Copy & Paste	193
Virtual Transmitter	194
Intelligent Dual Video Output Management	195
Transmitter Group	196
Transmitter Permissions	197
Receiver	199
Receiver Configuration	201
Copy & Paste	205
Receiver Group	206
Video Wall	207
Receiver Permissions	210
Account	211
Users	212
Adding Users	212
Modifying Users	214
Deleting Users	214
Groups	215
Adding Groups	215
Modifying Groups	216
Deleting Groups	216
Permissions	217
Assigning Device Permissions	217
Profile	219
Adding a Profile	220
Adding a Schedule	223
Log	224

Chapter 7. System Settings

Overview	225
General	225
Connection Redundancy (KE6910 / 6912 only)	228
ANMS	231
Event Destination	231
Authentication & Authorization	233
FW Upgrade	236
Firmware Upgrade Recovery	237
Redundancy	238
Backup / Restore	240
Backup	241
Restore	241
Certificates	242
Private Certificate	242

Certificate Signing Request	243
Sessions	245
Chapter 8.Connections	
Overview	247
Connections	248
Chapter 9.Scheduled Profile	
Overview	251
Chapter 10.Sessions	
Overview	253
Chapter 11.Firmware Upgrade Utility	
Preparation	255
Starting the Upgrade	256
Upgrade Succeeded	258
Firmware Upgrade Recovery	259
Chapter 12.CLI Commands	
Serial Control Protocol Commands	261
Configuring the Serial Port	261
Device/Profile Commands	262
Telnet	262
Verification	262
Switch Port Command	263
Mute Command	267
Profile Command	269
EDID Command	271
Reset Command	273
RS-232 Command	274
OSD Command	277
List Command	278
Read Command	280
Set Command	284
Appendix	
Safety Instructions	293
General	293
Rack Mounting	295
Technical Support	296
International	296
North America	296
Specifications	297
KE6900T / KE6940T	297
KE6900R / KE6940R	299
KE6900AT / KE6940AT	300
KE6900AR / KE6940AR	302

KE6900ST	303
KE6910	304
KE6912	306
KE6920	308
KE6922	310
KE8900S	312
KE8950T / KE8952T	313
KE8950R / KE8952R	314
KE9900ST	315
KE9950	316
KE9952	318
Optional Rack Mounting	320
Dual Rack Mounting	320
Transmitter Dual Rack Mounting	320
Receiver Dual Rack Mounting	322
Single Rack Mounting	324
IP Installer	326
Trusted Certificates	327
Overview	327
Self-Signed Private Certificates	328
Examples	328
Importing the Files	328
Reset All Information	329
Default Password Pins	330
RS-232 Pin Assignments	336
Transmitter Front RS-232 Port	336
Multicast IP Address	337
KE Multicast Rule	337
Multicast IP Formula	337
If X is between 0 ~ 127	337
If X is between 128 ~ 192	338
If X is 192 or higher	338
Keys to Network Performance	339
Build a Network Diagram	339
Other Factors	339
Choose a High Performance Switch	341
Layer 2 or Layer 3 Switches	341
Considerations	341
Number of ports	341
Stackable verse Standalone	341
What Stackable Switches Can do:	342
Switch Specifications	342
Configuring Switches and KE Devices	343
KE transmitter Settings:	343
Recommended Network Switches	343
Setup CCKM Server IP address on Windows	345

Limited Warranty 346

Package Contents

KE6900 / KE6940

Package content of KE6900T / KE6940T DVI Single/Dual Display KVM over IP Extender (Transmitter):

- 1 Transmitter
- 1 USB DVI-D KVM Cable
- 1 DVI-D Cable 1.8 m (for KE6940T)
- 1 Foot Pad Set
- 1 Power Adapters
- 1 Mounting Kit
- 1 User Instructions*

Package content of KE6900R / KE6940R DVI Single/Dual Display KVM over IP Extender (Receiver):

- 1 Receiver
- 1 Power Adapters
- 1 User Instructions*

KE6900A / KE6940A

Package content of KE6900AT / KE6940AT DVI-I Single / Dual Display KVM over IP Transmitter:

- 1 Transmitter
- 1 USB DVI-D KVM Cable
- 1 DVI-D Cable 1.8 m (for KE6940AT)
- 1 Power Adapter & Power Cord
- 1 Foot Pad Set
- 1 Mounting Kit
- 1 User Instructions*

Package content of KE6900AR / KE6940AR DVI-I Single / Dual Display KVM over IP Receiver:

- 1 Receiver
- 1 Power Adapter & Power Cord
- 1 User Instructions*

KE6900ST

Package content of KE6900ST DVI KVM over IP Extender Lite:

- 1 Transmitter
- 1 USB DVI-D KVM Cable
- 1 Foot Pad Set
- 1 Power Adapter
- 1 Mounting Kit
- 1 User Instructions*

KE6910 / KE6912

Package content of KE6910T / KE6912T DVI-D Dual Link KVM over IP Extender (Transmitter):

- 1 Transmitter
- 1 USB DVI-D KVM Cable
- 1 Power Adapter & Power Cord (for KE6910T)
- 1 Foot Pad Set
- 1 Mounting Kit
- 1 User Instructions*

Package content of KE6910R / KE6912R DVI-D Dual Link KVM over IP Extender (Receiver):

- 1 Receiver
- 1 Power Adapter & Power Cord (for KE6910R)
- 1 User Instructions*

KE6920 / KE6922

Package content of KE6920T DVI-D Dual Link KVM over IP Extender with Dual SFP (Transmitter) / KE6922T DVI-D Dual Link KVM over IP Extender with Dual SFP & PoE (Transmitter):

- 1 Transmitter
- 1 USB DVI-D KVM Cable
- 1 Power Adapter & Power Cord (for KE6910T)
- 1 Foot Pad Set
- 1 Mounting Kit
- 1 User Instructions*

Package content of KE6920R DVI-D Dual Link KVM over IP Extender with Dual SFP (Receiver) / KE6922R DVI-D Dual Link KVM over IP Extender with Dual SFP & PoE (Receiver):

- 1 Receiver
- 1 Power Adapter & Power Cord (for KE6910R)
- 1 User Instructions*

KE8900S

Package content of KE8900ST Slim HDMI KVM over IP Extender (Transmitter):

- 1 Transmitter
- 1 USB HDMI KVM Cable
- 1 Foot Pad Set
- 1 Power Adapter
- 1 Mounting Kits
- 1 HDMI Lockpro
- 1 User Instructions*

Package content of KE8900SR Slim HDMI KVM over IP Extender (Receiver):

- 1 Receiver
- 1 Power Adapter
- 1 Mounting Kits
- 1 HDMI Lockpro
- 1 User Instructions*

KE8950 / KE8952

Package content of KE8950T / KE8952T 4K HDMI Single Display KVM over IP Extender (Transmitter):

- 1 Transmitter
- 1 USB HDMI KVM Cable
- 1 Foot Pad Set
- 1 Power Adapter & Power Cord (for KE8950T)
- 1 Mounting Kit
- 1 HDMI Lockpro
- 1 User Instructions*

Package content of KE8950R / KE8952R 4K HDMI Single Display KVM over IP Extender (Receiver):

- 1 Receiver
- 1 Power Adapter & Power Cord (for KE8950R)
- 1 HDMI Lockpro
- 1 User Instructions*

KE9900ST

Package content of KE9900ST Slim DisplayPort KVM over IP Extender (Transmitter):

- 1 Transmitter
- 1 DisplayPort Cable
- 1 USB 2.0 Type-A to Type-B Cable
- 1 Power Adapter
- 1 Mounting Kit
- 1 User Instructions*

KE9950 / KE9952

Package content of KE9950T / KE9952T 4K DisplayPort KVM over IP Extender (Transmitter):

- 1 Transmitter

- 1 DisplayPort Cable
- 1 USB 2.0 Type-A to Type-B Cable
- 1 Foot Pad Set
- 1 Power Adapter & Power Cord (for KE9950T)
- 1 Mounting Kit
- 1 User Instructions*

Package content of KE9950R / KE9952R 4K DisplayPort KVM over IP Extender (Receiver):

- 1 Receiver
- 1 Power Adapter & Power Cord (for KE9950R)
- 1 User Instructions*

* Features may have been added to the KE6900 / KE6900A / KE6900ST / KE6910 / KE6912 / KE6920 / KE6922 / KE6940 / KE6940A / KE8900S / KE8950 / KE8952 / KE9900ST / KE9950 / KE9952 since this manual was published. Please visit our website to download the most up-to-date version.

Check to make sure that all of the components are present and in good order. If anything is missing, or was damaged in shipping, contact your dealer. Read this manual thoroughly and follow the installation and operation procedures carefully to prevent any damage to the KE6900 / KE6900A / KE6900ST / KE6910 / KE6912 / KE6920 / KE6922 / KE6940 / KE6940A / KE8900S / KE8950 / KE8952 / KE9900ST / KE9950 / KE9952 or to any other devices on the installation.

Conventions

This manual uses the following conventions:

- Monospaced Indicates text that you should key in.
- [] Indicates keys you should press. For example, [Enter] means to press the **Enter** key. If keys need to be chorded, they appear together in the same bracket with a plus sign between them: [Ctrl+Alt].
1. Numbered lists represent procedures with sequential steps.
- ◆ Bullet lists provide information, but do not involve sequential steps.
- Indicates selecting the option (on a menu or dialog box, for example), that comes next. For example, Start → Run means to open the *Start* menu, and then select *Run*.
-  Indicates critical information.

Product Information

For information about all ATEN products and how they can help you connect without limits, visit ATEN on the Web or contact an ATEN Authorized Reseller. Visit ATEN on the Web for a list of locations and telephone numbers:

International	http://www.aten.com
North America	http://www.aten-usa.com

Chapter 1

Introduction

Overview

The KVM over IP Matrix System is a solution that combines KE Series KVM over IP Extenders (KE6900, KE6900A, KE6940, KE6940A, KE6900ST, KE6910, KE6912, KE6920, KE6922, KE8900S, KE8950, KE8952, KE9900ST, KE9950, KE9952), with the KE Matrix Manager Software (CCKM) to extend, control and monitor access to computers, across a network, in a multitude of ways. The system lets you setup a matrix of remote KVM consoles that access computers across a network, with the flexibility to control and configure each connection.

The high-performance IP-based KE Extenders are consisted of a transmitter and a receiver. The transmitter connects to a computer to deliver the computer's data to the receiver to collectively provide console access from a remote or separate location. The computer can be accessed from the remote console via a standard TCP/IP network or direct Ethernet cable connection. This is perfect for any installation where you need to place the console where it is convenient, but you want the computer to reside in a secure location - away from the keyboard, mouse and display.

The extenders support flawless and lossless video compression quality with ultra low latency, some extenders also support 2K x 2K video resolution (2048 x 2048 @ 60Hz), which is used widely in the Air Traffic Control (ATC) industry. For a list of video resolution support, refer to *Supported Video Resolutions* on page 6.

For power redundancy, some extenders have dual power supplies, some provide single power supply with a Power over Ethernet (PoE) LAN port, while some provide dual power supplies and a PoE LAN port.

Some extenders support Fiber Channel over Ethernet via SFP fiber modules* which connect to a network switch at speeds up to 1 Gbps. The extenders can connect unit-to-unit or over a TCP/IP network via Gigabit Ethernet or the SFP ports. Connecting both methods allows network failover.

The non-slim KE over IP Extenders have local On Screen Display (OSD) on the receiver end to configure both receiver and transmitter - for easy setup and operation. Both the transmitter and receiver have RS-232 ports to connect to a

serial terminal for configuration or serial devices such as touchscreens and barcode scanners.

Slimmer versions of KE over IP Extenders are also available. These are KE6900ST, KE8900S or KE9900ST, and are cost and space saving alternatives for installations with extenders that don't need a local console or audio transmission, but want the connectivity features of advanced KE models. KE6900ST is a slim KVM over IP Transmitter that supports DVI input. KE8900S offers a slim KVM over IP Transmitter (KE8900ST) and a slim KVM over IP Receiver (KE8900SR) to respectively support HDMI video input from the computer and one HDMI monitor output. KE9900ST is a slim KVM over IP Transmitter that supports DisplayPort input. In addition to a DC power jack, both the KE8900ST and KE9900ST transmitters have an extra DC terminal block each for convenient installation.

Since different KE over IP Extenders support different types of video interfaces (DVI, HDMI, DisplayPort, etc.), video resolutions, power redundancy function and network failover feature, administrators/users may select and tailor what is currently best for your environment, and for expected or unexpected future expansions.

Refer to the table below for the variations in interfaces, functions and features:

Models	DVI	HDMI	DisplayPort	Power Redundancy via PoE*	Power Redundancy via Second Power Jack	Network Failover - SFP
KE6900	1	-	-	-	-	-
KE6900A	1	-	-	-	1	1
KE6900ST	1	-	-	-	-	-
KE6910	1	-	-	-	1	1
KE6912	1	-	-	1	-	1
KE6920	1	-	-	-	1	2
KE6922	1	-	-	1	1	2
KE6940	2	-	-	-	-	-
KE6940A	2	-	-	-	1	1
KE8900S	-	1	-	-	-	-
KE8950	-	1	-	-	-	1
KE8952	-	1	-	1	-	1
KE9900ST	-	-	1	-	-	-
KE9950	-	-	1	-	1	1
KE9952	-	-	1	1	-	1

*Power redundancy via PoE requires power board version B01G or later (see *PoE Power Redundancy* on page 69 for more details).

KVM over IP Extenders allow flexible setup as they can make console-to-computer connections in several ways: one-to-one (Extender mode), one-to-

many (Splitter mode), many-to-one (Switch mode), or many-to-many (Matrix mode).

The KE Matrix Manager Software (CCKM) allows you to define the aforementioned matrix connections and manage KE Extenders with features such as auto-detection of KE Extenders, username/password authentication, switching and sharing of connections, scheduling, permissions and more. Whether you're extending computer access for Monitoring, Broadcasting, Editing or Workstation setup, the KVM over IP Matrix System gives you the flexibility and control to manage one or hundreds of extended connections. For more detailed feature list, refer to *Features* on page 4.

Note: The SFP module is sold separately. You can choose the 2A-136G, a multi-mode SFP module that provides 1 GbE connectivity up to 550 meters; or the 2A-137G, a single-mode SFP module that provides 1 GbE connectivity up to 10 kilometers. Visit ATEN's website or contact your ATEN dealer for more information.

Features

- ◆ Remote KVM console access of computers over LAN or Ethernet cable connection
- ◆ Dual console operation – control your system from both the Transmitter and Receiver by USB keyboard, monitor, and mouse
- ◆ RS-232 serial ports allows you to connect to a serial terminal for configuration, and serial devices such as touchscreens and barcode scanners¹
- ◆ Superior video quality² – up to 1920 x 1200 @ 60 Hz with 24-bit color depth (KE69 Series); up to 3840 x 2160 @ 30 Hz (4:4:4) with 36-bit color depth (KE89 Series, KE99 Series)
- ◆ Supports standard resolutions from 640 x 480 to 1920 x 1200 @ 60 Hz (KE69 Series); and resolutions from 640 x 480 to 3840 x 2160 @ 30 Hz (KE89 Series, KE99 Series)
- ◆ Supports 2K x 2K video resolution (2048 x 2048 @ 60Hz) (KE6910/KE6912/KE6920/KE6922)
- ◆ OSD (On Screen Display) on the Receiver configures Tx / Rx devices
- ◆ Supports KE Matrix Manager Web GUI administration³
- ◆ Supports Power over Ethernet (PoE) functionality – compliant with IEEE 802.3at and 802.3af standards (KE6912, KE6922, KE8952 and KE9952)
- ◆ Boundless Switching – simply move the mouse cursor across screen boundaries to switch between different receivers
- ◆ Intelligent Dual Video Output Management – split two video sources from a dual display Transmitter and connect to each from different Receivers (KE6940/KE6940A)
- ◆ Gigabit Ethernet port
- ◆ Remote login security
- ◆ DVI digital and analog monitor support (KE6900/KE6900A/KE6900ST/KE6910/KE6912/KE6920/KE6922/KE6940/KE6940A)
- ◆ HDMI monitor support (KE8900S/KE8950/KE8952)
- ◆ DisplayPort monitor support (KE9900ST/KE9950/KE9952)
- ◆ Built-in ESD protection and surge protection
- ◆ Supports 2 channel analog (KE69 Series) and 7.1 channel surround sound (KE89/KE99 Series) stereo speakers and microphone

- ◆ Auto-MDIX - automatically detects cable type
- ◆ Supports widescreen formats
- ◆ Supports High-Quality Video streaming
- ◆ Virtual Media Support
- ◆ Hot pluggable
- ◆ Rack Mountable
- ◆ Upgradeable firmware
- ◆ Supports digital audio (KE8900S/KE8950/KE8952/KE9900ST/KE9950/KE9952)
- ◆ Adaptive Fast Switching – automatically fast switches between different Tx video resolutions on a Rx display within 0.3 second (KE6910/KE6912)
- ◆ Authentication Lock – automatically logs in when the power of the system is resumed after power off (KE6910/KE6912)
- ◆ Connection Redundancy – automatically connects to another transmitter (Tx) after disconnection with the original Tx, ensuring constant access to servers (KE6900A/KE6910/KE6912/KE6920/KE6922/KE6940A)
- ◆ Disconnection Alert – Pop-up warning message and looping alarm beeping notify users the disconnection status (KE6910/KE6912)
- ◆ Instant Link – Switch intuitively and efficiently between transmitter (Tx) on a receiver (Rx) display
- ◆ Rx access control – users at the Tx local console can enable / disable Rx access by simply pressing a control button⁴

Note: 1. RS-232 serial ports support Tx/Rx/CTS/RTS/DTR/DSR signals only.

2. Refer to *Supported Video Resolutions* below for details.

3. The KE Matrix Manager web GUI can be updated from the CCKM page on our website (www.aten.com) or via eService website (<http://eservice.aten.com>). The free version supports up to 8 KE devices. To obtain a license for the full version of the software, please contact your ATEN dealer.

4. The KVM over IP Access Control Box (2XRT-0015G) is sold separately. Contact your ATEN dealer for product information.

Supported Video Resolutions

Resolutions	KE6900/KE6940 KE6900A/KE6940A	KE6910/KE6912 KE6920/KE6922	KE8950/KE8952 KE9950/KE9952	KE6900ST KE8900S KE9900ST
3840 x 2160 @ 24/25/30 Hz			•	
3440 x 1440 @ 50 Hz			•	
2560 x 2048 @ 50 Hz		•		
2560 x 1600 @ 60 Hz		•	•	
2560 x 1440 @ 60 Hz		•	•	
2560 x 1080 @ 24/25/30/50/ 60/100/120 Hz			•	
2048 x 2048 @ 30/60 Hz		•		
2048 x 1536 @ 60 Hz		•	•	
2048 x 1536 @ 30 Hz		•		
2048 x 1152 @ 60 Hz		•		
1600 x 1600 @ 60 Hz		•		
1920 x 2160 @ 60 Hz		•		
1920 x 2160 @ 30 Hz		•	•	
1920 x 1440 @ 60 Hz		•	•	
1920 x 1200 @ 60 Hz	•	•	•	•
1920 x 1080 @ 60 Hz	•	•	•	•
1600 x 1200 @ 60 Hz	•	•	•	•
1680 x 1050 @ 60 Hz	•	•	•	•
1400 x 1050 @ 60 Hz	•	•	•	•
1280 x 1024 @ 60/75 Hz	•	•	•	•
1280 x 960 @ 60 Hz	•	•	•	•
1280 x 800 @ 60 Hz		•		
1600 x 900 @ 60 Hz	•	•	•	•
1440 x 900 @ 60 Hz	•	•	•	•
1152 x 864 @ 75 Hz	•	•	•	•
1366 x 768 @ 60 Hz	•	•	•	•
1280 x 720 @ 60 Hz	•	•	•	•
1024 x 768 @ 60/70/75/85 Hz	•	•	•	•
848 x 480 @ 60 Hz		•		
800 x 600 @ 56/60/72/75/85 Hz	•	•	•	•
720 x 400 @ 70/85 Hz	•	•	•	•
640 x 480 @ 60/72/75/85 Hz	•	•	•	•

Requirements

Console

- ◆ (KE6900/KE6900A/KE6900ST/KE6910/KE6912/KE6920/KE6922) One DVI compatible monitor capable of the highest possible resolution
- ◆ (KE6940/KE6940A) Two DVI compatible monitors capable of the highest possible resolution
- ◆ (KE8900S/KE8950/KE8952) One HDMI compatible monitor capable of the highest possible resolution
- ◆ (KE9900ST/KE9950/KE9952) One DisplayPort compatible monitor capable of the highest possible resolution
- ◆ A USB mouse
- ◆ A USB keyboard
- ◆ Microphone and speakers

Computers

The following equipment must be installed on each computer that is to be connected to the system:

- ◆ (KE6900/KE6900A/KE6900ST/KE6910/KE6912/KE6920/KE6922) One DVI port
- ◆ (KE6940/KE6940A) Two DVI ports
- ◆ (KE8900S/KE8950/KE8952) One HDMI port
- ◆ (KE9900ST/KE9950/KE9952) One DisplayPort port
- ◆ USB Type A port
- ◆ Audio ports

Cables

- ◆ For optimal signal integrity and to simplify the setup, we strongly recommend that you only use the high quality custom USB KVM Cable that is provided with this package.

Minimum Hardware/Software Requirements

The minimum hardware and software requirements for the computer running the KE Matrix Manager software are:

- ◆ Processor: Pentium 4, 2.60 GHz or above

- ◆ Memory: 1GB or above
- ◆ HDD: 500MB or above
- ◆ Web browser: Internet Explorer 10 (or later), Chrome 70 (or later), Firefox 62 (or later)
- ◆ Operating System Requirements:
 - ◆ Windows 7, 8.1, 10, server 2008, server 2012, or server 2016
 - ◆ Linux Ubuntu 16.04, CentOS 7

Note: Java Runtime Environment (JRE) 8 or later for the above OS

Components

KE6900T (Transmitter) Front View

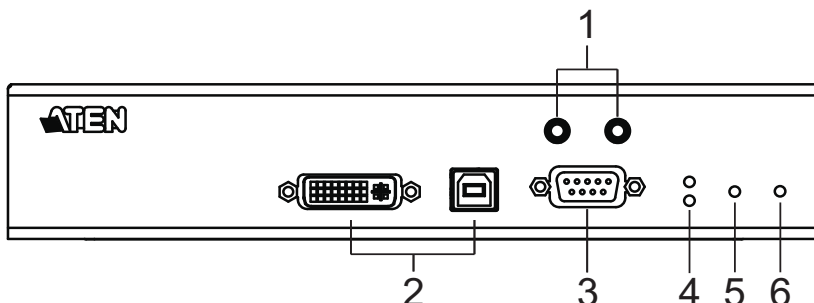

No.	Component	Description
1	Audio Ports	These mini stereo ports are for the speakers (green) and microphone (pink).
2	KVM Ports	The USB KVM cable supplied with the package that links the Transmitter to the computer plugs into these ports.
3	RS-232 Port	This RS-232 serial port is for connecting to the computer for serial control.
4	Remote / Local LED	Lights Green to indicate which side of the installation (Local or Remote) currently has KVM control of the computer.
5	LAN LED	This LED indicates the network status. <ul style="list-style-type: none"> ◆ Lights when connected to the LAN and blinks when the Ethernet connection is active: <ul style="list-style-type: none"> ◆ Orange: 10 Mbps ◆ Orange + Green: 100 Mbps ◆ Green: 1000 Mbps ◆ Off when not connected to the LAN.
6	Power LED	Lights blue to indicate the unit is turned on.

KE6900T (Transmitter) Rear View

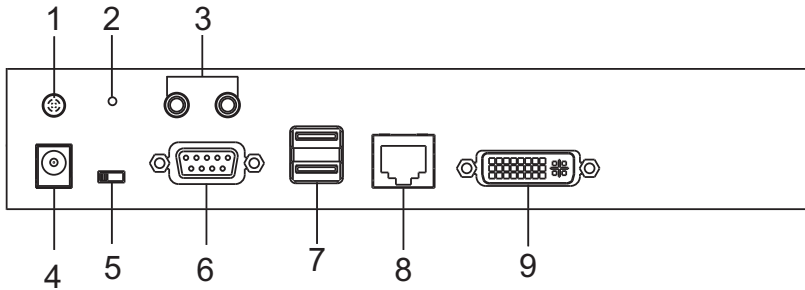

No.	Component	Description
1	Grounding Terminal	The wire used to ground the unit connects here.
2	Reset	<p>This switch must be pushed with a thin object, such as the end of a paper clip.</p> <ul style="list-style-type: none"> ◆ Press and release to reboot the device. ◆ Power off, hold reset then power on the device while pressing reset to recover from a firmware upgrade failure. ◆ Press and hold it in for more than three seconds resets the unit back to its factory default settings*. <p>Note: The Reset to Factory Default function resets everything but the login information (username/password) to the factory default settings. To reset the login information, refer to <i>Reset All Information</i> on page 329.</p>
3	Audio Ports	These mini stereo ports are for the speakers (green) and microphone (pink).
4	Power Jack	The cable from the DC Power adapter connects here.
5	Function Switch	<p>Use this slide switch to set the unit's mode to:</p> <ul style="list-style-type: none"> ◆ Auto: Shared (simultaneous) KVM control of the computer at the Transmitter and Receiver console.* ◆ RS-232 Config: The device is ready to be configured via serial commands through the RS-232 port. When connected to a KVM over IP Access Control Box (2XRT-0015G), users can enable / disable control privileges of the connected receivers. ◆ Local: Only the local Transmitter has KVM control of the computer. The Receiver's KVM access to the computer is locked. <p>Note: In Auto mode, RS-232 and audio functions will work on the Receiver but not on the Transmitter.</p>

No.	Component	Description
6	RS-232 Port	This RS-232 serial port is for connecting to a serial terminal.
7	Console Ports	The unit's USB keyboard and USB mouse plug into these ports.
8	LAN Port	The cable that connects the unit to the LAN plugs in here.
9	DVI-I Output	The cable from the local DVI monitor plugs in here.

KE6900R (Receiver) Front View

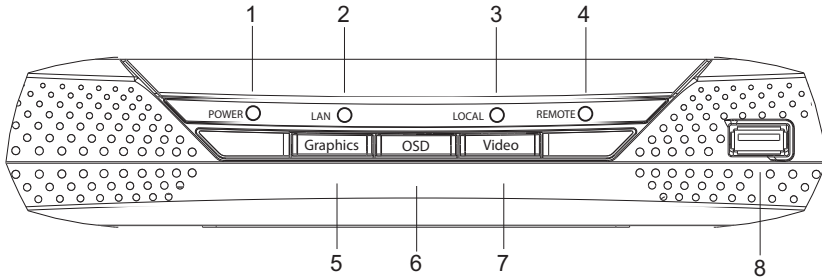

No.	Component	Description
1	Power LED	Lights blue to indicate the unit is turned on.
2	LAN LED	This LED indicates the network status. <ul style="list-style-type: none"> ◆ Lights when connected to the LAN and blinks when the Ethernet connection is active: <ul style="list-style-type: none"> ◆ Orange: 10 Mbps ◆ Orange + Green: 100 Mbps ◆ Green: 1000 Mbps ◆ Off when not connected to the LAN.
3	Local LED	Lights green to Indicate the Transmitter has KVM access of the computer.
4	Remote LED	Lights green to Indicate the Receiver has KVM access of the computer.
5	Graphics Pushbutton	Sets the image quality of the display to the highest possible grade so that images are optimized. This toggle button turns off the Video Pushbutton option. Graphics mode is selected by default.
6	OSD Pushbutton	Use this pushbutton to open the OSD menu.
7	Video Pushbutton	Sets the image quality of the display to a grade that is optimized for playing videos. This toggle button turns off the Graphics Pushbutton option.

No.	Component	Description
8	USB Port	<p>Use this port for virtual media or a USB peripheral device.</p> <p>Note: 1. When using a USB disk plugged into this port, see <i>USB Mode</i>, page 203.</p> <p>2. This USB port does not support isochronous endpoints, therefore USB peripherals that stream audio or video data, such as speakers or webcams, will not work.</p>

KE6900R (Receiver) Rear View

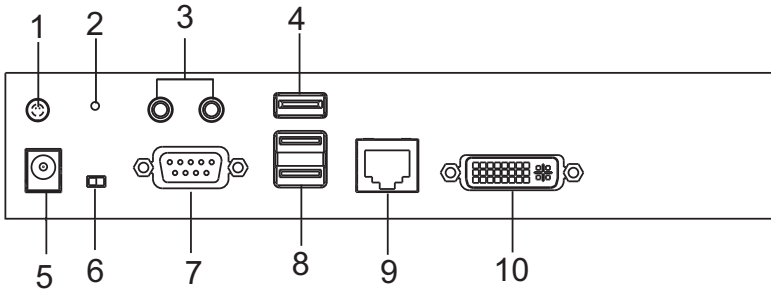

No.	Component	Description
1	Grounding Terminal	The wire used to ground the unit connects here.
2	Reset	<p>This switch must be pushed with a thin object, such as the end of a paper clip.</p> <ul style="list-style-type: none"> ◆ Press and release to reboot the device. ◆ Power off, hold reset then power on the device while pressing reset to recover from a firmware upgrade failure. ◆ Press and hold it in for more then three seconds resets the unit back to its factory default settings*. <p>Note: The Reset to Factory Default function resets everything but the login information (username/password) to the factory default settings. To reset the login information, refer to <i>Reset All Information</i> on page 329.</p>
3	Audio Ports	These mini stereo ports are for the local speakers (green) and microphone (pink).
4	USB Port	<p>Use this port for virtual media or a USB peripheral device.</p> <p>Note: 1. When using a USB disk plugged into this port, see <i>USB Mode</i>, page 203.</p> <p>2. This USB port does not support isochronous endpoints, therefore USB peripherals that stream audio or video data, such as speakers or webcams, will not work.</p>
5	Power Jack	The cable from the DC Power adapter connects here.
6	Function Switch	<p>Use this slide switch to set the unit's mode:</p> <ul style="list-style-type: none"> ◆ Extension: Sets the device to use the normal TX to RX extension mode. ◆ RS-232 Config: The device is ready to be configured via serial commands through the RS-232 port.
7	RS-232 Port	This RS-232 serial port is for connecting to a serial terminal.

No.	Component	Description
8	Console Ports	The unit's USB keyboard and USB mouse plug into these ports. When using a keyboard or mouse with special functions, see <i>USB Mode</i> , page 203.
9	LAN Port	The cable that connects the unit to the LAN plugs in here.
10	DVI-I Output	The cable from the local DVI monitor plugs in here.

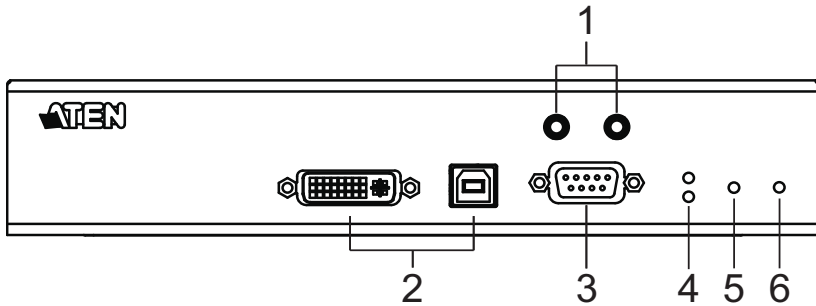
KE6900AT (Transmitter) Front View

No.	Component	Description
1	Audio Ports	These mini stereo ports are for the speakers (green) and microphone (pink).
2	KVM Ports	The USB KVM cable supplied with the package that links the Transmitter to the computer plugs into these ports.
3	RS-232 Port	This RS-232 serial port is for connecting to the computer for serial control.
4	Remote / Local LED	Lights Green to indicate which side of the installation (Local or Remote) currently has KVM control of the computer.
5	LAN LED	This LED indicates the network status. <ul style="list-style-type: none"> ◆ Lights when connected to the LAN and blinks when the Ethernet connection is active: <ul style="list-style-type: none"> ◆ Orange: 10 Mbps ◆ Orange + Green: 100 Mbps ◆ Green: 1000 Mbps ◆ Off when not connected to the LAN.
6	Power LED	Lights blue to indicate the unit is turned on.

KE6900AT (Transmitter) Rear View

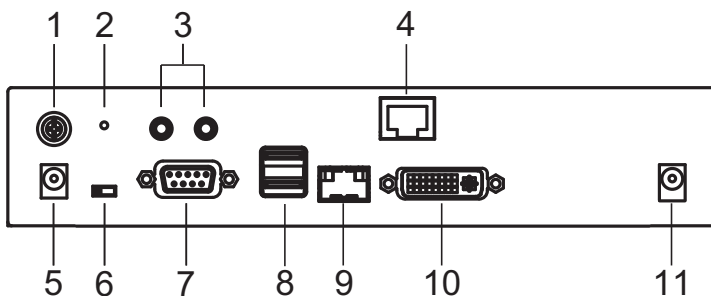

No.	Component	Description
1	Grounding Terminal	The wire used to ground the unit connects here.
2	Reset	<p>This switch must be pushed with a thin object, such as the end of a paper clip.</p> <ul style="list-style-type: none"> ◆ Press and release to reboot the device. ◆ Power off, hold reset then power on the device while pressing reset to recover from a firmware upgrade failure. ◆ Press and hold it in for more than three seconds resets the unit back to its factory default settings*. <p>Note: The Reset to Factory Default function resets everything but the login information (username/password) to the factory default settings. To reset the login information, refer to <i>Reset All Information</i> on page 329.</p>
3	Audio Ports	These mini stereo ports are for the speakers (green) and microphone (pink).
4	LAN Port	The cable that connects the unit to the LAN plugs in here.
5	Power Jack	The cable from the DC Power adapter connects here.

No.	Component	Description
6	Function Switch	<p>Use this slide switch to set the unit's mode to:</p> <ul style="list-style-type: none">◆ Auto: Shared (simultaneous) KVM control of the computer at the Transmitter and Receiver console.*◆ RS-232 Config: The device is ready to be configured via serial commands through the RS-232 port. When connected to a KVM over IP Access Control Box (2XRT-0015G), users can enable / disable control privileges of the connected receivers.◆ Local: Only the local Transmitter has KVM control of the computer. The Receiver's KVM access to the computer is locked. <p>Note: In Auto mode, RS-232 and audio functions will work on the Receiver but not on the Transmitter.</p>
7	RS-232 Port	This RS-232 serial port is for connecting to a serial terminal.
8	Console Ports	The unit's USB keyboard and USB mouse plug into these ports.
9	SFP Slot	The Gigabit Ethernet (GbE) optical fiber cable that connects the unit to the LAN plugs in here.
10	DVI-I Output	The cable from the local DVI monitor plugs in here.
11	Power Jack	Connect a second power source for power redundancy.

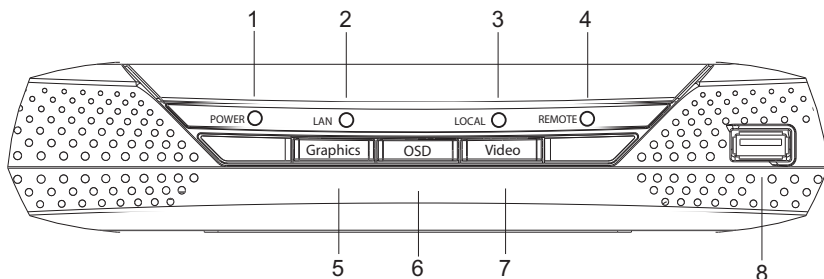
KE6900AR (Receiver) Front View

No.	Component	Description
1	Power LED	Lights blue to indicate the unit is turned on.
2	LAN LED	This LED indicates the network status. <ul style="list-style-type: none"> ◆ Lights when connected to the LAN and blinks when the Ethernet connection is active: <ul style="list-style-type: none"> ◆ Orange: 10 Mbps ◆ Orange + Green: 100 Mbps ◆ Green: 1000 Mbps ◆ Off when not connected to the LAN.
3	Local LED	Lights green to Indicate the Transmitter has KVM access of the computer.
4	Remote LED	Lights green to Indicate the Receiver has KVM access of the computer.
5	Graphics Pushbutton	Sets the image quality of the display to the highest possible grade so that images are optimized. This toggle button turns off the Video Pushbutton option. Graphics mode is selected by default.
6	OSD Pushbutton	Use this pushbutton to open the OSD menu.
7	Video Pushbutton	Sets the image quality of the display to a grade that is optimized for playing videos. This toggle button turns off the Graphics Pushbutton option.

No.	Component	Description
8	USB Port	<p>Use this port for virtual media or a USB peripheral device.</p> <p>Note: 1. When using a USB disk plugged into this port, see <i>USB Mode</i>, page 203.</p> <p>2. This USB port does not support isochronous endpoints, therefore USB peripherals that stream audio or video data, such as speakers or webcams, will not work.</p>

KE6900AR (Receiver) Rear View

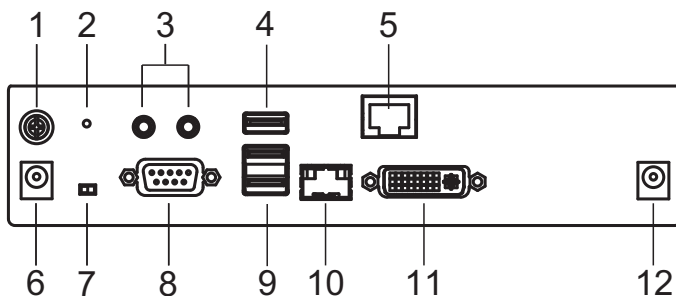

No.	Component	Description
1	Grounding Terminal	The wire used to ground the unit connects here.
2	Reset	<p>This switch must be pushed with a thin object, such as the end of a paper clip.</p> <ul style="list-style-type: none"> ◆ Press and release to reboot the device. ◆ Power off, hold reset then power on the device while pressing reset to recover from a firmware upgrade failure. ◆ Press and hold it in for more then three seconds resets the unit back to its factory default settings*. <p>Note: The Reset to Factory Default function resets everything but the login information (username/password) to the factory default settings. To reset the login information, refer to <i>Reset All Information</i> on page 329.</p>
3	Audio Ports	These mini stereo ports are for the local speakers (green) and microphone (pink).
4	USB Port	<p>Use this port for virtual media or a USB peripheral device.</p> <p>Note: 1. When using a USB disk plugged into this port, see <i>USB Mode</i>, page 203.</p> <p>2. This USB port does not support isochronous endpoints, therefore USB peripherals that stream audio or video data, such as speakers or webcams, will not work.</p>
5	SFP Slot	The Gigabit Ethernet (GbE) optical fiber cable that connects the unit to the LAN plugs in here.
6	Power Jack	The cable from the DC Power adapter connects here.

No.	Component	Description
7	Function Switch	Use this slide switch to set the unit's mode: <ul style="list-style-type: none">◆ Extension: Sets the device to use the normal TX to RX extension mode.◆ RS-232 Config: The device is ready to be configured via serial commands through the RS-232 port.
8	RS-232 Port	This RS-232 serial port is for connecting to a serial terminal.
9	Console Ports	The unit's USB keyboard and USB mouse plug into these ports. When using a keyboard or mouse with special functions, see <i>USB Mode</i> , page 203.
10	LAN Port	The cable that connects the unit to the LAN plugs in here.
11	DVI-I Output	The cable from the local DVI monitor plugs in here.
12	Power Jack	Connect a second power source for power redundancy.

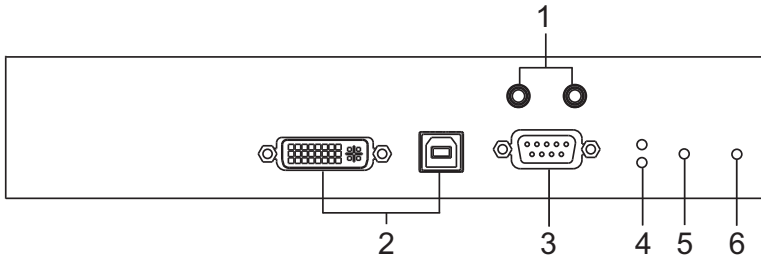
KE6910T / KE6912T (Transmitter) Front View

No.	Component	Description
1	Audio Ports	These mini stereo ports are for the speakers (green) and microphone (pink).
2	KVM Ports	The USB KVM cable supplied with the package that links the Transmitter to the computer plugs into these ports.
3	RS-232 Port	This RS-232 serial port is for connecting to the computer for serial control.
4	Remote / Local LED	Lights green to indicate which side of the installation (Local or Remote) has KVM control of the computer.
5	LAN LED	This LED indicates the network status. <ul style="list-style-type: none"> ◆ Lights when connected to the LAN and blinks when the Ethernet connection is active: <ul style="list-style-type: none"> ◆ Orange: 10 Mbps ◆ Orange + Green: 100 Mbps ◆ Green: 1000 Mbps ◆ Off when not connected to the LAN.
6	Power LED	Lights blue to indicate the unit is turned on.

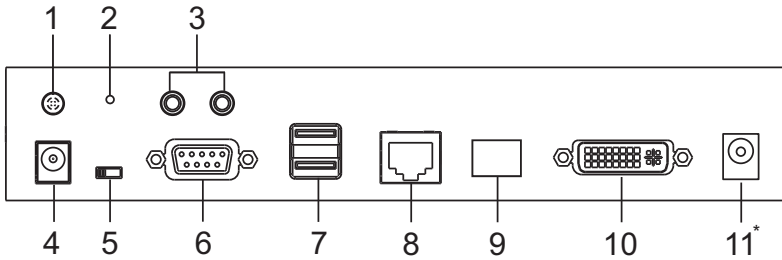
KE6910T / KE6912T (Transmitter) Rear View

No.	Component	Description
1	Grounding Terminal	The wire used to ground the unit connects here.
2	Reset	<p>This switch must be pushed with a thin object, such as the end of a paper clip.</p> <ul style="list-style-type: none"> ◆ Press and release to reboot the device. ◆ Power off, hold reset then power on the device while pressing reset to recover from a firmware upgrade failure. ◆ Press and hold it in for more than three seconds resets the unit back to its factory default settings*. <p>Note: The Reset to Factory Default function resets everything but the login information (username/password) to the factory default settings. To reset the login information, refer to <i>Reset All Information</i> on page 329.</p>
3	Audio Ports	These mini stereo ports are for the local speakers (green) and microphone (pink).
4	Power Jack	The cable from the DC Power adapter connects here.
5	Function Switch	<p>Use this slide switch to set the unit's mode to:</p> <ul style="list-style-type: none"> ◆ Auto: Shared (simultaneous) KVM control of the computer at the Transmitter and Receiver console.* ◆ RS-232 Config: The device is ready to be configured via serial commands through the RS-232 port. When connected to a KVM over IP Access Control Box (2XRT-0015G), users can enable / disable control privileges of the connected receivers. ◆ Local: Only the local Transmitter has KVM control of the computer. The Receiver's KVM access to the computer is locked. <p>Note: In Auto mode, RS-232 and audio functions will work on the Receiver but not on the Transmitter.</p>

No.	Component	Description
6	RS-232 Port	This RS-232 serial port is for connecting to a serial terminal.
7	Console Ports	The unit's USB keyboard and USB mouse plug into these ports.
8	LAN Port	The cable that connects the unit to the LAN plugs in here. This port is PoE enabled* for KE6912 for power redundancy or cable management. *Requires power board version B01G or later (see <i>PoE Power Redundancy</i> on page 69 for more details).
9	SFP Slot	The Gigabit Ethernet (GbE) optical fiber cable that connects the unit to the LAN plugs in here.
10	DVI-D Output	The cable from the local DVI monitor plugs in here.
11	Power Jack (KE6910T only)	Connect a second power source for power redundancy.

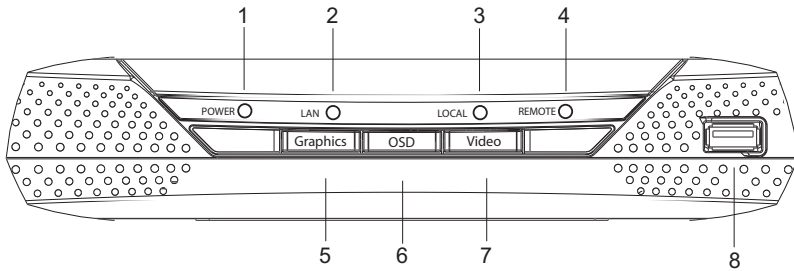
KE6910R / KE6912R (Receiver) Front View

No.	Component	Description
1	Power LED	Lights blue to indicate the unit is turned on.
2	LAN LED	This LED indicates the network status. <ul style="list-style-type: none"> ◆ Lights when connected to the LAN and blinks when the Ethernet connection is active: <ul style="list-style-type: none"> ◆ Orange: 10 Mbps ◆ Orange + Green: 100 Mbps ◆ Green: 1000 Mbps ◆ Off when not connected to the LAN.
3	Local LED	Lights green to Indicate the Transmitter has KVM access of the computer.
4	Remote LED	Lights green to Indicate the Receiver has KVM access of the computer.
5	Graphics Pushbutton	Sets the image quality of the display to the highest possible grade so that images are optimized. This toggle button turns off the Video Pushbutton option. Graphics mode is selected by default.
6	OSD Pushbutton	Use this pushbutton to open the OSD menu.
7	Video Pushbutton	Sets the image quality of the display to a grade that is optimized for playing videos. This toggle button turns off the Graphics Pushbutton option.
8	USB Port	Use this port for virtual media or a USB peripheral device. <p>Note: 1. When using a USB disk plugged into this port, see <i>USB Mode</i>, page 203.</p> <p>2. This USB port does not support isochronous endpoints, therefore USB peripherals that stream audio or video data, such as speakers or webcams, will not work.</p>

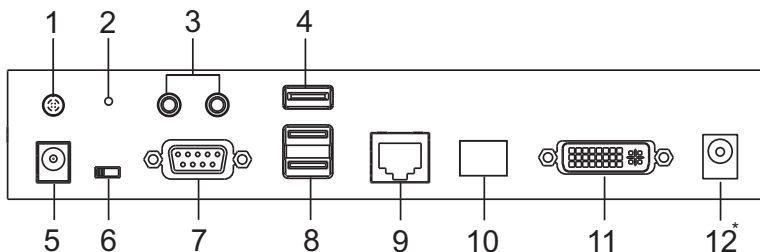
KE6910R / KE6912R (Receiver) Rear View

No.	Component	Description
1	Grounding Terminal	The wire used to ground the unit connects here.
2	Reset	<p>This switch must be pushed with a thin object, such as the end of a paper clip.</p> <ul style="list-style-type: none"> ◆ Press and release to reboot the device. ◆ Power off, hold reset then power on the device while pressing reset to recover from a firmware upgrade failure. ◆ Press and hold it in for more than three seconds resets the unit back to its factory default settings*. <p>Note: The Reset to Factory Default function resets everything but the login information (username/password) to the factory default settings. To reset the login information, refer to <i>Reset All Information</i> on page 329.</p>
3	Audio Ports	These mini stereo ports are for the local speakers (green) and microphone (pink).
4	USB Port	<p>Use this port for virtual media or a USB peripheral device.</p> <p>Note: 1. When using a USB disk plugged into this port, see <i>USB Mode</i>, page 203.</p> <p>2. This USB port does not support isochronous endpoints, therefore USB peripherals that stream audio or video data, such as speakers or webcams, will not work.</p>
5	Power Jack	The cable from the DC Power adapter connects here.
6	Function Switch	<p>Use this slide switch to set the unit's mode:</p> <ul style="list-style-type: none"> ◆ Extension: Sets the device to use the normal TX to RX extension mode. ◆ RS-232 Config: The device is ready to be configured via serial commands through the RS-232 port.

No.	Component	Description
7	RS-232 Port	This RS-232 serial port is for connecting to a serial terminal.
8	Console Ports	The unit's USB keyboard and USB mouse plug into these ports.
9	LAN Port	The cable that connects the unit to the LAN plugs in here. This port is PoE enabled* for KE6912 for power redundancy or cable management. *Requires power board version B01G or later (see <i>PoE Power Redundancy</i> on page 69 for more details).
10	SFP Slot	The Gigabit Ethernet (GbE) optical fiber cable that connects the unit to the LAN plugs in here.
11	DVI-D Output	The cable from the local DVI monitor plugs in here.
12	Power Jack (KE6910R only)	Connect a second power source for power redundancy.

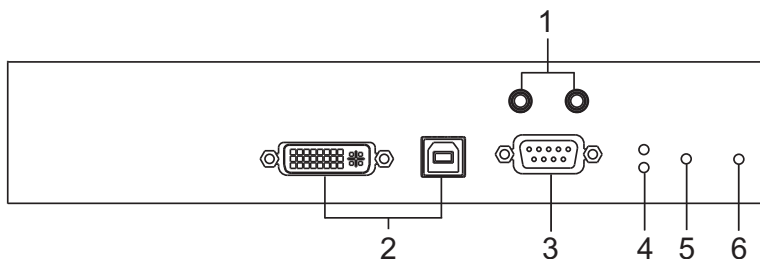
KE6920T / KE6922T (Transmitter) Front View

No.	Component	Description
1	Audio Ports	These mini stereo ports are for the speakers (green) and microphone (pink).
2	KVM Ports	The USB KVM cable supplied with the package that links the Transmitter to the computer plugs into these ports.
3	RS-232 Port	This RS-232 serial port is for connecting to the computer for serial control.
4	Remote / Local LED	Lights green to indicate which side of the installation (Local or Remote) has KVM control of the computer.
5	LAN LED	This LED indicates the network status. <ul style="list-style-type: none"> ◆ Lights when connected to the LAN and blinks when the Ethernet connection is active: <ul style="list-style-type: none"> ◆ Orange: 10 Mbps ◆ Orange + Green: 100 Mbps ◆ Green: 1000 Mbps ◆ Off when not connected to the LAN.
6	Power LED	Lights blue to indicate the unit is turned on.

KE6920T / KE6922T (Transmitter) Rear View

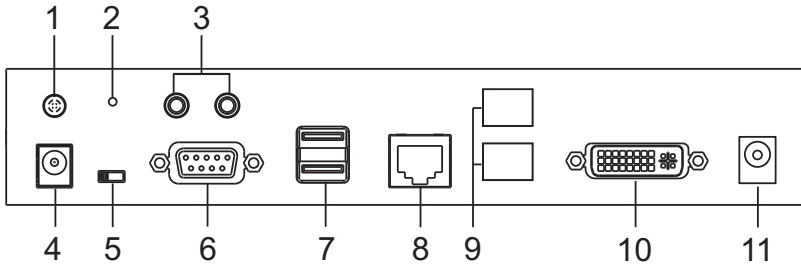

No.	Component	Description
1	Grounding Terminal	The wire used to ground the unit connects here.
2	Reset	<p>This switch must be pushed with a thin object, such as the end of a paper clip.</p> <ul style="list-style-type: none"> ◆ Press and release to reboot the device. ◆ Power off, hold reset then power on the device while pressing reset to recover from a firmware upgrade failure. ◆ Press and hold it in for more then three seconds resets the unit back to its factory default settings*. <p>Note: The Reset to Factory Default function resets everything but the login information (username/password) to the factory default settings. To reset the login information, refer to <i>Reset All Information</i> on page 329.</p>
3	Audio Ports	These mini stereo ports are for the local speakers (green) and microphone (pink).
4	Power Jack	The cable from the DC Power adapter connects here.
5	Function Switch	<p>Use this slide switch to set the unit's mode to:</p> <ul style="list-style-type: none"> ◆ Auto: Shared (simultaneous) KVM control of the computer at the Transmitter and Receiver console.* ◆ RS-232 Config: The device is ready to be configured via serial commands through the RS-232 port. When connected to a KVM over IP Access Control Box (2XRT-0015G), users can enable / disable control privileges of the connected receivers. ◆ Local: Only the local Transmitter has KVM control of the computer. The Receiver's KVM access to the computer is locked. <p>Note: In Auto mode, RS-232 and audio functions will work on the Receiver but not on the Transmitter.</p>

No.	Component	Description
6	RS-232 Port	This RS-232 serial port is for connecting to a serial terminal.
7	Console Ports	The unit's USB keyboard and USB mouse plug into these ports.
8	LAN Port	The cable that connects the unit to the LAN plugs in here. This port is PoE enabled* for KE6922 for power redundancy or cable management. *Requires power board version B01G or later (see <i>PoE Power Redundancy</i> on page 69 for more details).
9	SFP Slots	The Gigabit Ethernet (GbE) optical fiber cable that connects the unit to the LAN can be plugged here.
10	DVI-D Output	The cable from the local DVI monitor plugs in here.
11	Power Jack	Connect a second power source for power redundancy.

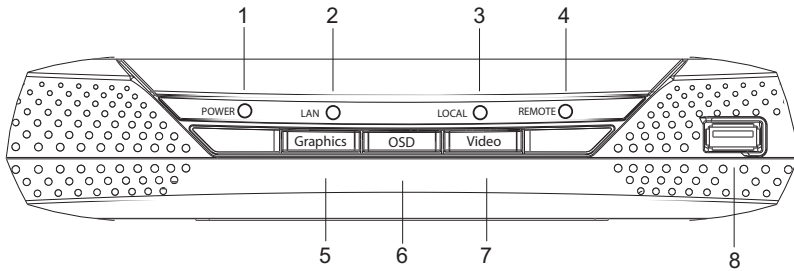
KE6920R / KE6922R (Receiver) Front View

No.	Component	Description
1	Power LED	Lights blue to indicate the unit is turned on.
2	LAN LED	This LED indicates the network status. <ul style="list-style-type: none"> ◆ Lights when connected to the LAN and blinks when the Ethernet connection is active: <ul style="list-style-type: none"> ◆ Orange: 10 Mbps ◆ Orange + Green: 100 Mbps ◆ Green: 1000 Mbps ◆ Off when not connected to the LAN.
3	Local LED	Lights green to Indicate the Transmitter has KVM access of the computer.
4	Remote LED	Lights green to Indicate the Receiver has KVM access of the computer.
5	Graphics Pushbutton	Sets the image quality of the display to the highest possible grade so that images are optimized. This toggle button turns off the Video Pushbutton option. Graphics mode is selected by default.
6	OSD Pushbutton	Use this pushbutton to open the OSD menu.
7	Video Pushbutton	Sets the image quality of the display to a grade that is optimized for playing videos. This toggle button turns off the Graphics Pushbutton option.
8	USB Port	Use this port for virtual media or a USB peripheral device. <p>Note: 1. When using a USB disk plugged into this port, see <i>USB Mode</i>, page 203.</p> <p>2. This USB port does not support isochronous endpoints, therefore USB peripherals that stream audio or video data, such as speakers or webcams, will not work.</p>

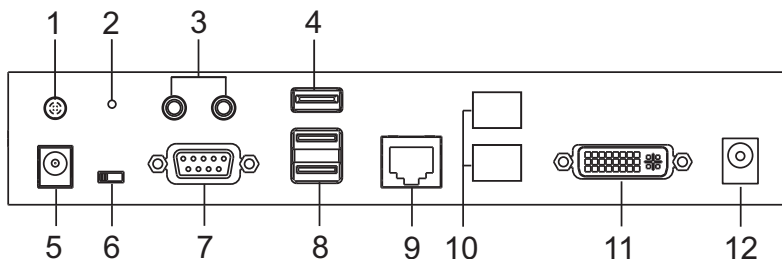
KE6920R / KE6922R (Receiver) Rear View

No.	Component	Description
1	Grounding Terminal	The wire used to ground the unit connects here.
2	Reset	<p>This switch must be pushed with a thin object, such as the end of a paper clip.</p> <ul style="list-style-type: none"> ◆ Press and release to reboot the device. ◆ Power off, hold reset then power on the device while pressing reset to recover from a firmware upgrade failure. ◆ Press and hold it in for more than three seconds resets the unit back to its factory default settings*. <p>Note: The Reset to Factory Default function resets everything but the login information (username/password) to the factory default settings. To reset the login information, refer to <i>Reset All Information</i> on page 329.</p>
3	Audio Ports	These mini stereo ports are for the local speakers (green) and microphone (pink).
4	USB Port	<p>Use this port for virtual media or a USB peripheral device.</p> <p>Note: 1. When using a USB disk plugged into this port, see <i>USB Mode</i>, page 203.</p> <p>2. This USB port does not support isochronous endpoints, therefore USB peripherals that stream audio or video data, such as speakers or webcams, will not work.</p>
5	Power Jack	The cable from the DC Power adapter connects here.
6	Function Switch	<p>Use this slide switch to set the unit's mode:</p> <ul style="list-style-type: none"> ◆ Extension: Sets the device to use the normal TX to RX extension mode. ◆ RS-232 Config: The device is ready to be configured via serial commands through the RS-232 port.

No.	Component	Description
7	RS-232 Port	This RS-232 serial port is for connecting to a serial terminal.
8	Console Ports	The unit's USB keyboard and USB mouse plug into these ports.
9	LAN Port	The cable that connects the unit to the LAN plugs in here. This port is PoE enabled* for KE6922 for power redundancy or cable management. *Requires power board version B01G or later (see <i>PoE Power Redundancy</i> on page 69 for more details).
10	SFP Slots	The Gigabit Ethernet (GbE) optical fiber cable that connects the unit to the LAN can be plugged here.
11	DVI-D Output	The cable from the local DVI monitor plugs in here.
12	Power Jack	Connect a second power source for power redundancy.

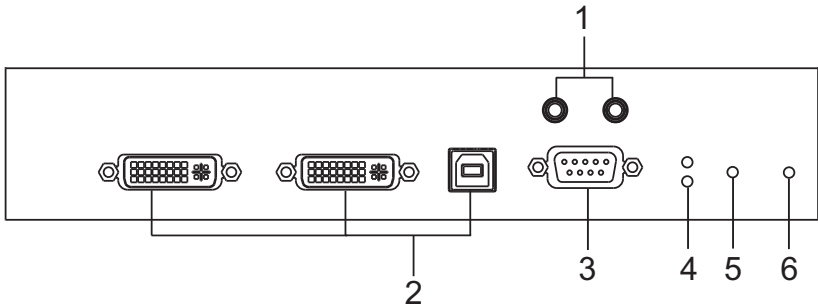
KE6940T (Transmitter) Front View

No.	Component	Description
1	Audio Ports	These mini stereo ports are for the speakers (green) and microphone (pink).
2	KVM Ports	The USB KVM cable supplied with the package that links the Transmitter to the computer plugs into these ports.
3	RS-232 Port	This RS-232 serial port is for connecting to the computer for serial control.
4	Remote / Local LED	Lights green to indicate which side of the installation (Local or Remote) has KVM control of the computer.
5	LAN LED	This LED indicates the network status. <ul style="list-style-type: none"> ◆ Lights when connected to the LAN and blinks when the Ethernet connection is active: <ul style="list-style-type: none"> ◆ Orange: 10 Mbps ◆ Orange + Green: 100 Mbps ◆ Green: 1000 Mbps ◆ Off when not connected to the LAN.
6	Power LED	Lights blue to indicate the unit is turned on.

KE6940T (Transmitter) Rear View

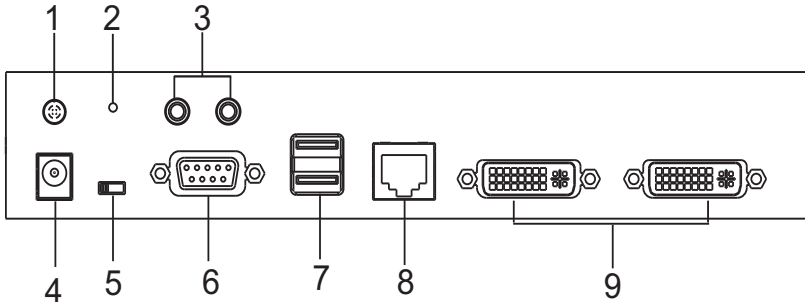

No.	Component	Description
1	Grounding Terminal	The wire used to ground the unit connects here.
2	Reset	<p>This switch must be pushed with a thin object, such as the end of a paper clip.</p> <ul style="list-style-type: none"> ◆ Press and release to reboot the device. ◆ Power off, hold reset then power on the device while pressing reset to recover from a firmware upgrade failure. ◆ Press and hold it in for more than three seconds resets the unit back to its factory default settings*. <p>Note: The Reset to Factory Default function resets everything but the login information (username/password) to the factory default settings. To reset the login information, refer to <i>Reset All Information</i> on page 329.</p>
3	Audio Ports	These mini stereo ports are for the local speakers (green) and microphone (pink).
4	Power Jack	The cable from the DC Power adapter connects here.
5	Function Switch	<p>Use this slide switch to set the unit's mode to:</p> <ul style="list-style-type: none"> ◆ Auto: Shared (simultaneous) KVM control of the computer at the Transmitter and Receiver console.* ◆ RS-232 Config: The device is ready to be configured via serial commands through the RS-232 port. When connected to a KVM over IP Access Control Box (2XRT-0015G), users can enable / disable control privileges of the connected receivers. ◆ Local: Only the local Transmitter has KVM control of the computer. The Receiver's KVM access to the computer is locked. <p>Note: In Auto mode, RS-232 and audio functions will work on the Receiver but not on the Transmitter.</p>

No.	Component	Description
6	RS-232 Port	This RS-232 serial port is for connecting to a serial terminal.
7	Console Ports	The unit's USB keyboard and USB mouse plug into these ports.
8	LAN Port	The cable that connects the unit to the LAN plugs in here.
9	DVI-I Output	The cable from the local DVI monitor plugs in here.

KE6940R (Receiver) Front View

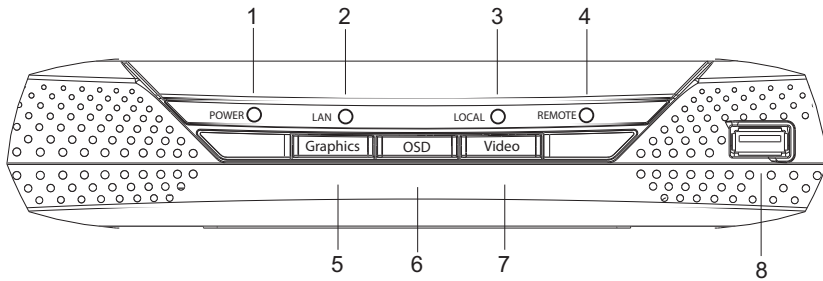

No.	Component	Description
1	Power LED	Lights blue to indicate the unit is turned on.
2	LAN LED	This LED indicates the network status. <ul style="list-style-type: none"> ◆ Lights when connected to the LAN and blinks when the Ethernet connection is active: <ul style="list-style-type: none"> ◆ Orange: 10 Mbps ◆ Orange + Green: 100 Mbps ◆ Green: 1000 Mbps ◆ Off when not connected to the LAN.
3	Local LED	Lights green to Indicate the Transmitter has KVM access of the computer.
4	Remote LED	Lights green to Indicate the Receiver has KVM access of the computer.
5	Graphics Pushbutton	Sets the image quality of the display to the highest possible grade so that images are optimized. This toggle button turns off the Video Pushbutton option. Graphics mode is selected by default.
6	OSD Pushbutton	Use this pushbutton to open the OSD menu.
7	Video Pushbutton	Sets the image quality of the display to a grade that is optimized for playing videos. This toggle button turns off the Graphics Pushbutton option.

No.	Component	Description
8	USB Port	<p>Use this port for virtual media or a USB peripheral device.</p> <p>Note: 1. When using a USB disk plugged into this port, see <i>USB Mode</i>, page 203.</p> <p>2. This USB port does not support isochronous endpoints, therefore USB peripherals that stream audio or video data, such as speakers or webcams, will not work.</p>

KE6940R (Receiver) Rear View

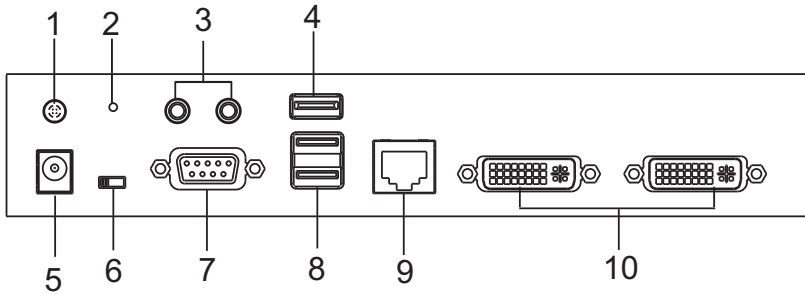

No.	Component	Description
1	Grounding Terminal	The wire used to ground the unit connects here.
2	Reset	<p>This switch must be pushed with a thin object, such as the end of a paper clip.</p> <ul style="list-style-type: none"> ◆ Press and release to reboot the device. ◆ Power off, hold reset then power on the device while pressing reset to recover from a firmware upgrade failure. ◆ Press and hold it in for more than three seconds resets the unit back to its factory default settings*. <p>Note: The Reset to Factory Default function resets everything but the login information (username/password) to the factory default settings. To reset the login information, refer to <i>Reset All Information</i> on page 329.</p>
3	Audio Ports	These mini stereo ports are for the local speakers (green) and microphone (pink).
4	USB Port	<p>Use this port for virtual media or a USB peripheral device.</p> <p>Note: 1. When using a USB disk plugged into this port, see <i>USB Mode</i>, page 203.</p> <p>2. This USB port does not support isochronous endpoints, therefore USB peripherals that stream audio or video data, such as speakers or webcams, will not work.</p>
5	Power Jack	The cable from the DC Power adapter connects here.
6	Function Switch	<p>Use this slide switch to set the unit's mode:</p> <ul style="list-style-type: none"> ◆ Extension: Sets the device to use the normal TX to RX extension mode. ◆ RS-232 Config: The device is ready to be configured via serial commands through the RS-232 port.

No.	Component	Description
7	RS-232 Port	This RS-232 serial port is for connecting to a serial terminal.
8	Console Ports	The unit's USB keyboard and USB mouse plug into these ports.
9	LAN Port	The cable that connects the unit to the LAN plugs in here.
10	DVI-I Output	The cable from the local DVI monitors plug in here.

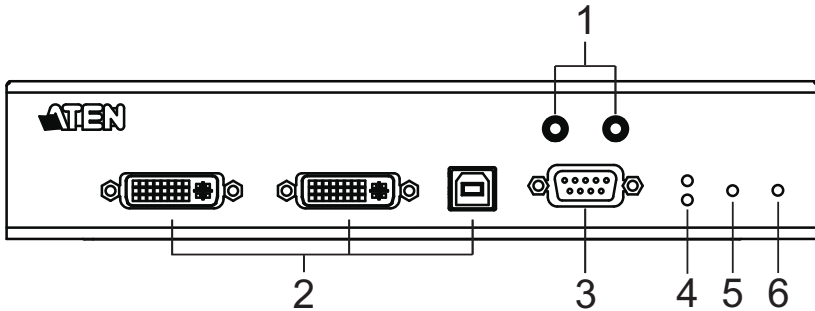
KE6940AT (Transmitter) Front View

No.	Component	Description
1	Audio Ports	These mini stereo ports are for the speakers (green) and microphone (pink).
2	KVM Ports	The USB KVM cable and the DVI cable supplied with the package plugs into these ports to link the Transmitter to the computer.
3	RS-232 Port	This RS-232 serial port is for connecting to the computer for serial control.
4	Remote / Local LED	Lights Green to indicate which side of the installation (Local or Remote) currently has KVM control of the computer.
5	LAN LED	This LED indicates the network status. <ul style="list-style-type: none"> ◆ Lights when connected to the LAN and blinks when the Ethernet connection is active: <ul style="list-style-type: none"> ◆ Orange: 10 Mbps ◆ Orange + Green: 100 Mbps ◆ Green: 1000 Mbps ◆ Off when not connected to the LAN.
6	Power LED	Lights blue to indicate the unit is turned on.

KE6940AT (Transmitter) Rear View

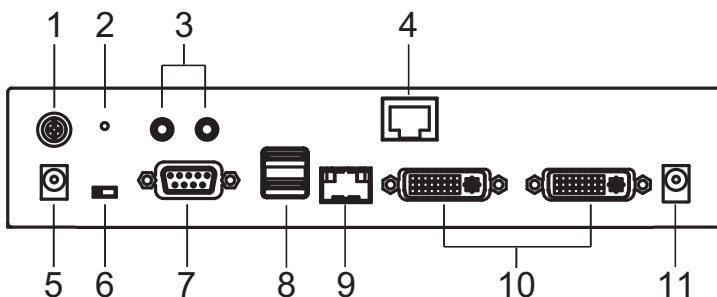

No.	Component	Description
1	Grounding Terminal	The wire used to ground the unit connects here.
2	Reset	<p>This switch must be pushed with a thin object, such as the end of a paper clip.</p> <ul style="list-style-type: none"> ◆ Press and release to reboot the device. ◆ Power off, hold reset then power on the device while pressing reset to recover from a firmware upgrade failure. ◆ Press and hold it in for more than three seconds resets the unit back to its factory default settings*. <p>Note: The Reset to Factory Default function resets everything but the login information (username/password) to the factory default settings. To reset the login information, refer to <i>Reset All Information</i> on page 329.</p>
3	Audio Ports	These mini stereo ports are for the speakers (green) and microphone (pink).
4	LAN Port	The cable that connects the unit to the LAN plugs in here.
5	Power Jack	The cable from the DC Power adapter connects here.

No.	Component	Description
6	Function Switch	<p>Use this slide switch to set the unit's mode to:</p> <ul style="list-style-type: none">◆ Auto: Shared (simultaneous) KVM control of the computer at the Transmitter and Receiver console.*◆ RS-232 Config: The device is ready to be configured via serial commands through the RS-232 port. When connected to a KVM over IP Access Control Box (2XRT-0015G), users can enable / disable control privileges of the connected receivers.◆ Local: Only the local Transmitter has KVM control of the computer. The Receiver's KVM access to the computer is locked. <p>Note: In Auto mode, RS-232 and audio functions will work on the Receiver but not on the Transmitter.</p>
7	RS-232 Port	This RS-232 serial port is for connecting to a serial terminal.
8	Console Ports	The unit's USB keyboard and USB mouse plug into these ports.
9	SFP Slot	The Gigabit Ethernet (GbE) optical fiber cable that connects the unit to the LAN plugs in here.
10	DVI-I Output	The cables from the local DVI monitors plug in here.
11	Power Jack	Connect a second power source for power redundancy.

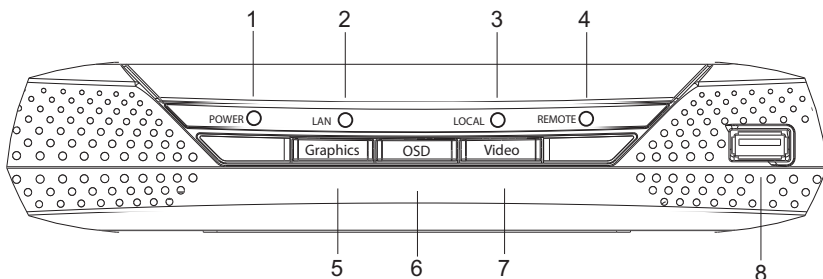
KE6940AR (Receiver) Front View

No.	Component	Description
1	Power LED	Lights blue to indicate the unit is turned on.
2	LAN LED	This LED indicates the network status. <ul style="list-style-type: none"> ◆ Lights when connected to the LAN and blinks when the Ethernet connection is active: <ul style="list-style-type: none"> ◆ Orange: 10 Mbps ◆ Orange + Green: 100 Mbps ◆ Green: 1000 Mbps ◆ Off when not connected to the LAN.
3	Local LED	Lights green to Indicate the Transmitter has KVM access of the computer.
4	Remote LED	Lights green to Indicate the Receiver has KVM access of the computer.
5	Graphics Pushbutton	Sets the image quality of the display to the highest possible grade so that images are optimized. This toggle button turns off the Video Pushbutton option. Graphics mode is selected by default.
6	OSD Pushbutton	Use this pushbutton to open the OSD menu.
7	Video Pushbutton	Sets the image quality of the display to a grade that is optimized for playing videos. This toggle button turns off the Graphics Pushbutton option.

No.	Component	Description
8	USB Port	<p>Use this port for virtual media or a USB peripheral device.</p> <p>Note: 1. When using a USB disk plugged into this port, see <i>USB Mode</i>, page 203.</p> <p>2. This USB port does not support isochronous endpoints, therefore USB peripherals that stream audio or video data, such as speakers or webcams, will not work.</p>

KE6940AR (Receiver) Rear View

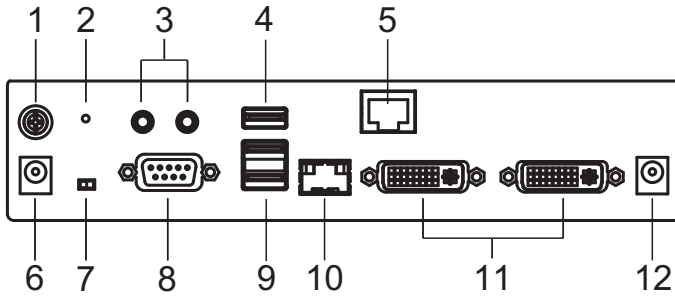

No.	Component	Description
1	Grounding Terminal	The wire used to ground the unit connects here.
2	Reset	<p>This switch must be pushed with a thin object, such as the end of a paper clip.</p> <ul style="list-style-type: none"> ◆ Press and release to reboot the device. ◆ Power off, hold reset then power on the device while pressing reset to recover from a firmware upgrade failure. ◆ Press and hold it in for more then three seconds resets the unit back to its factory default settings*. <p>Note: The Reset to Factory Default function resets everything but the login information (username/password) to the factory default settings. To reset the login information, refer to <i>Reset All Information</i> on page 329.</p>
3	Audio Ports	These mini stereo ports are for the local speakers (green) and microphone (pink).
4	USB Port	<p>Use this port for virtual media or a USB peripheral device.</p> <p>Note: 1. When using a USB disk plugged into this port, see <i>USB Mode</i>, page 203.</p> <p>2. This USB port does not support isochronous endpoints, therefore USB peripherals that stream audio or video data, such as speakers or webcams, will not work.</p>
5	SFP Slot	The Gigabit Ethernet (GbE) optical fiber cable that connects the unit to the LAN plugs in here.
6	Power Jack	The cable from the DC Power adapter connects here.

No.	Component	Description
7	Function Switch	Use this slide switch to set the unit's mode: <ul style="list-style-type: none">◆ Extension: Sets the device to use the normal TX to RX extension mode.◆ RS-232 Config: The device is ready to be configured via serial commands through the RS-232 port.
8	RS-232 Port	This RS-232 serial port is for connecting to a serial terminal.
9	Console Ports	The unit's USB keyboard and USB mouse plug into these ports. When using a keyboard or mouse with special functions, see <i>USB Mode</i> , page 203.
10	LAN Port	The cable that connects the unit to the LAN plugs in here.
11	DVI-I Output	The cables from the local DVI monitors plug in here.
12	Power Jack	Connect a second power source for power redundancy.

KE6900ST (Transmitter) Front, Rear and Top View

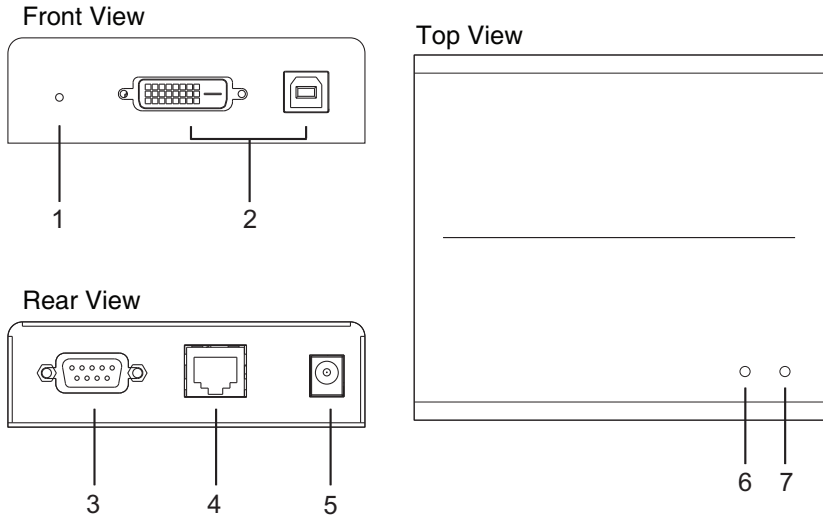

No.	Component	Description
1	Reset	<p>This switch must be pushed with a thin object, such as the end of a paper clip.</p> <ul style="list-style-type: none"> ◆ Press and release to reboot the device. ◆ Power off, hold reset then power on the device while pressing reset to recover from a firmware upgrade failure. ◆ Press and hold it in for more then three seconds resets the unit back to its factory default settings*. <p>Note: The Reset to Factory Default function resets everything but the login information (username/password) to the factory default settings. To reset the login information, refer to <i>Reset All Information</i> on page 329.</p>
2	KVM Port	The USB KVM cable supplied with the package that links the Transmitter to the computer plugs into these ports.
3	RS-232 Port	<p>This RS-232 serial port is for connecting to the computer for serial control.</p> <p>Note: When a LAN connection is detected serial commands bypass the KE6900ST and are sent across the network to the receiver. When no LAN connection is detected serial commands are automatically directed to the KE6900ST for local configuration and control.</p>
4	LAN Port	The cable that connects the unit to the LAN plugs in here.

No.	Component	Description
5	Power Jack	The cable from the DC Power adapter connects here.
6	LAN LED	This LED indicates the network status. <ul style="list-style-type: none">◆ Lights when connected to the LAN and blinks when the Ethernet connection is active:<ul style="list-style-type: none">◆ Orange: 10 Mbps◆ Orange + Green: 100 Mbps◆ Green: 1000 Mbps◆ Off when not connected to the LAN.
7	Power LED	Lights blue to indicate the unit is turned on.

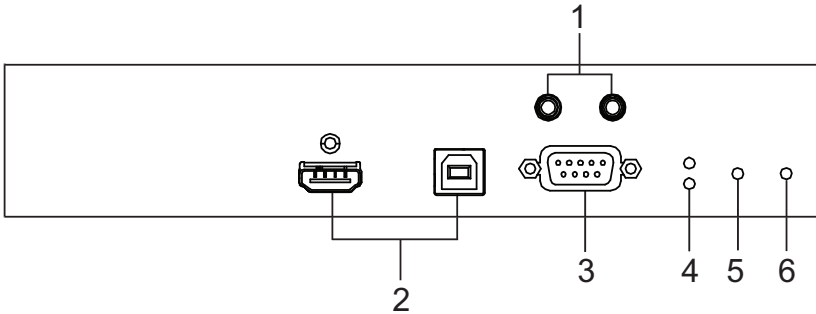
KE8950T / KE8952T (Transmitter) Front View

No.	Component	Description
1	Audio Ports	These mini stereo ports are for the speakers (green) and microphone (pink).
2	KVM Ports	The USB KVM cable supplied with the package that links the Transmitter to the computer plugs into these ports.
3	RS-232 Port	This RS-232 serial port is for connecting to the computer for serial control.
4	Remote / Local LED	Lights Green to indicate which side of the installation (Local or Remote) currently has KVM control of the computer.
5	LAN LED	This LED indicates the network status. <ul style="list-style-type: none"> ◆ Lights when connected to the LAN and blinks when the Ethernet connection is active: <ul style="list-style-type: none"> ◆ Orange: 10 Mbps ◆ Orange + Green: 100 Mbps ◆ Green: 1000 Mbps ◆ Off when not connected to the LAN.
6	Power LED	Lights blue to indicate the unit is turned on.

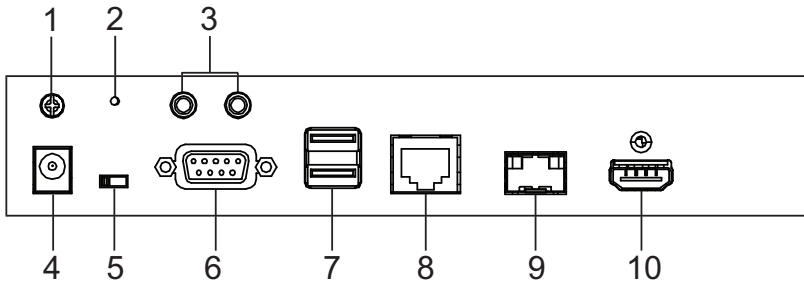
KE8950T / KE8952T (Transmitter) Rear View

No.	Component	Description
1	Grounding Terminal	The wire used to ground the unit connects here.
2	Reset	<p>This switch must be pushed with a thin object, such as the end of a paper clip.</p> <ul style="list-style-type: none"> ◆ Press and release to reboot the device. ◆ Power off, hold reset then power on the device while pressing reset to recover from a firmware upgrade failure. ◆ Press and hold it in for more than three seconds resets the unit back to its factory default settings*. <p>Note: The Reset to Factory Default function resets everything but the login information (username/password) to the factory default settings. To reset the login information, refer to <i>Reset All Information</i> on page 329.</p>
3	Audio Ports	These mini stereo ports are for the speakers (green) and microphone (pink).
4	Power Jack	The cable from the DC Power adapter connects here.
5	Function Switch	<p>Use this slide switch to set the unit's mode to:</p> <ul style="list-style-type: none"> ◆ Auto: Shared (simultaneous) KVM control of the computer at the Transmitter and Receiver console.* ◆ RS-232 Config: The device is ready to be configured via serial commands through the RS-232 port. When connected to a KVM over IP Access Control Box (2XRT-0015G), users can enable / disable control privileges of the connected receivers. ◆ Local: Only the local Transmitter has KVM control of the computer. The Receiver's KVM access to the computer is locked. <p>Note: In Auto mode, RS-232 and audio functions will work on the Receiver but not on the Transmitter.</p>

No.	Component	Description
6	RS-232 Port	This RS-232 serial port is for connecting to a serial terminal.
7	Console Ports	The unit's USB keyboard and USB mouse plug into these ports.
8	LAN Port	The cable that connects the unit to the LAN plugs in here. This port is PoE enabled* for KE8952 for power redundancy or cable management. *Requires power board version B01G or later (see <i>PoE Power Redundancy</i> on page 69 for more details).
9	SFP Port	The Gigabit Ethernet (GbE) optical fiber cable that connects the unit to the LAN plugs in here.
10	HDMI Output	The cable from the local HDMI monitor plugs in here.

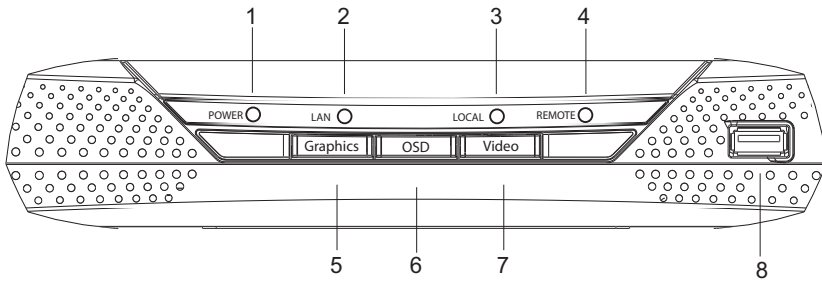
KE8950R / KE8952R (Receiver) Front View

No.	Component	Description
1	Power LED	Lights blue to indicate the unit is turned on.
2	LAN LED	This LED indicates the network status. <ul style="list-style-type: none"> ◆ Lights when connected to the LAN and blinks when the Ethernet connection is active: <ul style="list-style-type: none"> ◆ Orange: 10 Mbps ◆ Orange + Green: 100 Mbps ◆ Green: 1000 Mbps ◆ Off when not connected to the LAN.
3	Local LED	Lights green to Indicate the Transmitter has KVM access of the computer.
4	Remote LED	Lights green to Indicate the Receiver has KVM access of the computer.
5	Graphics Pushbutton	Sets the image quality of the display to the highest possible grade so that images are optimized. This toggle button turns off the Video Pushbutton option. Graphics mode is selected by default.
6	OSD Pushbutton	Use this pushbutton to open the OSD menu.
7	Video Pushbutton	Sets the image quality of the display to a grade that is optimized for playing videos. This toggle button turns off the Graphics Pushbutton option.

No.	Component	Description
8	USB Port	<p>Use this port for virtual media or a USB peripheral device.</p> <p>Note: 1. When using a USB disk plugged into this port, see <i>USB Mode</i>, page 203.</p> <p>2. This USB port does not support isochronous endpoints, therefore USB peripherals that stream audio or video data, such as speakers or webcams, will not work.</p>

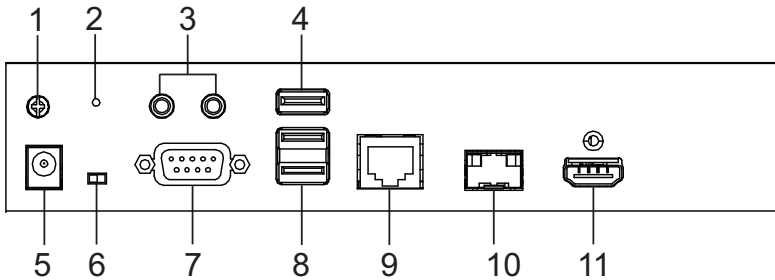
KE8950R / KE8952R (Receiver) Rear View

No.	Component	Description
1	Grounding Terminal	The wire used to ground the unit connects here.
2	Reset	<p>This switch must be pushed with a thin object, such as the end of a paper clip.</p> <ul style="list-style-type: none"> ◆ Press and release to reboot the device. ◆ Power off, hold reset then power on the device while pressing reset to recover from a firmware upgrade failure. ◆ Press and hold it in for more then three seconds resets the unit back to its factory default settings*. <p>Note: The Reset to Factory Default function resets everything but the login information (username/password) to the factory default settings. To reset the login information, refer to <i>Reset All Information</i> on page 329.</p>
3	Audio Ports	These mini stereo ports are for the local speakers (green) and microphone (pink).
4	USB Port	<p>Use this port for virtual media or a USB peripheral device.</p> <p>Note: 1. When using a USB disk plugged into this port, see <i>USB Mode</i>, page 203.</p> <p>2. This USB port does not support isochronous endpoints, therefore USB peripherals that stream audio or video data, such as speakers or webcams, will not work.</p>
5	Power Jack	The cable from the DC Power adapter connects here.
6	Function Switch	<p>Use this slide switch to set the unit's mode:</p> <ul style="list-style-type: none"> ◆ Extension: Sets the device to use the normal TX to RX extension mode. ◆ RS-232 Config: The device is ready to be configured via serial commands through the RS-232 port.
7	RS-232 Port	This RS-232 serial port is for connecting to a serial terminal.

No.	Component	Description
8	Console Ports	The unit's USB keyboard and USB mouse plug into these ports. When using a keyboard or mouse with special functions, see <i>USB Mode</i> , page 203.
9	LAN Port	The cable that connects the unit to the LAN plugs in here. This port is PoE enabled* for KE8952 for power redundancy or cable management. *Requires power board version B01G or later (see <i>PoE Power Redundancy</i> on page 69 for more details).
10	SFP Port	The Gigabit Ethernet (GbE) optical fiber cable that connects the unit to the LAN plugs in here.
11	HDMI Output	The cable from the local HDMI monitor plugs in here.

KE8900ST (Transmitter) Front, Rear and Side View

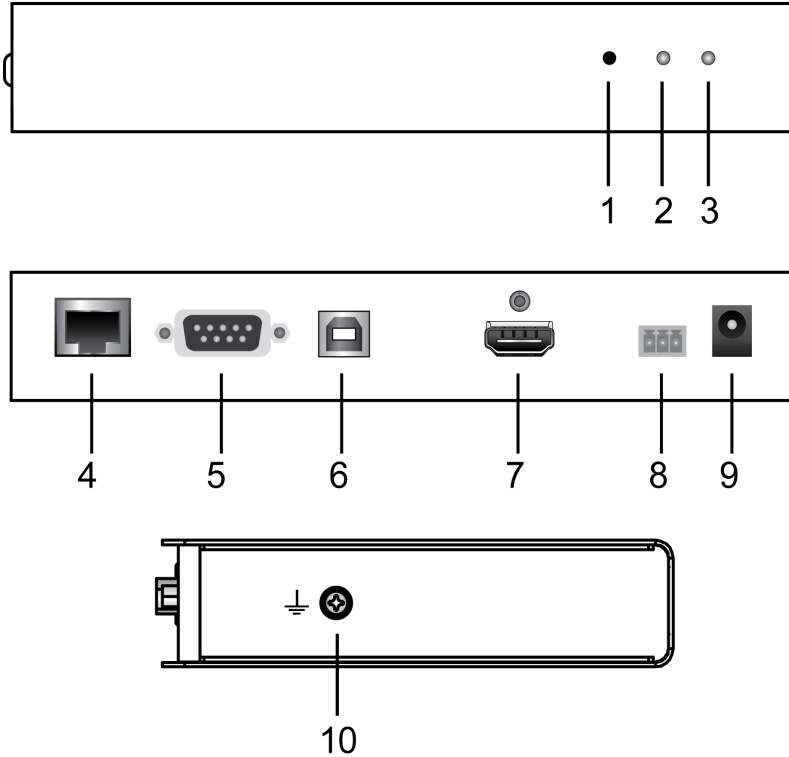

No.	Component	Description
1	Reset	<p>This switch must be pushed with a thin object, such as the end of a paper clip.</p> <ul style="list-style-type: none"> ◆ Press and release to reboot the device. ◆ Power off, hold reset then power on the device while pressing reset to recover from a firmware upgrade failure. ◆ Press and hold it in for more than three seconds resets the unit back to its factory default settings*. <p>Note: The Reset to Factory Default function resets everything but the login information (username/password) to the factory default settings. To reset the login information, refer to <i>Reset All Information</i> on page 329.</p>

No.	Component	Description
2	LAN LED	<p>This LED indicates the network status.</p> <ul style="list-style-type: none"> ◆ Lights when connected to the LAN and blinks when the Ethernet connection is active: <ul style="list-style-type: none"> ◆ Orange: 10 Mbps ◆ Orange + Green: 100 Mbps ◆ Green: 1000 Mbps ◆ Off when not connected to the LAN.
3	Power LED	Lights blue to indicate the unit is turned on.
4	LAN Port	The cable that connects the unit to the LAN plugs in here.
5	RS-232 Port	<p>This RS-232 serial port is for connecting to the computer for serial control.</p> <p>Note: When a LAN connection is detected serial commands bypass the KE8900ST and are sent across the network to the receiver. When no LAN connection is detected serial commands are automatically directed to the KE8900ST for local configuration and control.</p>
6	USB Type-B Port	The USB port that links the Transmitter to the computer .
7	HDMI Input	The cable from the local HDMI monitor plugs in here.
8	3-Pole Terminal Block	Insert DC + and - wires (DC 12 to 48V) to the terminal block for power input.
9	Power Jack	The cable from the DC Power adapter connects here.
10	Grounding Terminal	The wire used to ground the unit connects here.

KE8900SR (Receiver) Front, Rear and Side View

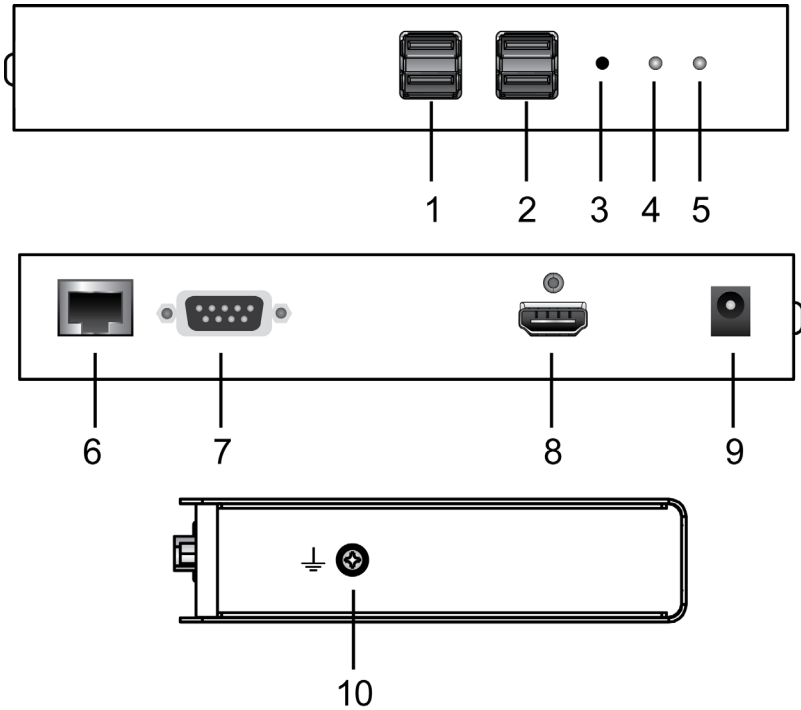

No.	Component	Description
1	USB Peripheral Port	Use this port for virtual media or a USB peripheral device. Note: 1. When using a USB disk plugged into this port, see <i>USB Mode</i> , page 203. 2. This USB port does not support isochronous endpoints, therefore USB peripherals that stream audio or video data, such as speakers or webcams, will not work.
2	Console Ports	The unit's USB keyboard and USB mouse plug into these ports.

No.	Component	Description
3	Reset	<p>This switch must be pushed with a thin object, such as the end of a paper clip.</p> <ul style="list-style-type: none"> ◆ Press and release to reboot the device. ◆ Power off, hold reset then power on the device while pressing reset to recover from a firmware upgrade failure. ◆ Press and hold it in for more then three seconds resets the unit back to its factory default settings*. <p>Note: The Reset to Factory Default function resets everything but the login information (username/password) to the factory default settings. To reset the login information, refer to <i>Reset All Information</i> on page 329.</p>
4	LAN LED	<p>This LED indicates the network status.</p> <ul style="list-style-type: none"> ◆ Lights when connected to the LAN and blinks when the Ethernet connection is active: <ul style="list-style-type: none"> ◆ Orange: 10 Mbps ◆ Orange + Green: 100 Mbps ◆ Green: 1000 Mbps ◆ Off when not connected to the LAN.
5	Power LED	Lights blue to indicate the unit is turned on.
6	LAN Port	The cable that connects the unit to the LAN plugs in here.
7	RS-232 Port	<p>This RS-232 serial port is for connecting to the computer for serial control.</p> <p>Note: When a LAN connection is detected serial commands bypass the KE8900ST and are sent across the network to the receiver. When no LAN connection is detected serial commands are automatically directed to the KE8900ST for local configuration and control.</p>
8	HDMI Output	The cable from the local HDMI monitor plugs in here.
9	Power Jack	The cable from the DC Power adapter connects here.
10	Grounding Terminal	The wire used to ground the unit connects here.

KE9900ST (Transmitter) Front, Rear and Side View

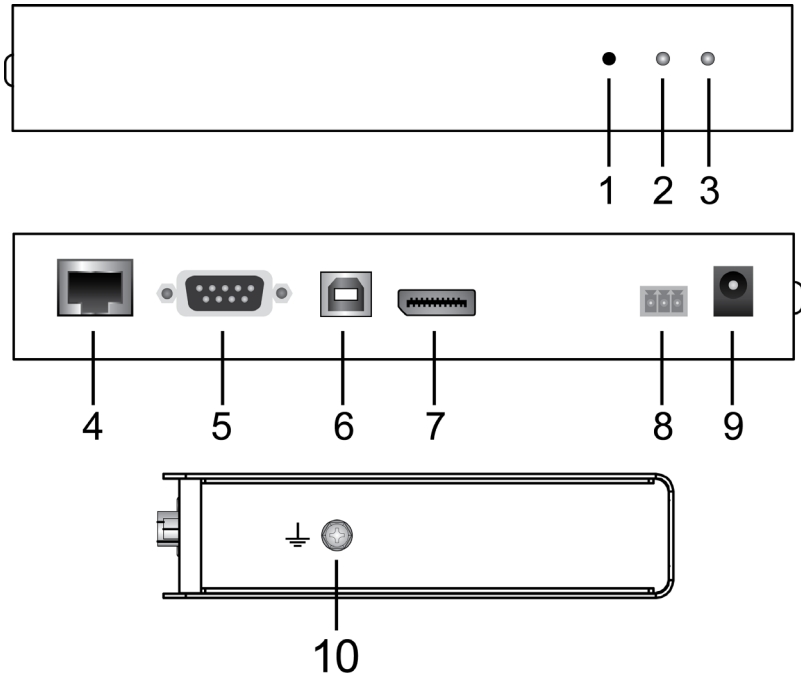

No.	Component	Description
1	Reset	<p>This switch must be pushed with a thin object, such as the end of a paper clip.</p> <ul style="list-style-type: none"> ◆ Press and release to reboot the device. ◆ Power off, hold reset then power on the device while pressing reset to recover from a firmware upgrade failure. ◆ Press and hold it in for more then three seconds resets the unit back to its factory default settings*. <p>Note: The Reset to Factory Default function resets everything but the login information (username/password) to the factory default settings. To reset the login information, refer to <i>Reset All Information</i> on page 329.</p>

No.	Component	Description
2	LAN LED	<p>This LED indicates the network status.</p> <ul style="list-style-type: none"> ◆ Lights when connected to the LAN and blinks when the Ethernet connection is active: <ul style="list-style-type: none"> ◆ Orange: 10 Mbps ◆ Orange + Green: 100 Mbps ◆ Green: 1000 Mbps ◆ Off when not connected to the LAN.
3	Power LED	Lights blue to indicate the unit is turned on.
4	LAN Port	The cable that connects the unit to the LAN plugs in here.
5	RS-232 Port	<p>This RS-232 serial port is for connecting to the computer for serial control.</p> <p>Note: When a LAN connection is detected serial commands bypass the KE8900ST and are sent across the network to the receiver. When no LAN connection is detected serial commands are automatically directed to the KE8900ST for local configuration and control.</p>
6	USB Type-B Port	The USB port that links the Transmitter to the computer.
7	DisplayPort Input	The cable from the local DisplayPort monitor plugs in here.
8	3-Pole Terminal Block	Insert DC + and - wires (DC 12 to 48V) to the terminal block for power input.
9	Power Jack	The cable from the DC Power adapter connects here.
10	Grounding Terminal	The wire used to ground the unit connects here.

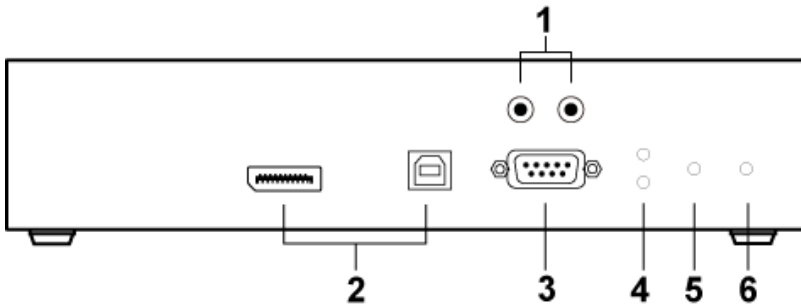
KE9950T / KE9952T (Transmitter) Front View

No.	Component	Description
1	Audio Ports	These mini stereo ports are for the speakers (green) and microphone (pink).
2	KVM Ports	The USB KVM cable supplied with the package that links the Transmitter to the computer plugs into these ports.
3	RS-232 Port	This RS-232 serial port is for connecting to the computer for serial control.
4	Remote / Local LED	Lights Green to indicate which side of the installation (Local or Remote) currently has KVM control of the computer.
5	LAN LED	This LED indicates the network status. <ul style="list-style-type: none"> ◆ Lights when connected to the LAN and blinks when the Ethernet connection is active: <ul style="list-style-type: none"> ◆ Orange: 10 Mbps ◆ Orange + Green: 100 Mbps ◆ Green: 1000 Mbps ◆ Off when not connected to the LAN.
6	Power LED	Lights blue to indicate the unit is turned on.

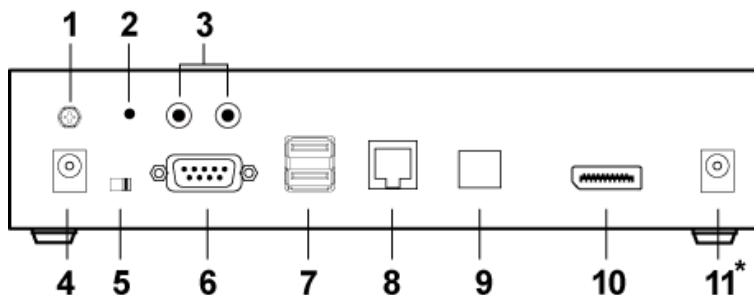
KE9950T / KE9952T (Transmitter) Rear View

No.	Component	Description
1	Grounding Terminal	The wire used to ground the unit connects here.
2	Reset	<p>This switch must be pushed with a thin object, such as the end of a paper clip.</p> <ul style="list-style-type: none"> ◆ Press and release to reboot the device. ◆ Power off, hold reset then power on the device while pressing reset to recover from a firmware upgrade failure. ◆ Press and hold it in for more than three seconds resets the unit back to its factory default settings*. <p>Note: The Reset to Factory Default function resets everything but the login information (username/password) to the factory default settings. To reset the login information, refer to <i>Reset All Information</i> on page 329.</p>
3	Audio Ports	These mini stereo ports are for the local speakers (green) and microphone (pink).
4	Power Jack	The cable from the DC Power adapter connects here.
5	Function Switch	<p>Use this slide switch to set the unit's mode to:</p> <ul style="list-style-type: none"> ◆ Auto: Shared (simultaneous) KVM control of the computer at the Transmitter and Receiver console.* ◆ RS-232 Config/Access Control: The device is ready to be configured via serial commands through the RS-232 port. When connected to a KVM over IP Access Control Box (2XRT-0015G), users can enable / disable control privileges of the connected receivers. ◆ Local: Only the local Transmitter has KVM control of the computer. The Receiver's KVM access to the computer is locked. <p>Note: In Auto mode, RS-232 and audio functions will work on the Receiver but not on the Transmitter.</p>

No.	Component	Description
6	RS-232 Port	This RS-232 serial port is for connecting to a serial terminal.
7	Console Ports	The unit's USB keyboard and USB mouse plug into these ports.
8	LAN Port	The cable that connects the unit to the LAN plugs in here. This port is PoE enabled* for KE9952 for power redundancy or cable management. *Requires power board version B01G or later (see <i>PoE Power Redundancy</i> on page 69 for more details).
9	SFP Slot	The Gigabit Ethernet (GbE) optical fiber cable that connects the unit to the LAN plugs in here.
10	DisplayPort Output	The cable from the local DisplayPort monitor plugs in here.
11	Power Jack (KE9950T only)	Connect a second power source for power redundancy.

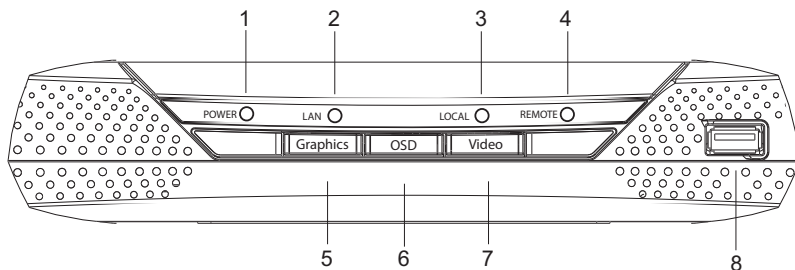
KE9950R / KE9952R (Receiver) Front View

No.	Component	Description
1	Power LED	Lights blue to indicate the unit is turned on.
2	LAN LED	This LED indicates the network status. <ul style="list-style-type: none"> ◆ Lights when connected to the LAN and blinks when the Ethernet connection is active: <ul style="list-style-type: none"> ◆ Orange: 10 Mbps ◆ Orange + Green: 100 Mbps ◆ Green: 1000 Mbps ◆ Off when not connected to the LAN.
3	Local LED	Lights green to Indicate the Transmitter has KVM access of the computer.
4	Remote LED	Lights green to Indicate the Receiver has KVM access of the computer.
5	Graphics Pushbutton	Sets the image quality of the display to the highest possible grade so that images are optimized. This toggle button turns off the Video Pushbutton option. Graphics mode is selected by default.
6	OSD Pushbutton	Use this pushbutton to open the OSD menu.
7	Video Pushbutton	Sets the image quality of the display to a grade that is optimized for playing videos. This toggle button turns off the Graphics Pushbutton option.
8	USB Port	Use this port for virtual media or a USB peripheral device. <p>Note:</p> <ol style="list-style-type: none"> 1. When using a USB disk plugged into this port, see <i>USB Mode</i>, page 203. 2. This USB port does not support isochronous endpoints, therefore USB peripherals that stream audio or video data, such as speakers or webcams, will not work.

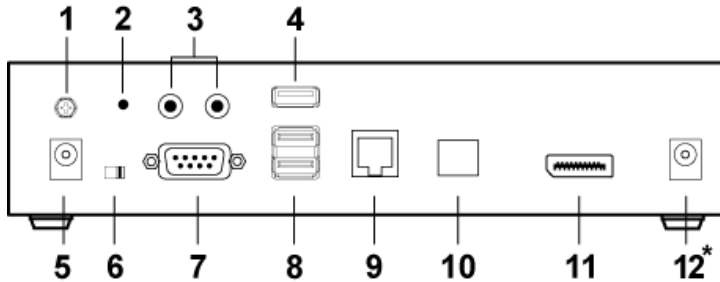
KE9950R / KE9952R (Receiver) Rear View

No.	Component	Description
1	Grounding Terminal	The wire used to ground the unit connects here.
2	Reset	<p>This switch must be pushed with a thin object, such as the end of a paper clip.</p> <ul style="list-style-type: none"> ◆ Press and release to reboot the device. ◆ Power off, hold reset then power on the device while pressing reset to recover from a firmware upgrade failure. ◆ Press and hold it in for more than three seconds resets the unit back to its factory default settings*. <p>Note: The Reset to Factory Default function resets everything but the login information (username/password) to the factory default settings. To reset the login information, refer to <i>Reset All Information</i> on page 329.</p>
3	Audio Ports	These mini stereo ports are for the local speakers (green) and microphone (pink).
4	USB Port	<p>Use this port for virtual media or a USB peripheral device.</p> <p>Note: 1. When using a USB disk plugged into this port, see <i>USB Mode</i>, page 203.</p> <p>2. This USB port does not support isochronous endpoints, therefore USB peripherals that stream audio or video data, such as speakers or webcams, will not work.</p>
5	Power Jack	The cable from the DC Power adapter connects here.
6	Function Switch	<p>Use this slide switch to set the unit's mode:</p> <ul style="list-style-type: none"> ◆ Extension: Sets the device to use the normal TX to RX extension mode. ◆ RS-232 Config: The device is ready to be configured via serial commands through the RS-232 port.

No.	Component	Description
7	RS-232 Port	This RS-232 serial port is for connecting to a serial terminal.
8	Console Ports	The unit's USB keyboard and USB mouse plug into these ports.
9	LAN Port	The cable that connects the unit to the LAN plugs in here. This port is PoE enabled* for KE9952 for power redundancy or cable management. *Requires power board version B01G or later (see <i>PoE Power Redundancy</i> on page 69 for more details).
10	SFP Slot	The Gigabit Ethernet (GbE) optical fiber cable that connects the unit to the LAN plugs in here.
11	DisplayPort Output	The cable from the local DisplayPort monitor plugs in here.
12	Power Jack (KE9950R only)	Connect a second power source for power redundancy.

PoE Power Redundancy

For power redundancy with PoE-enabled models, the unit's underside label must be printed with a "Power Board Version: B01G" string. An example is shown below and the string is indicated in the diagram:

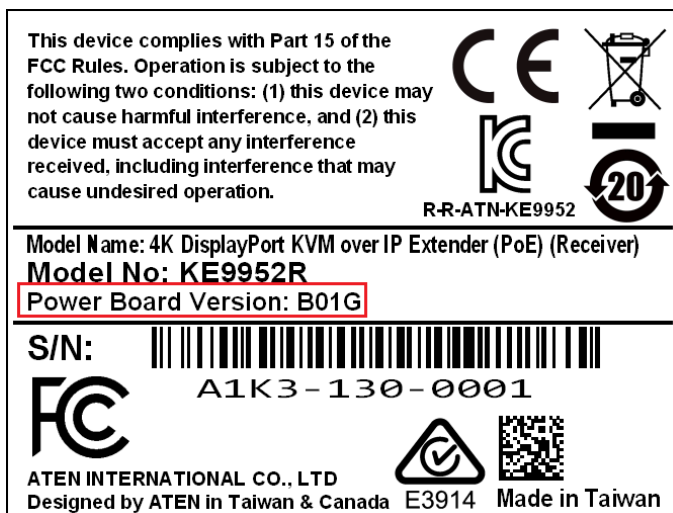

This Page Intentionally Left Blank

Chapter 2

Hardware Setup



1. Important safety information regarding the placement of this device is found on page 293. Please review it before proceeding.
2. Make sure that the power to all devices connected to the installation is turned off. You must unplug the power cords of any computers that have the Keyboard Power On function.

Mounting

For convenience and flexibility, the transmitters can be mounted on system racks or on a wall.

Note: Optional mounting options are available, refer to *Optional Rack Mounting* on page 320 for more information.

The following sections will demonstrate on how to mount the transmitters with the included mounting kit.

Attaching the Bracket

Follow the steps below to attach the mounting bracket to the unit:

Non-Slim Transmitters

Note: Steps for the non-slim transmitters (KE6900, KE6900A, KE6910, KE6912, KE6920, KE6922, KE6940, KE6940A, KE8950, KE8952, KE9950, and KE9952) are the same and KE6900 will be shown in the steps below.

1. Unscrew the screws from the side shown in the diagram below:

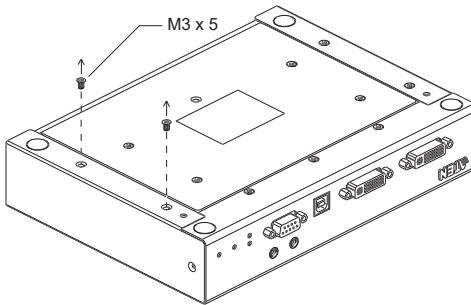

2. Use the screws from step 1 to screw the mounting bracket to the bottom of the Transmitter as shown below:

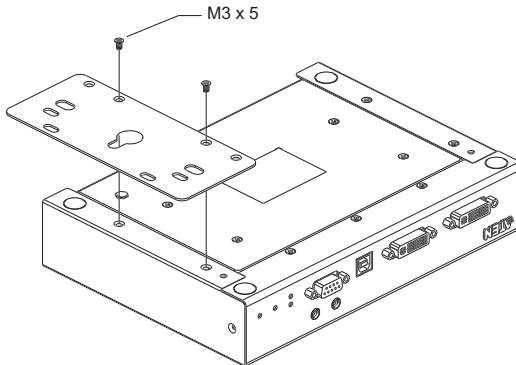

Slim Transmitters - KE6900ST

Using the screws provided in the Mounting Kit, screw the mounting bracket into the bottom of the Transmitter as show below:

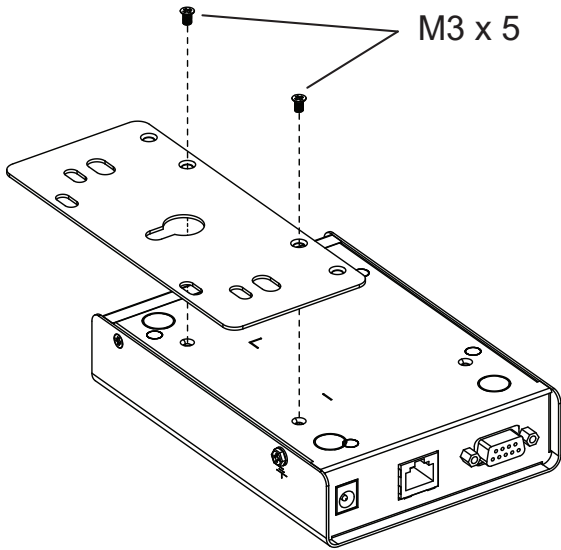

Slim Transmitters - KE8900ST / KE9900ST

KE8900ST is used in the diagrams below.

1. Unscrew the screws from the side shown in the diagram below:

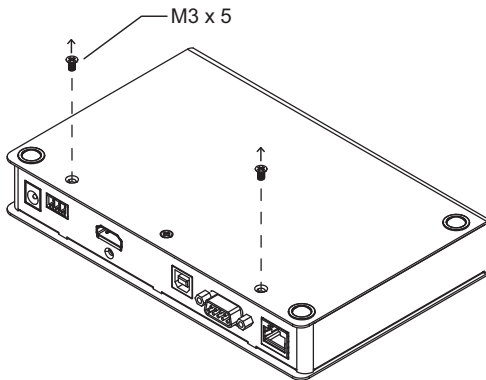

2. Use the screws from step 1 to screw the mounting bracket to the bottom of the Transmitter as shown below:

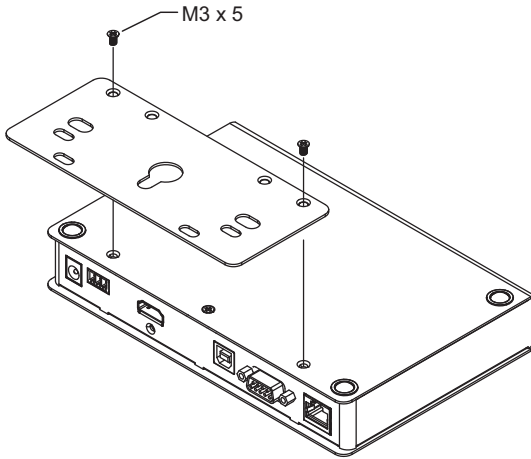

Rack Mount

Non-Slim Transmitters

Note: Steps for the non-slim transmitters (KE6900, KE6900A, KE6910, KE6912, KE6920, KE6922, KE6940, KE6940A, KE8950, KE8952, KE9950, and KE9952) are the same and KE6900 will be shown in the steps below.

Screw the bracket into a convenient location on the rack.

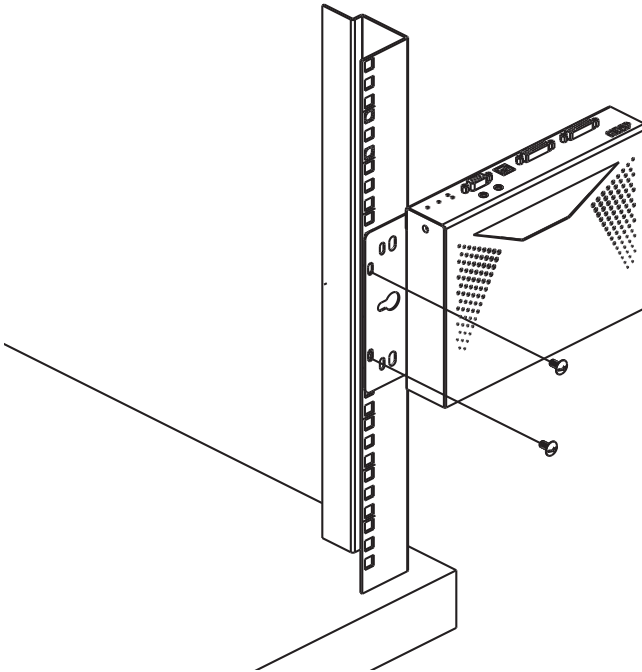

Note: Rack screws are not provided. We recommend that you use M5 x 12 Phillips Type I cross recessed type screws.

Slim Transmitters - KE6900ST

Screw the bracket into a convenient location on the rack.

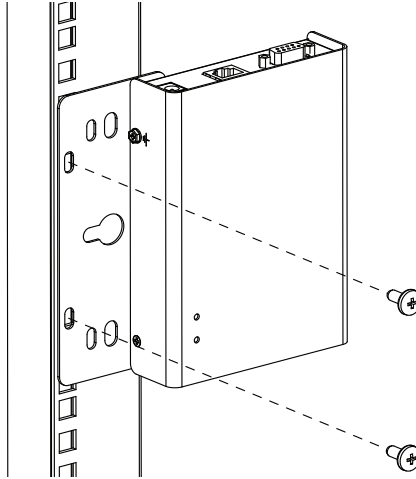

Note: Rack screws are not provided. We recommend that you use M5 x 12 Phillips Type I cross recessed type screws.

Slim Transmitters - KE8900ST / KE9900ST

Screw the mounting bracket to any convenient location on the rack.

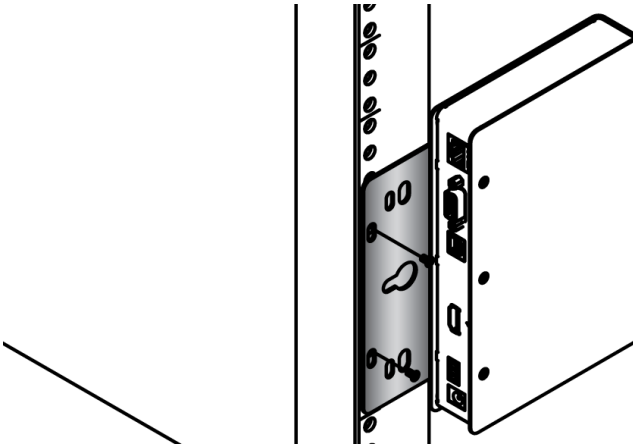

Wall Mounting

Non-Slim Transmitters

Note: Steps for the non-slim transmitters (KE6900, KE6900A, KE6910, KE6912, KE6920, KE6922, KE6940, KE6940A, KE8950, KE8952, KE9950, and KE9952) are the same and KE6900 will be shown in the steps below.

Use the center hole to screw the bracket to a secure wall surface.

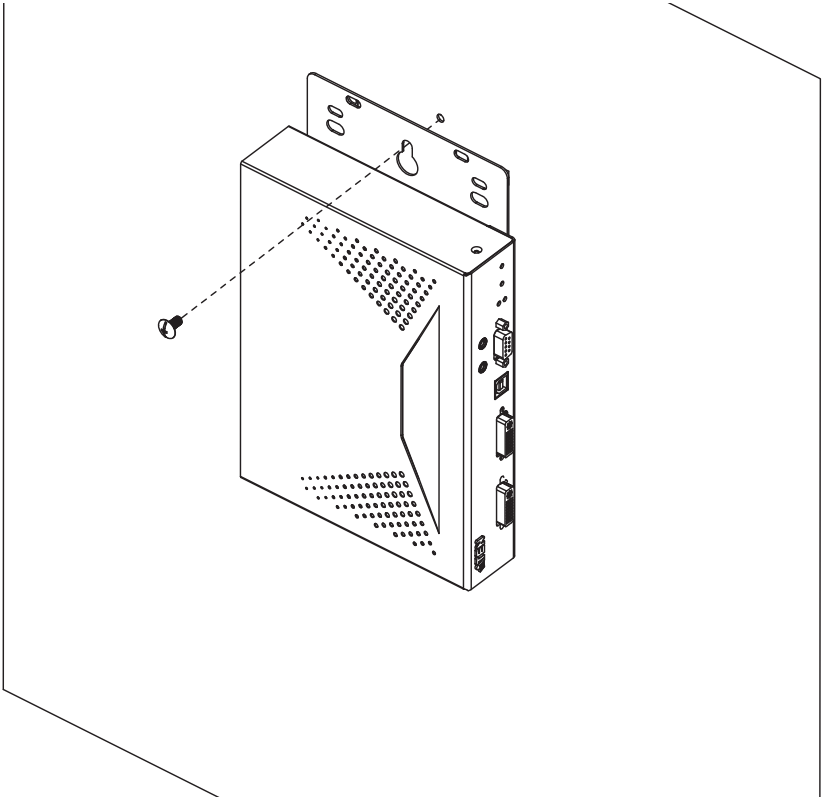

Slim Transmitters - KE6900ST

Use the center hole to screw the bracket to a secure wall surface.

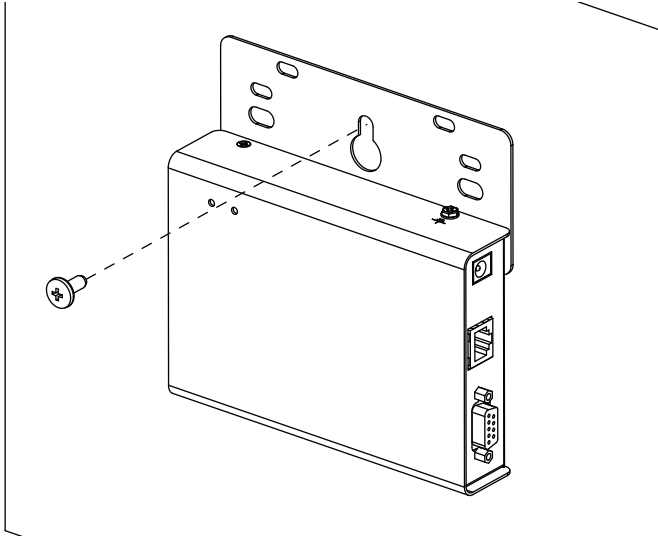

Slim Transmitters - KE8900ST / KE9900ST

Use the mounting bracket's center screw hole to mount the unit on a wall.

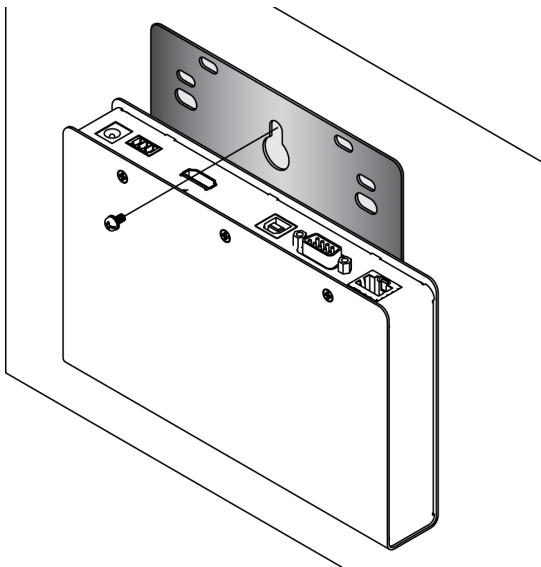

KE6900 / KE6940 Point-to-Point Installation

Setting up the KE6900 / KE6940 system in a point-to-point configuration is simply a matter of plugging in the cables.

Note: In a point-to-point configuration, no administrator setup is necessary.

Make sure that all the equipment is powered off. Refer to the installation diagrams on the next two pages and do the following:

1. On the Transmitter side, plug the mouse, keyboard, DVI monitor, microphone and speakers into the ports on the Console section of the KE6900T / KE6940T. Each port is marked with an appropriate icon to indicate itself.*
2. Connect the USB KVM cable provided to the KVM Ports on the front of the KE6900T / KE6940T.
3. Connect the other end of the USB KVM cable to the keyboard, video, mouse, speaker and microphone ports on the computer.
4. For control of serial devices, connect the RS-232 serial port on the Transmitter to a serial port on the computer.
5. Connect a Cat 5e/6 cable to the KE6900T / KE6940T's LAN port.
6. Plug the power adapter into an AC source; and plug the other end into the KE6900T / KE6940T's Power Jack.
7. On the Receiver side, plug the mouse, keyboard, DVI monitor, microphone, and speakers into the ports on the Console section of the KE6900R / KE6940R.**
8. Connect the other end of the Cat 5e/6 cable to the KE6900R / KE6940R's LAN port.
9. Plug the second power adapter into an AC source; and plug the other end into the KE6900R / KE6940R's Power Jack.
10. Power on the computer.

Note: 1. If installing the KE6940 with two DVI monitors, connect the second DVI monitor via a DVI cable into the additional ports on the KE6940 and computer.

2. A keyboard or mouse with special functions may need to use the USB ports for advanced features to work (see *USB Mode*, page 203).
-

KE6900 / KE6940 Point-to-Point Installation 1 of 2

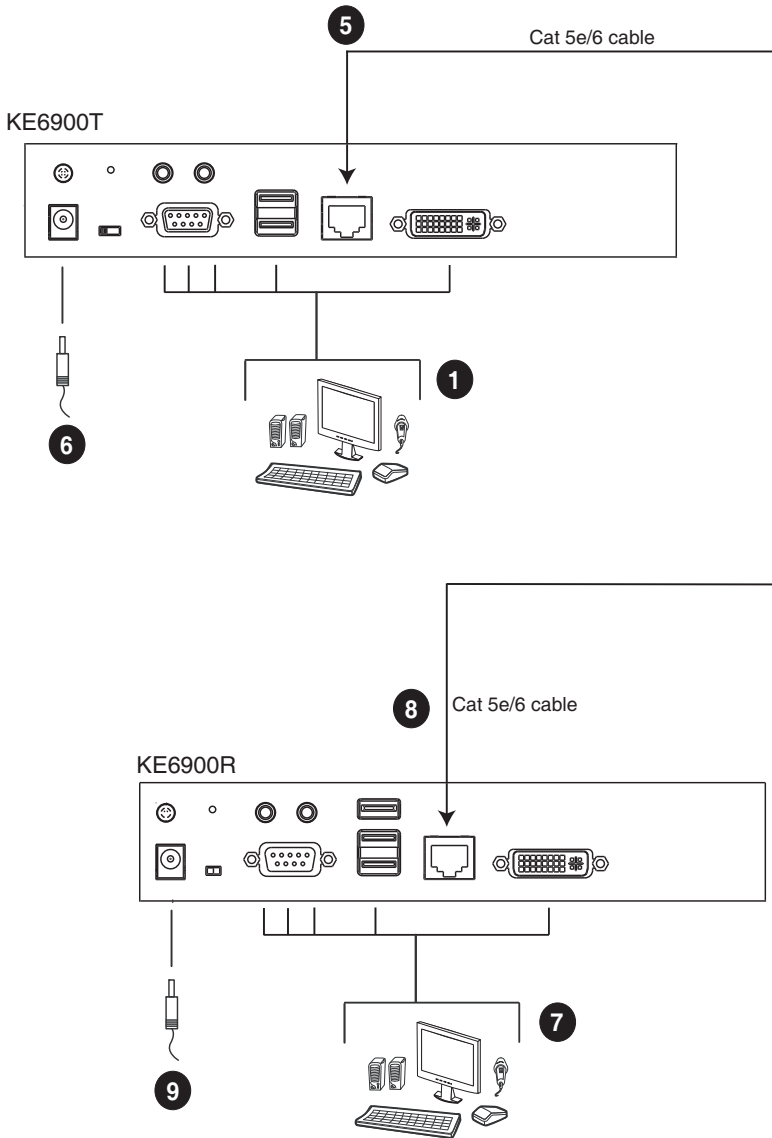

Note: The diagram above shows the KE6900T and KE6900R. The KE6940 installation is the same except that an additional DVI monitor can be connected at each end for a dual-view display setup.

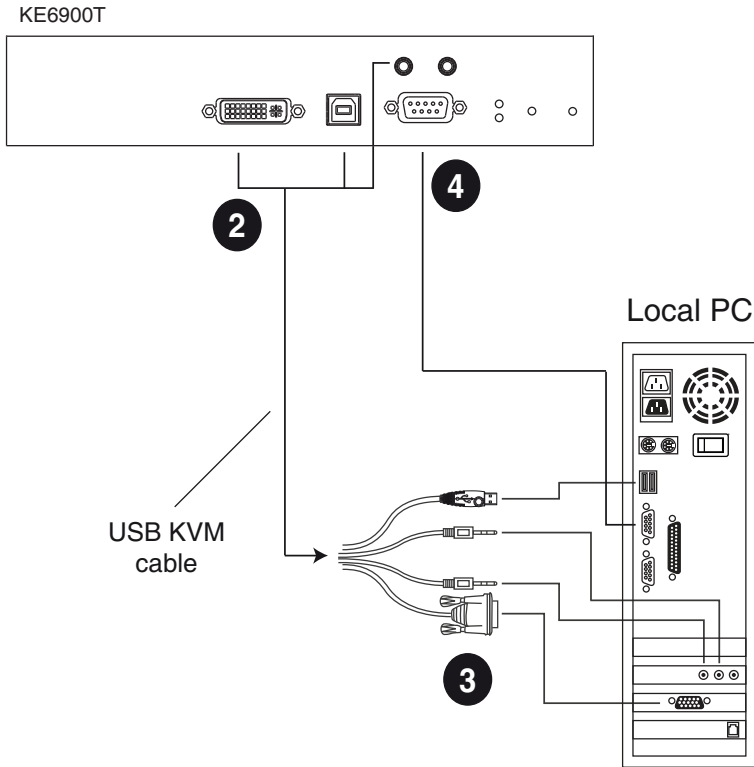
KE6900 / KE6940 Point-to-Point Installation 2 of 2

Note: The serial port on the Transmitter (shown above) connects to the computer; the serial port on the Receiver (not shown) connects to a serial device (optional).

KE6900A / KE6940A Point-to-Point Installation

Setting up the KE6900A / KE6940A system in a point-to-point configuration is simply a matter of plugging in the cables.

Note: In a point-to-point configuration, no administrator setup is necessary.

Make sure that all the equipment is powered off. Refer to the installation diagrams on the next two pages and do the following:

1. (Optional) Connect a grounding wire between the extender's grounding terminal and a suitable grounded object.
2. On the transmitter side, plug the mouse, keyboard, DVI monitor, and serial devices into the ports on the Console section of the transmitter (KE6900AT/KE6940AT)¹.
3. Connect the DVI-D cable and the USB 2.0 Type-A to Type-B cable provided with this package into the KVM Ports on the front of the transmitter.
4. Connect the other end of the USB DVI-D KVM cable into the keyboard, video, mouse, speaker and microphone ports on the computer.
5. For control of serial devices, connect the RS-232 port on the front of the transmitter to a serial port on the computer.
6. Connect a Cat 5e/6 cable to the transmitter's LAN port.
7. Plug the mouse, keyboard, DVI monitor, and serial devices into the ports on the Console section of the receiver (KE6900AR/KE6940AR)².
8. Connect the other end of the Cat 5e/6 cable to the receiver's LAN port.
9. Instead of connecting through the LAN ports, you can choose to connect the extenders through the SFP slots. To do so, plug SFP modules into the transmitter and receiver's SFP slots, then connect each end of Gigabit Ethernet (GbE) optical fiber between the SFP modules³.
10. Plug the power adapters into AC sources with the power cords and plug the other ends into the transmitter and receiver's power jacks respectively.
11. (Optional) For power redundancy, plug the second power adapters into AC sources with the power cords and plug the other ends into the transmitter and receiver's power jacks.
12. Power on the computer.

- Note:**
1. If installing the KE6940A with two DVI monitors, connect the second DVI monitor via a DVI cable into the additional ports on the KE6940 and computer.
 2. A keyboard or mouse with special functions may need to use the USB ports for advanced features to work (see *USB Mode*, page 203).
 3. The SFP module 2A-136G / 2A-137G is sold separately. Contact your ATEN dealer for product information.

KE6900A / KE6940A Point-to-Point Installation 1 of 2

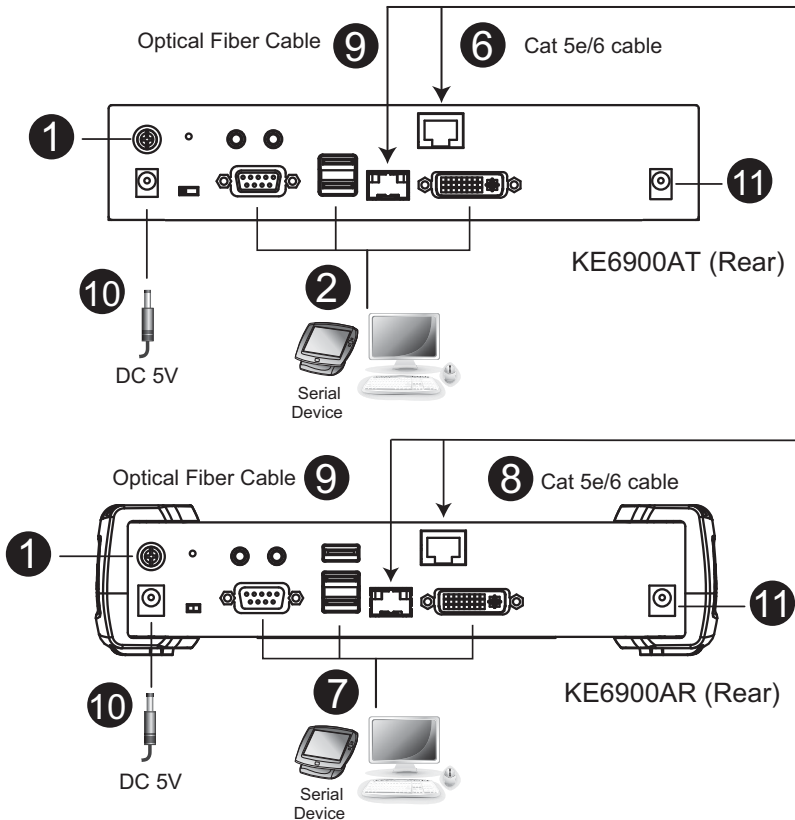

Note: The diagram above shows the KE6900AT and KE6900AR. The KE6940A installation is the same except that an additional DVI monitor can be connected at each end for a dual-view display setup.

KE6900A / KE6940A Point-to-Point Installation 2 of 2

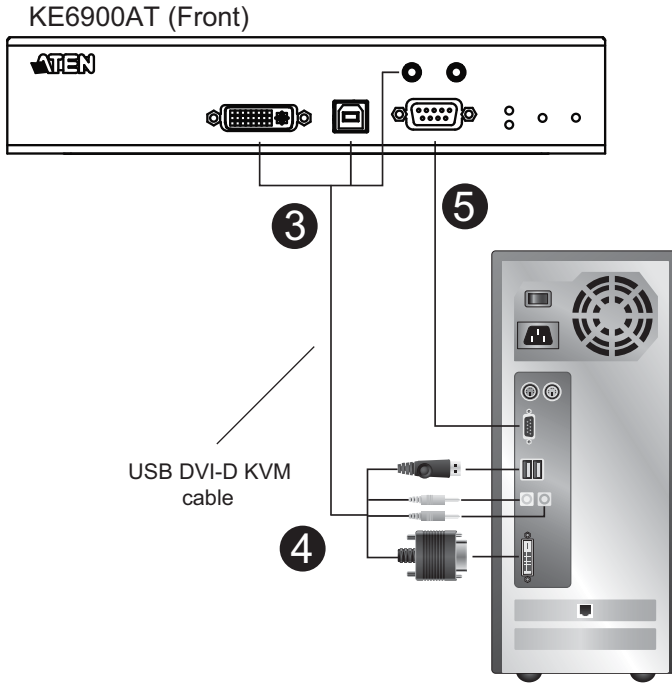

Note: The serial port on the Transmitter (shown above) connects to the computer; the serial port on the Receiver (not shown) connects to a serial device (optional).

KE6910 / KE6912 Point-to-Point Installation

Setting up the KE6910 / KE6912 system in a point-to-point configuration is simply a matter of plugging in the cables.

Note: In a point-to-point configuration, no administrator setup is necessary.

Make sure that all the equipment is powered off. Refer to the installation diagrams on the next two pages and do the following:

1. (Optional) Use the grounding wire to connect the extender's grounding terminal to a suitable grounded object.
2. On the transmitter side, plug the mouse, keyboard, DVI-D monitor, serial devices, microphone and speakers into the ports on the Console section of the KE6910T / KE6912T.
3. Connect the USB DVI-D KVM cable provided with this package into the KVM Ports and the audio ports on the front of the KE6910T / KE6912T.
4. Connect the other end of the USB DVI-D KVM cable into the keyboard, video, mouse, speaker and microphone ports on the computer.
5. For control of serial devices, connect the RS-232 port on the front of the transmitter to a serial port on the computer.
6. Connect a Cat 5e/6 cable to the KE6910T / KE6912T's LAN port.
7. On the receiver side, plug the mouse, keyboard, DVI-D monitor, serial devices, microphone, and speakers into the ports on the Console section of the KE6910R / KE6912R.
8. Connect the other end of the Cat 5e/6 cable to the KE6910R / KE6912R's LAN port.
9. Instead of connecting through the LAN ports, you can choose to connect the KE6910 / KE6912 through the SFP slots. To do so, plug SFP modules into the transmitter and receiver's SFP slots, then connect each end of Gigabit Ethernet (GbE) optical fiber between the SFP modules.*
10. Plug the power adapters into AC sources with the power cords; then plug the other ends into the transmitter and receiver's power jacks respectively. The KE6912 supports Power over Ethernet (PoE), thus the power can be supplied through PoE network switch, without the need of a power adapter.

11. (Optional) For power redundancy, plug the second power adapters into AC sources with the power cords; then plug the other ends into the transmitter and receiver's power jacks.**
12. Power on the computer.

Note: 1. The SFP module 2A-136G / 2A-137G is sold separately. Contact your ATEN dealer for product information.

2. Available for KE6910T and KE6910R only. The second power adapter with the power cord is sold separately. Contact your ATEN dealer for product information. Power redundancy for KE6912T and KE6912R can be achieved with the PoE function.

KE6910 / KE6912 Point-to-Point Installation 1 of 2

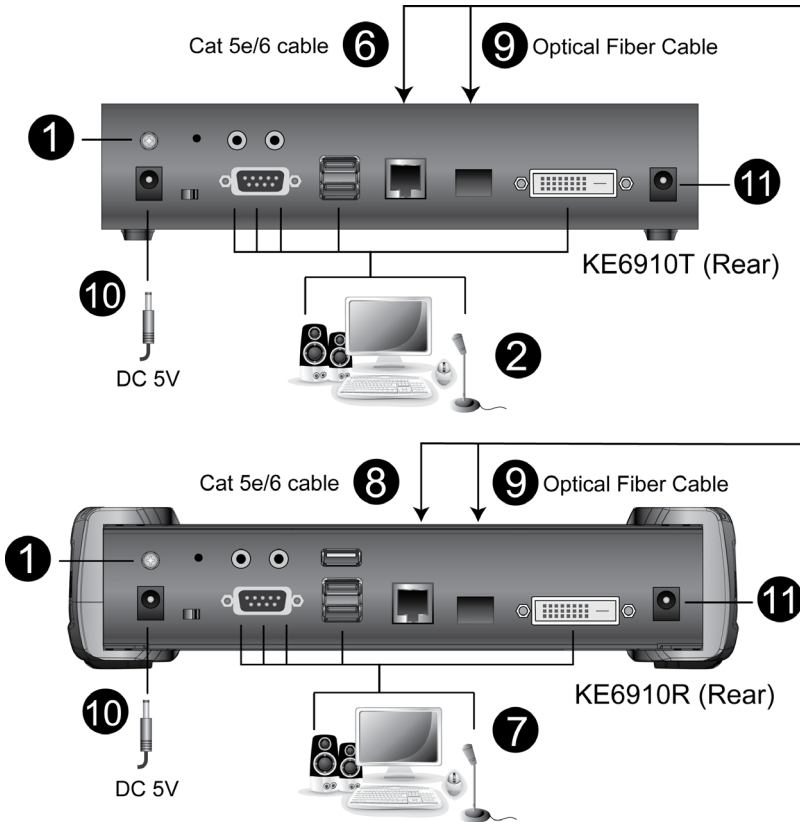

KE6910 / KE6912 Point-to-Point Installation 2 of 2

KE6910T (Front)

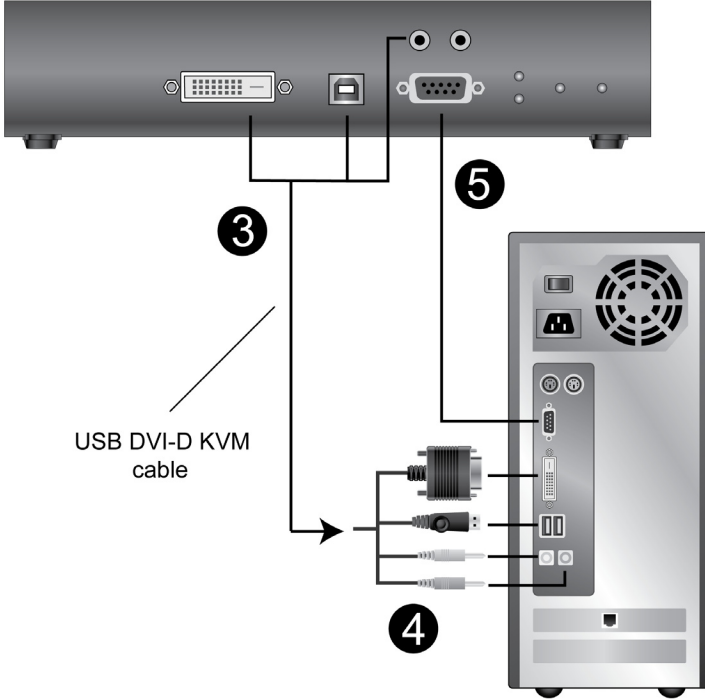

KE6920 / KE6922 Point-to-Point Installation

Setting up the KE6920 / KE6922 system in a point-to-point configuration is simply a matter of plugging in the cables.

Note: In a point-to-point configuration, no administrator setup is necessary.

Make sure that all the equipment is powered off. Refer to the installation diagrams on the next two pages and do the following:

1. (Optional) Connect a grounding wire between the extender's grounding terminal and a suitable grounded object.
2. On the transmitter side, plug the mouse, keyboard, DVI monitor, and serial devices into the ports on the Console section of the transmitter (KE6920T/KE6922T).
3. Connect the DVI-D cable and the USB 2.0 Type-A to Type-B cable provided with this package into the KVM Ports on the front of the transmitter.
4. Connect the other end of the USB DVI-D KVM cable into the keyboard, video, mouse, speaker and microphone ports on the computer.
5. For control of serial devices, connect the RS-232 port on the front of the transmitter to a serial port on the computer.
6. Connect a Cat 5e/6 cable to the transmitter's LAN port.
7. Plug the mouse, keyboard, DVI monitor, and serial devices into the ports on the Console section of the receiver (KE6920R/KE6922R).
8. Connect the other end of the Cat 5e/6 cable to the receiver's LAN port.
9. Instead of connecting through the LAN ports, you can choose to connect the extenders through the SFP slots. To do so, plug SFP modules into the transmitter and receiver's SFP slots, then connect each end of Gigabit Ethernet (GbE) optical fiber between the SFP modules¹.
10. Plug the power adapters into AC sources with the power cords and plug the other ends into the transmitter and receiver's power jacks respectively.
11. (Optional) For power redundancy, plug the second power adapters into AC sources with the power cords and plug the other ends into the transmitter and receiver's power jacks².
12. Power on the computer.

- Note:** 1. The SFP module 2A-136G / 2A-137G is sold separately. Contact your ATEN dealer for product information.
2. Available for KE6920T and KE6920R only. The second power adapter with the power cord is sold separately. Contact your ATEN dealer for product information. Power redundancy for KE6922T and KE6922R can be achieved with the PoE function.

KE6920 / KE6922 Point-to-Point Installation 1 of 2

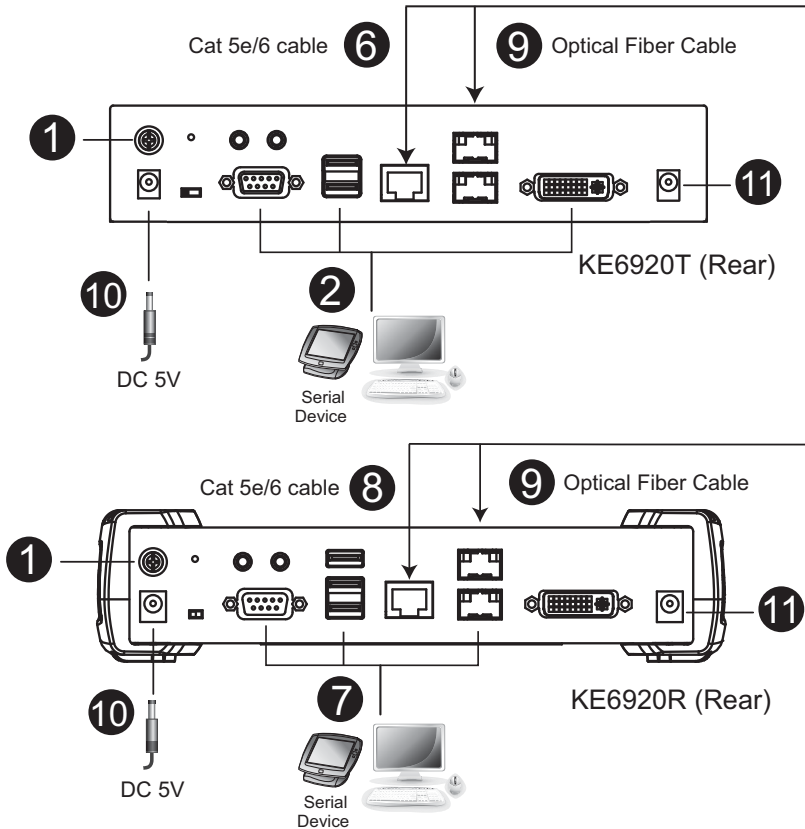

KE6920 / KE6922 Point-to-Point Installation 2 of 2

KE6920T (Front)

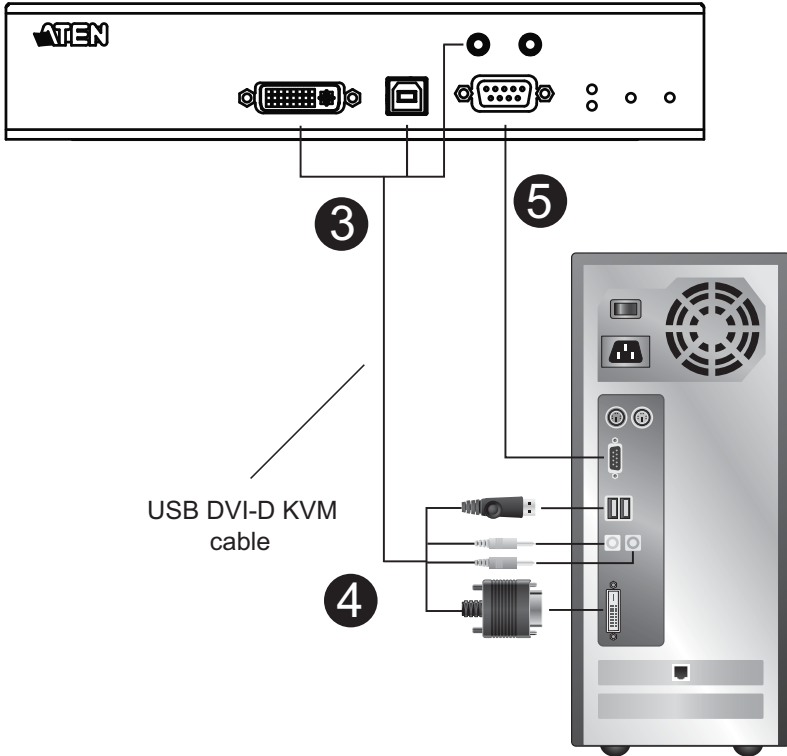

KE8950 / KE8952 Point-to-Point Installation

Setting up the KE8950 / KE8952 system in a point-to-point configuration is simply a matter of plugging in the cables.

Note: In a point-to-point configuration, no administrator setup is necessary.

Make sure that all the equipment is powered off. Refer to the installation diagrams on the next two pages and do the following:

1. On the transmitter side, plug the mouse, keyboard, HDMI monitor, microphone and speakers into the ports on the Console section of the KE8950T / KE8952T. Each port is marked with an appropriate icon to indicate its function.
2. Connect the USB HDMI KVM cable provided with this package into the KVM Ports on the front of the KE8950T / KE8952T.
3. Connect the other end of the USB HDMI KVM cable into the keyboard, video, mouse, speaker and microphone ports on the computer.
4. For control of serial devices, connect the RS-232 serial port on the transmitter to a serial port on the computer.
5. Connect a Cat 5e/6 cable to the KE8950T / KE8952T's LAN port, or a Gigabit Ethernet (GbE) optical fiber cable to the SFP port.
6. Plug the power adapter into an AC source; then plug the other end into the KE8950T / KE8952T's power jack.*
7. On the receiver side, plug the mouse, keyboard, HDMI monitor, microphone, and speakers into the ports on the Console section of the KE8950R / KE8952R.
8. Connect the other end of the Cat 5e/6 cable to the KE8950R / KE8952R's LAN port; or the other end of the Gigabit Ethernet (GbE) optical fiber cable to the SFP port.
9. Plug the second power adapter into an AC source; then plug the other end into the KE8950R / KE8952R's power jack.*
10. Power on the computer.

Note: Power adapters are not provided with KE8952 units. Please contact your ATEN dealer to purchase additional power adapters.

KE8950 / KE8952 Point-to-Point Installation 1 of 2

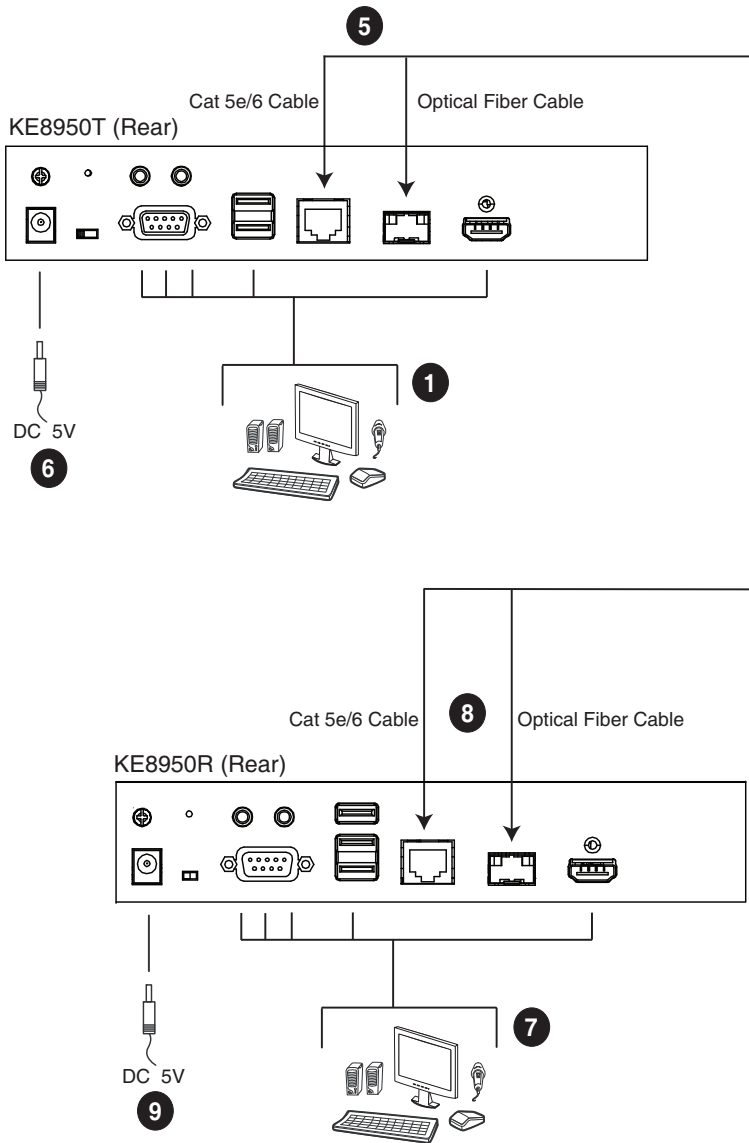

Note: Power adapters are not provided with the KE8952. Please contact your ATEN dealer to purchase additional power adapters, or use the Power over Ethernet (PoE) feature to supply power to the KE8952.

KE8950 / KE8952 Point-to-Point Installation 2 of 2

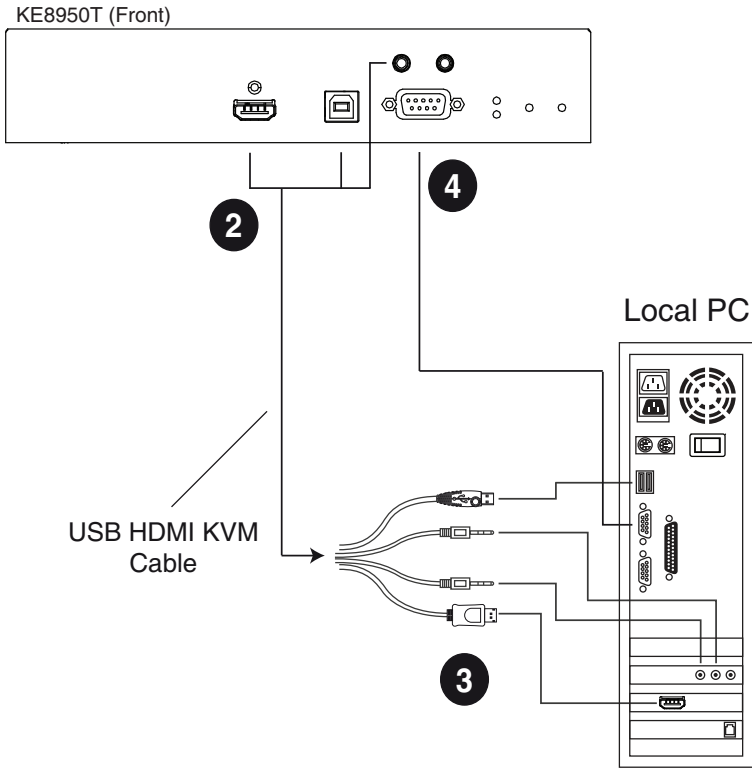

Note: The serial port on the Transmitter (shown above) connects to the computer; the serial port on the Receiver (not shown) connects to a serial device (optional).

KE6900ST Point-to-Point Installation

The KE6900ST DVI KVM over IP Extender Lite is a cost saving alternative for installations with Transmitters that don't need a local console or audio transmission but want the connectivity features of advanced KE models.

Setting up the KE6900ST system in a point-to-point configuration is simply a matter of plugging in the cables. Make sure that all the equipment is powered off. Refer to the installation diagrams on the next page and do the following:

1. Connect the USB DVI-D KVM Cable (provided with this package) to the USB and DVI-D ports on the front of the KE6900ST.
2. Connect the other end of the USB DVI-D KVM Cable to USB and DVI video ports on the computer.
3. For control of serial devices, connect the RS-232 serial port on the KE6900ST to a serial port on the computer.
4. Plug the power adapter (provided with this package) into an AC source; and plug the other end into the KE6900ST Power Jack.
5. Connect a Cat 5e/6 cable to the KE6900ST's LAN port.
6. Connect the other end of the Cat 5e/6 cable to the KE69x0R's* LAN port.
7. On the Receiver side, plug the mouse, keyboard and DVI monitor into the ports on the Console section of the KE69x0R.*
8. Plug the second power adapter into an AC source; and plug the other end into the KE69x0R's Power Jack.
9. Power on the computer.

Note: KE69x0R units are required and sold separately.

Setting up a LAN Installation

Setting up the KE6900ST on a network allows point-to-point, point-to-multipoint, and multipoint-to-multipoint computer to console operation by connecting multiple KE69x0 devices on the same TCP/IP LAN. To setup a LAN installation, simply connect the Cat 5e/6 cable (in step 5 above) to the network instead of directly between two KE69x0 devices and see *KE6900 / KE6940 LAN Installation*, page 103 for details.

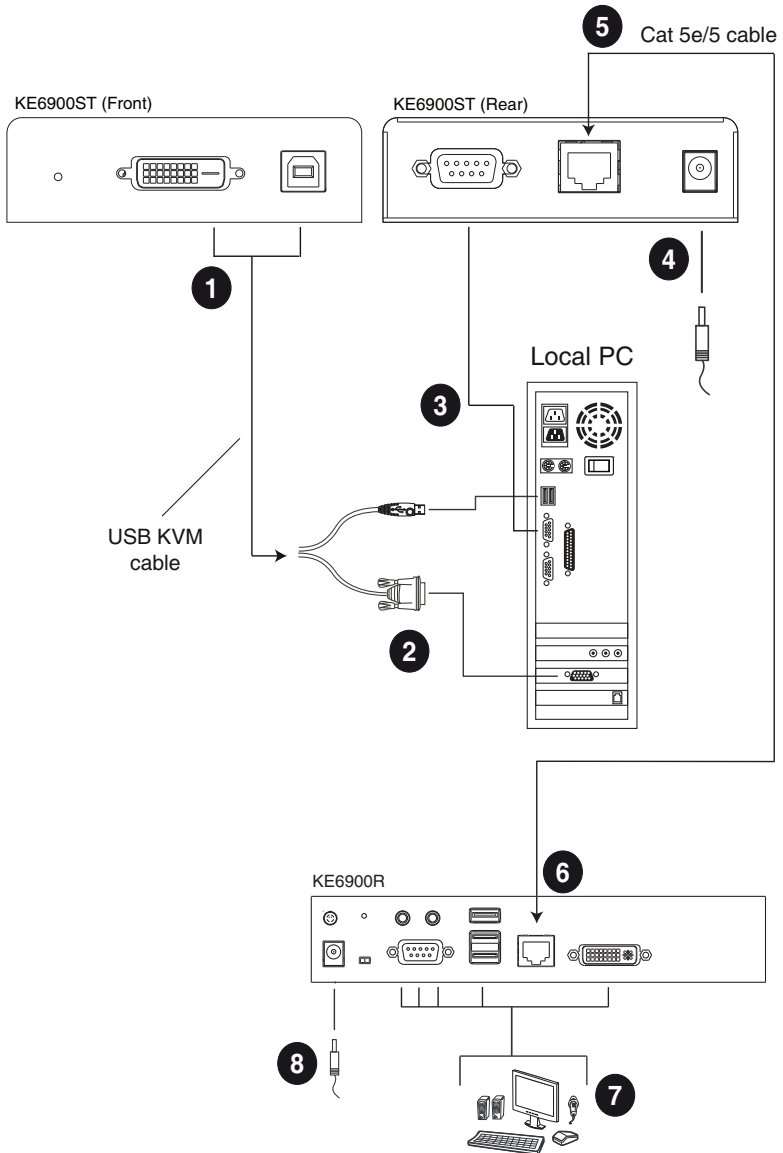

KE8900S Point-to-Point Installation

The KE8900S Slim HDMI KVM over IP Extender is a cost saving alternative for installations that don't need a local console or audio transmission but want the connectivity features of advanced KE models.

Setting up the KE8900S system in a point-to-point configuration is simply a matter of plugging in the cables. Make sure that all the equipment is powered off. Refer to the installation diagrams on the next page and do the following:

1. (Optional) Connect the grounding terminals of KE8900ST and KE8900SR to a suitable grounded object using grounding wires.
2. Connect the USB HDMI KVM Cable provided with this package between a computer and the KE8900ST. Please use the USB Type-B end of the USB HDMI KVM Cable for the KE8900ST as it has a USB Type-B port.
3. Connect a Cat 5e/6 cable between the LAN ports of KE8900ST and KE8900SR.
4. Connect a USB mouse/keyboard to the front panel of the KE8900SR and HDMI monitor to the rear panel of the KE8900SR.
5. Plug the power adapters into power sockets; then plug the other ends respectively into KE8900ST and KE8900SR's power jacks. For KE8900ST, you can choose to use the terminal block for power input. Insert DC + and - wires (DC 12 to 48V) to the terminal block according to the icon.*
6. (Optional) For control of serial devices, connect the RS-232 serial port on the KE8900ST to a serial port on the computer.
7. Power on the computer.

Setting up a LAN Installation

Setting up the units on a network allows point-to-point, point-to-multipoint, and multipoint-to-multipoint computer to console operation by connecting multiple KE Series devices on the same TCP/IP LAN. To set up a LAN installation, simply connect the Cat 5e/6 cable (in step 3) to the network instead of directly between two KE Series devices. As an example, please refer to *KE6900 / KE6940 LAN Installation*.

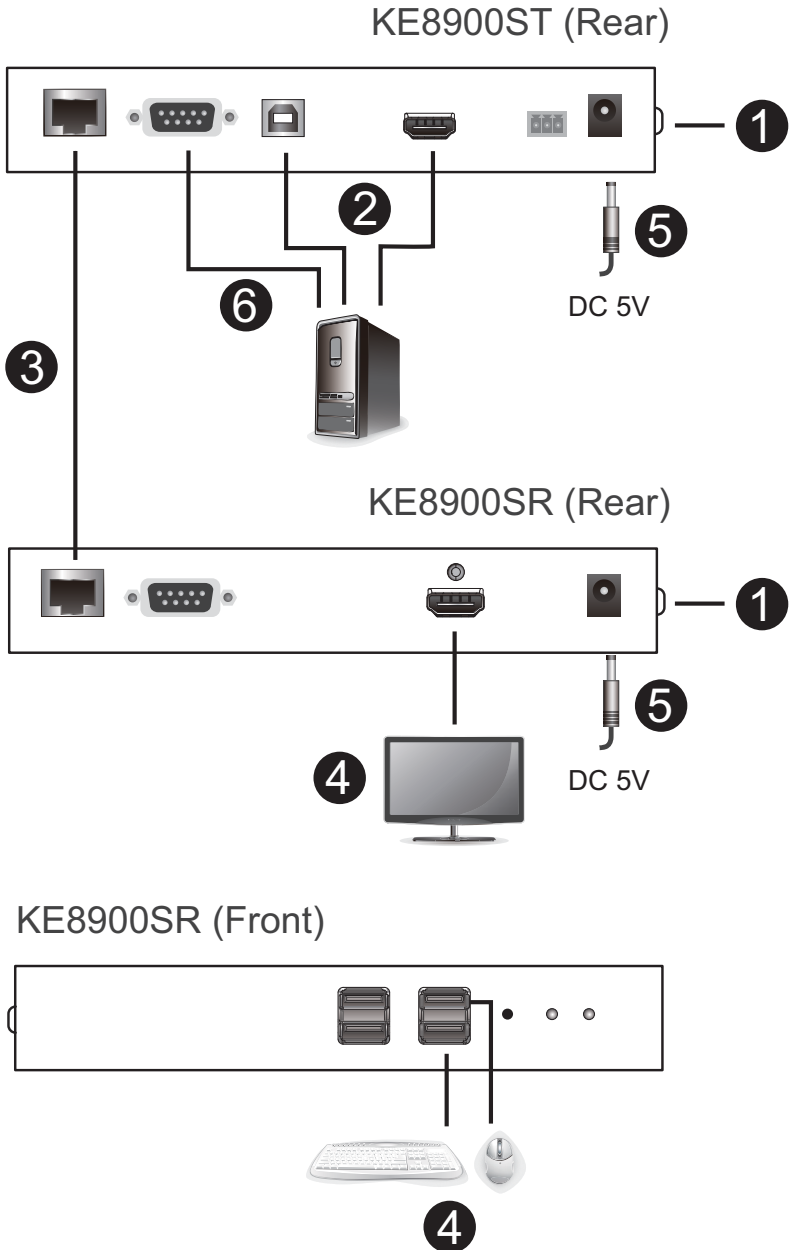

KE9900ST Point-to-Point Installation

The KE9900ST DisplayPort KVM over IP Extender Lite is a cost saving alternative for installations with Transmitters that don't need a local console or audio transmission but want the connectivity features of advanced KE models.

Setting up the KE9900ST system in a point-to-point configuration is simply a matter of plugging in the cables. Make sure that all the equipment is powered off. Refer to the installation diagrams on the next page and do the following:

1. (Optional) Connect the grounding terminal of the KE9900ST to a suitable grounded object using a grounding wire.
2. Connect the supplied DisplayPort Cable between the DisplayPort ports of the computer and the KE9900ST.
3. With the supplied USB 2.0 Type-A to Type-B cable, connect the USB Type-A end to the computer and the Type-B end to the KE9900ST.
4. (Optional) For control of serial devices, connect the RS-232 serial port on the KE9900ST to a serial port on the computer.
5. Connect a Cat 5e/6 cable between the LAN ports of KE9900ST and the receiver unit* (e.g. KE8900SR).
6. Connect a USB mouse/keyboard and HDMI monitor to their respective ports on the KE8900SR.
7. Power the KE8900SR (e.g. plugging power adapter between the unit and a power socket).
8. Plug the power adapter into a power socket; then plug the other end into KE9900ST's power jack. Alternatively, you can choose to use the terminal block for power input. Insert DC + and - wires (DC 12 to 48V) to the terminal block according to the icon.
9. Power on the computer.

Note: A KE Series receiver unit is required and sold separately.

Setting up a LAN Installation

Setting up the units on a network allows point-to-point, point-to-multipoint, and multipoint-to-multipoint computer to console operation by connecting multiple KE Series devices on the same TCP/IP LAN. To set up a LAN installation, simply connect the Cat 5e/6 cable (in step 5) to the network instead

of directly between two KE Series devices. As an example, please refer to *KE6900 / KE6940 LAN Installation*.

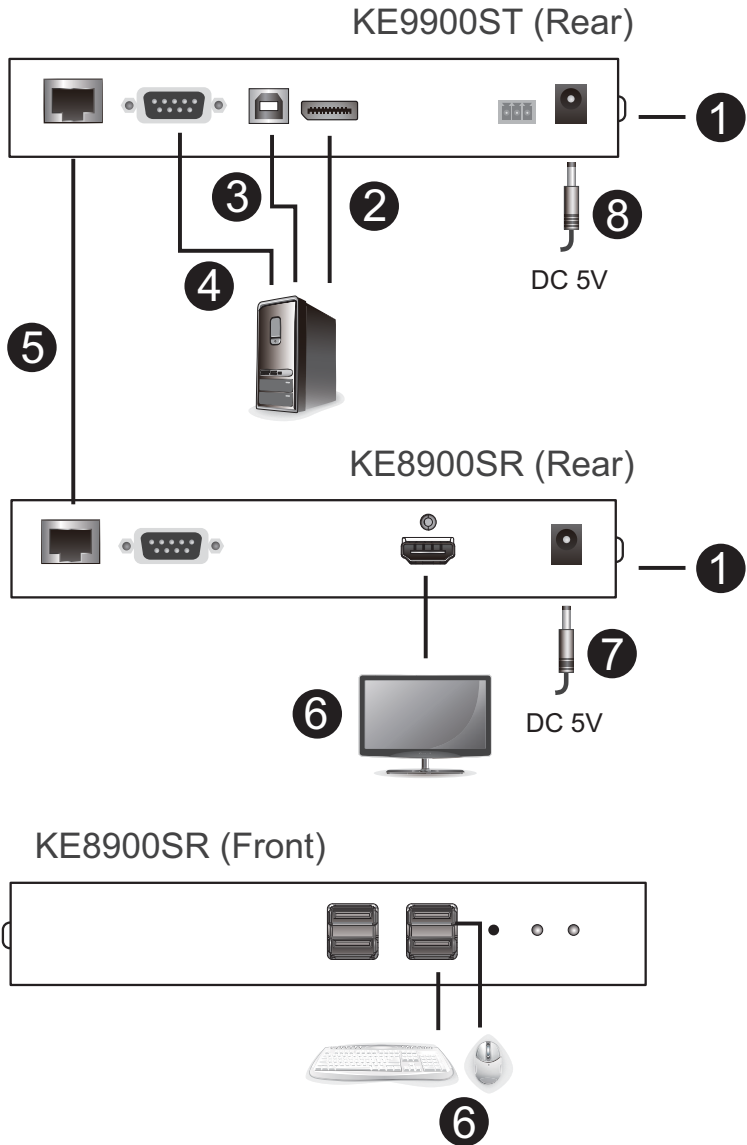

KE9950 / KE9952 Point-to-Point Installation

Setting up the KE9950 / KE9952 system in a point-to-point configuration is simply a matter of plugging in the cables.

Note: In a point-to-point configuration, no administrator setup is necessary.

Make sure that all the equipment is powered off. Refer to the installation diagrams on the next two pages and do the following:

1. (Optional) Connect the extender's grounding terminal to a suitable grounded object using the grounding wire.
2. On the transmitter side, plug the mouse, keyboard, DisplayPort monitor, serial devices, microphone and speakers into the ports on the Console section of the KE9950T / KE9952T.
3. Connect the DisplayPort cable, the USB 2.0 Type-A to Type-B cable provided with this package and the audio ports into the KVM Ports on the front of the KE9950T / KE9952T.
4. Connect the other end of the DisplayPort cable and the USB 2.0 Type-A to Type-B and audio cables into the keyboard, video, mouse, speaker and microphone ports on the computer.
5. For control of serial devices, connect the RS-232 port on the front of the transmitter to a serial port on the computer.
6. Connect a Cat 5e/6 cable to the KE9950T / KE9952T's LAN port.
7. On the receiver side, plug the mouse, keyboard, DisplayPort monitor, serial devices, microphone and speakers into the ports on the Console section of the KE9950R / KE9952R.
8. Connect the other end of the Cat 5e/6 cable to the KE9950R / KE9952R's LAN port.
9. Instead of connecting through the LAN ports, you can choose to connect the KE9950 / KE9952 through the SFP slots. To do so, plug SFP modules into the transmitter and receiver's SFP slots, then connect each end of Gigabit Ethernet (GbE) optical fiber between the SFP modules.*
10. Plug the power adapters into AC sources with the power cords and plug the other ends into the transmitter and receiver's power jacks respectively. The KE9952 supports Power over Ethernet (PoE) where power can be supplied through a PoE network switch instead of using a power adapter.

11. (Optional) For power redundancy, plug the second power adapters into AC sources with the power cords and plug the other ends into the transmitter and receiver's second power jacks.**
12. Power on the computer.

Note: 1. The SFP module 2A-136G / 2A-137G is sold separately. Contact your ATEN dealer for product information.

2. Available for KE9950T and KE9950R only. The second power adapter with the power cord is sold separately. Contact your ATEN dealer for product information. Power redundancy for KE9952T and KE9952R can be achieved with the PoE function.

KE9950 / KE9952 Point-to-Point Installation 1 of 2

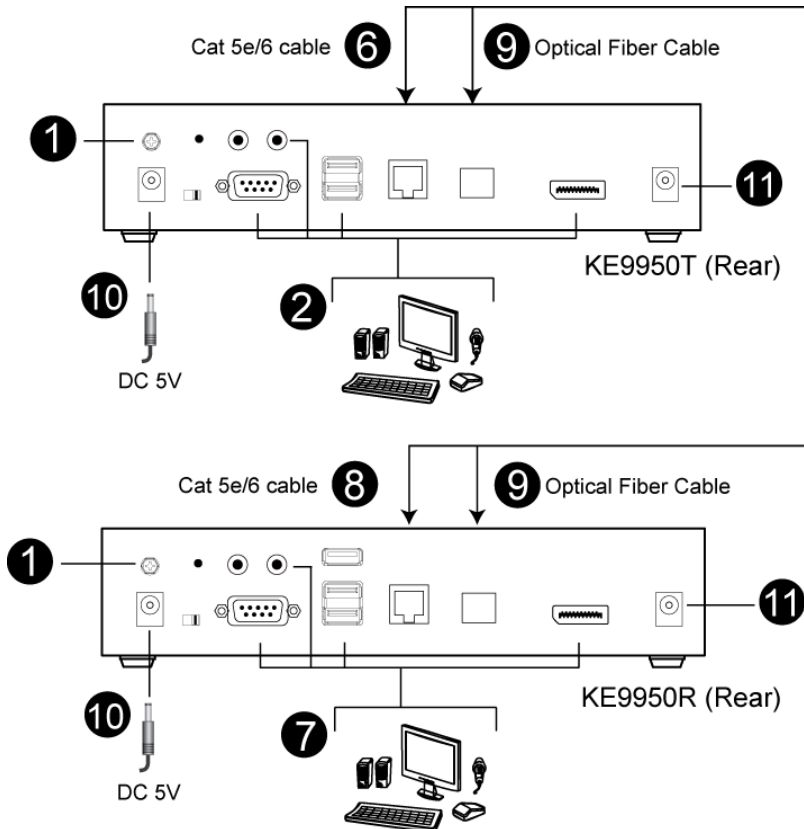

Note: Power adapters are not provided with the KE9952. Please contact your ATEN dealer to purchase additional power adapters, or use the Power over Ethernet (PoE) feature to supply power to the KE9952.

KE9950 / KE9952 Point-to-Point Installation 2 of 2

KE9950T (Front)

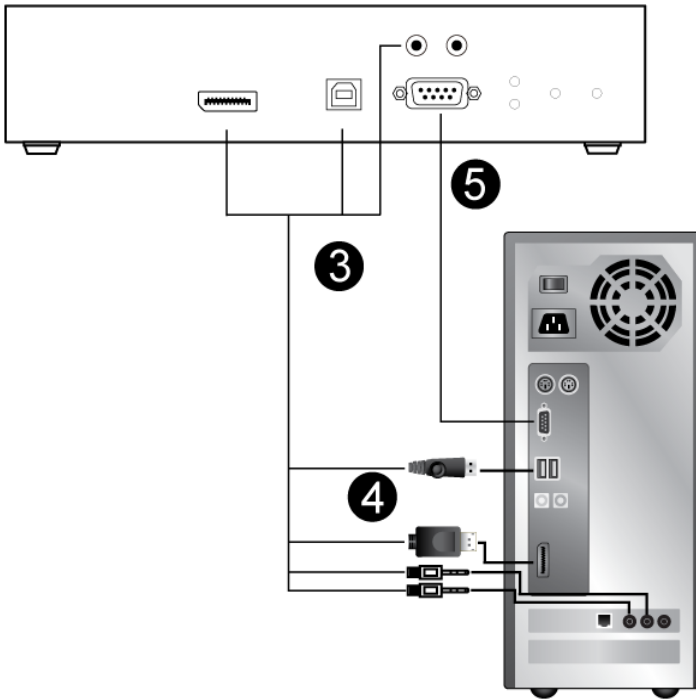

Note: The serial port on the Transmitter (shown above) connects to the computer; the serial port on the Receiver (not shown) connects to a serial device (optional).

KE6900 / KE6940 LAN Installation

Setting up the units on a network allows point-to-point, point-to-multipoint, and multipoint-to-multipoint computer to console operation by connecting multiple KE6900 / KE6900ST / KE6940 devices on the same TCP/IP LAN. Prior to setup we recommended laying out the plans for your KE installation using our performance guide (see *Keys to Network Performance*, page 339).

-
- Note:**
1. The units are preconfigured with factory-default network settings. If you install only one set of KE Series units, you do not need to change these default network settings. See *Default IP Addresses*, page 126, for further details.
 2. In a network setup with multiple units, each Transmitter and Receiver must be configured with a unique IP address. See *Network Configuration*, page 125, for further details.
 3. We recommended using 1000Mbps Gigabit Ethernet switches (wire speeds, non-blocking with 1Gbps/1.5Mpps performance per port) between KE Series devices installed on different LAN segments. 10/100Mbps switches might cause poor performance.
 4. In multipoint configurations, the IGMP and flow control function of your network switches/hubs must be enabled to avoid the deterioration of data throughput. To ensure functionality use a layer 3 switch that supports IGMP queries.
 5. If your network uses cascaded switches, please check to ensure the data throughput is sufficient.
 6. To get the best performance, we suggest creating a private network for KE devices, as they are bandwidth-intensive devices.
-

Make sure that all the equipment is powered off. Refer to the installation diagram on the following page, and do the following:

1. On the Transmitter side, plug the mouse, keyboard, DVI monitor, microphone and speakers into the ports on the Console section of the KE6900T / KE6940T.* Each port is marked with an appropriate icon to indicate itself.
 2. Connect the USB KVM cable provided to the KVM Ports on the front of the KE6900T / KE6940T.
 3. Connect the other end of the USB KVM cable to the keyboard, video, mouse, speaker and microphone ports on the computer.
-

4. For control of serial devices, connect the RS-232 serial port on the Transmitter to a serial port on the computer.
5. Use a Cat 5e/6 cable to connect the KE6900T / KE6940T's LAN port to the local area TCP/IP network.
6. Plug the power adapter into an AC source; and plug the other end into the KE6900T / KE6940T's Power Jack.
7. On the Receiver side, plug the mouse, keyboard, DVI monitor, microphone, and speakers into the ports on the Console section of the KE6900R / KE6940R.**
8. Use a Cat 5e/6 cable to connect the KE6900R / KE6940R's LAN port to the local area TCP/IP network.
9. Plug the second power adapter into an AC source; and plug the other end into the KE6900R / KE6940R's Power Jack.
10. Use the OSD on the Receiver to configure the network settings for both devices (See *Network Configuration*, page 125).
11. Repeat these steps for each Transmitter and Receiver you wish to install on the network.
12. Power on the computer(s).

-
- Note:** 1. If installing the KE6940 with two DVI monitors, connect the second DVI monitor via a DVI cable into the additional ports on the KE6940 and computer.
2. A keyboard or mouse with special functions may need to use the USB ports for advanced features to work (see *USB Mode*, page 203).
-

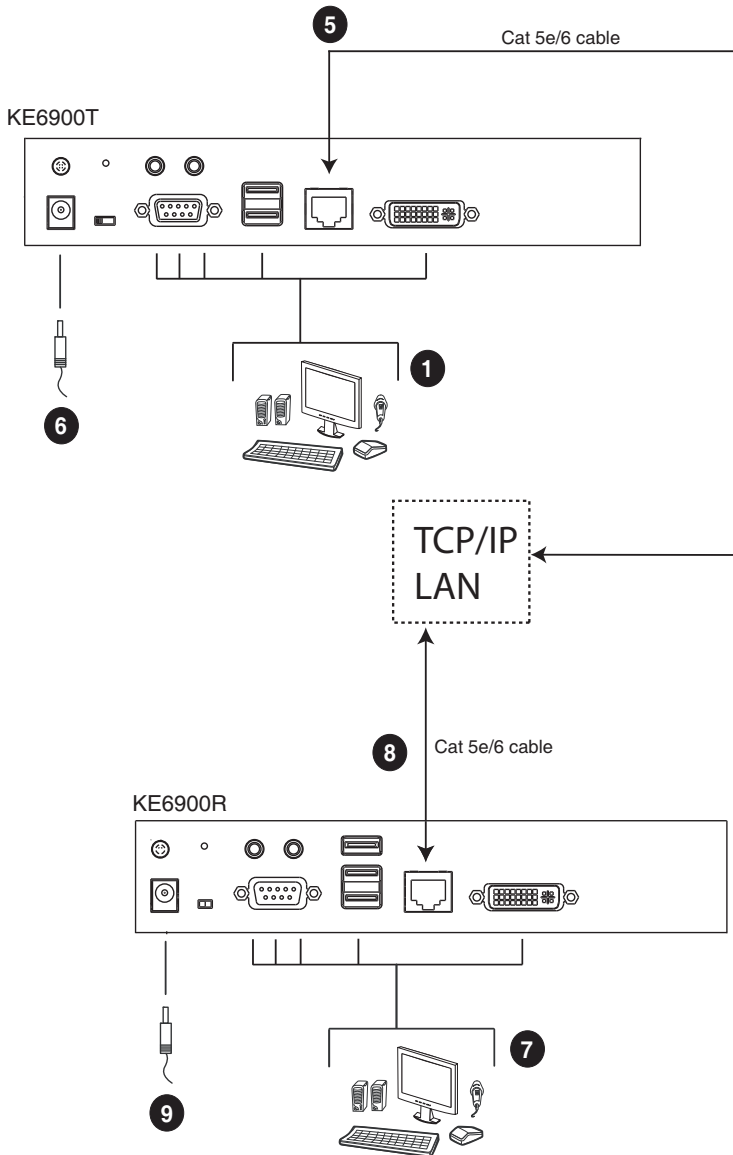
KE6900 / KE6940 Network Installation Diagram 1 of 2

Note: The diagram above shows the KE6900T and KE6900R. The KE6940 installation is the same except that an additional DVI monitor can be connected at each end for a dual-view display setup.

KE6900 / KE6940 Network Installation Diagram 2 of 2

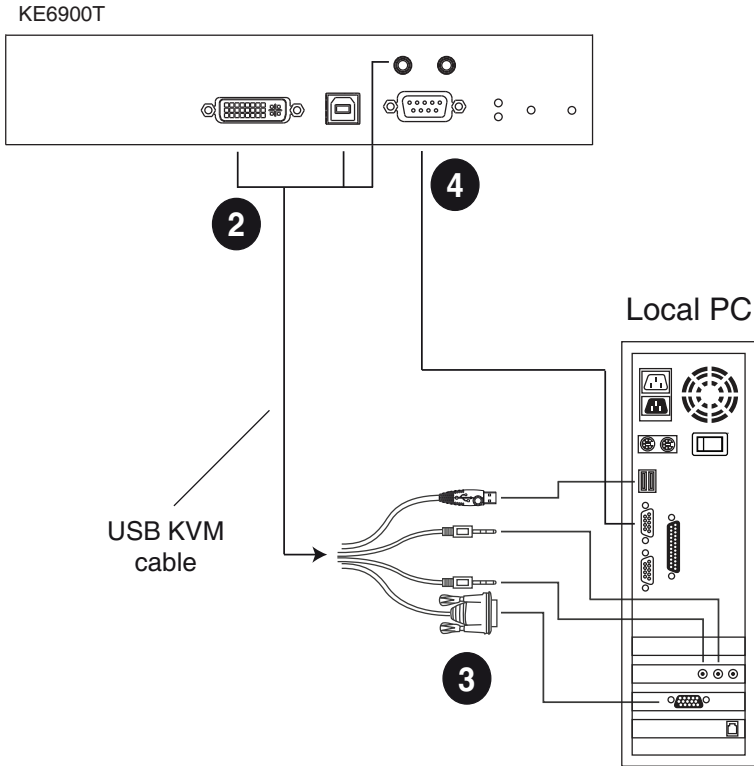

Note: The serial port on the Transmitter (shown above) connects to the computer; the serial port on the Receiver (not shown) connects to a serial device (optional).

KE6900A / KE6940A LAN Installation

Setting up the units on a network allows point-to-point, point-to-multipoint, and multipoint-to-multipoint computer to console operation by connecting multiple extender devices on the same TCP/IP LAN. Prior to setup we recommended laying out the plans for your KE installation using our performance guide (see *Keys to Network Performance*, page 339).

-
- Note:**
1. The units are preconfigured with factory-default network settings. If you install only one set of KE Series units, you do not need to change these default network settings. See *Default IP Addresses*, page 126, for further details.
 2. In a network setup with multiple units, each Transmitter and Receiver must be configured with a unique IP address. See *Network Configuration*, page 125, for further details.
 3. We recommended using 1000Mbps Gigabit Ethernet switches (wire speeds, non-blocking with 1Gbps/1.5Mpps performance per port) between KE Series devices installed on different LAN segments. 10/100Mbps switches might cause poor performance.
 4. In multipoint configurations, the IGMP and flow control function of your network switches/hubs must be enabled to avoid the deterioration of data throughput. To ensure functionality use a layer 3 switch that supports IGMP queries.
 5. If your network uses cascaded switches, please check to ensure the data throughput is sufficient.
 6. To get the best performance, we suggest creating a private network for KE devices, as they are bandwidth-intensive devices.
 7. The unit supports network redundancy. Where both LAN and SFP ports are connected, a network redundancy is established. Please note that if you use copper SFP modules, the module has to be removed for the unit to switch to the LAN port's network.
 8. A keyboard or mouse with special functions may need to use the USB ports for advanced features to work (see *USB Mode*, page 203).
-

Make sure that all the equipment is powered off before the installation.

The installation is similar to that of *KE6900A / KE6940A Point-to-Point Installation* on page 82, with the difference in connecting the transmitter and

the receiver to a local area TCP/IP network. Refer to the diagrams on the following page and connect accordingly.

Repeat these steps for each Transmitter and Receiver you wish to install on the network then power on the computer(s).

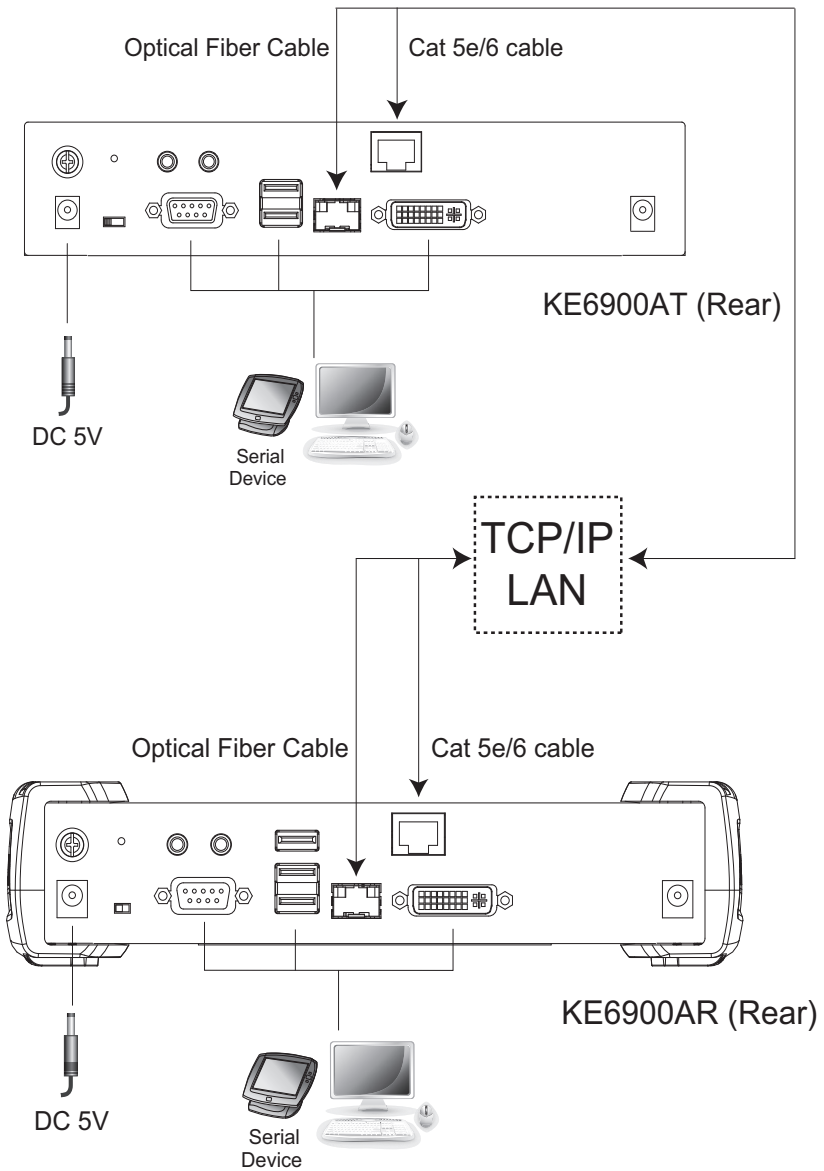
KE6900A / KE6940A Network Installation Diagram 1 of 2

KE6900A / KE6940A Network Installation Diagram 2 of 2

KE6900AT (Front)

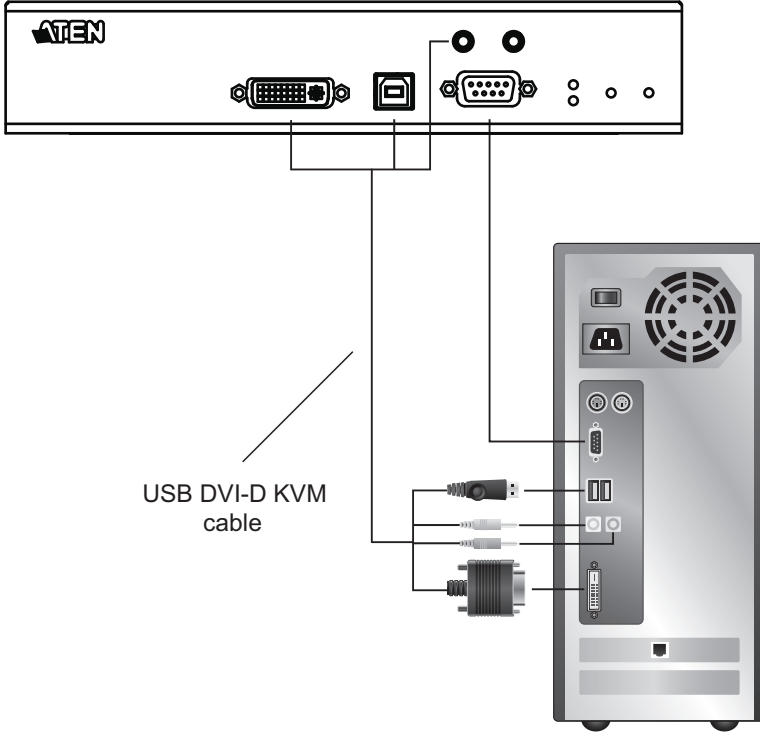

KE6910 / KE6912 LAN Installation

Setting up the units on a network allows point-to-point, point-to-multipoint, and multipoint-to-multipoint computer to console operation by connecting multiple KE6910 / KE6912 devices on the same TCP/IP LAN. Prior to setup we recommended laying out the plans for your KE installation using our performance guide (see *Keys to Network Performance*, page 339).

-
- Note:**
1. The units are preconfigured with factory-default network settings. If you install only one set of KE Series units, you do not need to change these default network settings. See *Default IP Addresses*, page 126, for further details.
 2. In a network setup with multiple units, each Transmitter and Receiver must be configured with a unique IP address. See *Network Configuration*, page 125, for further details.
 3. We recommended using 1000Mbps Gigabit Ethernet switches (wire speeds, non-blocking with 1Gbps/1.5Mpps performance per port) between KE Series devices installed on different LAN segments. 10/100Mbps switches might cause poor performance.
 4. In multipoint configurations, the IGMP and flow control function of your network switches/hubs must be enabled to avoid the deterioration of data throughput. To ensure functionality use a layer 3 switch that supports IGMP queries.
 5. If your network uses cascaded switches, please check to ensure the data throughput is sufficient.
 6. To get the best performance, we suggest creating a private network for KE devices, as they are bandwidth-intensive devices.
-

Make sure that all the equipment is powered off before the installation.

The installation is similar to that of *KE6910 / KE6912 Point-to-Point Installation* on page 85, with the difference in connecting the transmitter and the receiver to a local area TCP/IP network. Refer to the diagrams on the following page and connect accordingly.

Repeat these steps for each Transmitter and Receiver you wish to install on the network then power on the computer(s).

KE6910 / KE6912 Network Installation Diagram 1 of 2

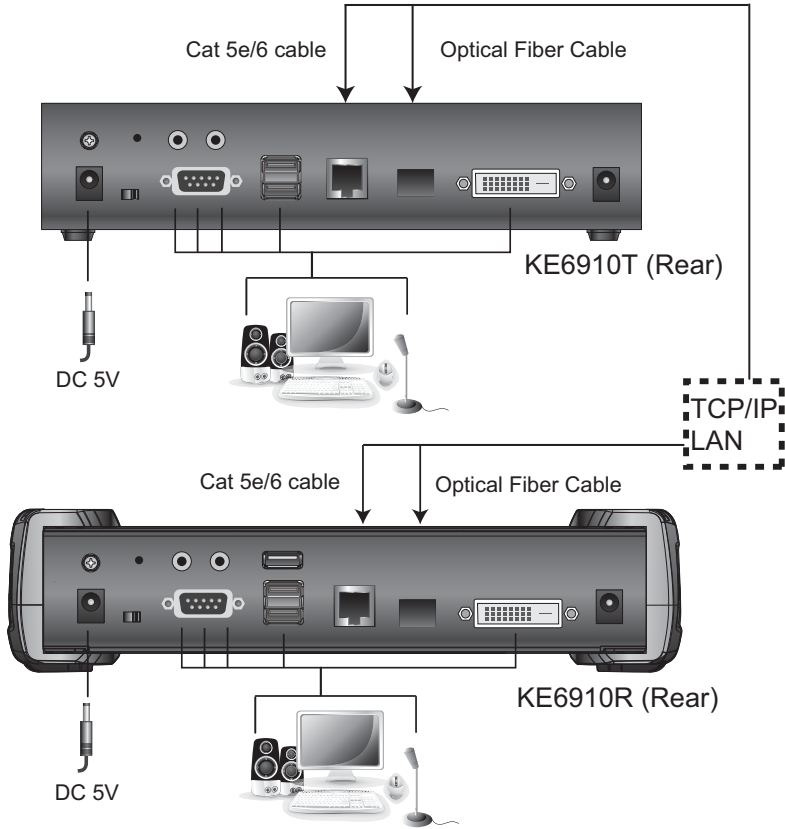

KE6910 / KE6912 Network Installation Diagram 2 of 2

KE6910T (Front)

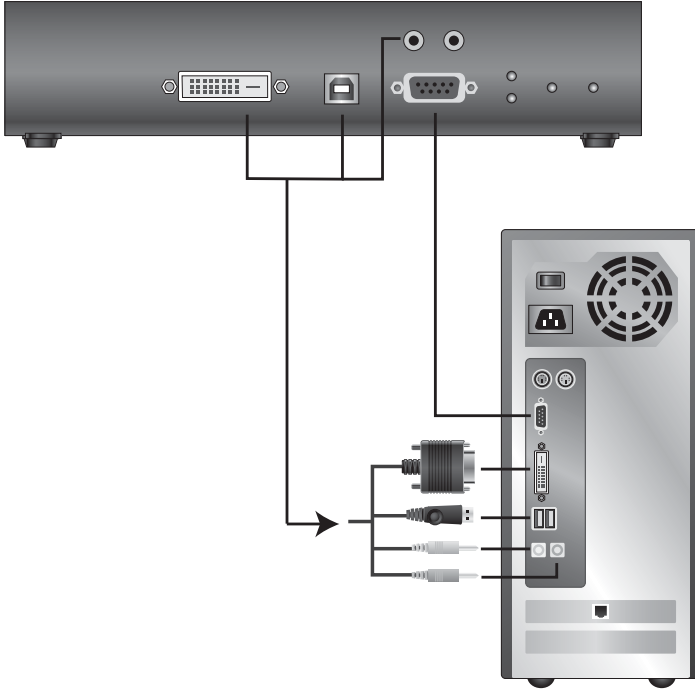

KE6920 / KE6922 LAN Installation

Setting up the units on a network allows point-to-point, point-to-multipoint, and multipoint-to-multipoint computer to console operation by connecting multiple KE6920 / KE6922 devices on the same TCP/IP LAN. Prior to setup we recommended laying out the plans for your KE installation using our performance guide (see *Keys to Network Performance*, page 339).

-
- Note:**
1. The units are preconfigured with factory-default network settings. If you install only one set of KE Series units, you do not need to change these default network settings. See *Default IP Addresses*, page 126, for further details.
 2. In a network setup with multiple units, each Transmitter and Receiver must be configured with a unique IP address. See *Network Configuration*, page 125, for further details.
 3. We recommended using 1000Mbps Gigabit Ethernet switches (wire speeds, non-blocking with 1Gbps/1.5Mpps performance per port) between KE Series devices installed on different LAN segments. 10/100Mbps switches might cause poor performance.
 4. In multipoint configurations, the IGMP and flow control function of your network switches/hubs must be enabled to avoid the deterioration of data throughput. To ensure functionality use a layer 3 switch that supports IGMP queries.
 5. If your network uses cascaded switches, please check to ensure the data throughput is sufficient.
 6. To get the best performance, we suggest creating a private network for KE devices, as they are bandwidth-intensive devices.
-

Make sure that all the equipment is powered off before the installation.

The installation is similar to that of *KE6920 / KE6922 Point-to-Point Installation* on page 88, with the difference in connecting the transmitter and the receiver to a local area TCP/IP network. Refer to the diagrams on the following page and connect accordingly.

Repeat these steps for each Transmitter and Receiver you wish to install on the network then power on the computer(s).

-
- Note:**
1. The unit supports network redundancy. Where both LAN and SFP ports are connected, a network redundancy is established. Please note
-

that if you use copper SFP modules, the module has to be removed for the unit to switch to the LAN port's network.

2. The KE6922's LAN port provides Power over Ethernet (PoE) functionality which supplies power to the unit when connected to a compatible PoE network switch.
 3. Power adapters are not provided with KE6922 units. Please contact your ATEN dealer to purchase additional power adapters, or use the Power over Ethernet (PoE) feature to supply power to KE6922 units.
 4. A keyboard or mouse with special functions may need to use the USB ports for advanced features to work (see *USB Mode*, page 203).
-

KE6920 / KE6922 Network Installation Diagram 1 of 2

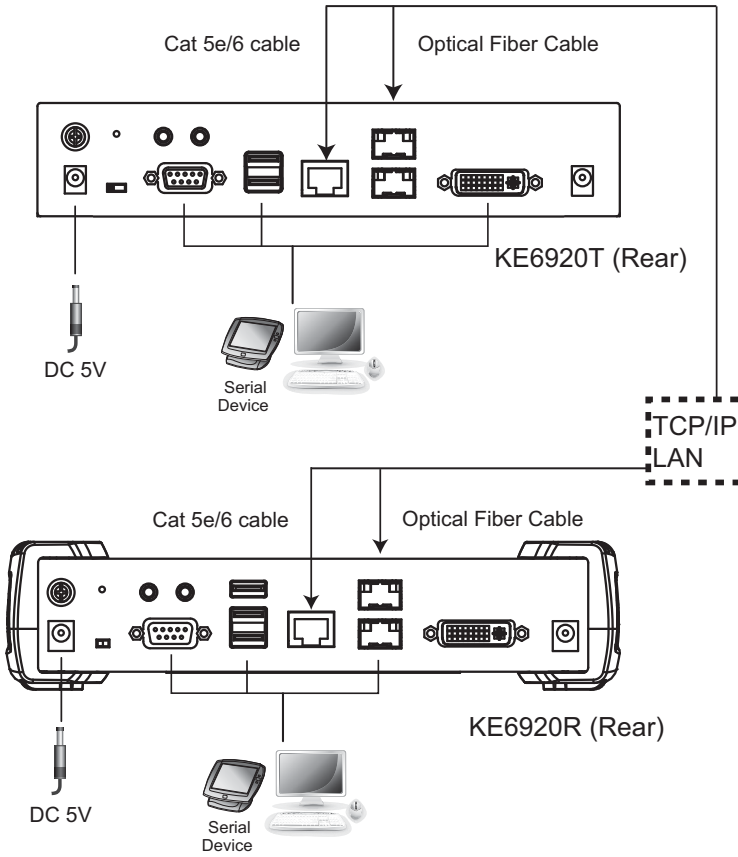

KE6920 / KE6922 Network Installation Diagram 2 of 2

KE6920T (Front)

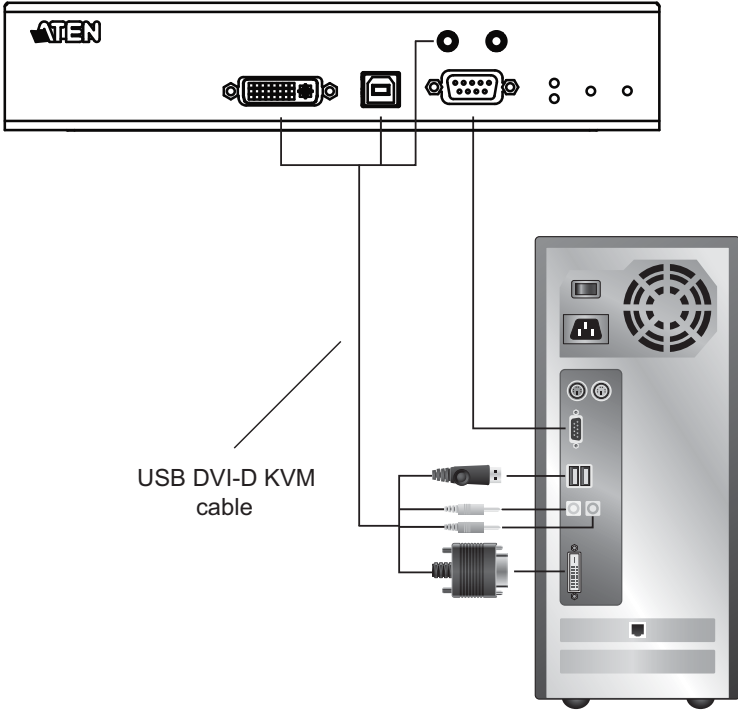

KE8950 / KE8952 LAN Installation

Setting up the units on a network allows point-to-point, point-to-multipoint, and multipoint-to-multipoint computer to console operation by connecting multiple KE8950 / KE8952 devices on the same TCP/IP LAN. Prior to setup we recommended laying out the plans for your KE installation using our performance guide (see *Keys to Network Performance*, page 339).

-
- Note:**
1. The units are preconfigured with factory-default network settings. If you install only one set of KE Series units, you do not need to change these default network settings. See *Default IP Addresses*, page 126, for further details.
 2. In a network setup with multiple units, each Transmitter and Receiver must be configured with a unique IP address. See *Network Configuration*, page 125, for further details.
 3. We recommended using 1000Mbps Gigabit Ethernet switches (wire speeds, non-blocking with 1Gbps/1.5Mpps performance per port) between KE Series devices installed on different LAN segments. 10/100Mbps switches might cause poor performance.
 4. In multipoint configurations, the IGMP and flow control function of your network switches/hubs must be enabled to avoid the deterioration of data throughput. To ensure functionality use a layer 3 switch that supports IGMP queries.
 5. If your network uses cascaded switches, please check to ensure the data throughput is sufficient.
 6. To get the best performance, we suggest creating a private network for KE devices, as they are bandwidth-intensive devices.
-

Make sure that all the equipment is powered off. Refer to the installation diagram on the following page, and do the following:

1. On the Transmitter side, plug the mouse, keyboard, HDMI monitor, microphone and speakers into the ports on the Console section of the KE8950T / KE8952T. Each port is marked with an appropriate icon to indicate itself.
2. Connect the USB KVM cable provided to the KVM Ports on the front of the KE8950T / KE8952T.
3. Connect the other end of the USB KVM cable to the keyboard, video, mouse, speaker and microphone ports on the computer.

4. For control of serial devices, connect the RS-232 serial port on the Transmitter to a serial port on the computer.
5. Connect a Cat 5e/6 cable to the LAN port, or a Gigabit Ethernet (GbE) optical fiber cable to the SFP port* to connect the KE8950T / KE8952T to the local area TCP/IP network.**
6. Plug the power adapter into an AC source; and plug the other end into the KE8950T / KE8952T's Power Jack.***
7. On the Receiver side, plug the mouse, keyboard, HDMI monitor, microphone, and speakers into the ports on the Console section of the KE8950R / KE8952R.****
8. Connect a Cat 5e/6 cable to the LAN port, or a Gigabit Ethernet (GbE) optical fiber cable to the SFP port* to connect the KE8950R / KE8952R to the local area TCP/IP network.**
9. Plug the power adapter into an AC source; and plug the other end into the KE8950R / KE8952R's Power Jack.***
10. Use the OSD on the Receiver to configure the network settings for both devices (See *Network Configuration*, page 125).
11. Repeat these steps for each Transmitter and Receiver you wish to install on the network.
12. Power on the computer(s).

-
- Note:**
1. The unit supports network redundancy. Where both LAN and SFP ports are connected, a network redundancy is established. Please note, though, that if you use copper SFP modules, the module has to be removed for the unit to switch to the LAN port's network.
 2. The KE8952's LAN port provides Power over Ethernet (PoE) functionality which supplies power to the unit when connected to a compatible PoE network switch.
 3. Power adapters are not provided with KE8952 units. Please contact your ATEN dealer to purchase additional power adapters, or use the Power over Ethernet (PoE) feature to supply power to KE8952 units.
 4. A keyboard or mouse with special functions may need to use the USB ports for advanced features to work (see *USB Mode*, page 203).
-

KE8950 / KE8952 Network Installation Diagram 1 of 2

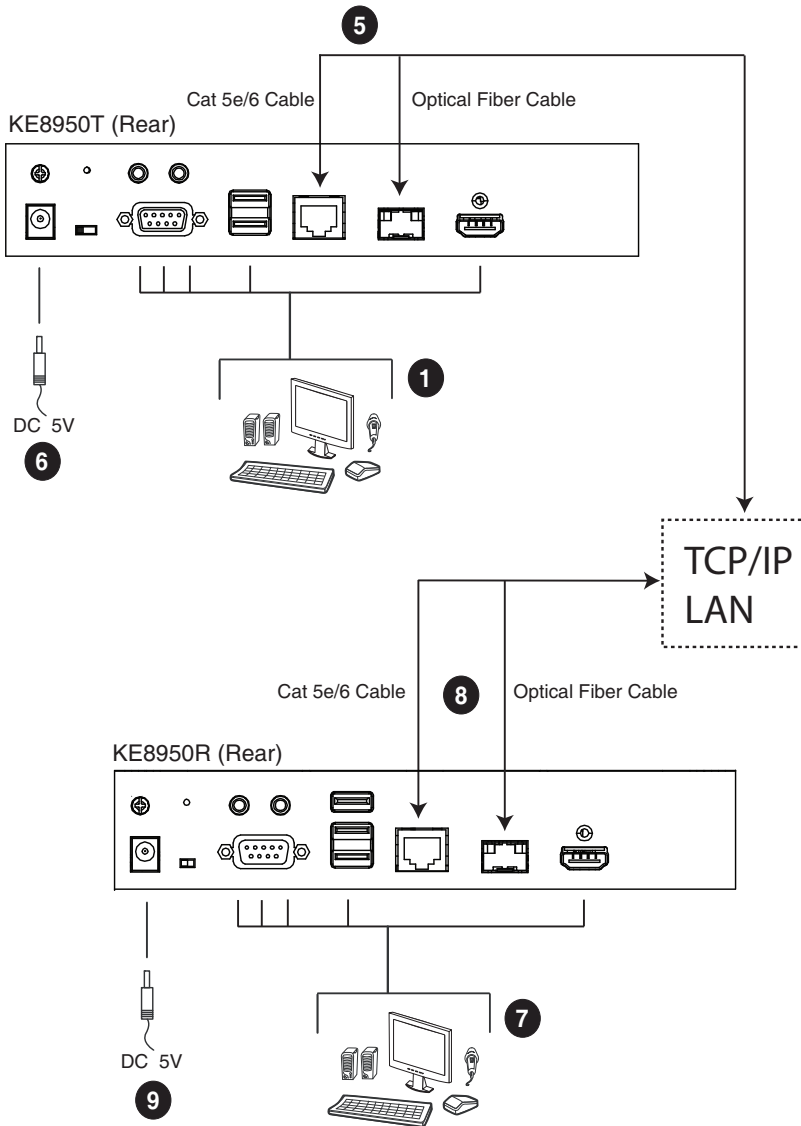

Note: Power adapters are not provided with KE8952 units. Please contact your ATEN dealer to purchase additional power adapters, or use the Power over Ethernet (PoE) feature to supply power to KE8952 units.

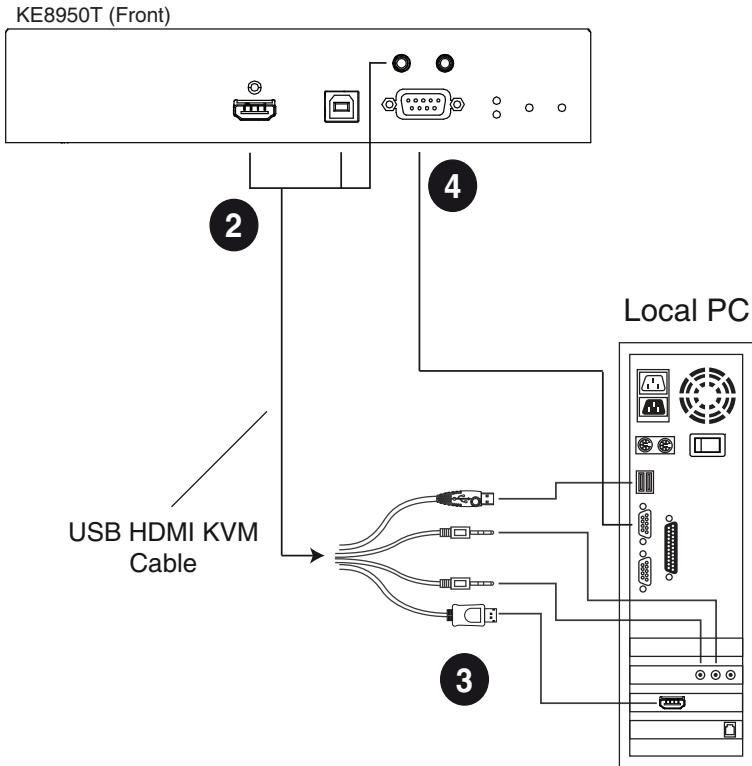
KE8950 / KE8952 Network Installation Diagram 2 of 2

Note: The serial port on the Transmitter (shown above) connects to the computer; the serial port on the Receiver (not shown) connects to a serial device (optional).

KE9950 / KE9952 LAN Installation

Setting up the units on a network allows point-to-point, point-to-multipoint, and multipoint-to-multipoint computer to console operation by connecting multiple KE9950 / KE9952 devices on the same TCP/IP LAN. Prior to setup we recommended laying out the plans for your KE installation using our performance guide (see *Keys to Network Performance*, page 339).

-
- Note:**
1. The units are preconfigured with factory-default network settings. If you install only one set of KE Series units, you do not need to change these default network settings. See *Default IP Addresses*, page 126, for further details.
 2. In a network setup with multiple units, each Transmitter and Receiver must be configured with a unique IP address. See *Network Configuration*, page 125, for further details.
 3. We recommended using 1000Mbps Gigabit Ethernet switches (wire speeds, non-blocking with 1Gbps/1.5Mpps performance per port) between KE Series devices installed on different LAN segments. 10/100Mbps switches might cause poor performance.
 4. In multipoint configurations, the IGMP and flow control function of your network switches/hubs must be enabled to avoid the deterioration of data throughput. To ensure functionality use a layer 3 switch that supports IGMP queries.
 5. If your network uses cascaded switches, please check to ensure the data throughput is sufficient.
 6. To get the best performance, we suggest creating a private network for KE devices, as they are bandwidth-intensive devices.
-

Make sure that all the equipment is powered off.

The installation is similar to that of *KE6900 / KE6940 Point-to-Point Installation* on page 79, with the difference in connecting the transmitter and the receiver to a local area TCP/IP network. Refer to the diagrams on the following page and connect accordingly.

Repeat these steps for each Transmitter and Receiver you wish to install on the network then power on the computer(s).

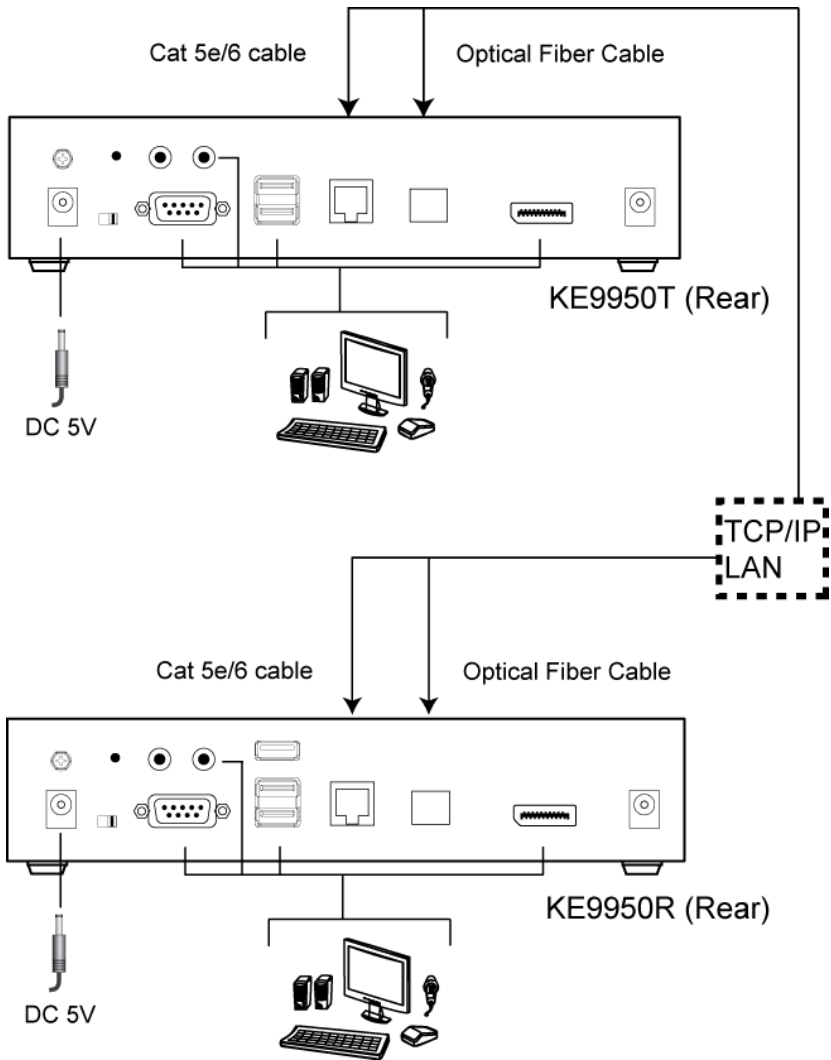
KE9950 / KE9952 Network Installation Diagram 1 of 2

KE9950 / KE9952 Network Installation Diagram 2 of 2

KE9950T (Front)

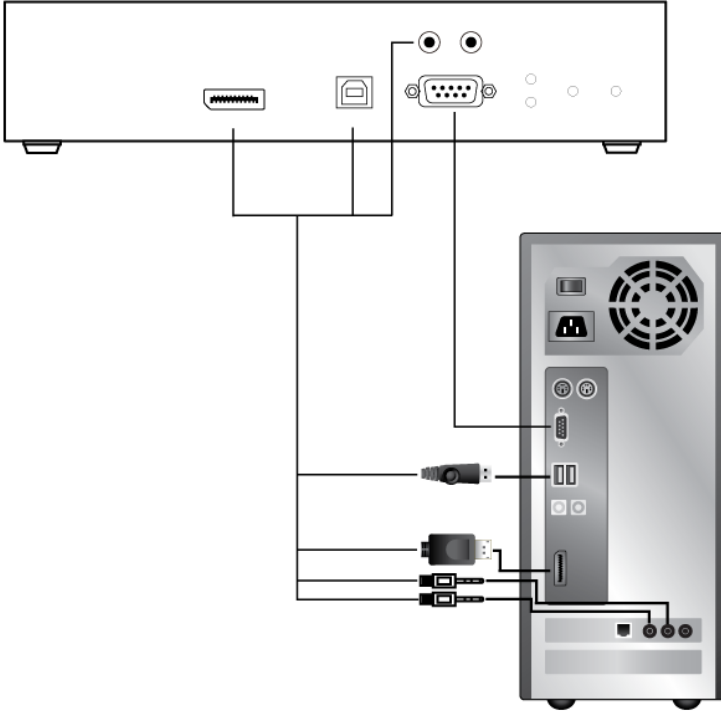

Network Configuration

This section provides instructions to configure the network settings with a fixed IP address, subnet mask, and default gateway. To use the **IP Installer** to configure the IP address, see *IP Installer*, page 326.

-
- Note:**
1. Both devices are preconfigured with factory-default network settings. If you install only one set of KE Series units, you do not need to change these default network settings. See *Default IP Addresses*, page 126, for further details.
 2. In a network setup with multiple units, each transmitter and receiver must be configured with a unique IP address. See *Network Configuration*, page 125, for further details.
 3. We recommended using 1000Mbps Gigabit Ethernet switches (wire speeds, non-blocking with 1Gbps/1.5Mpps performance per port) between devices installed on different LAN segments. 10/100Mbps switches might cause poor performance.
 4. In multipoint configurations, the IGMP and flow control function of your network switches/hubs must be enabled to avoid the deterioration of data throughput. To ensure functionality use a layer 3 switch that supports IGMP queries.
 5. If your network uses cascaded switches, please check to ensure the data throughput is sufficient.
 6. To get the best performance, we suggest creating a private network for KE device, as they are bandwidth-intensive devices.
-

To configure the network settings, do the following:

1. Setup the hardware and connect the Transmitter and Receiver to the local area network (see *KE6900 / KE6940 LAN Installation*, page 103, or *KE8950 / KE8952 LAN Installation*, page 118).
2. From the Receiver, tap the **Scroll Lock** key twice to invoke the OSD.
3. Select the *Receiver* or *Transmitter* from the sidebar menu.
4. Enter the password and click **Configure**.
The default password is: password.
5. From the *Network* tab select **Set IP address manually** and enter the following:

- ♦ *IP Address*– sets the IP address for the KE device. Key in a valid unique IP address.

Note: See *Default IP Addresses*, page 126, for the preconfigured factory-default settings.

- ♦ *Subnet Mask* – sets the subnet mask for the KE device. Key in a valid subnet mask value.

Note: The default setting is 255.255.255.0

- ♦ *Default Gateway*– sets the default gateway for the KE device. Key in a valid default gateway.

6. Click **Save**.

Exit OSD

To exit the OSD, press **[Esc]** on the keyboard, click **Logout**; tap the **Scroll Lock** key twice; or return to the OSD main page and press the front panel OSD pushbutton (Receiver only).

At this point the Receiver can connect to the Transmitter to access the remote computer (see *Connecting*, page 146 for instructions).

Default IP Addresses

The preconfigured factory-default IP addresses for the KE Series devices are as follows:

Transmitters – 192 . 168 . 0 . 61

Receivers – 192 . 168 . 0 . 60

KE I/O Ports

The following table provides the I/O port use of KE Series devices.

Device	Port	Number
KE Matrix Manager (TCP)	HTTP	8080
	HTTPS	8443
	Device TCP	9110
	CLI	9111
	Redundancy	9120
	Database Service	1527
KE Matrix Manager (UDP)	Port	9110
	Broadcast	9000
KE TX/RX Device (TCP)	Manager	9110
	Service	9000
	Telnet	23
	SSH	22
KE TX Device (TCP)	VM	9001
	vUSB	9002
	Serial	9003
	USB Access Mode	9009
KE RX Device (TCP)	CLI	9130
KE TX/RX Device (UDP)	Manager	9110
	Service	9000
	Array Mode	9120
	Video	0xFE00(65024) - 0xFE03(65027)
	Audio	0xFE04(65028) - 0xFE05(65029)

LED Display

Both the Transmitter and Receiver have front panel LEDs to indicate their operating and power status, as explained in the table below:

LED	Indication
LAN	<p>This LED indicates the network status.</p> <ul style="list-style-type: none">◆ Lights when connected to the LAN and blinks when the Ethernet connection is active:<ul style="list-style-type: none">◆ Orange: 10 Mbps◆ Orange + Green: 100 Mbps◆ Green: 1000 Mbps◆ Off when not connected to the LAN.
Power	<ul style="list-style-type: none">◆ Lights blue when the unit is powered on.◆ OFF when power is off.
Local	<ul style="list-style-type: none">◆ Lights green to Indicate the Transmitter has KVM focus of the computer
Remote	<ul style="list-style-type: none">◆ Lights green to Indicate the Receiver has KVM focus of the computer.

Authentication Lock (KE6910 / KE6912 only)

The KE6910/KE6912 extenders feature the Authentication Lock function. When accidental power cut happens, the function allows the user to retain his/her settings as was shown before the power cut. The user keeps the same authentication and display.

This function can be configured in *General* on page 225.

Chapter 3

OSD Operation

Overview

This chapter provides instructions to configure and operate KE Series devices using the local On Screen Display (OSD). To configure the network settings with the OSD, see *Network Configuration*, page 125.

Invoking the OSD

The On Screen Display (OSD) is a keyboard/mouse-driven application on the receiver used to configure the transmitter and receiver settings. Once the receiver has discovered the transmitter over a network* or Ethernet cable connection, you can use the OSD on the receiver to configure the transmitter.

To invoke the OSD, press the OSD pushbutton on the front of the receiver, or from the keyboard tap the **Scroll Lock** key twice. The *OSD* main page will appear (see , page 130).

To exit the OSD, press **[Esc]** on the keyboard; click **Logout**; tap the **Scroll Lock** key twice; or return to the OSD main page and press the OSD pushbutton on the front of the receiver. The OSD disappears and the computer desktop screen or the System Login prompt is displayed.

-
- Note:**
1. For the Receiver to discover the Transmitter over a network, both must be on the same subnet of the LAN.
 2. To change the OSD hotkeys, see page 145.
 3. If the keyboard/mouse won't work when the OSD is invoked, see *USB Mode*, page 203.
-

Touch Screen Calibration

If you're using a touch screen monitor and the OSD appears off center, you can use the blinking **+** at each corner to adjust the position of the OSD.

OSD Hotkeys

The OSD hotkeys navigate the Receiver's OSD screens. The hotkeys work after logging in from the *System Login* screen (see page 146) but not the *OSD Configuration* screen. Pressing a hotkey will immediately take you to the corresponding OSD screen.

Hotkey	OSD Screen	Page
[F1]	Connections Page 1 in List Mode	148
[F2]	Connections Page 1 in Array Mode	151
[F3]	Profile Page 1	153
[F5]	Push Content Page 1	154
[F6]	Pull Content Page 1	156
[F7]	Receiver > Properties	133
[F8]	User Preferences	145
[F9]	OSD Login Screen (logs user off)	146

Microphone Hotkey

You can switch microphone access between Receivers with a hotkey:

1. Press and hold down [**Num Lock**].
2. Press and release [-].
3. Release [**Num Lock**].
4. Press **1**.

Press the **Esc** key to cancel.

OSD Interface

After you invoke the OSD, the main page appears:



Note: A password is required to enter the OSD. The default password is: *password*. For security purposes, we recommend you change this to something unique.

The OSD components are described in the table below:

No.	Item	Description
1	Receiver	Select this radio button, enter a password, and click Configure to enter the <i>Receiver Configuration</i> screen.
2	Transmitter	Select this radio button, enter a password, and click Configure to enter the <i>Transmitter Configuration</i> screen. Note: Receiver must first discover the transmitter over the network for this option to be available.
3	User Preferences	Select this radio button, enter a password, and click Configure to enter the <i>User Preferences</i> screen.
4	About	About provides information regarding the OSD version.
5	Password	Input the OSD password and click Configure to enter the selected configuration screen. See note for password.
6	Configure	After entering a password, click Configure to enter the selected configuration screen.
7	Back to Connection	Clicking this button exits the OSD and returns you to the computer's video display.

Receiver Configuration

When you select the *Receiver* radio button and click **Configure** to login, the Network tab appears:

The screenshot shows the 'Receiver Configuration' window. On the left is a sidebar with 'Receiver' selected, and options for 'Transmitter', 'User Preferences', 'About', and 'Logout'. Below the sidebar is a 'Password' field and a 'Configure' button. The main area has tabs for 'Network', 'Properties', and 'System'. Under 'Network', there are radio buttons for 'IP Installer' (Enable, View Only, Disabled). Below that is the 'Network Configuration' section with radio buttons for 'Obtain IP address automatically' and 'Set IP address manually'. The 'Set IP address manually' option is selected, and there are input fields for 'IP Address' (192.168.0.71), 'Subnet Mask' (255.255.255.0), and 'Default Gateway' (192.168.0.254). A 'Save' button is at the bottom right.

Network

The Network tab allows you to configure the Receiver's IP address settings:

Item	Description
IP Installer	The IP Installer is an external Windows-based utility for assigning an IP address to the device. Click one of the radio buttons to select Enable , View Only , or Disable for the IP Installer utility. See <i>IP Installer</i> , page 326 for instructions. Note: For security, we strongly recommend that you set this to <i>View Only</i> or <i>Disable</i> after each use.
Network Configuration	For dynamic IP address assignment (DHCP), select the Obtain IP address automatically radio button. To specify a fixed <i>IP Address</i> , <i>Subnet Mask</i> , and <i>Default Gateway</i> select the Set IP address manually radio button and fill in the fields with values appropriate for your network. For help configuring network settings with the OSD, see <i>Network Configuration</i> , page 125.

After entering the information, click **Save**.

Properties

There are two versions of Properties for KE Series, a Regular Version, and a Slim Version.

Note: KE8900ST, KE8900SR, and KE9900ST are Slim Version.

Regular Version

The *Properties* tab allows you to configure the Receiver's settings:

The screenshot shows the 'Properties' tab of the Receiver's OSD. It features several configuration sections:

- Mode:** Radio buttons for 'Extender' and 'Matrix' (selected).
- RS232 Settings:** Dropdown menus for Baud Rate (9600), Data Bits (8), Parity (None), Stop Bits (1), and Flow Control (None).
- Manager Address:** Text boxes for Manager IP (192.168.0.12) and Manager Port (9110).
- Beeper:** A checked checkbox for 'Enable'.
- Touch Screen Calibration:** A 'Calibrate' button.
- Disable front video button:** A checked checkbox for 'Disabled'.
- Properties:** Text boxes for Transmitter Video IP, Audio IP, USB IP, and RS232 IP, all set to 10.3.170.214. A group box 'Enable Media' contains checked checkboxes for Video, Audio, USB, and RS232.
- USB Mode:** Radio buttons for 'Virtual Media' (selected), 'Enable', and 'Genetic USB device'.
- User Station Keyboard:** A dropdown menu for 'Keyboard Country Code' set to 'English (US)'.

A 'Save' button is located at the bottom right of the interface.

Item	Description
Mode	<p>Select Extender mode for simple one-to-one (Transmitter to Receiver) setups that are managed with the Receiver's OSD menu.</p> <p>Select Matrix mode to manage devices and connections from the KE Matrix Manager web GUI. This mode is for advanced administration of Transmitter to Receiver connections (see <i>Browser / Telnet Operation</i>, page 169).</p>
Properties	<p>If you selected Extender mode (above) set the Transmitter IP address for the Receiver's Video, Audio, USB, and RS232 source signals.</p> <p>If you selected Matrix mode (above) the <i>Properties</i> will be grayed out. Use Channels to configure the Transmitter connections (see <i>Browser / Telnet Operation</i>, page 169).</p>

Item	Description
RS232 Settings	Configure the serial device settings for the Receiver. The default settings are: Baud Rate: 9600 Parity: None Data Bits: 8 bits Stop bits: 1 bit Flow Control: None
Enable Media	Select which type of media the Receiver can stream from Transmitters: Video, Audio, USB, and RS232. For KE8950 Series models, use the radio button to set the source of the audio signal: HDMI, Analog, or Both.
Manager Address	Set the IP address and Port number of the computer running the KE Matrix Manager software. The default port number is 9110.
Beeper	Check this box to allow the Receiver to beep when configuration changes are made to it.
Touch Screen Calibration	Use this button to calibrate the surface of a USB touch screen connected to the unit. When the calibration screen appears, touch the flashing + symbol at each corner until the process is complete.

Item	Description
USB Mode	<p>Select the type of USB device you will connect to the USB ports:</p> <p>Virtual Media: Only select this option if you are plugging a USB disk into the USB ports. This will give you the highest data transfer speeds but will not allow other USB devices plugged into the USB ports to work. When Receivers connected to the same transmitter mount or unmount USB disk drives, the keyboard and mouse operations will experience a brief delay. Transmitters can support up to 12 virtual media connections at the same time (keyboard/mouse included).</p> <p>vUSB (Generic USB device): Use this option to plug USB peripherals* into the USB ports. This option also allows a keyboard and mouse with special functions to plug into the USB ports for console use. Use this only if the special functions of the keyboard or mouse are required but do not work when plugged into the console ports. When the keyboard and mouse are plugged into the USB ports, they will not work within the OSD menus. To work within the OSD menus, the keyboard and mouse must be plugged into the console ports. KE6900ST/KE8900ST/KE9900ST transmitters do not support vUSB (Generic USB Device) mode. In this mode, KE6900/KE6940 transmitters supports up to 2 USB connections, KE8950/KE8952 transmitters support up to 5 USB connections (keyboard/mouse excluded), and KE8900SR supports 1 vUSB connection.</p> <p>Encryption: Check this box to encrypt USB drives plugged into the USB ports.</p> <p>Note: This USB port does not support isochronous endpoints, therefore USB peripherals that stream audio or video data, such as speakers or webcams, will not work.</p>
Receiver Keyboard	Use the Keyboard Country Code drop-down menu to select the Receiver's language keyboard for use in the OSD.
Disable front video button (KE6910 / 6912 only)	<p>You can enable or disable the function (select video mode or graphic mode) of the video pushbutton on the front of the receiver.</p> <p>Check Disable to disable (checked by default). Uncheck Disable to enable.</p>

After entering the information, click **Save**.

Slim Version

The *Properties* tab allows you to configure the Receiver's settings:

Item	Description
Mode	<p>Select Extender mode for simple one-to-one (Transmitter to Receiver) setups that are managed with the Receiver's OSD menu.</p> <p>Select Matrix mode to manage devices and connections from the KE Matrix Manager web GUI. This mode is for advanced administration of Transmitter to Receiver connections (see <i>Browser / Telnet Operation</i>, page 169).</p>
Properties	<p>If you selected Extender mode (above) set the Transmitter IP address for the Receiver's Video, Audio, USB, and RS232 source signals.</p> <p>If you selected Matrix mode (above) the <i>Properties</i> will be grayed out. Use Channels to configure the Transmitter connections (see <i>Browser / Telnet Operation</i>, page 169).</p>
RS232 Settings	<p>Configure the serial device settings for the Receiver. The default settings are:</p> <p>Baud Rate: 9600</p> <p>Parity: None</p> <p>Data Bits: 8 bits</p> <p>Stop bits: 1 bit</p> <p>Flow Control: None</p>

Item	Description
Enable Media	Select which type of media the Receiver can stream from Transmitters: Video, Audio, USB, and RS232. For KE8950 Series models, use the radio button to set the source of the audio signal: HDMI, Analog, or Both.
Manager Address	Set the IP address and Port number of the computer running the KE Matrix Manager software. The default port number is 9110.
Beeper	Check this box to allow the Receiver to beep when configuration changes are made to it.
Touch Screen Calibration	Use this button to calibrate the surface of a USB touch screen connected to the unit. When the calibration screen appears, touch the flashing + symbol at each corner until the process is complete.
USB Mode	<p>Select the type of USB device you will connect to the USB ports:</p> <p>Virtual Media: Only select this option if you are plugging a USB disk into the USB ports. This will give you the highest data transfer speeds but will not allow other USB devices plugged into the USB ports to work. When Receivers connected to the same transmitter mount or unmount USB disk drives, the keyboard and mouse operations will experience a brief delay. Transmitters can support up to 12 virtual media connections at the same time (keyboard/mouse included).</p> <p>vUSB (Generic USB device): Use this option to plug USB peripherals* into the USB ports. This option also allows a keyboard and mouse with special functions to plug into the USB ports for console use. Use this only if the special functions of the keyboard or mouse are required but do not work when plugged into the console ports. When the keyboard and mouse are plugged into the USB ports, they will not work within the OSD menus. To work within the OSD menus, the keyboard and mouse must be plugged into the console ports. KE6900ST/KE8900ST/KE9900ST transmitters do not support vUSB (Generic USB Device) mode. In this mode, KE6900/KE6940 transmitters supports up to 2 USB connections; and KE8950/KE8952 transmitters support up to 5 USB connections (keyboard/mouse excluded).</p> <p>Encryption: Check this box to encrypt USB drives plugged into the USB ports.</p> <p>Note: This USB port does not support isochronous endpoints, therefore USB peripherals that stream audio or video data, such as speakers or webcams, will not work.</p>
Receiver Keyboard	Use the Keyboard Country Code drop-down menu to select the Receiver's language keyboard for use in the OSD.

Item	Description
Video Quality (KE8900ST / 8900SR / 9900ST)	You can select video mode or graphic mode for the video quality, the Slim Version KE Series does not have a physical pushbutton on the front of the receiver.

After entering the information, click **Save**.

System

The *System* tab allows you to configure the Receiver's general settings:

The screenshot shows the 'System' configuration page. At the top, there are three tabs: 'Network', 'Properties', and 'System', with 'System' being the active tab. Below the tabs is the 'Device Information' section, which contains several fields: 'Name' (KE694DR), 'Description' (empty), 'IP Address' (192.168.0.60), 'MAC Address' (00:10:74:a8:01:37), 'F/W Version' (V1.1.106 (May 2 2014 13:39:47)), and 'Serial Number' (empty). Below this is the 'Reboot' section, which has a checkbox for 'Reset to factory default' and a 'Reboot' button. The 'User Station Password Change' section has a checked 'Enable' checkbox and three password input fields labeled 'Old Password', 'New Password', and 'Confirm Password'. A 'Save' button is located at the bottom right of the form.

Item	Description
Device Information	Enter the Name , and Description of the Receiver. It also displays the <i>IP Address</i> , <i>MAC Address</i> , <i>F/W Version</i> , and <i>Serial Number</i> of the Receiver.
Reboot	Check the box and click Reboot to reset the Receiver's settings back to the factory default. All custom settings (but not the login information) will be lost.
Receiver Password Change	Check Enable to require a password for access to the Receiver's OSD configuration screen. Enter the Old Password, enter a New Password, and confirm the new password in the Confirm Password box.

After entering the information, click **Save**.

Transmitter Configuration

When you select the *Transmitter* radio button and click **Configure** to login, the Network tab appears:

Network

The *Network* tab allows you to configure the Transmitter's IP address settings:

Item	Description
IP Installer	<p>The IP Installer is an external Windows-based utility for assigning an IP address to the device. Click one of the radio buttons to select Enable, View Only, or Disable for the IP Installer utility. See <i>IP Installer</i>, page 326 for instructions.</p> <p>Note: For security, we strongly recommend that you set this to <i>View Only</i> or <i>Disable</i> after each use.</p>
Network Configuration	<p>For dynamic IP address assignment (DHCP), select the Obtain IP address automatically radio button.</p> <p>To specify a fixed <i>IP Address</i>, <i>Subnet Mask</i>, and <i>Default Gateway</i> select the Set IP address manually radio button and fill in the fields with values appropriate for your network.</p> <p>For help configuring network settings with the OSD, see <i>Network Configuration</i>, page 125.</p>

After entering the information, click **Save**.

Properties

The *Properties* tab allows you to configure the Transmitter's extender settings:

The screenshot shows the 'Properties' tab of a configuration interface. It features several sections:

- Mode:** Radio buttons for 'Extender' (selected) and 'Matrix'.
- RS232 Settings:** A group of dropdown menus for Baud Rate (9600), Data Bits (8), Parity (None), Stop Bits (1), and Flow Control (None).
- Manager Address:** Input fields for 'KE Manager IP' and 'KE Manager Port' (9110).
- Transmitter Video Attributes:** A group of dropdown menus for Video Type (Analog[DVI-A]), Video Quality (5), Color Depth (24 bits), Background Refresh (Every 32 frames(s)), and Bandwidth Limit (Unlimited).
- Beeper:** An 'Enable' checkbox.
- Properties (Right Panel):** Includes OS Language (English [US]), Port OS (w/IN), checkboxes for 'Enable Multicast Video' and 'Enable Multicast Audio', EDID Mode Selection (Manual) with an 'EDID' button, and 'Enable Media' checkboxes for Video, Audio, USB, and RS232.
- Save:** A blue button at the bottom right.

Item	Description
Mode	<p>Select Extender mode for simple one-to-one (Transmitter to Receiver) setups that are managed with the Receiver's OSD menu.</p> <p>Select Matrix mode to manage devices and connections from the KE Matrix Manager web GUI. This mode is for advanced administration of Transmitter to Receiver connections (see <i>Browser / Telnet Operation</i>, page 169).</p>

Item	Description
Properties	<p>Port OS: Use the drop-down menu to select the operating system of the computer connected to the Transmitter.</p> <p>OS Language: Use the drop-down menu to select the operating system language of the computer connected to the Transmitter.</p> <p>Enable Multicast Video: Check this box to allow a broadcast of the Transmitter's video signal to be sent out to multiple Receivers.</p> <p>Enable Multicast Audio: Check this box to allow a broadcast of the Transmitter's audio signal to be sent out to multiple Receivers.</p> <p>EDID Mode Selection: EDID contains a display's basic information and is used by the source device to utilize the best resolution across different monitors. When <i>Manual</i> or <i>Remix</i> is selected, the Receiver's OSD will have a button allowing the local EDID setting to be configured for the connection. Select how you want the source device to acquire the display's EDID:</p> <ul style="list-style-type: none"> ◆ Default: EDID is set to the default ATEN configuration. This setting must be used when connecting KE6900 devices to KE8950 devices. ◆ Auto: Checks the EDID of all connected displays and the ATEN default EDID to use the best common resolution for all displays. ◆ Manual: Manually set the EDID configuration from the Connections Page (see page 148). ◆ Remix: Manually checks the EDID of all connected displays and the ATEN default EDID to use the best common resolution for all displays (see page 148).
Enable Media	Select which type of media the Transmitter can stream to Receivers: Video, Audio, USB, and RS232.
RS232 Settings	<p>Configure the serial device settings for the Transmitter. The default settings are:</p> <p>Baud Rate: 9600</p> <p>Parity: None</p> <p>Data Bits: 8 bits</p> <p>Stop bits: 1 bit</p> <p>Flow Control: None</p>
Manager Address	Set the IP address and Port number of the computer running the KE Matrix Manager software. The default port number is 9110.

Item	Description
Transmitter Video Attributes	<p>To set the Transmitter's video settings:</p> <p>Video Type: Select the DVI video connector being used by the display: Digital (DVI-D) or Digital (DVI-I). This option is available for KE6900, KE6940, KE6900A, KE6940A units and will be grayed out for other models.</p> <p>Color Depth: Select the number of bits to use for the color depth: 24, 16, or 8. This is the number of bits used to describe the color of a single pixel. A bit depth determines the number of colors that can be displayed at one time.</p> <p>Bandwidth Limit: Select the maximum bandwidth that the Transmitter can use to transmit video over the network. A lower bandwidth setting transmits lower quality video; a higher bandwidth setting sends higher quality video but this can affect network speed.</p> <p>Video Quality: Select the video quality to use. 5 is the highest video quality, and 1 is the lowest video quality. Options are: 1~5.</p> <p>Background Refresh: Sets how often the Transmitter refreshes the background image on the connected display. Options are to refresh every 256,128, 64, 32,16, or 0 frames.</p>
Beeper	<p>Check this box to allow the device to beep every time a configuration change is made.</p>
Occupy Timeout	<p>Set a time threshold for devices whose Access Mode has been set to Occupy (see <i>Access Type</i>, page 198). If there is no activity from the Receiver occupying the port for the amount of time set here, the Receiver is timed out and the port is released. The first Receiver to send keyboard or mouse input after the port has been released gets to occupy the port. Input a value from 1 to 240 seconds.</p>

After entering the information, click **Save**.

System

The *System* tab allows you to configure the Transmitter's general settings:

The screenshot shows the 'System' configuration page. It includes three tabs: 'Network', 'Properties', and 'System'. The 'System' tab is selected. The page is divided into three main sections: 'Device Information', 'Reboot', and 'Transmitter Password Change'.
 - **Device Information:** Contains fields for Name (KE6940T), Description, IP Address (192.168.0.61), MAC Address (00:00:00:a9:01:37), F/W Version (V1.1.106 (May 2 2014 13:39:47)), and Serial Number.
 - **Reboot:** Features a checkbox for 'Reset to factory default' and a 'Reboot' button.
 - **Transmitter Password Change:** Includes a checked 'Enable' checkbox and three password input fields: 'Old Password', 'New Password', and 'Confirm Password'.
 A 'Save' button is located at the bottom right of the form.

Item	Description
Device Information	Enter the Name and Description of the Transmitter. It also displays the <i>IP Address</i> , <i>MAC Address</i> , <i>F/W Version</i> , and <i>Serial Number</i> of the Transmitter.
Reboot	Check the box and click Reboot to reset the Transmitter's settings back to the factory default. All custom settings (but not the login information) will be lost.
Transmitter Password Change	Check Enable to require a password for access to the Transmitter's OSD configuration screen. Enter the Old Password, enter a New Password, and confirm the new password in the Confirm Password box.

After entering the information, click **Save**.

User Preferences

When you select the *User Preferences* radio button and click **Configure** to login, the configuration screen appears:

Item	Description
User Password Change	This section allows you to change the OSD password: <ol style="list-style-type: none"> 1. Key in the old password in the Old password field. 2. Key in the new password in the New password field. 3. Key in the new password again in the Confirm password field.
OSD Language	Click the drop-down menu to select the language you want to use for OSD sessions. Choices are: English, Chinese (Simplified), Chinese (Traditional), Japanese, Korean, Dutch, French, Spanish, Portuguese, and Russian.
OSD Hotkey	Select the hotkey combination to invoke the OSD screen.
Logout Timeout	If there is no user input for the amount of time set with this function, the user is automatically logged out of the OSD. A login is necessary before the OSD can be accessed again.
Screen Blanker	Set how many minutes the OSD waits when a session is idle before turning off the display.

When you have made your choices, Click **Save**.

Connecting

If the Receiver is set to **Extender** mode, the video screen of the remote computer will appear automatically when you exit the OSD (press **Esc** to exit). In **Matrix** mode you will see the *System Login* screen, which provides access to the *Connection Page* by entering a username and password:

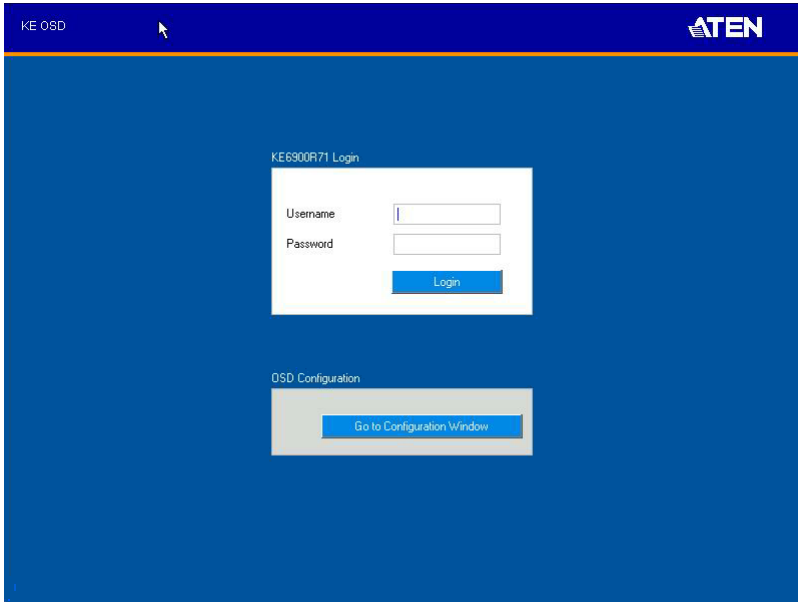

-
- Note:**
1. If you are the administrator, and are logging in to transmitter, receiver or any of the modes for the first time, refer to *Logging in for the First Time* on page 147.
 2. If the Receiver does not require a login, click *Login to system* (see *Login Required*, under *Basic*, page 202).
 3. For information about Extender and Desktop/Matrix modes, see *Mode*, page 133.
-

After you login the *Connection Page* appears, as shown on the next page.

Logging in for the First Time

If you are the administrator, and are logging in for the first time (transmitter, receiver or any of the modes), use the default username (*administrator*) and the default password (*password*).

For security purposes, the system will prompt you to change the login password immediately as shown below:



Click **OK** and change the password in the dialog box shown below:



Enter the password and confirm it in the next field. The password must be different from your original password.

No.	Item	Description
3	Connect	<p>To connect the Receiver to a Channel, click the access type:</p> <p>Exclusive: The first Receiver to access the Channel has exclusive control over the Channel. No other Receivers can view the Channel. The Timeout function does not apply to this setting.</p> <p>Occupy: The first Receiver to access the Channel has control over the Channel. However, additional Receivers may view the Channel's video display. If the Receiver controlling the Channel is inactive for longer than the time set in the Timeout box, control is transferred to the first Receiver to move the mouse or strike the keyboard.</p> <p>Share: Can simultaneously share control over the Channel. Input from the Receivers is placed in a queue and executed chronologically.</p> <p>View Only: Receiver connects with view only access to the Channels video display.</p>
4	Next Arrow	Use these two buttons to navigate to the next page or to the end of the list if there are more Channels available than can be seen on the page.
5	Previous Arrow	Use these two buttons to navigate to the previous page or to the beginning of the list if there are more Channels available than can be seen on the page.
6	Favorites	<p>Click Favorites to list only the Channels marked as favorites. Channels marked as favorites appear with a heart icon.</p> <p>To add/remove a Favorite, select a Channel and then right click with the mouse to select Add to Favorite or Remove from Favorite.</p>
7	Array Mode	Click to view the Channel connections with a video preview of each source. The list will be shown in groups of six at a time. The Array Mode is discussed on page 151.
8	List Mode	This option appears after selecting <i>Array</i> mode. Click to view the Channel connections in a list that can be sorted by name or with favorites listed first. Click the Channel Name heading to change the sort.

No.	Item	Description
9	EDID Mode	<p>When a Transmitter's EDID is configured, depending on its setting, different buttons will or won't appear to configure the Receiver's EDID for the connection. The following rules apply to the Receiver's OSD according to the Transmitter's EDID setting:</p> <ul style="list-style-type: none">◆ Under Default or Auto EDID mode, no EDID button appears as there is nothing to configure.◆ Under Manual or Remix EDID mode, the EDID button appears allowing you to select <i>Manual EDID</i> or <i>Remix EDID</i>. <p>Click Manual or Remix to adjust the EDID setting locally.</p> <p>To set the Transmitter's EDID Mode, see <i>Properties</i>, page 142.</p>
10	Logout	Click this button to log out of the Connection Page.
11	Go to Configuration Window	Click this button to return to the main OSD screen.

Array Mode

Note that Array Mode is not supported by slim KVM over IP Receivers.

In *Array Mode* the screen is divided into a grid of panels, with each panel showing the video display of a particular Channel. Right-click a panel and select a mode to connect: **E**: Exclusive, **O**: Occupy, **S**: Share, **V**: View Only, **X**: Exit. While the mouse cursor hovers over a panel displaying video, if audio is being sent from that Transmitter, it can be heard at the Receiver.

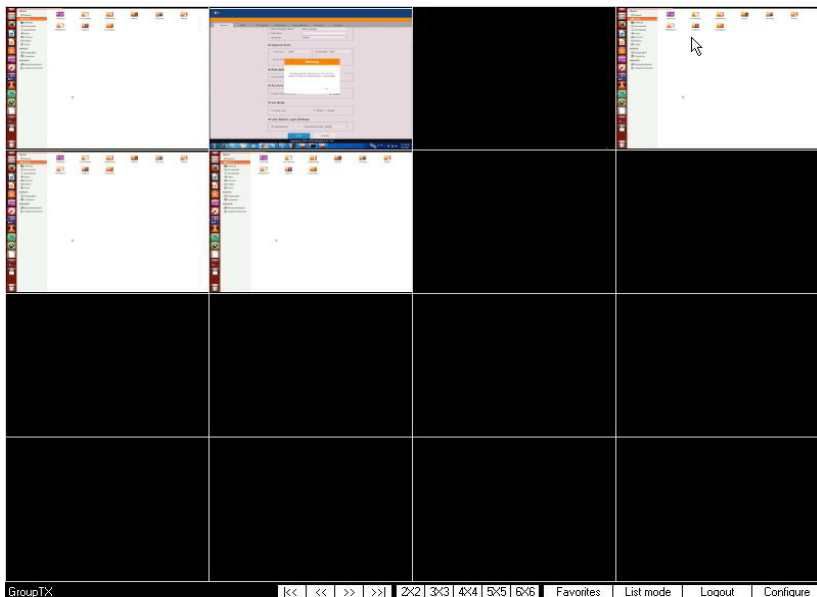

No.	Item	Description
1	Next Arrow	Use these two buttons to navigate to the next page or to the end of the list if there are more Channels available than can be seen on the page.
2	Previous Arrow	Use these two buttons to navigate to the previous page or to the beginning of the list if there are more Channels available than can be seen on the page.
3	Grid Selection	Select a range for how many Channels you want to display. Options are: 2x2, 3x3, 4x4, 5x5, and 6x6.

No.	Item	Description
4	Favorites	Click Favorites to list only the Channels marked as favorites. Click All to list all Channels. To add/remove a Favorite, go to List Mode, select a Channel and then right click with the mouse to select Add to Favorite or Remove from Favorite .
5	List Mode	Click to view the Channel connections in a list that can be sorted by name or with favorites listed first. Click the Channel Name heading to change the sort. <i>List Mode</i> is discussed on page 149.
6	Logout	Click this button to log out of the Connection Page.
10	Configure	Click this button to return to the main OSD screen.

Profile Page

Click the *Profile Page* tab and the following screen appears:

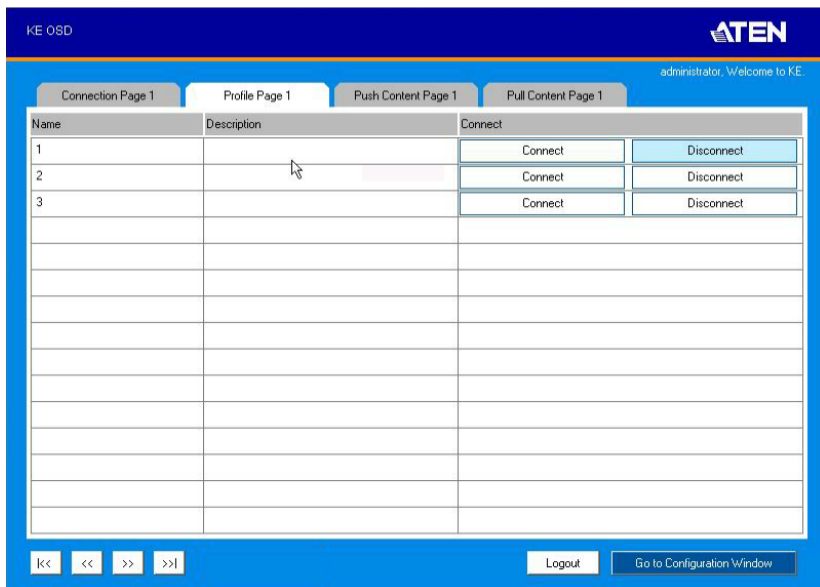

The *Profile Page* components are described in the table below:

No.	Item	Description
1	Name	Lists the Profiles available. Profiles give Receivers access to Channels and allow you to push the connection.
2	Description	The field provides a description of the Profile that was entered when it was created.
3	Connect	Click Connect and the Receiver will connect with the settings of that Profile (see <i>Adding a Profile</i> , page 220).
4	Disconnect	Click Disconnect to end the current Profile connection.
5	Next Arrow	Use these two buttons to navigate to the next page or to the end of the list if there are more Profiles available than can be seen on the page.
6	Previous Arrow	Use these two buttons to navigate to the previous page or to the beginning of the list if there are more Profiles available than can be seen on the page.
7	Logout	Click this button to log out of the Connection Page.
8	Go to Configuration Window	Click this button to return to the main OSD screen.

Push Content

Push Content allows you to push the Receiver's computer connection to another Receiver's console, allowing both to access to the computer. Select the *Push Content* tab and the following screen appears:

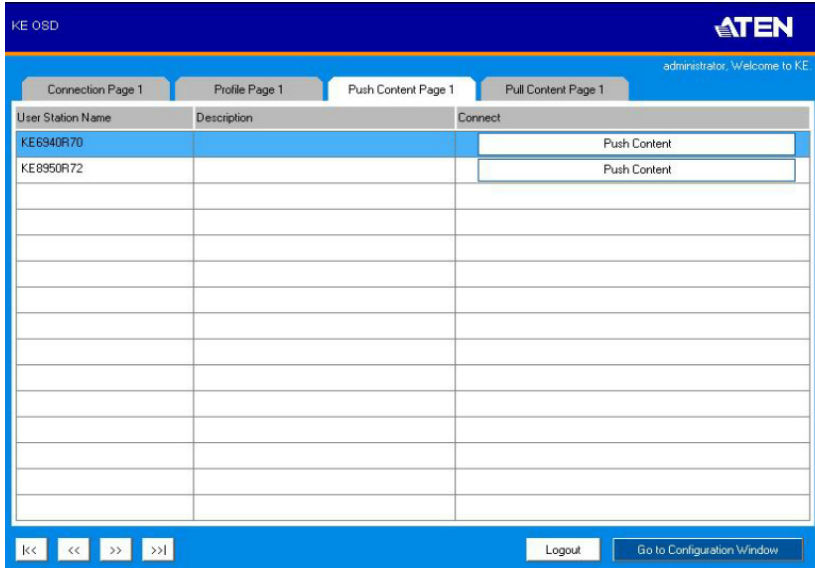

The *Push Content Page* components are described in the table, below:

No.	Item	Description
1	Receiver Name	Lists the Receivers that can be selected to push the local Receiver's computer connection to.
2	Description	The field provides a description of the Receiver that was entered when it was created.
3	Connect	Click Push Content to push the local Receiver's computer connection to the selected Receiver's console. The local Receiver's computer connection will appear on the Receiver that it was pushed to and both will share access to the computer. The access mode selected at the local Receiver will determine how access is shared (see <i>Transmitter Permissions</i> , page 197 for details).
5	Next Arrow	Use these two buttons to navigate to the next page or to the end of the list if there are more choices available than can be seen on the page.

No.	Item	Description
6	Previous Arrow	Use these two buttons to navigate to the previous page or to the beginning of the list if there are more choices available than can be seen on the page.
9	Logout	Click this button to log out of the Connection Page.
10	Go to Configuration Window	Click this button to return to the main OSD screen.

Pull Content

Pull Content allows you to pull a Receiver's computer connection to the local Receiver's console, allowing both to access to the computer. Click the *Pull Content* tab and the following screen appears:

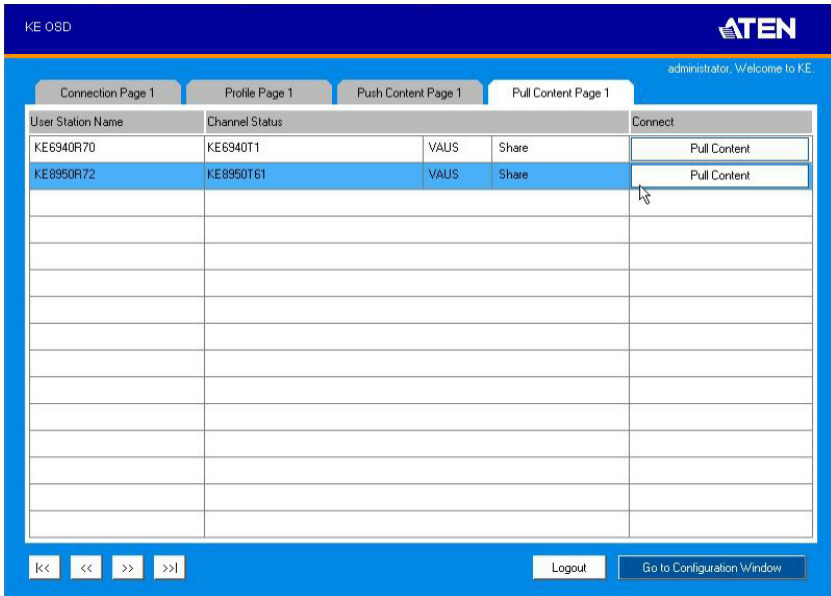

The *Pull Content Page* components are described in the table, below:

No.	Item	Description
1	Receiver Name	Lists the Receiver names currently connected to the Channel listed under <i>Channel Status</i> .
2	Channel Status	Lists the name, description and access type of each available Channel connection.
3	Connect	Click Pull Content and the Receiver will pull the Channel connection to the local console using the access mode displayed under Channel Status.
5	Next Arrow	Use these two buttons to navigate to the next page or to the end of the list if there are more choices available than can be seen on the page.
6	Previous Arrow	Use these two buttons to navigate to the previous page or to the beginning of the list if there are more choices available than can be seen on the page.
9	Logout	Click this button to log out of the Connection Page.

No.	Item	Description
10	Go to Configuration Window	Click this button to return to the main OSD screen.

This Page Intentionally Left Blank

Chapter 4

Software Installation

Overview

The *CCKMKE Matrix Manager Software* is a browser based GUI that provides management of KE Series devices over a network. You can download the KE Matrix Manager Software for free and manage up to 8 KE devices, or purchase a full version of the KE Matrix Manager Software. To purchase the full version, contact your local authorized ATEN dealer. To download the free KE Matrix Manager Software, use the instructions below.

Download - Trial Version

To download the KE Matrix Manager software, do the following:

1. Visit our website and click **Support & Downloads** → **ESERVICE**.

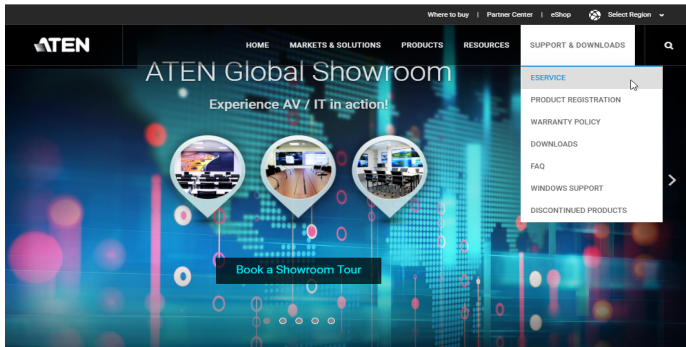

2. Under *Account*, click **Create New** or **Log In**.

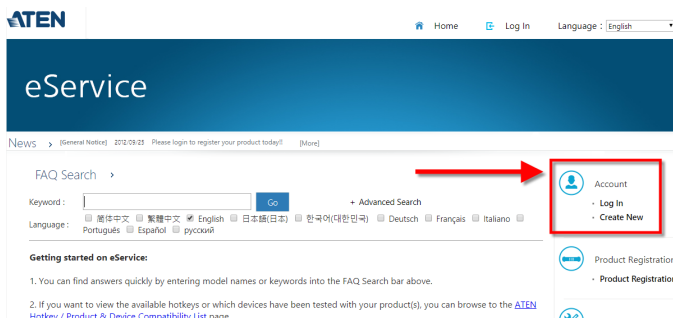

- After logging in, click **Product Registration** to register the KE device(s) you have purchased.

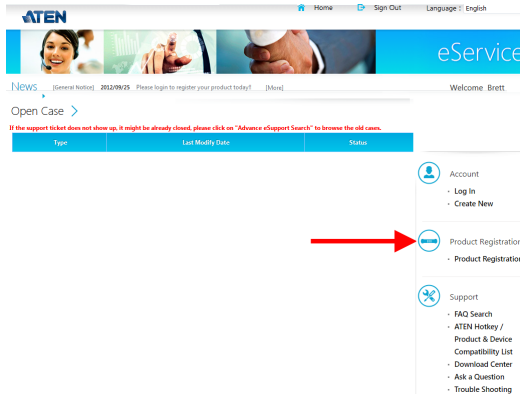

- After you have registered the KE device(s), click **Trial Software Download**.

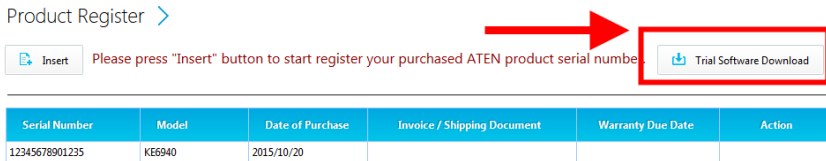

Note: The trial version of the KE Matrix Manager software includes full functions to set up and configure up to 8 KE Series devices. The KE Matrix Manager trial version will never expire. If you would like to purchase the official full version of the KE Matrix Manager software, please contact your ATEN reseller and see page 164.

- Click the software version you would like to download, then click **Save**.

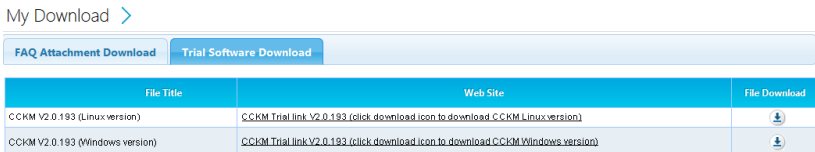

- Unzip the *cckm_win_Vx.x.xxx.zip* or *cckm_linux_Vx.x.xxx.zip* file and double click the *.exe file to start the installation.
- Follow the instructions on the next page to install the trial version of the software.

KE Matrix Manager Software Install

The following are instructions to install the full version of the KE Matrix Manager software on a primary or secondary computer. For software requirements, see *Minimum Hardware/Software Requirements*, page 7.

1. Insert the USB license key into a USB port on your computer.

Note: If you have more than 8 KE Series devices in your setup, a second USB license key is required to install KE Matrix Manager on a secondary computer.

2. Double click the *KEMatrixManagerSetup* file to start the setup. When the *Introduction* screen appears, click **Next**.

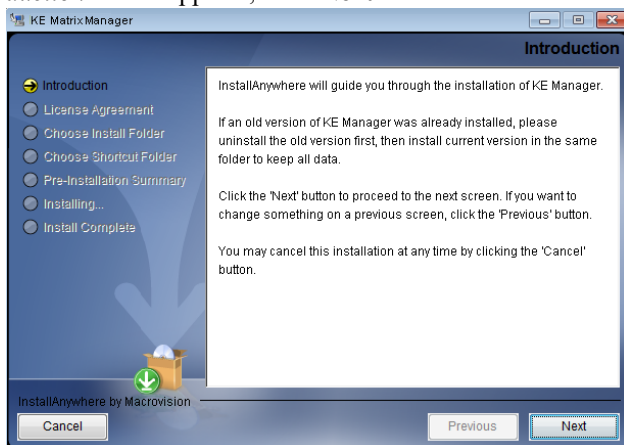

3. The *License Agreement* appears:

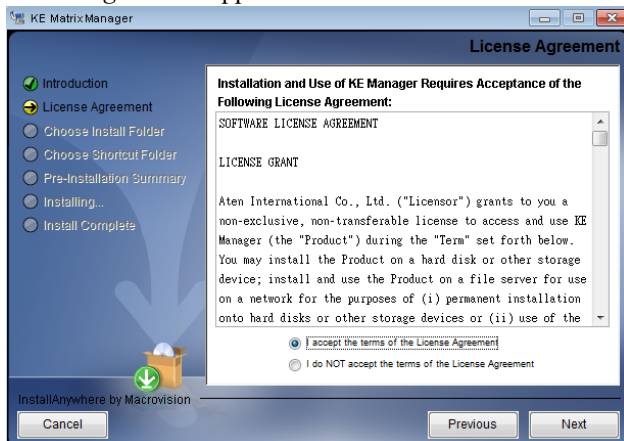

If you agree with the License Agreement, select *I accept the terms of the license agreement*, and click **Next**.

4. The *Choose Install Folder* screen appears:

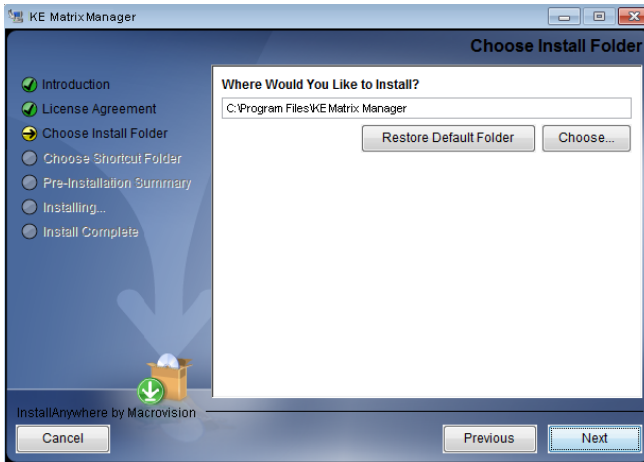

Select where you would like to install the program, and click **Next**.

5. The *Choose Shortcut Folder* screen appears:

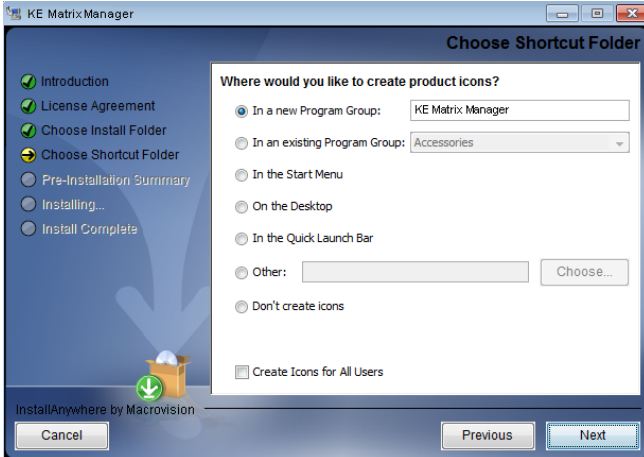

Select where to create shortcuts for the program by selecting the options provided, and click **Next**.

6. The *Pre-Installation Summary* screen appears:

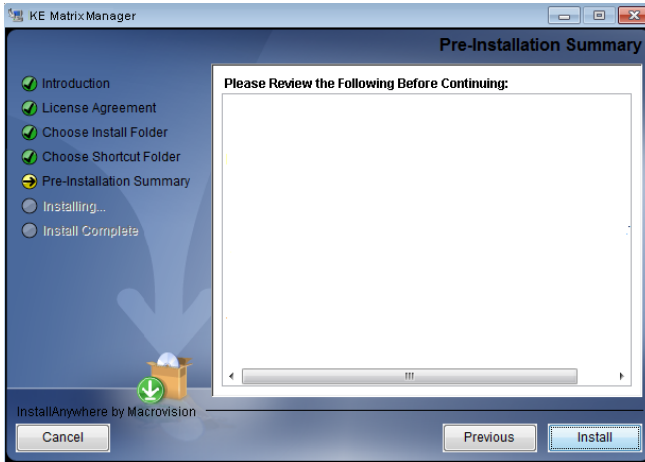

Confirm the settings you've selected. If you want to make a change click **Previous** to go back, or click **Install** to begin the software installation.

7. When the process is done, the *Install Complete* screen appears:

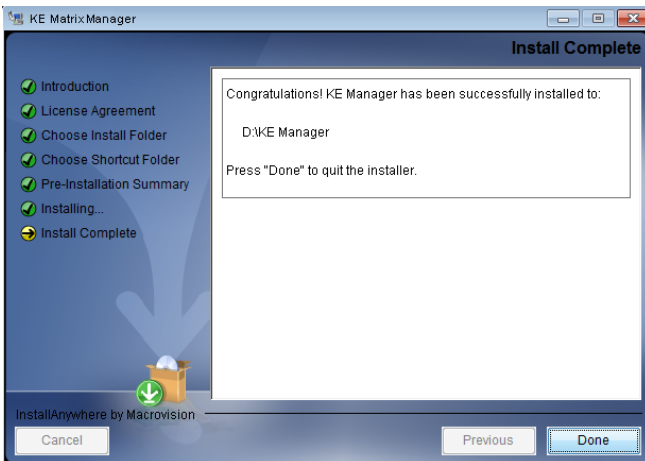

Click **Done**.

Upgrading Trial Version

After you purchase a license to upgrade the KE Matrix Manager trial version to the full version of the KE Matrix Manager software, go to the *Settings - General* tab (see page 225), and at the top page, select **Click to Upgrade**:

The screenshot displays the 'Settings - General' interface. At the top, there are tabs for 'General', 'ANMS', 'FW Upgrade', 'Redundancy', 'Backup/Restore', 'Certificates', and 'Sessions'. The 'Basic' section is expanded, showing the following configuration options:

- Basic**
 - KE Matrix Manager Version: 2.1.202 (2018-02-06 02:03)
 - Serial Number: [Click to Upgrade](#) (highlighted with a red box)
 - KE Matrix Manager Name: KE Matrix Manager
 - Description: [Empty text field]
 - Language: English (dropdown menu)
 - Beeper: Enable Disable
 - CCKM Timeout: 30 min(1-180) Disable
- Network Ports**
 - HTTP Port: 8080
 - HTTPS Port: 8443
 - Device Port: 9110
- Fast Switching**
 - Fast Switching: Disable Enable 1920x1200 (dropdown menu)
- Account Policy**
 - Enforce Password History: 3 (text field) Disable

Linux Installation

The following are instructions to install the full version of the KE Matrix Manager software on a Linux server. For software requirements, see *Minimum Hardware/Software Requirements*, page 7.

1. Download the KE Matrix Manager installation file to the Linux server.
2. Change the properties of the installation file so that its executable by running the command: `chmod a+x filename`
Example: `chmod a+x kemanager_setup.bin`
3. Start the installation with the command:
`sudo sh ./kemanager_setup.bin`
4. When the *Introduction* screen appears, click **Next**:

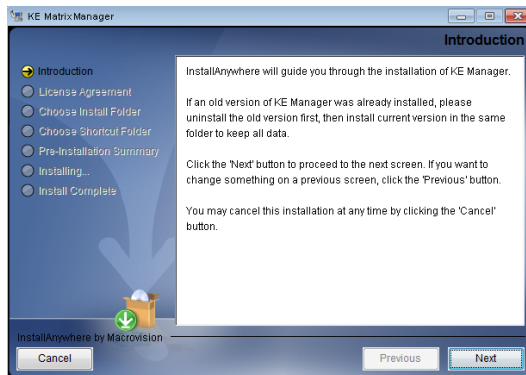

5. The *License Agreement* appears:

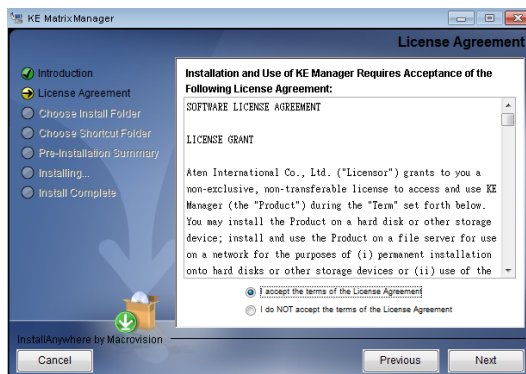

If you agree with the License Agreement, select *I accept the terms of the license agreement*, and click **Next**.

6. When the *Choose Install Folder* screen appears, select the location and continue through the installation by clicking **Next**.
7. After the software installs successfully, a directory provides useful links:

```

mitch@mitch-945GCM-S2L:/$ sudo -i
[sudo] password for mitch:
root@mitch-945GCM-S2L:~# ls -al
total 40
drwx----- 7 root root 4096  +- 14 13:42 .
drwxr-xr-x 25 root root 4096  +- 14 10:04 ..
-rw----- 1 root root 65  +- 14 13:42 .bash_history
-rw-r--r-- 1 root root 3106  + 23 2015 .bashrc
drwx----- 2 root root 4096  七 20 04:49 .cache
drwx----- 3 root root 4096  +- 13 16:07 .gnupg
drwxrwxr-x 4 root root 4096  +- 14 13:29 .java
drwxrwxr-x 5 root root 4096  +- 14 13:39 KeManager
drwxrwxr-x 2 root root 4096  +- 14 09:58 .oracle_jre_usage
-rw-r--r-- 1 root root 148  八 17 2015 .profile
root@mitch-945GCM-S2L:~# cd KeManager/
root@mitch-945GCM-S2L:~/KeManager# ls
kemanager          Query_Service      Uninstall_Matrix_Manager
_kemanager_installation Service_Manager
root@mitch-945GCM-S2L:~/KeManager#

```

8. The "Uninstall_Matrix_Manager" can be used to uninstall the software. By default the root folder can be accessed as shown below:

```
sudo -i cd /root cd KeManager sudo ./Uninstall_Matrix_Manager
```

9. To check and stop the KE Matrix Manager service, use the following commands:

```
cd KeManager sudo ./Query_Service Stop service: sudo ./Stop_Service
```

```

root@mtch-945GCM-52L:~/KeManager# sudo ./Query_Service
java version "1.8.0_121"
Java(TM) SE Runtime Environment (build 1.8.0_121-b13)
Java HotSpot(TM) 64-Bit Server VM (build 25.121-b13, mixed mode)
YAJSW: yajsw-stable-11.04
OS : Linux/4.4.0-92-generic/amd64
JVM : Oracle Corporation/1.8.0_121
Sep 07, 2017 2:13:51 PM org.apache.commons.vfs2.VfsLog info
INFO: Using "/tmp/vfs_cache" as temporary files store.
Sep 07, 2017 2:13:52 PM org.rzo.yajsw.os.posix.PosixService init
INFO: /etc/init.d/kenanager-service already exists
Sep 07, 2017 2:13:52 PM org.rzo.yajsw.os.posix.PosixService getPid
INFO: wrapper pid file: /run/wrapper.kenanager-service.pid
Name : kenanager-service
Installed : true
Running : false
Interactive : false
Automatic : false
Manual : false
Disabled : false
Paused : false
Unknown : false
Press [Enter] ...
root@mtch-945GCM-52L:~/KeManagers/cd/Service_Manager/
root@mtch-945GCM-52L:~/KeManager/Service_Manager# ls
Install_Service Start_Service Stop_Service Uninstall_Service
root@mtch-945GCM-52L:~/KeManager/Service_Manager# sudo ./Stop_Service
java version "1.8.0_121"
Java(TM) SE Runtime Environment (build 1.8.0_121-b13)
Java HotSpot(TM) 64-Bit Server VM (build 25.121-b13, mixed mode)
YAJSW: yajsw-stable-11.04
OS : Linux/4.4.0-92-generic/amd64
JVM : Oracle Corporation/1.8.0_121
Sep 07, 2017 2:15:01 PM org.apache.commons.vfs2.VfsLog info
INFO: Using "/tmp/vfs_cache" as temporary files store.
Sep 07, 2017 2:15:02 PM org.rzo.yajsw.os.posix.PosixService init
INFO: /etc/init.d/kenanager-service already exists
***** STOPPING kenanager-service *****
Sep 07, 2017 2:15:04 PM org.rzo.yajsw.os.posix.PosixService stop
INFO: Stopping kenanager-service ...
YAJSW: yajsw-stable-11.04
OS : Linux/4.4.0-92-generic/amd64
JVM : Oracle Corporation/1.8.0_121
***** STOPPING kenanager-service *****
Service kenanager-service stopped

```

10. To check and start the KE Matrix Manager service, use the following commands:

```
cd KeManager sudo ./Query_Service Stop service: sudo ./Start_service
```

```

root@mtch-945GCM-52L:~/KeManager/Service_Manager# sudo ./Start_Service
java version "1.8.0_121"
Java(TM) SE Runtime Environment (build 1.8.0_121-b13)
Java HotSpot(TM) 64-Bit Server VM (build 25.121-b13, mixed mode)
YAJSW: yajsw-stable-11.04
OS : Linux/4.4.0-92-generic/amd64
JVM : Oracle Corporation/1.8.0_121
Sep 07, 2017 2:17:27 PM org.apache.commons.vfs2.VfsLog info
INFO: Using "/tmp/vfs_cache" as temporary files store.
Sep 07, 2017 2:17:28 PM org.rzo.yajsw.os.posix.PosixService init
INFO: /etc/init.d/kenanager-service already exists
***** STARTING kenanager-service *****
Sep 07, 2017 2:17:28 PM org.rzo.yajsw.os.posix.PosixService getPid
INFO: wrapper pid file: /run/wrapper.kenanager-service.pid
Sep 07, 2017 2:17:33 PM org.rzo.yajsw.os.posix.PosixService start
INFO: Starting kenanager-service ...
YAJSW: yajsw-stable-11.04
OS : Linux/4.4.0-92-generic/amd64
JVM : Oracle Corporation/1.8.0_121
***** STARTING kenanager-service *****
Service kenanager-service started
Sep 07, 2017 2:17:33 PM org.rzo.yajsw.os.posix.PosixService getPid
INFO: wrapper pid file: /run/wrapper.kenanager-service.pid
Sep 07, 2017 2:17:34 PM org.rzo.yajsw.os.posix.PosixService getPid
INFO: wrapper pid file: /run/wrapper.kenanager-service.pid
Sep 07, 2017 2:17:34 PM org.rzo.yajsw.os.posix.PosixService getPid
INFO: wrapper pid file: /run/wrapper.kenanager-service.pid
Service kenanager-service started
root@mtch-945GCM-52L:~/KeManager/Service_Manager#

```

This Page Intentionally Left Blank

Chapter 5

Browser / Telnet Operation

Overview

The *CCKM KE Matrix Manager* Software can be accessed through most standard web browsers and via Telnet. Once users log in and are authenticated, the browser GUI comes up. The first section explains the login procedure and web browser components. The last section provides details for connecting via Telnet.

Logging In

To log into the KE Matrix Manager, do the following:

1. Open the browser and specify the IP address of the computer installed with the KE Matrix Manager software, in the browser's URL location bar.

Note: If the administrator has configured the HTTP or HTTPS port setting as something other than the default, you must include **http://** or **https://** before the IP address, and specify the port number along with the IP address. For example:

```
https://192.168.1.20:8443
```

Where *8443* is the https port number, or *8080* is the http port number, and a colon is inserted between it and the IP address.

2. If a Security Alert box appears, accept the certificate – it can be trusted (See *Trusted Certificates*, page 327 for details). The Login page appears:

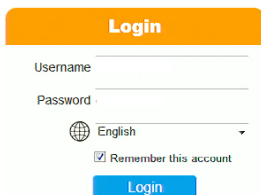

The screenshot shows a login interface with the following elements:

- An orange header with the word "Login" in white.
- A "Username" label followed by a text input field.
- A "Password" label followed by a text input field.
- A language selection dropdown menu with a globe icon and the text "English".
- A checkbox labeled "Remember this account" which is checked.
- A blue button with the word "Login" in white.

3. Enter the *Username* and *Password*, and click **Login**.

Note: Only administrator accounts can be used to login. By default, the username and password are *administrator* and *password*, respectively.

4. For security purposes, the system will prompt you to change the password immediately.

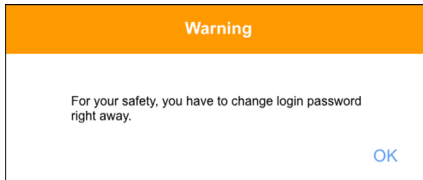

Click **OK** for the password change dialog box.

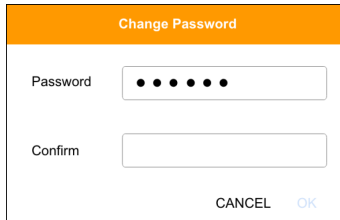

5. Enter the new password and confirm it by entering the password again.
6. Click **OK** to complete the change and the KE matrix manager main page appears. Refer to the next page for more details.

The KE Matrix Manager Main Page

After you have successfully logged in, the web browser's main page appears:

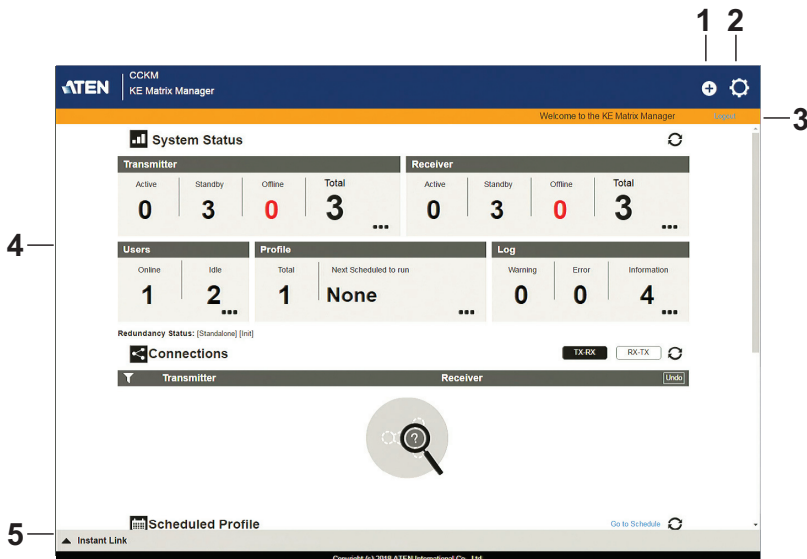







Web Components

The web components are described in the table below:

No.	Item	Description
1	Install Wizard	This icon helps you locate Transmitters/Receivers on the LAN to add them to the KE Matrix Manager (see <i>Installation Wizard</i> , page 173). If a device can't be found, check the Network settings in the device's OSD menu (see page 132 & 140).
2	System Settings	Click this icon to enter the <i>System Setting</i> section where you can configure the KE Matrix Manager software. The Settings are discussed on page 225.
3	Logout	Click this button to log out of your KE Matrix Manager web session.
4	Interactive Display Panel	This is your main work area. Scroll the page up or down to view the various selections. Some items can be clicked to open a settings page, while others provide status information.
5	Instant Link	Clicking this icon opens the lower bar which allows you to instantly connect KE devices. Instant Link is discussed on page 176.

Interactive Display Panel

The functions associated with each of the icons on the main Interactive Display Panel are explained in the table below:

Icon	Function
	<p>System Status: System Status provides an overview of the transmitter, receiver, user, profile, and log status. Each heading can be clicked to open the respective settings page. System Status is discussed on page 183.</p>
	<p>Connections: Connections provides a visual display of current transmitter and receiver connections. Connections is discussed on page 247.</p>
	<p>Scheduled Profile: Scheduled Profile provides an overview of connection profiles that are scheduled to run. Scheduled Profile is discussed on page 251.</p>
	<p>Sessions: Sessions provides a list of current user sessions. Sessions is discussed on page 253.</p>
	<p>Refresh: The Refresh button provides a way to update the information currently being displayed on the page.</p>
	<p>To Top: This button appears at the bottom right corner of the Interactive Display Panel and allows you to jump back to the top of the page.</p>

Installation Wizard

Use the *Install Wizard* to add Transmitters and Receivers to the CCKM. The wizard locates devices on the network and walks you through adding them. To add devices, do the following:

1. Connect all Transmitters and Receivers to the LAN.
2. On the CCKM main page, click the **Install Wizard** icon (page 171).
3. When the installation wizard appears, select options to locate devices:

Install Wizard

1. Connect all Transmitters and Receivers to the local area network.

Search Local
 Search Subnet

Transmitter

2

[1]00-10-74-A9-01-12
 [2]00-10-74-A9-00-00

Receiver

2

[1]00-10-74-A8-00-00
 [2]00-10-74-A8-01-03

Item	Description
Search Local	Check this box and click the <i>Refresh</i> button to search the local area network for Transmitters/Receivers.
Search Subnet	Check this box, enter a subnet IP and then click the <i>Refresh</i> button to search the subnet for Transmitters/Receivers.
Transmitter / Receiver	Displays the number of <i>Transmitters</i> and <i>Receivers</i> that have been discovered on the network. Use the check boxes next to the Transmitters/Receivers to select the devices you want to add.
	The <i>Refresh</i> button provides a way to update the information currently being displayed in the install wizard window.

4. Check the boxes under *Transmitter / Receiver* to select the devices you want to add, then click **Next**.

(Continues on next page.)

5. Under *Assign IP Address* select an option to configure the network settings, then click **Next**.

Install Wizard

2. Assign IP Address.

Transmitter

2

Receiver

2

IP Range

Transmitter ~

Receiver ~

DHCP

Use Original IP Setting

[BACK](#) [NEXT](#)

Item	Description
IP Range	Select the <i>IP Range</i> radio button to enter a series of static IP addresses to assign to the <i>Transmitters/ Receivers</i> that you are adding.
DHCP	Select the <i>DHCP</i> radio button for dynamic IP address assignment.
Use Original IP Setting	Select this radio button to use the IP address currently configured on the Transmitter/Receiver.

6. Use the *Naming Rule* radio button to create a naming convention (*Title + Number*); or *Use Original Name* to use the name currently configured on the Transmitter/Receiver, then click **Next**.

Install Wizard

3. Rename devices automatically.

Naming Rule

Transmitter + Number start from

Receiver + Number start from



Use Original Name

[BACK](#) [NEXT](#)

7. Confirm each Transmitter's *Name*, *IP Address*, *Audio* setting and check the boxes to set *Permissions**, then click **Next** and repeat the process for Receivers.

Install Wizard

4. Confirm Transmitter information.
Permissions View Only Occupy Exclusive

No.	MAC	Name	IP Address	
1	00-10-74-A9-01-12	<input type="text" value="KE6940T61"/>	<input type="text" value="192.168.0.61"/>	
2	00-10-74-BD-01-23	<input type="text" value="KE8950T"/>	<input type="text" value="192.168.0.63"/>	

[BACK](#) [NEXT](#)

Note: See *Transmitter Permissions*, **page 197**, and *Receiver Permissions*, **page 210** for information about setting permissions.

8. Click **Done**.



Instant Link

At the bottom of the KE Matrix Manager Main Page is the *Instant Link* bar. In this section you can quickly connect Receivers to Transmitters.

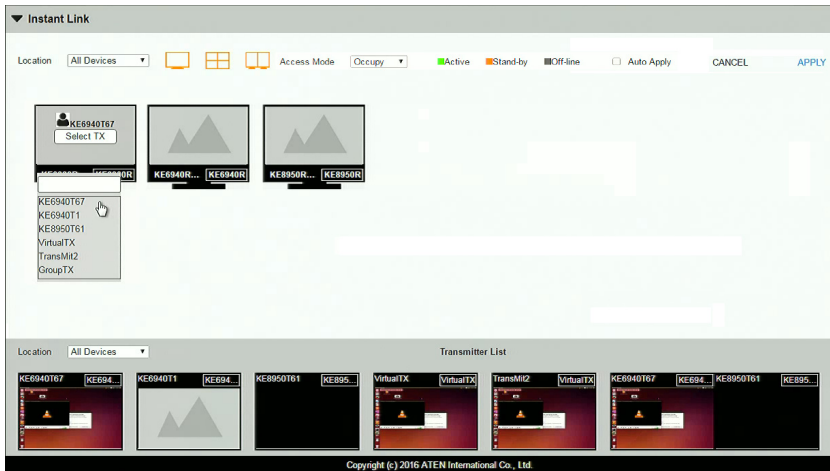
The top panel provides the **Receiver List**, and the bottom panel provides the **Transmitter List**. To create a connection, click a Receiver in the top panel and use the drop-down menu to select a Transmitter (as shown in the image below); or drag-and-drop Transmitters from the bottom panel to Receivers in the top panel. Configure as many Receiver to Transmitter connections as needed, and then click **Apply**.



Item	Description
Instant Link	The Instant Link bar provides access to quickly connect Receivers to Transmitters. Click the bar to open the panel, click again to minimize the panel. The top panel provides a list of all the Receivers discovered on the LAN. Click a Receiver and use the drop-down menu to select a Transmitter.
Transmitter List	Click the Transmitter List bar to open the panel. The panel provides a list of all the Transmitters discovered on the LAN. Drag-and-drop Transmitters in the bottom panel to Receivers in the top panel to establish the connection.
Location	Use the drop-down menu to select a location to filter the Receivers or Transmitters displayed on the page.
	Click this icon to show individual Receivers.

Item	Description
	Click this icon to show only video wall Receivers.
	Click this icon to show only Receiver Group Receivers.
Access Mode	Click a device and use the drop-down box to set the access mode: <i>Occupy</i> , <i>View Only</i> , or <i>Exclusive</i> .
Auto Apply	Checking this box allows you to drag and drop devices and apply the connection immediately without having to click the <i>Apply</i> button.
Apply	Click Apply to connect the devices.
Cancel	Click Cancel to exit without connecting.

RS-232 / Telnet

The KE Series can be operated and configured via a remote terminal session using Telnet. This is a useful means for configuring devices when they are first setup and connected to the network.

Telnet

To log into the KE Series device by means of a Telnet session, do the following:

1. On your computer, open a terminal (command line) session.
2. At the prompt, key in the KE device's IP address with port 23 in the following way:

```
telnet [IP address] [port]
```

3. Please press “**Enter**” to start “**TextMenu**” The login screen appears. At the login prompt, provide the Password.

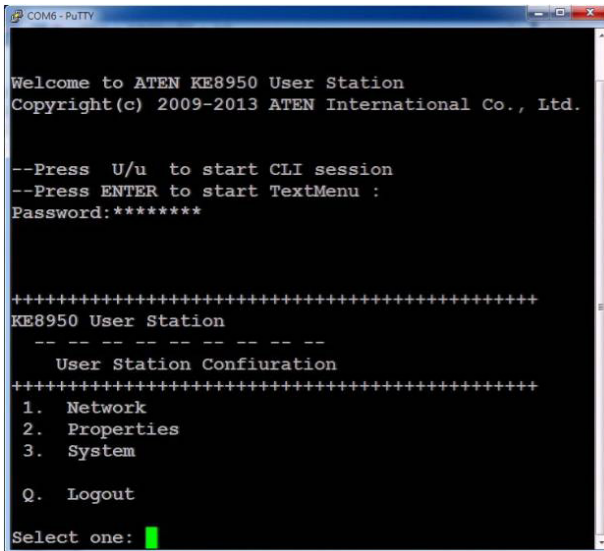

```
COM6 - PuTTY
Welcome to ATEN KE8950 User Station
Copyright(c) 2009-2013 ATEN International Co., Ltd.

--Press U/u to start CLI session
--Press ENTER to start TextMenu :
Password:*****

+++++
KE8950 User Station
-----
User Station Configuration
+++++
1. Network
2. Properties
3. System
Q. Logout
Select one: █
```

Note: The default password for Telnet sessions is *password*.

RS-232

To log into the KE Series device by means of a RS-232 session, do the following:

1. The controller's serial port should be configured the same as the Receiver's default configuration, as shown below:

Baud Rate	9600
Data Bits	8
Parity	None
Stop Bits	1
Flow Control	None

The Receiver's **Function Switch** should be set to *RS-232 Config* (see page 40). Before executing RS-232 commands across a network you must install the KE Matrix Manager software on a computer and ensure that it is online. For the Slim Version of KE Series (KE8900ST/8900SR/9900ST). Please make sure the RS-232 Serial Port is not connected before executing commands.

2. Please press “**Enter**” to start “**TextMenu**” The login screen appears. At the login prompt, provide the Password.

```

COM6 - PUTTY
Welcome to ATEN KE8950 User Station
Copyright(c) 2009-2013 ATEN International Co., Ltd.

--Press U/u to start CLI session
--Press ENTER to start TextMenu :
Password:*****

+++++
KE8950 User Station
  --  --  --  --  --  --  --
      User Station Confiuration
+++++
1. Network
2. Properties
3. System
Q. Logout
Select one: █

```

Note: The default password for Telnet sessions is *password*.

Configuration Menu

Once a Telnet connection to the KE device is established, the device's text-based Configuration Menu comes up, allowing you to select options by entering a number on the following screens:

Main Menu

+++++

KE6900 Receiver

Receiver Configuration

+++++

- 1. Network
- 2. Properties
- 3. System
- Q. Logout

Select one:

1. Network

```

+++++
KE6900 Receiver
-----

```

```

    Network Settings
+++++

```

1. IP Installer [Enabled]
2. DHCP [Disabled]
3. IP Address [172.17.17.34]
4. Subnet Mask [255.255.255.0]
5. Default Gateway [172.17.17.254]

```

Q. Exit

```

```

Select one:

```

2. Properties

```

+++++
KE6900 Receiver
-----

```

```

    Device Properties
+++++

```

1. Mode [Matrix]
2. Transmitter Video IP Address [172.17.17.35]
3. Transmitter Audio IP Address [172.17.17.35]
4. Transmitter USB IP Address [172.17.17.35]
5. Transmitter RS232 IP Address [172.17.17.35]
6. UART Configuration
7. Video [Enabled]
8. Audio [Enabled]
9. USB [Enabled]
10. RS232 [Enabled]
11. KE Matrix Manager IP [172.17.17.33]
12. KE Matrix Manager Port [9110]
13. Beeper [Enabled]
14. USB Mode [VM]
15. USB Secure Transmit [Disabled]

```

Q. Exit

```

```

Select one:

```

3. System

+++++

KE6900 Receiver

System Setting

+++++

1. Device Name [KE6900R]
2. Device Description [Receiver1]

Device IP Address: 172.17.17.34
Device MAC Address: 00:10:74:A8:01:23
Device FW Version: V1.1.109
Device Serial Number:

3. Password [Enabled]
4. Change Password
5. System Reboot/Reset to Factory Default

Q. Exit

Select one:

Note: The Reset to Factory Default function resets everything but the login information to the factory default settings. To reset the login information, refer to *Reset All Information* on page 329.

Chapter 6

System Status

Overview

The *System Status* panel is found at the top of the **KE Matrix Manager Main Page**. This section provides status information about Transmitters, Receivers, Users, Profiles and Logs. Click on a selection to open a *Settings* page, which are discussed in the sections that follow.

The screenshot displays the KE Matrix Manager interface. At the top, the ATEN logo and 'CCKM KE Matrix Manager' are visible. A navigation bar contains a welcome message and a 'Logout' link. The main content area features a 'System Status' panel with the following data:

Transmitter				Receiver			
Active	Stand-by	Off-line	Total	Active	Stand-by	Off-line	Total
0	3	0	3	0	3	0	3

Users		Profile		Log		
On-line	Idle	Total	Next schedule	Warning	Error	Information
1	4	3	Profile2	359	9	2...

Redundancy Status: [Primary] [Working]

The 'Connections' section shows a Receiver (KE8950R72) connected to a Transmitter (KE6940T67) via a bidirectional link. The user 'administrator (share)' is associated with the connection.

Copyright (c) 2019 ATEN International Co., Ltd.

System Status

The *System Status* panel has five sections that provide information and a link to each settings page. Each settings page can be accessed by **Clicking** within the section: Transmitter, Receiver, Users, Profile or Log. Each section is explained in the table below and the Settings on the pages that follow.

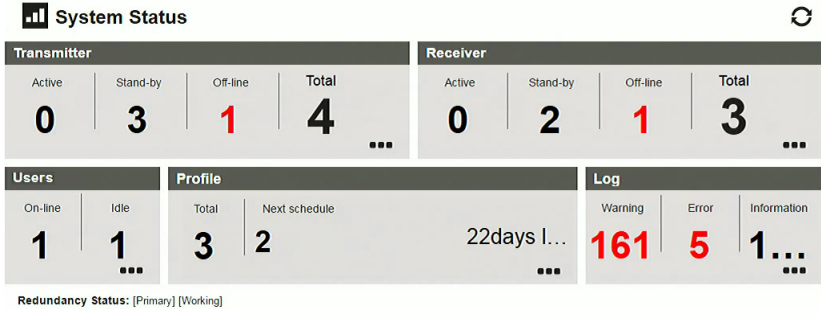

Item	Description
Transmitter	<p>This section provides an overview of the Transmitters added to the KE Matrix Manager:</p> <ul style="list-style-type: none"> ♦ Active: Shows the number of Transmitters that are currently online and connected to a Receiver. ♦ Standby: Shows the number of Transmitters that are online but not connected to a Receiver. ♦ Offline: Shows the number of Transmitters added to the KE Matrix Manager that are not online. ♦ Total: Displays the total number of Transmitters added to the KE Matrix Manager.
Receiver	<p>This section provides an overview of the Receivers added to the KE Matrix Manager:</p> <ul style="list-style-type: none"> ♦ Active: Shows the number of Receivers that are currently online and connected to a Transmitter. ♦ Standby: Shows the number of Receivers that are online but not connected to a Transmitter. ♦ Offline: Shows the number of Receivers added to the KE Matrix Manager that are not online. ♦ Total: Displays the total number of Receivers added to the KE Matrix Manager.





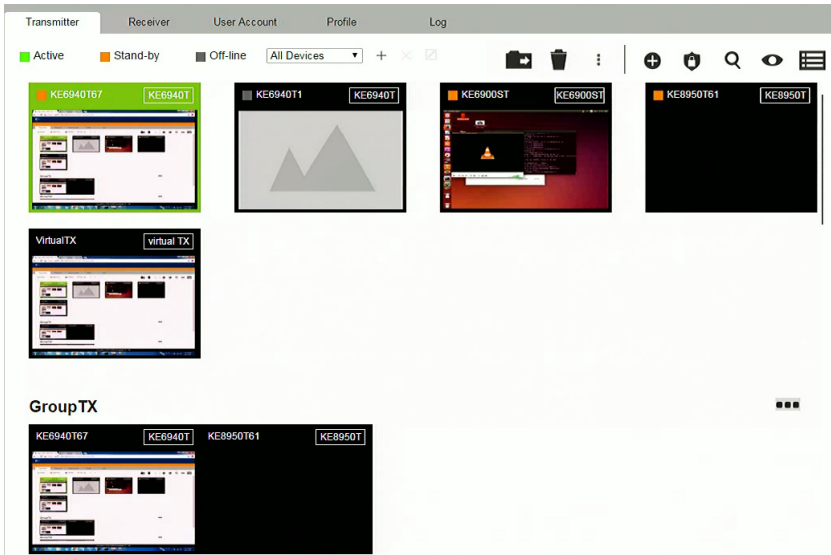

Item	Description
Users	<p>This section provides an overview of users with KE Matrix Manager sessions:</p> <ul style="list-style-type: none"> ◆ On-line: Shows the number of users that are logged into OSD or KE Matrix Manager web sessions. ◆ Idle: Shows the number of users not logged into OSD or KE Matrix Manager web sessions.
Profile	<p>This section provides an overview of Profile and Profile Schedules:</p> <ul style="list-style-type: none"> ◆ Total: Shows the total number of Profiles available. ◆ Next scheduled to run: Shows the name of the next Profile scheduled to run. ◆ Days later: Shows the number of days until the next Profile is scheduled to run.
Log	<p>This section provides an overview of system logs:</p> <ul style="list-style-type: none"> ◆ Warning: Shows the number of warnings logs generated since the event log was cleared. ◆ Error: Shows the number of error logs generated since the event log was cleared. ◆ Information: Shows the number of information logs generated since the log was cleared.
Redundancy Status	<p>This section provides information about the Redundancy mode. The first set of brackets shows which server is hosting the KE Matrix Manager database: [Primary] or [Secondary]. If Redundancy is disabled the first bracket will read: [Standalone]. The second set of brackets show the status:</p> <ul style="list-style-type: none"> ◆ [Working]: The server is actively hosting the KE Matrix Manager database. ◆ [Standby]: This message appears when database operations are idle.



Transmitter

Click **Transmitter** in the *System Status* panel to open the settings. On this page you can add, delete and configure *Transmitters* (physical transmitters), *Virtual Transmitters* (multi-source) and *Transmitter Groups* (multi-video source). The KE Matrix Manager automatically adds Transmitters connected to the local area network with a valid IP address.







The meanings of the icons and headings on the page are straightforward and let you view and configure Transmitters.

- ◆  *Active* refers to a Transmitter connection that is online and in use.
- ◆  *Standby* refers to a Transmitter connection that is online.
- ◆  *Offline* refers to a Transmitter connection that is offline.
- ◆  **All Devices** Use this drop-down menu to filter Transmitters by location. Use Locations to limit the Transmitters seen on the page.
 - ◆  Click to add a new **Location**.
 - ◆  Select a Transmitter and click the **Move to** icon to add devices to a Location.
 - ◆  Select a Location from the drop-down menu and click this icon to delete it.

- ◆  Select a Location and click this icon to change the name.
- ◆  Click to delete selected Transmitters.
- ◆  Click an option to have selected Transmitters:
 - ◆ **Copy & Paste:** Copy settings from one Transmitter and paste them to another (see *Copy & Paste*, page 193).
 - ◆ **Beeper:** Sound a Beep.
 - ◆ **Reboot:** Shut down and restart.
 - ◆ **Reset to Factory:** Reset all setting to the factory default.

Note: The Reset to Factory function resets everything but the login information to the factory default settings. To reset the login information, refer to *Reset All Information* on page 329.

- ◆  Click to *Create Virtual TX* or *Create TX Group* (page 194 & 196).
- ◆  Click to set Transmitter permissions (page 197).
- ◆  Click to search for Transmitters.
- ◆  Click to filter Transmitters shown on the page.
- ◆  Click to switch between *Grid View* and *List View*.

Transmitter Configuration

When the KE Matrix Manager discovers Transmitters on the network they appear on the *Transmitter* settings page. Double-click a Transmitter to configure its settings.

< Back device
Physical Transmitter Configuration

Basic <table style="width: 100%; border-collapse: collapse;"> <tr><td style="width: 20%;">Device Name</td><td><input type="text" value="KE6940T67"/></td></tr> <tr><td>Description</td><td><input type="text"/></td></tr> <tr><td>Location</td><td><input type="text" value="Brett"/></td></tr> <tr><td>Mode</td><td><input type="radio"/> Extender <input checked="" type="radio"/> Matrix</td></tr> <tr><td>Audio Input</td><td><input checked="" type="radio"/> HDMI <input type="radio"/> Analog <input type="radio"/> Auto</td></tr> <tr><td>Enable Media</td><td><input checked="" type="checkbox"/> Video <input checked="" type="checkbox"/> Audio <input checked="" type="checkbox"/> USB <input checked="" type="checkbox"/> RS232</td></tr> <tr><td>EDID Mode</td><td><input type="text" value="Default"/></td></tr> <tr><td>Multicast Video</td><td><input checked="" type="radio"/> Enable <input type="radio"/> Disable</td></tr> <tr><td>Multicast Audio</td><td><input checked="" type="radio"/> Enable <input type="radio"/> Disable</td></tr> <tr><td>Occupy Timeout</td><td><input type="text" value="5"/> sec (0-240)</td></tr> <tr><td>Port OS</td><td><input type="text" value="Win"/></td></tr> <tr><td>OS Language</td><td><input type="text" value="English (US)"/></td></tr> <tr><td>CCKM IP</td><td><input type="text" value="192.168.0.11"/> <input type="text" value="9110"/></td></tr> <tr><td>IP Installer</td><td><input checked="" type="radio"/> Enable <input type="radio"/> Disable <input type="radio"/> View Only</td></tr> </table>	Device Name	<input type="text" value="KE6940T67"/>	Description	<input type="text"/>	Location	<input type="text" value="Brett"/>	Mode	<input type="radio"/> Extender <input checked="" type="radio"/> Matrix	Audio Input	<input checked="" type="radio"/> HDMI <input type="radio"/> Analog <input type="radio"/> Auto	Enable Media	<input checked="" type="checkbox"/> Video <input checked="" type="checkbox"/> Audio <input checked="" type="checkbox"/> USB <input checked="" type="checkbox"/> RS232	EDID Mode	<input type="text" value="Default"/>	Multicast Video	<input checked="" type="radio"/> Enable <input type="radio"/> Disable	Multicast Audio	<input checked="" type="radio"/> Enable <input type="radio"/> Disable	Occupy Timeout	<input type="text" value="5"/> sec (0-240)	Port OS	<input type="text" value="Win"/>	OS Language	<input type="text" value="English (US)"/>	CCKM IP	<input type="text" value="192.168.0.11"/> <input type="text" value="9110"/>	IP Installer	<input checked="" type="radio"/> Enable <input type="radio"/> Disable <input type="radio"/> View Only	Video Settings <table style="width: 100%; border-collapse: collapse;"> <tr><td>Video Type</td><td><input type="text" value="DVI-D"/></td></tr> <tr><td>Color Depth</td><td><input type="text" value="24"/></td></tr> <tr><td>Bandwidth</td><td><input type="text" value="Unlimited"/></td></tr> <tr><td>Video Quality</td><td><input type="text" value="5(Best)"/></td></tr> <tr><td>Background Refresh</td><td><input type="text" value="Every 32 frames"/></td></tr> </table>	Video Type	<input type="text" value="DVI-D"/>	Color Depth	<input type="text" value="24"/>	Bandwidth	<input type="text" value="Unlimited"/>	Video Quality	<input type="text" value="5(Best)"/>	Background Refresh	<input type="text" value="Every 32 frames"/>
Device Name	<input type="text" value="KE6940T67"/>																																						
Description	<input type="text"/>																																						
Location	<input type="text" value="Brett"/>																																						
Mode	<input type="radio"/> Extender <input checked="" type="radio"/> Matrix																																						
Audio Input	<input checked="" type="radio"/> HDMI <input type="radio"/> Analog <input type="radio"/> Auto																																						
Enable Media	<input checked="" type="checkbox"/> Video <input checked="" type="checkbox"/> Audio <input checked="" type="checkbox"/> USB <input checked="" type="checkbox"/> RS232																																						
EDID Mode	<input type="text" value="Default"/>																																						
Multicast Video	<input checked="" type="radio"/> Enable <input type="radio"/> Disable																																						
Multicast Audio	<input checked="" type="radio"/> Enable <input type="radio"/> Disable																																						
Occupy Timeout	<input type="text" value="5"/> sec (0-240)																																						
Port OS	<input type="text" value="Win"/>																																						
OS Language	<input type="text" value="English (US)"/>																																						
CCKM IP	<input type="text" value="192.168.0.11"/> <input type="text" value="9110"/>																																						
IP Installer	<input checked="" type="radio"/> Enable <input type="radio"/> Disable <input type="radio"/> View Only																																						
Video Type	<input type="text" value="DVI-D"/>																																						
Color Depth	<input type="text" value="24"/>																																						
Bandwidth	<input type="text" value="Unlimited"/>																																						
Video Quality	<input type="text" value="5(Best)"/>																																						
Background Refresh	<input type="text" value="Every 32 frames"/>																																						
IP Settings <table style="width: 100%; border-collapse: collapse;"> <tr><td><input type="radio"/> DHCP</td><td></td></tr> <tr><td><input checked="" type="radio"/> Manual</td><td>IP Address <input type="text" value="192.168.0.67"/></td></tr> <tr><td></td><td>Mask <input type="text" value="255.255.255.0"/></td></tr> <tr><td></td><td>Gateway <input type="text" value="192.168.0.254"/></td></tr> </table>		<input type="radio"/> DHCP		<input checked="" type="radio"/> Manual	IP Address <input type="text" value="192.168.0.67"/>		Mask <input type="text" value="255.255.255.0"/>		Gateway <input type="text" value="192.168.0.254"/>																														
<input type="radio"/> DHCP																																							
<input checked="" type="radio"/> Manual	IP Address <input type="text" value="192.168.0.67"/>																																						
	Mask <input type="text" value="255.255.255.0"/>																																						
	Gateway <input type="text" value="192.168.0.254"/>																																						
Password Protection <table style="width: 100%; border-collapse: collapse;"> <tr><td><input type="radio"/> Disable</td><td></td></tr> <tr><td><input checked="" type="radio"/> Enable</td><td>Password <input type="text" value="*****"/></td></tr> <tr><td></td><td>Confirm <input type="text" value="*****"/></td></tr> </table>		<input type="radio"/> Disable		<input checked="" type="radio"/> Enable	Password <input type="text" value="*****"/>		Confirm <input type="text" value="*****"/>																																
<input type="radio"/> Disable																																							
<input checked="" type="radio"/> Enable	Password <input type="text" value="*****"/>																																						
	Confirm <input type="text" value="*****"/>																																						
RS232 Settings <table style="width: 100%; border-collapse: collapse;"> <tr><td>Baud Rate</td><td><input type="text" value="9600"/></td><td>Stop Bits</td><td><input type="text" value="1"/></td></tr> <tr><td>Parity</td><td><input type="text" value="None"/></td><td>Flow Control</td><td><input type="text" value="None"/></td></tr> <tr><td>Data Bits</td><td><input type="text" value="8"/></td><td></td><td></td></tr> </table>		Baud Rate	<input type="text" value="9600"/>	Stop Bits	<input type="text" value="1"/>	Parity	<input type="text" value="None"/>	Flow Control	<input type="text" value="None"/>	Data Bits	<input type="text" value="8"/>																												
Baud Rate	<input type="text" value="9600"/>	Stop Bits	<input type="text" value="1"/>																																				
Parity	<input type="text" value="None"/>	Flow Control	<input type="text" value="None"/>																																				
Data Bits	<input type="text" value="8"/>																																						

CANCEL
SAVE

Item	Description
Basic	<p>Device Name: Enter a name for the Transmitter.</p> <p>Description: Enter a description for the Transmitter.</p> <p>Location: Use the drop-down menu to select a Location for the device. Locations filter the Transmitters seen on the settings page.</p> <p>Mode: Use the radio button to select how the Transmitter will be installed and managed:</p> <ul style="list-style-type: none">◆ Select Extender mode for simple one-to-one (Transmitter to Receiver) setups that are managed at the Receiver's OSD menu.◆ Select Matrix mode to manage devices and connections over the LAN from the KE Matrix Manager software. This mode is for advanced administration of Transmitter and Receiver connections configured within the KE Matrix Manager Web GUI. <p>Enable Media: Select which source type the Transmitter can stream: Video, Audio, USB and RS232.</p> <p>Audio Input: Use this option to select the Transmitter's audio source signal: <i>HDMI</i>, <i>Analog</i>, or <i>Auto</i>. This setting should reflect the audio setting configured on the computer.*</p> <p>Note: The <i>Audio Input</i> option is only available on KE devices with HDMI capabilities.</p>

Item	Description
Basic	<p>EDID Mode: EDID contains a display's basic information and is used by the source device to utilize the best resolution across different monitors. When <i>Manual</i> or <i>Remix</i> is selected, the Receiver's OSD will have a button allowing the local EDID setting to be configured for the connection (see <i>EDID Mode</i>, page 150). Select how you want the source device to acquire the display's EDID:</p> <ul style="list-style-type: none"> ◆ Default: EDID is set to the default ATEN configuration. This setting must be used when connecting KE6900 devices to KE8950 devices. ◆ Auto: Checks the EDID of all connected displays and the ATEN default EDID to use the best common resolution for all displays. ◆ Manual: Manually set the EDID configuration from the Receiver's OSD (see <i>EDID Mode</i>, page 150). ◆ Remix: Manually checks the EDID of all connected displays and the ATEN default EDID to use the best common resolution for all displays (see <i>EDID Mode</i>, page 150). <p>Multicast Video: Select Enable to allow a broadcast of the Transmitter's video signal to be sent to multiple Receivers.</p> <p>Multicast Audio: Select Enable to allow a broadcast of the Transmitter's audio signal to be sent to multiple Receivers.</p> <ul style="list-style-type: none"> ◆ Occupy Timeout: Set a time threshold for Receivers whose Access Mode has been set to Occupy. If there is no activity from the Receiver occupying the port for the amount of time set here, the Receiver is timed out and the port is released. The first Receiver to send keyboard or mouse input after the port has been released gets to occupy the port. Input a value from 1 to 240 seconds. <p>Port OS: Use the drop-down menu to select the operating system on the computer connected to the Transmitter.</p> <p>OS Language: Use the drop-down menu to select the operating system language on the computer connected to the Transmitter.</p> <p>CCKM IP: Set the IP address and Port number of the computer running the KE Matrix Manager software. The default port number is 9110.</p> <p>IP Installer: The IP Installer is an external Windows-based utility for assigning an IP address to the device. Click a radio button to select Enable, Disable or View Only for the IP Installer utility. See <i>IP Installer</i>, page 326 for instructions.</p>

Item	Description
Video Settings	<p>These refer to the Transmitter's video settings:</p> <p>Video Type: Select the DVI video connector being used by the display: Digital (DVI-D) or Digital (DVI-I). This option is only available for KE6900 units.</p> <p>Color Depth: Select the number of bits to use for the color depth: 24, 16, or 8. This is the number of bits used to describe the color of a single pixel. A bit depth determines the number of colors that can be displayed at one time.</p> <p>Bandwidth Limit: Select the maximum bandwidth that the Transmitter can use to transmit video over the network. A lower bandwidth transmits lower quality video; a higher bandwidth sends higher quality video but this can affect network speed.</p> <p>Video Quality: Select the video quality to use. 5 is the highest video quality, and 1 is the lowest video quality. Options are: 1~5.</p> <p>Background Refresh: Sets how often the Transmitter refreshes the background image on the connected display. Options are to refresh every 256,128, 64, 32,16, or 0 frames.</p>
IP Settings	<p>For dynamic IP address assignment, select the DHCP radio button.</p> <p>To specify a fixed IP Address, Subnet Mask, and Default Gateway select the Manual radio button and fill in the fields with values appropriate for your network.</p> <p>For information to configure the network settings locally on the device, see <i>Network Configuration</i>, page 125.</p>
Password Protection	<p>Select Enable to require a password to access the Transmitter's OSD configuration screens (see page 130).</p> <p>Enter a <i>Password</i>, and confirm the password in the <i>Confirm</i> box.</p>
RS232 Settings	<p>Configure the serial device settings for the Transmitter. The default settings are:</p> <p>Baud Rate: 9600</p> <p>Parity: None</p> <p>Data Bits: 8 bits</p> <p>Stop bits: 1 bit</p> <p>Flow Control: None</p>

Item	Description
Replace Device	<p>Click Replace Device in the top left corner to replace an old Transmitter with a new one.* All settings are copied from the old Transmitter to the new Transmitter. Before using this feature, connect the new Transmitter to the network. After clicking <i>Replace Device</i>, use the drop-down menu to select the new Transmitter where the settings will be applied.</p> <p>Note:</p> <ol style="list-style-type: none">1. This option only appears when a Transmitter is offline.2. This feature can be used for both Receivers and Transmitters. Replacement should be carried out on a similar model.
Save	Click Save to save changes to the properties.
Cancel	Click Cancel to exit without saving.

Copy & Paste

Copy & Paste allows you to copy settings from one Transmitter and paste them to another. To copy Transmitter settings to another device, do the following:

1. Select a Physical Transmitter.
2. On the Transmitter menu bar, click **Copy & Paste** (page 187).
3. Check the boxes of the settings you want to copy, and click **Next**.

Copy & Paste

1. Please select the items you want to copy.

Select All

Unselect All

Basic

- Description
- Location
- Mode
- Enable Media
- EDID Mode
- Multicast Video
- Multicast Audio
- Occupy Timeout
- Port OS
- OS Language
- CCKM IP
- IP Installer

RS232 Settings

- Baud Rate
- Parity
- Data Bits
- Stop Bits
- Flow Control

Video Settings

- Video Type
- Color Depth
- Bandwidth
- Video Quality
- Background Refresh

CANCEL
NEXT

4. Select the Transmitter(s) where you want to apply the settings, and click **Done**.

Copy & Paste

2. Please select the targets you want to paste.

Select All

Unselect All

KE6940T62

KE8950T

PREVIOUS
DONE

Virtual Transmitter

Creating a *Virtual Transmitter* allows you to create one connection that sources media (KVM, audio, USB, serial) from different Transmitters. Virtual Transmitters appear on the *Transmitter* settings page with **Virtual TX** in the top right corner. Simply select an online Transmitter for each media source. Dual Display Transmitters can be added as two separate Virtual Transmitters.

To create a Virtual Transmitter, in *Transmitter* settings click  and then select **Create Virtual TX**.

Create Virtual TX

Name	<input type="text" value="VirtualTX"/>
Description	<input type="text"/>
Location	<input type="text" value="Unallocated"/> ▼
KVM	<input type="text" value="Select Device"/> ▼
Audio	<input type="text" value="Select Device"/> ▼
USB	<input type="text" value="Select Device"/> ▼
Serial	<input type="text" value="Select Device"/> ▼

CANCEL
APPLY

Item	Description
Name	Enter a name for the Virtual Transmitter.
Description	Enter a description for the Virtual Transmitter.
Location	Use the drop-down menu to select a location for the Virtual Transmitter or leave it Unallocated. See <i>Location</i> , page 186, for details.
KVM	Use the drop-down menu to select a KVM (keyboard, video, mouse) source for the Virtual Transmitter.
Audio	Use the drop-down menu to select an audio source for the Virtual Transmitter.
USB	Use the drop-down menu to select a USB source for the Virtual Transmitter.
Serial	Use the drop-down menu to select a serial source for the Virtual Transmitter.
Apply	Click Apply to save the changes.
Cancel	Click Cancel to exit without saving.

Intelligent Dual Video Output Management

For the A models (KE6900A, KE6940A), the *Intelligent Dual Video Output Management* feature allows the separation of a Dual Display Transmitter's (KE6940AT) video outputs (DVI:1 and DVI:2) as two separate Virtual Transmitters. These separated outputs can be accessed from different Receivers (KE6900AR or KE6940AR). Receivers can switch between and connect to both Virtual Transmitters independently with the *Access Type* determining which Receiver has control (see page 197).

To use this setup, install the KE devices as shown below and create two Virtual Transmitters, selecting **DVI:1** and **DVI:2** as the *KVM* source for each Virtual Transmitter.

For non-A model receivers (e.g. KE6910R, KE6912R), you can select between DVI:1 or DVI:2, but you will always be getting video output from DVI:1.

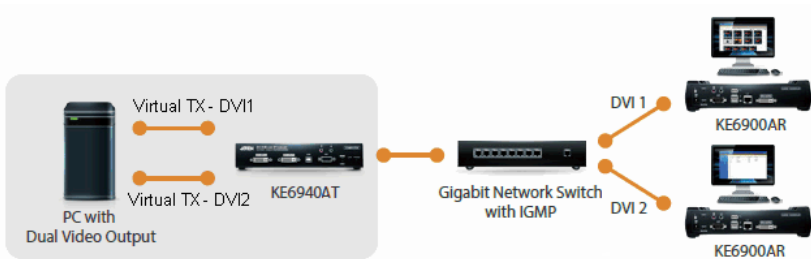

When connecting to either of the two Virtual Transmitters in the setup shown above, the mouse cursor may reside on the **main** or **extended** dual display screen, out of view. Therefore even if you have control of the mouse it may not be visible. To bring the mouse cursor into view on either of the dual display screens, first enable Boundless Switching (see *Boundless Switching*, page 209) and then use the hotkey **F8+F9**.

Transmitter Group

Creating a *Transmitter Group* allows you to create a connection that sources the video from multiple Transmitters to view at across multiple Receiver displays. To use this feature, connect a **Transmitter Group** to a **Receiver Group** (page 206). Transmitter Groups appear at the bottom of the *Transmitter* settings page.

To create a Transmitter Group, in *Transmitter* settings click  and then select **Create TX Group**.

Create TX Group

Name | Description | Location Unallocated

Please select physical transmitter...

KE6940T67
KE6940T



KE6940T1
KE6940T



KE6900ST
KE6900ST



KE8950T61
KE8950T



CANCEL
SAVE

Fill in the appropriate information and then double-click or drag-and-drop Transmitters to add or remove them in the top panel. The Transmitters in the top panel will be used as the video source for the Receiver Group at the Receiver.

Item	Description
Name	Enter a name for the Transmitter Group.
Description	Enter a description for the Transmitter Group.
Location	Use the drop-down menu to select a location for the Transmitter Group or leave it Unallocated. See <i>Location</i> , page 186, for details.
Save	Click Save to save the changes.
Cancel	Click Cancel to exit without saving.

Note: You can create up to 4 transmitter groups.

Transmitter Permissions

Transmitter Permissions sets the users and groups that can access a **Transmitter**, **Virtual Transmitter**, and **Transmitter Group**.

Select a device under **Transmitter List**, and then next to each user or group click *All*, *View*, *Occupy*, or *Exclusive* to grant them permission to connect to the Transmitter with this access type. A green block denotes that the user has access.

To set Transmitter Permissions, in *Transmitter* settings, click  .

Set Transmitter Permissions

Transmitter List		Select All Unselect All	Select All Unselect All	Select All Unselect All	Select All Unselect All
GroupTX	User	<input checked="" type="checkbox"/> All	<input checked="" type="checkbox"/> View	<input checked="" type="checkbox"/> Occupy	<input checked="" type="checkbox"/> Exclusive
GroupTX1					
VirtualTX	testtest1				
TransMil2	Harry				
KE6940T67					
KE6940T1					
KE6900ST					
KE8950T61					

■ Group Inherited
 ■ Permission Granted
 No Permission
 CANCEL APPLY

Item	Description
Transmitter List	Lists Transmitters, Virtual Transmitters and Transmitter Groups that can be selected to set permissions.
Drop-Down Menu	Use the drop-down menu to select User or Group . After making a selection, the list of users or groups appears. Set permissions by selecting the access type (All, View, Occupy, Exclusive) next to each user or group.
Access Type	<p>Select the access you want to grant to a user or group by clicking under the heading(s). This defines how the Transmitter can be accessed by a user or group. The access type will appear available for the user in the Receiver's OSD Connections menu. To disable an access type, uncheck a box in the heading.</p> <p>All: User has full control and can simultaneously share control of the Transmitter. Input from the users is placed in a queue and executed chronologically.</p> <p>View: User can only view the remote screen, and cannot perform operations on it.</p> <p>Occupy: The first user to access the Transmitter has control. However, additional users may view the Transmitter's video. If the user who controls the Transmitter is inactive for longer than the time set in the Transmitter's Timeout box, control is transferred to the first user to move the mouse or strike the keyboard.</p>





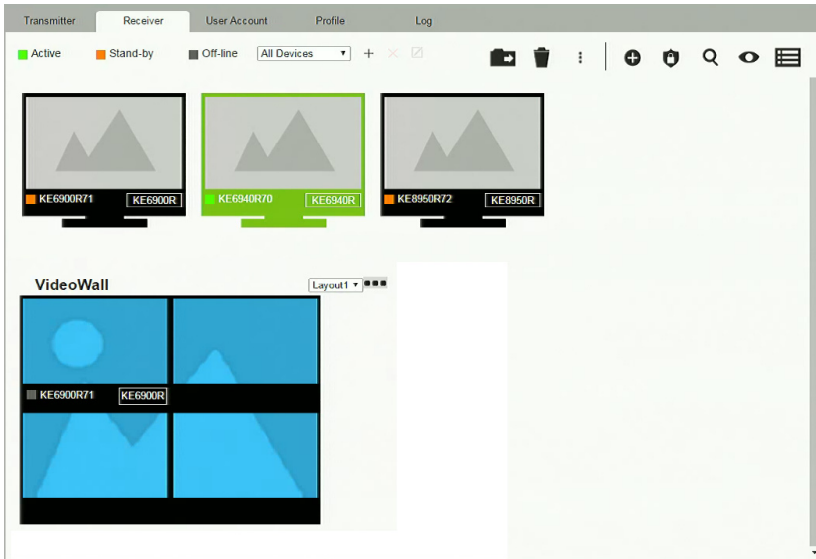

Item	Description
Access Type	Exclusive: The first user to access the Transmitter has exclusive control over the Transmitter. No other users can view the Transmitter. The Timeout function does not apply when Transmitters are accessed with this setting.
Apply	Click Apply to save the changes.
Cancel	Click Cancel to exit without saving.



Receiver

Click **Receiver** in the *System Status* panel to open the settings. The Receiver page allows you to add, delete and configure *Receivers* (physical receivers), *Receiver Groups*, and *Video Walls*. The KE Matrix Manager automatically adds Receivers connected to the local area network with a valid IP address.







The meanings of the icons and headings on the page are straightforward and let you view and configure Receivers.

- ◆  *Active* refers to a Receiver connection that is online and in use.
- ◆  *Standby* refers to a Receiver connection that is online.
- ◆  *Offline* refers to a Receiver connection that is offline.
- ◆  **All Devices** Use this drop-down menu to filter Receivers by location. Use Locations to limit the Receivers seen on the page.
 - ◆  Click to add a new **Location**.
 - ◆  Select a Receiver and click the **Move to** icon to add devices to a Location.
 - ◆  Select a Location from the drop-down menu and click this icon to delete it.

- ◆  Select a Location and click this icon to change the name.
- ◆  Click to delete selected Receivers.
- ◆  Click an option to have selected Receivers:
 - ◆ **Copy & Paste:** Copy settings from one Receiver and paste them to another (see *Copy & Paste*, page 205).
 - ◆ **Beeper:** Sound a Beep.
 - ◆ **Reboot:** Shut down and restart.
 - ◆ **Reset to Factory:** Reset all setting to the factory default.

Note: The Reset to Factory function resets everything but the login information to the factory default settings. To reset the login information, refer to *Reset All Information* on page 329.

- ◆  Click to *Create Receiver Group* or *Video Wall* (page 206 & 207).
- ◆  Click to set Receiver permissions (page 210).
- ◆  Click to search for Receivers.
- ◆  Click to filter Receivers shown on the page.
- ◆  Click to switch between *Grid View* and *List View*.

Receiver Configuration

When the KE Matrix Manager discovers Receivers on the network they appear on the *Receiver* settings page. Double-click a Transmitter to configure its settings.

Replace device **Receiver Configuration**

<p>Basic</p> <p>Device Name: <input type="text" value="KE8950R72"/></p> <p>Description: <input type="text"/></p> <p>Location: <input type="text" value="Unallocated"/></p> <p>Mode: <input type="radio"/> Extender <input checked="" type="radio"/> Matrix</p> <p>Enable Media: <input checked="" type="checkbox"/> Video <input checked="" type="checkbox"/> Audio <input checked="" type="checkbox"/> USB <input checked="" type="checkbox"/> RS232</p> <p>Audio Output: <input type="radio"/> HDMI <input type="radio"/> Analog <input checked="" type="radio"/> Both</p> <p>CCRM IP: <input type="text" value="192.168.0.12"/> <input type="text" value="9110"/></p> <p>IP Installer: <input checked="" type="radio"/> Enable <input type="radio"/> Disable <input type="radio"/> View Only</p>	<p>Extender Properties</p> <p>Transmitter Video IP: <input type="text" value="192.168.0.61"/></p> <p>Transmitter Audio IP: <input type="text" value="192.168.0.61"/></p> <p>Transmitter USB IP: <input type="text" value="192.168.0.61"/></p> <p>Transmitter RS232 IP: <input type="text" value="192.168.0.61"/></p>
<p>RS232 Settings</p> <p>Baud Rate: <input type="text" value="9600"/></p> <p>Parity: <input type="text" value="None"/></p> <p>Data Bits: <input type="text" value="8"/></p> <p>Stop Bits: <input type="text" value="1"/></p> <p>Flow Control: <input type="text" value="None"/></p>	<p>IP Settings</p> <p><input type="radio"/> DHCP</p> <p><input checked="" type="radio"/> Manual</p> <p>IP Address: <input type="text" value="192.168.0.70"/></p> <p>Mask: <input type="text" value="255.255.255.0"/></p> <p>Gateway: <input type="text" value="192.168.0.254"/></p>
	<p>Password Protection</p> <p><input type="radio"/> Disable</p> <p><input checked="" type="radio"/> Enable</p> <p>Password: <input type="text" value="*****"/></p> <p>Confirm: <input type="text" value="*****"/></p>
	<p>USB Mode</p> <p>Mode: <input type="radio"/> Virtual Media</p> <p><input checked="" type="radio"/> Generic USB Device</p> <p>Encryption: <input type="checkbox"/> Enable</p>

CANCEL
SAVE

Item	Description
Basic	<p>Device Name: Enter a name for the Receiver.</p> <p>Description: Enter a description for the Receiver.</p> <p>Location: Use the drop-down menu to select a Location for the device. Locations help organize how you view Receivers on the settings page.</p> <p>Mode: Use the radio button to select how the Receivers will be installed and managed:</p> <ul style="list-style-type: none"> ◆ Select Extender mode for simple one-to-one (Transmitter to Receiver) setups that are managed with the Receiver's OSD menu. ◆ Select Matrix mode to manage devices and connections over the LAN from the KE Matrix Manager software. This mode is for advanced administration of Transmitter and Receiver connections configured within the KE Matrix Manager Web GUI. <p>Enable Media: Select which source type the Receiver can stream: Video, Audio, USB and RS232.</p> <p>Audio Output: Use this option to independently stream <i>HDMI</i>, <i>Analog</i>, or <i>Both</i> audio signals to digital or analog audio output devices (speakers) connected to the Receiver.*</p> <p>CCKM IP: Set the IP address and Port number of the computer running the KE Matrix Manager software. The default port number is 9110.</p> <p>IP Installer: The IP Installer is an external Windows-based utility for assigning an IP address to the device. Click a radio button to select Enable, Disable or View Only for the IP Installer utility. See <i>IP Installer</i>, page 326 for instructions.</p> <p>Note: The <i>Audio Output</i> option is only available on KE devices with HDMI capabilities.</p>
RS232 Settings	<p>Configure the serial device settings for the Transmitter. The default settings are:</p> <p>Baud Rate: 9600</p> <p>Parity: None</p> <p>Data Bits: 8 bits</p> <p>Stop bits: 1 bit</p> <p>Flow Control: None</p>
Extender Properties	<p>If you selected Extender mode (under Basic) set the Transmitter IP address for the Receiver's Video, Audio, USB, and RS232 source.</p> <p>If you selected Matrix mode (under Basic) the <i>Properties</i> will be grayed out. Use Transmitters, Virtual Transmitters, and Transmitter Groups to configure the connections (see <i>Transmitter</i>, page 186).</p>

Item	Description
IP Settings	<p>For dynamic IP address assignment, select the DHCP radio button.</p> <p>To specify a fixed IP Address, Subnet Mask, and Default Gateway select the Manual radio button and fill in the fields with values appropriate for your network.</p> <p>For information to configure the network settings locally on the device, see <i>Network Configuration</i>, page 125.</p>
Password Protection	<p>Select Enable to require a password to access the Receiver's OSD configuration screen (see page 130).</p> <p>Enter a <i>Password</i>, and confirm the password in the <i>Confirm</i> box.</p>
USB Mode	<p>Select the type of USB device you will connect to the USB ports:</p> <p>Virtual Media: Select this option only if you are plugging a USB disk drive (including USB HDD/optical disk) into the USB ports. This will give you the highest data transfer speeds but will not allow other USB devices to work when plugged into the USB ports. When Receivers connected to the same transmitter mount or unmount USB disk drives, the keyboard and mouse operations will experience a brief delay. Transmitters can support up to 12 virtual media connections at the same time (keyboard/mouse included).</p> <p>vUSB (Generic USB device): Use this option to plug USB peripherals* into the USB ports. This option also allows a keyboard and mouse with special functions to plug into the USB ports for console use. Use this only if the special functions of the keyboard or mouse are required but do not work when plugged into the console ports. When the keyboard and mouse are plugged into the USB ports, they will not work within the OSD menus. To work within the OSD menus, the keyboard and mouse must be plugged into the console ports. KE6900ST/KE8900ST/KE9900ST transmitters do not support the Generic USB Device mode. In this mode, KE6900/KE6940 transmitters supports up to 2 USB connections; and KE8950/KE8952 transmitters support up to 5 USB connections (keyboard/mouse excluded).</p> <p>Encryption: Check this box to encrypt USB disk drives plugged into the USB ports.</p> <p>Note: This USB port does not support isochronous endpoints, therefore USB peripherals that stream audio or video data, such as speakers or webcams, will not work.</p>

Item	Description
Replace Device	<p>Click Replace Device in the top left corner to replace an old Receiver with a new one.* All settings are copied from the old Receiver to the new Receiver. Before using this feature, connect the new Receiver to the network. After clicking <i>Replace Device</i>, use the drop-down menu to select the new Receiver where the settings will be applied.</p> <p>Note:</p> <ol style="list-style-type: none">1. This option only appears when a Transmitter is offline.2. This feature can be used for both Receivers and Transmitters. Replacement should be carried out on a similar model.
Save	Click Save to save changes to the properties.
Cancel	Click Cancel to exit without saving.

Copy & Paste

Copy & Paste allows you to copy settings from one Receiver and paste them to another. To copy Receiver settings to another device, do the following:

1. Select a Physical Receiver.
2. On the Receiver menu bar, click **Copy & Paste** (page 200).
3. Check the boxes of the settings you want to copy, and click **Next**.

Copy & Paste

1. Please select the items you want to copy.

Select All

Unselect All

Basic

- Description
- Location
- Mode
- Enable Media
- CCKM IP
- IP Installer

USB Mode

- Mode
- Encryption

RS232 Settings

- Baud Rate
- Parity
- Data Bits
- Stop Bits
- Flow Control

Extender Properties

- Transmitter Video IP
- Transmitter Audio IP
- Transmitter USB IP
- Transmitter RS232 IP

CANCEL
NEXT

4. Select the Receiver(s) where you want to apply the settings, and click **Done**.

Copy & Paste

2. Please select the targets you want to paste.

Select All

Unselect All

KE6940R62
 KE8950R94

PREVIOUS
DONE

Receiver Group

Creating a *Receiver Group* allows you to connect the video from multiple transmitters to multiple Receiver displays. To use this feature, connect a **Transmitter Group** (page 196) to a **Receiver Group** (see *Instant Link*, page 176). Receiver Groups appear at the bottom of the *Receiver* settings page.

To create a Receiver Group, in *Receiver* settings, click  and then select **Create RX Group**.

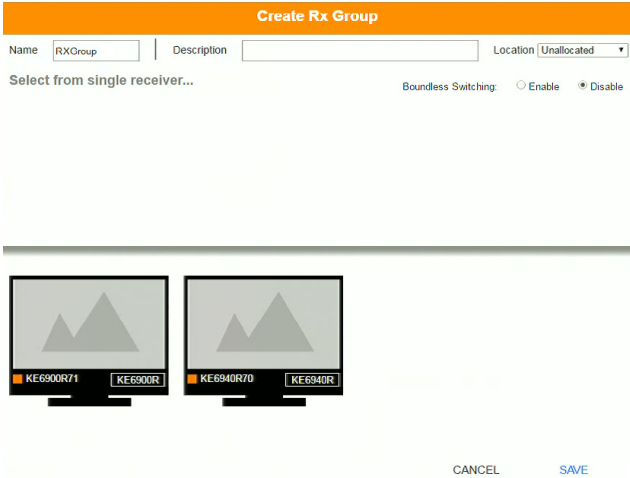

Fill in the appropriate information and then double-click or drag-and-drop Receivers to add or remove them in the top panel. The Receivers in the top panel will be used to view the video from the Transmitter Group. To connect a Transmitter Group to a Receiver Group, see *Instant Link*, page 176.

Item	Description
Name	Enter a name for the Receiver Group.
Description	Enter a description for the Receiver Group.
Location	Use the drop-down menu to select a location for the Receiver Group or leave it Unallocated. See <i>Location</i> , page 186, for details.
Boundless Switching	Use the radio button to enable or disable Boundless Switching. See <i>Boundless Switching</i> , page 209 for details.
Save	Click Save to save the changes.
Cancel	Click Cancel to exit without saving.

Note: You can create up to 4 receiver groups.

Video Wall

Creating a *Video Wall* allows you to create connections that combine Receiver displays to form a large video wall. Use the options to group multiple Receivers in the video wall. A video wall can contain multiple forms of single displays and grouped displays in various layouts. Video Walls appear listed below Receivers, on the *Receivers* settings page.



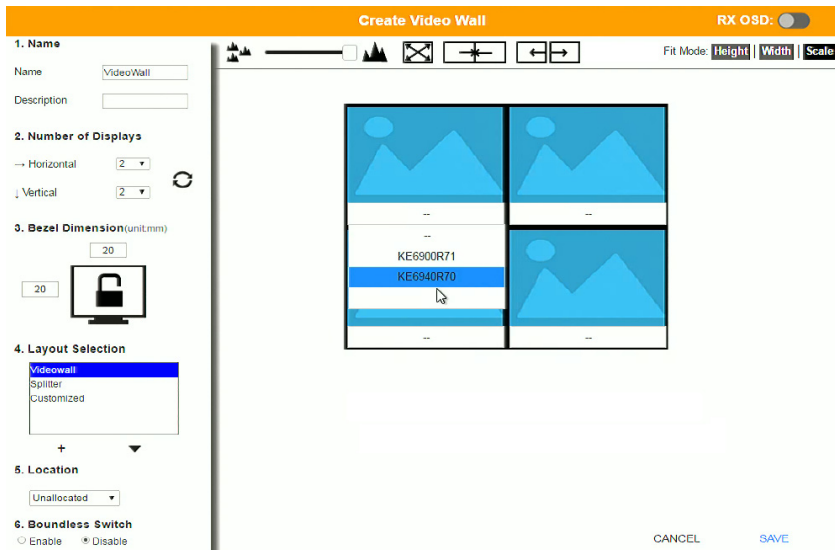

To create a Video Wall, in *Receiver* settings, click  and then select **Create Video Wall**.



Select the number of displays and then group multiple displays to form large screens and/or use single displays for independent screens to create the video wall's layout. Click the bar -- under the display icon to select a Receiver for each display. This configuration should match the actual video wall layout.

Item	Description
Name	Enter a name for the Video Wall.
Description	Enter a description for the Video Wall.
Number of Displays	Use the Horizontal and Vertical drop-down menus to select the number of displays that make up the video wall (a maximum of 64 are supported). Match this to the physical layout of the displays. Click the refresh icon to update the layout.

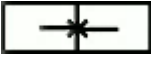
Item	Description
Bezel Dimension	Use the two boxes to increase/decrease the frame size of each active display.
Lock / Unlock 	Click the monitor to Lock the (2) bezel settings, so that when one size is changed they all change. Click the monitor to Unlock the (2) bezel settings, so that each size can be set independently.
Layout Selection	Click + or X to add or remove additional layouts to the Video Wall. The options listed here will appear in a drop-down menu for the Video Wall, allowing you to quickly choose different layouts from the Receiver settings page. Arrows below the Layout Selection box allow you to move up or down in the list. Three layout templates are available for quick setup. The Videowall and Splitter options can not be changed but allow you to select the Receivers. These three layouts can not be deleted. <ul style="list-style-type: none"> ◆ <i>Video Wall</i> provides a basic full screen layout where one Transmitter connects to multiple Receivers to display the video together as one full screen. ◆ <i>Splitter</i> provides a layout that connects a Transmitter to multiple Receivers that show the same video displayed on separate screens independently. ◆ <i>Customized</i> provides a basic full screen layout that can be configured into groups (see Group below) as desired.* <p>Note: When using the KE6940R in <i>Customized</i> layouts, only the KE6940's first video port will display video because each port's video source is independent. When using the KE6940R in <i>Video Wall</i> or <i>Splitter</i> layouts both video ports will display video.</p>
Location	Use the drop-down menu to select a location for the Video Wall or leave it Unallocated. See <i>Location</i> , page 186, for details.

Item	Description
Boundless Switching	<p>Enable this feature to allow you to switch KVM control between different receivers by moving the mouse cursor across screen boundaries. This option is disabled by default.</p> <p>When Boundless Switching is enabled, make sure to disable the following settings:</p> <ul style="list-style-type: none"> ◆ On the computer, under Control Panel - Mouse Properties - Pointer Options, uncheck Enhance pointer precision. ◆ On the CCKM Main page, click <i>Settings</i> (page 225), then on the <i>General</i> tab scroll down and disable Fast Switching. <p>Note:</p> <ul style="list-style-type: none"> ◆ Dual Display Transmitters can be set up as two independent Virtual Transmitters with Boundless Switching. The placement of the KE6940 setup must have DVI-1 as the main display on the left and DVI-2 as a secondary display on the right. ◆ Boundless Switching only supports single or dual video outputs from any one computer. ◆ If the mouse cursor disappears under a Linux operating system, execute this command: <i>gsettings set org.gnome.setting-daemon.plugins.cursor active false</i>
	Use the slide bar to zoom in or out for a better view of the Video Wall layout.
	Click this icon to reset the zoom back to full size.
	Select multiple display icons and click the Group button to group the displays into one screen.
	Select a group and click Ungroup to ungroup the displays.
Fit Mode	<p>Select how the video wall will be displayed:</p> <p>Height: Fits the video to the height of the display.</p> <p>Width: Fits the video to the width of the display.</p> <p>Scale: Fits the video on the entire display.</p>
	Use the RX OSD button to enable/disable showing the Receiver's name and IP address in the top left corner of the connected display. This helps identify which Receiver is connected to the display.
Save	Click Save to save the changes.
Cancel	Click Cancel to exit without saving.

Receiver Permissions

Receiver Permissions sets which users and groups can access a Receiver. Select a device under the **Receiver List**, and then click under Operation to grant a user or group permission to access the device. This will allow the user to login to the Receiver's OSD menu to access the Connections tab.

To set Receiver Permissions, in *Receiver* settings, click .

Set Receiver Permissions

Receiver List

- KE6900R71
- KE6940R70
- KE8950R72

User

Harry

Select All Unselect All

Operation

■ Group Inherited
 ■ Permission Granted
 No Permission

CANCEL
APPLY

Item	Description
Receiver List	Lists the Receivers which can be selected to set permissions.
Drop-Down Menu	Use the drop-down menu to select <i>User</i> or <i>Group</i> . After making a selection, the list of users or groups appears. Set permissions by selecting the Operation box next to each user or group.
Operation	Click the Operation box next to each user or group to apply access rights on the selected device. This gives users and groups permission to log in to the Receiver's OSD. If a user inherits its permissions from a group, the box will be Blue. To disable access rights for all users, uncheck the box in the heading.
Apply	Click Apply to save the changes.
Cancel	Click Cancel to exit without saving.

Account

Click **Users** in the *System Status* panel to open the settings. The *Account* page allows you to add, delete and configure users and groups. Instructions for adding users and groups is provide on page 212.

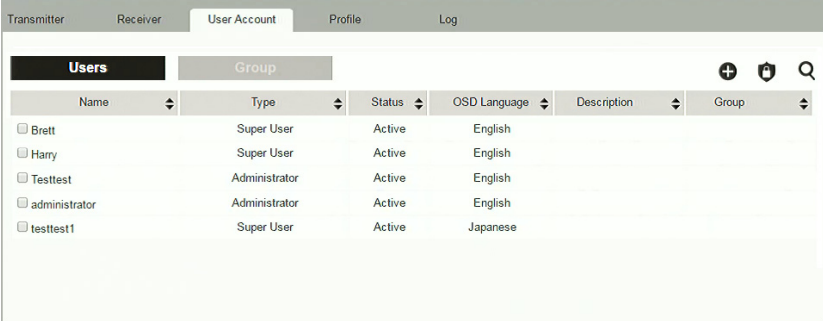

User Account						
Transmitter Receiver User Account Profile Log						
Users		Group				
Name	Type	Status	OSD Language	Description	Group	
<input type="checkbox"/> Brett	Super User	Active	English			
<input type="checkbox"/> Harry	Super User	Active	English			
<input type="checkbox"/> Testtest	Administrator	Active	English			
<input type="checkbox"/> administrator	Administrator	Active	English			
<input type="checkbox"/> testtest1	Super User	Active	Japanese			

- ◆ The Users and Group buttons appear at the top of the page.
 - ◆ Depending on the item selected, either Users or Groups are listed on the page.
- ◆ The sort order of the information displayed can be changed by clicking the column headings.
- ◆ Three icons in the right corner are used to add users, groups and set permissions, as explained in the sections that follow.

Users

The KE Matrix Manager supports three types of accounts, shown in the table below:

User Type	Role
Administrator	Access, push/pull and management of the KE Matrix Manager, including configuration and setting up of devices. Manage Users, Groups, Transmitters, Receivers, Profiles and Video Walls. Configure personal working environments.
Super User	Access and push/pull Receivers, Transmitters and Profiles they have been given permission for.
User	Access Receivers to connect to Transmitters they have been given permission for.

Adding Users

To add a user, do the following:

1. Click  on the menu bar.
2. Select **Add New User**. The *Add New User* window opens:

Add New User

Username Local User

Password

Confirm Password

Description

User Level Administrator
 Super User
 Users

Status Active
 Disable

OSD Language ▼

Toolbar Hotkey ▼

Logout Timeout min(1-180) Disable

Screen Blanker min(1-30) Disable

OSD Title Bar Duration sec(3-100) Disable

Welcome Message Enable Username

Group

CANCEL
SAVE

Enter the required information in the fields provided. A description of each is given in the table below:

Field	Description
Username	From 1 to 32 characters are allowed depending on the Account Policy settings.
Local User	Check the Local User box if the account is for logging in to the KE Matrix Manager software or a Receiver. Uncheck the Local User box if the account is authenticated with a 3rd party external source, such as RADIUS, LDAP/AD, or TACACS+. See ANMS, page 231 for details.
Password	From 6 to 32 characters are allowed depending on the Account Policy settings.
Confirm Password	To be sure there is no mistake in the password, you are asked to enter it again. The two entries must match.
Description	Additional information about the user that you may wish to include.
User Level	There are three account categories: Administrator, Super User and User. <ul style="list-style-type: none"> ◆ The Administrators have full access to make changes within the KE Matrix Manager software, which includes adding and removing Transmitters, Receivers, accounts, preferences, and configuration settings. ◆ The Super Users have access to the Receiver's OSD menu and can connect Channels and Profiles. ◆ The Users can log in to Receivers to connect channels.
Status	Status allows you to control the user's account and access, as follows: <ul style="list-style-type: none"> ◆ <i>Active</i> provides the user with access and permissions as granted. ◆ <i>Disable</i> lets you suspend a user's account without actually deleting it, so that it can be easily reinstated in the future.
OSD Language	Click the drop-down menu to select the language you want to use during OSD sessions for this user. Options are: Chinese (Traditional), Simplified Chinese, Japanese, German, Korean, Russian, French, Spanish, and Portuguese.
Toolbar Hotkey	Select the hotkey combination to call the Tool Bar function for this user. The Tool Bar is used when accessing the computer from the Transmitter or Receiver side.
Logout Timeout	If there is no user input for the amount of time set with this function, the user is automatically logged out. A login is necessary before the KE Matrix Manager can be accessed again. The default is 30 minutes.
Screen Blanker	Set how many minutes the device waits when a session is idle before turning off the display.

Field	Description
OSD Title Bar Duration	This function is only supported by KE6910/KE6912. When the accessing a port, the top left-hand corner will show a title bar displaying the access mode and the device name. Select how long you wish the title bar is to be displayed for, or check Disable to not show any title bar.
Welcome Message	If you want the Welcome Message to appear on screen when the user logs into the KE Matrix Manager, select Enable . If you want the user's Screen Name to appear with the Welcome Message, check the Username check box.
Group	Click Select and check a box to add the user to a group.
Apply	Click Apply to save the changes.
Cancel	Click Cancel to exit without saving.

3. When your selections have been made click **Apply**.
4. When the *Operation Succeeded* message appears, click **OK**.
5. The new user appears on the main panel.
 - ♦ The columns show the Username; User Level, Status, OSD Language, Description; and Group.

Modifying Users

To modify a user, do the following:

1. In the main panel, double-click the user's name.
2. In the *Edit User* page that comes up, make your changes, then click **Apply**.

Deleting Users

To delete a user, do the following:

1. In the main panel, check the box next to the user's name.
2. Click  .
3. Click **OK**.

Groups

Groups allow administrators to easily and efficiently manage users and devices. Since device access rights apply to anyone who is a member of the group, administrators need only set them once for the group, instead of having to set them for each user individually. Multiple groups can be defined to allow some users access to specific devices, while restricting other users from accessing them. Device permissions are discussed on page 217.

Adding Groups

To create a group, do the following:

1. Click *Group* on the Account page.
2. Click  and then select **Add New Group**. The *Add New Group* window opens:

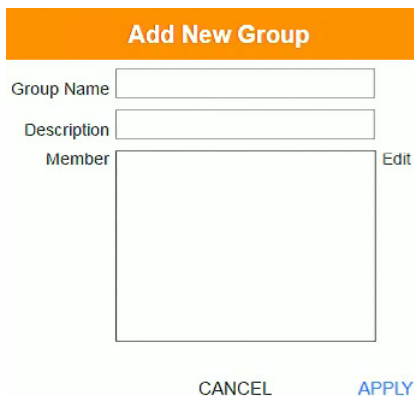

3. Enter the required information in the appropriate fields. A description of each of the fields is given in the table below:

Field	Description
Group Name	A maximum of 32 characters is allowed.
Description	Additional information about the user that you may wish to include. A maximum of 32 characters is allowed.
Member	Lists the users that are currently in the group. To add users, click the Edit button.

4. At this point you can assign users to the group by clicking **Edit**.
5. When your selections have been made click **Apply**.

6. When the *Operation Succeeded* message appears, click **OK**.
7. The new group appears in the main panel.
 - ◆ The columns show the Group Name, Description and Members that are in the group.

Repeat the above procedure to add additional groups.

Modifying Groups

To modify a group, do the following:

1. In the main panel, double-click the group's name.
2. Make your changes, then click **Apply**.

Deleting Groups

To delete a group, do the following:

1. In the main panel, check the box next to the group's name.
2. Click  .
3. Click **OK**.

Permissions

You can assign Transmitter, Receiver and Profile permissions for users and groups from the *Account* page.

Assigning Device Permissions

To assign permissions for a user or group from the *Account* page, do the following:

1. Click  on the menu bar. The *Set User Permissions* window opens:

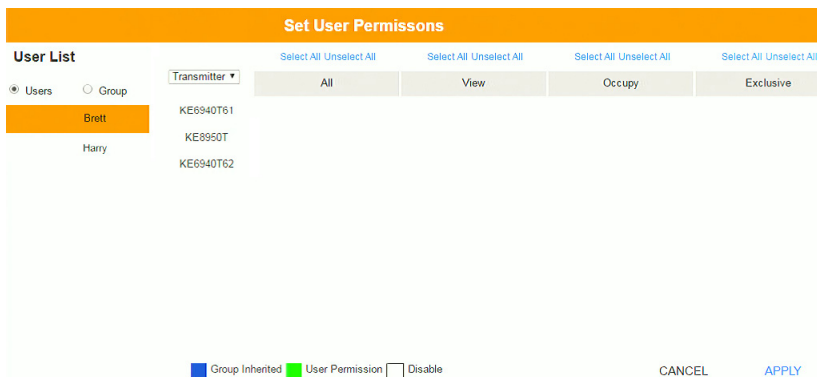

2. To set the permissions, select a user or group, then a device and select the Access Type under each column so that it turns green. Make your permission settings for each user or group on each device according to the information provided below:

Item	Description
User List	Use the radio button to view the Users or Group list. Click a user or group to configure their permissions.
Drop-Down Menu	Use the drop-down menu to select <i>Transmitter</i> , <i>Receiver</i> or <i>Profile</i> . After making a selection, a list of devices or profiles appears. Set permissions by selecting the access type (All, View, Occupy, Exclusive) next to the device.

Item	Description
Access Type	<p>Select the access you want to grant to a user or group by clicking under the heading(s) next to each device. This defines how the device can be accessed by the user or group. When granted, the access types (All, View, Occupy, Exclusive) for Transmitters will appear available for the user in the Receiver's OSD Connection page (see page 148).</p> <p>All: User has full control and can simultaneously share control of the Transmitter. Input from the users is placed in a queue and executed chronologically.</p> <p>View: User can only view the remote screen, and cannot perform operations on it.</p> <p>Occupy: The first user to access the Transmitter has control. However, additional users may view the Transmitter's video. If the user who controls the Transmitter is inactive for longer than the time set in the Transmitter's Timeout box, control is transferred to the first user to move the mouse or strike the keyboard.</p> <p>Exclusive: The first user to access the Transmitter has exclusive control over the Transmitter. No other users can view the Transmitter. The Timeout function does not apply when Transmitters are accessed with this setting.</p> <p>Operation (Receiver and Profile): The <i>Operation</i> access type for Receivers allows users to log into Receivers, and for Profiles allows a user to connect the Profile from a Receiver.</p>
Apply	Click Apply to save the changes.
Cancel	Click Cancel to exit without saving.







3. When you have finished making your choices, click **Apply**.
4. In the confirmation popup that appears, click **OK**.

Profile

Click **Profile** in the *System Status* panel to open the settings. The *Profile* page allows you to create, run and schedule connection profiles. Profiles channel specific Receiver to Transmitter connections and can be instantly connected from the Profile page at anytime. Profiles can be also scheduled to run automatically at specific times.

Name	Description	Access Mode	Login Check	Lock OSD
<input checked="" type="checkbox"/> Profile1		Share	No	No
<input type="checkbox"/> Profile2		Share	No	No
<input type="checkbox"/> Profile3		Share	No	No

The meanings of the icons and headings on the page are straightforward and let you view and configure Profiles.

- ◆  Click to connect the selected Profile.
- ◆  Click to disconnect the selected Profile.
- ◆  Click to delete the selected Profile.
- ◆  Click to *Create Profile* or *Create Schedule* (page 220 & 223).
- ◆  Click and enter text to search for a Profile.
- ◆ Check the box next to a **Profile** and click the *Connect* or *Disconnect* icon to start/stop profile connections. Check the box next to a **Schedule** and click the *Enable* or *Disable* icon to enable/disable a schedule.
- ◆  Appears on the *Schedule* page, click to enable the selected schedule.
- ◆  Appears on the *Schedule* page, click to disable the selected schedule.

Adding a Profile



Creating a Profile allows you to quickly connect single or multiple Receiver to Transmitter connections.

To add a Profile, do the following:

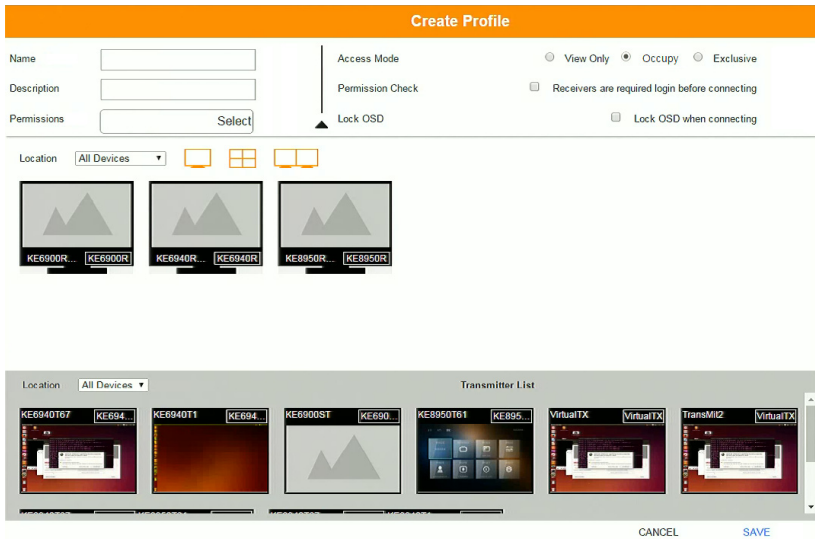

1. On the *Profile* page click  and then select **Create Profile**. The *Create Profile* window appears:



Item	Description
Name	Enter a name for the Profile.
Description	Enter a description for the Profile.
Permissions	Click Select and check the box of the users / groups you want to allow to connect this Profile. When the user logs into a Receiver, the profile will appear listed in the OSD menu on the Profile page (see page 153), allowing them to connect it.

Item	Description
Access Mode	<p>This defines how the Transmitter in a Profile can be accessed by Receivers when multiple users attempt to access it.</p> <p>View Only: Receivers only have view access to the Transmitter's video display.</p> <p>Occupy: Set a time threshold for Receivers whose Access Mode has been set to Occupy. If there is no activity from the Receiver occupying the port for the amount of time set here, the Receiver is timed out and the port is released. The first Receiver to send keyboard or mouse input after the port has been released gets to occupy the port. Input a value from 1 to 240 seconds.</p> <p>Exclusive: The first Receiver to access the Transmitter has exclusive control over the Transmitter. No other users can view the Transmitter. The Timeout function does not apply to Transmitters which have this setting.</p>
Login Check	<p>Check this box to require a user to be logged in to the Receiver before a Profile can connect it to a Transmitter. When enabled, a user must be logged into the Receiver or it will not connect to the Transmitter when the Profile is initiated.</p>
Lock OSD	<p>Checking this box will lock the Receiver's OSD screen when the Profile connects it to a Transmitter.</p>
Location	<p>Use the drop-down menu to select a location to filter the Receivers displayed on the page.</p>
	<p>Click this icon to show individual Receivers.</p>
	<p>Click this icon to show only video wall Receivers.</p>
	<p>Click this icon to show only Receiver Group Receivers.</p>
Save	<p>Click to save the changes.</p>
Cancel	<p>Click to exit without saving.</p>

- After filling in the information, click a Receiver, select **Select TX** and use the drop-down menu select a Transmitter; or use *Transmitter List* at the bottom of the page to drag-and-drop Transmitters to Receivers to create the connection.
- After configuring the connections, click **Save**. The new Profile appears on the *Profile* page.

4. To connect Profiles, check the box of the Profile(s) you want to connect, and click  .
5. To disconnect Profiles, click  .

Adding a Schedule

Creating a Schedule allows you to connect Profiles at specific dates, times and intervals.

To add a Schedule, do the following:

1. On the *Profile* page click **Schedule**.
2. Click **+** and then select **Create Schedule**. The *Create Schedule* window appears:

Create Schedule

Profile Select Profile ▾

Frequency Once ▾

Start Date 2018/2/15 

End Date 2018/2/15 

Start Time AM ▾ 00 : 00 Disable

End Time AM ▾ 00 : 00 Disable

CANCEL
SAVE

Item	Description
Profile	Use the drop-down menu to select a Profile to schedule.
Frequency	Use the drop-down menu to select how often the Profile should run: Once, Daily, Weekly and Monthly. When you select Weekly/Monthly an additional drop-down menu appears to select the <i>Week Day/Month Day</i> on which the profile will run.
Start Date	Enter the date on which you want the schedule to begin running.
End Date	Enter the date on which you want the schedule to stop running.
Start Time	Enter the time of day that you want the profile to connect.
End Time	Enter the time of day that you want the profile to disconnect.
Every	If you select Daily, Monthly or Weekly, the <i>Every</i> option appears allowing you to enter how often you want the schedule to run. For example, enter 3 months if you want the profile to run once every three months. If you want to run the schedule once a day, once a week or once a month, use the default entry of 1.

3. After the schedule is configured, click **Save**.

Log

Click **Log** in the *System Status* panel to open the settings. The *Log* page lists events that take place and provides a breakdown of the time, user, severity, device, and log information. You can change the sort order of the display by clicking on the column headings.

Transmitter	Receiver	Account	Profile	Log
All logs				
All Severity	All Device	All User	Time	Log Information
Information			2017/08/24 10:20:16	Session terminated normally(Sessionid=*****bam0).
Information		Brett	2017/08/24 10:20:16	User logout(username=Brett).
Information			2017/08/24 09:46:37	Session created(Sessionid=*****bam0) from ip 192.168.0.71.
Information		Brett	2017/08/24 09:46:37	User login succeeded(username=Brett).
Information		Brett	2017/08/23 22:51:14	User logout(username=Brett).
Information			2017/08/23 22:51:14	Session terminated normally(Sessionid=*****5vnc).
Information	KF694DR70	administrator	2017/08/23 22:33:08	Connection VIAJIS to channel KF694DR70[1001074BD0123000] established
Warning			2017/08/23 22:21:07	Session killed(Sessionid=*****amp0).
Information			2017/08/23 22:21:07	Session created(Sessionid=*****5vnc) from ip 192.168.0.71.
Information		Brett	2017/08/23 22:21:07	User login succeeded(username=Brett).
Information			2017/08/23 22:21:07	Session created(Sessionid=*****amp0) from ip 192.168.0.71.
Information		Brett	2017/08/23 22:21:07	User login succeeded(username=Brett).
Information			2017/08/23 22:15:36	Session created(Sessionid=*****ts26) from ip 192.168.0.70.
Information		administrator	2017/08/23 22:15:36	User login succeeded(username=administrator)

- Click the drop-down menu beside a heading to filter events into subcategories. Selecting a subcategory allows you to view only the logs that relate to the choice. The meanings of the headings at the top of the page are straightforward:
 - All Severity* refers to the event's severity type: Information, Error, or Warning
 - All Device* refers to the Transmitter or Receiver that relates to the event. If no device is listed the event refers to the KE Matrix Manager software.
 - All User* refers to the username that the event relates to. If no username appears, the event is general system information.
 - Time* refers to the date and time that the event occurred.
 - Log Information* provides detailed information about each event.
- Click to delete the logs currently displayed in the list.
- Click and enter text to search for an event log.
- Click to save the log contents to a file on your computer.
- Click to open a pop-up window that allows you to set how many days or the number of records to record before over-writing old log files. Use the radio button to select *By Period (Days)* or *By Records* and enter the number to use before overwriting the oldest log files.

Chapter 7

System Settings

Overview

The *System Settings* are accessed by clicking  from the **System Status** page (see *System Status*, page 183). There are 7 tabs to configure the KE Manager system settings: *General*, *ANMS*, *FW Upgrade*, *Redundancy*, *Backup/Restore*, *Certificates*, and *Sessions*.

General

Clicking  from the system status page opens the *General* tab, as shown below:

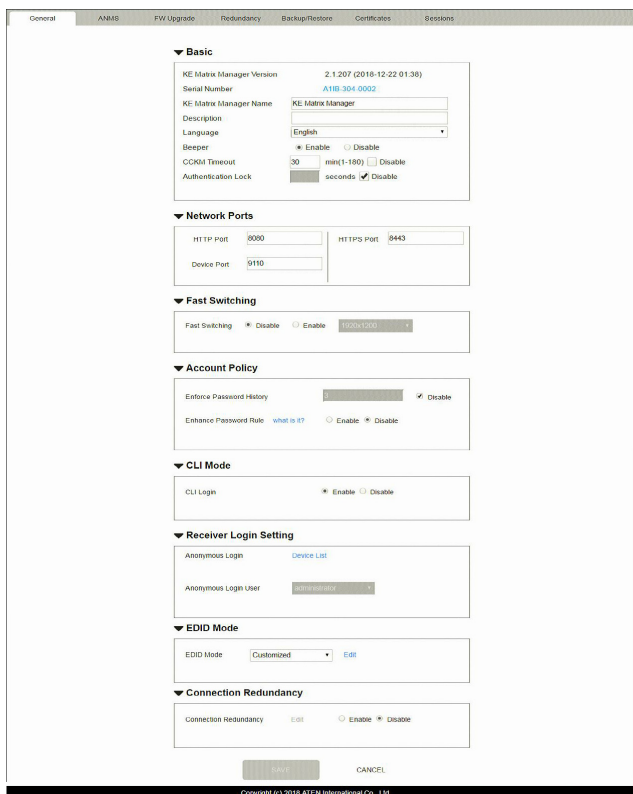

The screenshot shows the 'General' tab of the System Settings interface. The tabs at the top are: General, ANMS, FW Upgrade, Redundancy, Backup/Restore, Certificates, and Sessions. The 'Basic' section includes: KE Matrix Manager Version (2.1.207 (2018-12-22 01:38)), Serial Number (AT18-304-0002), KE Matrix Manager Name (KE Matrix Manager), Description (empty), Language (English), Beeper (Enable selected), CCKM Timeout (30 min(1-180) seconds), and Authentication Lock (seconds selected). The 'Network Ports' section includes: HTTP Port (8080), HTTPS Port (8443), and Device Port (9110). The 'Fast Switching' section includes: Fast Switching (Disable selected). The 'Account Policy' section includes: Enforce Password History (checked) and Enhance Password Rule (what is it? selected). The 'CLI Mode' section includes: CLI Login (Enable selected). The 'Receiver Login Setting' section includes: Anonymous Login (Device List) and Anonymous Login User (admin@ke-matrix.com). The 'EDID Mode' section includes: EDID Mode (Customized). The 'Connection Redundancy' section includes: Connection Redundancy (Enable selected). At the bottom, there are buttons for 'SAVE' and 'CANCEL', and a copyright notice: Copyright (c) 2018 AT&T Intellectual Co., Ltd.

Heading	Item	Description
Basic	KE Manager Version	This provides the version of the KE Manager software.
	Serial Number	This provides the serial number and a link to upgrade the software.
	KE Manager Name	Enter a name for the KE Manager.
	Description	Enter a description for the KE Manager.
	Language	Select the language for the KE Manager. Choices are: English, Chinese (Traditional), Simplified Chinese, Japanese, German, Korean, Russian, French, Spanish, and Portuguese.
	Beeper	Select Enable to sound a beep from the Transmitter/Receiver every time a configuration change is made.
	CCKM Timeout	If there is no user input for the amount of time entered in the box, a user logged into the CCKM is automatically logged out. Check Disable to turn this function off.
	Authentication Lock	<p>This function is only supported by KE6910/KE6912. When accidental power cut happens, the function allows the user to retain his/her settings as was shown before the power cut. The user keeps the same authentication and display.</p> <ul style="list-style-type: none"> ◆ Uncheck Disable to turn this function on. ◆ Specify a time (in seconds) you wish to keep the authentication and display for. <p>When disabled or, if enabled, after the time specified above, the manager will prompt you to authenticate when you wish to access the KE Manager.</p>
Network Ports	HTTP Port	Sets the HTTP service port used to access the KE Manager. This is the port number to use for a browser login. The default is 8080.
	Device Port	Sets the Device service port used to access the KE Manager. Configure this port number on the Transmitter and Receiver to access to the KE Manager software (see <i>Manager Address</i> , page 142 and 134). The default is 9110.
	HTTPS Port	<p>Sets the HTTPS service port used to access the KE Manager. This is the port number to use for a secure browser login. The default is 8443.</p> <p>Example: To access the KE Manager with an IP address of 192.168.0.100 using a secure browser login, enter: <i>https://192.168.0.100:8443</i></p>

Heading	Item	Description
Fast Switching		<p>Select the default resolution to use so that you can switch faster when changing Receiver to Transmitter connections. If the monitor you are using does not support fast switching the video may not display correctly when this setting is enabled.</p> <p>Note: Make sure to disable Boundless Switching when Fast Switching is enabled.</p>
Account Policy	Enforce Password History	<p>This setting determines the number of unique new passwords that must be used before an old password can be reused. Uncheck the box and enter a number to enforce the password history policy.</p>
	Enhance Password Rule	<p>Select Enable to enforce rules for creating passwords, as follows:</p> <ul style="list-style-type: none"> ◆ The password length must be at least 8 characters. ◆ The password must contain both upper and lowercase characters. ◆ The password must contain a number (0 through 9). ◆ If a user types in the wrong password 5 times consecutively, their account will be locked out for 10 minutes.
CLI Mode	CLI Mode Login	<p>Use the radio button to Enable or Disable command line interface logins to the KE Manager.</p> <p>Warning: If <i>Disable</i> CLI Mode Login is selected, anybody can login via Telnet with administrator privileges without needing to authenticate, allowing control of the entire installation. For installations requiring a high level of security, it's recommended that <i>Enable</i> CLI Mode Login be applied.</p>
Receiver Login Settings	Anonymous Login	<p>Use this to anonymously login a user at select Receivers. This option allows users to access the Receiver and connect to Transmitters without needing to login.</p> <p>Click Device List to display the list and check the box next to the Receiver(s) to enable the <i>Anonymous Login</i> feature.</p>
	Anonymous Login User	<p>When <i>Anonymous Login</i> (above) is enabled for Receivers, select a user from the drop-down menu to use as the default account to anonymously login to the Receiver.</p>

Heading	Item	Description
EDID Mode	EDID Mode	Use this drop-down menu to set the default EDID mode for all Transmitters. To set a different EDID mode for each Transmitter, use the drop-down menu to select Customized and then click Edit . A Transmitter list will appear with drop-down menus to configure each device's EDID mode.
Connection Redundancy (KE6910 / 6912 only)		Use this drop-down menu to set connection redundancy function. You can setup priority connection with this function. Please refer to <i>Connection Redundancy (KE6910 / 6912 only)</i> on page 228.
Save		Click to save the changes.
Cancel		Click to cancel the changes.

Connection Redundancy (KE6910 / 6912 only)

You can setup priority connection for receivers. Where a transmitter fails, this function allows the receiver to connect to the transmitter of the highest priority that is available.

Follow the steps below to setup the priority list.

1. Click **Enable** to enable this function.
2. Click **Edit**. A window will pop-up to allow editing.

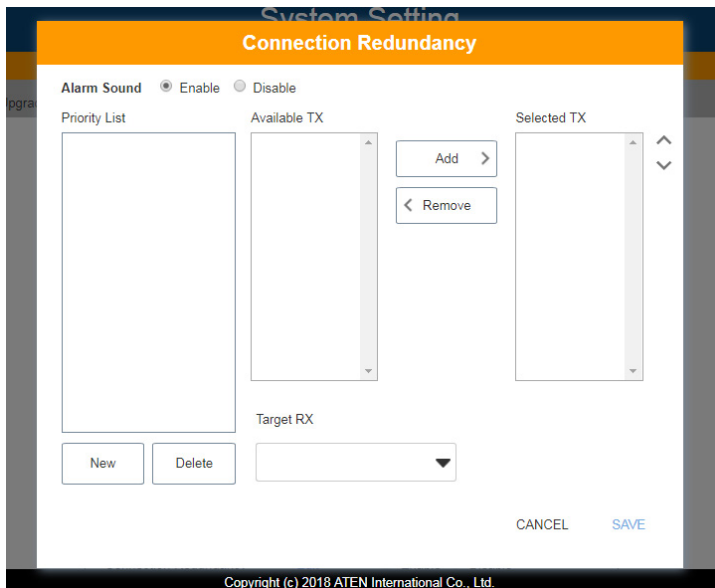

- For Alarm Sound, click **Enable**.

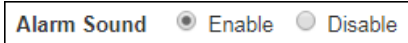

- To create a new list, click **New**. A Priority List 1 will be shown. (Click **New** again to create another list.)

 The screenshot shows a web interface titled "Connection Redundancy" with an orange header. At the top, there are radio buttons for "Alarm Sound" with "Enable" selected. Below this, there are three main sections: "Priority List", "Available TX", and "Selected TX". The "Priority List" section contains a list with "Priority List 1" selected. The "Available TX" section contains a list with "KE6910T1" and "KE6910T2". Between these two lists are "Add" and "Remove" buttons. The "Selected TX" section is currently empty. At the bottom left, there are "New" and "Delete" buttons. At the bottom right, there are "CANCEL" and "SAVE" buttons. A "Target RX" dropdown menu is located at the bottom center.

- Select the transmitters you wish to be in the list from the “Available TX” list and click **Add**. The added transmitter will be shifted to the “Selected TX” list.

 This screenshot is identical to the previous one, but the "Selected TX" list now contains "KE6910T2". The "Available TX" list now only contains "KE6910T1". The "Add" and "Remove" buttons are still present between the lists.

To deselect the transmitter, click to select the transmitter from the “Selected TX” list and click **Remove**. The transmitter will be shifted back to the “Available TX” list.

6. Select a target receiver by first clicking the drop-down menu “Target RX”, and select a receiver.

The screenshot shows the "Connection Redundancy" configuration window. At the top, there is an orange header with the title "Connection Redundancy". Below the header, there are two radio buttons for "Alarm Sound": "Enable" (selected) and "Disable".

The main area is divided into three columns:

- Priority List:** A list containing "Priority List 1", which is highlighted in blue. Below the list are "New" and "Delete" buttons.
- Available TX:** A list containing "KE6910T1".
- Selected TX:** A list containing "KE6910T2".

Between the "Available TX" and "Selected TX" lists, there are two buttons: "Add >" and "< Remove".

Below the "Selected TX" list, there is a "Target RX" label and a dropdown menu currently showing "KE6912R".

At the bottom right of the window, there are "CANCEL" and "SAVE" buttons.

7. Repeat steps 4-6 to add more priority lists.
8. Click **Save** to save the settings.

ANMS

The *ANMS* (Advanced Network Management Settings) tab is used to set up login authentication and authorization management from external sources. It is organized with two pages – each with a series of related panels, as described below.

Event Destination

The screenshot shows the configuration interface for the ANMS Event Destination. The top navigation bar includes tabs for General, ANMS, FW Upgrade, Redundancy, Backup/Restore, Certificates, and Sessions. The ANMS tab is active, and the 'Event Destination' sub-tab is selected. The 'Authentication & Authorization' section is expanded, showing two main settings panels: SMTP Settings and Syslog Settings.

SMTP Settings

- Enable report from the following SMTP Server
- Log Level: Information (dropdown)
- SMTP Server: [text input]
- SMTP Port: 25 (text input)
- Server requires authentication
 - Account Name: [text input]
 - Password: [text input]
- From: [text input]
- To: [text input]

Syslog Settings

- Enable
- Log Level: Information (dropdown)
- Server IP: [text input]
- Service Port: 514 (text input)

At the bottom of the form are two buttons: SAVE (in a blue box) and CANCEL.

◆ SMTP Settings

To have the KE Manager email reports from the SMTP server to you, do the following:

1. Enable the *Enable report from the following SMTP Server*, select the *Log Level* (Information, Warning, or Error), and key in the *SMTP Server* IP address and *SMTP Port*.
2. If your server requires authentication, check the *Server requires authentication* checkbox, and key in the appropriate information for the *Account Name* and *Password* fields.

3. Key in the email address of where the report is being sent from in the *From* field.

Note: 1. Only one email address is allowed in the *From* field, and it cannot exceed 64 Bytes.

2. 1 Byte = 1 English alphanumeric character.

4. Key in the email address (addresses) of where you want the SMTP reports sent to in the *To* field.

Note: If you are sending the report to more than one email address, separate the addresses with a semicolon. The total cannot exceed 256 Bytes.

5. Click **Save**.

◆ *Syslog Settings*

To record all the events that take place on the KE Manager and write them to a Syslog server, do the following:

1. Check **Enable**.
2. Use the drop-down menu to select the *Log Level* (Information, Warning, or Error).
3. Key in the *Server IP* address of the Syslog server.
4. Key in the *Service Port* number. The valid port range is 1-65535.
5. Click **Save**.

Authentication & Authorization

General	ANMS	FW Upgrade	Redundancy	Backup/Restore	Certificates	Sessions
Event Destination	Authentication & Authorization					
<input type="checkbox"/> Enable						
Preferred RADIUS Server		<input type="text"/>				
Preferred RADIUS Server Port		<input type="text" value="1812"/>				
Alternate RADIUS Server		<input type="text"/>				
Alternate RADIUS Server Port		<input type="text" value="1645"/>				
Timeout		<input type="text" value="3"/>				
Retries		<input type="text" value="3"/>				
Shared Secret (at least 6 characters)		<input type="text"/>				

◆ RADIUS Settings

To allow authentication and authorization through a RADIUS server, do the following:

1. Check **Enable**.
2. Fill in the IP addresses and service port of the *Preferred RADIUS Server* and *Alternate RADIUS Server*.
3. In the *Timeout* field, set the time in seconds that the KE Manager waits for a RADIUS server reply before it times out.
4. In the *Retries* field, set the number of allowed retries.
5. In the *Shared Secret* field, key in the character string that you want to use for authentication between the KE Manager and the RADIUS Server. A minimum of 6 characters is required.
6. On the RADIUS server, Users can be authenticated with any of the following methods:
 - ◆ Use the same Username on both the RADIUS server and the KE Manager.
 - ◆ Use the same Group name on both the RADIUS server and the KE Manager.
 - ◆ Use the same Username/Group name on both the RADIUS server and the KE Manager.

In each case, the user's access rights are the ones assigned that were assigned when the User or Group was created on the KE Manager.

◆ LDAP / AD Settings:

▼ LDAP / AD Settings

Enable

Enable SSL

Preferred LDAP Server

Preferred LDAP Server Port

Alternate LDAP Server

Alternate LDAP Server Port

Timeout

Admin DN

Admin Name

Password

Search DN

To allow authentication and authorization for the KE Manager via LDAP / AD, refer to the information in the table, below:

Item	Action
Enable	Put a check in the Enable checkbox to allow LDAP / AD authentication and authorization.
Enable SSL	Put a check in the Enable checkbox to allow SSL connections.
LDAP Server IP and Port	Fill in the IP address and port number for the LDAP / AD server. <ul style="list-style-type: none"> ◆ You can use the IPv4 address, the IPv6 address or the domain name in the LDAP Server field. ◆ For LDAP, the default port number is 389.
Timeout	Set the time in seconds that the KE Manager waits for an LDAP / AD server reply before it times out.
Admin DN	Consult the LDAP / AD administrator to ascertain the appropriate entry for this field. For example, the entry might look like this: ou=kn4132,dc=aten,dc=com
Admin Name	Key in the LDAP administrator's username.
Password	Key in the LDAP administrator's password.
Search DN	Set the distinguished name of the search base. This is the domain name where the search starts for user names.

On the LDAP / AD server, Users can be authenticated with any of the following methods:

- ◆ With MS Active Directory schema.

Note: If this method is used, the LDAP schema for MS Active Directory must be extended. Without schema – Only the Usernames used on the KE Manager are matched to the names on the LDAP / AD server. User privileges are the same as the ones configured in the KE Manager.

- ◆ Without schema – Only the Usernames used on the KE Manager are matched to the names on the LDAP server. User privileges are the same as the ones configured in the KE Manager software.
 - ◆ Without schema – Only Groups in AD are matched. User privileges are the ones configured for the groups he belongs to in the KE Manager.
 - ◆ Without schema – Usernames and Groups in AD are matched. User privileges are the ones configured for the User and the Groups in the KE Manager.
- ◆ *TACACS+ Settings:*

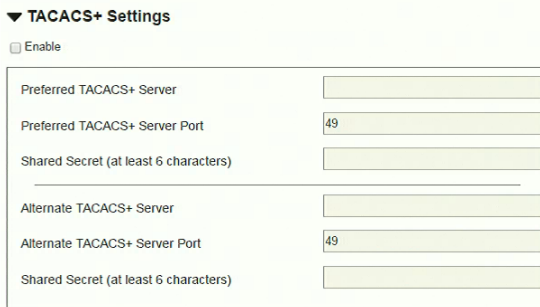

▼ **TACACS+ Settings**

Enable

Preferred TACACS+ Server	<input type="text"/>
Preferred TACACS+ Server Port	<input type="text" value="49"/>
Shared Secret (at least 6 characters)	<input type="text"/>
<hr/>	
Alternate TACACS+ Server	<input type="text"/>
Alternate TACACS+ Server Port	<input type="text" value="49"/>
Shared Secret (at least 6 characters)	<input type="text"/>

- ◆ **Enable TACACS+** and enter the following information:
 - ◆ Preferred TACACS+ Server
 - ◆ Preferred TACACS+ Service Port
 - ◆ Shared Secret 1
 - ◆ Alternate TACACS+ Server
 - ◆ Alternate TACACS+ Service Port
 - ◆ Shared Secret 2

FW Upgrade

In *FW Upgrade* all KE devices that are online are listed, allowing you to select which devices get upgraded. New firmware versions can be downloaded from our website as they become available. Check the website regularly to find the latest upgrade packages.

To upgrade the firmware do the following:

1. Go to our website and download the firmware upgrade package appropriate to your KE device.
2. Open your browser and log in to the KE Manager with an administrator's account.
3. Click the **Settings** icon; select the **FW Upgrade** tab, the *FW Upgrade* page appears:

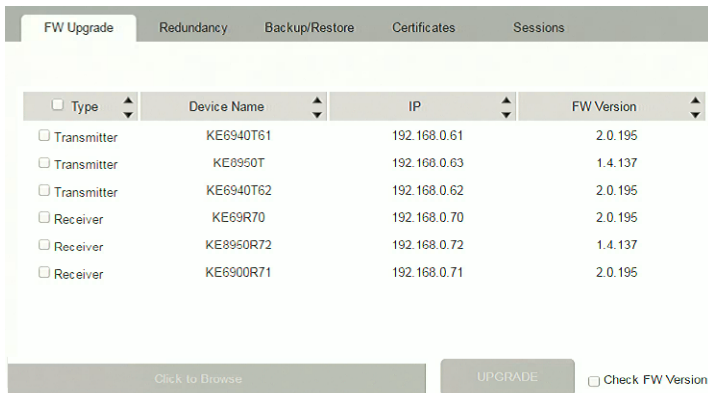

All the devices that are capable of being upgraded are listed.

Note: Only online devices show up in the list. Offline devices do not get upgraded.

4. Check the checkbox in front of the devices you want to upgrade. Uncheck the devices that you do not want to upgrade.
5. Click **Browse**. Navigate to the directory where the firmware upgrade file is located and select it.
6. Enable or disable *Check FW Version*
 - ◆ If you enabled *Check FW Version* the current firmware level is compared with that of the upgrade file. If the current version is equal to

or higher than the upgrade version, a popup message appears, to inform you of the situation and stops the upgrade procedure.

- ♦ If you didn't enable *Check FW Version*, the upgrade file is installed without checking what its level is.
 - ♦ If you cancel the firmware upgrade, you have to wait 12 seconds before you can disable *Check FW Version* and restart the firmware upgrade.
7. Click **Upgrade** to start the upgrade procedure. As the upgrade proceeds, progress information is shown on the screen. Once the upgrade completes successfully, the devices will reset.
 8. Log in to each device and check the firmware version to be sure it is the new one.

Firmware Upgrade Recovery

If the Upgrade Succeeded screen doesn't appear or the upgrade procedure is abnormally halted (due to computer crash, power failure, etc.), the device may become inoperable. If you find that the device does not work following a failed or interrupted upgrade, do the following

1. Power off the KE device.
2. Press the **Reset** button, then power on the KE device while holding Reset.
3. Hold **Reset** for 7 seconds after the device is powered on.
4. The device will revert to a previous firmware version and recover from the failure.
5. Upgrade the firmware to the most current version available.

Redundancy

The *Redundancy* tab allows you to set up a backup computer in case the computer hosting the KE Manager goes offline. If the KE Manager goes offline, the secondary computer will automatically take over operations, allowing all connections to continue without disruption – with only a brief period of 30 seconds when new connections can't be started. When the primary computer comes back online it retrieves the updated database from the secondary computer and re-takes all KE Manager operations.

To set up Redundancy, do the following:

1. Install KE Manager on a secondary computer with a USB license key. For detailed instructions, see page 161.

Note: A second USB license key is required if you have more than 8 KE Series devices in your setup.

2. On the secondary computer, log in to the KE Manager, click  and go to the *Redundancy* tab.

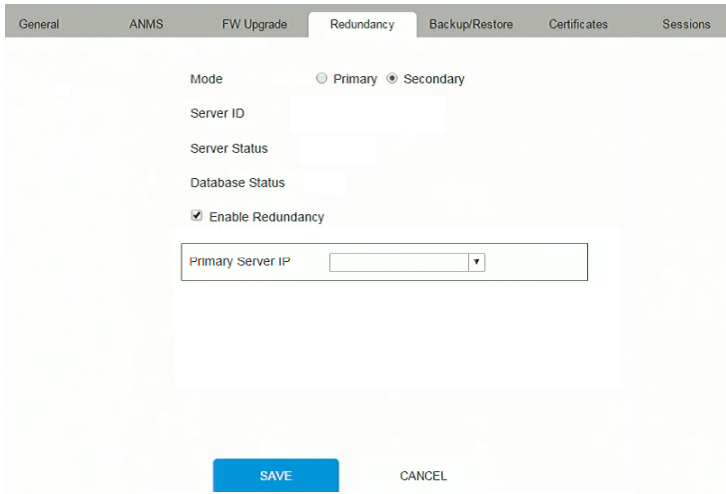

The screenshot shows the 'Redundancy' configuration tab in the KE Manager interface. The tab is selected among other tabs: General, ANMS, FW Upgrade, Redundancy, Backup/Restore, Certificates, and Sessions. The configuration options are as follows:

- Mode:** Radio buttons for 'Primary' and 'Secondary'. The 'Secondary' radio button is selected.
- Server ID:** A text input field.
- Server Status:** A text input field.
- Database Status:** A text input field.
- Enable Redundancy:** A checked checkbox.
- Primary Server IP:** A dropdown menu.

At the bottom of the form, there are two buttons: a blue 'SAVE' button and a 'CANCEL' button.

3. Check **Enable Redundancy** and select the **Secondary** radio button.
4. Use the **Primary Server IP** drop-down menu to select the primary IP address.
5. Click **Save**.
6. Redundancy is now running on the secondary computer.

7. On the primary computer, log in to the KE Manager, click  and go to the *Redundancy* tab.

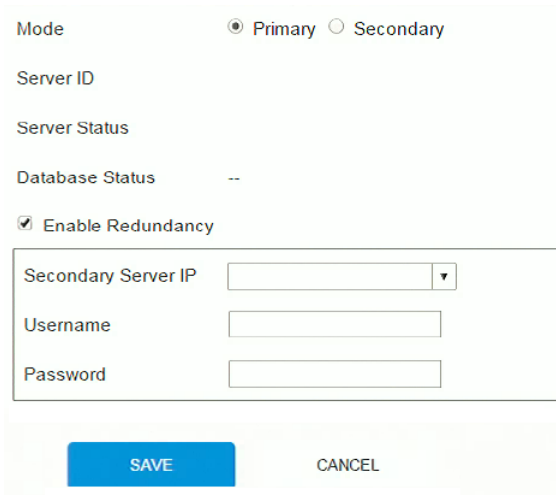

Mode Primary Secondary

Server ID

Server Status

Database Status --

Enable Redundancy

Secondary Server IP

Username

Password

SAVE CANCEL

8. Check **Enable Redundancy** and select the **Primary** radio button.
9. Use the **Secondary Server IP** drop-down menu to select the secondary IP address.
10. Enter the **Username** and **Password** of the secondary computer's local administrator account.
11. Click **Save**.
12. Information about the *Redundancy* status can be found in the event log (see *Log*, page 224 for details).

Backup / Restore

The *Backup/Restore* tab is divided into three panels: **Backup**, **Restore**, and **Export Device List**:

The screenshot shows the 'Backup/Restore' tab selected in a navigation menu. Below the menu are three panels:

- Backup:** Contains a blue 'BACKUP' button, a checkbox labeled 'Add Password', and an empty text input field.
- Restore:** Contains a grey button labeled 'Click to browse backup file...', a grey 'RESTORE' button, and a 'Password' text input field.
- Export Device List:** Contains a blue 'EXPORT' button.

The operations to perform backup/restore procedures are described in the table below and in the section that follows:

Procedure	Operation
Backup	Backs up the KE Manager configuration – including Receiver, Transmitter, Profile and Schedule configurations; user and group accounts, user profiles, logs, and system settings.
Restore	Deletes the current Receiver, Transmitter, Profile and Schedule configurations; user and group accounts, user profiles, logs, and system settings.; then restores those settings to the values that exist in the previously saved backup file.
Export Device List	Clicking Export allows you to save a file with a complete list of the devices added to the KE Manager. The file contains the ID, Name, Description and IP Address of each Transmitter and Receiver. An Existing column also lists if the device is available: Yes, it exists and is available, or No, it is offline or has been removed.

Backup

To back up system configuration settings, do the following:

1. (Optional) In the *Backup* panel, check **Add Password**, and provide a password for the backup file.

Note: Providing a password is a security feature – if you provide a password, you will need to give the same password in order to restore the configuration settings from this file.

2. Click **Backup**.
3. In the dialog box that comes up, Click **Save** to save the configuration file (*System.conf*) to a location on your hard disk.
4. Navigate to the directory where you want to save the file and click **Save**.

Restore

To restore system configuration settings, do the following:

1. In the *Restore* panel, click **Browse**.
2. Navigate to the directory where the backup file is located and select it.
3. When you return to the *Backup/Restore* page enter the password you set when the backup file was created.

Note: If you did not set a password for the file, leave the field blank.

4. Click **Restore**.
5. Click **OK** to confirm that you want to restore the configuration data.

When the Restore procedure is in process, a message stating that the KE Manager will restart will appear. After a short while the KE Manager closes and refreshes at the log in screen. When it comes back up the configuration settings that were restored from the backup file are in effect.

Certificates

This tab provides information about *Private Certificates*:

Issued To	
Common Name (CN)	ATEN INTERNATIONAL CO.,LTD
Organization (O)	ATEN INTERNATIONAL CO.,LTD
Organization Unit (OU)	R&D
Country (C)	TW
State or Province (ST)	New Taipei City
Locality (L)	Sijhih District
Email Address (E)	eservice@aten.com.tw
Serial Number	00:9D:5D:A9:CA:7F:40:B5:3B

Issued By	
Common Name (CN)	ATEN INTERNATIONAL CO.,LTD
Organization (O)	ATEN INTERNATIONAL CO.,LTD
Organization Unit (OU)	R&D

Validity	
Issued On	2016/03/17 05:40:43
Expires On	2026/03/16 05:40:43

Fingerprints	
SHA1 Fingerprint	EE:55:7F:72:13:B7:A9:40:00:32:E8:A0:AB:8C:9F:4B:C8:65:B5:A5

NEW GET CSR IMPORT RESTORE DEFAULT

Private Certificate

When logging in over a secure (SSL) connection, a signed certificate is used to verify that the user is logging in to the intended site. For enhanced security, the *Private Certificate* section allows you to use your own private encryption key and signed certificate, rather than the default ATEN certificate.

There are two methods for establishing your private certificate: generating a self-signed certificate; and importing a third-party certificate authority (CA) signed certificate.

- ♦ **Generating a Self-Signed Certificate**

If you wish to create your own self-signed certificate, a free utility – openssl.exe – is available for download over the web. See *Self-Signed Private Certificates*, page 328 for details about using OpenSSL to generate your own private key and SSL certificate.

- ♦ **Obtaining a CA Signed SSL Server Certificate**

For the greatest security, we recommend using a third party certificate authority (CA) signed certificate. To obtain a third party signed certificate,

go to a CA (Certificate Authority) website to apply for an SSL certificate. After the CA sends you the certificate and private encryption key, save them to a convenient location on your computer.

- ◆ **Importing the Private Certificate**

To import the private certificate, do the following:

1. Click **Import** from the bottom of the Private Certificate page, shown here:



2. Click **Browse** to the right of *Certificate Filename*; and browse to where your certificate file is located; and select it.
3. Click **Import** to complete the procedure.

Note: Clicking **Restore Defaults** returns the device to using the default ATEN certificate.

Certificate Signing Request

The Certificate Signing Request (CSR) section provides an automated way of obtaining and installing a CA signed SSL server certificate.

To perform this operation do the following:

1. Click **New**. The following dialog box appears:

2. Fill in the form – with entries that are valid for your site – according to the example information in the following table:

Information	Example
Country (2 letter code)	TW

Information	Example
State or Province	Taiwan
Locality	Taipei
Organization	Your Company, Ltd.
Organization Unit	Tech Department
Common Name	mycompany.com Note: This must be the exact domain name of the site that you want the certificate to be valid for. If the site's domain name is <i>www.mycompany.com</i> , and you only specify <i>mycompany.com</i> , the certificate will not be valid.
Email Address	administrator@yourcompany.com

3. After filling in the form (all fields are required), click **Create**.
A self-signed certificate based on the information you just provided is now stored on the KE Manager software.
4. Click Get CSR, and save the certificate file (*csr.cer*) to a convenient location on your computer.
This is the file that you give to the third party CA to apply for their signed SSL certificate.
5. After the CA sends you the certificate, save it to a convenient location on your computer. Click **Import** to locate the file; then click **Import** to store it on the KE Manager.

Note: When you upload the file, the KE Manager checks the file to make sure the specified information still matches. If it does, the file is accepted; if not, it is rejected.

If you want to remove the certificate (to replace it with a new one because of a domain name change, for example), simply click **Restore Defaults**.

Sessions

The *Sessions* tab shows all of the users that are logged into KE Manager and OSD sessions and provides information concerning the “who, where and when” of each session. This page also gives the administrator the option of forcing a user logout by selecting the user and clicking **Kill Session** next to each user.

Sessions						
Username	User Type	Service	IP	Login Time	Last Access	Operation
autocli	Administrator	SDK	192.168.0.72	2017/08/23 22:31:14	2017/08/23 22:36:26	<input type="button" value="Kill Session"/>
Harry	Super User	OSD	192.168.0.71	2017/08/25 14:54:02	2017/08/25 14:54:02	<input type="button" value="Kill Session"/>
administrator	Administrator	HTTPS	192.168.0.11	2017/08/25 16:03:00	2017/08/25 16:03:14	<input type="button" value="Kill Session"/>

- ◆ *Username* refers to the user that logged in to establish a session.
- ◆ *User Type* refers to the account type of the user.
- ◆ *Service* refers to how the user logged into their session – via KE Manager, Command Line, or OSD.
- ◆ *IP* refers to the IP address from which the user has logged in.
- ◆ *Login Time* refers to the date/time that the user logged into the session.
- ◆ *Last Access* refers to the last time the user session was active.
- ◆ *Operation* provides the **Kill Session** button to force a user logout.

This Page Intentionally Left Blank

Chapter 8

Connections

Overview

The *Connections* panel is found on the **KE Matrix Manager Main Page**, just below System Status. Connections provides a diagram of current Transmitter to Receiver connections. Before connections are established the panel appears blank, as shown below. To connect Receivers to Transmitters, use the *Instant Link* panel (page 176), or create a connection *Profile* (page 219).

When connections are made, clicking a device in the left column provides a way to view the connection, hovering the mouse cursor over the connection diagram in the right column allows you to disconnect the device, as explained in the sections that follows.

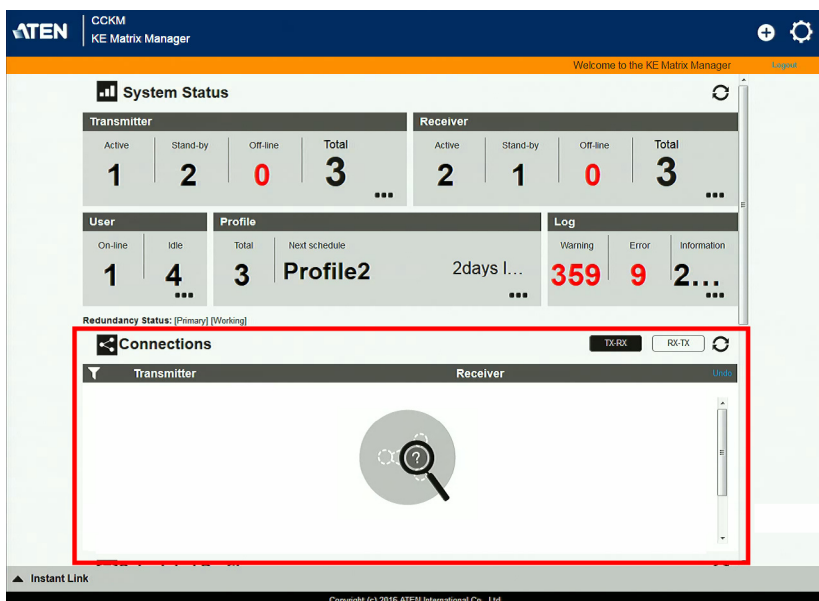

Connections

When Receivers connect to Transmitters, they appear in the *Connections* panel. There are two columns – each lists either Transmitters or Receivers. The columns can be swapped by clicking the **TX-RX** or **RX-TX** button. Devices in the left column can be clicked to display their connection to devices, shown in the right column. Connections, shown in the right column, can be disconnected by clicking the **X** over the connection diagram.

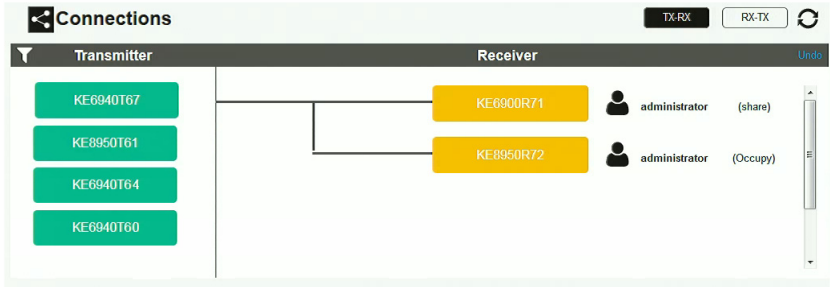

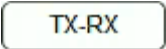
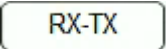
Item	Description
	On the heading bar under <i>Connections</i> , click this icon to change the sort order of the Transmitters or Receivers listed in the left column.
Left Column	Click a device in the left column to view its connection in the right column. A diagram to its connected device(s) appears in the right column.
Right Column	The right column displays a connection diagram when a device in the left column is selected. Move the mouse cursor over the diagram and click X to disconnect the devices. This column also shows the user and access type (Exclusive, Occupy, Share, View Only) used to establish the connection.
Transmitter	Lists Transmitters that are online and connected to Receivers.
Receiver	Lists Receivers that are online and connected to Transmitters.
	Click to view Transmitter to Receiver connections. This will list Transmitters in the left column so that they can be selected to view their connection diagram, shown in the right column.
	Click to view Receiver to Transmitter connections. This will list Receivers in the left column so that they can be selected to view their connection diagram, shown in the right column.

Item	Description
	Click this icon to Refresh the Transmitters and Receivers list in Connections panel.
Undo	Click this icon to undo the most recent disconnection.

This Page Intentionally Left Blank

Chapter 9

Scheduled Profile

Overview

The *Scheduled Profile* panel is found on the **KE Matrix Manager Main Page**, just below **Connections**. Scheduled Profiles displays connection profiles that have been scheduled. Click **Go to Schedule** to edit and create profile schedules (page 223). To create Profiles, see page 219.

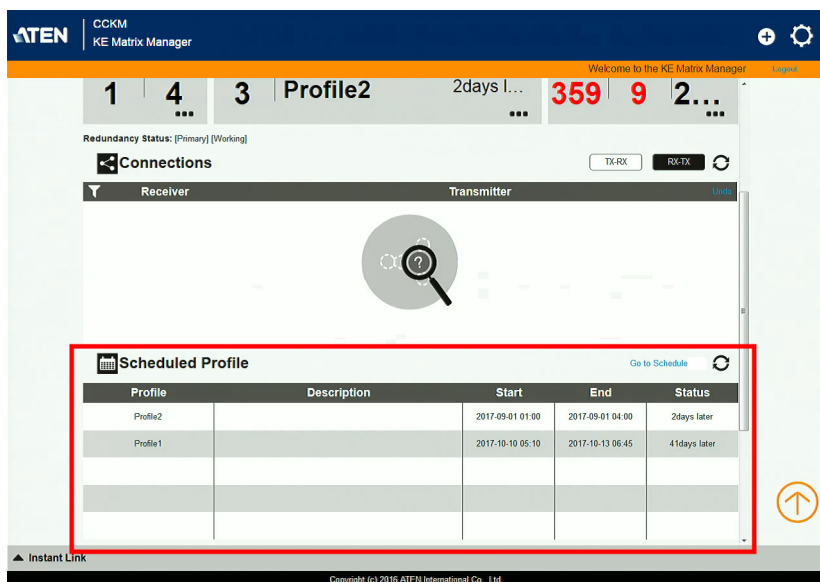

Item	Description
Headings	The headings provide the schedules: <i>Name</i> , <i>Description</i> , <i>Start</i> , <i>End</i> , and <i>Status</i> . Start and End show the time/date the profile is scheduled to begin and end. Status displays the number of days until to the next scheduled run.
Go to Schedule	Clicking Go to Schedule opens the <i>Profile</i> settings page which allows you to create and edit connection profiles. See <i>Profile</i> , page 219 for details.
	Click this icon to Refresh the connections list in the right column.
Undo	Click this icon to undo the most recent disconnection.

This Page Intentionally Left Blank

Chapter 10 Sessions

Overview

The *Sessions* panel is found at the bottom of the **KE Matrix Manager Main Page**, just below Scheduled Profile. Sessions displays information about users logged into devices and the KE Matrix Manager web GUI. Click **Go to Sessions** to view the settings page (see page 245).

The screenshot shows the KE Matrix Manager interface. At the top, there is a navigation bar with the ATEN logo, 'CCKM KE Matrix Manager', and a 'Welcome to the KE Matrix Manager' message. Below this is a 'Scheduled Profile' section with a table showing profiles and their schedules. The 'Sessions' section is highlighted with a red box and contains a table of active sessions. The 'Sessions' table has columns for Username, User Level, Service, IP, Login Time, Last Access, and Operation. The 'Operation' column contains 'Kill Session' buttons for each user. A 'Go to Sessions' link and a refresh icon are located to the right of the table.

Profile	Description	Start	End	Status
Profile2		2017-09-01 01:00	2017-09-01 04:00	2days later
Profile1		2017-10-10 05:10	2017-10-13 06:45	4days later

Username	User Level	Service	IP	Login Time	Last Access	Operation
Brett	Super User	OSD	192.168.0.71	2017/08/29 17:16	2017/08/29 17:16	Kill Session
administrator	Administrator	HTTPS	192.168.0.11	2017/08/29 17:17	2017/08/29 17:18	Kill Session
Jessy	Administrator	OSD	192.168.0.72	2017/08/29 17:18	2017/08/29 17:18	Kill Session

Item	Description
Headings	The headings provide information about each user session: <i>Username</i> , <i>User Level</i> , <i>Service</i> , <i>IP</i> , <i>Login Time</i> , and <i>Last Access</i> . For more details about each heading, see <i>Sessions</i> , page 245.
Go to Sessions	Clicking Go to Sessions opens the <i>Sessions</i> settings page which provides a page displaying the same information found in this panel.
	Click this icon to Refresh the Sessions list.

This Page Intentionally Left Blank

Chapter 11

Firmware Upgrade Utility

The Windows-based Firmware Upgrade Utility (FWUpgrade.exe) provides a smooth, automated process for upgrading the firmware. The Utility comes as part of a Firmware Upgrade Package that is specific for each device. New firmware upgrade packages are posted on our web site as new firmware revisions become available. Check the web site regularly to find the latest packages and information relating to them:

<http://www.aten.com>

For browser based firmware upgrade, please refer to *FW Upgrade* on page 236.

Preparation

1. From a computer that is not part of your installation go to our Internet support site and choose the model name that relates to your KE device to get a list of available Firmware Upgrade Packages.
2. Choose the Firmware Upgrade Package you want to install (usually the most recent), and download it to your computer.
3. Be sure that the computer is connected to the same LAN segment as the KE devices.

Starting the Upgrade

To upgrade your firmware:

1. Run the downloaded Firmware Upgrade Package file - either by double clicking the file icon, or by opening a command line and entering the full path to it. The Firmware Upgrade Utility Welcome screen appears:

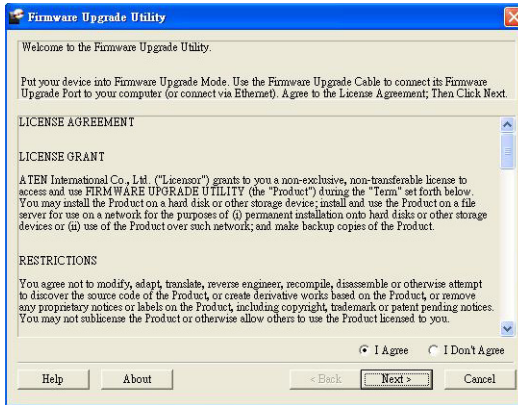

Note: The screens shown in this section are for reference only.

2. Read the License Agreement (enable the *I Agree* radio button).
3. Click **Next**. The Firmware Upgrade Utility main screen appears:

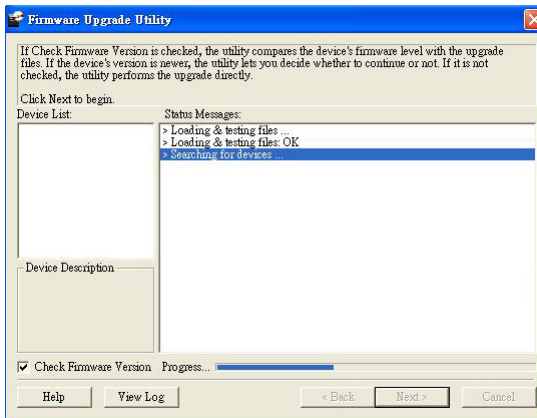

4. The Utility inspects your installation. All the devices capable of being upgraded by the package are listed in the *Select Master Device* list.

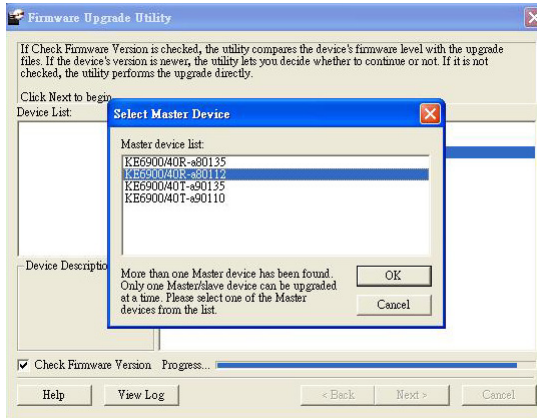

5. After you have made your device selection, Click **OK** and then **Next** to begin the upgrade.

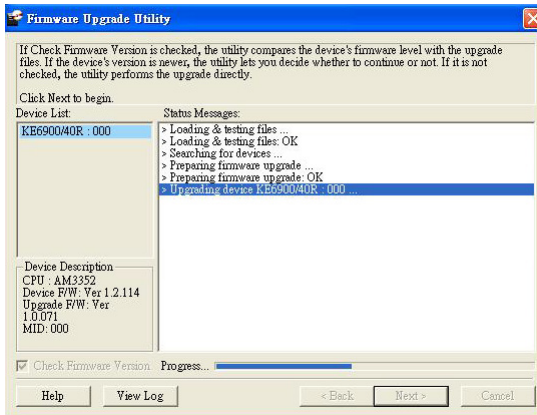

If you enabled *Check Firmware Version*, the Utility compares the device's firmware level with that of the upgrade files. If it finds that the device's version is higher than the upgrade version, it brings up a dialog box informing you of the situation and gives you the option to **Continue** or **Cancel**.

If you didn't enable *Check Firmware Version*, the Utility installs the upgrade files without checking whether they are a higher level, or not.

As the Upgrade proceeds status messages appear in the *Status Messages* panel, and the progress toward completion is shown on the *Progress* bar.

Upgrade Succeeded

After the upgrade has completed, a screen appears to inform you that the procedure was successful:

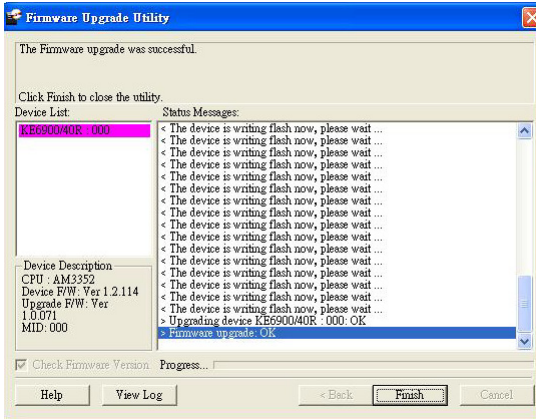

Firmware Upgrade Recovery

If the Upgrade Succeeded screen doesn't appear or the upgrade procedure is abnormally halted (due to computer crash, power failure, etc.), the device may become inoperable. If you find that the device does not work following a failed or interrupted upgrade, do the following

1. Power off the KE device.
2. Press the **Reset** button, then power on the KE device while holding Reset.
3. Hold **Reset** for 7 seconds after the device is powered on.
4. The device will revert to a previous firmware version and recover from the failure.
5. Upgrade the firmware to the most current version available.

This Page Intentionally Left Blank

Chapter 12

CLI Commands

Serial Control Protocol Commands

The KE Series's built-in bi-directional RS-232 serial interface and LAN port connection allows system control via Receivers through a high-end controller or PC. This control feature can also be accessed via TCP/IP through a computer running Telnet. The port for Telnet commands should be set to 9130.

Configuring the Serial Port

The controller's serial port should be configured the same as the Receiver's default configuration, as shown below:

Baud Rate	9600
Data Bits	8
Parity	None
Stop Bits	1
Flow Control	None

The Receiver's **Function Switch** should be set to *RS-232 Config* (see page 40). Before executing RS-232 commands across a network you must install the KE Matrix Manager software on a computer and ensure that it is online. For the Slim Version of KE Series (KE8900ST/8900SR/9900ST). Please make sure the RS-232 Serial Port is not connected before executing commands.

On your computer, open a terminal (command line) session. Please press "U/u" to start "CLI Session".

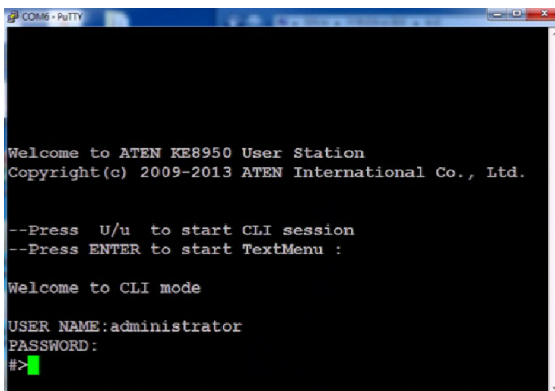

```
COM6 - PuTTY
Welcome to ATEN KE8950 User Station
Copyright(c) 2009-2013 ATEN International Co., Ltd.

--Press U/u to start CLI session
--Press ENTER to start TextMenu :

Welcome to CLI mode

USER_NAME:administrator
PASSWORD:
#>
```

Device/Profile Commands

When typing a device or profile into a command string, you can enter the name by: **IP address** (device only), **ID** or **@** with the List number for the device/profile in the command line interface.

Note: To find out about the List number for a device/profile, execute a List command (page 278).

Telnet

The KE Series can be operated and configured via a remote terminal session using Telnet. This is a useful means for configuring devices when they are first setup and connected to the network.

To log into the KE Series device by means of a Telnet session, do the following:

1. On your computer, open a terminal (command line) session.
2. At the prompt, key in the KE device's IP address with port 9130 in the following way:
telnet [IP address] [port]
3. Press Enter. The login screen appears. At the login prompt, provide the Password.

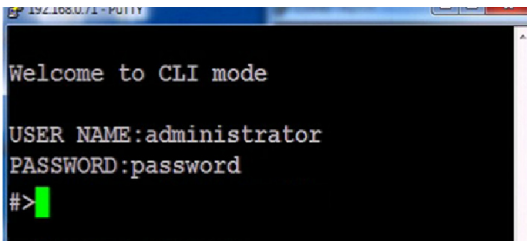
A screenshot of a terminal window titled "192.168.0.71 - PuTTY". The terminal displays the following text:

```
Welcome to CLI mode
USER NAME:administrator
PASSWORD:password
#>
```

A green cursor is visible after the prompt "#>".

Verification

After sending a command, a verification message appears at the end of the command line. Use the echo command to identify a command by number:

- ♦ **Command OK** - the command is correct and performed successfully
- ♦ **Command incorrect** - the command has the wrong format and/or values.
- ♦ **Echo Command** - at the end of a command string, type: **e1234** – where 1234 can be any number. The verification message returns with the echo number.

Switch Port Command

The formula for Switch Port commands is as follows:

Command + Output + Num1 + Input + Num2 + Mode + Stream + Connect + [Enter]

1. For example, if you want to switch the Receiver's connection to Transmitter (192.168.0.20), type the following:
sw i192.168.0.20 [Enter]
2. For example, if you want to disconnect the Receiver from its Transmitter connections, type the following:
sw off [Enter]
3. For example, if you want to connect Receiver (192.168.0.99) to Transmitter (192.168.0.79) with exclusive access to stream video and audio, type the following:
sw o192.168.0.99 i192.168.0.79 exclusive video audio on [Enter]
4. For example, to disconnect Receiver (192.168.0.11) from the video stream and return it to the OSD menu, type the following:
sw o192.168.0.11 off [Enter]
5. For example, to disconnect Receiver (192.168.0.09) from the video stream and logout the OSD, type the following:
sw o192.168.0.09 logout [Enter]
6. For example, to disconnect the Receiver's USB stream, type the following:
sw usb off [Enter]
7. For example, to switch the Receiver to the 5th Transmitter listed in the command line interface, type the following:
sw i@5 exclusive all on [Enter]
8. For example, to switch the Receiver to the 7th Transmitter listed in the command line interface with echo command 4312, type the following:
sw i@7 exclusive all on e4312
9. For example, to switch Receiver (192.168.0.12) to the 14th Transmitter listed in the command line interface with occupy access to stream video audio and USB, type the following:
sw o192.168.0.12 i@14 occupy video audio usb on [Enter]

The following tables show the possible values for the Switch Port commands:

Command	Description
sw	Switch port command

Output	Description
o	Output port command (RX)

Num1	Description
xx	Output port xx: Receiver ID or IP address
@zz	List # zz: 1~99 To use the 4th Receiver listed in the command line interface, type: o@4

Input	Description
i	Input command (TX)

Num2	Description
yy	Input port yy: Transmitter ID or IP address
@zz	List # zz: 1~99 To use the 8th Transmitter listed in the command line interface, type: i@8

Mode	Description
exclusive	Sets the Access Mode to exclusive.
share	Sets the Access Mode to share.
occupy	Sets the Access Mode to occupy.
viewonly	Sets the Access Mode to view only. If the mode is omitted, view only is used by default.

Stream	Description
video	Sets the video source stream
audio	Sets the audio source stream
serial	Sets the serial source stream

Stream	Description
usb	Sets the USB source stream
all	Sets all source streams

Connect	Description
on	Connect
off	Disconnect
logout	Logout OSD

The following table lists the available Switch Port commands:

Command	Output	Num1	Input	Num2	Mode	Stream	Connect	Description
sw	o	xx	i	yy	exclusive	video audio serial usb all	on	Switch output xx to input yy with exclusive access to source(s). xx: Receiver ID yy: Transmitter ID
sw	o	xx	i	yy	share	video audio serial usb all	on	Switch output xx to input yy with share access to stream source(s). xx: Receiver ID yy: Transmitter ID
sw	o	xx	i	yy	occupy	video audio serial usb all	on	Switch output xx to input yy with occupy access to stream source(s). xx: Receiver ID yy: Transmitter ID
sw	o	xx	i	yy	viewonly	video audio serial usb all	on	Switch output xx to input yy with viewonly access to stream source(s). xx: Receiver ID yy: Transmitter ID
sw	o	xx					off	Switch output xx, disconnect streams, return to OSD menu. xx: Receiver ID
sw	o	xx					logout	Switch output xx, disconnect streams and logout from OSD menu. xx: Receiver ID
sw						video audio serial usb all	off	Switch Receiver stream(s) to disconnect.

Command	Output	Num1	Input	Num2	Mode	Stream	Connect	Description
sw							off	Switch Receiver disconnect streams, return to OSD menu.
sw			i	@zz	exclusive share occupy viewonly	video audio serial usb all	on	Switch Receiver to input @zz with [mode] access to stream source(s). zz: Transmitter # by order listed in the command line interface.
sw	o	xx	i	@zz	exclusive	video audio serial usb all	on	Switch output xx to input @zz with [mode] access to stream source(s). xx: Receiver ID zz: Transmitter # by order listed in command line interface.

- Note:**
1. Each command string can be separated with a space.
 2. The **Mode** command string can be skipped and **view only** will be used by default.
 3. Skip the **Output** and **Num1** command strings to configure the local Receiver.

Mute Command

The Mute command allows you to enable or disable the audio.

The formula for the Mute command is as follows:

Command + Output + Num1 + Control + [Enter]

1. For example, to turn mute off (audio on) for the Receiver, type the following:

mute off [Enter]

2. For example, to turn mute on for Receiver (192.168.0.11), type the following:

mute o192.168.0.11 on [Enter]

3. For example, to turn mute off for Receiver (192.168.0.18), type the following:

mute o192.168.0.18 off [Enter]

The following tables show the possible values for the Mute commands:

Command	Description
mute	Mute command
Output	Description
o	Output port command
Num1	Description
xx	Output number xx: Receiver ID or IP address
Control	Description
on	Mute on; audio disabled
off	Mute off; audio enabled (default)

The following table lists the available Mute commands:

Command	Output	Num1	Control	Description
mute	o	xx	on	Turn mute on for output xx xx: Receiver ID
mute	o	xx	off	Turn mute off for output xx xx: Receiver ID

Command	Output	Num1	Control	Description
mute			on	Turn mute on for Receiver
mute			off	Turn mute off for Receiver

- Note:**
1. Each command string can be separated with a space.
 2. The **Control** command string can be skipped and **off** will be used by default.
 3. Skip the **Output** and **Num1** command strings to configure the local Receiver.
-

Profile Command

The Profile command allows you to connect profiles and video walls.

The formula for Profile commands is as follows:

Command + Profile + Num1 + Control + [Enter]

1. For example, to connect profile 8 and lock the OSD menu, type the following:

profile f8 [Enter]

2. For example, to connect profile 4 with access to the OSD menu, type the following:

profile f4 release [Enter]

3. For example, to disconnect profile 12 and return to the Receiver to the OSD menu, type the following:

profile f12 back [Enter]

The following tables show the possible values for the Profile commands:

Command	Description
profile	Profile command

Profile	Description
f	Profile ID

Num1	Description
xx	Profile or Video Wall ID xx: 1-99

Control	Description
lock	Connect profile, lock access to OSD menu (default)
release	Connect profile, allow access to OSD menu
back	Disconnect profile, return Receiver to OSD menu

The following table lists the available Profile commands:

Command	Profile	Num1	Control	Description
profile	f	xx	lock	Connect profile xx, lock OSD access xx: 1~99
profile	f	xx	release	Connect profile xx, allow OSD access xx: 1~99
profile	f	xx	back	Disconnect profile xx and return Receiver to OSD menu xx: 1~99

-
- Note:** 1. Each command string can be separated with a space.
2. The **Control** command string can be skipped and **lock** will be used by default.
 3. For functional **lock** and **release** commands, make sure the **Lock OSD when connecting** option is checked during *Create Profile*. Refer to *Lock OSD*, page 221 for more information.
-

EDID Command

Extended Display Identification Data (EDID) is a data that contains a display's basic information and is used to communicate with the video source. The EDID commands allow you to change the EDID setting of a Transmitter. For more information on configuring EDID settings, see *Properties*, page 141.

The formula for the EDID command is as follows:

Command + Address + Number + Control + [Enter]

1. For example, if you want to configure device (192.168.0.3) to use the remix EDID mode, type the following:

edid a192.168.0.3 remix [Enter]

The following tables show the possible values for the EDID commands:

Command	Description
edid	EDID command
Address	Description
a	Address command
Number	Description
xx	Address number xx: Receiver ID or IP address
Control	Description
auto	Checks the EDID of all connected displays and the ATEN default EDID to use the best common resolution for all displays.
remix	Manually checks the EDID of all connected displays and the ATEN default EDID to use the best common resolution for all displays (see <i>EDID Mode</i> , page 150).
default	Implements ATEN's default EDID. (default)
manual	Manually set the EDID configuration from the Receiver's OSD (see <i>EDID Mode</i> , page 150).

The following table lists the available EDID commands:

Command	Address	Number	Control	Enter	Description
edid	a	xx	auto	[Enter]	Set EDID of address xx to auto. xx: Device ID or IP Address
edid	a	xx	remix	[Enter]	Set EDID of address xx to remix. xx: Device ID or IP Address
edid	a	xx	default	[Enter]	Set EDID of address xx to default. xx: Device ID or IP Address
edid	a	xx	manual	[Enter]	Set EDID of address xx to manual. xx: Device ID or IP Address

Reset Command

The Reset command allows you to reset a device back to the default factory settings. Reset includes resetting the devices IP address.

Note: The Reset command resets everything but the login information to the factory default settings. To reset the login information, refer to *Reset All Information* on page 329.

The formula for the Reset command is as follows:

Command + Address + Number + [Enter]

1. For example, to reset device (192.168.0.95), type the following:
reset a192.168.0.95 [Enter]
2. For example, to reset the Receiver, type the following:
reset [Enter]

The following tables show the possible values for the **Reset** command:

Command	Description
reset	Reset command

Address	Description
a	Address command

Number	Description
xx	Address number xx: Receiver ID or IP address

The following table lists the available Reset commands:

Command	Address	Num	Enter	Description
reset	a	xx	[Enter]	Reset address xx back to the factory default settings xx: Device ID or IP Address
reset			[Enter]	Resets the Receiver settings

Note: 1. Each command string can be separated with a space.

2. Skip the **Address** and **Number** command strings to reset the local Receiver.

RS-232 Command

The RS-232 command allows you to set the RS-232 settings for a device.

The formula for the RS-232 command is as follows:

Command + Address + Number + Baud Rate + Parity + Data Bit + Stop Bit + Flow Control [Enter]

1. For example, to set device (192.168.0.33) with a baud rate of 38400, parity of none, data bit of 8, and stop bit of 1, type the following:

baud a192.168.0.33 38400 none 8 1 [Enter]

2. For example, to set the local device with a baud rate of 19200, type the following:

baud 19200 [Enter]

The following tables show the possible values for the RS-232 command:

Command	Description
baud	RS-232 command

Address	Description
a	Address command

Num1	Description
xx	Address number xx: Device ID or IP address

Baud Rate	Description
9600	Use 9600 baud rate
19200	Use 19200 baud rate
38400	Use 38400 baud rate
115200	Use 115200 baud rate

Parity	Description
None	Sets the parity to none
Even	Sets the parity to even
Odd	Sets the parity to odd

Data Bit	Description
5	Sets the data bit to 5
6	Sets the data bit to 6

Data Bit	Description
7	Sets the data bit to 7
8	Sets the data bit to 8
Stop Bit	Description
1	Sets the stop bit to 1
2	Sets the stop bit to 2
Flow Control	Description
None	Sets flow control to none
Hardware	Sets flow control to hardware
Xon	Sets flow control to Xon
Xoff	Sets flow control to Xoff

The following table lists the available Baud Rate commands:

Com mand	Address	Num 1	Baud Rate	Parity	Data Bit	Stop Bit	Flow Control	Description
baud	a	xx	9600	None Even Odd	5 6 7 8	1 2	None Hardware Xon/Xoff	Set address xx baud rate to 9600, with parity/ data bit/ stop bit / flow control setting
baud	a	xx	19200	None Even Odd	5 6 7 8	1 2	None Hardware Xon/Xoff	Set address xx baud rate to 19200, with parity/ data bit/ stop bit / flow control setting
baud	a	xx	38400	None Even Odd	5 6 7 8	1 2	None Hardware Xon/Xoff	Set address xx baud rate to 38400, with parity/ data bit/ stop bit / flow control setting
baud	a	xx	115200	None Even Odd	5 6 7 8	1 2	None Hardware Xon/Xoff	Set address xx baud rate to 115200, with parity/ data bit/ stop bit / flow control setting

Com mand	Address	Num 1	Baud Rate	Parity	Data Bit	Stop Bit	Flow Control	Description
baud			9600					Set local device baud rate to 9600
baud			19200					Set local device baud rate to 19200
baud			38400					Set local device baud rate to 38400
baud			115200					Set local device baud rate to 115200

- Note:** 1. Each command string can be separated with a space.
2. The **Baud Rate** value is required but **Parity**, **Data Bit** and **Stop Bit** can be skipped and their setting will not change.
 3. Skip the **Address** and **Number** command strings to configure the local device settings.
-

OSD Command

To enable or disable the On-Screen Display (OSD) menu for a Receiver, use the following command:

Command + Output + Number + Control + [Enter]

1. For example, to enable the OSD for Receiver 192.168.0.51, type:
osd o192.168.0.51 on [Enter]
2. For example, to disable the OSD for the local Receiver, type:
osd off [Enter]

The following tables show the possible values for the OSD command:

Command	Description
osd	OSD command

Output	Description
o	Output command

Number	Description
xx	Output number xx: Receiver ID or IP address

Control	Description
on	Enable OSD functions
off	Disable OSD functions (default)

The following table lists the available OSD commands:

Command	Output	Number	Control	Enter	Description
osd	o	xx	on	[Enter]	Enable OSD functions for output xx xx: Receiver ID or IP address
osd	o	xx	off	[Enter]	Disable OSD functions for output xx off (default) xx: Receiver ID or IP address

Note: 1. Each command string can be separated with a space.

2. Skip the **Output** and **Number** command strings to configure the local Receiver.

List Command

The List command allows you to retrieve information about users, settings and connections.

The formula for the List command is as follows:

Command + Output + Input + Number + Control [Enter]

1. For example, for a complete list of available channels, type the following:
list channel [Enter]
2. For example, for a complete list of available profiles, type the following:
list profile [Enter]
3. For example, to list all users logged into all OSD menus, type the following:
4. **list login [Enter]**
5. For example, to list the user logged into the OSD on Receiver (192.168.0.44), type the following:
list o192.168.0.44 login [Enter]
6. For example, for a complete list of available connections, type the following:
list connection [Enter]
7. For example, to list the current connections on Transmitter (192.168.0.88), type the following:
list i192.168.0.88 connection [Enter]

The following tables show the possible values for the List command:

Command	Description
list	List command

Output	Description
o	Output command

Input	Description
i	Input command

Number	Description
xx	Output or Input number xx: Device ID or IP address

Control	Description
channel	Lists information about the available channel(s)
profile	Lists information about the available profile and TV wall connections
rx	Lists information about the Receiver
login	Lists information about users logged into to the OSD menu
connection	Lists information about a Transmitters current connections

The following table lists the available List commands:

Command	Output	Input	Number	Control	Description
list	o		xx	login	List output xx user logged into OSD.
list	o		xx	rx	List output xx Receiver information
list		i	xx	connection	List input xx Transmitter information
list				channel	List all available channel information
list				profile	List all available profile information
list				rx	List information about all Receivers
list				login	List information about all OSD logins
list				connection	List information about all connections

Note: 1. Each command string can be separated with a space.

2. Skip the **Output** or **Input** and **Number** command strings to view the local Receiver.

Read Command

The Read command allows you to retrieve the properties of a device.

The formula for the Read command is as follows:

Command + Output + Input + Number + Control [Enter]

1. For example, to read all of the local Receiver's properties, type the following:
read all [Enter]
2. For example, to read all of Receiver (192.168.0.19) device properties, type the following:
read o192.168.0.19 all [Enter]
3. For example, to read all of Transmitter (192.168.0.28) device properties, type the following:
read i192.168.0.28 all [Enter]
4. For example, to read the basic properties of Receiver (192.168.0.61), type the following:
read o192.168.0.61 basic [Enter]
5. For example, to read the network properties of Transmitter (192.168.0.71), type the following:
read i192.168.0.71 network [Enter]

The following tables show the possible values for the Read command:

Command	Description
read	Read command

Output	Description
o	Output command

Input	Description
i	Input command

Number	Description
xx	Output or Input number xx: Device ID or IP address

Control	Description
all	Read all device properties

Control	Description
basic	Read basic properties
network	Read network properties
ipsettings	Read IP settings
rs232	Read RS232 properties
properties	Read connection properties
manager	Read KE Matrix Manager software properties
streams	Read enable media properties
tx	Read source stream IP properties (Receiver)
usbmode	Read USB mode properties (Receiver)
multicast	Read multicast properties (Transmitter)
videoqyadvanced	Read advanced video properties (Transmitter)
ossettings	Read OS properties (Transmitter)

The following table lists the available Read commands:

Command	Output	Input	Number	Control	Description
read	o	i	xx	all	Read output or input xx all device properties xx: Device ID or IP address
read	o	i	xx	basic	Read output or input xx basic properties xx: Device ID or IP address
read	o	i	xx	network	Read output or input xx network properties xx: Device ID or IP address
read	o	i	xx	ipsettings	Read output or input xx IP address properties xx: Device ID or IP address

Command	Output	Input	Number	Control	Description
read	o	i	xx	rs232	Read output or input xx RS-232 properties xx: Device ID or IP address
read	o	i	xx	properties	Read output or input xx connection properties xx: Device ID or IP address
read	o	i	xx	manager	Read output or input xx KE Matrix Manager IP and port properties xx: Device ID or IP address
read	o	i	xx	streams	Read output or input xx enable media properties xx: Device ID or IP address
read	o		xx	tx	Read output xx source stream IP address properties xx: Receiver ID or IP address
read	o		xx	usbmode	Read output xx USB mode properties xx: Receiver ID or IP address
read	i		xx	multicast	Read input xx multicast properties xx: Transmitter ID or IP address
read	i		xx	videoqyadvanced	Read input xx advanced video properties xx: Transmitter ID or IP address
read	i		xx	ossettings	Read input xx OS properties xx: Transmitter ID or IP address
read				all	Read all properties of local Receiver

Command	Output	Input	Number	Control	Description
read				basic network ipsettings rs232 properties manager streams tx usbmode	Read [control] properties of local Receiver.

Note: 1. Each command string can be separated with a space.

2. Skip the **Output** or **Input** and **Number** command strings to read the local Receiver properties.
-

Set Command

The Set command allows you to configure the properties of a device. Some settings require that both the device and Matrix Manager are online or the command will fail.

The formula for the Set command is as follows:

Command + Output + Input + Number + Control + Value + [Enter]

1. For example, to set the name of the local Receiver to KE6940TX1, type the following:

set Name=KE6940TX1 [Enter]

2. For example, to set the description of Transmitter (192.168.0.33) to KE Room B, type the following:

set o192.168.0.19 Description=KE Room B [Enter]

3. For example, to set the DHCP settings of Transmitter (192.168.0.28) to static, type the following:

set i192.168.0.28 dhcpFlag=STATIC [Enter]

4. For example, to set the IP settings of the local Receiver to 192.168.0.2, type the following:

set ipAddr=192.168.0.2 [Enter]

5. For example, to set the Transmitter Video IP setting to 192.168.0.44 for Receiver (192.168.0.56), type the following:

set o192.168.0.56 TxVideoIP=192.168.0.44 [Enter]

The following tables show the possible values for the Set command:

Command	Description
set	Set command

Output	Description
o	Output command

Input	Description
i	Input command

Number	Description
xx	Output or Input number xx: Device ID or IP address

Control	Description
Name	Sets the device name
Description	Sets the device description
ipInstallerFlag	Sets the IP installer option
dhcpFlag	Sets the DHCP setting
ipAddr	Sets the IP address
netmask	Sets the subnet mask
gw	Sets the default gateway
modeFlag	Sets the device mode
BaudRate	Sets the baud rate setting
Parity	Sets the parity setting
DataBit	Sets the data bit setting
StopBit	Sets the stop bit setting
FlowCtrl	Sets the flow control setting
TxVideoIP	Sets the Transmitter video IP setting
TxAudioIP	Sets the Transmitter audio IP setting
TxUSBIP	Sets the Transmitter USB IP setting
TxRSIP	Sets the Transmitter RS-232 IP setting
VideoEnFlag	Sets the (enable media) video source stream
AudioEnFlag	Sets the (enable media) audio source stream
USBEnFlag	Sets the (enable media) USB source stream
RSEnFlag	Sets the (enable media) RS232 source stream
ManagerIP	Sets the KE Matrix Manager software IP
ManagerPort	Sets the KE Matrix Manager software port
Beeper	Sets the beeper
RxVM	Sets the USB mode setting
USBSecure	Sets the USB encryption
PortOS	Sets the port OS setting
OSLanguage	Sets the OS language
videoMCastEn	Sets the enable multicast video setting

Control	Description
audioMCastEn	Sets the enable multicast audio setting
Edid	Sets the EDID mode selection setting
VideoType	Sets the video type setting
ColorDepth	Sets the color depth setting
BandwidthLimit	Sets the bandwidth limit setting
VideoQty	Sets the video quality setting
BGRefresh	Sets the background refresh setting
Beeper	Sets the beeper setting
OccupyTimeout	Sets the occupy timeout setting
Resolution	Sets the resolution setting

Value	Description
=yy	Set value to yy yy: Enter a value that corresponds to the control being used

The following table lists the available Set commands:

Command	Output	Input	Number	Control	Value	Description
Set	o	i	xx	Name	yy	Set output or input xx Name to yy xx: Device ID or IP address yy: Name value
Set	o	i	xx	Description	yy	Set output or input xx Description to yy xx: Device ID or IP address yy: Description value
Set	o	i	xx	ipInstallerFlag	yy	Set output or input xx ipInstallerFlag to yy xx: Device ID or IP address yy: enable, viewonly, disable

Comm and	Output	Input	Number	Control	Value	Description
Set	o	i	xx	dhcpFlag	yy	Set output or input xx dhcpFlag to yy xx: Device ID or IP address yy: dhcp, static
Set	o	i	xx	ipAddr	yy	Set output or input xx ipAddr to yy xx: Device ID or IP address yy: IP address value
Set	o	i	xx	netmask	yy	Set output or input xx netmask to yy xx: Device ID or IP address yy: Subnet mask value
Set	o	i	xx	gw	yy	Set output or input xx gw to yy xx: Device ID or IP address yy: Default gateway value
Set	o	i	xx	modeFlag	yy	Set output or input xx modeFlag to yy xx: Device ID or IP address yy: extender, matrix
Set	o	i	xx	BaudRate	yy	Set output or input xx BaudRate to yy xx: Device ID or IP address yy: 9600, 19200, 38400, 115200
Set	o	i	xx	Parity	yy	Set output or input xx Parity to yy xx: Device ID or IP address yy: none, even, odd
Set	o	i	xx	DataBit	yy	Set output or input xx DataBit to yy xx: Device ID or IP address yy: 5, 6, 7, 8

Comm and	Output	Input	Number	Control	Value	Description
Set	o	i	xx	StopBit	yy	Set output or input xx StopBit to yy xx: Device ID or IP address yy: 1, 1.5, 2
Set	o	i	xx	FlowCtrl	yy	Set output or input xx FlowCtrl to yy xx: Device ID or IP address yy: none, hardware, Xon, Xoff
Set	o	i	xx	TxVideoIP	yy	Set output xx TxVideoIP to yy xx: Device ID or IP address yy: IP address value
Set	o		xx	TxAudioIP	yy	Set output xx TxAudioIP to yy xx: Device ID or IP address yy: IP address value
Set	o		xx	TxUSBIP	yy	Set output xx TxUSBIP to yy xx: Device ID or IP address yy: IP address value
Set	o		xx	TxRSIP	yy	Set output xx TxRSIP to yy xx: Device ID or IP address yy: IP address value
Set	o	i	xx	VideoEnFlag	yy	Set output or input xx VideoEnFlag to yy xx: Device ID or IP address yy: enable, disable
Set	o	i	xx	AudioEnFlag	yy	Set output or input xx AudioEnFlag to yy xx: Device ID or IP address yy: enable, disable

Command	Output	Input	Number	Control	Value	Description
Set	o	i	xx	USBEnFlag	yy	Set output or input xx USBEnFlag to yy xx: Device ID or IP address yy: enable, disable
Set	o	i	xx	RSEnFlag	yy	Set output or input xx RSEnFlag to yy xx: Device ID or IP address yy: enable, disable
Set	o	i	xx	ManagerIP	yy	Set output or input xx ManagerIP to yy xx: Device ID or IP address yy: KE Matrix Manager software IP address
Set	o	i	xx	ManagerPort	yy	Set output or input xx ManagerPort to yy xx: Device ID or IP address yy: KE Matrix Manager software port
Set	o	i	xx	Beeper	yy	Set output or input xx Beeper to yy xx: Device ID or IP address yy: enable, disable
Set	o		xx	RxVM	yy	Set output xx RxVM to yy xx: Device ID or IP address yy: vm, vusb
Set	o		xx	USBSecure	yy	Set output xx USBSecure to yy xx: Device ID or IP address yy: on, off
Set		i	xx	PortOS	yy	Set input xx PortOS to yy xx: Device ID or IP address yy: win, mac, sun, other

Command	Output	Input	Number	Control	Value	Description
Set		i	xx	OSLanguage	yy	Set input xx OSLanguage to yy xx: Device ID or IP address yy: english, japanese, french, german, spanish, korean, chinese(traditional), english(uk), swedish, arabic, belgian, canadian-bilingual, french(canada), czech, danish, finnish, greek, hebrew, hungarian, international(iso), italian, latin american, dutch, norwegian, persian(farsi), polish, portuguese, russian, slovak, french (switzerland), german (switzerland), switzerland, reserved, turkish-q, reserved, serbo-croatian
Set		i	xx	videoMCastEn	yy	Set input xx videoMCastEn to yy xx: Device ID or IP address yy: enable, disable
Set		i	xx	audioMCastEn	yy	Set input xx audioMCastEn to yy xx: Device ID or IP address yy: enable, disable
Set		i	xx	Edid	yy	Set input xx Edid to yy xx: Device ID or IP address yy: default, auto, manual, remix
Set		i	xx	VideoType	yy	Set input xx VideoType to yy xx: Device ID or IP address yy: dvi-d, dvi-a

Command	Output	Input	Number	Control	Value	Description
Set		i	xx	ColorDepth	yy	Set input xx ColorDepth to yy xx: Device ID or IP address yy: 8, 16, 24, and 36 (only for KE89 Series)
Set		i	xx	BandwidthLimit	yy	Set input xx BandwidthLimit to yy xx: Device ID or IP address yy: unlimited, 100, 200, 500
Set		i	xx	VideoQty	yy	Set input xx VideoQty to yy xx: Device ID or IP address yy: 1, 2, 3, 4, 5
Set		i	xx	BGRefresh	yy	Set input xx BGRefresh to yy xx: Device ID or IP address yy: off, 16, 32, 64, 128, 256
Set		i	xx	OccupyTimeout	yy	Set input xx OccupyTimeout to yy xx: Device ID or IP address yy: 1~240

Command	Output	Input	Number	Control	Value	Description
Set		i	xx	Resolution	yy	Set input xx Resolution to yy xx: Device ID or IP address yy: 1920x1200, 1920x1080, 1680x1050, 1600x1200, 1600x900, 1440x900, 1400x1050, 1366x768, 1280x1024, 1280x960, 1280x720, 1152x864, 1024x768, 800x600, 720x400, 640x480, 2560x1080*, 3840x2160*, 1920x1440*, 2560x1600*, 2560x1440*, 2048x1536* *Only for KE89 Series

Safety Instructions

General

- ◆ This product is for indoor use only.
- ◆ Read all of these instructions. Save them for future reference.
- ◆ Follow all warnings and instructions marked on the device.
- ◆ Do not place the device on any unstable surface (cart, stand, table, etc.). If the device falls, serious damage will result.
- ◆ Do not use the device near water.
- ◆ Do not place the device near, or over, radiators or heat registers.
- ◆ The device cabinet is provided with slots and openings to allow for adequate ventilation. To ensure reliable operation, and to protect against overheating, these openings must never be blocked or covered.
- ◆ The device should never be placed on a soft surface (bed, sofa, rug, etc.) as this will block its ventilation openings. Likewise, the device should not be placed in a built in enclosure unless adequate ventilation has been provided.
- ◆ Never spill liquid of any kind on the device.
- ◆ Avoid circuit overloads. Before connecting equipment to a circuit, know the power supply's limit and never exceed it. Always review the electrical specifications of a circuit to ensure that you are not creating a dangerous condition or that one doesn't already exist. Circuit overloads can cause a fire and destroy equipment.
- ◆ Unplug the device from the wall outlet before cleaning. Do not use liquid or aerosol cleaners. Use a damp cloth for cleaning.
- ◆ The device should be operated from the type of power source indicated on the marking label. If you are not sure of the type of power available, consult your dealer or local power company.
- ◆ The device is designed for IT power distribution systems with 230V phase-to-phase voltage.
- ◆ To prevent damage to your installation it is important that all devices are properly grounded.
- ◆ The device is equipped with a 3-wire grounding type plug. This is a safety feature. If you are unable to insert the plug into the outlet, contact your electrician to replace your obsolete outlet. Do not attempt to defeat the

purpose of the grounding-type plug. Always follow your local/national wiring codes.

- ◆ Do not allow anything to rest on the power cord or cables. Route the power cord and cables so that they cannot be stepped on or tripped over.
- ◆ If an extension cord is used with this device make sure that the total of the ampere ratings of all products used on this cord does not exceed the extension cord ampere rating. Make sure that the total of all products plugged into the wall outlet does not exceed 15 amperes.
- ◆ To help protect your system from sudden, transient increases and decreases in electrical power, use a surge suppressor, line conditioner, or uninterruptible power supply (UPS).
- ◆ Position system cables and power cables carefully; Be sure that nothing rests on any cables.
- ◆ Never push objects of any kind into or through cabinet slots. They may touch dangerous voltage points or short out parts resulting in a risk of fire or electrical shock.
- ◆ Do not attempt to service the device yourself. Refer all servicing to qualified service personnel.
- ◆ If the following conditions occur, unplug the device from the wall outlet and bring it to qualified service personnel for repair.
 - ◆ The power cord or plug has become damaged or frayed.
 - ◆ Liquid has been spilled into the device.
 - ◆ The device has been exposed to rain or water.
 - ◆ The device has been dropped, or the cabinet has been damaged.
 - ◆ The device exhibits a distinct change in performance, indicating a need for service.
 - ◆ The device does not operate normally when the operating instructions are followed.
- ◆ Only adjust those controls that are covered in the operating instructions. Improper adjustment of other controls may result in damage that will require extensive work by a qualified technician to repair.

Rack Mounting

- ◆ Before working on the rack, make sure that the stabilizers are secured to the rack, extended to the floor, and that the full weight of the rack rests on the floor. Install front and side stabilizers on a single rack or front stabilizers for joined multiple racks before working on the rack.
- ◆ Always load the rack from the bottom up, and load the heaviest item in the rack first.
- ◆ Make sure that the rack is level and stable before extending a device from the rack.
- ◆ Use caution when pressing the device rail release latches and sliding a device into or out of a rack; the slide rails can pinch your fingers.
- ◆ After a device is inserted into the rack, carefully extend the rail into a locking position, and then slide the device into the rack.
- ◆ Do not overload the AC supply branch circuit that provides power to the rack. The total rack load should not exceed 80 percent of the branch circuit rating.
- ◆ Make sure that all equipment used on the rack – including power strips and other electrical connectors – is properly grounded.
- ◆ Ensure that proper airflow is provided to devices in the rack.
- ◆ Ensure that the operating ambient temperature of the rack environment does not exceed the maximum ambient temperature specified for the equipment by the manufacturer.
- ◆ Do not step on or stand on any device when servicing other devices in a rack.

Technical Support

International

- ◆ For online technical support – including troubleshooting, documentation, and software updates: **<http://support.aten.com>**
- ◆ For telephone support, see *Telephone Support*, page iii.

North America

Email Support		support@aten-usa.com
Online Technical Support	Troubleshooting Documentation Software Updates	http://www.aten-usa.com/support
Telephone Support		1-888-999-ATEN ext 4988 1-949-428-1111

When you contact us, please have the following information ready beforehand:

- ◆ Product model number, serial number, and date of purchase.
- ◆ Your computer configuration, including operating system, revision level, expansion cards, and software.
- ◆ Any error messages displayed at the time the error occurred.
- ◆ The sequence of operations that led up to the error.
- ◆ Any other information you feel may be of help.

Specifications

KE6900T / KE6940T

Function		KE6900T	KE6940T	
Connectors	Console Ports	Keyboard	1 x USB Type A Female (White)	
		Video	1 x DVI-I Female (White) 2 x DVI-I Female (White)	
		Mouse	1 x USB Type A Female (White)	
		Speaker	1 x Mini Stereo Jack Female (Green)	
		Mic.	1 x Mini Stereo Jack Female (Pink)	
		RS-232	1 x DB-9 Male (Black)	
	KVM Ports	KB / Mouse	USB Type B Female (White)	
		Speaker	1 x Mini Stereo Jack (Green)	
		Mic.	1 x Mini Stereo Jack (Pink)	
		Video	1 x DVI-I Female (White) 2 x DVI-I Female (White)	
		RS-232	1 x DB-9 Female (Black)	
	Power		1 x DC Jack (Black)	
	LAN		1 x RJ-45 Female (Black)	
	Switches	Function	1 x Slide switch (Black) (Auto, RS-232 Config, Local)	
Reset		1 x Semi-recessed Pushbutton		
LEDs	LAN	1 (Green / Orange)		
	Power	1 x Blue		
	Local	1 x Green		
	Remote	1 x Green		
Emulation	Keyboard / Mouse	USB		
Power Consumption		DC 5V, 7.34W	DC 5V, 8.91W	
Video Resolution		Up to 1920 x 1200		
Environment	Operating Temp.	0–50°C		
	Storage Temp.	-20–60°C		
	Humidity	0–95% RH, Non-condensing		

Function		KE6900T	KE6940T
Physical Properties	Housing	Metal	
	Weight	1.14 kg	1.15 kg
	Dimensions (L x W x H)	21.50 x 16.29 x 4.18 cm	

KE6900R / KE6940R

Function		KE6900R	KE6940R	
Connectors	USB Virtual Media		2 x USB Type A Female (White)	
	Console Ports	Keyboard	1 x USB Type A Female (White)	
		Video	1 x DVI-I Female (White)	2 x DVI-I Female (White)
		Mouse	1 x USB Type A Female (White)	
		Speaker	1 x Mini Stereo Jack Female (Green)	
		Mic.	1 x Mini Stereo Jack Female (Pink)	
	RS-232		1 x DB-9 Male (Black)	
	Power		1 x DC Jack (Black)	
	LAN		1 x RJ-45 Female (Black)	
Switches	OSD		1 x Pushbutton	
	Video		1 x Pushbutton	
	Graphics		1 x Pushbutton	
	Function		1 x Slide Switch (Black) (Extension, RS-232 Config)	
	Reset		1 x Semi-recessed Pushbutton	
LEDs	LAN		1 (Green / Orange)	
	Power		1 x Blue	
	Local		1 x Green	
	Remote		1 x Green	
Emulation	Keyboard / Mouse		USB	
Power Consumption		DC 5V, 6.9W	DC 5V, 9.53W	
Video Resolution		Up to 1920 x 1200		
Environment	Operating Temp.		0–50°C	
	Storage Temp.		-20–60°C	
	Humidity		0–95% RH, Non-condensing	
Physical Properties	Housing		Metal	
	Weight		1.25 kg	1.25 kg
	Dimensions (L x W x H)		22.75 x 17.16 x 5.48 cm	

KE6900AT / KE6940AT

Function		KE6900AT	KE6940AT	
Connectors	Console Ports	Keyboard	1 x USB Type A Female (White)	
		Video	1 x DVI-I Female (White) 2 x DVI-I Female (White)	
		Mouse	1 x USB Type A Female (White)	
		Speaker	1 x Mini Stereo Jack Female (Green)	
		Mic.	1 x Mini Stereo Jack Female (Pink)	
		RS-232	1 x DB-9 Male (Black)	
	KVM Ports	KB / Mouse	1 x USB Type B Female (White)	
		Speaker	1 x Mini Stereo Jack (Green)	
		Mic.	1 x Mini Stereo Jack (Pink)	
		Video	1 x DVI-I Female (White) 2 x DVI-I Female (White)	
		RS-232	1 x DB-9 Female (Black)	
	Power		2 x DC Jack (Black)	
	LAN		1 x RJ-45 Female (Black) 1 x SFP Slot	
	Switches	Function	1 x Slide switch (Black) (Auto, RS-232 Config/Access Control, Local)	
Reset		1 x Semi-recessed Pushbutton		
LEDs	LAN	1 (10: Orange / 100: Orange & Green / 1000: Green)		
	Power	1 x Blue		
	Local	1 x Green		
	Remote	1 x Green		
Emulation	Keyboard / Mouse	USB		
Power Consumption		DC 5V, 7.95W	DC 5V, 12.2W	
Video Resolution		Up to 1920 x 1200 @ 60Hz		
Environment	Operating Temp.	0–50°C		
	Storage Temp.	-20–60°C		
	Humidity	0–95% RH, Non-condensing		

Function		KE6900AT	KE6940AT
Physical Properties	Housing	Metal	
	Weight	1.15 kg (2.53 lb)	1.17 kg (2.58 lb)
	Dimensions (L x W x H)	21.50 x 16.33 x 4.18 cm (8.46 x 6.43 x 1.65 in.)	

KE6900AR / KE6940AR

Function		KE6900AR	KE6940AR	
Connectors	USB Virtual Media	2 x USB Type A Female (White)		
	Console Ports	Keyboard	1 x USB Type A Female (White)	
		Video	1 x DVI-I Female (White)	2 x DVI-I Female (White)
		Mouse	1 x USB Type A Female (White)	
		Speaker	1 x Mini Stereo Jack Female (Green)	
		Mic.	1 x Mini Stereo Jack Female (Pink)	
		RS-232	1 x DB-9 Male (Black)	
	Power	2 x DC Jack (Black)		
LAN	1 x RJ-45 Female (Black) 1 x SFP Slot			
Switches	OSD	1 x Pushbutton		
	Video	1 x Pushbutton		
	Graphics	1 x Pushbutton		
	Function	1 x Slide Switch (Black) (Extension, RS-232 Config)		
	Reset	1 x Semi-recessed Pushbutton		
LEDs	LAN	1 (10: Orange / 100: Orange & Green / 1000: Green)		
	Power	1 x Blue		
	Local	1 x Green		
	Remote	1 x Green		
Emulation	Keyboard / Mouse	USB		
Power Consumption		DC 5V, 6.35W	DC 5V, 8.51W	
Video Resolution		Up to 1920 x 1200 @ 60Hz		
Environment	Operating Temp.	0–50°C		
	Storage Temp.	-20–60°C		
	Humidity	0–95% RH, Non-condensing		
Physical Properties	Housing	Metal		
	Weight	1.30 kg (2.86 lb)	1.31 kg (2.89 lb)	
	Dimensions (L x W x H)	22.75 x 17.16 x 5.48 cm (8.96 x 6.76 x 2.16 in.)		

KE6900ST

Function			KE6900ST
Connectors	KVM Ports	KB / Mouse	USB Type B Female (White)
		Video	1 x DVI-D Male (White)
	RS-232		1 x DB-9 Female (Black)
	Power		1 x DC Jack (Black)
	LAN		1 x RJ-45 Female (Black)
Switch	Reset		1 x Semi-recessed Pushbutton
LEDs	LAN		1 (Green / Orange)
	Power		1 x Blue
Emulation	Keyboard / Mouse		USB
Power Consumption			5 V / 7.3 W
Video Resolution			Up to 1920 x 1200
Environment	Operating Temp.		0–50°C
	Storage Temp.		-20–60°C
	Humidity		0–95% RH, Non-condensing
Physical Properties	Housing		Metal
	Weight		0.43 kg
	Dimensions (L x W x H)		14.39 x 10.30 x 3.00 cm

KE6910

Function		KE6910R	KE6910T
Connectors	Virtual Media	2 x USB Type A Female (White)	N/A
	Console Ports	2 x USB Type A Female (White)	2 x USB Type A Female (White)
		1 x DVI-D Female (White)	1 x DVI-D Female (White)
		1 x Mini Stereo Jack (Green)	1 x Mini Stereo Jack (Green)
		1 x Mini Stereo Jack (Pink)	1 x Mini Stereo Jack (Pink)
		1 x DB-9 Male (Black)	1 x DB-9 Male (Black)
	KVM Ports	N/A	1 x USB Type B Female (White)
			1 x DVI-D Female (White)
			1 x Mini Stereo Jack (Green)
			1 x Mini Stereo Jack (Pink)
	Power	2 x DC Jack (Black)	2 x DC Jack (Black)
LAN	1 x RJ-45 (Black) 1 x SFP Slot		
Switches	OSD	1 x Pushbutton	N/A
	Video	1 x Pushbutton	N/A
	Graphics	1 x Pushbutton	N/A
	Reset	1 x Semi-recessed Pushbutton	
	Mode Selection	1 x Slide Switch (Extension, RS-232 Config)	1 x Slide Switch (Auto, RS-232 Config/ Access Control, Local)
LEDs	10/100/1000 Mbps	1 (10: Orange / 100: Orange & Green / 1000: Green)	
	Power	1 x Blue	
	Local	1 x Green	
	Remote	1 x Green	
Emulation	Keyboard / Mouse	USB	

Function		KE6910R	KE6910T
Power Consumption		DC 5V, 9.02 W	DC 5V, 10.02 W
Video Resolution		Up to 2560 x 2048 @ 50 Hz	
Environment	Operating Temp.	0–50°C	
	Storage Temp.	-20–60°C	
	Humidity	0–95% RH, Non-condensing	
Physical Properties	Housing	Metal	
	Weight	1.26 kg	1.13 kg
	Dimensions (L x W x H)	22.75 x 17.16 x 5.48 cm	21.5 x 16.33 x 4.18 cm

KE6912

Function		KE6912R	KE6912T
Connectors	Virtual Media	2 x USB Type A Female (White)	N/A
	Console Ports	2 x USB Type A Female (White)	2 x USB Type A Female (White)
		1 x DVI-D Female (White)	1 x DVI-D Female (White)
		1 x Mini Stereo Jack (Green)	1 x Mini Stereo Jack (Green)
		1 x Mini Stereo Jack (Pink)	1 x Mini Stereo Jack (Pink)
		1 x DB-9 Male (Black)	1 x DB-9 Male (Black)
	KVM Ports	N/A	1 x USB Type B Female (White)
			1 x DVI-D Female (White)
			1 x Mini Stereo Jack (Green)
			1 x Mini Stereo Jack (Pink)
		1 x DB-9 Male (Black)	
Power	1 x DC Jack (Black) 1 x RJ-45 (Black, PoE)	1 x DC Jack (Black) 1 x RJ-45 (Black, PoE)	
LAN	1 x RJ-45 (Black, PoE) 1 x SFP Slot	1 x RJ-45 (Black, PoE) 1 x SFP Slot	
Switches	OSD	1 x Pushbutton	N/A
	Video	1 x Pushbutton	N/A
	Graphics	1 x Pushbutton	N/A
	Reset	1 x Semi-recessed Pushbutton	
	Mode Selection	1 x Slide Switch (Extension, RS-232 Config)	1 x Slide Switch (Auto, RS-232 Config/ Access Control, Local)
LEDs	10/100/1000 Mbps	1 (10: Orange / 100: Orange & Green / 1000: Green)	
	Power	1 x Blue	
	Local	1 x Green	
	Remote	1 x Green	
Emulation	Keyboard / Mouse	USB	

Function		KE6912R	KE6912T
Power Consumption		DC48V / 11.27W (PoE)	DC48V / 12.53W (PoE)
Video Resolution		Up to 2560 x 2048 @ 50 Hz	
Environment	Operating Temp.	0–50°C	
	Storage Temp.	-20–60°C	
	Humidity	0–95% RH, Non-condensing	
Physical Properties	Housing	Metal	
	Weight	1.28 kg	1.17 kg
	Dimensions (L x W x H)	22.75 x 17.16 x 5.48 cm	21.5 x 16.33 x 4.18 cm

KE6920

Function		KE6920R	KE6920T
Connectors	Virtual Media	2 x USB Type A Female (White)	N/A
	Console Ports	2 x USB Type A Female (White)	2 x USB Type A Female (White)
		1 x DVI-D Female (White)	1 x DVI-D Female (White)
		1 x Mini Stereo Jack (Green)	1 x Mini Stereo Jack (Green)
		1 x Mini Stereo Jack (Pink)	1 x Mini Stereo Jack (Pink)
		1 x DB-9 Male (Black)	1 x DB-9 Male (Black)
	KVM Ports	N/A	1 x USB Type B Female (White)
			1 x DVI-D Female (White)
			1 x Mini Stereo Jack (Green)
			1 x Mini Stereo Jack (Pink)
	Power	2 x DC Jack (Black)	2 x DC Jack (Black)
LAN	1 x RJ-45 (Black) 2 x SFP Slot		
Switches	OSD	1 x Pushbutton	N/A
	Video	1 x Pushbutton	N/A
	Graphics	1 x Pushbutton	N/A
	Reset	1 x Semi-recessed Pushbutton	
	Mode Selection	1 x Slide Switch (Extension, RS-232 Config)	1 x Slide Switch (Auto, RS-232 Config/ Access Control, Local)
LEDs	10/100/1000 Mbps	1 (10: Orange / 100: Orange & Green / 1000: Green)	
	Power	1 x Blue	
	Local	1 x Green	
	Remote	1 x Green	
Emulation	Keyboard / Mouse	USB	

Function		KE6920R	KE6920T
Power Consumption		DC 5V, 8.86 W	DC 5V, 10.87 W
Video Resolution		Up to 2560 x 2048 @ 50 Hz / 2560 x 1600 @ 60 Hz	
Environment	Operating Temp.	0–50°C	
	Storage Temp.	-20–60°C	
	Humidity	0–95% RH, Non-condensing	
Physical Properties	Housing	Metal	
	Weight	1.27 kg (2.8 lb)	1.15 kg (2.53 lb)
	Dimensions (L x W x H)	22.75 x 17.16 x 5.48 cm (8.96 x 6.76 x 2.16 in.)	21.50 x 16.33 x 4.18 cm (8.46 x 6.43 x 1.65 in.)

KE6922

Function		KE6922R	KE6922T
Connectors	Virtual Media	2 x USB Type A Female (White)	N/A
	Console Ports	2 x USB Type A Female (White)	2 x USB Type A Female (White)
		1 x DVI-D Female (White)	1 x DVI-D Female (White)
		1 x Mini Stereo Jack (Green)	1 x Mini Stereo Jack (Green)
		1 x Mini Stereo Jack (Pink)	1 x Mini Stereo Jack (Pink)
		1 x DB-9 Male (Black)	1 x DB-9 Male (Black)
	KVM Ports	N/A	1 x USB Type B Female (White)
			1 x DVI-D Female (White)
			1 x Mini Stereo Jack (Green)
			1 x Mini Stereo Jack (Pink)
		1 x DB-9 Male (Black)	
Power	2 x DC Jack (Black) 1 x RJ-45 (Black, PoE)	2 x DC Jack (Black) 1 x RJ-45 (Black, PoE)	
LAN	1 x RJ-45 (Black, PoE) 2 x SFP Slot	1 x RJ-45 (Black, PoE) 2 x SFP Slot	
Switches	OSD	1 x Pushbutton	N/A
	Video	1 x Pushbutton	N/A
	Graphics	1 x Pushbutton	N/A
	Reset	1 x Semi-recessed Pushbutton	
	Mode Selection	1 x Slide Switch (Extension, RS-232 Config)	1 x Slide Switch (Auto, RS-232 Config/ Access Control, Local)
LEDs	10/100/1000 Mbps	1 (10: Orange / 100: Orange & Green / 1000: Green)	
	Power	1 x Blue	
	Local	1 x Green	
	Remote	1 x Green	
Emulation	Keyboard / Mouse	USB	

Function		KE6922R	KE6922T
Power Consumption		DC48V / 11.54W	DC48V / 13.59W
Video Resolution		Up to 2560 x 2048 @ 50 Hz / 2560 x 1600 @ 60 Hz	
Environment	Operating Temp.	0–50°C	
	Storage Temp.	-20–60°C	
	Humidity	0–95% RH, Non-condensing	
Physical Properties	Housing	Metal	
	Weight	1.30 kg (2.86 lb)	1.18 kg (2.6 lb)
	Dimensions (L x W x H)	22.75 x 17.16 x 5.48 cm (8.96 x 6.76 x 2.16 in.)	21.50 x 16.33 x 4.18 cm (8.46 x 6.43 x 1.65 in.)

KE8900S

Function		KE8900SR	KE8900ST
Connectors	Virtual Media	2 x USB Type A Female (Black)	N/A
	Console Ports	2 x USB Type A Female (Black)	N/A
		1 x HDMI Female (Black)	
		1 x DB-9 Male (Black)	
	KVM Ports	N/A	1 x USB Type B Female (White)
			1 x HDMI Female (Black)
			1 x DB-9 Male (Black)
Power	1 x DC Jack (Black)	1 x DC Jack (Black)	
		1 x 3-Pole Terminal Block Connector (Green)	
LAN	1 x RJ-45 (Black)		
Switches	Reset	1 x Semi-recessed Pushbutton	
LEDs	10/100/1000 Mbps	1 (10: Orange / 100: Orange & Green / 1000: Green)	
	Power	1 x Blue	
Emulation	Keyboard / Mouse	USB	
Power Consumption		DC 5V, 4.35 W	DC 5V, 3.8 W DC 48V, 5.53 W
Video Resolution		Up to 1920 x 1200 @ 60 Hz	
Environment	Operating Temp.	0–50°C	
	Storage Temp.	-20–60°C	
	Humidity	0–95% RH, Non-condensing	
Physical Properties	Housing	Metal	
	Weight	0.64 kg	0.65 kg
	Dimensions (L x W x H)	18.20 x 11.75 x 2.87 cm	

KE8950T / KE8952T

Function		KE8950T	KE8952T	
Connectors	Console Ports	Keyboard	1 x USB Type A Female (White)	
		Video	1 x HDMI Female (Silver)	
		Mouse	1 x USB Type A Female (White)	
		Speaker	1 x Mini Stereo Jack Female (Green)	
		Mic.	1 x Mini Stereo Jack Female (Pink)	
		RS-232	1 x DB-9 Male (Black)	
	KVM Ports	KB / Mouse	1 x USB Type B Female (White)	
		Speaker	1 x Mini Stereo Jack (Green)	
		Mic.	1 x Mini Stereo Jack (Pink)	
		Video	1 x HDMI Female (Silver)	
		RS-232	1 x DB-9 Female (Black)	
	LAN		1 x RJ-45 Female (Black)	1 x RJ-45 Female (Black; PoE)
	LAN		1 x SFP Module Female (Black)	
	Power		1 x DC Jack (Black)	
Switches	Function	1 x Slide Switch (Black) (Auto, RS-232 Config, Local)		
	Reset	1 x Semi-recessed Pushbutton		
LEDs	LAN	1 (10: Orange / 100: Orange & Green / 1000: Green)		
	Power	1 x Blue		
	Local	1 x Green		
	Remote	1 x Green		
Emulation	Keyboard / Mouse	USB		
Power Consumption		DC 5V, 7.22 W	DC48V, 9.02W (PoE)	
Video Resolution		Up to 3840 x 2160 @ 30 Hz (4:4:4)		
Environment	Operating Temp.	0–50°C		
	Storage Temp.	-20–60°C		
	Humidity	0–95% RH, Non-condensing		
Physical Properties	Housing	Metal		
	Weight	1.10 kg (2.42 lb)	1.13 kg (2.49 lb)	
	Dimensions (L x W x H)	21.50 x 16.29 x 4.18 cm (8.46 x 6.41 x 1.65 in.)		

KE8950R / KE8952R

Function		KE8950R	KE8952R	
Connectors	USB Virtual Media	2 x USB Type A Female (White)		
	Console Ports	Keyboard	1 x USB Type A Female (White)	
		Video	1 x HDMI Female (Silver)	
		Mouse	1 x USB Type A Female (White)	
		Speaker	1 x Mini Stereo Jack Female (Green)	
		Mic.	1 x Mini Stereo Jack Female (Pink)	
	RS-232	1 x DB-9 Male (Black)		
	LAN	1 x RJ-45 Female (Black)	1 x RJ-45 Female (Black; PoE)	
	LAN	1 x SFP Module Female (Black)		
Power	1 x DC Jack (Black)			
Switches	OSD	1 x Pushbutton		
	Video	1 x Pushbutton		
	Graphics	1 x Pushbutton		
	Function	1 x Slide Switch (Black) (Extension, RS-232 Config)		
	Reset	1 x Semi-recessed Pushbutton		
LEDs	LAN	1 (10: Orange / 100: Orange & Green / 1000: Green)		
	Power	1 x Blue		
	Local	1 x Green		
	Remote	1 x Green		
Emulation	Keyboard / Mouse	USB		
Power Consumption		DC 5V, 5.65 W	DC48V, 7.06W (PoE)	
Video Resolution		Up to 3840 x 2160 @ 30 Hz (4:4:4)		
Environment	Operating Temp.	0–50°C		
	Storage Temp.	-20–60°C		
	Humidity	0–95% RH, Non-condensing		
Physical Properties	Housing	Metal		
	Weight	1.23 kg (2.71 lb)	1.26 kg (2.78 lb)	
	Dimensions (L x W x H)	22.75 x 17.16 x 5.48 cm (8.96 x 6.76 x 2.16 in.)		

KE9900ST

Function		KE9900ST
Connectors	KVM Ports	1 x USB Type B Female (White)
		1 x DisplayPort Female (Black)
		1 x DB-9 Male (Black)
	Power	1 x DC Jack (Black)
		1 x 3-Pole Terminal Block Connector (Green)
LAN	1 x RJ-45 (Black)	
Switches	Reset	1 x Semi-recessed Pushbutton
LEDs	10/100/1000 Mbps	1 (10: Orange / 100: Orange & Green / 1000: Green)
	Power	1 x Blue
Emulation	Keyboard / Mouse	USB
Power Consumption		DC 5V, 4.75 W; DC 48V, 6.97 W
Video Resolution		Up to 1920 x 1200 @ 60 Hz
Environment	Operating Temp.	0–50°C
	Storage Temp.	-20–60°C
	Humidity	0–95% RH, Non-condensing
Physical Properties	Housing	Metal
	Weight	0.65 kg (1.43 lb)
	Dimensions (L x W x H)	18.20 x 11.75 x 2.87 cm (7.17 x 4.63 x 1.13 in.)

KE9950

Function		KE9950R	KE9950T
Connectors	Virtual Media	2 x USB Type A Female (White)	N/A
	Console Ports	2 x USB Type A Female (White)	
		1 x DisplayPort Female (Black)	
		1 x Mini Stereo Jack (Green)	
		1 x Mini Stereo Jack (Pink)	
		1 x DB-9 Male (Black)	
	KVM Ports	N/A	1 x USB Type B Female (White)
			1 x DisplayPort Female (Black)
			1 x Mini Stereo Jack (Green)
			1 x Mini Stereo Jack (Pink)
1 x DB-9 Male (Black)			
Power	2 x DC Jack (Black)		
LAN	1 x RJ-45 (Black) 1 x SFP Slot		
Switches	OSD	1 x Pushbutton	N/A
	Video	1 x Pushbutton	N/A
	Graphics	1 x Pushbutton	N/A
	Reset	1 x Semi-recessed Pushbutton	
	Mode Selection	1 x Slide Switch (Extension, RS-232 Config)	1 x Slide Switch (Auto, RS-232 Config/ Access Control, Local)
LEDs	10/100/1000 Mbps	1 (10: Orange / 100: Orange & Green / 1000: Green)	
	Power	1 x Blue	
	Local	1 x Green	
	Remote	1 x Green	
Emulation	Keyboard / Mouse	USB	
Power Consumption		DC 5V, 8.03 W	DC 5V, 9.51 W
Video Resolution		Up to 3840 x 2160 @ 30 Hz	

Function		KE9950R	KE9950T
Environment	Operating Temp.	0–50°C	
	Storage Temp.	-20–60°C	
	Humidity	0–95% RH, Non-condensing	
Physical Properties	Housing	Metal	
	Weight	1.24 kg (2.73 lb)	1.12 kg (2.47 lb)
	Dimensions (L x W x H)	22.75 x 17.16 x 5.48 cm (8.96 x 6.76 x 2.16 in.)	21.50 x 16.29 x 4.18 cm (8.46 x 6.41 x 1.65 in.)

KE9952

Function		KE9952R	KE9952T
Connectors	Virtual Media	2 x USB Type A Female (White)	N/A
	Console Ports	2 x USB Type A Female (White)	
		1 x DisplayPort Female (Black)	
		1 x Mini Stereo Jack (Green)	
		1 x Mini Stereo Jack (Pink)	
		1 x DB-9 Male (Black)	
	KVM Ports	N/A	1 x USB Type B Female (White)
			1 x DisplayPort Female (Black)
1 x Mini Stereo Jack (Green)			
1 x Mini Stereo Jack (Pink)			
1 x DB-9 Male (Black)			
Power	1 x DC Jack (Black) 1 x RJ-45 (Black, PoE)	1 x DC Jack (Black) 1 x RJ-45 (Black, PoE)	
LAN	1 x RJ-45 (Black, PoE) 1 x SFP Slot	1 x RJ-45 (Black, PoE) 1 x SFP Slot	
Switches	OSD	1 x Pushbutton	N/A
	Video	1 x Pushbutton	
	Graphics	1 x Pushbutton	
	Reset	1 x Semi-recessed Pushbutton	
	Mode Selection	1 x Slide Switch (Extension, RS-232 Config)	1 x Slide Switch (Auto, RS-232 Config/ Access Control, Local)
LEDs	10/100/1000 Mbps	1 (10: Orange / 100: Orange & Green / 1000: Green)	
	Power	1 x Blue	
	Local	1 x Green	
	Remote	1 x Green	
Emulation	Keyboard / Mouse	USB	
Power Consumption		DC48V / 10.04W (PoE)	DC48V / 11.88W (PoE)

Function		KE9952R	KE9952T
Video Resolution		Up to 3840 x 2160 @ 30 Hz	
Environment	Operating Temp.	0–50°C	
	Storage Temp.	-20–60°C	
	Humidity	0–95% RH, Non-condensing	
Physical Properties	Housing	Metal	
	Weight	1.27 kg (2.8 lb)	1.15 kg (2.53 lb)
	Dimensions (L x W x H)	22.75 x 17.16 x 5.48 cm (8.96 x 6.76 x 2.16 in.)	21.50 x 16.29 x 4.18 cm (8.46 x 6.41 x 1.65 in.)

Optional Rack Mounting

For convenience and flexibility, three optional rack mounting kits are available as shown in the following table:

Mounting Type	Model
Dual Rack Mount Kit*	2X-021G
Single Rack Mount Kit*	2X-031G
Video Extender Rack Mount Kit** (for KE6900ST, KE8900ST, KE8900SR and KE9900ST)	VE-RMK 1U

*Supports KE6900/KE6900A/KE6910/KE6912/KE6920/KE6922/KE6940/KE6940A/KE8950/KE8952/KE9950/KE9952.

**Please refer to VE-RMK 1U User Manual on how to mount these units.

Dual Rack Mounting

The 2X-021G Dual Rack Mounting Kit installs two KE6900/KE6900A/KE6910/KE6912/KE6920/KE6922/KE6940/KE6940A/KE8950/KE8952/KE9950/KE9952 units side by side in 1U of server rack space.

Transmitter Dual Rack Mounting

KE8950T is the example used here.

1. Remove four screws from the units and then use the same screws to secure the units together with the link bracket provided with the kit.

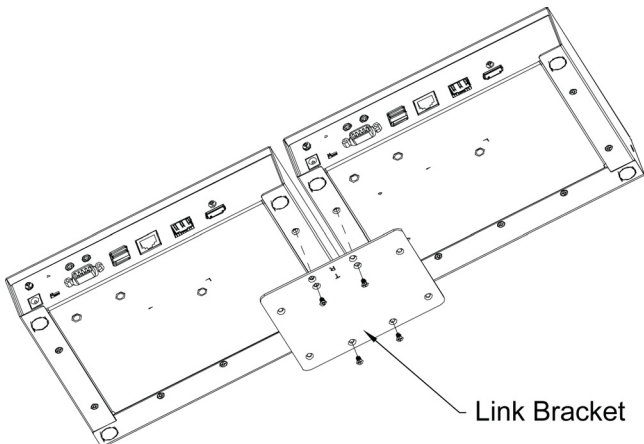

2. Remove the bottom and side screws from each unit.

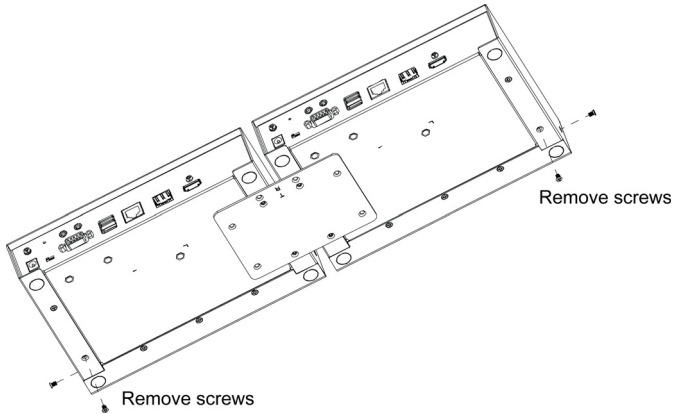

3. Use the screws in step 2 to install the left and right mounting brackets.

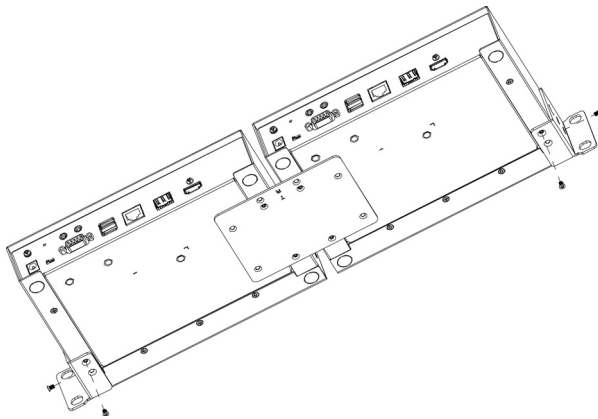

4. Screw the mounting brackets to the rack.

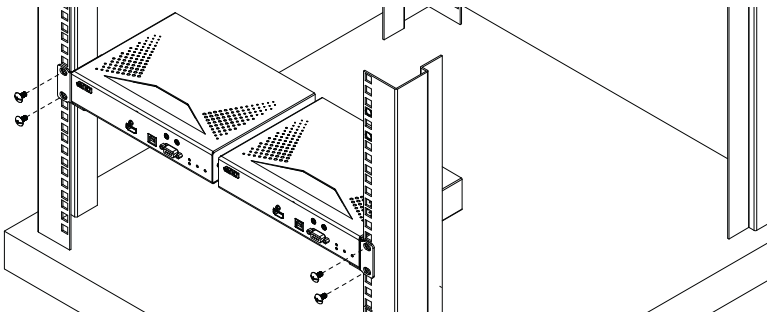

Receiver Dual Rack Mounting

KE8950R is the example used here.

1. Remove the eight screws and plastic guards from the receiver units.

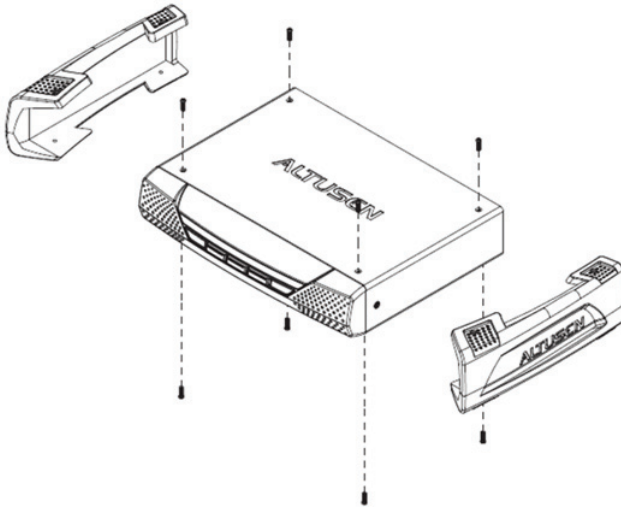

2. Remove four screws from the units and then use the same screws to secure the units together with the link bracket provided with the kit.

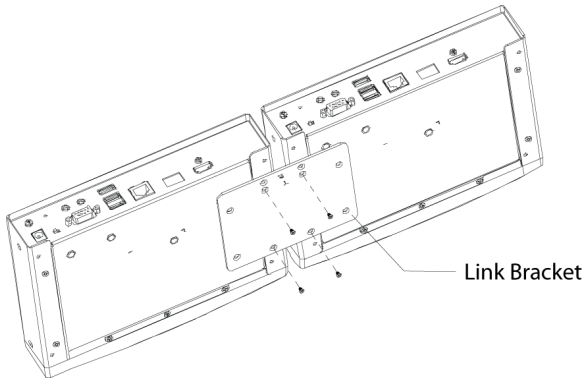

3. Remove the bottom and side screws from each unit.

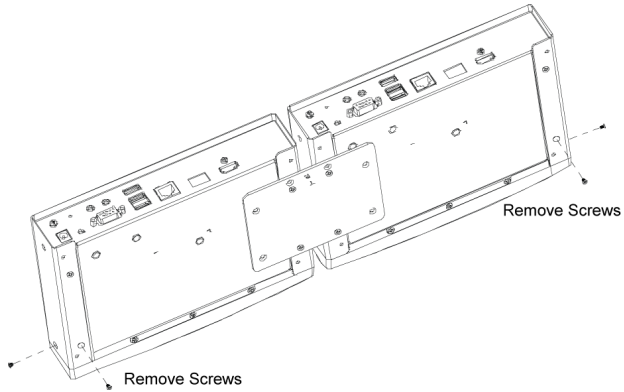

4. Use the screws in step 3 to install the left and right mounting brackets.

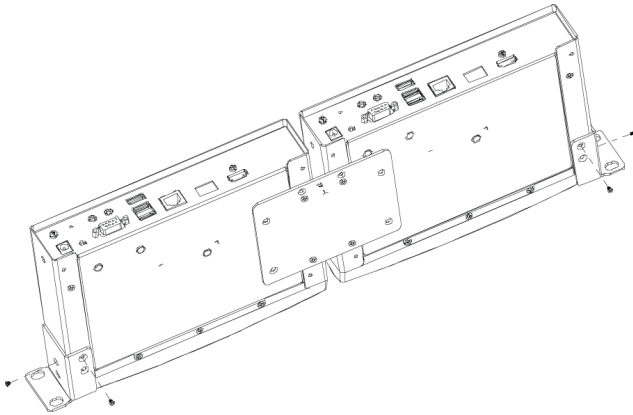

5. Screw the mounting brackets to the rack.

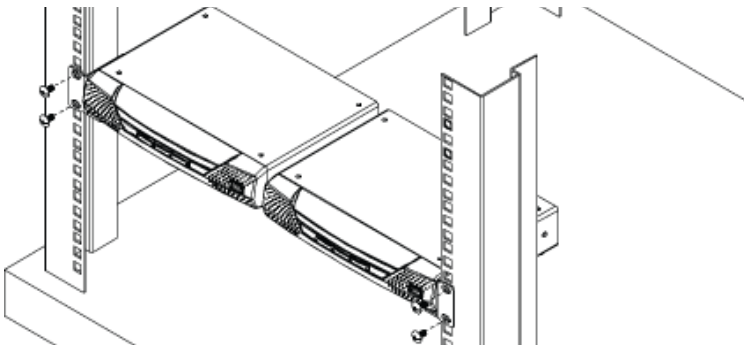

Single Rack Mounting

The 2X-031G Single Rack Mounting kit installs one KE6900/KE6940/KE8950/KE8952 unit in 1U of server rack space.

1. Remove the eight screws and plastic guards from the unit (Receiver units only).

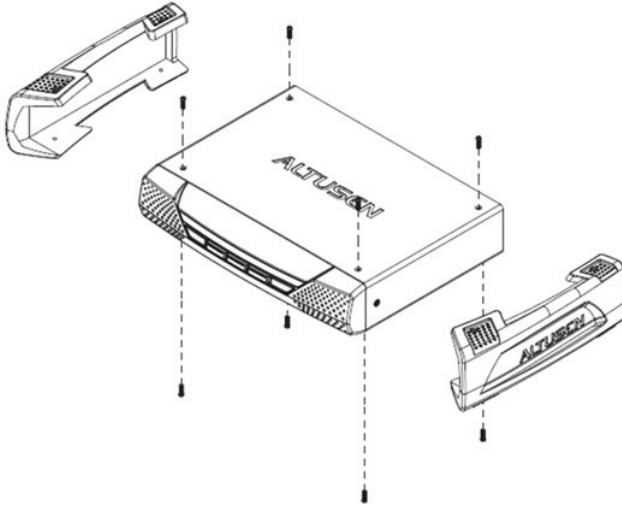

2. Remove the bottom and side screws from the unit.

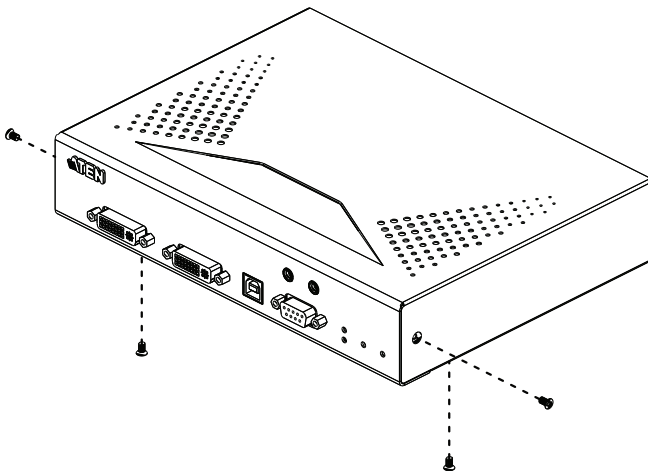

3. Use the screws in step 2 to install the right and left mounting brackets.

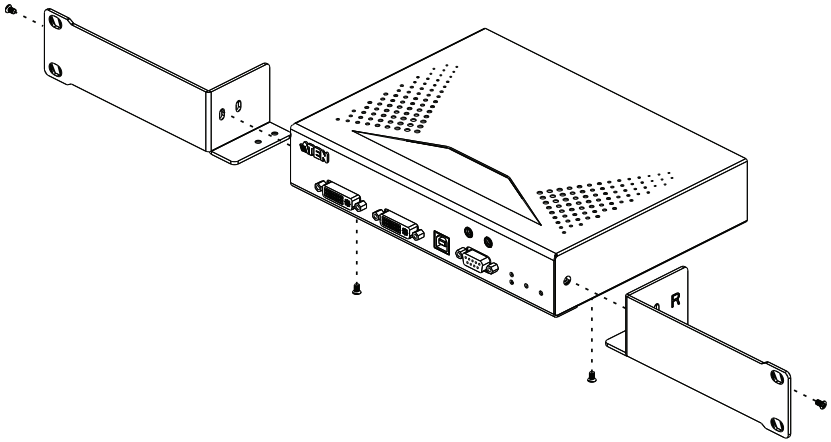

4. Screw the mounting brackets to the rack.

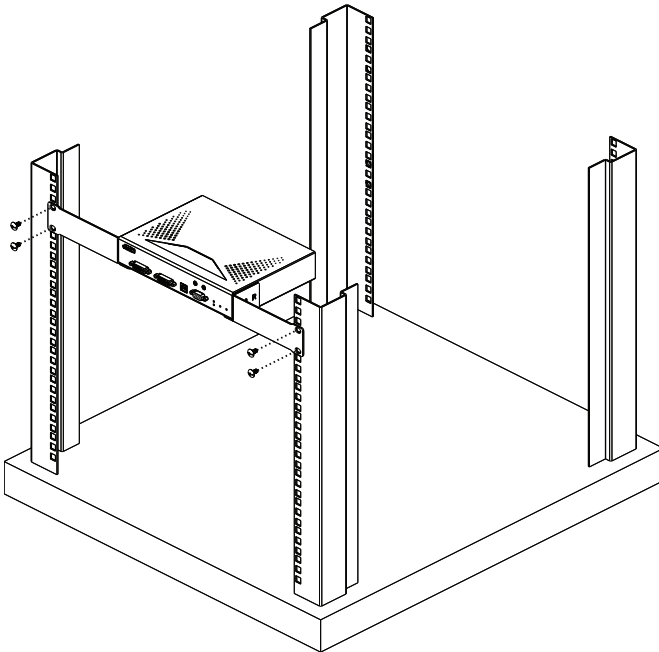

IP Installer

From a client computer running Windows, an IP address for a transmitter or receiver can be assigned with the IP Installer utility. The utility can be obtained from the Download area of our website or from the product page on the *Software & Driver* tab. After downloading the utility to your client computer, do the following:

1. Unzip the contents of IPInstaller.zip to a directory on your hard drive.
2. Go to the directory that you unzipped the IPInstaller program to and run IPInstaller.exe. A dialog box similar to the one below appears:

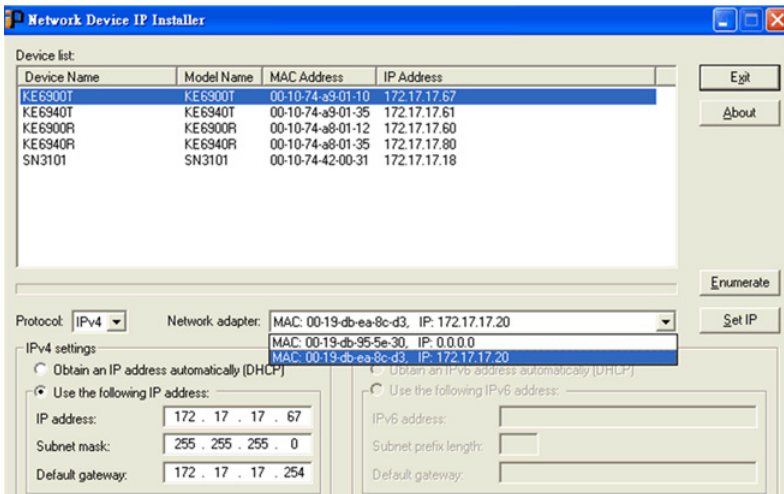

3. Select the Transmitter or Receiver in the Device List.

Note: 1. If the list is empty, or your device doesn't appear, click **Enumerate** to refresh the Device List.

2. If there is more than one device in the list, use the MAC address to pick the one you want. The MAC address is located on the devices bottom panel.

4. Select either *Obtain an IP address automatically (DHCP)*, or *Specify an IP address*. If you chose the latter, fill the IP Address, Subnet Mask, and Gateway fields with the information appropriate to your network.
5. Click **Set IP**.
6. After the IP address shows up in the Device List, click **Exit**.

Trusted Certificates

Overview

When you try to log in to the device from your browser, a Security Alert message appears to inform you that the device's certificate is not trusted, and asks if you want to proceed.

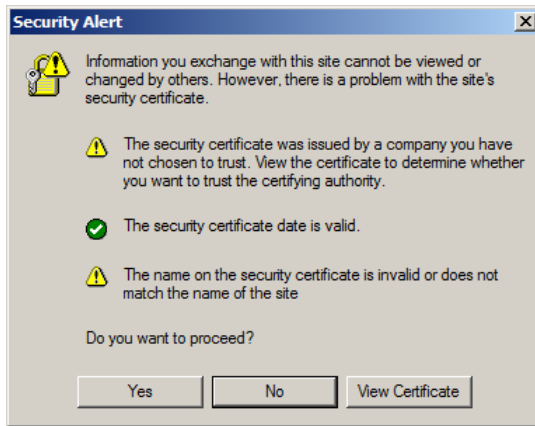

The certificate can be trusted, but the alert is triggered because the certificate's name is not found on the Microsoft list of Trusted Authorities. You can ignore the warning and click **Yes** to go on.

Self-Signed Private Certificates

If you wish to create your own self-signed encryption key and certificate, a free utility – `openssl.exe` – is available for download over the web at www.openssl.org. To create your private key and certificate do the following:

1. Go to the directory where you downloaded and extracted *openssl.exe* to.
2. Run `openssl.exe` with the following parameters:

```
openssl req -new -newkey rsa:1024 -days 3653 -nodes -x509  
-keyout CA.key -out CA.cer -config openssl.cnf
```

-
- Note:**
1. The command should be entered all on one line (i.e., do not press [Enter] until all the parameters have been keyed in).
 2. If there are spaces in the input, surround the entry in quotes (e.g., “ATEN International”).
-

To avoid having to input information during key generation the following additional parameters can be used:

```
/C /ST /L /O /OU /CN /emailAddress .
```

Examples

```
openssl req -new -newkey rsa:1024 -days 3653 -nodes -x509  
-keyout CA.key -out CA.cer -config openssl.cnf -subj  
"/C=yourcountry/ST=yourstateorprovince/L=yourlocationor  
city/O=yourorganization/OU=yourorganizationalunit/  
CN=yourcommonname/emailAddress=name@yourcompany.com
```

```
openssl req -new -newkey rsa:1024 -days 3653 -nodes -x509  
-keyout CA.key -out CA.cer -config openssl.cnf -subj  
"/C=CA/ST=BC/L=Richmond/O=ATEN International/OU=ATEN  
/CN=ATEN/emailAddress=eservice@aten.com.tw
```

Importing the Files

After the `openssl.exe` program completes, two files – `CA.key` (the private key) and `CA.cer` (the self-signed SSL certificate) – are created in the directory that you ran the program from.

Reset All Information

To reset all information (including passwords) to their default settings, follow the steps below:

1. Power off the unit and remove its housing.
2. Use a jumper cap to short the mainboard pins labeled **DEFAULT PASSWORD**. An example is shown:

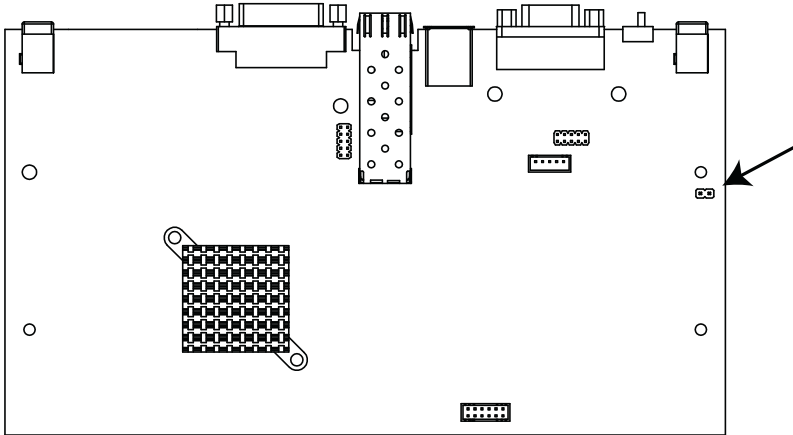

3. Power on the unit.
4. After the unit is turned on, power off the unit.
5. Remove the jumper cap from the **Reset** pins and close the housing.
6. Power on the unit again.

After powering on the unit, you can use the default administrator Username and Password (see *Logging In*, page 169) to log in.

Default Password Pins

The **Default Password** pins for different models are shown below.

■ KE6900ST

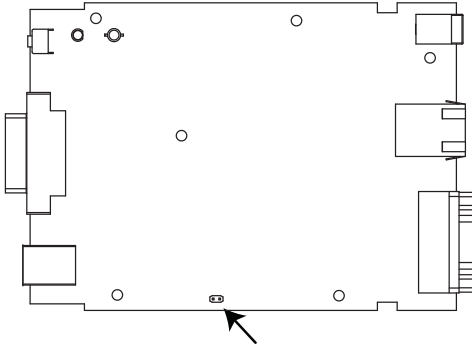

■ KE6900AR

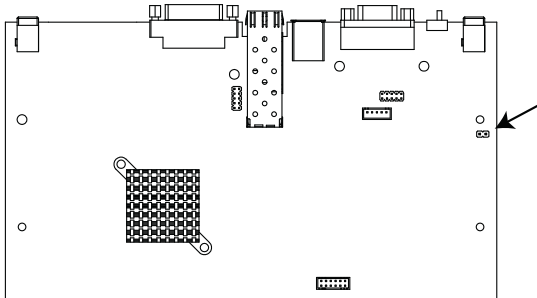

■ KE6900AT

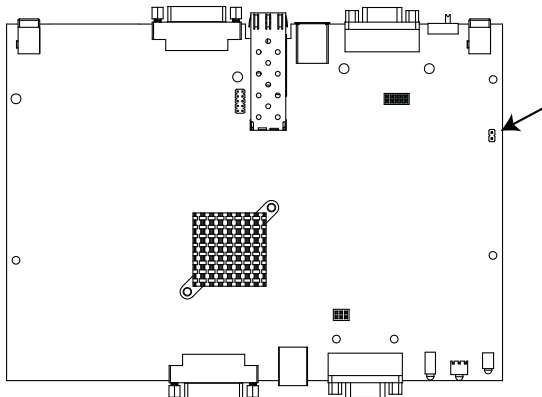

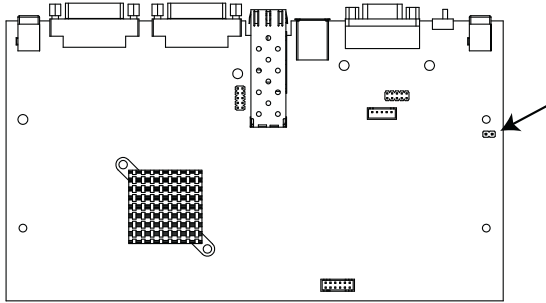
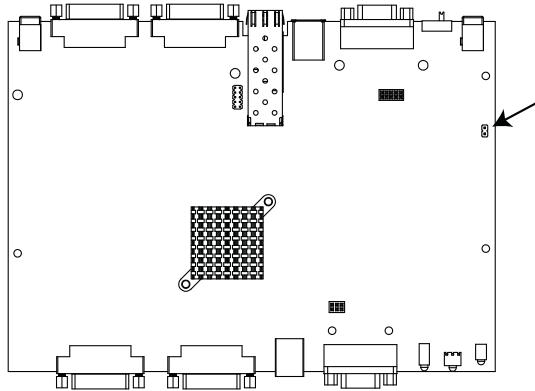
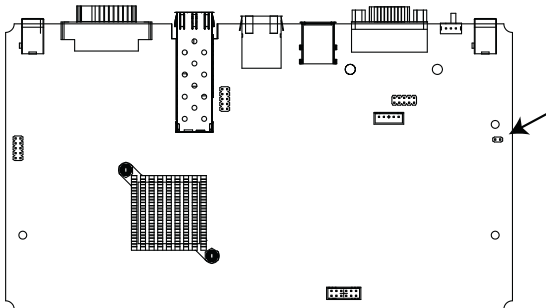
■ KE6940AR**■ KE6940AT****■ KE6910R / KE6912R**

■ KE6910T / KE6912T

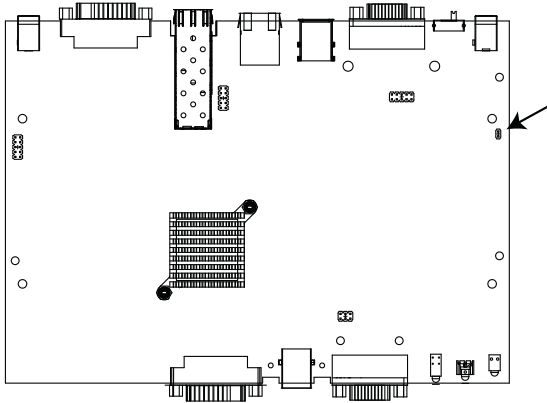

■ KE6920R / KE6922R

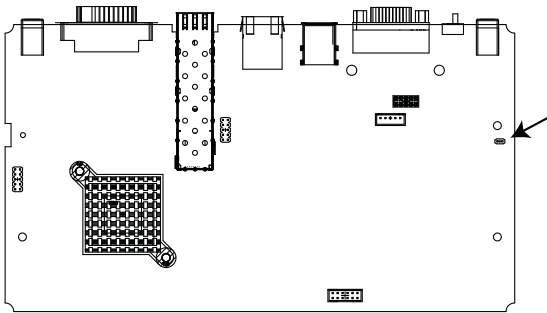

■ KE6920T / KE6922T

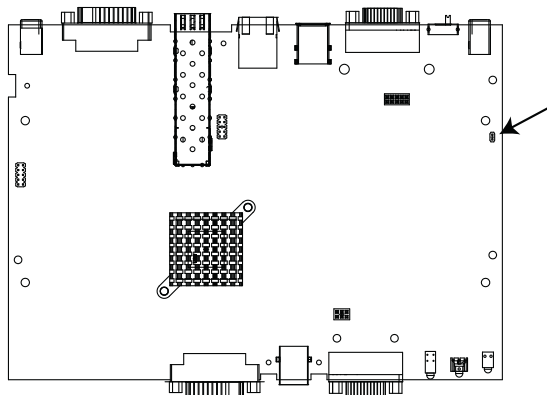

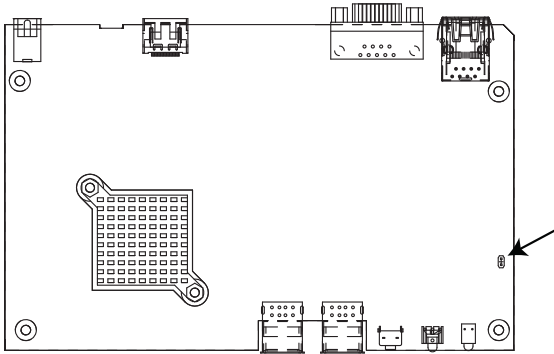
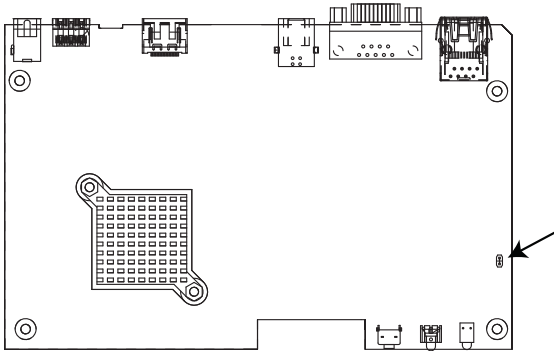
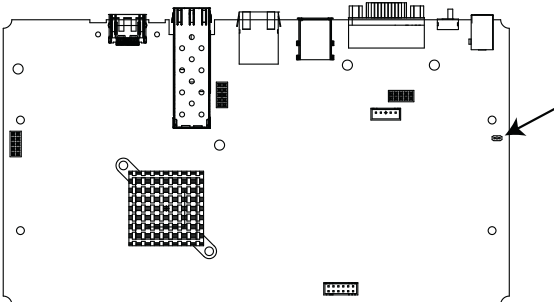
■ KE8900SR**■ KE8900ST****■ KE8950R / KE8952R**

■ KE8950T / KE8952T

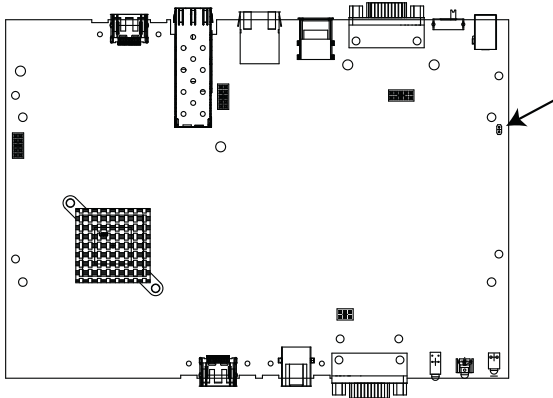

■ KE9900ST

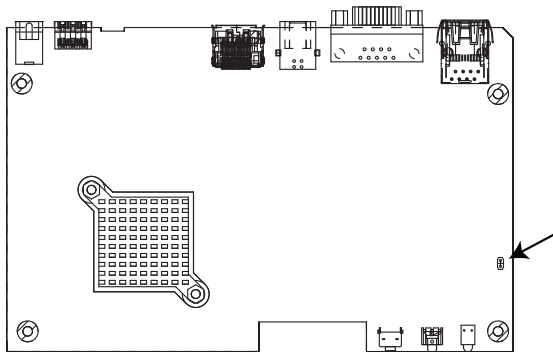

■ KE9950R / KE9952R

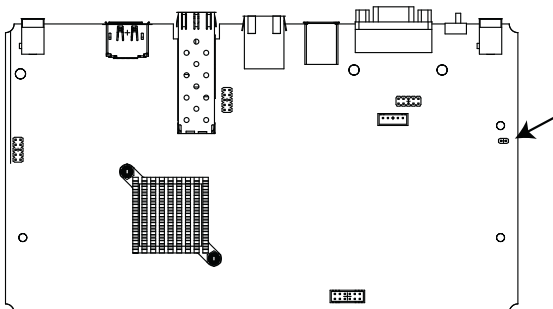

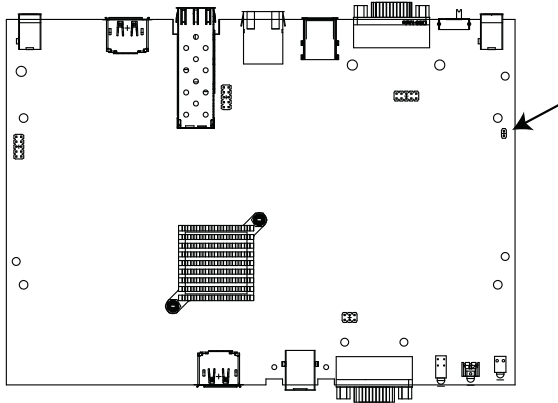
■ KE9950T / KE9952T

RS-232 Pin Assignments

Pin assignments for the Transmitter and Receiver's rear RS-232 port that is used for connecting to a serial terminal are given in the table, below:

Pin	Assignment	
1	N/A	None
2	RXD	Receive Data
3	TXD	Transmit Data
4	DTR	Data Terminal Ready
5	GND	Signal Ground
6	DSR	Data Set Ready
7	RTS	Request to Sent
8	CTS	Clear to Sent
9	N/A	None

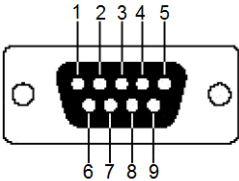

DB9 Male

Transmitter Front RS-232 Port

Pin assignments for the Transmitter's front RS-232 port that is used for connecting to a computer for serial control are given in the table, below:

Pin	Assignment	
1	N/A	None
2	TXD	Transmit Data
3	RXD	Receive Data
4	DSR	Data Set Ready
5	GND	Signal Ground
6	DTR	Data Terminal Ready
7	CTS	Clear to Sent
8	RTS	Request to Sent
9	N/A	None

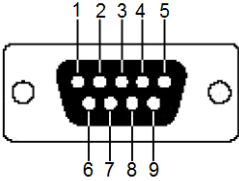

DB9 Female

Multicast IP Address

Multicasting helps to broadcast audio and video data from a transmitter to multiple Receivers over a network. To setup up Multicasting on a network switch you must know the Audio and Video Multicast IP address which can be found on the KE Transmitter. To determinate the default Multicast IP address set by the KE device use the instructions below. The Multicast IP addresses can be set manually using Telnet.

KE Multicast Rule

All Audio and Video Multicast IP addresses use the format: 230.X.Y.Z.

X.Y.Z relates to the Transmitter's IP address and **230** is always the first octet of a Multicast IP address. You use the Transmitter's IP address to find **X** and then use it to calculate the Audio and Video Multicast IP address.

Multicast IP Formula

To calculate the Audio and Video Multicast IP address, use the Transmitter's IP address to determine **X** and then use the appropriate table below to calculate the Multicast IP address for each data stream (audio/video).

Example:

Transmitter IP Address: 172.16.27.146; (172.X.Y.Z)

X =16

If X is between 0 ~ 127

Transmitter IP	X	Video X + 128	Audio X + 192	Multicast Video IP Address	Multicast Audio IP Address
172.16.27.146 (example)	16	$\underline{16} + 128 =$ 144	$\underline{16} + 192 =$ 208	230.144.27.146	230.208.27.146
		___ + 128 =	___ + 192 =	230.____.____.____	230.____.____.____
		___ + 128 =	___ + 192 =	230.____.____.____	230.____.____.____
		___ + 128 =	___ + 192 =	230.____.____.____	230.____.____.____

If X is between 128 ~ 192

Transmitter IP	X - 128 = A	Video A + 128	Audio A + 192	Multicast Video IP Address	Multicast Audio IP Address
172.168.27.14 (example)	168 - 128 = 40	40 + 128 = 168	40 + 192 = 232	230.168.27.14	230.232.27.14
	___ - 128 =	___ + 128 =	___ + 192 =	230.	230.
	___ - 128 =	___ + 128 =	___ + 192 =	230.	230.
	___ - 128 =	___ + 128 =	___ + 192 =	230.	230.

If X is 192 or higher

Transmitter IP	X - 192 = A	Video A + 128	Audio A + 192	Multicast Video IP Address	Multicast Audio IP Address
172.200.27.14 (example)	200 - 192 = 8	8 + 128 = 136	8 + 192 = 200	230.136.27.14	230.200.27.14
	___ - 192 =	___ + 128 =	___ + 192 =	230.	230.
	___ - 192 =	___ + 128 =	___ + 192 =	230.	230.
	___ - 192 =	___ + 128 =	___ + 192 =	230.	230.

Keys to Network Performance

For optimum performance, KE Series devices requires high amounts of data to be transferred across a network; therefore we recommend the following strategies to setup KE Series devices. Using our suggestions will provide better performance and the highest video resolutions possible. Use each of the keys to ensure the best transmission of data and the highest throughput possible.

Build a Network Diagram

To build an effective KE installation, start by mapping out the layout. Create a diagram with the KE devices, computers and routers along with how they will be connected across the network. It also helps to write out how the devices will interact. Use this diagram as the frame work as you decide what devices to purchase and how to build the network effectively for the best data throughput.

Considerations:

- ◆ If possible, create a private network for the KE devices
- ◆ Use the same switch model throughout
- ◆ Use a flat cascaded layout
- ◆ Avoid a tree or pyramid structure
- ◆ Limit cascades to two levels
- ◆ Install network switches near each other
- ◆ Minimize the distance of connections
- ◆ Install KE Matrix Manager (CCKM) computer and KE devices on the same subnet
- ◆ Check the 3 Other Factors before installation

Other Factors

■ Choose the Right Cable

Always use Cat 5/6e Ethernet cable or higher installed by a professional between any two devices you are installing. We recommend using ATEN Brand Ethernet cable to ensure the quality. It's best when installing KE devices to use brand new Ethernet cabling for each part of the installation to ensure the reliability of the data being transmitted. This is a key to getting the best uninterrupted video resolution across the network.

■ Determine the Distance

Distance is an important factor when setting up networks, with a shorter distance and fewer hops through routers, data can be transmitted more efficiently. So whenever possible decrease the distance and direct network traffic effectively between subnets that communicate with each other to increase the data throughput.

■ Ensure the Bandwidth

Ensuring the bandwidth ahead of time will guarantee performance before installing KE devices on a network. This will eliminate the primary cause of problems related to video quality and transmission of data. If the speed is right at all ends of your network, then the only other causes are derived from device failure or limits caused by a router, switch or device setting.

Sample Network Diagram

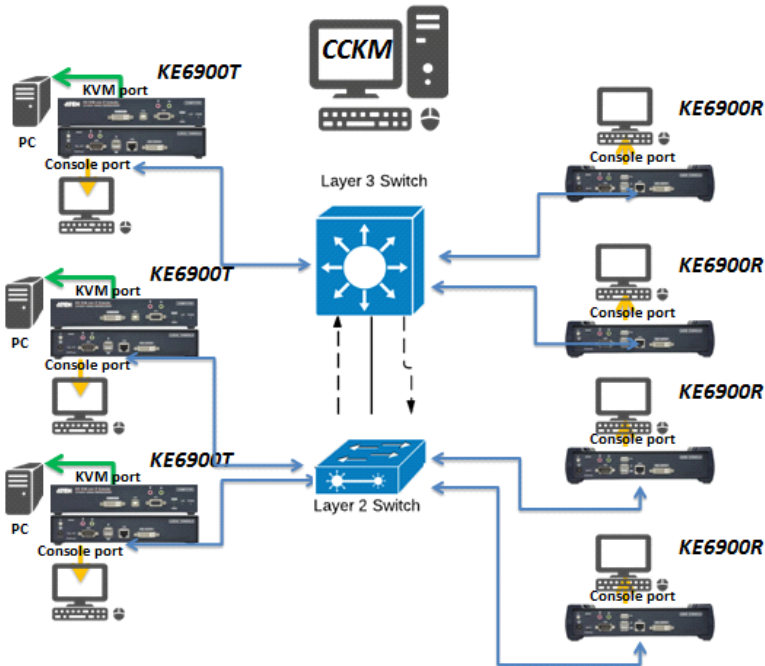

Choose a High Performance Switch

A high performance network switch is the means of a successful KE setup. When choosing a network switch, first select the type:

Layer 2 or Layer 3 Switches

You'll need to determine whether you need a layer 2 or a layer 3 switch for your KE network. Layer 3 switches cost more than layer 2 switches because they are more complex and handle more network traffic. The best way to calculate which type of switch you need is to first determine if you will have a dedicated network for the KE devices or if the KE devices will be on a network that shares throughput with other network equipment such as computers, servers and printers. If they share the network with other devices its best to consider a layer 3 switch and use layer 2 switches exclusively for the KE device connections. For larger installations we recommend using Layer 3 switches. The major differences are:

Layer 3 Switch: IP addresses in packets are examined and intelligent forwarding decisions are made. On a larger network broken into subnets across long distances, a layer 3 switch becomes the best choice as they can improve network efficiency and provide better traffic flow. They are better at directing more traffic to different locations on a larger more complex network, and with layer two switches working below them.

Layer 2 Switch: Packets are examined and forwarded using only the MAC address. If you have a small central network, a layer 2 switch should do the job. If the network is exclusive and will only transmit the bandwidth of KE devices, layer 2 switches with the correct settings can get the job done effectively.

Considerations

Number of ports

Choose a switch that has enough ports to match the number of KE devices you will be installing. Switches typically come in 5, 8, 10, 16, 24, 28, 48, and 52-port configurations. If you are installing 13 KE transmitters and 13 KE receivers, you will need to purchase a switch with at least 28 ports.

Stackable verse Standalone

Stackable switches allow you to easily manage and configure ports spanning across multiple switches that the KE devices are connected through. This provides a centralized method to configure and troubleshoot the initial setup of

KE devices on a network which makes fine tuning the bandwidth, data throughput and video quality easier. Stackable switches can be configured to direct the KE transmissions between many units more specifically and effectively. Standalone switches provide the same configuration features as Stackable switches but they must be set individually.

Stackable switches provide an easy way to manage multiple switches, as one unit. For example, instead of configuring, managing, and troubleshooting 6 28-port switches individually, you can manage the six as if they are a single unit using Stackable Switches. The six switches (168 ports) function as a single switch and are managed from one web or GUI interface.

What Stackable Switches Can do:

1. Create a link aggregation group with one port in one unit of the stack and another port of that group in another switch in the stack.
2. Select a port on one switch in the stack and mirror the traffic to a switch port on another unit of the stack; thus copy the configuration to direct traffic more effectively between KE devices.
3. Apply custom ACL security settings to any port on any switch in the stack.
4. Stackable switches can be setup in a ring configuration, so that if a port or cable fails, the stack automatically routes around the failure, at microsecond speeds. Stackable Switches also allow you to add and remove stack “members” which are automatically updated and recognized as such.

Switch Specifications

The following specifications are recommended when choosing a layer 2 or layer 3 switch:

- ◆ 1000Mbps Gigabit Ethernet switches (1000Mbps or faster Ethernet ports)
- ◆ High bandwidth between switches, if possible using Fibre Channel
- ◆ Layer 3 switches that efficiently processes IGMP queries
- ◆ IGMP Snooping v2 or v3
- ◆ Flow Control Functions
- ◆ Throughput of: Full Duplex, 1Gbps up- and down- stream speeds per port
- ◆ Performance of their most onerous tasks (e.g. IGMP snooping) with multiple dedicated processors (ASICs)
- ◆ Use the same switch make and model throughout each subnet

- ◆ The maximum number of simultaneous ‘snoopable groups’ the switch can handle meets or exceeds the number of KE transmitters that will be used to create Channel groups

Configuring Switches and KE Devices

Configuring the switch correctly will pass data more efficiently, allowing a better stream across the network to each KE device. The following settings will help optimize your network traffic through a switch:

- ◆ Enable IGMP Snooping on L2 switches
- ◆ Enable IGMP Querier on the L3 switch
- ◆ Enable IGMP Fast-Leave on all switches where KE units are directly connected
- ◆ Enable Spanning Tree Protocol (STP) on all switches and enable Portfast exclusively on switch ports that have KE units connected
- ◆ Pick an appropriate forwarding mode on all switches. Use Cut-through if available, or Store and Forward (see *Recommended Network Switches* below)

KE transmitter Settings:

- ◆ Adjust the KE transmitter settings one at a time, in small intervals, and view the images as you do, so that you can adjust to the positive or negative results and achieve the best quality and bandwidth possible
- ◆ If the quality of color is important, set the Color Depth to 24 bits (KE69 Series) or 36 bits (KE89 Series) and manually adjust other settings until you are satisfied with the visual appearance
- ◆ If moving video images are shown frequently, increase the Video Quality setting to the highest level and reduce the Bandwidth Limit and Color Depth setting.
- ◆ When images on the screen are more often static, increase the Background Refresh and/or the Video Quality settings
- ◆ Check that all KE units have been updated with the latest firmware version

Recommended Network Switches

Below are the network switches that have passed ATEN's stress tests using the KE Series extenders. Our tests streamed content over a network with a resolution of 1920 x 1200 @60Hz (KE69 Series, KE8900S, KE9900ST); 24 bit color depth and 3840 x 2160 @30Hz (KE8950 and KE8952); 36 bit color depth.

- ◆ Cisco Catalyst 2960X / Catalyst 2960XR / Catalyst 3750
- ◆ HP Procurve 2920
- ◆ H3C S5120
- ◆ Huawei S5700
- ◆ DLink DGS-1510

Please refer to the FAQ link below on how to select network switches and network switch information collected by ATEN Customer Service Division, where the collected information includes customer's feedback from their actual experience in using and installing the product(s).

<https://eservice.aten.com/eServiceCx/Common/FAQ/view.do?id=6276>

Setup CCKM Server IP address on Windows

1. Select **Network and Sharing Center** and click **Change adapter settings**.
2. Right-click **Local Area Connection** and select **Properties**.
3. In the Local Area Connection Properties window, highlight **Internet Protocol Version 4 (TCP/IPv4)** then click **Properties**.
4. Select **Use the following IP address** and enter in the IP for the CCKM server (e.g. any IP address not in use, and in between 192.168.0.2 and 192.168.0.253)*, Subnet Mask (e.g. 255.255.255.0), and Default Gateway that corresponds with your network setup.
5. Click **OK** to change the CCKM server's IP address.

Note: Make sure the CCKM server's IP address is not a duplicate to prevent IP address conflict.

To connect to the CCKM server via web browser, enter the CCKM IP address and port number (default: 8443). For example, if the CCKM IP address is 192.168.0.10, then enter <https://192.168.0.10:8443>.

If you have a 2nd NIC, please follow the following steps.

6. Select **Network and Sharing Center** and click **Change adapter settings**.
7. Right-click **Local Area Connection** for the 2nd NIC and select **Properties**.
8. In the Local Area Connection Properties window, highlight **Internet Protocol Version 4 (TCP/IPv4)** then click **Properties**.
9. Select **Use the following IP address** and enter in the IP of the 2nd subnet for the CCKM server (e.g. any IP address not in use, and in between 192.168.1.2 and 192.168.1.253)*, Subnet Mask (e.g. 255.255.255.0), and Default Gateway that corresponds with your network setup.
10. Click **OK** to change the CCKM server's IP address of the 2nd subnet.

Limited Warranty

ATEN warrants its hardware in the country of purchase against flaws in materials and workmanship for a Warranty Period of two [2] years (warranty period may vary in certain regions/countries) commencing on the date of original purchase. This warranty period includes the LCD panel of ATEN LCD KVM switches. Select products are warranted for an additional year (see *A+ Warranty* for further details). Cables and accessories are not covered by the Standard Warranty.

What is covered by the Limited Hardware Warranty

ATEN will provide a repair service, without charge, during the Warranty Period. If a product is defective, ATEN will, at its discretion, have the option to (1) repair said product with new or repaired components, or (2) replace the entire product with an identical product or with a similar product which fulfills the same function as the defective product. Replaced products assume the warranty of the original product for the remaining period or a period of 90 days, whichever is longer. When the products or components are replaced, the replacing articles shall become customer property and the replaced articles shall become the property of ATEN.

To learn more about our warranty policies, please visit our website:

<http://www.aten.com/global/en/legal/policies/warranty-policy/>