



Lexmark™

CX820, CX827

User's Guide

October 2017

www.lexmark.com

Machine type(s):

7563

Model(s):

136, 137

Contents

- Safety information..... 6**
 - Conventions..... 6
 - Product statements..... 6

- Learning about the printer..... 9**
 - Finding information about the printer.....9
 - Selecting a location for the printer..... 10
 - Printer configurations..... 11
 - Attaching cables..... 12
 - Using the control panel.....14
 - Understanding the status of the power button and indicator light..... 15
 - Using the home screen.....15
 - Menu map.....16
 - Printing a menu settings page..... 18

- Setting up and using the home screen applications..... 19**
 - Customizing the home screen..... 19
 - Setting up Forms and Favorites..... 19
 - Setting up Card Copy.....19
 - Using Shortcut Center..... 20
 - Setting up Scan Center.....20
 - Managing contacts..... 20

- Setting up and using the accessibility features..... 23**
 - Enabling Magnification mode.....23
 - Activating Voice Guidance.....23
 - Adjusting the Voice Guidance speech rate.....23
 - Enabling spoken passwords or personal identification numbers..... 23
 - Navigating the screen using gestures.....24
 - Using the keyboard on the display.....24

- Loading paper and specialty media..... 25**
 - Setting the size and type of the specialty media.....25
 - Configuring Universal paper settings..... 25
 - Loading trays.....25

Loading the multipurpose feeder.....27
Linking trays.....28

Printing.....29

Printing from a computer.....29
Printing forms..... 29
Printing from a mobile device..... 29
Printing from a flash drive..... 30
Supported flash drives and file types.....31
Configuring confidential jobs..... 32
Printing held jobs.....32
Printing a font sample list..... 33
Canceling a print job.....33

Copying.....34

Making copies..... 34
Copying photos..... 34
Copying on letterhead..... 34
Copying on both sides of the paper..... 34
Reducing or enlarging copies..... 35
Collating copies..... 35
Placing separator sheets between copies..... 35
Copying multiple pages onto a single sheet..... 35
Creating a copy shortcut..... 35

E-mailing..... 36

Setting up the e-mail function..... 36
Configuring e-mail settings.....36
Sending an e-mail.....36
Creating an e-mail shortcut.....37

Faxing.....38

Setting up the printer to fax.....38
Sending a fax.....51
Scheduling a fax..... 52
Creating a fax destination shortcut..... 52
Changing the fax resolution..... 52

Adjusting the fax darkness..... 52
Viewing a fax log..... 53
Blocking junk faxes..... 53
Holding faxes..... 53
Forwarding a fax..... 53

Scanning..... 54

Scanning to an FTP server..... 54
Creating an FTP shortcut..... 54
Scanning to a flash drive..... 54
Sending scanned documents to a computer..... 55

Securing the printer..... 56

Locating the security slot..... 56
Erasing printer memory..... 56
Erasing printer hard disk memory..... 56
Configuring printer hard disk encryption..... 57
Restoring factory default settings..... 57
Statement of Volatility..... 57

Maintaining the printer..... 59

Adjusting the speaker volume..... 59
Networking..... 60
Setting up serial printing (Windows only)..... 61
Cleaning printer parts..... 62
Ordering parts and supplies..... 67
Replacing parts and supplies..... 70
Storing supplies..... 102
Moving the printer..... 102
Saving energy and paper..... 103
Recycling..... 104

Clearing jams..... 106

Avoiding jams..... 106
Identifying jam locations..... 107
Paper jam in trays..... 108
Paper jam in the multipurpose feeder..... 109

Paper jam in the automatic document feeder..... 111
Paper jam in the standard bin..... 113
Paper jam in door B..... 113
Paper jam in the finisher bin..... 117
Staple jam in door G..... 119

Troubleshooting..... 123

Network connection problems..... 123
Hardware options problems..... 125
Issues with supplies..... 127
Paper feed problems..... 129
Printing problems..... 133
Color quality problems..... 155
Faxing problems..... 158
Scanning problems..... 161
Contacting customer support..... 165

Upgrading and migrating..... 166

Hardware..... 166
Software..... 182
Firmware..... 182

Notices..... 184

Index..... 188

Safety information







Conventions

Note: A *note* identifies information that could help you.







Warning: A *warning* identifies something that could damage the product hardware or software.









CAUTION: A *caution* indicates a potentially hazardous situation that could injure you.







Different types of caution statements include:

-  **CAUTION—POTENTIAL INJURY:** Indicates a risk of injury.
-  **CAUTION—SHOCK HAZARD:** Indicates a risk of electrical shock.
-  **CAUTION—HOT SURFACE:** Indicates a risk of burn if touched.
-  **CAUTION—TIPPING HAZARD:** Indicates a crush hazard.
-  **CAUTION—PINCH HAZARD:** Indicates a risk of being caught between moving parts.
-  **CAUTION—ROTATING FAN BLADES:** Indicates a risk of laceration from moving fan blades.

Product statements

-  **CAUTION—POTENTIAL INJURY:** To avoid the risk of fire or electrical shock, connect the power cord to an appropriately rated and properly grounded electrical outlet that is near the product and easily accessible.
-  **CAUTION—POTENTIAL INJURY:** To avoid the risk of fire or electrical shock, use only the power cord provided with this product or the manufacturer's authorized replacement.
-  **CAUTION—POTENTIAL INJURY:** Do not use this product with extension cords, multioutlet power strips, multioutlet extenders, or UPS devices. The power capacity of these types of accessories can be easily overloaded by a laser printer and may result in a risk of fire, property damage, or poor printer performance.
-  **CAUTION—POTENTIAL INJURY:** To reduce the risk of fire, use only a 26 AWG or larger telecommunications (RJ-11) cord when connecting this product to the public switched telephone network. For users in Australia, the cord must be approved by the Australian Communications and Media Authority.
-  **CAUTION—POTENTIAL INJURY:** Only a Lexmark Inline Surge Protector that is properly connected between the printer and the power cord provided with the printer may be used with this product. The use of non-Lexmark surge protection devices may result in a risk of fire, property damage, or poor printer performance.
-  **CAUTION—SHOCK HAZARD:** To avoid the risk of electrical shock, do not place or use this product near water or wet locations.

-  **CAUTION—SHOCK HAZARD:** To avoid the risk of electrical shock, do not set up this product or make any electrical or cabling connections, such as the power cord, fax feature, or telephone, during a lightning storm.
-  **CAUTION—POTENTIAL INJURY:** Do not cut, twist, bind, crush, or place heavy objects on the power cord. Do not subject the power cord to abrasion or stress. Do not pinch the power cord between objects such as furniture and walls. If any of these things happen, a risk of fire or electrical shock results. Inspect the power cord regularly for signs of such problems. Remove the power cord from the electrical outlet before inspecting it.
-  **CAUTION—SHOCK HAZARD:** To avoid the risk of electrical shock, make sure that all external connections (such as Ethernet and telephone system connections) are properly installed in their marked plug-in ports.
-  **CAUTION—SHOCK HAZARD:** To avoid the risk of electrical shock, if you are accessing the controller board or installing optional hardware or memory devices sometime after setting up the printer, then turn the printer off, and unplug the power cord from the electrical outlet before continuing. If you have any other devices attached to the printer, then turn them off as well, and unplug any cables going into the printer.
-  **CAUTION—SHOCK HAZARD:** To avoid the risk of electrical shock, do not use the fax feature during a lightning storm.
-  **CAUTION—SHOCK HAZARD:** To avoid the risk of electrical shock when cleaning the exterior of the printer, unplug the power cord from the electrical outlet and disconnect all cables from the printer before proceeding.
-  **CAUTION—POTENTIAL INJURY:** If the printer weight is greater than 18 kg (40 lb), then it requires two or more trained personnel to lift it safely.
-  **CAUTION—POTENTIAL INJURY:** When moving the printer, follow these guidelines to avoid personal injury or printer damage:
- Make sure that all doors and trays are closed.
 - Turn off the printer, and then unplug the power cord from the electrical outlet.
 - Disconnect all cords and cables from the printer.
 - If the printer has separate floor-standing optional trays or output options attached to it, then disconnect them before moving the printer.
 - If the printer has a caster base, then carefully roll it to the new location. Use caution when passing over thresholds and breaks in flooring.
 - If the printer does not have a caster base but is configured with optional trays or output options, then remove the output options and lift the printer off the trays. Do not try to lift the printer and any options at the same time.
 - Always use the handholds on the printer to lift it.
 - Any cart used to move the printer must have a surface able to support the full footprint of the printer.
 - Any cart used to move the hardware options must have a surface able to support the dimensions of the options.
 - Keep the printer in an upright position.
 - Avoid severe jarring movements.
 - Make sure that your fingers are not under the printer when you set it down.
 - Make sure that there is adequate clearance around the printer.

-  **CAUTION—TIPPING HAZARD:** Installing one or more options on your printer or MFP may require a caster base, furniture, or other feature to prevent instability causing possible injury. For more information on supported configurations, see www.lexmark.com/multifunctionprinters.
-  **CAUTION—TIPPING HAZARD:** To reduce the risk of equipment instability, load each tray separately. Keep all other trays closed until needed.
-  **CAUTION—HOT SURFACE:** The inside of the printer might be hot. To reduce the risk of injury from a hot component, allow the surface to cool before touching it.
-  **CAUTION—PINCH HAZARD:** To avoid the risk of a pinch injury, use caution in areas marked with this label. Pinch injuries may occur around moving parts, such as gears, doors, trays, and covers.
-  **CAUTION—ROTATING FAN BLADES:** To avoid the risk of laceration from moving fan blades, turn off the printer and unplug the power cord from the electrical outlet before accessing areas marked with this symbol.
-  **CAUTION—POTENTIAL INJURY:** This product uses a laser. Use of controls or adjustments or performance of procedures other than those specified in the *User's Guide* may result in hazardous radiation exposure.
-  **CAUTION—POTENTIAL INJURY:** The lithium battery in this product is not intended to be replaced. There is a danger of explosion if a lithium battery is incorrectly replaced. Do not recharge, disassemble, or incinerate a lithium battery. Discard used lithium batteries according to the manufacturer's instructions and local regulations.

This product is designed, tested, and approved to meet strict global safety standards with the use of specific manufacturer's components. The safety features of some parts may not always be obvious. The manufacturer is not responsible for the use of other replacement parts.

Refer service or repairs, other than those described in the user documentation, to a service representative.

This product uses a printing process that heats the print media, and the heat may cause the media to release emissions. You must understand the section in your operating instructions that discusses the guidelines for selecting print media to avoid the possibility of harmful emissions.

This product may produce small amounts of ozone during normal operation, and may be equipped with a filter designed to limit ozone concentrations to levels well below the recommended exposure limits. To avoid high ozone concentration levels during extensive usage, install this product in a well-ventilated area and replace the ozone and exhaust filters if instructed to do so in the product maintenance instructions. If there are no references to filters in the product maintenance instructions, then there are no filters requiring replacement for this product.

SAVE THESE INSTRUCTIONS.

Learning about the printer

Finding information about the printer

What are you looking for?	Find it here
Initial setup instructions: <ul style="list-style-type: none"> • Connecting the printer • Installing the printer software 	See the setup documentation that came with the printer or go to http://support.lexmark.com .
More setup and instructions for using the printer: <ul style="list-style-type: none"> • Selecting and storing paper and specialty media • Loading paper • Configuring printer settings • Viewing and printing documents and photos • Setting up and using the printer software • Configuring the printer on a network • Caring for and maintaining the printer • Troubleshooting and solving problems 	<i>Information Center</i> —Go to http://infoserve.lexmark.com . <i>Help Menu Pages</i> —Access the guides on the printer firmware or go to http://support.lexmark.com . <i>Touch Screen Guide</i> —Go to http://support.lexmark.com . Product videos—Go to http://infoserve.lexmark.com/idv/ .
Information on setting up and configuring the accessibility features of your printer	<i>Lexmark Accessibility Guide</i> —Go to http://support.lexmark.com .
Help using the printer software	Help for Microsoft® Windows® or Macintosh operating systems—Open a printer software program or application, and then click Help . Click  to view context-sensitive information. Notes: <ul style="list-style-type: none"> • Help is automatically installed with the printer software. • Depending on the operating system, the printer software is located in the printer program folder or on the desktop.

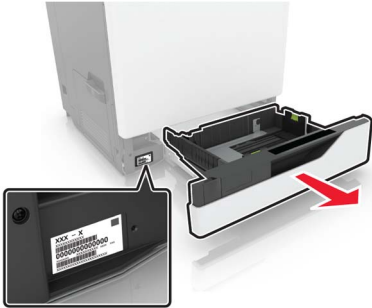
What are you looking for?	Find it here
<p>The latest supplemental information, updates, and customer support:</p> <ul style="list-style-type: none"> • Documentation • Driver downloads • Live chat support • E-mail support • Voice support 	<p>Go to http://support.lexmark.com.</p> <p>Note: Select your country or region, and then select your product to view the appropriate support site.</p> <p>Support contact information for your country or region can be found on the website or on the printed warranty that came with the printer.</p> <p>Have the following information ready when you contact customer support:</p> <ul style="list-style-type: none"> • Place and date of purchase • Machine type and serial number 
<ul style="list-style-type: none"> • Safety information • Regulatory information • Warranty information • Environmental information 	<p>Warranty information varies by country or region:</p> <ul style="list-style-type: none"> • In the U.S.—See the Statement of Limited Warranty included with the printer, or go to http://support.lexmark.com. • In other countries and regions—See the printed warranty that came with the printer. <p><i>Product Information Guide</i>—See the documentation that came with the printer or go to http://support.lexmark.com.</p>

Selecting a location for the printer

When selecting a location for the printer, leave enough room to open trays, covers, and doors and to install hardware options.

- Set up the printer near an electrical outlet.

 **CAUTION—POTENTIAL INJURY:** To avoid the risk of fire or electrical shock, connect the power cord to an appropriately rated and properly grounded electrical outlet that is near the product and easily accessible.

 **CAUTION—SHOCK HAZARD:** To avoid the risk of electrical shock, do not place or use this product near water or wet locations.

- Make sure that airflow in the room meets the latest revision of the ASHRAE 62 standard or the CEN Technical Committee 156 standard.
- Provide a flat, sturdy, and stable surface.

- Keep the printer:
 - Clean, dry, and free of dust.
 - Away from stray staples and paper clips.
 - Away from the direct airflow of air conditioners, heaters, or ventilators.
 - Free from direct sunlight and humidity extremes.
- Observe the recommended temperatures and avoid fluctuations:

Ambient temperature	10 to 32.2°C (50 to 90°F)
Storage temperature	-40 to 43.3°C (-40 to 110°F)

- Allow the following recommended amount of space around the printer for proper ventilation:

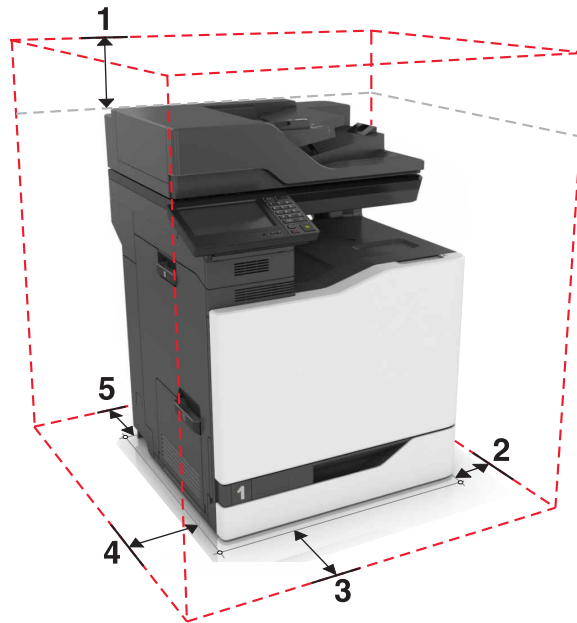

1	Top	330 mm (13 in.)
2	Right side	152 mm (6 in.)
3	Front	381 mm (15 in.)
4	Left side	457 mm (18 in.)
5	Rear	203 mm (8 in.)

Printer configurations

CAUTION—TIPPING HAZARD: Installing one or more options on your printer or MFP may require a caster base, furniture, or other feature to prevent instability causing possible injury. For more information on supported configurations, see www.lexmark.com/multifunctionprinters.

You can configure your printer by adding an optional 2200-sheet tray or a combination of up to three optional 550-sheet trays or envelope trays.

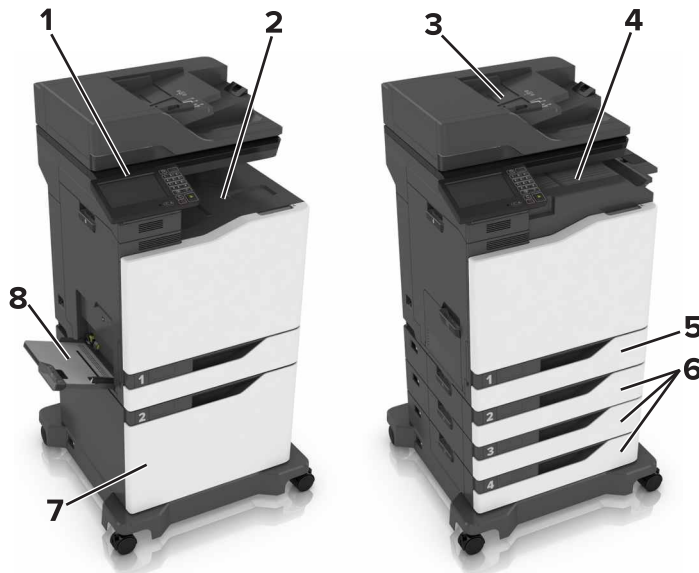

1	Control panel
2	Staple finisher
3	Standard bin
4	Standard 550-sheet tray
5	Optional 550-sheet trays or envelope trays
6	Optional 2200-sheet tray
7	Multipurpose feeder

Attaching cables

- ⚠ CAUTION—POTENTIAL INJURY:** To avoid the risk of fire or electrical shock, connect the power cord to an appropriately rated and properly grounded electrical outlet that is near the product and easily accessible.
- ⚠ CAUTION—POTENTIAL INJURY:** To avoid the risk of fire or electrical shock, use only the power cord provided with this product or the manufacturer's authorized replacement.
- ⚠ CAUTION—POTENTIAL INJURY:** To avoid the risk of electrical shock, do not set up this product or make any electrical or cabling connections, such as the power cord, fax feature, or telephone, during a lightning storm.
- ⚠ CAUTION—POTENTIAL INJURY:** To reduce the risk of fire, use only a 26 AWG or larger telecommunications (RJ-11) cord when connecting this product to the public switched telephone network. For users in Australia, the cord must be approved by the Australian Communications and Media Authority.

Warning—Potential Damage: To avoid loss of data or printer malfunction, do not touch the USB cable, any wireless network adapter, or the printer in the areas shown while actively printing.

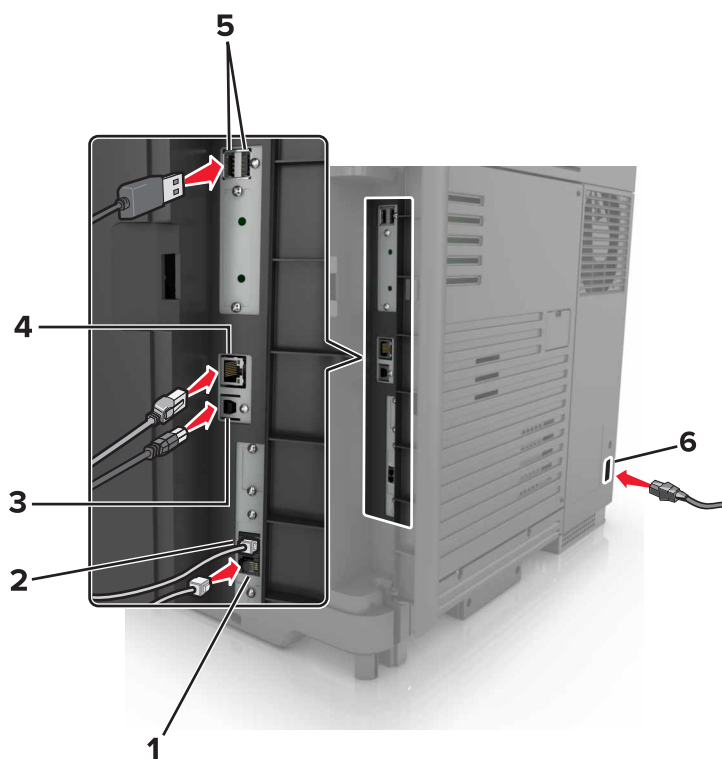

	Use the	To
1	EXT port	Connect additional devices (telephone or answering machine) to the printer and the telephone line. Use this port if you do not have a dedicated fax line for the printer and if this connection method is supported in your country or region. Note: Remove the plug to access the port.
2	LINE port	Connect the printer to an active telephone line through a standard wall jack (RJ-11), DSL filter, VoIP adapter, or any other adapter that allows you to access the telephone line to send and receive faxes.
3	USB printer port	Connect the printer to a computer.
4	Ethernet port	Connect the printer to an Ethernet network.
5	USB ports	Attach a keyboard or any compatible options.
6	Power cord socket	Connect the printer to a properly grounded electrical outlet.

Using the control panel

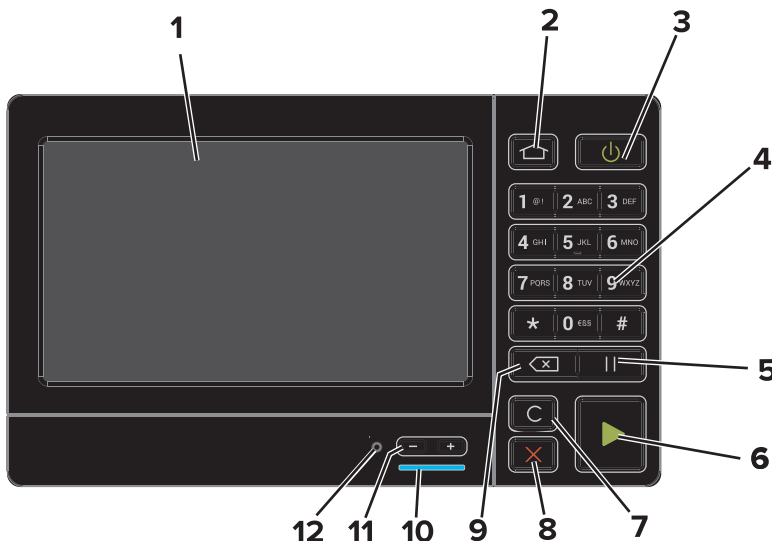

	Use the	To
1	Display	<ul style="list-style-type: none"> View the printer messages and supply status. Set up and operate the printer.
2	Home button	Go to the home screen.
3	Power button	<ul style="list-style-type: none"> Turn on or turn off the printer. Note: To turn off the printer, press and hold the power button for five seconds. Set the printer to Sleep or Hibernate mode. Wake the printer from Sleep or Hibernate mode.
4	Keypad	Enter numbers or symbols in an input field.
5	Pause button	Place a dial pause in a fax number.
6	Start button	Start a job, depending on which mode is selected.
7	Clear all or Reset button	Reset the default settings of a function such as copying, faxing, or scanning.
8	Stop or Cancel button	Stop the current job.
9	Backspace button	Move the cursor backward and delete a character in an input field.
10	Indicator light	Check the status of the printer.
11	Volume buttons	Adjust the volume of the headset or speaker.
12	Headset or speaker port	Attach a headset or speaker.

Understanding the status of the power button and indicator light

Indicator light	Printer status
Off	The printer is off or in Hibernate mode.
Blue	The printer is ready or processing data.
Red	The printer requires user intervention.

Power button light	Printer status
Off	The printer is off, ready, or processing data.
Solid amber	The printer is in sleep mode.
Blinking amber	The printer is in hibernate mode.

Using the home screen

Note: Your home screen may vary depending on your home screen customization settings, administrative setup, and active embedded solutions.

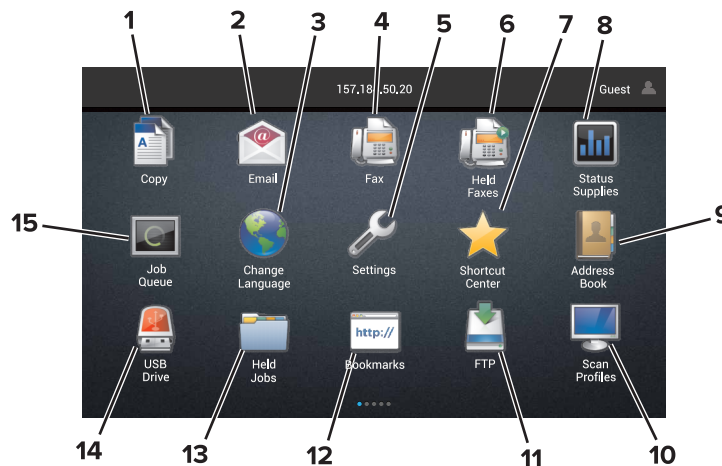

Touch	To
1	Copy Make copies.
2	E-mail Send e-mails.
3	Change Language Change the language on the printer display.
4	Fax Send fax.
5	Settings Access the printer menus.
6	Held Faxes Show all the current held fax jobs. Note: If Held Faxes is hidden, then Release Held Faxes appears.
7	Shortcut Center Organize all shortcuts.

Touch		To
8	Status/Supplies	<ul style="list-style-type: none"> Show a printer warning or error message whenever the printer requires intervention to continue processing. View more information on the printer warning or message, and on how to clear it. <p>Note: You can also access this setting by touching the top section of the home screen.</p>
9	Address Book	Access, create, and organize contacts.
10	Scan Profiles	Scan and save documents directly to the computer.
11	FTP	Scan and save documents directly to an FTP server.
12	Bookmarks	Organize all bookmarks.
13	Held Jobs	Show all the current held print jobs
14	USB Drive	View, select, or print photos and documents from a flash drive.
15	Job Queue	<p>Show all the current print jobs.</p> <p>Note: You can also access this setting by touching the top section of the home screen.</p>

These settings may also appear on the home screen

Touch	To
App Profiles	Access application profiles.
Lock Device	Prevent users from accessing any printer functions from the home screen.

Menu map

Device

<ul style="list-style-type: none"> Preferences Remote Operator Panel Notifications Power Management Information Sent to Lexmark 	<ul style="list-style-type: none"> Accessibility Restore Factory Defaults Maintenance Visible Home Screen Icons About This Printer
--	---

Print

<ul style="list-style-type: none"> Layout Finishing Setup Quality Job Accounting XPS 	<ul style="list-style-type: none"> PDF PostScript PCL HTML Image PPDS
--	---

Paper

<ul style="list-style-type: none"> • Tray Configuration • Media Configuration 	<ul style="list-style-type: none"> • Bin Configuration
---	---

Copy

Copy Defaults

Fax

<ul style="list-style-type: none"> • Fax Mode • Analog Fax Setup 	<ul style="list-style-type: none"> • Fax Server Setup
--	--

E-mail

<ul style="list-style-type: none"> • E-mail Setup • E-mail Defaults 	<ul style="list-style-type: none"> • Web Link Setup
---	--

Network/Ports

<ul style="list-style-type: none"> • Network Overview • Wireless • AirPrint • Ethernet • TCP/IP • IPv6 • SNMP • IPSec 	<ul style="list-style-type: none"> • LPD Configuration • HTTP/FTP Settings • ThinPrint • USB • Parallel [x] • Serial • Google Cloud Print • Wi-Fi Direct
---	--

FTP

FTP Defaults

USB Drive

<ul style="list-style-type: none"> • Flash Drive Scan 	<ul style="list-style-type: none"> • Flash Drive Print
--	---

Security

<ul style="list-style-type: none"> • Login Methods • Schedule USB Devices • Security Audit Log • Login Restrictions • Confidential Print Setup 	<ul style="list-style-type: none"> • Disk Encryption • Erase Temporary Data Files • Solutions LDAP Settings • Miscellaneous
---	---

Option Card Menu

Note: This setting appears only when an optional card is installed.
--

Reports

<ul style="list-style-type: none">• Menu Settings Page• Device• Print	<ul style="list-style-type: none">• Shortcuts• Fax• Network
---	---

Help

<ul style="list-style-type: none">• Print All Guides• Color Quality Guide• Connection Guide• Copy Guide• E-mail Guide• Fax Guide	<ul style="list-style-type: none">• Information Guide• Media Guide• Moving Guide• Print Quality Guide• Scan Guide• Supplies Guide
---	--

Troubleshooting

<ul style="list-style-type: none">• Basic Print Quality Samples	<ul style="list-style-type: none">• Advanced Print Quality Samples
---	--

Printing a menu settings page

From the home screen, touch **Settings > Reports > Menu Settings Page**.

Setting up and using the home screen applications

Customizing the home screen

- 1 Open a web browser, and then type the printer IP address in the address field.

Notes:

- View the printer IP address on the printer home screen. The IP address appears as four sets of numbers separated by periods, such as 123.123.123.123.
- If you are using a proxy server, then temporarily disable it to load the web page correctly.

- 2 Click **Settings > Device > Visible Home Screen Icons**.
- 3 Select the icons that you want to appear on the home screen.
- 4 Apply the changes.

Setting up Forms and Favorites

- 1 Open a Web browser, and then type the printer IP address in the address field.

Notes:

- View the printer IP address on the printer home screen. The IP address appears as four sets of numbers separated by periods, such as 123.123.123.123.
- If you are using a proxy server, then temporarily disable it to load the Web page correctly.

- 2 Click **Apps > Forms and Favorites > Configure**.
- 3 Click **Add**, and then customize the settings.

Notes:

- To make sure that the location settings of the bookmark are correct, type the IP address of the host computer where the bookmark is located.
- Make sure that the printer has access rights to the folder where the bookmark is located.

- 4 Apply the changes.

Setting up Card Copy

- 1 Open a Web browser, and then type the printer IP address in the address field.

Notes:

- View the printer IP address on the printer home screen. The IP address appears as four sets of numbers separated by periods, such as 123.123.123.123.
- If you are using a proxy server, then temporarily disable it to load the Web page correctly.

- 2 Click **Apps > Card Copy > Configure**.

3 Configure the output options and scan settings.

Notes:

- When scanning a card, make sure that the scan resolution does not exceed 200 dpi for color and 400 dpi for black and white.
- When scanning multiple cards, make sure that the scan resolution does not exceed 150 dpi for color and 300 dpi for black and white.
- You need a printer hard disk to scan multiple cards.
- Make sure that the printer network and e-mail settings are configured.

4 Apply the changes.

Using Shortcut Center

1 From the home screen, touch **Shortcut Center**, and then select a printer function.

2 Touch **Create Shortcut**, and then configure the settings.

3 Touch **Save**, and then type a unique shortcut name.

4 Apply the changes.

Setting up Scan Center

1 From the home screen, touch **Scan Center**.

2 Select and create a destination, and then configure the settings.

Notes:

- When creating a network destination, make sure to validate and adjust the settings until no errors occur.
- Only destinations created from the Embedded Web Server are saved. For more information, see the documentation that came with the solution.

3 Apply the changes.

Managing contacts

Adding contacts

1 Open a web browser, and then type the printer IP address in the address field.

Notes:

- View the printer IP address on the printer home screen. The IP address appears as four sets of numbers separated by periods, such as 123.123.123.123.
- If you are using a proxy server, then temporarily disable it to load the web page correctly.

2 Click **Address Book**.

3 From the Contacts section, add a contact.

Note: You can assign the contact to one or more groups.

4 If necessary, specify a login method to allow application access.

5 Apply the changes.

Adding groups

1 Open a web browser, and then type the printer IP address in the address field.

Notes:

- View the printer IP address on the printer home screen. The IP address appears as four sets of numbers separated by periods, such as 123.123.123.123.
- If you are using a proxy server, then temporarily disable it to load the web page correctly.

2 Click **Address Book**.

3 From the Contact Groups section, add a group name.

Note: You can assign one or more contacts to the group.

4 Apply the changes.

Editing contacts or groups

1 Open a web browser, and then type the printer IP address in the address field.

Notes:

- View the printer IP address on the printer home screen. The IP address appears as four sets of numbers separated by periods, such as 123.123.123.123.
- If you are using a proxy server, then temporarily disable it to load the web page correctly.

2 Click **Address Book**.

3 Do either of the following:

- From the Contacts section, click a contact name, and then edit the information.
- From the Contact Groups section, click a group name, and then edit the information.

4 Apply the changes.

Deleting contacts or groups

1 Open a web browser, and then type the printer IP address in the address field.

Notes:

- View the printer IP address on the printer home screen. The IP address appears as four sets of numbers separated by periods, such as 123.123.123.123.
- If you are using a proxy server, then temporarily disable it to load the web page correctly.

2 Click **Address Book**.

3 Do either of the following:

- From the Contacts section, select a contact that you want to delete.
- From the Contact Groups section, select a group name that you want to delete.

Setting up and using the accessibility features

Enabling Magnification mode

- 1 From the control panel, press and hold the **5** key until you hear a voice message.
- 2 Select **Magnification**.
- 3 Select **OK**.

For more information on navigating a magnified screen, see [“Navigating the screen using gestures” on page 24](#).

Activating Voice Guidance

From the control panel

- 1 Press and hold the **5** key until you hear a voice message.
- 2 Select **OK**.

From the keyboard

- 1 Press and hold the **5** key until you hear a voice message.
- 2 Press **Tab** to navigate the focus cursor to the OK button, and then press **Enter**.

Notes:

- Voice Guidance is also activated when you insert headphones into the headphone jack.
- To adjust the volume, use the volume buttons at the bottom part of the control panel.

Adjusting the Voice Guidance speech rate

- 1 From the home screen, select **Settings** > **Device** > **Accessibility** > **Speech Rate**.
- 2 Select the speech rate.

Enabling spoken passwords or personal identification numbers

- 1 From the home screen, select **Settings** > **Device** > **Accessibility** > **Speak Passwords/PINs**.
- 2 Enable the setting.

Navigating the screen using gestures

Notes:

- The gestures are applicable only when Voice Guidance is activated.
- A physical keyboard is required for typing characters and adjusting certain settings.

Gesture	Function
Double-tap	Select an option or item on the screen.
Triple-tap	Zoom in or zoom out text and images.
Swipe right or swipe down	Move to the next item on the screen.
Swipe left or swipe up	Move to the previous item on the screen.
Pan	Access parts of the zoomed image that are beyond the limits of the screen. Note: This gesture requires the use of two fingers to drag across a zoomed image.
Swipe up then left	Exit an application and return to the home screen.
Swipe down then left	<ul style="list-style-type: none"> • Cancel a job. • Go back to the previous setting. • Exit the screen that appears without changing any setting or value.
Swipe up then down	Repeat a spoken prompt.

Using the keyboard on the display

Do one or more of the following:

- Drag a finger over the key to announce the character.
- Lift the finger to enter or type the character in the field.
- Press **Backspace** to delete characters.
- To hear the content in the input field, press **Tab**, and then press **Shift + Tab**.

Loading paper and specialty media

Setting the size and type of the specialty media

The trays automatically detect the size of plain paper. For specialty media like labels, card stock, or envelopes, do the following:

- 1 From the home screen, navigate to:
Settings > Paper > Tray Configuration > Paper Size/Type > select a paper source
- 2 Set the size and type of the specialty media.

Configuring Universal paper settings

- 1 From the home screen, touch **Settings > Paper > Media Configuration > Universal Setup**.
- 2 Configure the settings.

Loading trays

 **CAUTION—TIPPING HAZARD:** To reduce the risk of equipment instability, load each tray separately. Keep all other trays closed until needed.

- 1 Pull out the tray.

Note: To avoid paper jams, do not remove trays while the printer is busy.

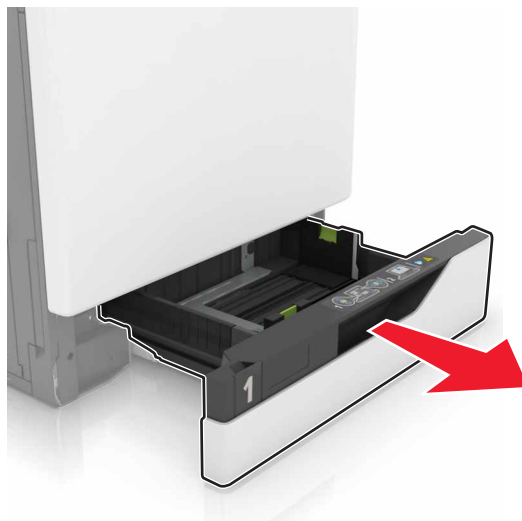

- 2 Adjust the guides to match the size of the paper that you are loading.

Note: Use the indicators on the bottom of the tray to position the guides.

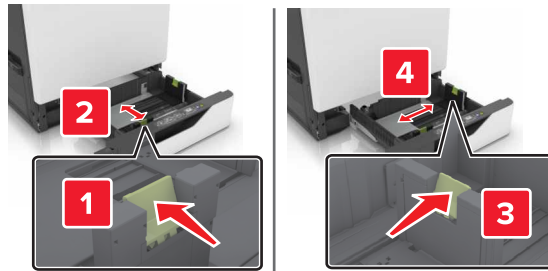

3 Flex, fan, and align the paper edges before loading.

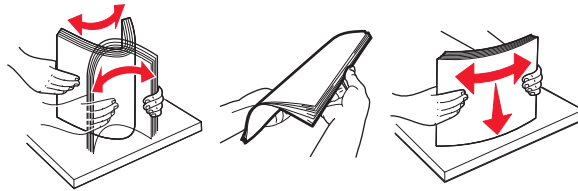

4 Load the paper with the printable side faceup.

Note: Load envelopes only in the optional envelope tray.

Warning—Potential Damage: Do not use envelopes with stamps, clasps, snaps, windows, coated linings, or self-stick adhesives in the optional envelope tray.

Notes:

- Load letterhead faceup with the header on the left side of the tray for one-sided printing.
- Load letterhead facedown with the header on the right side of the tray for two-sided printing.
- Load letterhead faceup with the header on the right side of the tray for one-sided print jobs that require finishing.
- Load letterhead facedown with the header on the left side of the tray for two-sided print jobs that require finishing.
- Load pre-punched paper with the holes toward the front or left side of the tray.
- Load envelopes with the flap side down and against the back side of the tray. Load European envelopes with the flap side down and against the left side of the tray.
- Do not slide paper into the tray.
- Make sure that the stack height is below the maximum paper fill indicator. Overfilling may cause paper jams.



5 Insert the tray.

If loading a paper type other than plain, set the paper size and paper type in the Paper menu to match the paper loaded.

Loading the multipurpose feeder

1 Open the multipurpose feeder.



2 Adjust the guide to match the size of the paper you are loading.

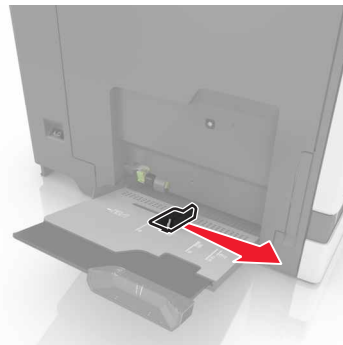

3 Flex, fan, and align the paper edges before loading.

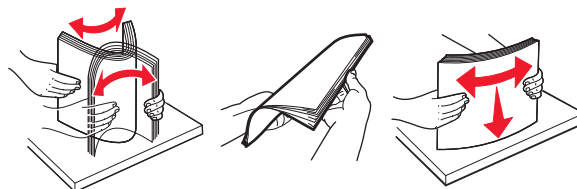

4 Load the paper.

- Load paper, card stock, and transparencies with the printable side facedown and the top edge entering the printer first.

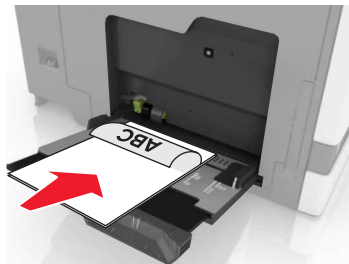

- Load envelopes with the flap side up and against the left side of the paper guide. Load European envelopes with the flap side up and entering the printer first.

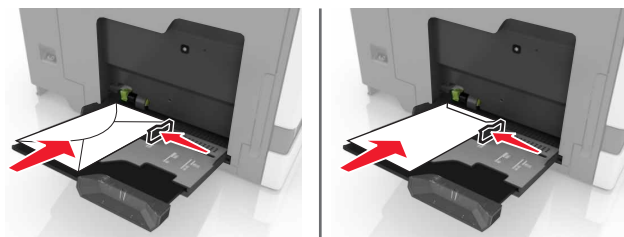

Warning—Potential Damage: Do not use envelopes with stamps, clasps, snaps, windows, coated linings, or self-stick adhesives.

5 From the control panel, set the paper size and type to match the paper loaded in the tray.

Linking trays

1 Open a Web browser, and then type the printer IP address in the address field.

Notes:

- View the printer IP address on the printer home screen. The IP address appears as four sets of numbers separated by periods, such as 123.123.123.123.
- If you are using a proxy server, then temporarily disable it to load the Web page correctly.

2 Click **Settings** > **Paper**.

3 Match the paper size and type for the trays you are linking.

Note: To unlink trays, make sure that no trays have the same paper size or type.

4 Save the settings.

Note: You can also change the paper size and type settings from the printer control panel.

Warning—Potential Damage: The temperature of the fuser varies according to the specified paper type. To avoid printing issues, match the paper type settings in the printer with the paper loaded in the tray.

Printing

 **CAUTION—PINCH HAZARD:** To avoid the risk of a pinch injury, use caution in areas marked with this label. Pinch injuries may occur around moving parts, such as gears, doors, trays, and covers.

Printing from a computer

Note: For labels, card stock, and envelopes, set the paper size and type in the printer before printing the document.

- 1 From the document that you are trying to print, open the Print dialog.
- 2 If necessary, adjust the settings.
- 3 Print the document.

Printing forms

- 1 From the home screen, navigate to:
Forms and Favorites > select form > **Print**
- 2 If necessary, configure the print settings.
- 3 Send the print job.

Printing from a mobile device

Printing from a mobile device using Lexmark Mobile Print

Lexmark™ Mobile Print allows you to send documents and images directly to a supported Lexmark printer.

- 1 Open the document, and then send or share the document to Lexmark Mobile Print.
Note: Some third-party applications may not support the send or share feature. For more information, see the documentation that came with the application.
- 2 Select a printer.
- 3 Print the document.

Printing from a mobile device using Google Cloud Print

Google Cloud Print™ is a mobile printing service that allows enabled applications on mobile devices to print to any Google Cloud Print-ready printer.

- 1 From the home screen of your mobile device, launch an enabled application.
- 2 Tap **Print**, and then select a printer.
- 3 Print the document.

Printing from a mobile device using Mopria Print Service

Mopria® Print Service is a mobile printing solution for mobile devices running on Android version 4.4 or later. It allows you to print directly to any Mopria-certified printer.

Note: Before printing, make sure that the Mopria Print Service is enabled.

- 1 From the home screen of your mobile device, launch a compatible application.
- 2 Tap **Print**, and then select a printer.
- 3 Print the document.

Printing from a mobile device using AirPrint

AirPrint is a mobile printing solution that allows you to print directly from Apple devices to an AirPrint-certified printer.

Notes:

- This application is supported only in some Apple devices.
 - This application is supported only in some printer models.
- 1 From the home screen of your mobile device, launch a compatible application.
 - 2 Select an item to print, and then tap the share icon.
 - 3 Tap **Print**, and then select a printer.
 - 4 Print the document.

Printing from a flash drive

- 1 Insert a flash drive into the USB port.

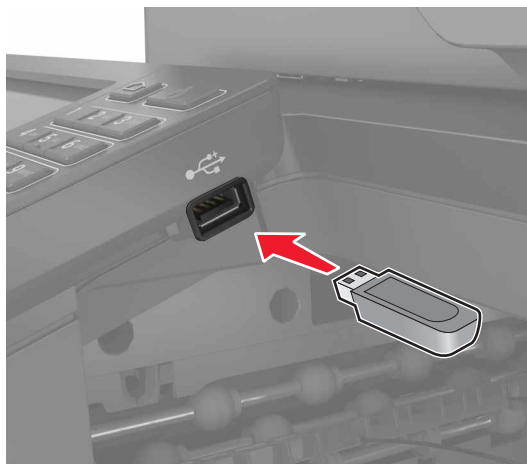

Notes:

- If you insert the flash drive when an error message appears, then the printer ignores the flash drive.

- If you insert the flash drive while the printer is processing other print jobs, then **Busy** appears on the display.
- 2 From the display, touch the document that you want to print.
If necessary, configure other print settings.
 - 3 Send the print job.
To print another document, touch **USB Drive**.

Warning—Potential Damage: Do not touch the printer or the flash drive in the area shown while actively printing, reading, or writing from the memory device. Loss of data or a malfunction can occur.



Supported flash drives and file types

Flash drives

- Lexar JumpDrive S70 (16GB and 32GB)
- SanDisk Cruzer (16GB and 32GB)
- PNY Attaché (16GB and 32GB)

Notes:

- The printer supports high-speed USB flash drives with full-speed standard.
- USB flash drives must support the File Allocation Table (FAT) system.

File types

Documents:

- .doc or .docx
- .xls or .xlsx
- .ppt or .pptx
- .pdf
- .xps

Images:

- .dcx
- .gif
- .jpeg or .jpg
- .bmp
- .pcx
- .tiff or .tif
- .png

Configuring confidential jobs

- 1 From the home screen, touch **Settings > Security > Confidential Print Setup**.
- 2 Configure the settings.

Use	To
Max Invalid PIN	Limit the number of times an invalid PIN can be entered. Note: When the limit is reached, the print jobs for that user name are deleted.
Confidential Job Expiration	Set the amount of time before confidential jobs are automatically deleted from the printer memory. Note: Confidential held jobs are stored in the printer until you log in and release or delete them manually.
Repeat Job Expiration	Set the amount of time before repeat jobs are deleted from the printer memory. Note: Repeat held jobs are stored so extra copies can be printed later.
Verify Job Expiration	Set the amount of time before verify jobs are deleted from the printer memory. Note: Verify jobs print one copy to check if it is satisfactory before printing the remaining copies.
Reserve Job Expiration	Set the amount of time before reserved jobs are deleted without being printed. Note: Reserve held jobs are automatically deleted after printing.

Printing held jobs

- 1 From the document you are trying to print, open the Print dialog.
- 2 Select the printer, and then do the following:
 - For Windows users, click **Properties** or **Preferences**, and then click **Print and Hold**.
 - For Macintosh users, select **Print and Hold**.
- 3 Select the print job type.
- 4 If necessary, assign a user name.
- 5 Send the print job.
- 6 From the printer home screen, touch **Held Jobs**.
- 7 Send the print job.

Printing a font sample list

- 1 From the home screen, touch **Settings** > **Reports** > **Print** > **Print Fonts**.
- 2 Touch **PCL Fonts** or **PostScript Fonts**.

Canceling a print job

From the printer control panel

- 1 From the home screen, touch **Job Queue**.
Note: You can also access this setting by touching the top section of the home screen.
- 2 Select the job to cancel.

From the computer

- 1 Depending on the operating system, do either of the following:
 - Open the printers folder, and then select your printer.
 - From the System Preferences in the Apple menu, navigate to your printer.
- 2 Select the job to cancel.

Copying

Making copies

- 1 Load an original document into the ADF tray or on the scanner glass.

Note: To avoid a cropped image, make sure that the original document and output have the same paper size.

- 2 From the home screen, touch **Copy**, and then specify the number of copies.
If necessary, adjust the copy settings.
- 3 Copy the document.

Note: To make a quick copy, from the control panel, press .

Copying photos

- 1 Place a photo on the scanner glass.
- 2 From the home screen, touch **Copy** > **Content** > **Photo**.
- 3 From the Content Source menu, select the setting that best matches the original photo.
- 4 Send the copy job.

Copying on letterhead

- 1 Load an original document into the ADF tray or on the scanner glass.
- 2 From the home screen, touch **Copy**, and then specify the size of the original document.
- 3 Touch **Copy to**, and then select the tray that contains the specialty media.
If you are loading the specialty media into the multipurpose feeder, then navigate to:
Multipurpose Feeder > select the size of the specialty media > **Letterhead**
- 4 Send the copy job.

Copying on both sides of the paper

- 1 Load an original document into the ADF tray or on the scanner glass.
- 2 From the home screen, touch **Copy** > **Paper Setup**.
- 3 Adjust the settings.
- 4 Copy the document.

Reducing or enlarging copies

- 1 Load an original document into the ADF tray or on the scanner glass.
- 2 From the home screen, navigate to:
Copy > **Scale** > specify a scale value
Note: Changing the size of the original document or output after setting Scale restores the scale value to Auto.
- 3 Copy the document.

Collating copies

- 1 Load an original document into the ADF tray or on the scanner glass.
- 2 From the home screen, touch **Copy**, and then set Collate to **On**.
- 3 Copy the document.

Placing separator sheets between copies

- 1 Load an original document into the ADF tray or on the scanner glass.
- 2 From the home screen, touch **Copy** > **Separator Sheets**.
- 3 Adjust the settings.
- 4 Send the copy job.

Copying multiple pages onto a single sheet

- 1 Load an original document into the ADF tray or on the scanner glass.
- 2 From the home screen, touch **Copy** > **Pages per Side**.
- 3 Adjust the settings.
- 4 Copy the document.

Creating a copy shortcut

- 1 From the home screen, touch **Copy**.
- 2 Adjust the settings, and then touch .
- 3 Enter a shortcut name.
- 4 Apply the changes.

E-mailing

Setting up the e-mail function

- 1 From the home screen, touch **Settings** > **Device** > **Preferences** > **Run Initial Setup**.
- 2 Turn off the printer, wait for about 10 seconds, and then turn it back on.
- 3 From the Before You Begin screen, select **Change the Settings and Continue with the Wizard**.
- 4 From the Fax/Email Server Setup screen, enter the needed information.
- 5 Finish the setup.

Configuring e-mail settings

- 1 Open a Web browser, and then type the printer IP address in the address field.

Notes:

- View the printer IP address on the printer home screen. The IP address appears as four sets of numbers separated by periods, such as 123.123.123.123.
- If you are using a proxy server, then temporarily disable it to load the Web page correctly.

- 2 Click **Settings** > **E-mail**.
- 3 Enter the needed information.
- 4 Apply the changes.

Sending an e-mail

Using the control panel

- 1 Load an original document into the ADF tray or on the scanner glass.
- 2 From the home screen, touch **E-mail**, and then enter the needed information.
Note: You can also enter the recipient using the address book or shortcut number.
- 3 If necessary, configure the output file type settings.
- 4 Send the e-mail.

Using the shortcut number

- 1 From the control panel, press **#**, and then enter the shortcut number using the keypad.
- 2 Send the e-mail.

Creating an e-mail shortcut

- 1 From the home screen, touch **E-mail**.
- 2 Configure the settings, and then touch .
- 3 Enter a shortcut name.
- 4 Apply the changes.

Faxing

Setting up the printer to fax

Notes:

- The following connection methods are applicable only in some countries or regions.
- During the initial printer setup, clear the fax function check box and any other function you plan to set up later, and then touch **Continue**.
- The indicator light may blink red if the fax function is enabled and not fully set up.

Warning—Potential Damage: Do not touch cables or the printer in the area shown while actively sending or receiving a fax.





Setting up the fax function

- 1 From the home screen, touch **Settings > Device > Preferences > Run Initial Setup**.
- 2 Turn off the printer, wait for about 10 seconds, and then turn it back on.
- 3 From the Before You Begin screen, select **Change the Settings and Continue with the Wizard**.
- 4 From the Fax/Email Server Setup screen, enter the needed information.
- 5 Finish the setup.

Choosing a fax connection

Setting up fax using a standard telephone line

-  **CAUTION—SHOCK HAZARD:** To avoid the risk of electrical shock, do not set up this product or make any electrical or cabling connections, such as the power cord, fax feature, or telephone, during a lightning storm.
-  **CAUTION—SHOCK HAZARD:** To avoid the risk of electrical shock, do not use the fax feature during a lightning storm.
-  **CAUTION—POTENTIAL INJURY:** To reduce the risk of fire, use only a 26 AWG or larger telecommunications (RJ-11) cord when connecting this product to the public switched telephone network. For users in Australia, the cord must be approved by the Australian Communications and Media Authority.

Setup 1: Printer is connected to a dedicated fax line

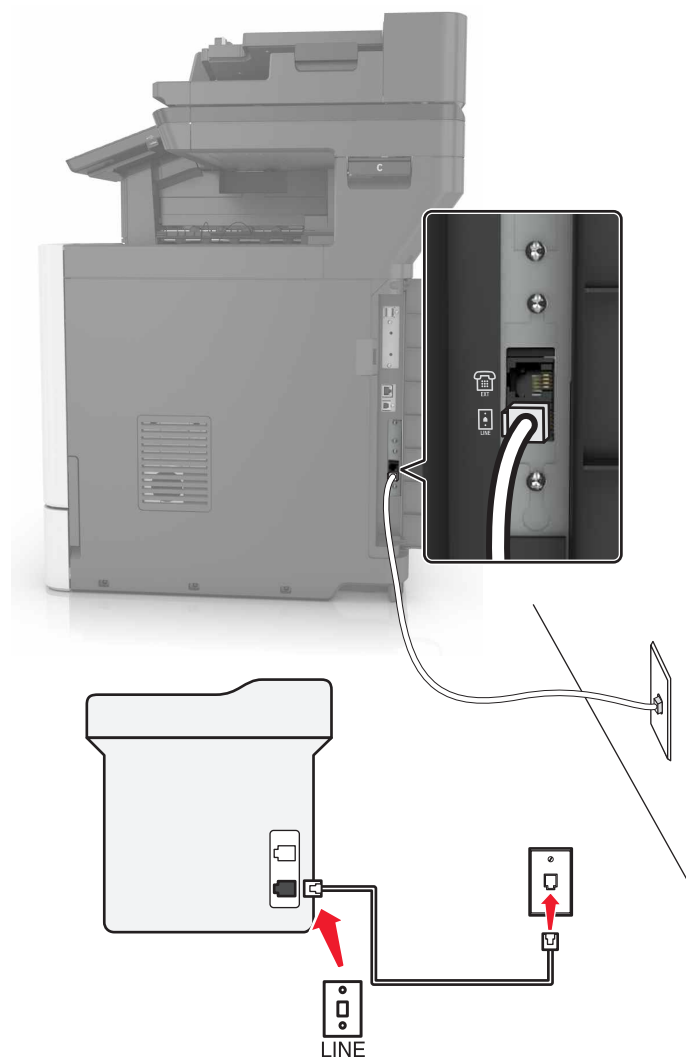

- 1 Connect one end of the telephone cable to the line port of the printer.
- 2 Connect the other end of the cable to an active analog wall jack.

Notes:

- You can set the printer to receive faxes automatically (Auto Answer On) or manually (Auto Answer Off).
- If you want to receive faxes automatically, then set the printer to pick up on a specified number of rings.

Setup 2: Printer is sharing the line with an answering machine

Note: If you subscribe to a distinctive ring service, then make sure that you set the correct ring pattern for the printer. Otherwise, the printer does not receive faxes even if you have set it to receive faxes automatically.

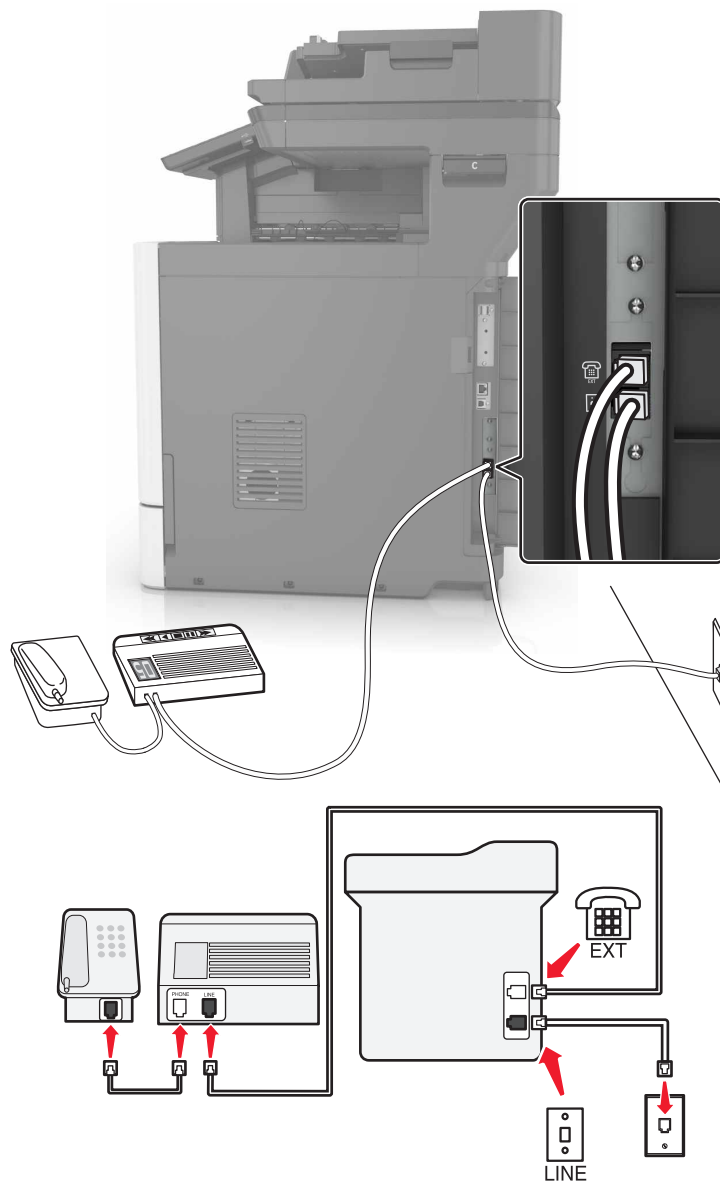
Connected to the same telephone wall jack

- 1 Connect one end of the telephone cable to the line port of the printer.
- 2 Connect the other end of the cable to an active analog wall jack.
- 3 Connect the answering machine to the telephone port of the printer.

Connected to different wall jacks

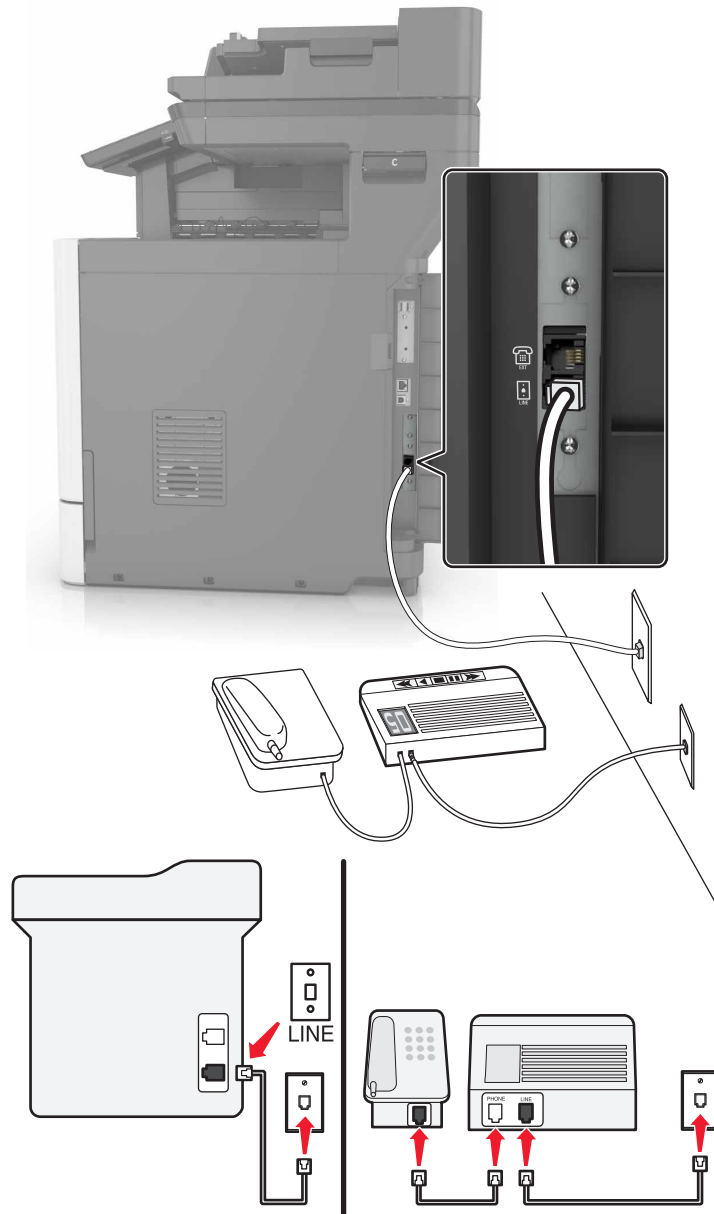

- 1 Connect one end of the telephone cable to the line port of the printer.
- 2 Connect the other end of the cable to an active analog wall jack.

Notes:

- If you have only one telephone number on your line, then set the printer to receive faxes automatically.

- Set the printer to pick up calls two rings after the answering machine. For example, if the answering machine picks up calls after four rings, then set the printer Rings to Answer setting to six.

Setup 3: Printer is sharing the line with a telephone subscribed to voice mail service

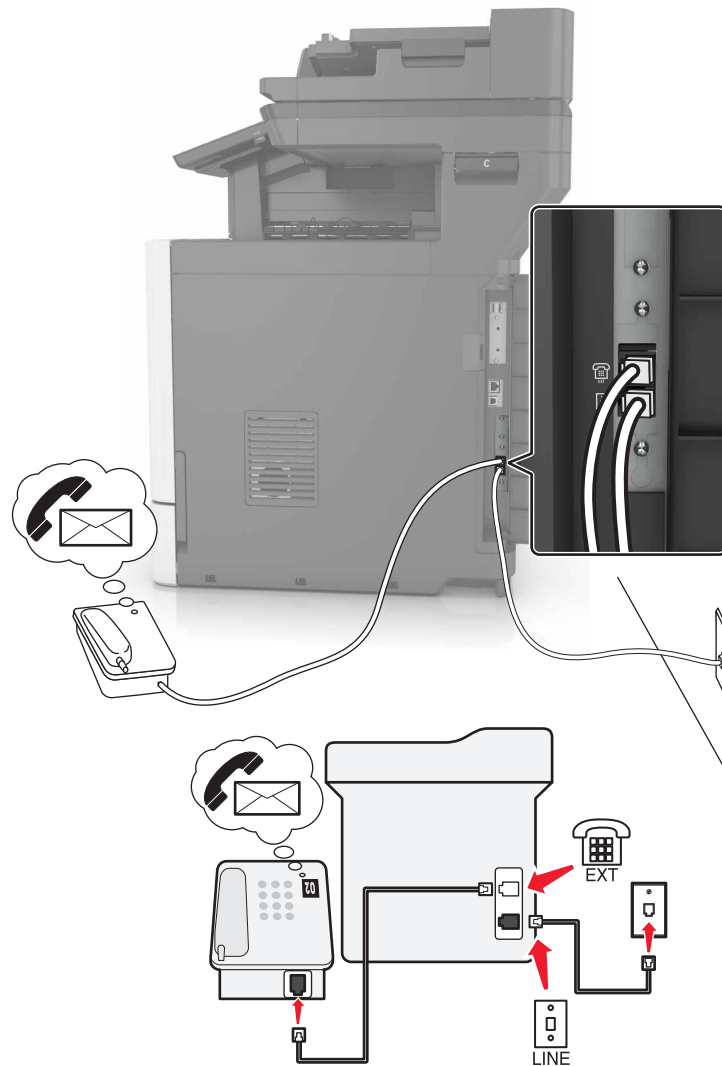



- 1 Connect one end of the telephone cable to the line port of the printer.
- 2 Connect the other end of the cable to an active analog wall jack.
- 3 Connect the telephone to the telephone port of the printer.

Notes:

- This setup works best if you are using voice mail more often than fax, and if you subscribe to a distinctive ring service.
- When you answer the telephone and you hear fax tones, press ***9*** or the manual answer code on the telephone to receive the fax.
- You can also set the printer to receive faxes automatically, but turn off the voice mail service when you are expecting a fax.

Setting up fax using digital subscriber line

-  **CAUTION—SHOCK HAZARD:** To avoid the risk of electrical shock, do not set up this product or make any electrical or cabling connections, such as the power cord, fax feature, or telephone, during a lightning storm.
-  **CAUTION—SHOCK HAZARD:** To avoid the risk of electrical shock, do not use the fax feature during a lightning storm.
-  **CAUTION—POTENTIAL INJURY:** To reduce the risk of fire, use only a 26 AWG or larger telecommunications (RJ-11) cord when connecting this product to the public switched telephone network. For users in Australia, the cord must be approved by the Australian Communications and Media Authority.

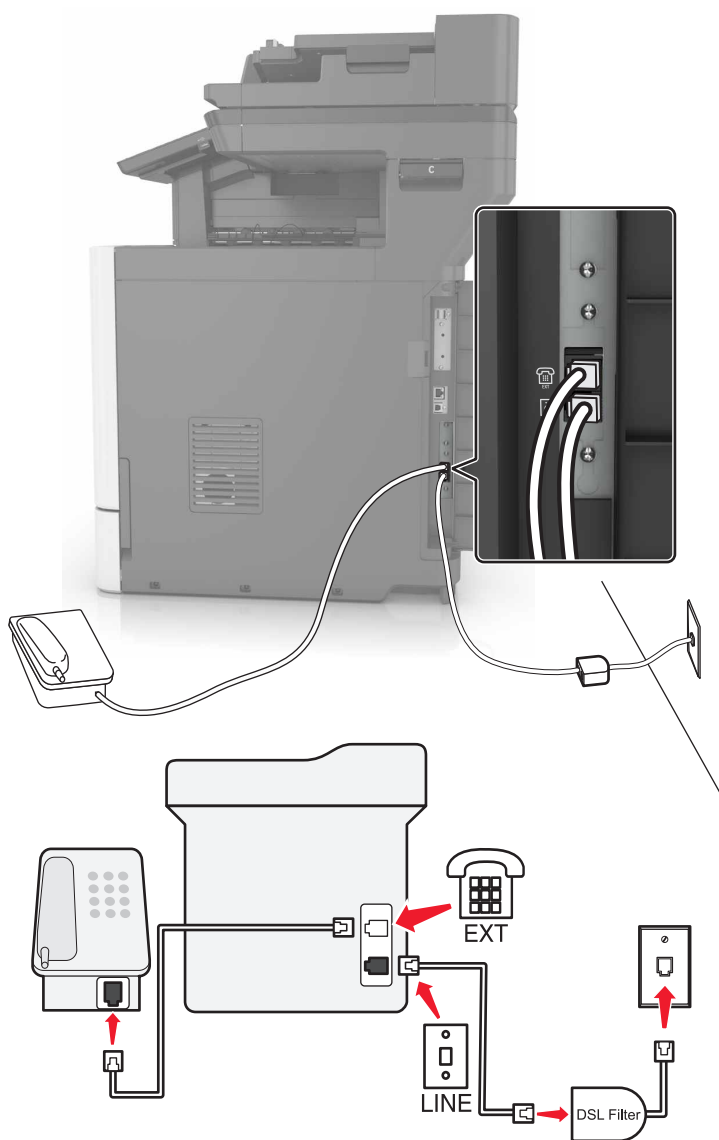

Digital subscriber line (DSL) splits your regular telephone line into two channels: voice and Internet. Telephone and fax signals travel through the voice channel, and Internet signals pass through the other channel.

To minimize interference between the two channels, ask for a DSL filter from your DSL provider.

- 1** Connect the line port of the DSL filter to the wall jack.
- 2** Connect one end of the telephone cable to the line port of the printer.
- 3** Connect the other end of the cable to the telephone port on the DSL filter.

Note: To connect a telephone to the printer, remove any installed adapter plug from the telephone port of the printer, and then connect the telephone.

Setting up fax using VoIP telephone service



CAUTION—SHOCK HAZARD: To avoid the risk of electrical shock, do not set up this product or make any electrical or cabling connections, such as the power cord, fax feature, or telephone, during a lightning storm.



CAUTION—SHOCK HAZARD: To avoid the risk of electrical shock, do not use the fax feature during a lightning storm.



CAUTION—POTENTIAL INJURY: To reduce the risk of fire, use only a 26 AWG or larger telecommunications (RJ-11) cord when connecting this product to the public switched telephone network. For users in Australia, the cord must be approved by the Australian Communications and Media Authority.

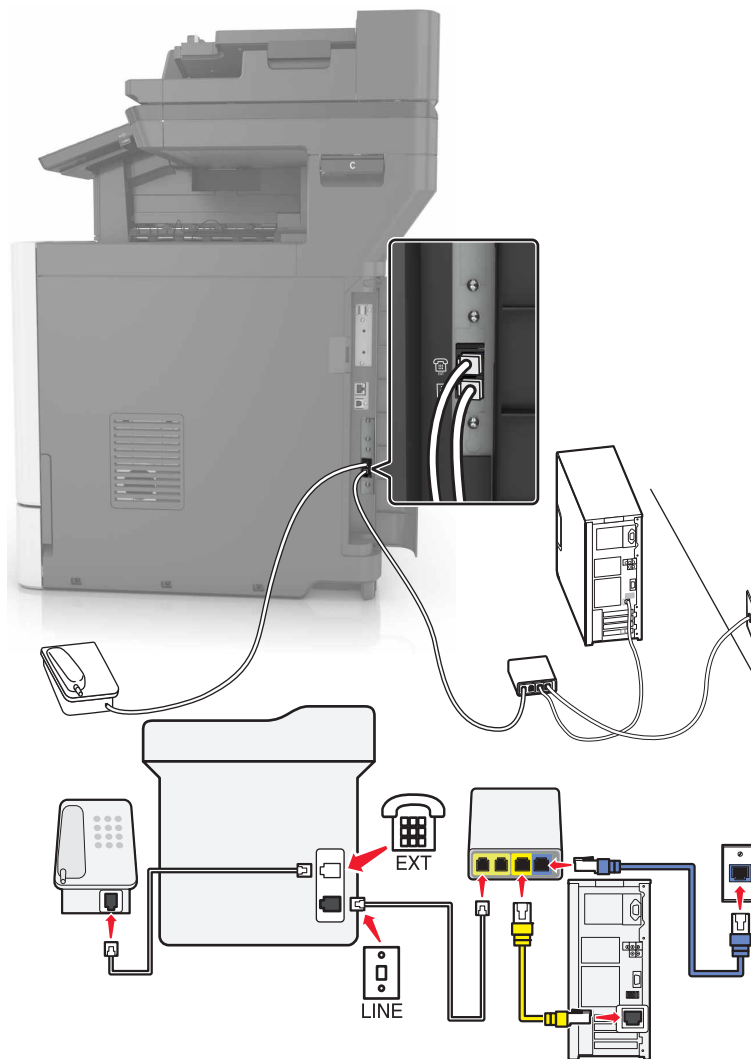

- 1 Connect one end of the telephone cable to the line port of the printer.
- 2 Connect the other end of the cable to the port labeled **Phone Line 1** or **Phone Port** on the VoIP adapter.



Note: The port labeled **Phone Line 2** or **Fax Port** is not always active. VoIP providers may charge extra cost for the activation of the second telephone port.

- 3 Connect the telephone to the telephone port of the printer.

Notes:

- To check if the telephone port on the VoIP adapter is active, plug an analog telephone into the port, and then listen for a dial tone.
- If you need two telephone ports for your devices, but do not want to pay extra cost, then use a phone splitter. Plug the phone splitter into the port labeled **Phone Line 1** or **Phone Port**, and then plug the printer and telephone into the splitter.
- To check the splitter, plug an analog telephone into the splitter, and then listen for a dial tone.

Setting up fax using cable modem connection

-  **CAUTION—SHOCK HAZARD:** To avoid the risk of electrical shock, do not set up this product or make any electrical or cabling connections, such as the power cord, fax feature, or telephone, during a lightning storm.
-  **CAUTION—SHOCK HAZARD:** To avoid the risk of electrical shock, do not use the fax feature during a lightning storm.
-  **CAUTION—POTENTIAL INJURY:** To reduce the risk of fire, use only a 26 AWG or larger telecommunications (RJ-11) cord when connecting this product to the public switched telephone network. For users in Australia, the cord must be approved by the Australian Communications and Media Authority.

Setup 1: Printer is connected directly to a cable modem

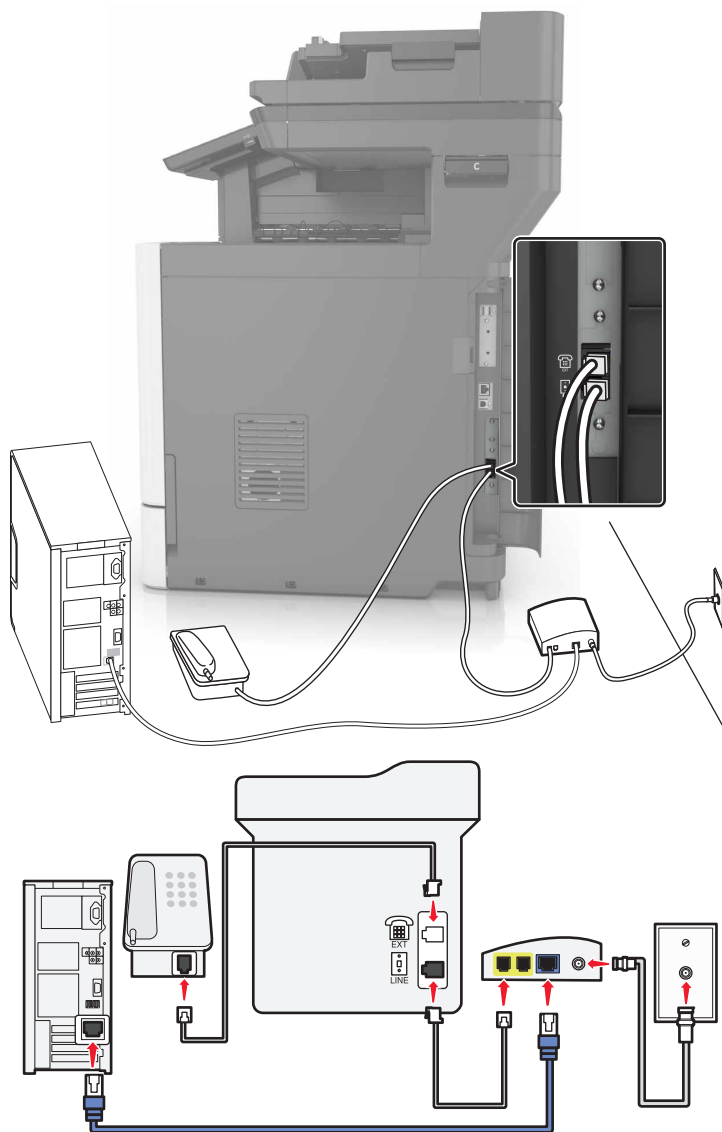

- 1 Connect one end of the telephone cable to the line port of the printer.
- 2 Connect the other end of the cable to the port labeled **Phone Line 1** or **Phone Port** on the cable modem.

3 Connect your analog telephone to the telephone port of the printer.

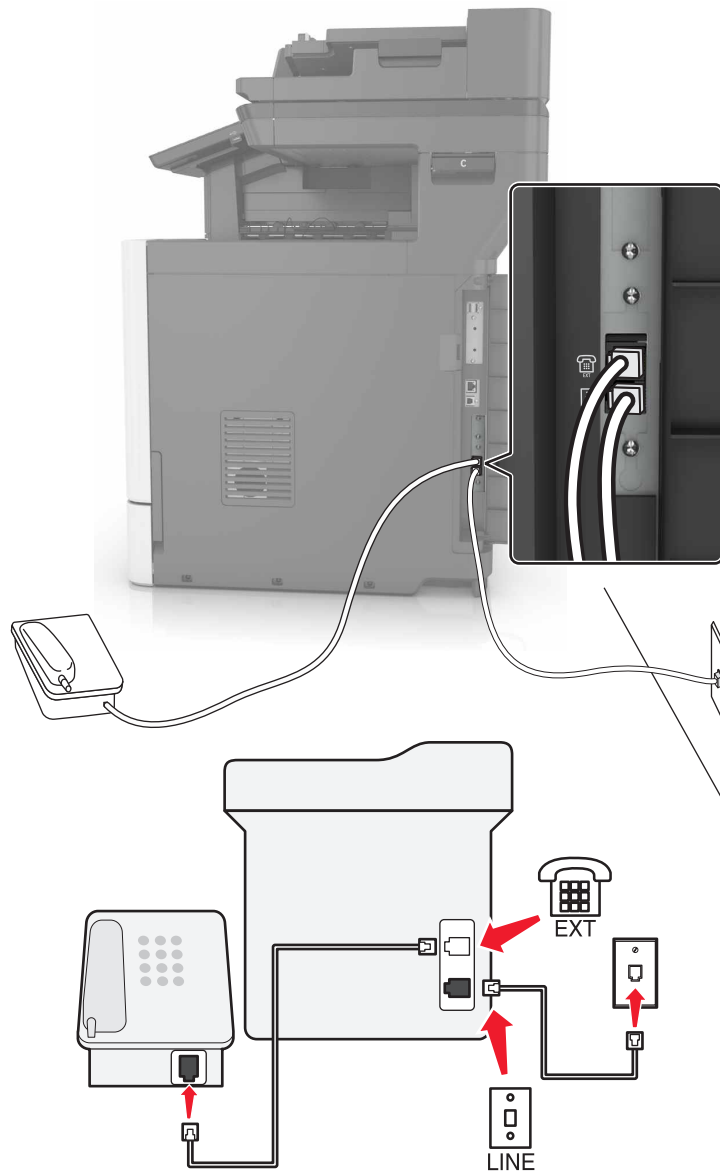

Note: To check if the telephone port on the cable modem is active, connect an analog telephone, and then listen for a dial tone.

Setup 2: Printer is connected to a wall jack; cable modem is installed elsewhere in the facility



- 1** Connect one end of the telephone cable to the line port of the printer.
- 2** Connect the other end of the cable to an active analog telephone wall jack.
- 3** Connect your analog telephone to the telephone port of the printer.

Setting up fax in countries or regions with different telephone wall jacks and plugs

-  **CAUTION—SHOCK HAZARD:** To avoid the risk of electrical shock, do not set up this product or make any electrical or cabling connections, such as the power cord, fax feature, or telephone, during a lightning storm.
-  **CAUTION—SHOCK HAZARD:** To avoid the risk of electrical shock, do not use the fax feature during a lightning storm.
-  **CAUTION—POTENTIAL INJURY:** To reduce the risk of fire, use only a 26 AWG or larger telecommunications (RJ-11) cord when connecting this product to the public switched telephone network. For users in Australia, the cord must be approved by the Australian Communications and Media Authority.

The standard wall jack adopted by most countries or regions is RJ11. If the wall jack or equipment in your facility is not compatible with this type of connection, then use a telephone adapter. An adapter for your country or region may not come with your printer, and you may need to purchase it separately.

There may be an adapter plug installed in the telephone port of the printer. Do not remove the adapter plug from the telephone port of the printer if you are connecting to a serial or cascaded telephone system.

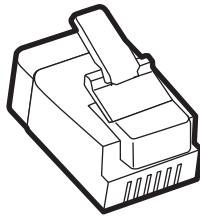

Part name	Part number
Lexmark adapter plug	40X8519

Connecting the printer to a non-RJ11 wall jack

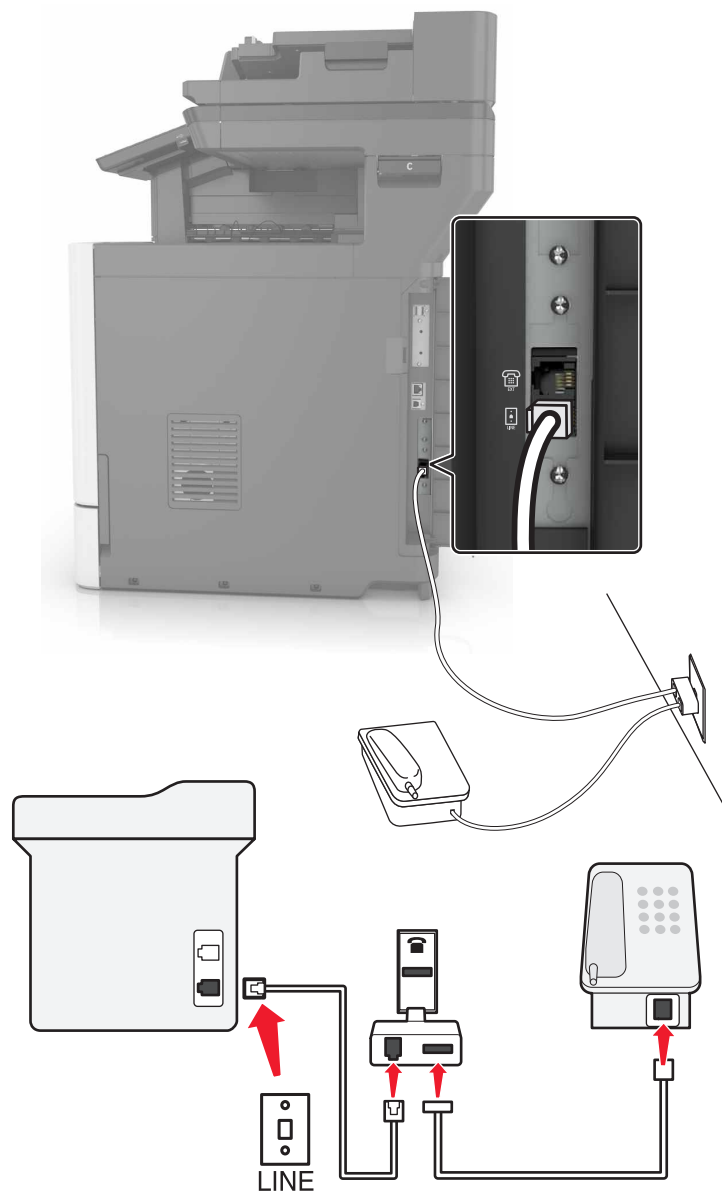

- 1** Connect one end of the telephone cable to the line port of the printer.
- 2** Connect the other end of the cable to the RJ11 adapter, and then connect the adapter to the wall jack.
- 3** If you want to connect another device with a non-RJ11 connector to the same wall jack, then connect it directly to the telephone adapter.

Connecting the printer to a wall jack in Germany

The German wall jack has two kinds of ports. The N ports are for fax machines, modems, and answering machines. The F port is for telephones. Connect the printer to any of the N ports.

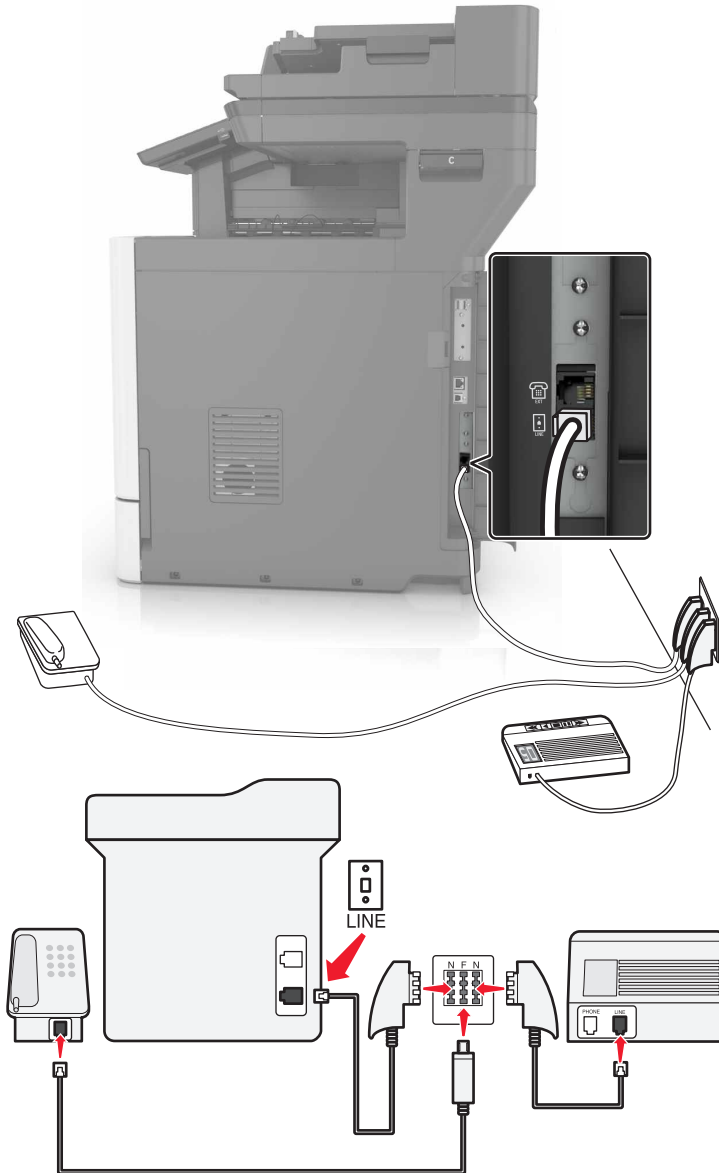

- 1 Connect one end of the telephone cable to the line port of the printer.
- 2 Connect the other end of the cable to the RJ11 adapter, and then connect the adapter to an N port.
- 3 If you want to connect a telephone and answering machine to the same wall jack, then connect the devices as shown.

Connecting to a distinctive ring service

A distinctive ring service lets you have multiple telephone numbers on one telephone line. Each telephone number is assigned a different ring pattern.

- 1 From the home screen, touch **Settings > Fax > Analog Fax Setup > Fax Receive Settings > Admin Controls > Answer On**.
- 2 Select the ring pattern.
- 3 Apply the changes.

Setting the fax date and time

- 1 From the home screen, touch **Settings > Device > Preferences > Date and Time > Configure**.
- 2 Configure the settings.

Configuring daylight saving time

- 1 From the home screen, touch **Settings > Device > Preferences > Date and Time > Configure**.
- 2 In the Time Zone menu, select **Custom**.
- 3 Configure the settings.

Sending a fax

Using the control panel

- 1 Load the original document into the ADF tray or on the scanner glass.
- 2 From the control panel, select **Fax**, and then enter the needed information.
- 3 If necessary, configure other fax settings.
- 4 Fax the document.

Using the computer

For Windows users

- 1 From the document that you are trying to fax, open the Print dialog.
- 2 Select the printer, and then click **Properties, Preferences, Options, or Setup**.
- 3 Click **Fax > Enable fax**, and then enter the recipient number.
- 4 If necessary, configure other fax settings.
- 5 Fax the document.

For Macintosh users

- 1 With a document open, choose **File > Print**.
- 2 Select the printer, and then enter the recipient number.
- 3 If necessary, configure other fax settings.
- 4 Fax the document.

Scheduling a fax

- 1 Load the original document into the ADF tray or on the scanner glass.
- 2 From the home screen, navigate to:
Fax > enter the fax number > Send Time
- 3 Configure the date and time to send the fax.
- 4 If necessary, configure other fax settings.
- 5 Send the fax job.

Creating a fax destination shortcut

- 1 From the home screen, touch **Fax > To**.
- 2 Enter the recipient number.

Note: To create a group of fax numbers, touch , and then enter another fax number.

- 3 Touch .
- 4 Enter a shortcut name.
- 5 Apply the changes.

Changing the fax resolution

- 1 Load an original document into the ADF tray or on the scanner glass.
- 2 From the home screen, touch **Fax**, and then enter the needed information.
- 3 Adjust the Resolution setting.
- 4 Send the fax job.

Adjusting the fax darkness

- 1 Load an original document into the ADF tray or on the scanner glass.
- 2 From the home screen, touch **Fax**, and then enter the needed information.

- 3 Adjust the Darkness setting.
- 4 Send the fax job.

Viewing a fax log

- 1 Open a Web browser, and then type the printer IP address in the address field.

Notes:

- View the printer IP address on the printer home screen. The IP address appears as four sets of numbers separated by periods, such as 123.123.123.123.
- If you are using a proxy server, then temporarily disable it to load the Web page correctly.

- 2 Click **Settings** > **Reports** > **Fax**.
- 3 Click **Fax Job Log** or **Fax Call Log**.

Blocking junk faxes

- 1 From the home screen, touch **Settings** > **Fax** > **Analog Fax Setup** > **Fax Receive Settings** > **Admin Controls** > **Block No Name Fax**.
- 2 Apply the changes.

Holding faxes

- 1 From the home screen, touch **Settings** > **Fax** > **Analog Fax Setup** > **Fax Receive Settings** > **Holding Faxes**.
- 2 Select a mode.

Forwarding a fax

- 1 From the home screen, touch **Settings** > **Fax** > **Analog Fax Setup** > **Fax Receive Settings** > **Admin Controls**.
- 2 Configure the Fax Forwarding, Forward To, and Forward to Shortcut settings.
- 3 Apply the changes.

Scanning

Scanning to an FTP server

- 1 Load the original document into the ADF tray or on the scanner glass.
- 2 From the home screen, touch **FTP**, and then enter the needed information.
- 3 If necessary, configure other FTP settings.
- 4 Send the FTP job.

Creating an FTP shortcut

- 1 From the home screen, touch **FTP**.
- 2 Enter the FTP server address, and then touch .
- 3 Enter a shortcut name.
- 4 Apply the changes.

Scanning to a flash drive

- 1 Load an original document into the ADF tray or on the scanner glass.
- 2 Insert the flash drive.

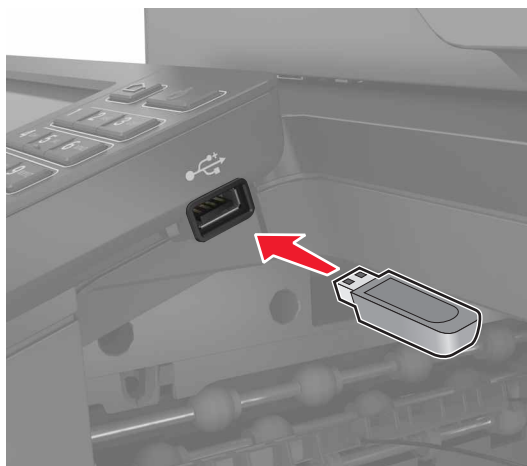

- 3 Touch **Scan to USB** and adjust the settings if necessary.

Note: If the USB Drive screen does not appear, then touch **USB Drive** on the home screen.

- 4 Scan the document.

Warning—Potential Damage: To avoid loss of data or printer malfunction, do not touch the flash drive or the printer in the area shown while actively printing, reading, or writing from the memory device.



Sending scanned documents to a computer

- 1 Load an original document into the ADF tray or on the scanner glass.
- 2 From the home screen, touch **Scan Profiles** > **Scan To Computer**.
- 3 Select the scan profile where you want to save the document.

Securing the printer

Locating the security slot

The printer is equipped with a security lock feature. Attach a security lock compatible with most laptop computers in the location shown to secure the printer in place.



Erasing printer memory

To erase volatile memory or buffered data in your printer, turn off the printer.

To erase non-volatile memory or individual settings, device and network settings, security settings, and embedded solutions, do the following:

- 1 From the home screen, touch **Settings > Device > Maintenance > Out of Service Erase**.
- 2 Select the **Sanitize all information on nonvolatile memory** check box, and then touch **ERASE**.
- 3 Follow the instructions on the display.

Erasing printer hard disk memory

- 1 From the home screen, touch **Settings > Device > Maintenance > Out of Service Erase**.
- 2 Select the **Sanitize all information on hard disk** check box, and then touch **ERASE**.
- 3 Follow the instructions on the display.

Note: This process can take from several minutes to more than an hour, making the printer unavailable for other tasks.

Configuring printer hard disk encryption

1 From the home screen, touch **Settings > Security > Disk Encryption > Start Encryption**.

Note: Enabling disk encryption erases the contents of the hard disk. If necessary, back up important data from the printer before starting the encryption.

2 Follow the instructions on the display.

Notes:

- Do not turn off the printer during the encryption process. Loss of data can occur.
- Disk encryption can take from several minutes to more than an hour, making the printer unavailable for other tasks.
- After encryption, the printer returns to the home screen.

Restoring factory default settings

From the home screen, touch **Settings > Device > Restore Factory Defaults > Restore Settings > Restore all settings > RESTORE > Start**.

For more information, see [“Erasing printer memory” on page 56](#).

Statement of Volatility

Your printer contains various types of memory that can store device and network settings, and user data.

Type of memory	Description
Volatile memory	Your printer uses standard <i>random access memory</i> (RAM) to temporarily buffer user data during simple print jobs.
Non-volatile memory	Your printer may use two forms of non-volatile memory: EEPROM and NAND (flash memory). Both types are used to store the operating system, device settings, network information and bookmark settings, and embedded solutions.
Hard disk memory	Some printers have a hard disk drive installed. The printer hard disk is designed for printer-specific functionality. This lets the printer retain buffered user data from complex print jobs, as well as form data, and font data.

Erase the content of any installed printer memory in the following circumstances:

- The printer is being decommissioned.
- The printer hard disk is being replaced.
- The printer is being moved to a different department or location.
- The printer is being serviced by someone from outside your organization.
- The printer is being removed from your premises for service.
- The printer is being sold to another organization.

Disposing of a printer hard disk

Note: Some printer models may not have a printer hard disk installed.

In high-security environments, it may be necessary to take additional steps to make sure that confidential data stored in the printer hard disk cannot be accessed when the printer—or its hard disk—is removed from your premises.

- **Degaussing**—Flushes the hard disk with a magnetic field that erases stored data
- **Crushing**—Physically compresses the hard disk to break component parts and render them unreadable
- **Milling**—Physically shreds the hard disk into small metal bits

Note: Most data can be erased electronically, but the only way to guarantee that all data are completely erased is to physically destroy each hard disk where data is stored.

Maintaining the printer

Warning—Potential Damage: Failure to maintain optimum printer performance, or to replace parts and supplies, may cause damage to your printer.

Adjusting the speaker volume

Adjusting the default internal speaker volume

The speaker volume will reset to default value after the session is logged out, when the printer wakes from Sleep or Hibernate mode, or after a power-on reset.

- 1 From the control panel, navigate to:
Settings > Device > Preferences > Audio Feedback
- 2 Select the volume.

Note: If Quiet Mode is enabled, then audible alerts are turned off.

Adjusting the default headphones volume

Headphones volume will reset to default value after the session is logged out, when the printer wakes from Sleep or Hibernate mode, or after a power-on reset.

- 1 From the control panel, select **Settings > Device > Accessibility > Headphone Volume**.
- 2 Select the volume.

Configuring the fax speaker settings

Note: This feature is available only in some printer models.

- 1 From the home screen, select **Settings > Fax > Analog Fax Setup > Speaker Settings**.
- 2 Do the following:
 - Set the Speaker Mode to **Always On**.
 - Set the Speaker Volume to **High**.
 - Activate the Ringer Volume.

Networking

Note: Purchase a MarkNet(TM) N8360 wireless network adapter first before setting up the printer on a wireless network. For information on installing the wireless network adapter, see the setup sheet that came with the adapter.

Connecting the printer to a wireless network using Wi-Fi Protected Setup (WPS)

Before you begin, make sure that:

- The access point (wireless router) is WPS-certified or WPS-compatible. For more information, see the documentation that came with your access point.
- A wireless network adapter is installed in your printer. For more information, see the instructions that came with the adapter.

Using the Push Button method

- 1 From the control panel, navigate to:
Settings > Network/Ports > Wireless > Wi-Fi Protected Setup > Start Push Button Method
- 2 Follow the instructions on the display.

Using the personal identification number (PIN) method

- 1 From the control panel, navigate to:
Settings > Network/Ports > Wireless > Wi-Fi Protected Setup > Start PIN Method
- 2 Copy the eight-digit WPS PIN.
- 3 Open a Web browser, and then type the IP address of your access point in the address field.

Notes:

- View the printer IP address on the printer home screen. The IP address appears as four sets of numbers separated by periods, such as 123.123.123.123.
 - If you are using a proxy server, then temporarily disable it to load the Web page correctly.
- 4 Access the WPS settings. For more information, see the documentation that came with your access point.
 - 5 Enter the eight-digit PIN, and then save the changes.

Changing port settings after installing an internal solutions port

Notes:

- If the printer has a static IP address, then do not change the configuration.
- If the computers are configured to use the network name instead of an IP address, then do not change the configuration.
- If you are adding a wireless internal solutions port (ISP) to a printer previously configured for an Ethernet connection, then disconnect the printer from the Ethernet network.

For Windows users

- 1 Open the printers folder.
- 2 From the shortcut menu of the printer with the new ISP, open the printer properties.
- 3 Configure the port from the list.
- 4 Update the IP address.
- 5 Apply the changes.

For Macintosh users

- 1 From System Preferences in the Apple menu, navigate to the list of printers, and then select + > **IP**.
- 2 Type the IP address in the address field.
- 3 Apply the changes.

Setting up serial printing (Windows only)

- 1 Set the parameters in the printer.
 - a From the control panel, navigate to the menu for the port settings.
 - b Locate the menu for the serial port settings, and then adjust the settings, if necessary.
 - c Apply the changes.
- 2 From your computer, open the printers folder, and then select your printer.
- 3 Open the printer properties, and then select the COM port from the list.
- 4 Set the COM port parameters in Device Manager.

Notes:

- Serial printing reduces printing speed.
- Make sure that the serial cable is connected to the serial port on your printer.

Cleaning printer parts

Cleaning the printer

⚠ CAUTION—SHOCK HAZARD: To avoid the risk of electrical shock when cleaning the exterior of the printer, unplug the power cord from the electrical outlet and disconnect all cables from the printer before proceeding.

Notes:

- Perform this task after every few months.
- Damage to the printer caused by improper handling is not covered by the printer warranty.

- 1 Turn off the printer, and then unplug the power cord from the electrical outlet.
- 2 Remove paper from the standard bin and multipurpose feeder.
- 3 Remove any dust, lint, and pieces of paper around the printer using a soft brush or vacuum.
- 4 Wipe the outside of the printer with a damp, soft, lint-free cloth.

Notes:

- Do not use household cleaners or detergents, as they may damage the finish of the printer.
- Make sure that all areas of the printer are dry after cleaning.

- 5 Connect the power cord to the electrical outlet, and then turn on the printer.

⚠ CAUTION—POTENTIAL INJURY: To avoid the risk of fire or electrical shock, connect the power cord to an appropriately rated and properly grounded electrical outlet that is near the product and easily accessible.

Cleaning the scanner

- 1 Open the scanner cover.



2 Using a damp, soft, lint-free cloth, wipe the following areas:

- ADF glass

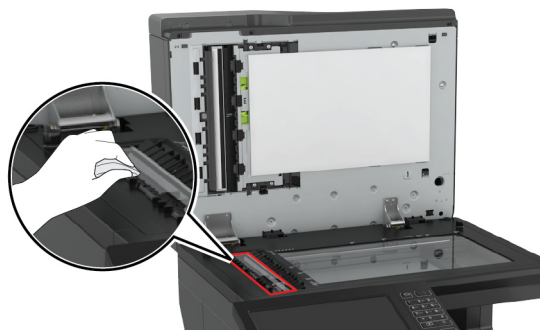

- ADF glass pad

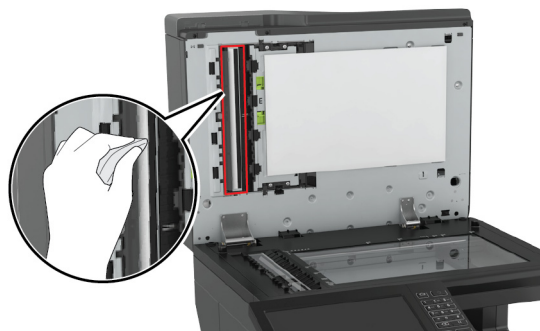

- Scanner glass

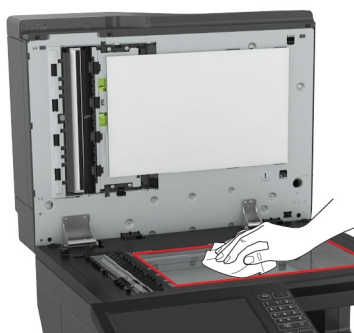

- Scanner glass pad

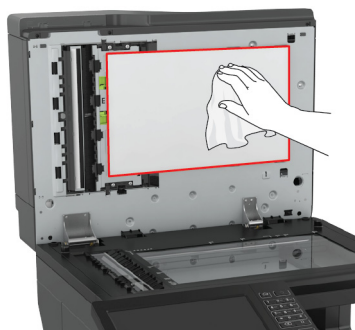

3 Open door E.

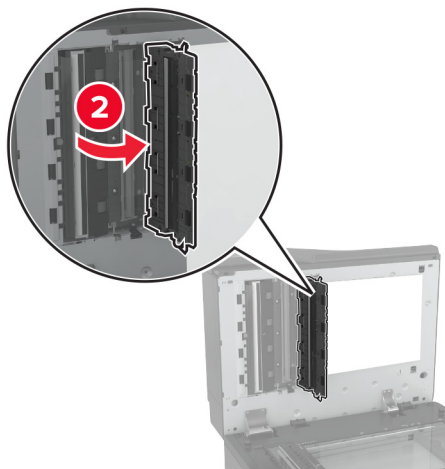
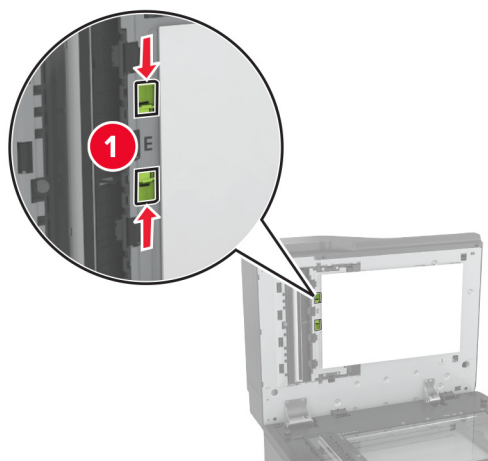

4 Wipe the following areas:

- ADF glass in door E

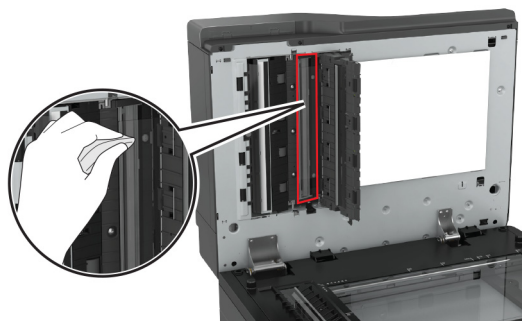

- ADF glass pad in door E

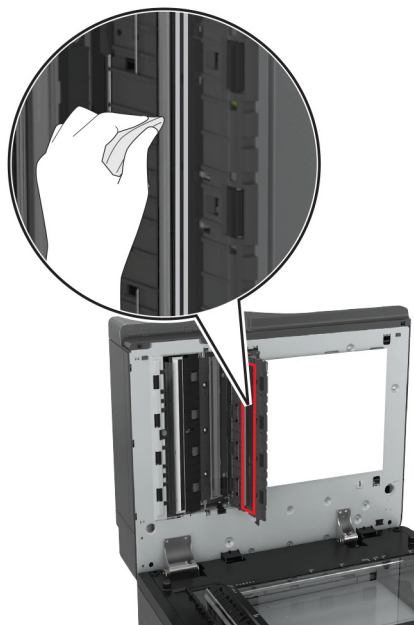
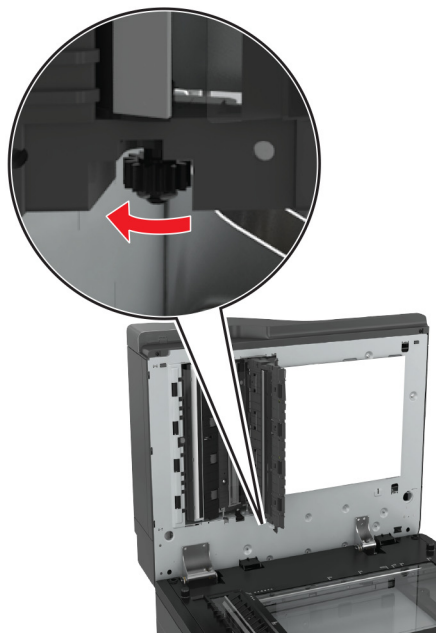

5 Close the door, and then close the scanner cover.

Ordering parts and supplies

To order parts and supplies in the U.S., contact 1-800-539-6275 for information about Lexmark authorized supplies dealers in your area. In other countries or regions, go to www.lexmark.com or contact the place where you purchased the printer.

Note: All life estimates for printer supplies assume printing on letter- or A4-size plain paper.

Checking the status of parts and supplies

- 1 From the home screen, touch **Status/Supplies**.
- 2 Select the parts or supplies that you want to check.

Note: You can also access this setting by touching the top section of the home screen.

Using genuine Lexmark parts and supplies

Your Lexmark printer is designed to function best with genuine Lexmark parts and supplies. Use of third-party supplies or parts may affect the performance, reliability, or life of the printer and its imaging components. It can also affect warranty coverage. Damage caused by the use of third-party parts and supplies is not covered by the warranty. All life indicators are designed to function with Lexmark parts and supplies, and may deliver unpredictable results if third-party parts and supplies are used. Imaging component usage beyond the intended life may damage your Lexmark printer or its associated components.

Ordering toner cartridges

Notes:

- The estimated cartridge yield is based on the ISO/IEC 19798 standard.
- Extremely low print coverage for extended periods of time may negatively affect actual yield and may cause cartridge parts to fail before toner exhaustion.

CX820 Return Program cartridges

Item	United States and Canada	European Economic Area (EEA+)	Rest of Europe, Middle East, and Africa (RoEMEA)	Latin America Distribution (LAD)	Rest of Asia Pacific (RoAP)	Australia and New Zealand (ANZ)
Return Program toner cartridges						
Black	72K10K0	72K20K0	72K50K0	72K40K0	72K30K0	72K60K0
Cyan	72K10C0	72K20C0	72K50C0	72K40C0	72K30C0	72K60C0
Magenta	72K10M0	72K20M0	72K50M0	72K40M0	72K30M0	72K60M0
Yellow	72K10Y0	72K20Y0	72K50Y0	72K40Y0	72K30Y0	72K60Y0
High Yield Return Program toner cartridges						
Cyan	82K1HC0	82K2HC0	82K5HC0	82K4HC0	82K3HC0	82K6HC0

Item	United States and Canada	European Economic Area (EEA+)	Rest of Europe, Middle East, and Africa (RoEMEA)	Latin America Distribution (LAD)	Rest of Asia Pacific (RoAP)	Australia and New Zealand (ANZ)
Magenta	82K1HM0	82K2HM0	82K5HM0	82K4HM0	82K3HM0	82K6HM0
Yellow	82K1HY0	82K2HY0	82K5HY0	82K4HY0	82K3HY0	82K6HY0
Extra High Yield Return Program toner cartridge						
Black	72K1XK0	72K2XK0	72K3XK0	72K4XK0	72K5XK0	72K6XK0

CX820 Regular cartridges

Item	Worldwide
High yield regular toner cartridges	
Cyan	82K0H20
Magenta	82K0H30
Yellow	82K0H40
Extra high yield regular toner cartridge	
Black	72K0X10

CX827 Return Program cartridges

Item	United States and Canada	European Economic Area (EEA+)	Rest of Europe, Middle East, and Africa (RoEMEA)	Latin America Distribution (LAD)	Rest of Asia Pacific (RoAP)	Australia and New Zealand (ANZ)
Regular Program toner cartridges						
Black	73B10K0	73B20K0	73B50K0	73B40K0	73B30K0	73B60K0
Cyan	73B10C0	73B20C0	73B50C0	73B40C0	73B30C0	73B60C0
Magenta	73B10M0	73B20M0	73B50M0	73B40M0	73B30M0	73B60M0
Yellow	73B10Y0	73B20Y0	73B50Y0	73B40Y0	73B30Y0	73B60Y0

CX827 Regular cartridges

Item	Worldwide
Regular toner cartridges	
Black	73B0010
Cyan	73B0020
Magenta	73B0030
Yellow	73B0040

Ordering a photoconductor unit

Item	Part number
Photoconductor unit (1 pack)	72K0P00
Photoconductor unit (3 pack)	72K0Q00

Ordering a developer and PC unit combo pack

Item	All countries and regions
Return Program developer and PC unit combo pack	
Black	72K0FK0
Color (CMY)	72K0FV0
Regular developer and PC unit combo pack	
Black	72K0F10
Color (CMY)	72K0F50

Ordering developer units

Item	Part number
Return Program developer units	
Black developer unit	72K0DK0
Color (CMY) developer kit	72K0DV0
Cyan developer unit	72K0DC0
Magenta developer unit	72K0DM0
Yellow developer unit	72K0DY0
Regular developer units	
Black developer unit	72K0D10
Color (CMY) developer kit	72K0D50
Cyan developer unit	72K0D20
Magenta developer unit	72K0D30
Yellow developer unit	72K0D40

Ordering staple cartridges

Item	Part number
Staple cartridges	25A0013

Ordering a waste toner bottle

Item	Part number
Waste toner bottle	72K0W00

Configuring supply notifications

1 Open a web browser, and then type the printer IP address in the address field.

Notes:

- View the printer IP address on the printer home screen. The IP address appears as four sets of numbers separated by periods, such as 123.123.123.123.
- If you are using a proxy server, then temporarily disable it to load the web page correctly.

2 Click **Settings > Device > Notifications**.

3 From the Supplies menu, click **Custom Supply Notifications**.

4 Select a notification for each supply item.

5 Apply the changes.

Replacing parts and supplies

Replacing a developer unit

1 Open door A.

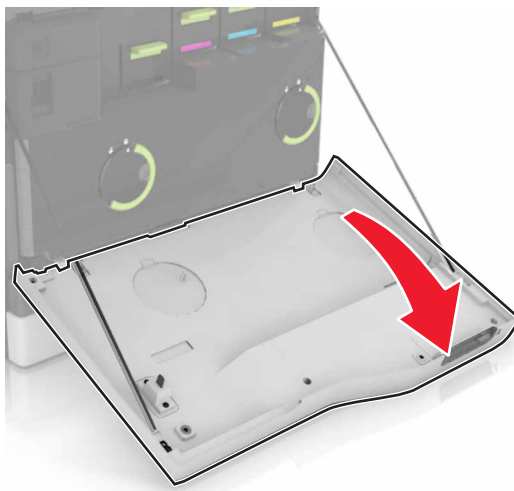

2 Remove the waste toner bottle.

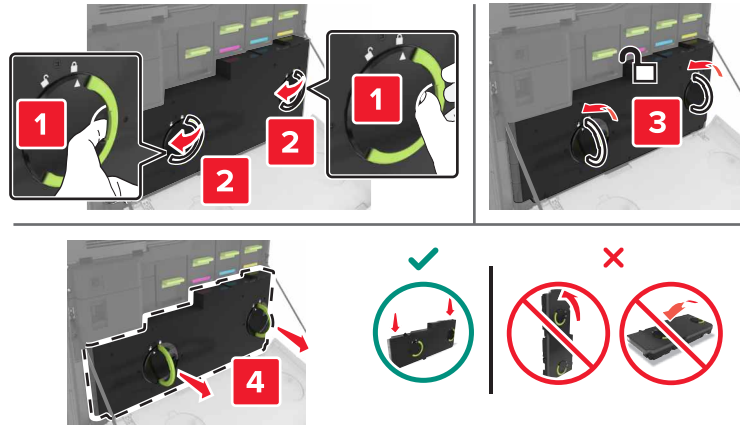

3 Remove the imaging unit.

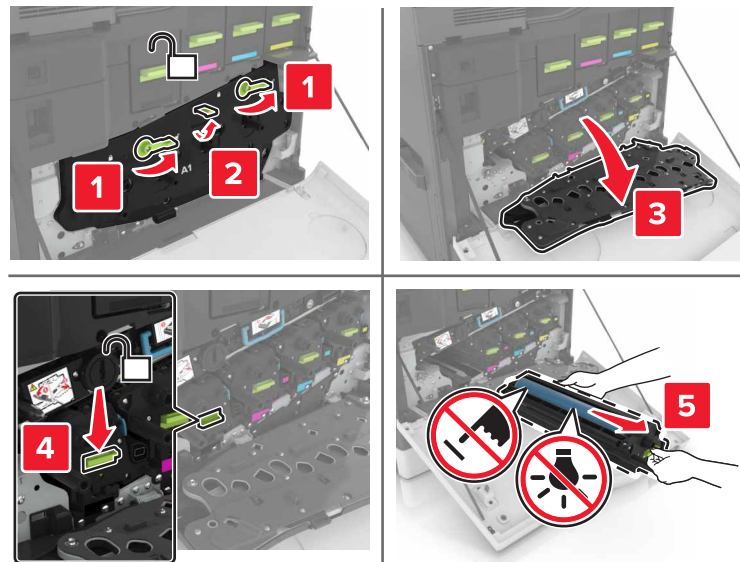

4 Remove the developer unit.

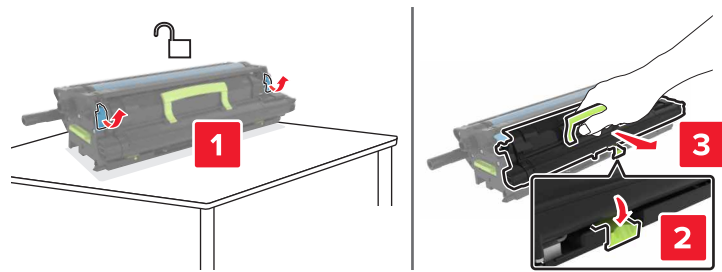

5 Unpack the new developer unit, and then remove the packing material.

6 Insert the new developer unit.

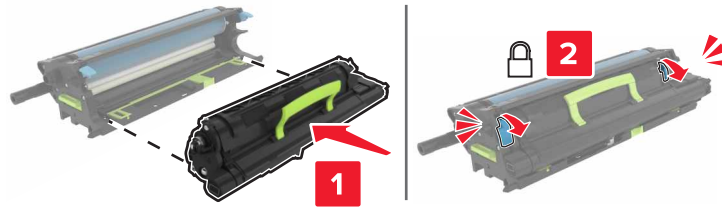

7 Insert the imaging unit.

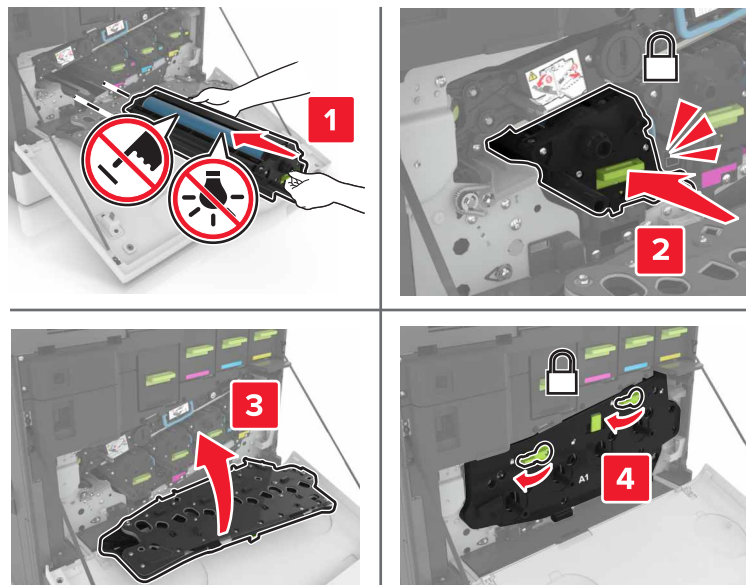

8 Insert the waste toner bottle.

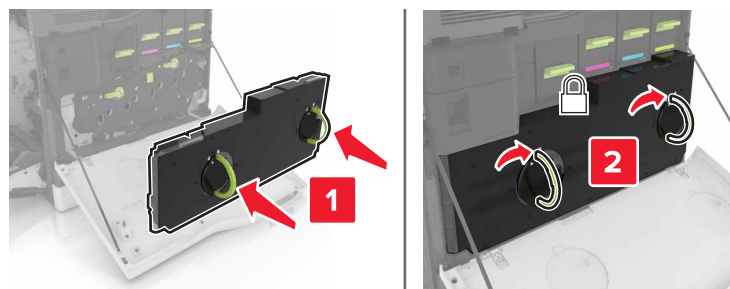

9 Close door A.

Replacing the fuser

1 Turn off the printer.

2 Open door B.

 **CAUTION—HOT SURFACE:** The inside of the printer might be hot. To reduce the risk of injury from a hot component, allow the surface to cool before touching it.

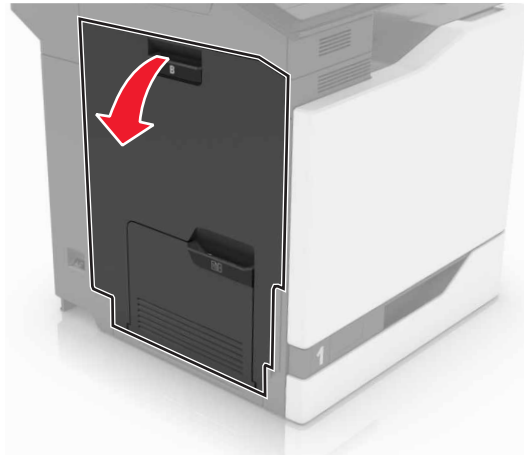

3 Remove the fuser.

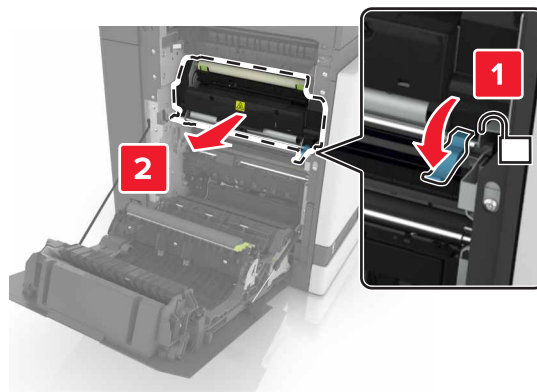

4 Unpack the new fuser.

5 Clean the fuser lens using the cotton swab that came with the package.

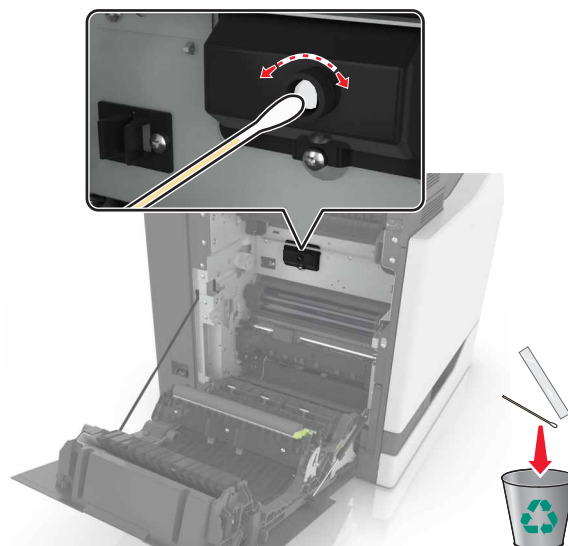

6 Insert the new fuser until it *clicks* into place.

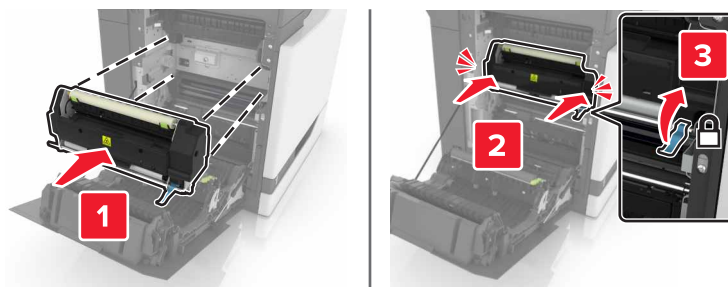

7 Close door B.

8 Turn on the printer.

Replacing a photoconductor unit

1 Open door A.

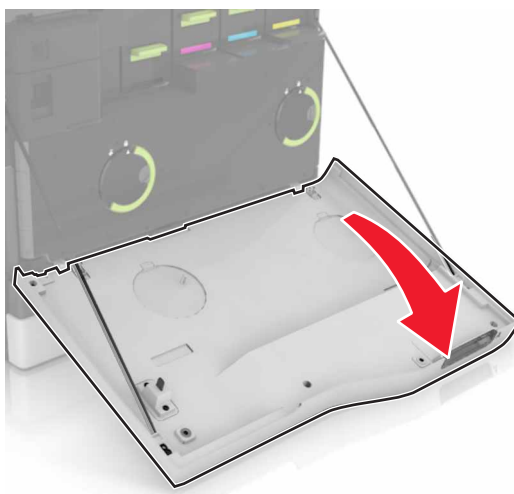

2 Remove the waste toner bottle.

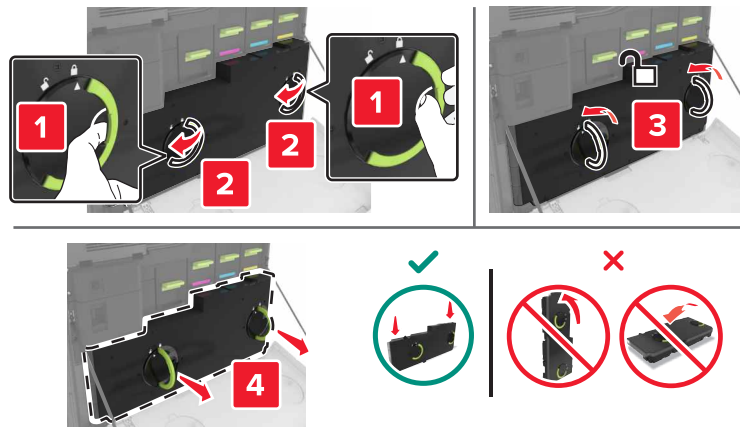

3 Remove the imaging unit.

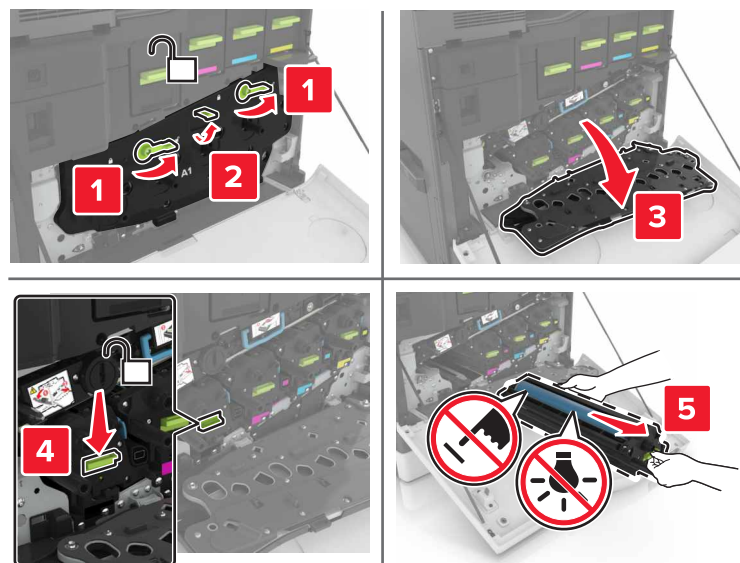

4 Remove the photoconductor unit.

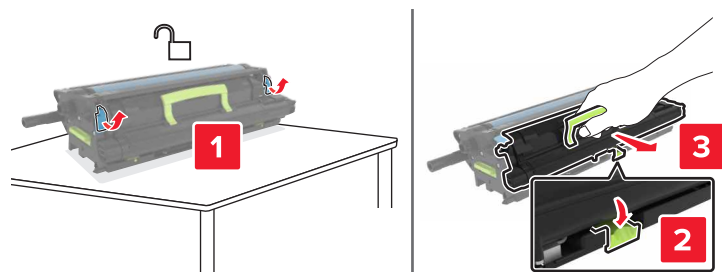

5 Unpack the new photoconductor unit, and then remove the packing material.

Warning—Potential Damage: Do not expose the photoconductor unit to direct light for more than 10 minutes. Extended exposure to light may cause print quality problems.

Warning—Potential Damage: Do not touch the photoconductor drum. Doing so may affect the print quality of future print jobs.

6 Insert the new photoconductor unit.

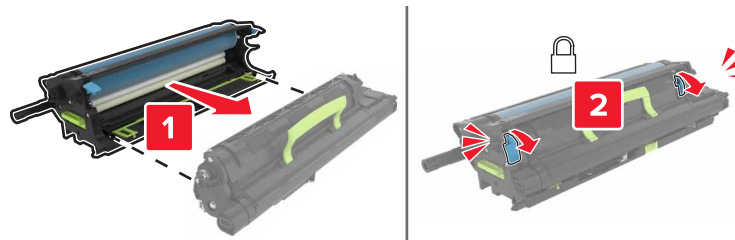

7 Insert the imaging unit.

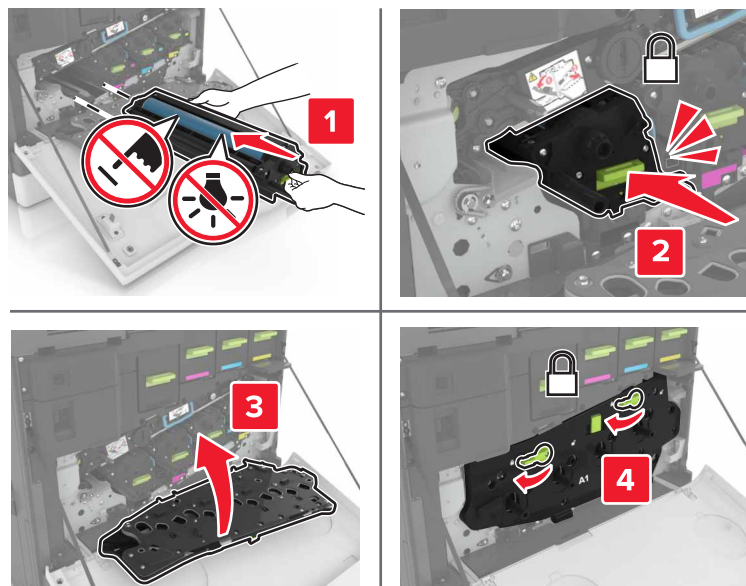

8 Insert the waste toner bottle.

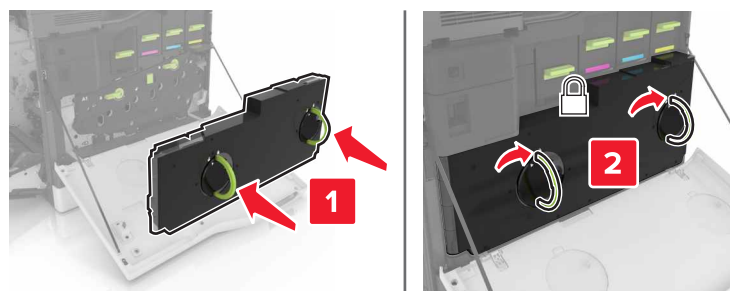

9 Close door A.

Replacing an imaging unit

1 Open door A.

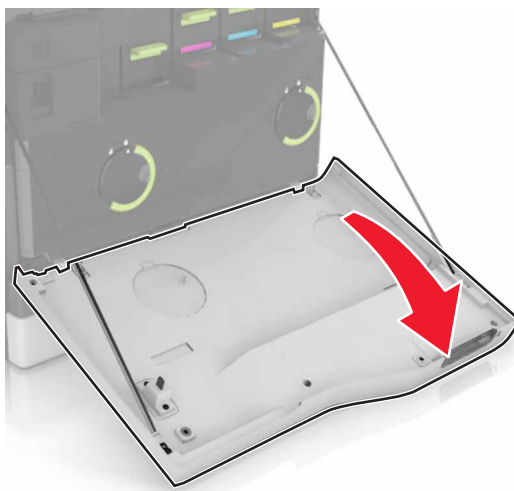

2 Remove the waste toner bottle.

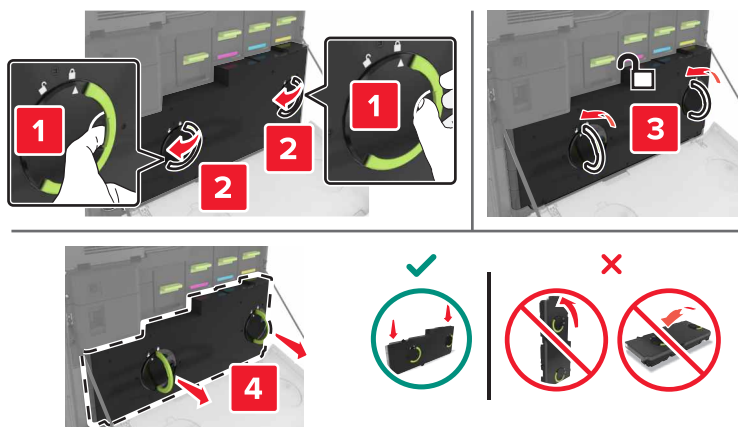

3 Remove the imaging unit.

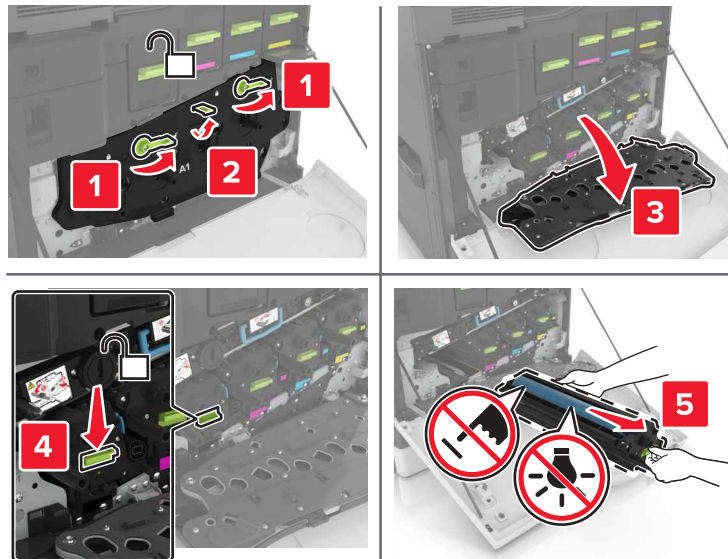

4 Unpack the new imaging unit, and then remove the packing material.

Warning—Potential Damage: Do not expose the photoconductor unit to direct light for more than 10 minutes. Extended exposure to light may cause print quality problems.

Warning—Potential Damage: Do not touch the photoconductor drum. Doing so may affect the print quality of future print jobs.

5 Insert the new imaging unit.

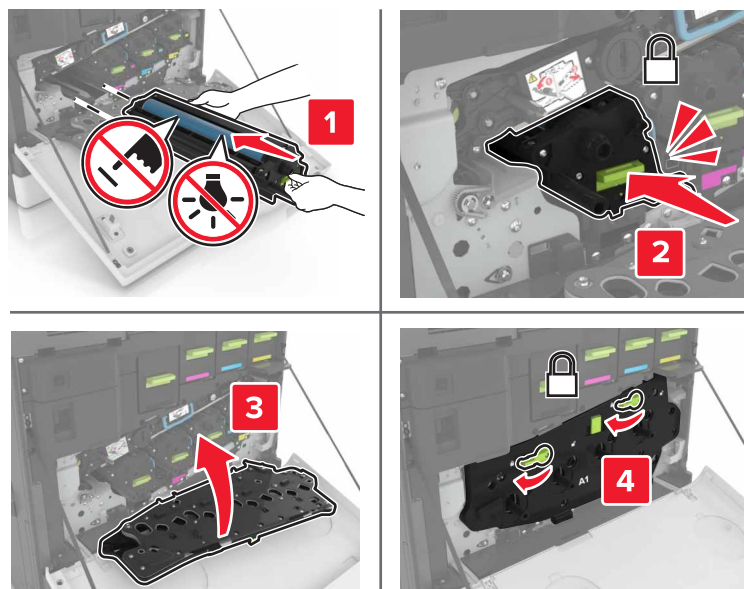

6 Insert the waste toner bottle.

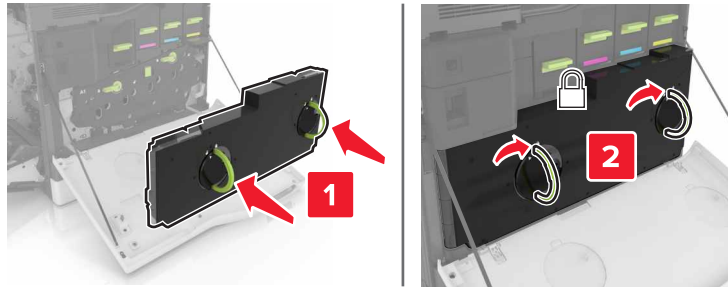

7 Close door A.

Replacing a toner cartridge

1 Open door A.

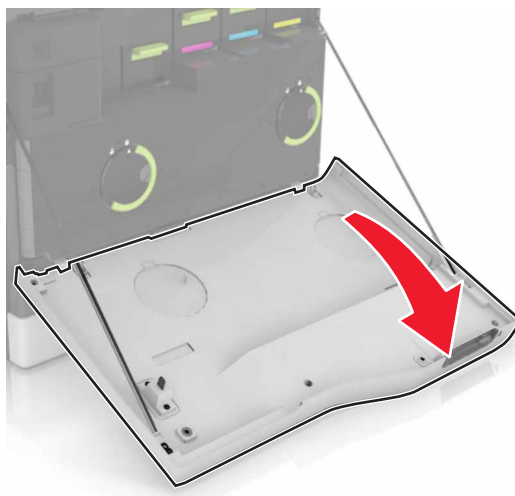

2 Remove the toner cartridge.



3 Unpack the new toner cartridge.

- 4 Insert the new toner cartridge until it *clicks* into place.

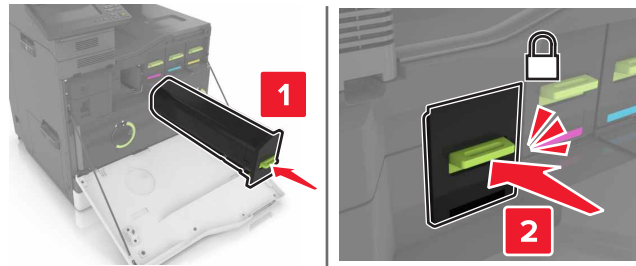

- 5 Close door A.

Replacing the pick roller

Replacing the pick roller in the 550-sheet tray or envelope tray

- 1 Turn off the printer.
- 2 Remove the tray.

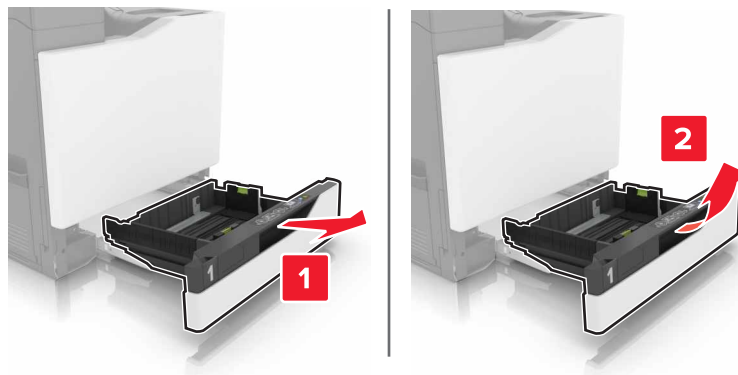

3 Remove the pick roller.

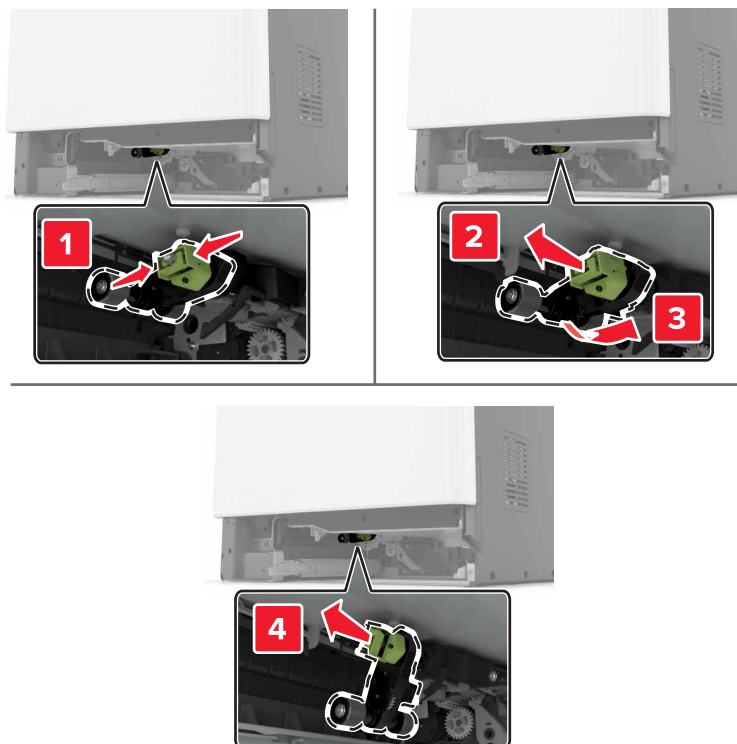

4 Unpack the new pick roller.

5 Insert the new pick roller until it *clicks* into place.

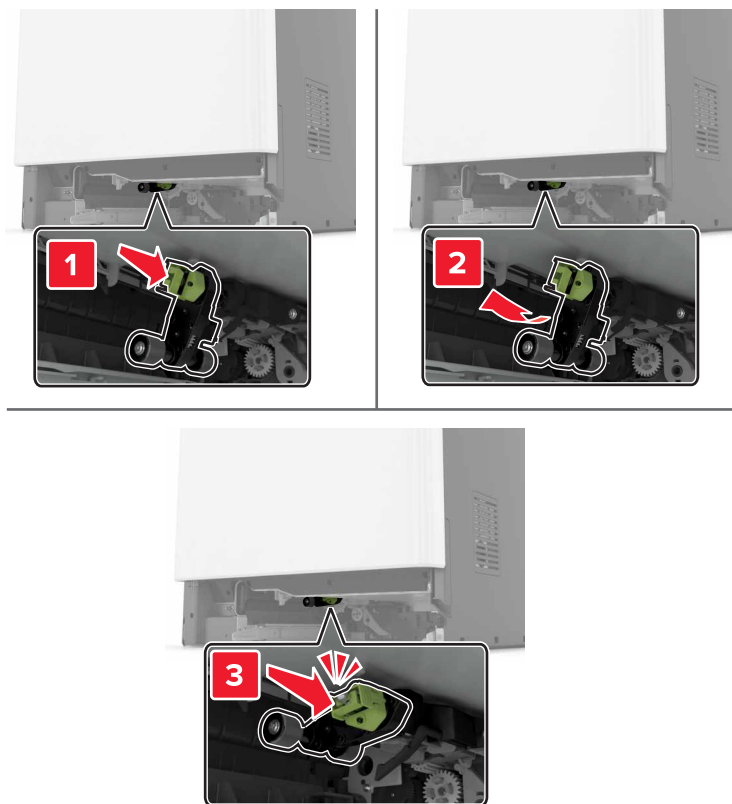

6 Insert the tray.

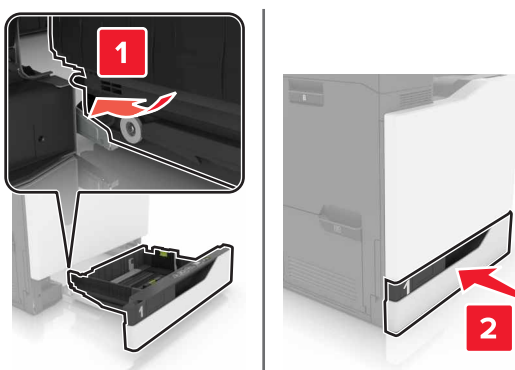

7 Turn on the printer.

Replacing the pick roller in the 2200-sheet tray

- 1 Turn off the printer.
- 2 Pull out, and then unlock the tray.

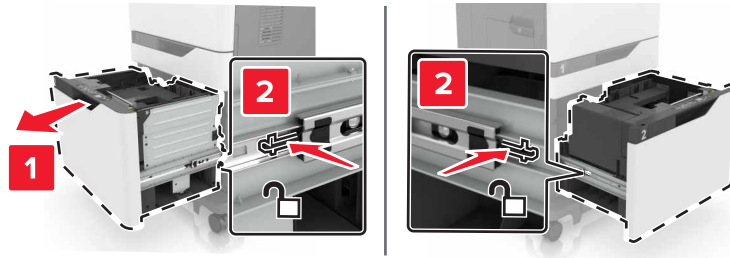

- 3 Remove the tray.
- 4 Remove the pick roller.

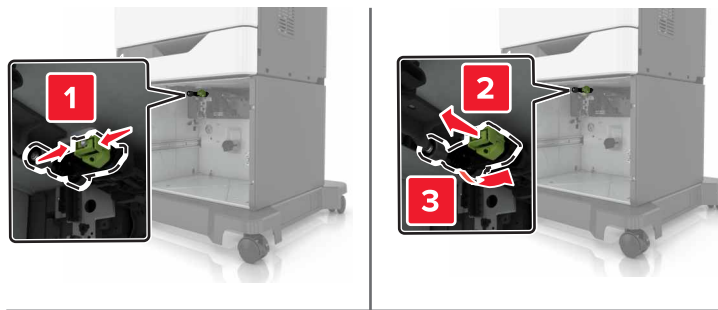

- 5 Unpack the new pick roller.

6 Insert the new pick roller until it *clicks* into place.

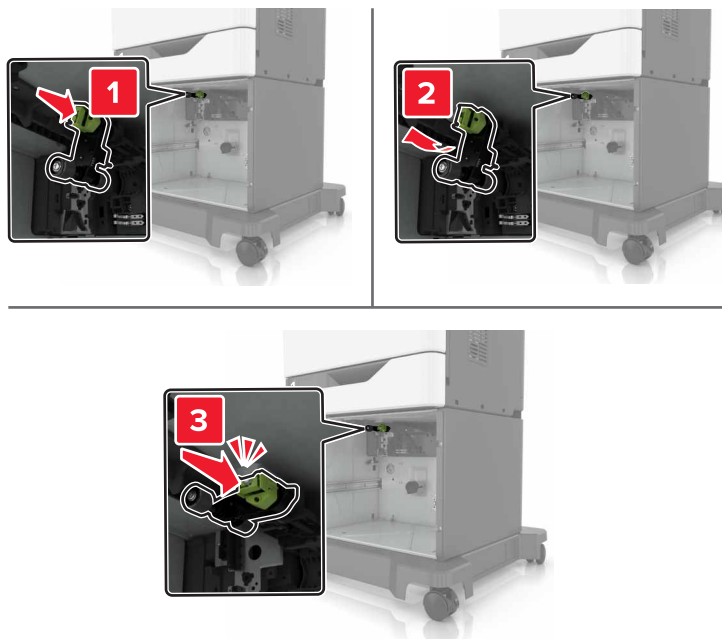

7 Insert the tray.

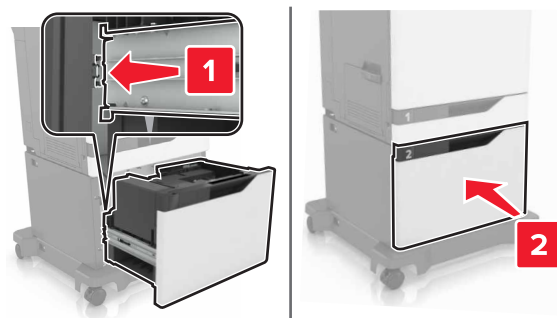

8 Turn on the printer.

Replacing the separator pad

- 1 Pull out the tray.

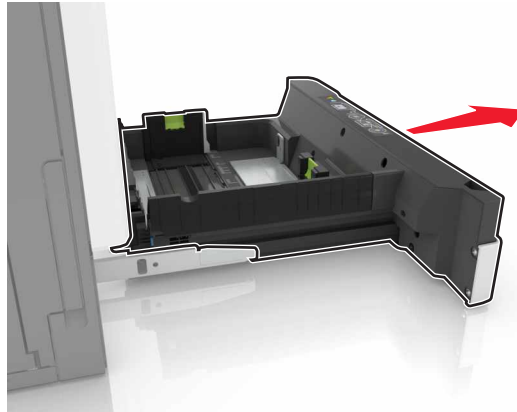

- 2 Remove the separator pad.

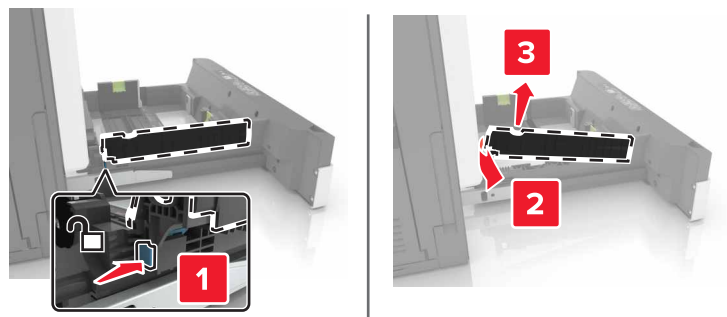

- 3 Unpack the new separator pad.

- 4 Insert the new separator pad until it *clicks* into place.

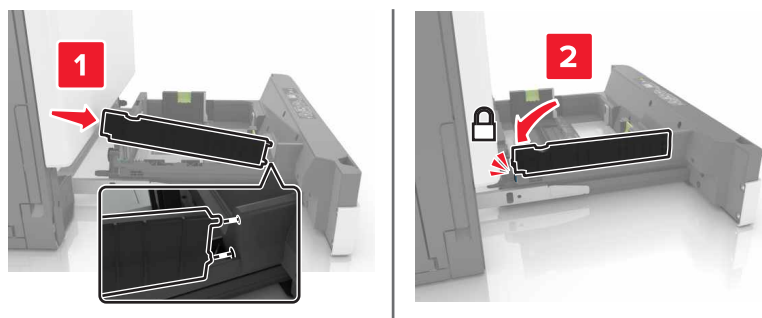

- 5 Insert the tray.

Replacing the waste toner bottle

1 Open door A.

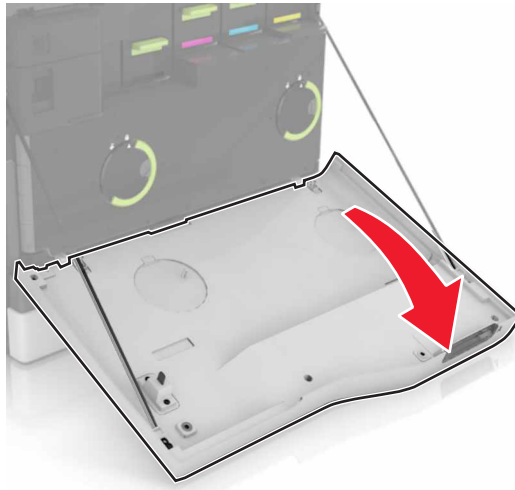

2 Remove the waste toner bottle.

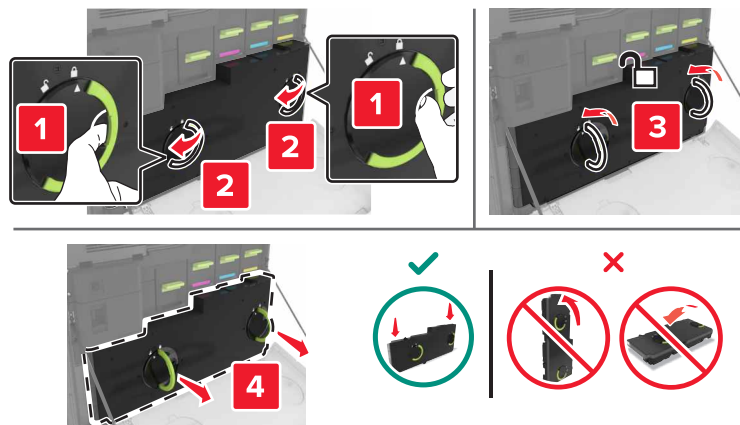

3 Unpack the new waste toner bottle.

4 Insert the new waste toner bottle.

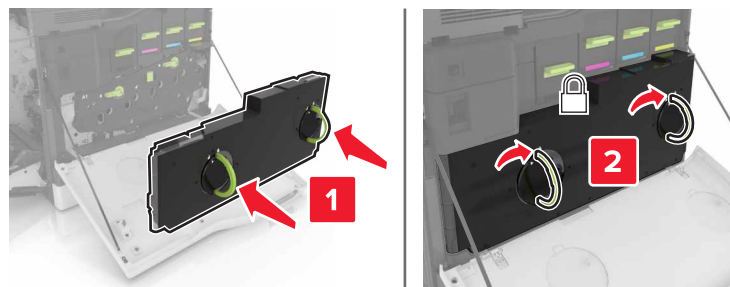

5 Close door A.

Replacing the transfer belt

- 1 Turn off the printer.
- 2 Open door A.

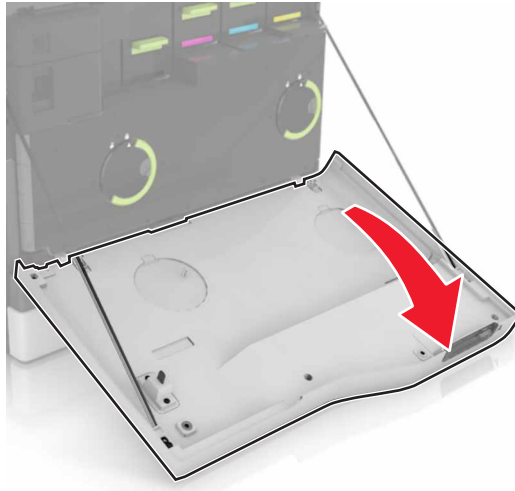

- 3 Remove the waste toner bottle.

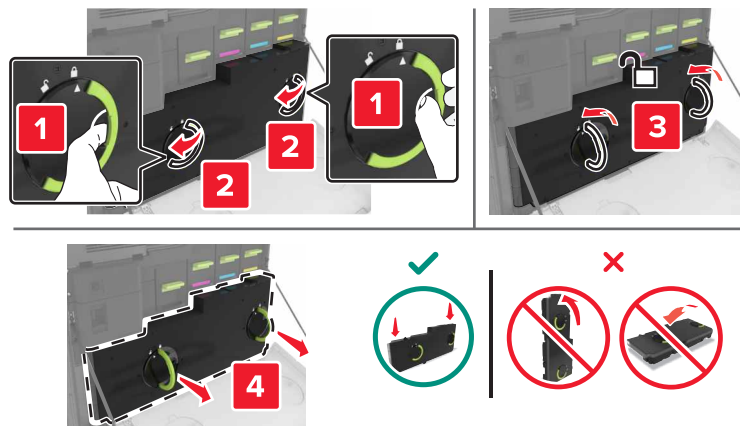

4 Open door A1.

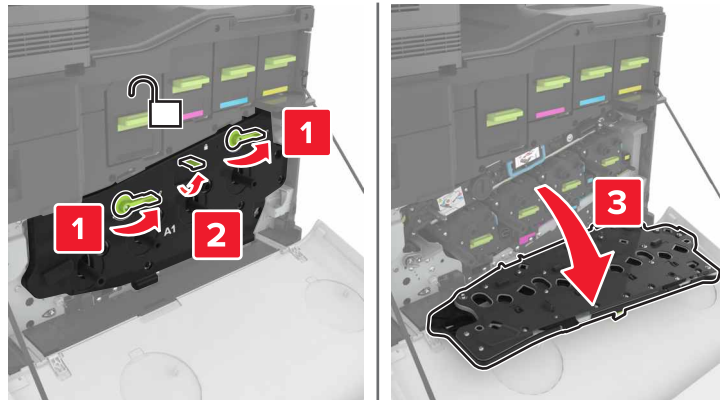

5 Remove the transfer belt.

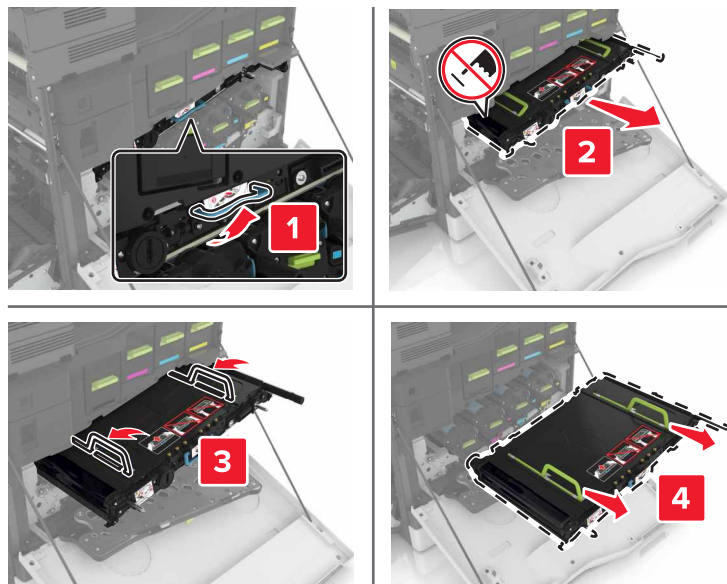

6 Unpack the new transfer belt, and then remove the packing material.

Warning—Potential Damage: Do not expose the transfer belt to direct light for more than 10 minutes. Extended exposure to light may cause print quality problems.

Warning—Potential Damage: Do not touch the transfer belt. Doing so may affect the print quality of future print jobs.



7 Insert the new transfer belt until it *clicks* into place.

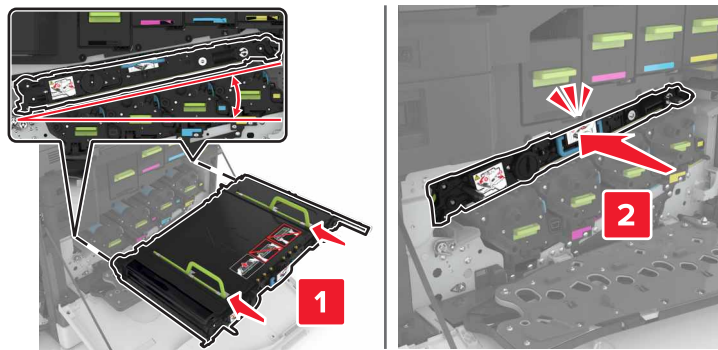

8 Close door A1.

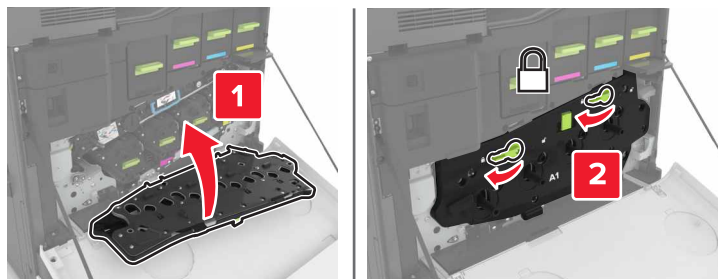

9 Insert the waste toner bottle.

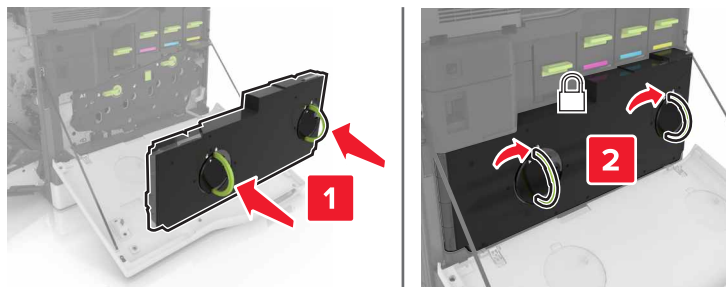

10 Close door A .

11 Turn on the printer.

Replacing the transfer roller

- 1 Open door B.

 **CAUTION—HOT SURFACE:** The inside of the printer might be hot. To reduce the risk of injury from a hot component, allow the surface to cool before touching it.

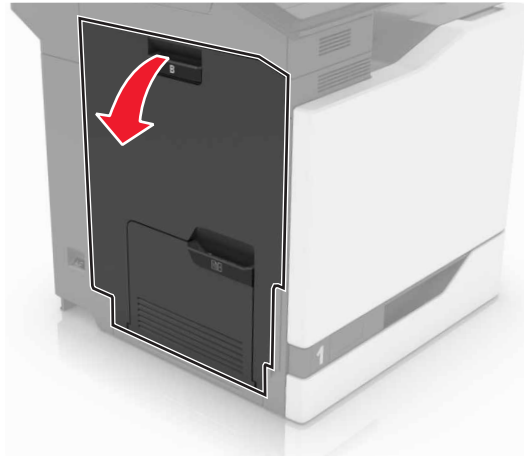

- 2 Remove the transfer roller.

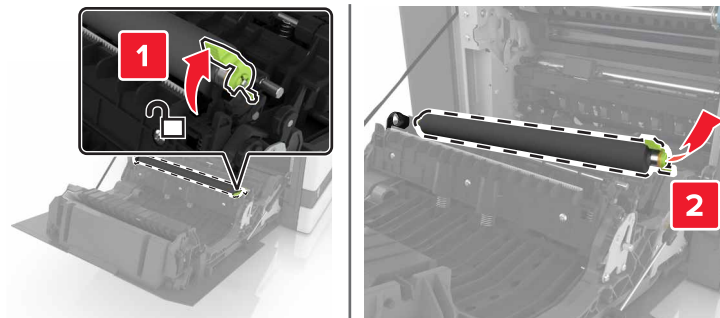

- 3 Unpack the new transfer roller.

Note: Do not remove the white packing material.

4 Insert the new transfer roller.

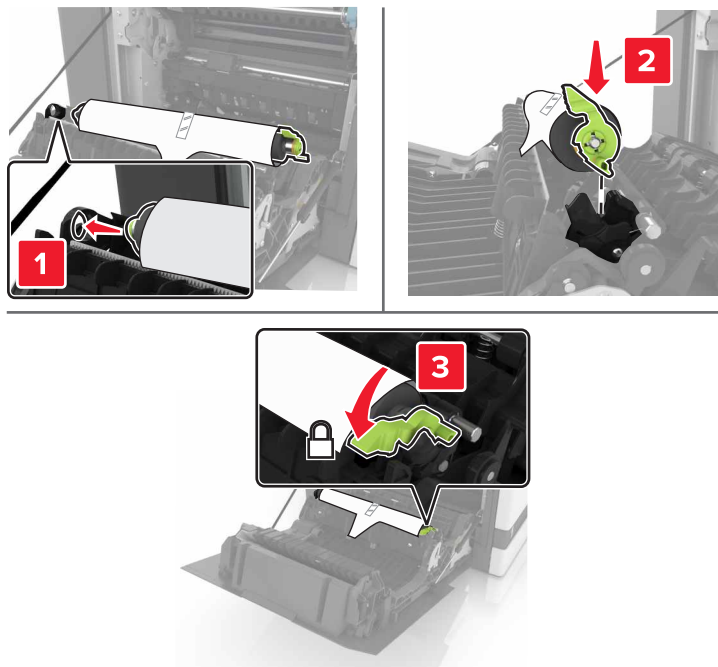

5 Remove the white packing material.



6 Close door B.

Replacing the ADF pick roller

- 1 Turn off the printer.
- 2 Open door D.

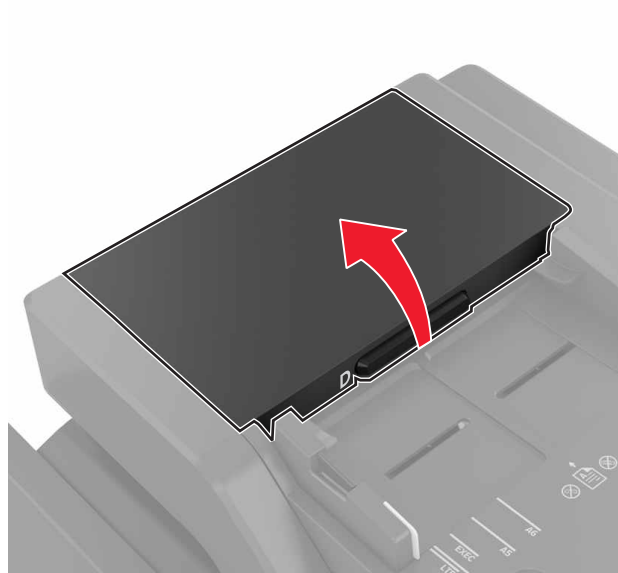

- 3 Remove the ADF pick roller cover.

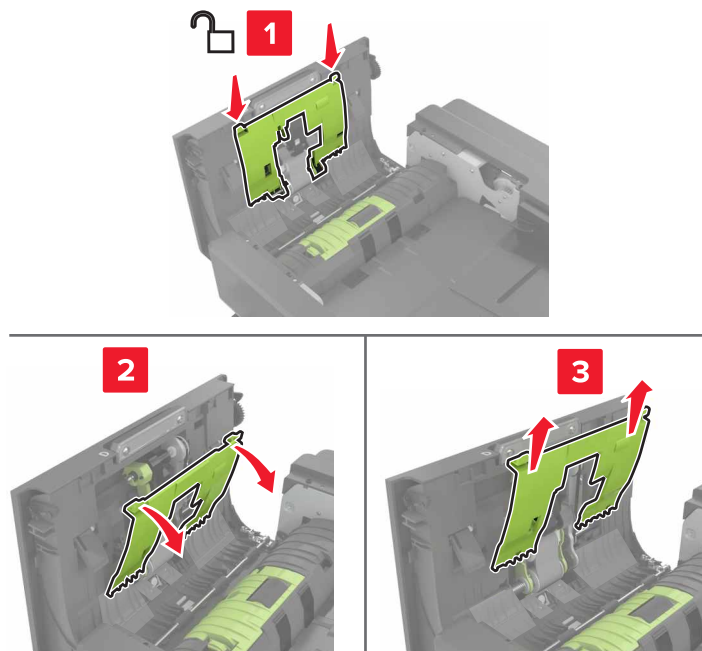

- 4 Remove the ADF pick roller.

Warning—Potential Damage: Some parts of the printer are easily damaged by static electricity. Before touching any parts or components in an area marked with the static-sensitive symbol, touch a metal surface in an area away from the symbol.

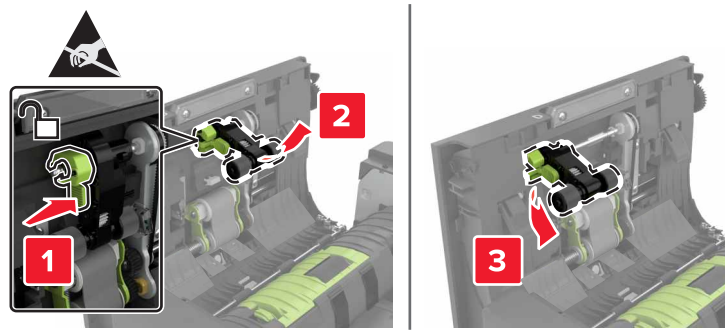

- 5 Unpack the new ADF pick roller.
- 6 Insert the new ADF pick roller until it *clicks* into place.

Warning—Potential Damage: Some parts of the printer are easily damaged by static electricity. Before touching any parts or components in an area marked with the static-sensitive symbol, touch a metal surface in an area away from the symbol.

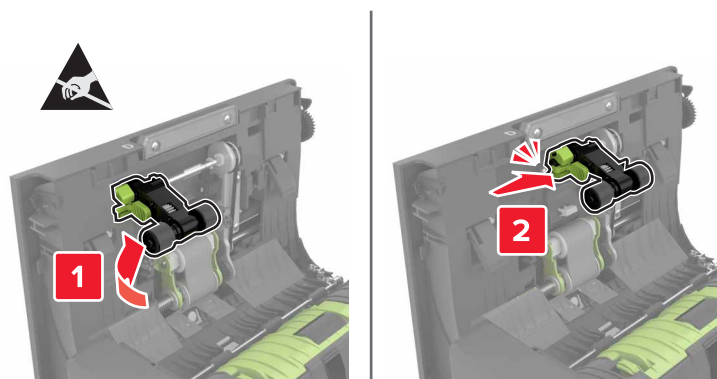

- 7 Insert the ADF pick roller cover until it *clicks* into place.

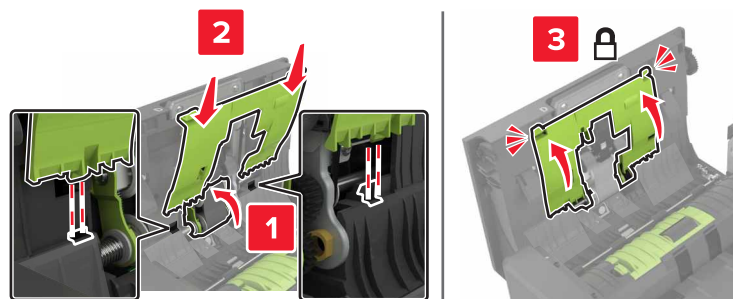

- 8 Close door D.
- 9 Turn on the printer.

Replacing the ADF feed roller

- 1 Turn off the printer.
- 2 Open door D.

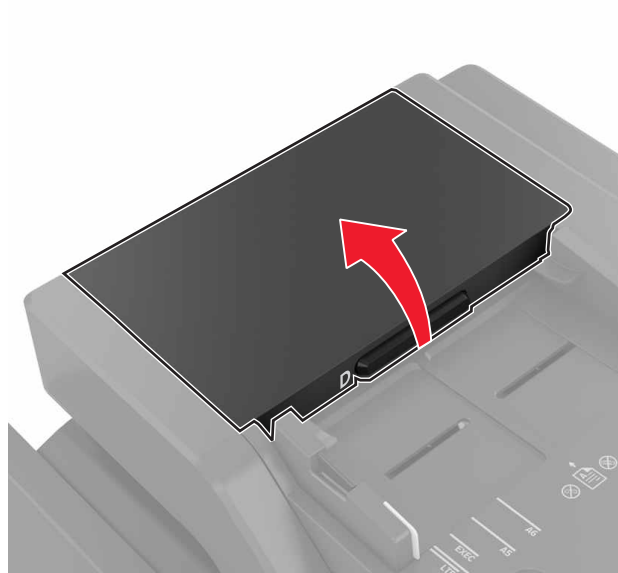

- 3 Remove the ADF pick roller cover.

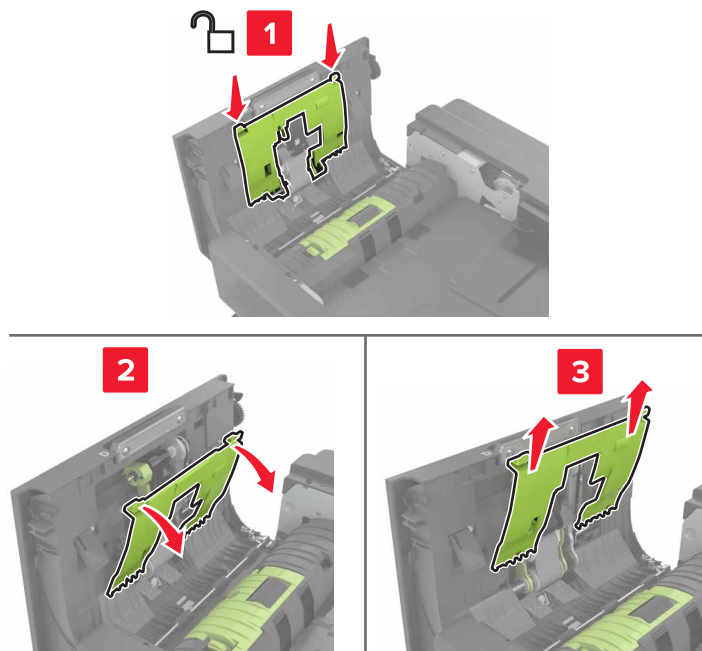

- 4 Remove the ADF feed roller.

Warning—Potential Damage: Some parts of the printer are easily damaged by static electricity. Before touching any parts or components in an area marked with the static-sensitive symbol, touch a metal surface in an area away from the symbol.

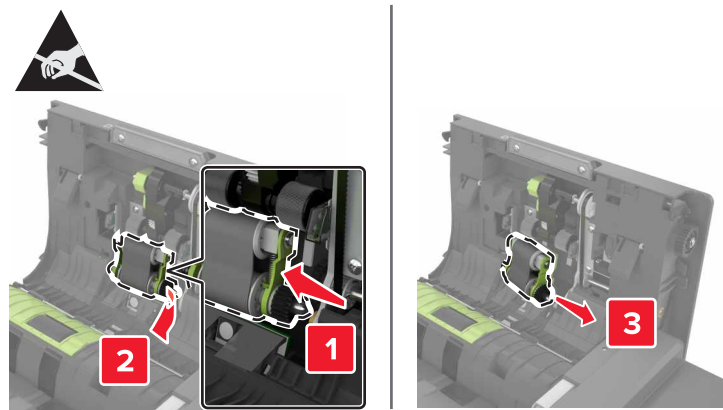

- 5 Unpack the new ADF feed roller.
- 6 Insert the new ADF feed roller until it *clicks* into place.

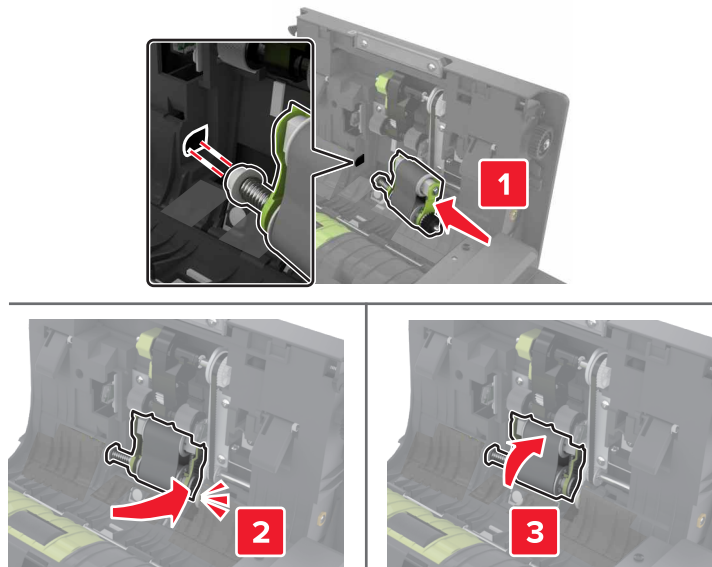

- 7 Insert the ADF pick roller cover until it *clicks* into place.

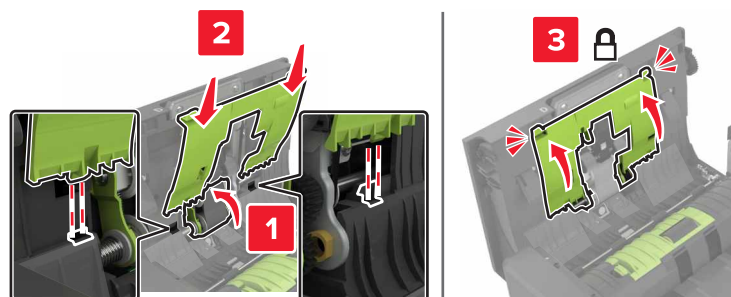

- 8 Close door D.
- 9 Turn on the printer.

Replacing the ADF separator roller

- 1 Turn off the printer.
- 2 Open door D.

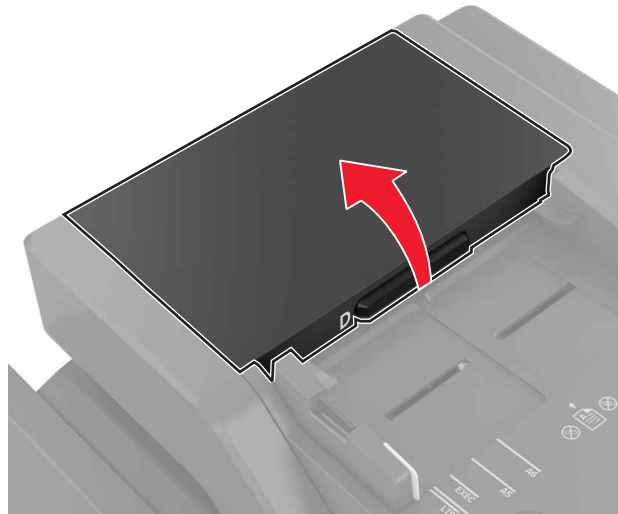

- 3 Remove the ADF separator roller cover.



- 4 Remove the ADF separator roller.

Warning—Potential Damage: Some parts of the printer are easily damaged by static electricity. Before touching any parts or components in an area marked with the static-sensitive symbol, touch a metal surface in an area away from the symbol.

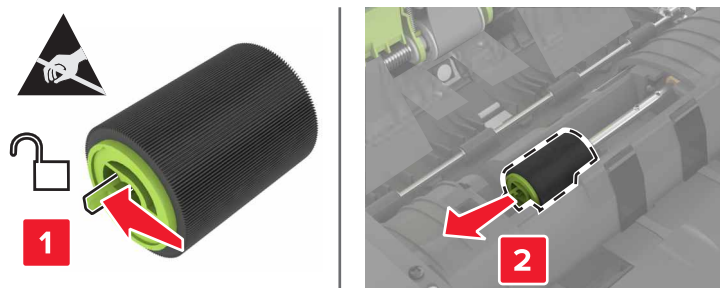

- 5 Unpack the new ADF separator roller.
- 6 Insert the new ADF separator roller until it *clicks* into place.

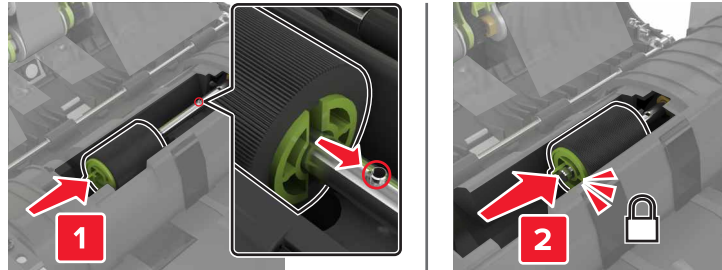

- 7 Insert the ADF separator roller cover until it *clicks* into place.

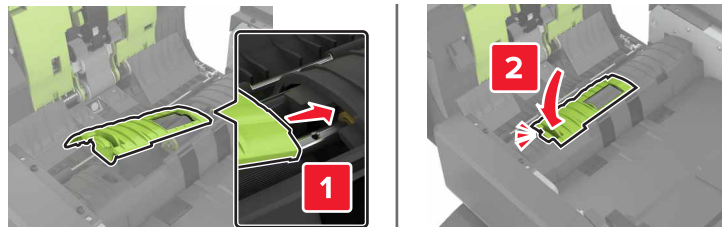

- 8 Close door D.
- 9 Turn on the printer.

Replacing the staple cartridge unit

Replacing the staple cartridge in the staple finisher

- 1 Open door C.

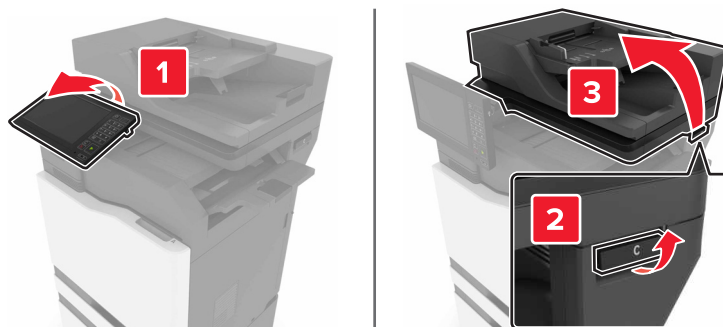

2 Open door G.

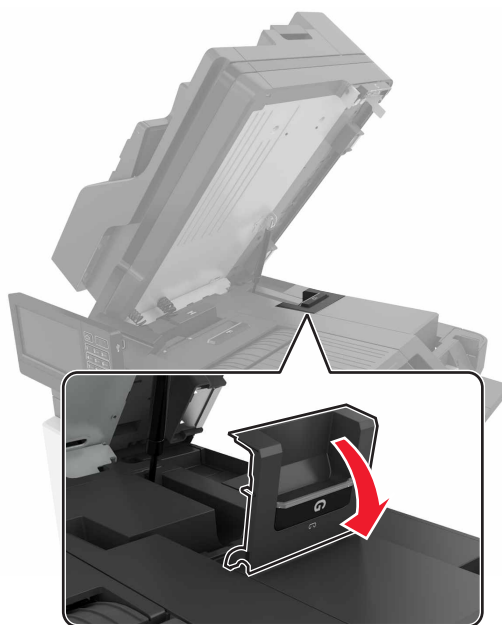

3 Remove the staple cartridge.

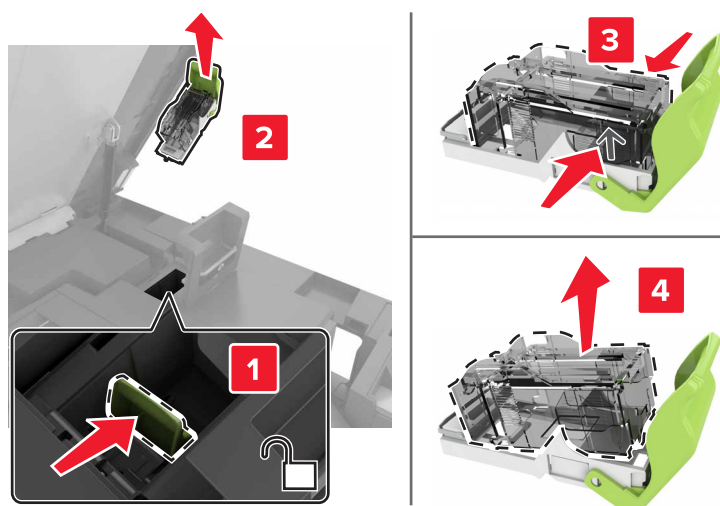

4 Unpack the new staple cartridge.

5 Insert the new staple cartridge until it *clicks* into place.

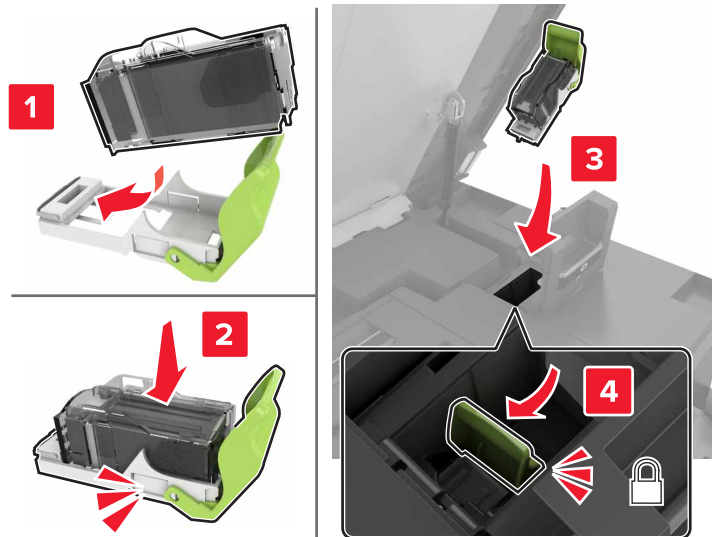

6 Close doors G and C.

CAUTION—PINCH HAZARD: To avoid the risk of a pinch injury, keep hands clear of the labeled area when closing door C.

Replacing the staple cartridge holder in the staple finisher

1 Open door C.

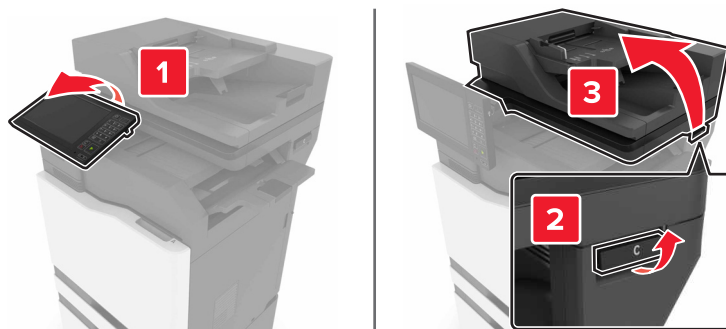

2 Open door G.

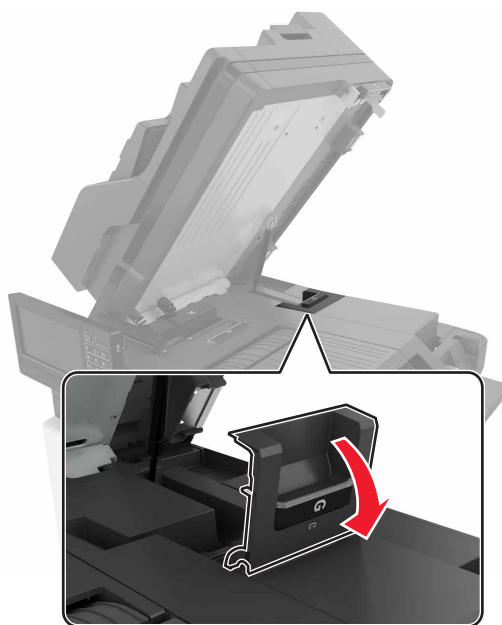

3 Pull out the staple cartridge holder.

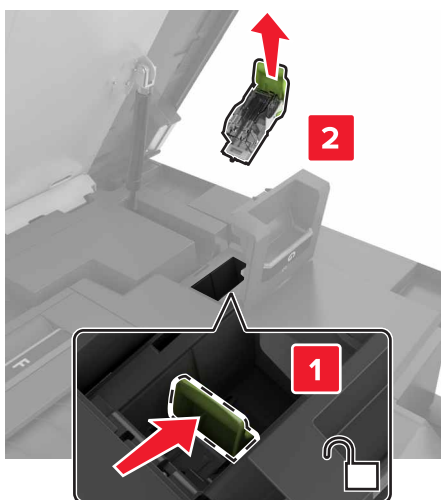

4 Remove the staple cartridge.

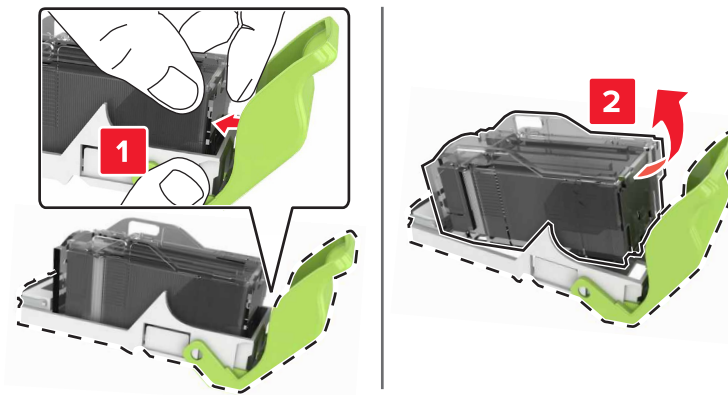

5 Unpack the new staple cartridge holder.

6 Insert the staple cartridge until it *clicks* into place.

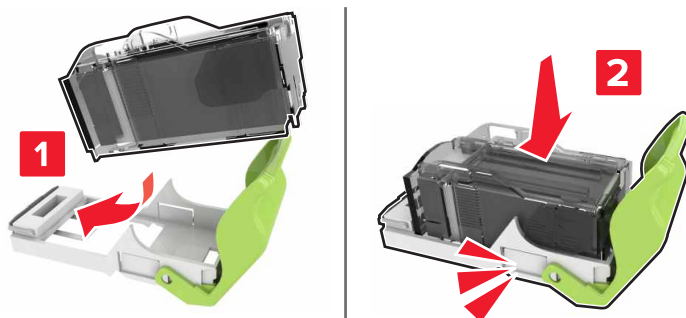

7 Insert the staple cartridge holder until it *clicks* into place.

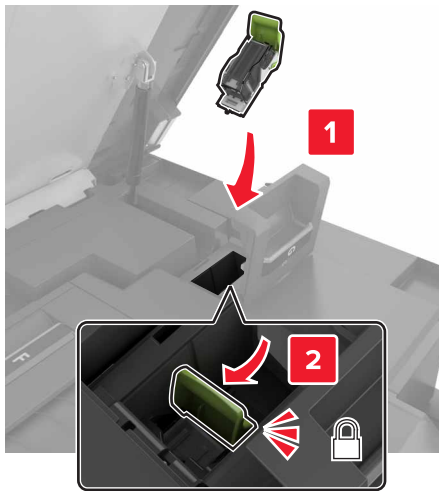

8 Close doors G and C.

 **CAUTION—PINCH HAZARD:** To avoid the risk of a pinch injury, keep hands clear of the labeled area when closing door C.

Storing supplies

Choose a cool, clean storage area for the printer supplies. Store supplies right side up in their original packing until you are ready to use them.

Do not expose supplies to:

- Direct sunlight
- Temperatures above 35°C (95°F)
- High humidity above 80%
- Salty air
- Corrosive gases
- Heavy dust

Moving the printer

Moving the printer to another location

 **CAUTION—POTENTIAL INJURY:** If the printer weight is greater than 18 kg (40 lb), then it requires two or more trained personnel to lift it safely.

 **CAUTION—POTENTIAL INJURY:** To avoid the risk of fire or electrical shock, use only the power cord provided with this product or the manufacturer's authorized replacement.

 **CAUTION—POTENTIAL INJURY:** When moving the printer, follow these guidelines to avoid personal injury or printer damage:

- Make sure that all doors and trays are closed.
- Turn off the printer, and then unplug the power cord from the electrical outlet.
- Disconnect all cords and cables from the printer.
- If the printer has separate floor-standing optional trays or output options attached to it, then disconnect them before moving the printer.
- If the printer has a caster base, then carefully roll it to the new location. Use caution when passing over thresholds and breaks in flooring.
- If the printer does not have a caster base but is configured with optional trays or output options, then remove the output options and lift the printer off the trays. Do not try to lift the printer and any options at the same time.
- Always use the handholds on the printer to lift it.
- Any cart used to move the printer must have a surface able to support the full footprint of the printer.
- Any cart used to move the hardware options must have a surface able to support the dimensions of the options.
- Keep the printer in an upright position.
- Avoid severe jarring movements.
- Make sure that your fingers are not under the printer when you set it down.
- Make sure that there is adequate clearance around the printer.

Note: Damage to the printer caused by improper moving is not covered by the printer warranty.

Shipping the printer

For shipping instructions, go to <http://support.lexmark.com> or contact customer support.

Saving energy and paper

Setting up power saver modes

Eco-Mode

- 1 From the home screen, touch **Settings > Device > Power Management > Eco-Mode**.
- 2 Select a setting.

Sleep mode

- 1 From the home screen, touch **Settings > Device > Power Management > Timeouts > Sleep Mode**.
- 2 Enter the number of minutes the printer stays idle before it enters Sleep mode.

Hibernate mode

- 1 From the home screen, touch **Settings > Device > Power Management > Timeouts > Hibernate Timeout**.
- 2 Select the amount of time before the printer enters hibernate mode.

Notes:

- Make sure to wake the printer from hibernate mode before sending a print job.
- The Embedded Web Server is disabled when the printer is in hibernate mode.

Adjusting the brightness of the printer display

- 1 From the home screen, touch **Settings > Device > Preferences > Screen Brightness**.
- 2 Adjust the setting.

Conserving supplies

- Print on both sides of the paper.
Note: Two-sided printing is the default setting in the print driver.
- Print multiple pages on a single sheet of paper.
- Use the preview feature to see how the document looks like before printing it.
- Print one copy of the document to check its content and format for accuracy.

Recycling

Recycling Lexmark products

To return Lexmark products for recycling:

- 1 Go to www.lexmark.com/recycle.
- 2 Select the product you want to recycle.

Note: Printer supplies and hardware not listed in the Lexmark Collection and Recycling Program may be recycled through your local recycling center.

Recycling Lexmark packaging

Lexmark continually strives to minimize packaging. Less packaging helps to ensure that Lexmark printers are transported in the most efficient and environmentally sensitive manner and that there is less packaging to dispose of. These efficiencies result in fewer greenhouse emissions, energy savings, and natural resource savings. Lexmark also offers recycling of packaging components in some countries or regions. For more information, go to www.lexmark.com/recycle, and then choose your country or region. Information on available packaging recycling programs is included with the information on product recycling.

Lexmark cartons are 100% recyclable where corrugated recycling facilities exist. Facilities may not exist in your area.

The foam used in Lexmark packaging is recyclable where foam recycling facilities exist. Facilities may not exist in your area.

When you return a cartridge to Lexmark, you can reuse the box that the cartridge came in. Lexmark recycles the box.

Returning Lexmark cartridges for reuse or recycling

The Lexmark Cartridge Collection Program allows you to return used cartridges for free to Lexmark for reuse or recycling. One hundred percent of the empty cartridges returned to Lexmark are either reused or demanufactured for recycling. The boxes used to return the cartridges are also recycled.

To return Lexmark cartridges for reuse or recycling, do the following:

- 1 Go to www.lexmark.com/recycle.
- 2 Select the product that you want to recycle.

Clearing jams

Avoiding jams

Load paper properly

- Make sure that the paper lies flat in the tray.

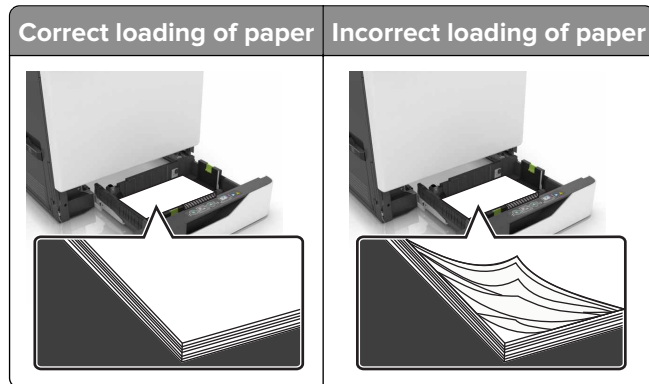

- Do not load or remove a tray while the printer is printing.
- Do not load too much paper. Make sure that the stack height is below the maximum paper fill indicator.
- Do not slide paper into the tray. Load paper as shown in the illustration.

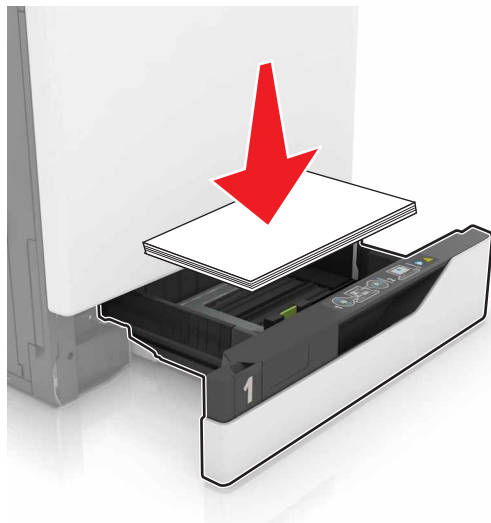

- Make sure that the paper guides are positioned correctly and are not pressing tightly against the paper or envelopes.
- Push the tray firmly into the printer after loading paper.

Use recommended paper

- Use only recommended paper or specialty media.
- Do not load paper that is wrinkled, creased, damp, bent, or curled.

- Flex, fan, and align the paper edges before loading.

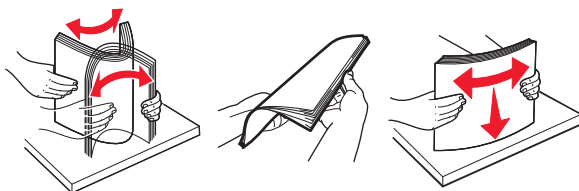

- Do not use paper that has been cut or trimmed by hand.
- Do not mix paper sizes, weights, or types in the same tray.
- Make sure that the paper size and type are set correctly on the computer or printer control panel.
- Store paper according to manufacturer recommendations.

Identifying jam locations

Notes:

- When Jam Assist is set to On, the printer flushes blank pages or pages with partial prints after a jammed page has been cleared. Check your printed output for blank pages.
- When Jam Recovery is set to On or Auto, the printer reprints jammed pages.

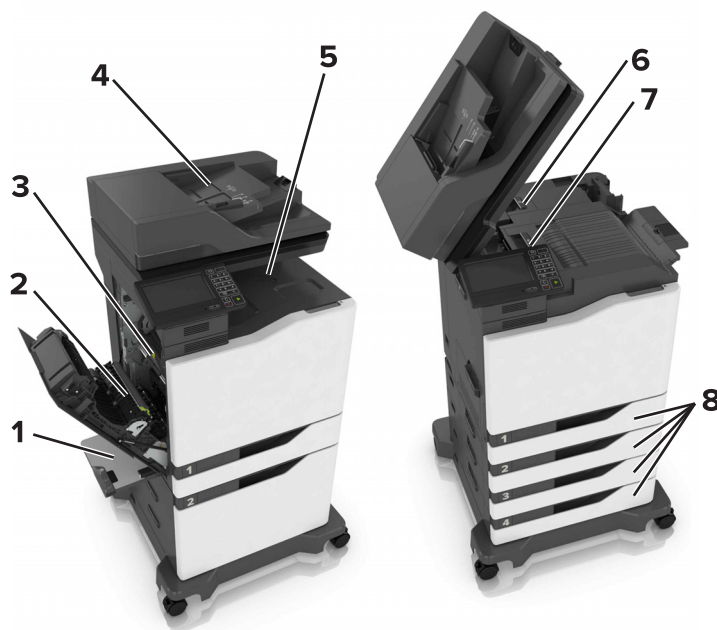

	Jam locations
1	Multipurpose feeder
2	Duplex unit
3	Fuser
4	Automatic document feeder (ADF)

	Jam locations
5	Standard bin
6	Door G
7	Door F
8	Trays

Paper jam in trays

- 1 Pull out the tray.



- 2 Remove the jammed paper.

Note: Make sure that all paper fragments are removed.



- 3 Insert the tray.

- 4 Open the tray cover.



- 5 Remove the jammed paper.

Note: Make sure that all paper fragments are removed.



- 6 Close the tray cover.

Paper jam in the multipurpose feeder

- 1 Remove paper from the multipurpose feeder.
- 2 Remove the jammed paper.

Note: Make sure that all paper fragments are removed.

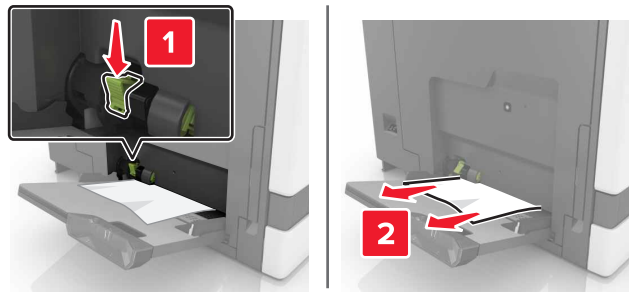

3 Open door B, and then remove any paper fragments.

CAUTION—HOT SURFACE: The inside of the printer might be hot. To reduce the risk of injury from a hot component, allow the surface to cool before touching it.

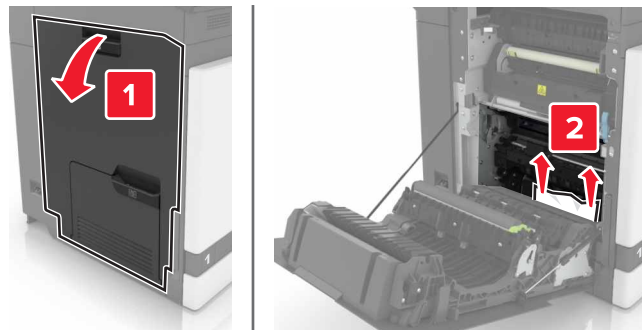

4 Close door B.

5 Flex, fan, and align the paper edges before loading.

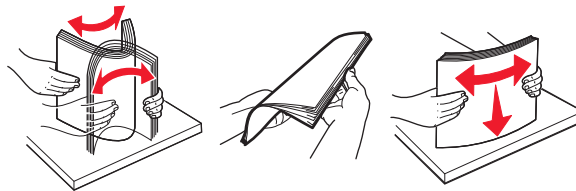

6 Reload paper.

Paper jam in the automatic document feeder

- 1 Remove all original documents from the ADF tray.
- 2 Open door D.

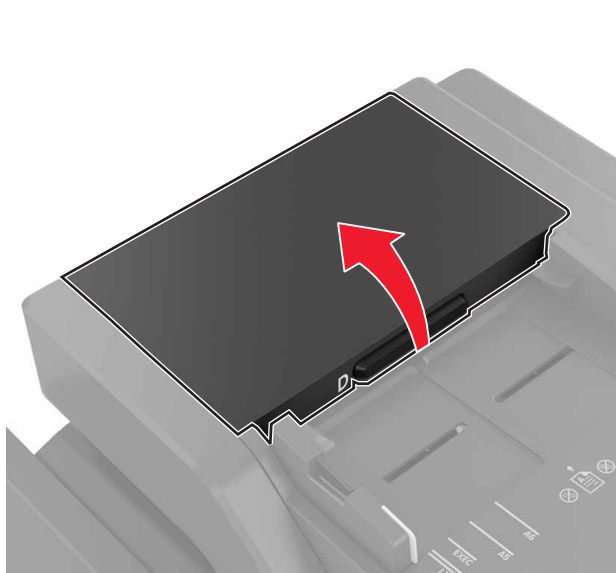

- 3 Remove the jammed paper.

Note: Make sure that all paper fragments are removed.

Warning—Potential Damage: Some parts of the printer are easily damaged by static electricity. Before touching any parts or components in an area marked with the static-sensitive symbol, touch a metal surface in an area away from the symbol.

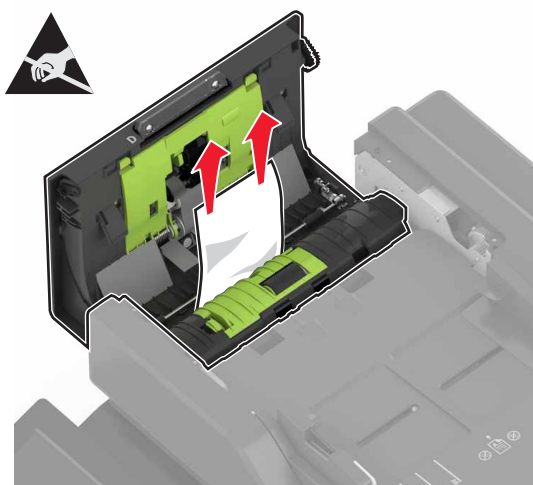

- 4 Close door D.

5 Open the scanner cover.

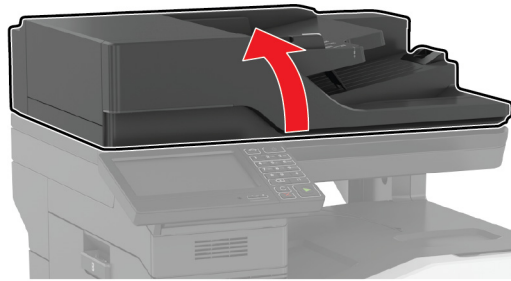

6 Open door E.

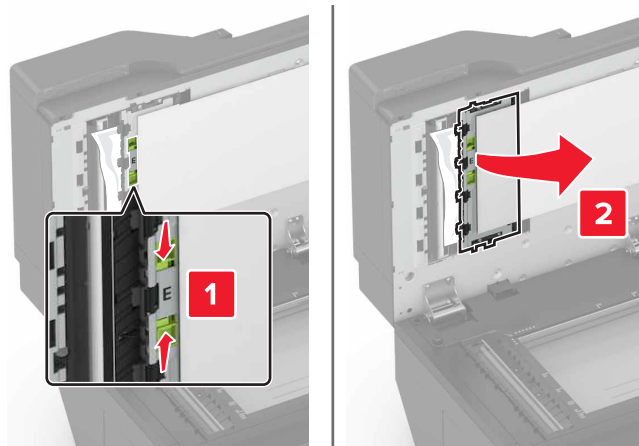

7 Remove the jammed paper.

Note: Make sure that all paper fragments are removed.

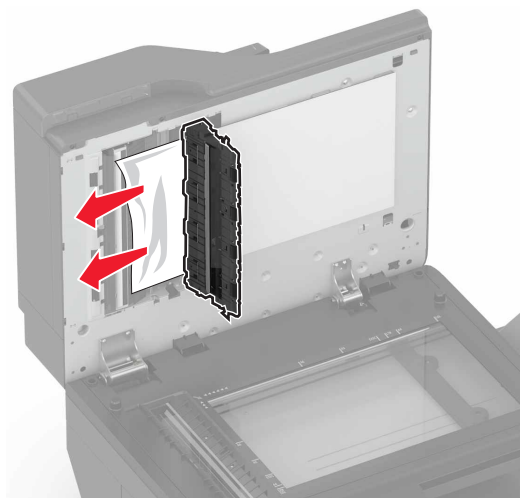

8 Close door E and the scanner cover.

Paper jam in the standard bin

- 1 Remove the jammed paper.

Note: Make sure that all paper fragments are removed.

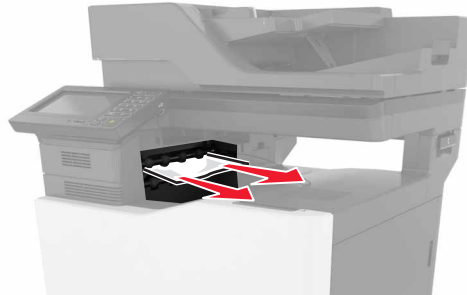

- 2 Open door B, and then remove any paper fragments.

 **CAUTION—HOT SURFACE:** The inside of the printer might be hot. To reduce the risk of injury from a hot component, allow the surface to cool before touching it.

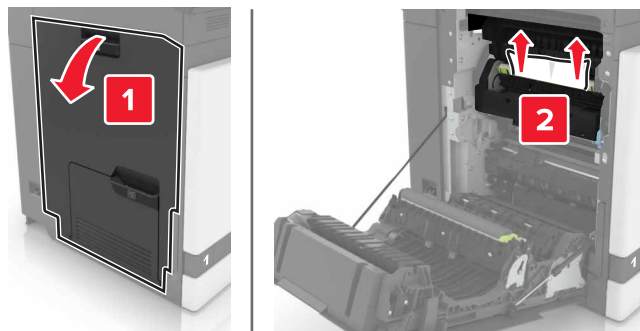

- 3 Close door B.

Paper jam in door B

Paper jam in the fuser

- 1 Open door B.

 **CAUTION—HOT SURFACE:** The inside of the printer might be hot. To reduce the risk of injury from a hot component, allow the surface to cool before touching it.

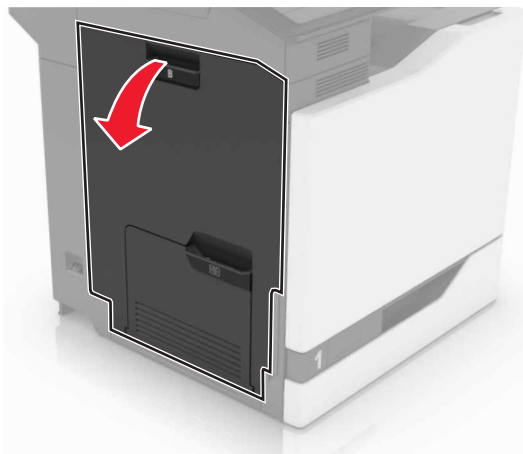

2 Remove the jammed paper.

Note: Make sure that all paper fragments are removed.

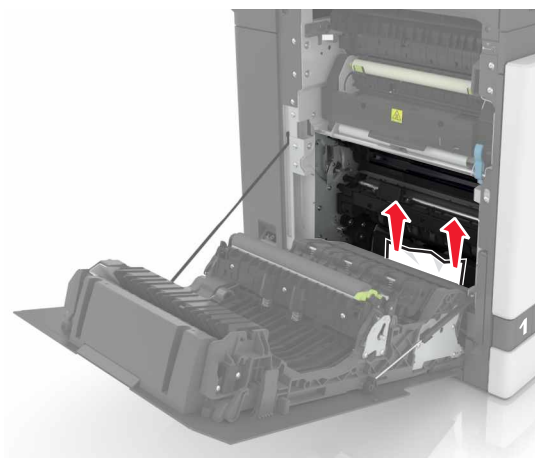

- 3 Open the fuser access door.

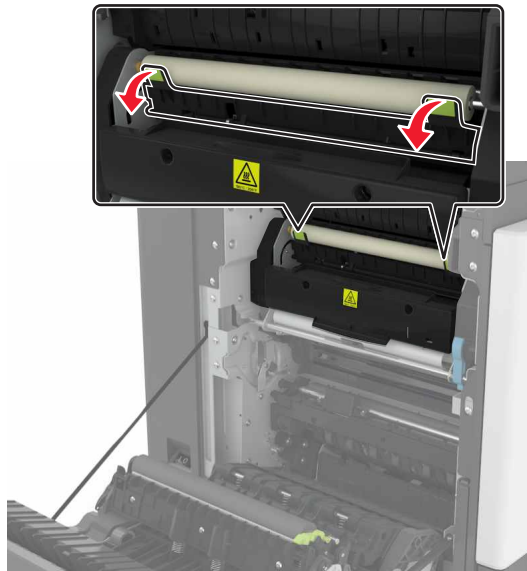

- 4 Remove the jammed paper.

Note: Make sure that all paper fragments are removed.

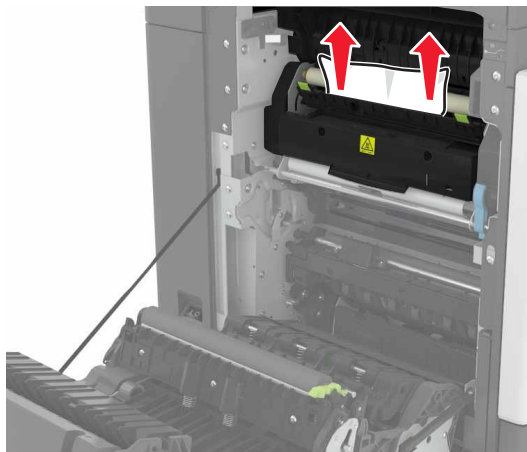

- 5 Close door B.

Paper jam in the duplex unit

- 1 Open door B.

 **CAUTION—HOT SURFACE:** The inside of the printer might be hot. To reduce the risk of injury from a hot component, allow the surface to cool before touching it.

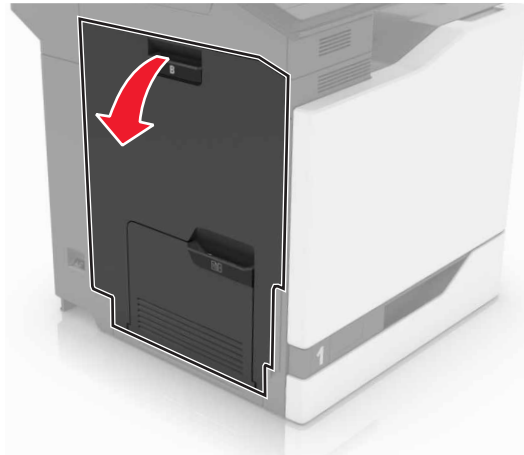

2 Remove the jammed paper.

Note: Make sure that all paper fragments are removed.

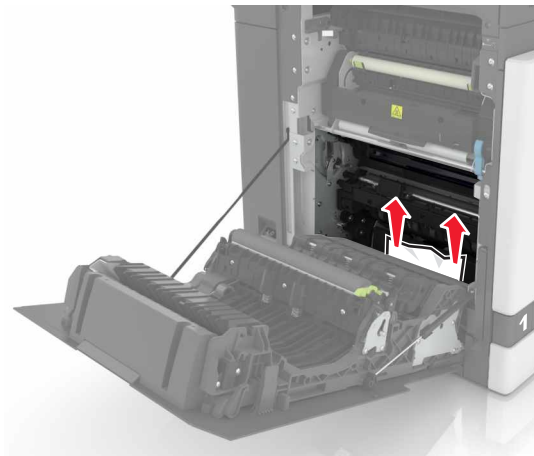

3 Open the duplex cover.

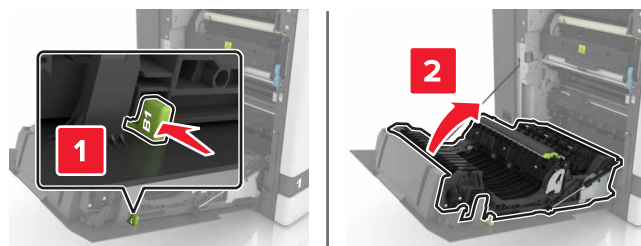

4 Remove the jammed paper.

Note: Make sure that all paper fragments are removed.

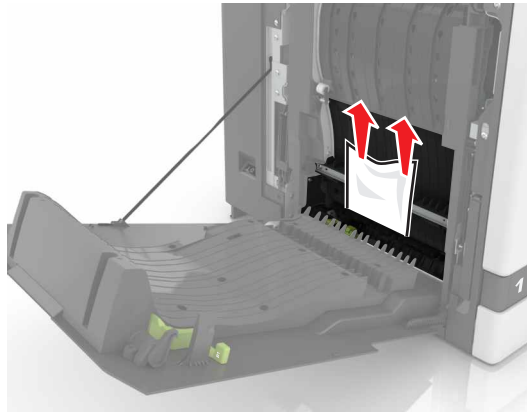

- 5 Close the duplex cover and door B.

Paper jam in the finisher bin

- 1 Remove the jammed paper.

Note: Make sure that all paper fragments are removed.

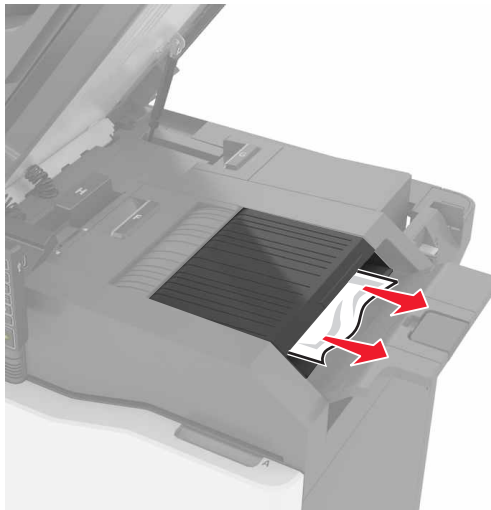

2 Open door C.

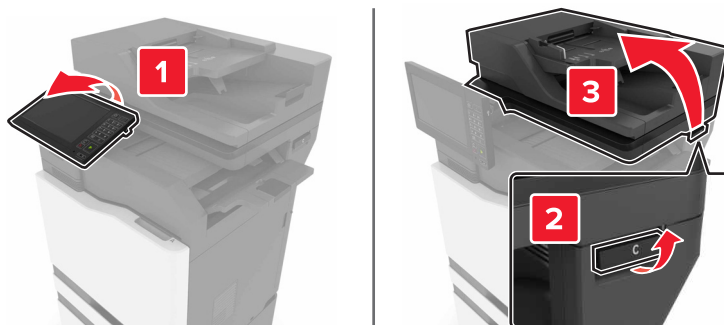

3 Open door F.

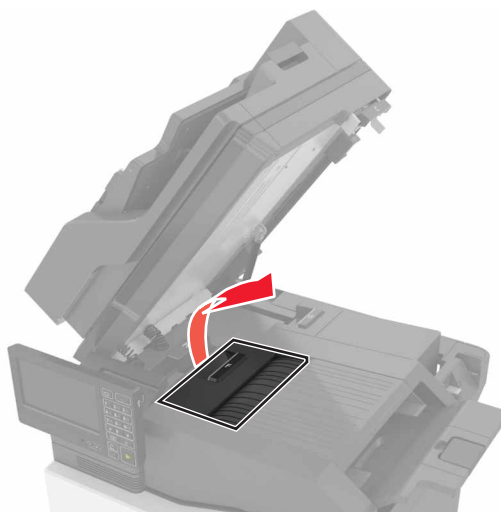

4 Remove the jammed paper.

Note: Make sure that all paper fragments are removed.

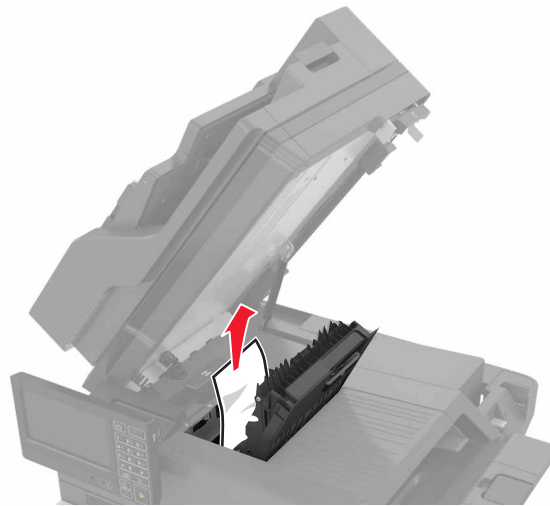

5 Close doors F and C.

 **CAUTION—PINCH HAZARD:** To avoid the risk of a pinch injury, keep hands clear of the labeled area when closing door C.

Staple jam in door G

1 Open door C.

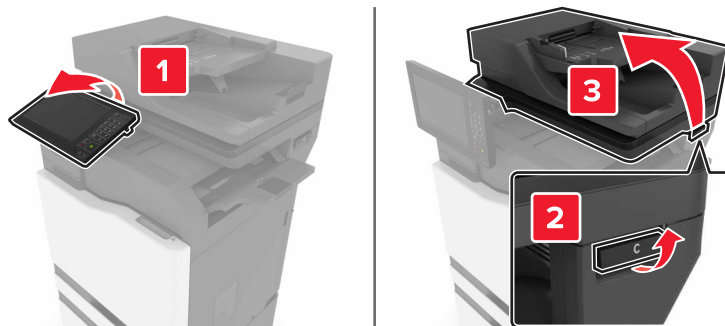

2 Open door G.

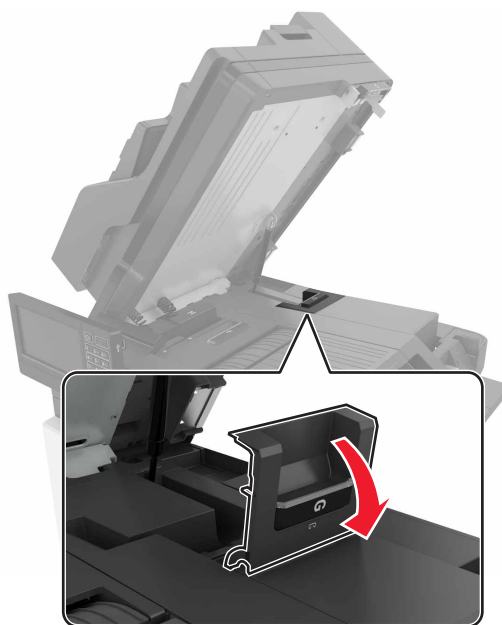

3 Pull out the staple cartridge holder.

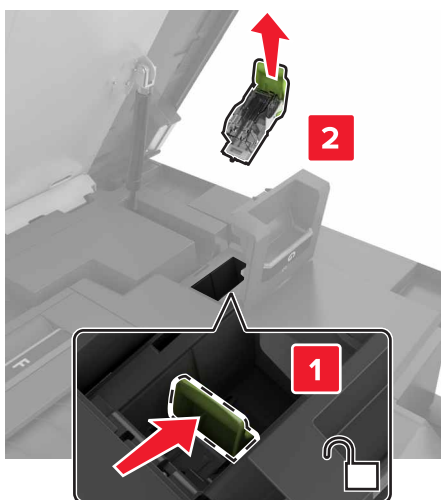

4 Lift the staple guard, and then remove the loose staples.

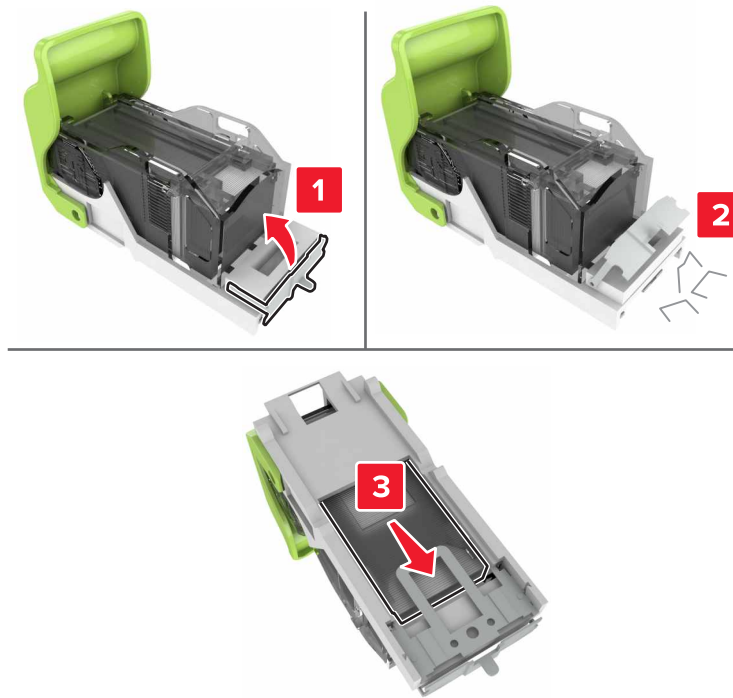

Note: Do not insert the staples that came out of the cartridge.

5 Close the staple guard.



6 Insert the staple cartridge holder.

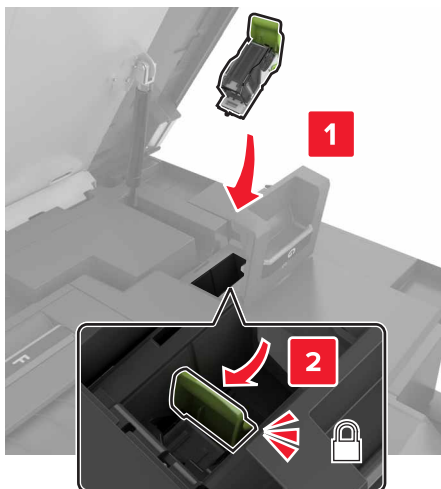

7 Close doors G and C.

 **CAUTION—PINCH HAZARD:** To avoid the risk of a pinch injury, keep hands clear of the labeled area when closing door C.

Troubleshooting

Network connection problems

Cannot open Embedded Web Server

Action	Yes	No
<p>Step 1</p> <p>Check if you are using a supported browser:</p> <ul style="list-style-type: none"> • Internet Explorer® version 9 or later • Safari version 8.0.3 or later • Google Chrome™ • Mozilla Firefox <p>Is your browser supported?</p>	Go to step 2.	Install a supported browser.
<p>Step 2</p> <p>Make sure that the printer IP address is correct.</p> <p>View the printer IP address:</p> <ul style="list-style-type: none"> • From the home screen • From the TCP/IP section in the Network/Ports menu • By printing a network setup page or menu settings page, and then finding the TCP/IP section <p>Note: An IP address appears as four sets of numbers separated by periods, such as 123.123.123.123.</p> <p>Is the printer IP address correct?</p>	Go to step 3.	Type the correct printer IP address in the address field.
<p>Step 3</p> <p>Check if the printer is on.</p> <p>Is the printer on?</p>	Go to step 4.	Turn on the printer.
<p>Step 4</p> <p>Check if the network connection is working.</p> <p>Is the network connection working?</p>	Go to step 5.	Contact your administrator.
<p>Step 5</p> <p>Make sure that the cable connections to the printer and print server are secure.</p> <p>For more information, see the setup documentation that came with the printer.</p> <p>Are the cable connections secure?</p>	Go to step 6.	Secure the cable connections.

Action	Yes	No
<p>Step 6 Check if the web proxy servers are disabled.</p> <p>Are the web proxy servers disabled?</p>	Go to step 7.	Contact your administrator.
<p>Step 7 Access the Embedded Web Server.</p> <p>Did the Embedded Web Server open?</p>	The problem is solved.	Contact customer support .

Unable to read flash drive

Action	Yes	No
<p>Step 1 Check if the flash drive is inserted into the front USB port.</p> <p>Note: The flash drive does not work when it is inserted into the rear USB port.</p> <p>Is the flash drive inserted into the front USB port?</p>	Go to step 2.	The problem is solved.
<p>Step 2 Check if the flash drive is supported. For more information, see “Supported flash drives and file types” on page 31</p> <p>Does the error message still appear?</p>	Go to step 3.	The problem is solved.
<p>Step 3 Check if the front USB port is disabled. For more information, see “Enabling the USB port” on page 124.</p> <p>Does the error message still appear?</p>	Contact customer support .	The problem is solved.

Enabling the USB port

From the home screen, touch **Settings > Network/Ports > USB > Enable USB Port**.

Checking the printer connectivity

- 1 From the home screen, touch **Settings > Reports > Network > Network Setup Page**.
- 2 Check the first section of the network setup page, and confirm that the status is connected.
If the status is not connected, then the LAN drop may be inactive, or the network cable may be unplugged or malfunctioning. Contact your administrator for assistance.

Hardware options problems

Cannot detect internal option

Action	Yes	No
<p>Step 1 Turn off the printer, wait for about 10 seconds, and then turn it back on.</p> <p>Does the internal option operate correctly?</p>	The problem is solved.	Go to step 2.
<p>Step 2 Print a menu settings page, and then check if the internal option appears in the Installed Features list.</p> <p>Is the internal option listed in the menu settings page?</p>	Go to step 4.	Go to step 3.
<p>Step 3 Check if the internal option is properly installed in the controller board.</p> <ul style="list-style-type: none"> a Turn off the printer, and then unplug the power cord from the electrical outlet. b Make sure that the internal option is installed in the appropriate connector in the controller board. c Connect the power cord to the electrical outlet, and then turn on the printer. <p> CAUTION—POTENTIAL INJURY: To avoid the risk of fire or electrical shock, connect the power cord to an appropriately rated and properly grounded electrical outlet that is near the product and easily accessible.</p> <p>Does the internal option operate correctly?</p>	The problem is solved.	Go to step 4.
<p>Step 4 a Check if the internal option is available in the print driver. Note: If necessary, manually add the internal option in the print driver to make it available for print jobs. For more information, see “Adding available options in the print driver” on page 182.</p> <ul style="list-style-type: none"> b Resend the print job. <p>Does the internal option operate correctly?</p>	The problem is solved.	Contact customer support .

Internal solutions port does not operate correctly

Action	Yes	No
<p>Step 1 Print a menu settings page, and then check if the internal solutions port (ISP) appears in the Installed Features list.</p> <p>Is the ISP listed in the Installed Features list?</p>	Go to step 3.	Go to step 2.
<p>Step 2 Remove, and then install the ISP. For more information, see “Installing an internal solutions port” on page 167.</p> <p>Note: Use a supported ISP.</p> <p>Does the ISP operate correctly?</p>	The problem is solved.	Go to step 3.
<p>Step 3 Check the cable and the ISP connection.</p> <ul style="list-style-type: none"> a Use the correct cable, and then make sure that it is securely connected to the ISP. b Check if the ISP solution interface cable is securely connected into the receptacle of the controller board. <p>Does the ISP operate correctly?</p>	The problem is solved.	Contact customer support .

Parallel or serial interface card does not operate correctly

Action	Yes	No
<p>Step 1 Print a menu settings page, and then check if the parallel or serial interface card appears in the Installed Features list.</p> <p>Is the parallel or serial interface card listed in the Installed Features list?</p>	Go to step 3.	Go to step 2.
<p>Step 2 Remove, and then install the parallel or serial interface card. For more information, see “Installing an internal solutions port” on page 167.</p> <p>Does the parallel or serial interface card operate correctly?</p>	The problem is solved.	Go to step 3.
<p>Step 3 Check the connection between the cable and the parallel or serial interface card.</p> <p>Does the parallel or serial interface card operate correctly?</p>	The problem is solved.	Contact customer support .

Defective flash detected

Try one or more of the following:

- Replace the defective flash memory.
- From the printer control panel, select **Continue** to ignore the message and continue printing.
- Cancel the current print job.

Not enough free space in flash memory for resources

Try one or more of the following:

- From the printer control panel, select **Continue** to clear the message and continue printing.
- Delete fonts, macros, and other data stored in the flash memory.
- Install flash memory with larger capacity.

Note: Downloaded fonts and macros that are not previously stored in the flash memory are deleted.

Unformatted flash detected

Try one or more of the following:

- From the control panel, select **Continue** to stop the defragmentation and continue printing.
- Format the flash memory.

Note: If the error message remains, then the flash memory may be defective and needs to be replaced.

Issues with supplies

Replace cartridge, printer region mismatch

To correct this problem, purchase a cartridge with the correct region that matches the printer region, or purchase a worldwide cartridge.

- The first number in the message after 42 indicates the region of the printer.
- The second number in the message after 42 indicates the region of the cartridge.

Printer and toner cartridge regions

Region	Numeric code
Worldwide or Undefined region	0
North America (United States, Canada)	1
European Economic Area, Western Europe, Nordic countries, Switzerland	2
Asia Pacific	3
Latin America	4
Rest of Europe, Middle East, Africa	5
Australia, New Zealand	6

Region	Numeric code
Invalid region	9

Note: To find the region settings of the printer and toner cartridge, print the print quality test pages. From the control panel, navigate to: **Settings > Troubleshooting > Print Quality Test Pages.**

Non-Lexmark supply

The printer has detected a non-Lexmark supply or part installed in the printer.

Your Lexmark printer is designed to function best with genuine Lexmark supplies and parts. Use of third-party supplies or parts may affect the performance, reliability, or life of the printer and its imaging components.

All life indicators are designed to function with Lexmark supplies and parts and may deliver unpredictable results if third-party supplies or parts are used. Imaging component usage beyond the intended life may damage your Lexmark printer or associated components.

Warning—Potential Damage: Use of third-party supplies or parts can affect warranty coverage. Damage caused by the use of third-party supplies or parts may not be covered by the warranty.

To accept any and all of these risks and to proceed with the use of non-genuine supplies or parts in your printer, from the control panel, press and hold **X** and **#** simultaneously for 15 seconds.

If you do not want to accept these risks, then remove the third-party supply or part from your printer and install a genuine Lexmark supply or part. For more information, see [“Using genuine Lexmark parts and supplies” on page 67.](#)

If the printer does not print after pressing and holding **X** and **#** simultaneously for 15 seconds, then reset the supply usage counter.

- 1 From the control panel, navigate to:
Settings > Device > Maintenance > Configuration Menu > Supply Usage And Counters
- 2 Select the part or supply that you want to reset, and then select **Start**.
- 3 Read the warning message, and then select **Continue**.
- 4 Press and hold **X** and **#** simultaneously for 15 seconds to clear the message.

Note: If you are unable to reset the supply usage counters, then return the item to the place of purchase.

Scanner maintenance required, use ADF Kit

The printer is scheduled for maintenance. For more information, go to <http://support.lexmark.com> or contact your service representative, and then report the message.

Paper feed problems

Envelope seals when printing

Action	Yes	No
<p>1 Use envelopes that have been stored in a dry environment.</p> <p>Note: Printing on envelopes with high moisture content can seal the flaps.</p> <p>2 Resend the print job.</p> <p>Does the envelope seal when printing?</p>	<p>Contact customer support.</p>	<p>The problem is solved.</p>

Collated printing does not work

Action	Yes	No
<p>Step 1</p> <p>a From the home screen, touch Settings > Print > Layout > Collate.</p> <p>b Set Collate to On.</p> <p>c Print the document.</p> <p>Are the pages collated correctly?</p>	<p>The problem is solved.</p>	<p>Go to step 2.</p>
<p>Step 2</p> <p>a From the document that you are trying to print, open the Print dialog, and then select Collate.</p> <p>b Print the document.</p> <p>Are the pages collated correctly?</p>	<p>The problem is solved.</p>	<p>Go to step 3.</p>
<p>Step 3</p> <p>a Reduce the number of pages to print.</p> <p>b Print the document.</p> <p>Are the pages collated correctly?</p>	<p>The problem is solved.</p>	<p>Contact customer support.</p>

Paper curl

Action	Yes	No
<p>Step 1 Move the paper guides in the tray to the correct position for the paper loaded.</p> <p>Is the paper still curled?</p>	Go to step 2.	The problem is solved.
<p>Step 2 a Depending on your operating system, specify the paper type and weight from the Printing Preferences or Print dialog.</p> <p>Notes:</p> <ul style="list-style-type: none"> • Make sure that the settings match the paper loaded in the tray. • You can also change the settings on the printer control panel. <p>b Resend the print job.</p> <p>Is the paper still curled?</p>	Go to step 3.	The problem is solved.
<p>Step 3 a Remove paper from the tray, and then turn it over. b Resend the print job.</p> <p>Is the paper still curled?</p>	Go to step 4.	The problem is solved.
<p>Step 4 a Load paper from a fresh package. Note: Paper absorbs moisture due to high humidity. Store paper in its original wrapper until you are ready to use it. b Resend the print job.</p> <p>Is the paper still curled?</p>	Contact customer support .	The problem is solved.

Tray linking does not work

Action	Yes	No
<p>Step 1 a Check if the trays contain paper of the same size and type. b Check if the paper guides are positioned correctly. c Print the document.</p> <p>Do the trays link correctly?</p>	The problem is solved.	Go to step 2.

Action	Yes	No
<p>Step 2</p> <p>a From the home screen, touch Settings > Paper > Tray Configuration > Paper Size/Type.</p> <p>b Set the paper size and type to match the paper loaded in the linked trays.</p> <p>c Print the document.</p> <p>Do the trays link correctly?</p>	<p>The problem is solved.</p>	<p>Contact customer support.</p>

Check tray connection

Try one or more of the following:

- Turn off the printer, wait for about 10 seconds, and then turn it back on.

If the error occurs a second time, then:

- 1 Turn off the printer.
- 2 Unplug the power cord from the electrical outlet.
- 3 Remove the indicated tray.
- 4 Insert the tray.
- 5 Connect the power cord to the electrical outlet.



CAUTION—POTENTIAL INJURY: To avoid the risk of fire or electrical shock, connect the power cord to an appropriately rated and properly grounded electrical outlet that is near the product and easily accessible.

- 6 Turn on the printer.

If the error occurs again, then:

- 1 Turn off the printer.
 - 2 Unplug the power cord from the electrical outlet.
 - 3 Remove the indicated tray.
 - 4 Contact customer support.
- From the control panel, select **Continue** to clear the message and resume printing.

Paper frequently jams

Action	Yes	No
<p>Step 1</p> <p>a Pull out the tray.</p> <p>b Check if the paper is loaded correctly.</p> <p>Notes:</p> <ul style="list-style-type: none"> • Make sure that the paper guides are positioned correctly. • Make sure that the stack height is below the maximum paper fill indicator. • Make sure to print on recommended paper size and type. <p>c Insert the tray.</p> <p>d Print the document.</p> <p>Do paper jams still occur frequently?</p>	Go to step 2.	The problem is solved.
<p>Step 2</p> <p>a From the Paper menu on the control panel, check if the printer is detecting the correct paper size.</p> <p>b Resend the print job.</p> <p>Do paper jams still occur frequently?</p>	Go to step 3.	The problem is solved.
<p>Step 3</p> <p>a Load paper from a fresh package.</p> <p>b Print the document.</p> <p>Do paper jams still occur frequently?</p>	Contact customer support .	The problem is solved.

Jammed pages are not reprinted

Action	Yes	No
<p>a From the home screen, touch Settings > Device > Notifications > Jam Content Recovery.</p> <p>b Select On or Auto.</p> <p>c Apply the changes.</p> <p>Are the jammed pages reprinted?</p>	The problem is solved.	Contact customer support .

Printing problems

Confidential and other held documents do not print

Action	Yes	No
<p>Step 1</p> <p>a From the control panel, check if the documents appear in the Held Jobs list.</p> <p>Note: If the documents are not listed, then print the documents using the Print and Hold options.</p> <p>b Print the documents.</p> <p>Are the documents printed?</p>	The problem is solved.	Go to step 2.
<p>Step 2</p> <p>The print job may contain a formatting error or invalid data.</p> <ul style="list-style-type: none"> • Delete the print job, and then send it again. • For PDF files, generate a new file, and then print the documents. <p>Are the documents printed?</p>	The problem is solved.	Go to step 3.
<p>Step 3</p> <p>If you are printing from the Internet, then the printer may be reading the multiple job titles as duplicates.</p> <p>For Windows users</p> <p>a Open the Printing Preferences dialog.</p> <p>b From the Print and Hold section, select Keep duplicate documents.</p> <p>c Enter a PIN.</p> <p>d Resend the print job.</p> <p>For Macintosh users</p> <p>a Save and name each job differently.</p> <p>b Send the job individually.</p> <p>Are the documents printed?</p>	The problem is solved.	Go to step 4.
<p>Step 4</p> <p>a Delete some held jobs to free up printer memory.</p> <p>b Resend the print job.</p> <p>Are the documents printed?</p>	The problem is solved.	Go to step 5.

Action	Yes	No
<p>Step 5</p> <p>a Add printer memory.</p> <p>b Resend the print job.</p> <p>Are the documents printed?</p>	The problem is solved.	Contact customer support .

Slow printing

Action	Yes	No
<p>Step 1</p> <p>a Make sure that the printer is not in Eco-Mode and Quiet Mode.</p> <p>b Print the document.</p> <p>Is the printer printing slow?</p>	Go to step 2.	The problem is solved.
<p>Step 2</p> <p>a Depending on your operating system, specify the paper type from the Printing Preferences or Print dialog.</p> <p>Notes:</p> <ul style="list-style-type: none"> • Make sure that the setting matches the paper loaded in the tray. • You can also change the setting on the printer control panel. <p>b Print the document.</p> <p>Is the printer printing slow?</p>	Go to step 3.	The problem is solved.
<p>Step 3</p> <p>a Reduce the number of pages to print.</p> <p>b Print the document.</p> <p>Is the printer printing slow?</p>	Go to step 4.	The problem is solved.
<p>Step 4</p> <p>a Remove held jobs.</p> <p>b Print the document.</p> <p>Is the printer printing slow?</p>	Go to step 5.	The problem is solved.
<p>Step 5</p> <p>a Connect the printer cable securely to the printer and the computer, print server, option, or other network device.</p> <p>b Print the document.</p> <p>Is the printer printing slow?</p>	Go to step 6.	The problem is solved.

Action	Yes	No
<p>Step 6</p> <p>a From the Quality menu on the control panel, set the Print Resolution to 4800CQ.</p> <p>b Print the document.</p> <p>Is the printer printing slow?</p>	Go to step 7.	The problem is solved.
<p>Step 7</p> <p>a Make sure that the printer is not overheating.</p> <p>Notes:</p> <ul style="list-style-type: none"> • Allow the printer to cool down after a long print job. • Observe the recommended ambient temperature for the printer. For more information, see “Selecting a location for the printer” on page 10. <p>b Print the document.</p> <p>Is the printer printing slow?</p>	Go to step 8.	The problem is solved.
<p>Step 8</p> <p>a Add more printer memory.</p> <p>b Print the document.</p> <p>Is the printer printing slow?</p>	Contact customer support .	The problem is solved.

Print jobs do not print

Action	Yes	No
<p>Step 1</p> <p>a From the document you are trying to print, open the Print dialog, and then check if you have selected the correct printer.</p> <p>b Resend the print job.</p> <p>Is the document printed?</p>	The problem is solved.	Go to step 2.
<p>Step 2</p> <p>a Check if the printer is on.</p> <p>b Resolve any error messages that appear on the display.</p> <p>c Resend the print job.</p> <p>Is the document printed?</p>	The problem is solved.	Go to step 3.

Action	Yes	No
<p>Step 3</p> <p>a Check if the ports are working and if the cables are securely connected to the computer and the printer. For more information, see the setup documentation that came with the printer.</p> <p>b Resend the print job.</p> <p>Is the document printed?</p>	The problem is solved.	Go to step 4.
<p>Step 4</p> <p>a Turn off the printer, wait for about 10 seconds, and then turn it back on.</p> <p>b Resend the print job.</p> <p>Is the document printed?</p>	The problem is solved.	Go to step 5.
<p>Step 5</p> <p>a Remove, and then reinstall the printer software. Note: The printer software is available at http://support.lexmark.com.</p> <p>b Resend the print job.</p> <p>Is the document printed?</p>	The problem is solved.	Contact customer support .

Print quality is poor

Blank or white pages



Note: Before solving the problem, print the quality sample pages to determine the missing color. From the home screen, touch **Settings > Troubleshooting > Basic Print Quality Pages**.

Action	Yes	No
<p>Step 1</p> <p>a Remove, and then reinstall the imaging unit or imaging kit.</p> <p>Warning—Potential Damage: Do not expose the imaging unit or imaging kit to direct light for more than 10 minutes. Extended exposure to light may cause print quality problems.</p> <p>Warning—Potential Damage: To avoid damage, do not touch the underside of the imaging unit or imaging kit.</p> <p>b Print a document.</p> <p>Is the printer still printing blank or white pages?</p>	Go to step 2.	The problem is solved.
<p>Step 2</p> <p>a Replace the imaging unit or imaging kit.</p> <p>Warning—Potential Damage: Do not expose the imaging unit or imaging kit to direct light for more than 10 minutes. Extended exposure to light may cause print quality problems.</p> <p>Warning—Potential Damage: To avoid damage, do not touch the underside of the imaging unit or imaging kit.</p> <p>b Print a document.</p> <p>Is the printer still printing blank or white pages?</p>	Contact customer support .	The problem is solved.

Dark print

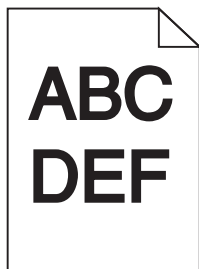

Action	Yes	No
<p>Step 1</p> <p>a From the Quality menu on the control panel, select Color Adjust.</p> <p>b Resend the print job.</p> <p>Is the print still too dark?</p>	Go to step 2.	The problem is solved.

Action	Yes	No
<p>Step 2</p> <p>a Depending on your operating system, reduce the toner darkness from the Printing Preferences or Print dialog.</p> <p>Note: You can also change the settings on the printer control panel.</p> <p>b Resend the print job.</p> <p>Is the print still too dark?</p>	Go to step 3.	The problem is solved.
<p>Step 3</p> <p>a Depending on your operating system, specify the paper type, texture, and weight from the Printing Preferences or Print dialog.</p> <p>Notes:</p> <ul style="list-style-type: none"> • Make sure that the settings match the paper loaded in the tray. • You can also change the settings on the printer control panel. <p>b Resend the print job.</p> <p>Is the print still too dark?</p>	Go to step 4.	The problem is solved.
<p>Step 4</p> <p>Make sure that the paper has no texture or rough finishes.</p> <p>Are you printing on textured or rough paper?</p>	Change the texture settings to match the paper you are printing on.	Go to step 5.
<p>Step 5</p> <p>a Load paper from a fresh package.</p> <p>Note: Paper absorbs moisture due to high humidity. Store paper in its original wrapper until you are ready to use it.</p> <p>b Resend the print job.</p> <p>Is the print still too dark?</p>	Go to step 6.	The problem is solved.
<p>Step 6</p> <p>Replace the imaging unit or imaging kit, and then resend the print job.</p> <p>Is the print still too dark?</p>	Contact customer support .	The problem is solved.

Ghost images

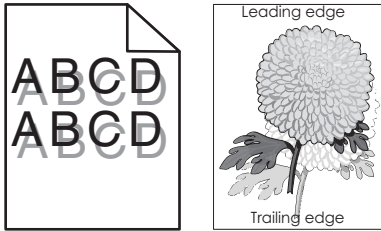

Action	Yes	No
<p>Step 1</p> <p>a Load the tray with the correct paper type and weight.</p> <p>b Resend the print job.</p> <p>Do ghost images still appear on prints?</p>	Go to step 2.	The problem is solved.
<p>Step 2</p> <p>a Depending on your operating system, specify the paper type and weight from the Printing Preferences or Print dialog.</p> <p>Notes:</p> <ul style="list-style-type: none"> • Make sure that the settings match the paper loaded in the tray. • You can also change the settings on the printer control panel. <p>b Resend the print job.</p> <p>Do ghost images still appear on prints?</p>	Go to step 3.	The problem is solved.
<p>Step 3</p> <p>a From the Quality menu on the control panel, select Color Adjust.</p> <p>b Resend the print job.</p> <p>Do ghost images still appear on prints?</p>	Contact customer support .	The problem is solved.

Gray background

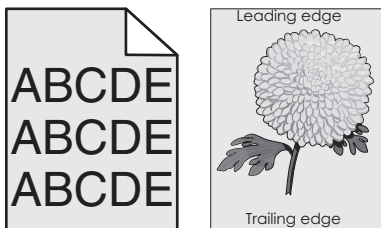

Action	Yes	No
<p>Step 1</p> <p>a From the home screen, touch Settings > Print > Quality.</p> <p>b Adjust the toner darkness.</p> <p>c Print the document.</p> <p>Does gray background still appear on prints?</p>	Go to step 2.	The problem is solved.
<p>Step 2</p> <p>a From the home screen, touch Settings > Print > Quality > Advanced Imaging > Color Adjust.</p> <p>b Start the process.</p> <p>c Print the document.</p> <p>Does gray background still appear on prints?</p>	Go to step 3.	The problem is solved.
<p>Step 3</p> <p>a Remove, and then reinstall the imaging unit or imaging kit.</p> <p>Warning—Potential Damage: Do not expose the imaging unit or imaging kit to direct light for more than 10 minutes. Extended exposure to light may cause print quality problems.</p> <p>Warning—Potential Damage: To avoid damage, do not touch the underside of the imaging unit or imaging kit.</p> <p>b Print the document.</p> <p>Does gray background still appear on prints?</p>	Contact customer support .	The problem is solved.

Horizontal dark lines

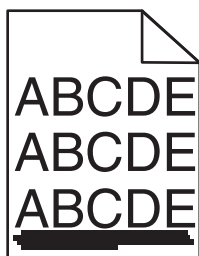

Note: If horizontal dark lines keep appearing on your prints, then see the “Repeating defects” topic.

Action	Yes	No
<p>Step 1</p> <p>a Depending on your operating system, specify the tray or feeder from the Printing Preferences or Print dialog.</p> <p>b Resend the print job.</p> <p>Do horizontal dark lines still appear on prints?</p>	Go to step 2.	The problem is solved.

Action	Yes	No
<p>Step 2</p> <p>a Depending on your operating system, specify the paper type and weight from the Printing Preferences or from Print dialog.</p> <p>Notes:</p> <ul style="list-style-type: none"> • Make sure that the settings match the paper loaded in the tray. • You can also change the settings on the printer control panel. <p>b Resend the print job.</p> <p>Do horizontal dark lines still appear on prints?</p>	Go to step 3.	The problem is solved.
<p>Step 3</p> <p>a Load paper from a fresh package.</p> <p>Note: Paper absorbs moisture due to high humidity. Store paper in its original wrapper until you use it.</p> <p>b Resend the print job.</p> <p>Do horizontal dark lines still appear on prints?</p>	Go to step 4.	The problem is solved.
<p>Step 4</p> <p>a Remove, and then reinstall the imaging unit or imaging kit.</p> <p>Warning—Potential Damage: Do not expose the imaging unit or imaging kit to direct light for more than 10 minutes. Extended exposure to light may cause print quality problems.</p> <p>Warning—Potential Damage: To avoid damage, do not touch the underside of the imaging unit or imaging kit.</p> <p>b Resend the print job.</p> <p>Do horizontal dark lines still appear on prints?</p>	Go to step 5.	The problem is solved.
<p>Step 5</p> <p>Replace the imaging unit or imaging kit, and then resend the print job.</p> <p>Do horizontal dark lines still appear on prints?</p>	Contact customer support .	The problem is solved.

Horizontal white lines

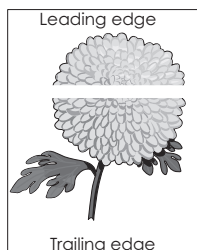

Note: If horizontal dark lines keep appearing on your prints, then see the “Repeating defects” topic.

Action	Yes	No
<p>Step 1</p> <p>a Depending on your operating system, specify the paper type and weight from the Printing Preferences or Print dialog.</p> <p>Notes:</p> <ul style="list-style-type: none"> • Make sure that the settings match the paper loaded in the tray. • You can also change the settings on the printer control panel. <p>b Resend the print job.</p> <p>Do horizontal white lines still appear on prints?</p>	Go to step 2.	The problem is solved.
<p>Step 2</p> <p>a Load the specified tray or feeder with the recommended paper type.</p> <p>b Resend the print job.</p> <p>Do horizontal white lines still appear on prints?</p>	Go to step 3.	The problem is solved.
<p>Step 3</p> <p>a Remove, and then reinstall the imaging unit or imaging kit.</p> <p>Warning—Potential Damage: Do not expose the imaging unit or imaging kit to direct light for more than 10 minutes. Extended exposure to light can cause print quality problems.</p> <p>Warning—Potential Damage: To avoid damage, do not touch the underside of the imaging unit or imaging kit.</p> <p>b Resend the print job.</p> <p>Do horizontal white lines still appear on prints?</p>	Go to step 4.	The problem is solved.
<p>Step 4</p> <p>Replace the imaging unit or imaging kit, and then resend the print job.</p> <p>Do horizontal white lines still appear on prints?</p>	Contact customer support .	The problem is solved.

Incorrect margins

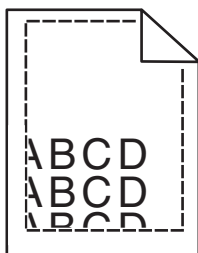

Action	Yes	No
<p>Step 1</p> <p>a Squeeze and slide the paper guides to the correct position for the size of the paper you are loading.</p> <p>b Resend the print job.</p> <p>Are the margins correct?</p>	The problem is solved.	Go to step 2.
<p>Step 2</p> <p>a From the Paper menu on the control panel, check if the printer is detecting the correct paper size.</p> <p>b Resend the print job.</p> <p>Are the margins correct?</p>	The problem is solved.	Go to step 3.
<p>Step 3</p> <p>a Depending on your operating system, specify the paper size from the Printing Preferences or Print dialog.</p> <p>Notes:</p> <ul style="list-style-type: none"> • Make sure that the settings match the paper loaded in the tray. • You can also change the settings on the printer control panel. <p>b Resend the print job.</p> <p>Are the margins correct?</p>	The problem is solved.	Contact customer support .

Jagged or uneven characters

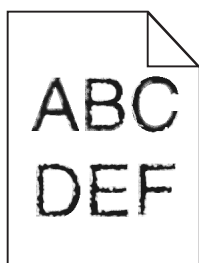

Action	Yes	No
<p>a Check if the printer supports the fonts that are installed on your computer.</p> <p>1 From the control panel, touch: Settings > Reports > Print > Print Fonts</p> <p>2 Select PCL Fonts or PS Fonts.</p> <p>b If the font is not supported, then install a supported font. For more information, contact your administrator.</p> <p>c Resend the print job.</p> <p>Do prints still contain jagged or uneven characters?</p>	<p>Contact customer support.</p>	<p>The problem is solved.</p>

Light print

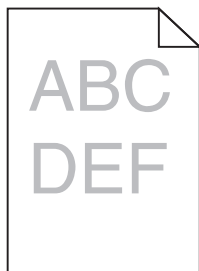

Action	Yes	No
<p>Step 1</p> <p>a From the Quality menu on the control panel, select Color Adjust.</p> <p>b Resend the print job.</p> <p>Is the print still too light?</p>	<p>Go to step 2.</p>	<p>The problem is solved.</p>
<p>Step 2</p> <p>a Depending on your operating system, increase the toner darkness from the Printing Preferences or Print dialog.</p> <p>Note: You can also change the settings on the printer control panel.</p> <p>b Resend the print job.</p> <p>Is the print still too light?</p>	<p>Go to step 3.</p>	<p>The problem is solved.</p>

Action	Yes	No
<p>Step 3</p> <p>a Depending on your operating system, specify the paper type, texture, and weight from the Printing Preferences or Print dialog.</p> <p>Notes:</p> <ul style="list-style-type: none"> • Make sure that the settings match the paper loaded in the tray. • You can also change the settings on the printer control panel. <p>b Resend the print job.</p> <p>Is the print still too light?</p>	Go to step 4.	The problem is solved.
<p>Step 4</p> <p>Make sure that the paper has no texture or rough finishes.</p> <p>Are you printing on textured or rough paper?</p>	Change the texture settings to match the paper you are printing on.	Go to step 5.
<p>Step 5</p> <p>a Load paper from a fresh package.</p> <p>Note: Paper absorbs moisture due to high humidity. Store paper in its original wrapper until you are ready to use it.</p> <p>b Resend the print job.</p> <p>Is the print still too light?</p>	Go to step 6.	The problem is solved.
<p>Step 6</p> <p>Replace the imaging unit or imaging kit, and then resend the print job.</p> <p>Warning—Potential Damage: Do not expose the imaging unit or imaging kit to direct light for more than 10 minutes. Extended exposure to light can cause print quality problems.</p> <p>Warning—Potential Damage: To avoid damage, do not touch the underside of the imaging unit or imaging kit.</p> <p>Is the print still too light?</p>	Contact customer support .	The problem is solved.

Mottled print and dots

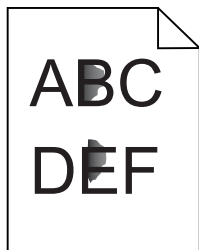

Action	Yes	No
<p>Step 1 Check the printer for leaked toner contamination.</p> <p>Is the printer free of leaked toner?</p>	Go to step 2.	Contact customer support .
<p>Step 2</p> <p>a From the home screen, touch Settings > Device > Preferences.</p> <p>b Check if the paper type and size settings match the paper type and size set in the tray.</p> <p>Do the settings match?</p>	Go to step 4.	Go to step 3.
<p>Step 3</p> <p>a Change the paper size and type in the Paper menu or adjust the size settings in the tray.</p> <p>b Print the document.</p> <p>Is the print still mottled?</p>	Go to step 4.	The problem is solved.
<p>Step 4</p> <p>a Replace the textured or rough paper loaded in the tray with plain paper.</p> <p>b Print the document.</p> <p>Is the print still mottled?</p>	Go to step 5.	The problem is solved.
<p>Step 5</p> <p>a Replace the imaging unit or imaging kit.</p> <p>Warning—Potential Damage: Do not expose the imaging unit or imaging kit to direct light for more than 10 minutes. Extended exposure to light can cause print quality problems.</p> <p>Warning—Potential Damage: To avoid damage, do not touch the underside of the imaging unit or imaging kit.</p> <p>b Print the document.</p> <p>Is the print still mottled?</p>	Contact customer support .	The problem is solved.

Print crooked or skewed

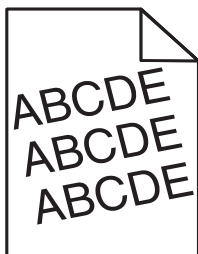

Action	Yes	No
<p>Step 1</p> <ul style="list-style-type: none"> a Remove the tray. b Remove the paper, and then load paper from a fresh package. Note: Paper absorbs moisture due to high humidity. Store paper in its original wrapper until you are ready to use it. c Squeeze and slide the paper guides to the correct position for the size of the paper you are loading. d Insert the tray. e Resend the print job. <p>Is the print still crooked or skewed?</p>	Go to step 2.	The problem is solved.
<p>Step 2</p> <ul style="list-style-type: none"> a Check if you are printing on a supported paper. b Resend the print job. <p>Is the print still crooked or skewed?</p>	Contact customer support .	The problem is solved.

Repeating defects

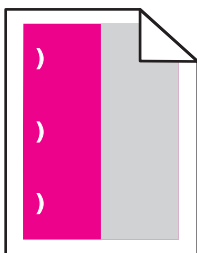

Note: Before solving the problem, print the *Maintenance Defect Ruler* from the Troubleshooting section of the Settings menu.

Action	Yes	No
<p>Step 1</p> <ul style="list-style-type: none"> a Print the quality sample pages. From the home screen, touch Settings > Troubleshooting > Basic Print Quality Samples. b Determine how many colors have defects. <p>Is only one color affected?</p>	Go to step 2.	Go to step 3.

Action	Yes	No
<p>Step 2</p> <p>a Using the <i>Maintenance Defect Ruler</i>, measure the distance between the repeating defects on the affected color page.</p> <p>b Replace the supply item that matches the measurement on the affected color page.</p> <p>Photoconductor unit</p> <ul style="list-style-type: none"> • 125.70 mm (4.95 in.) • 35.40 mm (1.39 in.) <p>Developer unit</p> <p>42 mm (1.65 in.)</p> <p>c Print the quality sample pages.</p> <p>Do the defects still appear?</p>	<p>Take note of the distance, and then contact customer support or your service representative.</p>	<p>The problem is solved.</p>
<p>Step 3</p> <p>a Using the <i>Maintenance Defect Ruler</i>, measure the distance between the repeating defects on the affected color page.</p> <p>b Replace the supply item that matches the measurement on the affected color page.</p> <p>Transfer roller</p> <p>78.50 mm (3.09 in.)</p> <p>Transfer module</p> <ul style="list-style-type: none"> • 47.10 mm (1.86 in.) • 90 mm (3.54 in.) <p>Fuser</p> <ul style="list-style-type: none"> • 96.60 mm (3.80 in.) • 127.60 mm (5.02 in.) <p>c Print the quality sample pages.</p> <p>Do the defects still appear?</p>	<p>Take note of the distance, and then contact customer support or your service representative.</p>	<p>The problem is solved.</p>

Solid color or black images

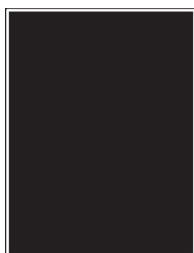

Action	Yes	No
<p>Step 1</p> <p>a Remove, and then reinstall the imaging unit or imaging kit.</p> <p>Warning—Potential Damage: Do not expose the imaging unit or imaging kit to direct light for more than 10 minutes. Extended exposure to light may cause print quality problems.</p> <p>Warning—Potential Damage: To avoid damage, do not touch the underside of the imaging unit or imaging kit.</p> <p>b Resend the print job.</p> <p>Is the printer still printing solid color or black images?</p>	Go to step 2.	The problem is solved.
<p>Step 2</p> <p>Replace the imaging unit or imaging kit, and then resend the print job.</p> <p>Is the printer still printing solid color or black images?</p>	Contact customer support .	The problem is solved.

Text or images cut off

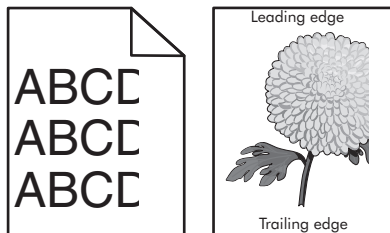

Action	Yes	No
<p>Step 1</p> <p>a Move the paper guides in the tray to the correct position for the paper loaded.</p> <p>b Resend the print job.</p> <p>Is the page or image still clipped?</p>	Go to step 2.	The problem is solved.
<p>Step 2</p> <p>a Depending on your operating system, specify the paper size from the Printing Preferences or Print dialog.</p> <p>Notes:</p> <ul style="list-style-type: none"> • Make sure that the settings match the paper loaded in the tray. • You can also change the settings on the printer control panel. <p>b Resend the print job.</p> <p>Is the page or image still clipped?</p>	Go to step 3.	The problem is solved.

Action	Yes	No
<p>Step 3</p> <p>a Remove, and then reinstall the imaging unit or imaging kit.</p> <p>Warning—Potential Damage: Do not expose the imaging unit or imaging kit to direct light for more than 10 minutes. Extended exposure to light may cause print quality problems.</p> <p>Warning—Potential Damage: To avoid damage, do not touch the underside of the imaging unit or imaging kit.</p> <p>b Resend the print job.</p> <p>Is the page or image still clipped?</p>	<p>Contact customer support.</p>	<p>The problem is solved.</p>

Toner easily rubs off

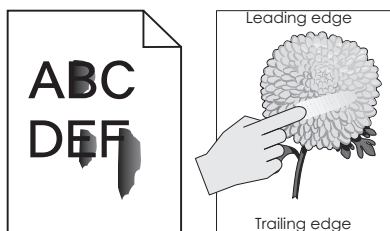

Action	Yes	No
<p>1 Depending on your operating system, specify the paper type, texture, and weight from the Printing Preferences or Print dialog.</p> <p>Notes:</p> <ul style="list-style-type: none"> • Make sure that the settings match the paper loaded in the tray. • You can also change the settings on the printer control panel. <p>2 Resend the print job.</p> <p>Does the toner still rub off?</p>	<p>Contact customer support.</p>	<p>The problem is solved.</p>

Uneven print density

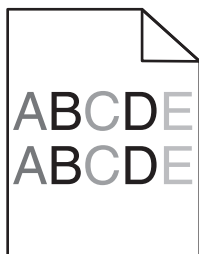

Action	Yes	No
<p>Replace the imaging unit or imaging kit, and then resend the print job.</p> <p>Warning—Potential Damage: Do not expose the imaging unit or imaging kit to direct light for more than 10 minutes. Extended exposure to light can cause print quality problems.</p> <p>Warning—Potential Damage: To avoid damage, do not touch the underside of the imaging unit or imaging kit.</p> <p>Is the print density uneven?</p>	<p>Contact customer support.</p>	<p>The problem is solved.</p>

Vertical dark lines or streaks

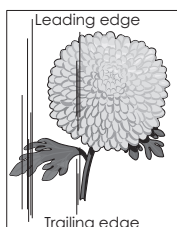
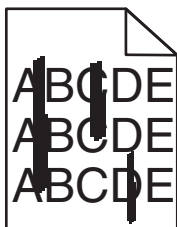

Action	Yes	No
<p>Step 1</p> <p>a Depending on your operating system, specify the paper type, texture, and weight from the Printing Preferences or Print dialog.</p> <p>Notes:</p> <ul style="list-style-type: none"> • Make sure that the settings match the paper loaded in the tray. • You can also change the settings on the printer control panel. <p>b Resend the print job.</p> <p>Do vertical dark lines or streaks still appear on prints?</p>	<p>Go to step 2.</p>	<p>The problem is solved.</p>
<p>Step 2</p> <p>a Load paper from a fresh package.</p> <p>Note: Paper absorbs moisture due to high humidity. Store paper in its original wrapper until you use it.</p> <p>b Resend the print job.</p> <p>Do vertical dark lines or streaks still appear on prints?</p>	<p>Go to step 3.</p>	<p>The problem is solved.</p>

Action	Yes	No
<p>Step 3</p> <p>a Remove, and then reinstall the imaging unit or imaging kit.</p> <p>Warning—Potential Damage: Do not expose the imaging unit or imaging kit to direct light for more than 10 minutes. Extended exposure to light can cause print quality problems.</p> <p>Warning—Potential Damage: To avoid damage, do not touch the underside of the imaging unit or imaging kit.</p> <p>b Resend the print job.</p> <p>Do vertical dark lines or streaks still appear on prints?</p>	Go to step 4.	The problem is solved.
<p>Step 4</p> <p>Replace the imaging unit or imaging kit, and then resend the print job.</p> <p>Do vertical dark lines or streaks still appear on prints?</p>	Contact customer support .	The problem is solved.

Vertical white lines

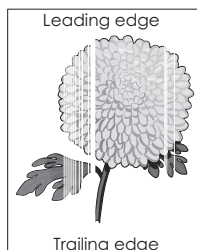

Action	Yes	No
<p>Step 1</p> <p>a Depending on your operating system, specify the paper type and weight from the Printing Preferences or Print dialog.</p> <p>Notes:</p> <ul style="list-style-type: none"> • Make sure that the settings match the paper loaded in the tray. • You can also change the settings on the printer control panel. <p>b Resend the print job.</p> <p>Do vertical white lines still appear on prints?</p>	Go to step 2.	The problem is solved.

Action	Yes	No
<p>Step 2 Check if you are using the recommended paper type.</p> <ul style="list-style-type: none"> a Load the specified tray or feeder with the recommended paper type. b Resend the print job. <p>Do vertical white lines still appear on prints?</p>	Go to step 3.	The problem is solved.
<p>Step 3 a Remove, and then reinstall the imaging unit or imaging kit.</p> <p>Warning—Potential Damage: Do not expose the imaging unit or imaging kit to direct light for more than 10 minutes. Extended exposure to light may cause print quality problems.</p> <p>Warning—Potential Damage: To avoid damage, do not touch the underside of the imaging unit or imaging kit.</p> <ul style="list-style-type: none"> b Resend the print job. <p>Do vertical white lines still appear on prints?</p>	Go to step 4.	The problem is solved.
<p>Step 4 Replace the imaging unit or imaging kit, and then resend the print job.</p> <p>Do vertical white lines still appear on prints?</p>	Contact customer support .	The problem is solved.

The printer is not responding

Action	Yes	No
<p>Step 1 Connect the power cord to the electrical outlet.</p> <p> CAUTION—POTENTIAL INJURY: To avoid the risk of fire or electrical shock, connect the power cord to an appropriately rated and properly grounded electrical outlet that is near the product and easily accessible.</p> <p>Is the printer responding?</p>	The problem is solved.	Go to step 2.
<p>Step 2 Check if the electrical outlet is turned off by a switch or breaker.</p> <p>Is the electrical outlet turned off by a switch or breaker?</p>	Turn on the switch or reset the breaker.	Go to step 3.
<p>Step 3 Check if the printer is on.</p> <p>Is the printer on?</p>	Go to step 4.	Turn on the printer.

Action	Yes	No
<p>Step 4 Check if the printer is in sleep or hibernate mode.</p> <p>Is the printer in sleep or hibernate mode?</p>	Press the power button to wake the printer.	Go to step 5.
<p>Step 5 Check if the cables connecting the printer and the computer are inserted in the correct ports.</p> <p>Are the cables inserted in the correct ports?</p>	Go to step 6.	<p>Make sure to match the following:</p> <ul style="list-style-type: none"> • The USB cable with the USB port on the printer • The Ethernet cable with the Ethernet port on the printer
<p>Step 6 Turn off the printer, reinstall the hardware options, and then turn it back on.</p> <p>For more information, see the documentation that came with the option.</p> <p>Is the printer responding?</p>	The problem is solved	Go to step 7.
<p>Step 7 Install the correct print driver.</p> <p>Is the printer responding?</p>	The problem is solved	Go to step 8.
<p>Step 8 Turn off the printer, wait for about 10 seconds, and then turn it back on.</p> <p>Is the printer responding?</p>	The problem is solved.	Contact customer support .

Job prints from the wrong tray or on the wrong paper

Action	Yes	No
<p>Step 1</p> <p>a Check if you are printing on a supported paper.</p> <p>b Print the document.</p> <p>Is the document printed from the correct tray or on the correct paper?</p>	The problem is solved.	Go to step 2.

Action	Yes	No
<p>Step 2</p> <p>a Depending on your operating system, specify the paper size from the Printing Preferences or Print dialog.</p> <p>Notes:</p> <ul style="list-style-type: none"> • Make sure that the settings match the paper loaded in the tray. • You can also change the settings on the printer control panel. <p>b Print the document.</p> <p>Is the document printed from the correct tray or on the correct paper?</p>	<p>The problem is solved.</p>	<p>Go to step 3.</p>
<p>Step 3</p> <p>a Check if the trays are not linked.</p> <p>b Print the document.</p> <p>Is the document printed from the correct tray or on the correct paper?</p>	<p>The problem is solved.</p>	<p>Contact customer support.</p>

Color quality problems

Adjusting toner darkness

- 1 From the home screen, touch **Settings > Print > Quality**.
- 2 Adjust the toner darkness.
- 3 Apply the changes.

Modifying the colors in printed output

- 1 From the home screen, touch **Settings > Print > Quality > Advanced Imaging > Color Correction > Manual**.
- 2 From the Advanced Imaging menu, select **Color Correction Content**.
- 3 Choose the appropriate color conversion setting.

Object type	Color conversion tables
RGB Image RGB Text RGB Graphics	<ul style="list-style-type: none"> • Vivid—Produces brighter, more saturated colors and may be applied to all incoming color formats. • sRGB Display—Produces an output that approximates the colors displayed on a computer monitor. Black toner usage is optimized for printing photographs. • Display-True Black—Produces an output that approximates the colors displayed on a computer monitor. This setting uses only black toner to create all levels of neutral gray. • sRGB Vivid—Provides an increased color saturation for the sRGB Display color correction. Black toner usage is optimized for printing business graphics. • Off
CMYK Image CMYK Text CMYK Graphics	<ul style="list-style-type: none"> • US CMYK—Applies color correction to approximate the Specifications for Web Offset Publishing (SWOP) color output. • Euro CMYK—Applies color correction to approximate Euroscale color output. • Vivid CMYK—Increases the color saturation of the US CMYK color correction setting. • Off

FAQ about color printing

What is RGB color?

RGB color is a method of describing colors by indicating the amount of red, green, or blue used to produce a certain color. Red, green, and blue light can be added in various amounts to produce a large range of colors observed in nature. Computer screens, scanners, and digital cameras use this method to display colors.

What is CMYK color?

CMYK color is a method of describing colors by indicating the amount of cyan, magenta, yellow, and black used to reproduce a particular color. Cyan, magenta, yellow, and black inks or toners can be printed in various amounts to produce a large range of colors observed in nature. Printing presses, inkjet printers, and color laser printers create colors in this manner.

How is color specified in a document to be printed?

Software programs are used to specify and modify the document color using RGB or CMYK color combinations. For more information, see the software program Help topics.

How does the printer know what color to print?

When printing a document, information describing the type and color of each object is sent to the printer and is passed through color conversion tables. Color is translated into the appropriate amounts of cyan, magenta, yellow, and black toner used to produce the color you want. The object information determines the application of color conversion tables. For example, it is possible to apply one type of color conversion table to text while applying a different color conversion table to photographic images.

What is manual color correction?

When manual color correction is enabled, the printer employs user-selected color conversion tables to process objects. Manual color correction settings are specific to the type of object being printed (text, graphics, or images). It is also specific to how the color of the object is specified in the software program (RGB or CMYK combinations). To apply a different color conversion table manually, see [“Modifying the colors in printed output” on page 155](#).

If the software program does not specify colors with RGB or CMYK combinations, then manual color correction is not useful. It is also not effective if the software program or the computer operating system controls the adjustment of colors. In most situations, setting the Color Correction to Auto generates preferred colors for the documents.

How can I match a particular color (such as a corporate logo)?

From the printer Quality menu, nine types of Color Samples sets are available. These sets are also available from the Color Samples page of the Embedded Web Server. Selecting any sample set generates multiple-page prints consisting of hundreds of colored boxes. Each box contains a CMYK or RGB combination, depending on the table selected. The observed color of each box is obtained by passing the CMYK or RGB combination labeled on the box through the selected color conversion table.

By examining Color Samples sets, you can identify the box with color closest to the color being matched. The color combination labeled on the box can then be used for modifying the color of the object in a software program. For more information, see the software program Help topics. Manual color correction may be necessary to use the selected color conversion table for the particular object.

Selecting which Color Samples set to use for a particular color-matching problem depends on:

- The Color Correction setting being used (Auto, Off, or Manual)
- The type of object being printed (text, graphics, or images)
- How the color of the object is specified in the software program (RGB or CMYK combinations)

If the software program does not specify colors with RGB or CMYK combinations, then the Color Samples pages are not useful. Additionally, some software programs adjust the RGB or CMYK combinations specified in the program through color management. In these situations, the printed color may not be an exact match of the Color Samples pages.

The print appears tinted

Action	No	Yes
Adjust the color balance. a From the home screen, touch Settings > Print > Quality > Advanced Imaging > Color Balance . b Adjust the setting. c Resend the print job. Does the print still appear tinted?	The problem is solved.	Contact customer support .

Faxing problems

Cannot send or receive faxes

Action	Yes	No
<p>Step 1 Resolve any error messages that appear on the display.</p> <p>Can you send or receive a fax?</p>	The problem is solved.	Go to step 2.
<p>Step 2 Make sure that the cable connections for the following equipment are secure:</p> <ul style="list-style-type: none"> • Telephone • Handset • Answering machine <p>Can you send or receive a fax?</p>	The problem is solved.	Go to step 3.
<p>Step 3 Check for a dial tone.</p> <ul style="list-style-type: none"> • Call the fax number to check if it is working properly. • If you are using the On Hook Dial feature, then turn up the volume to check if you hear a dial tone. <p>Can you hear a dial tone?</p>	Go to step 5.	Go to step 4.
<p>Step 4 Check the telephone wall jack.</p> <ol style="list-style-type: none"> a Connect the analog telephone directly to the wall jack. b Listen for a dial tone. c If you do not hear a dial tone, then use a different telephone cable. d If you still do not hear a dial tone, then connect the analog telephone to a different wall jack. e If you hear a dial tone, then connect the printer to that wall jack. <p>Can you send or receive a fax?</p>	The problem is solved.	Go to step 5.

Action	Yes	No
<p>Step 5</p> <p>Check if the printer is connected to an analog phone service or to the correct digital connector.</p> <ul style="list-style-type: none"> • If you are using an Integrated Services for Digital Network (ISDN) telephone service, then connect to an analog telephone port of an ISDN terminal adapter. For more information, contact your ISDN provider. • If you are using DSL, then connect to a DSL filter or router that supports analog use. For more information, contact your DSL provider. • If you are using a private branch exchange (PBX) telephone service, then make sure that you are connecting to an analog connection on the PBX. If none exists, then consider installing an analog telephone line for the fax machine. <p>Can you send or receive a fax?</p>	<p>The problem is solved.</p>	<p>Go to step 6.</p>
<p>Step 6</p> <p>Temporarily disconnect other equipment and disable other telephone services.</p> <ol style="list-style-type: none"> a Disconnect other equipment (such as answering machines, computers, modems, or telephone line splitters) between the printer and the telephone line. b Disable call waiting and voice mail. For more information, contact your telephone company. <p>Can you send or receive a fax?</p>	<p>The problem is solved.</p>	<p>Go to step 7.</p>
<p>Step 7</p> <p>Scan the original document one page at a time.</p> <ol style="list-style-type: none"> a Dial the fax number. b Scan the document. <p>Can you send or receive a fax?</p>	<p>The problem is solved.</p>	<p>Contact customer support.</p>

Can receive but not send faxes

Action	Yes	No
<p>Step 1 Load the original document properly into the ADF tray or on the scanner glass.</p> <p>Can you send faxes?</p>	The problem is solved.	Go to step 2.
<p>Step 2 Set up the shortcut number properly.</p> <ul style="list-style-type: none"> • Check if the shortcut number is set for the telephone number that you want to dial. • Dial the telephone number manually. <p>Can you send faxes?</p>	The problem is solved.	Contact customer support .

Can send but not receive faxes

Action	Yes	No
<p>Step 1 Make sure that the tray or multipurpose feeder is not empty.</p> <p>Can you receive faxes?</p>	The problem is solved.	Go to step 2.
<p>Step 2 Check the ring count delay settings.</p> <p>a From the home screen, touch Settings > Fax > Analog Fax Setup > Fax Receive Settings > Rings to Answer.</p> <p>b If necessary, configure the setting.</p> <p>Can you receive faxes?</p>	The problem is solved.	Go to step 3.
<p>Step 3 Replace the toner cartridge.</p> <p>For more information, see the instruction sheet that came with the supply.</p> <p>Can you receive faxes?</p>	The problem is solved.	Contact customer support .

Poor fax print quality

Action	Yes	No
<p>Step 1 Enhance the print quality.</p> <p>a From the home screen, touch Settings > Print > Quality.</p> <p>b Adjust the settings.</p> <p>Is the fax print quality satisfactory?</p>	The problem is solved.	Go to step 2.
<p>Step 2 Decrease the incoming fax transmission speed.</p> <p>a From the home screen, touch Settings > Fax > Analog Fax Setup > Fax Receive Settings > Admin Controls > Max Speed.</p> <p>b Select a lower transmission speed.</p> <p>Is the fax print quality satisfactory?</p>	The problem is solved.	Go to step 3.
<p>Step 3 Replace the toner cartridge.</p> <p>For more information, see the instruction sheet that came with the supply.</p> <p>Is the fax print quality satisfactory?</p>	The problem is solved.	Contact customer support .

Scanning problems

Adjusting scanner registration

- 1 From the control panel, navigate to:
Settings > Maintenance > Configuration Menu > Scanner Configuration > Scanner Manual Registration
- 2 From the Print Quick Test menu, touch **Start**.
- 3 Place the Print Quick Test page on the scanner glass, and then touch **Flatbed Registration**.
- 4 From the Copy Quick Test menu, touch **Start**.
- 5 Compare the Copy Quick Test page with the original document.
Note: If the margins of the test page are different from the original document, then adjust Left Margin and Top Margin.
- 6 Repeat [step 4](#) and [step 5](#) until the margins of the Copy Quick Test page closely match the original document.

Adjusting ADF registration

- 1 From the control panel, navigate to:
Settings > Maintenance > Configuration Menu > Scanner Configuration > Scanner Manual Registration
- 2 From the Print Quick Test menu, touch **Start**.
- 3 Place the Print Quick Test page on the ADF tray.
- 4 Touch **Front ADF Registration** or **Rear ADF Registration**.

Notes:

- To align Front ADF Registration, place the test page faceup, short edge first into the ADF.
- To align Rear ADF Registration, place the test page facedown, short edge first into the ADF.

- 5 From the Copy Quick Test menu, touch **Start**.
- 6 Compare the Copy Quick Test page with the original document.
Note: If the margins of the test page are different from the original document, then adjust Horizontal Adjust and Top Margin.
- 7 Repeat [step 5](#) and [step 6](#) until the margins of the Copy Quick Test page closely match the original document.

Cannot scan from a computer

Action	Yes	No
<p>Step 1</p> <p>a Turn off the printer, wait for about 10 seconds, and then turn it back on.</p> <p>b Resend the scan job.</p> <p>Can you send the scan job?</p>	The problem is solved.	Go to step 2.
<p>Step 2</p> <p>a Make sure that the cables between the printer and the print server are secure. For more information, see the setup documentation that came with the printer.</p> <p>b Resend the scan job.</p> <p>Can you send the scan job?</p>	The problem is solved.	Contact customer support .

Partial copies of document or photo

Action	Yes	No
<p>Step 1</p> <p>a Make sure that the document or photo is loaded facedown on the upper left corner of the scanner glass.</p> <p>b Copy the document or photo.</p> <p>Is the document or photo copied correctly?</p>	The problem is solved.	Go to step 2.
<p>Step 2</p> <p>a Match the paper size setting and the paper loaded in the tray.</p> <p>b Copy the document or photo.</p> <p>Is the document or photo copied correctly?</p>	The problem is solved.	Contact customer support .

Poor copy quality

Action	Yes	No
<p>Step 1</p> <p>a Clean the scanner glass and the ADF glass with a damp, soft, lint-free cloth.</p> <p>b Make sure that the document or photo is loaded facedown on the upper left corner of the scanner glass.</p> <p>c Copy the document or photo.</p> <p>Is the copy quality satisfactory?</p>	The problem is solved.	Go to step 2.
<p>Step 2</p> <p>a Check the quality of the original document or photo.</p> <p>b Adjust the scan quality settings.</p> <p>c Copy the document or photo.</p> <p>Is the copy quality satisfactory?</p>	The problem is solved.	Contact customer support .

Scan job was not successful

Action	Yes	No
<p>Step 1</p> <p>Check the cable connections.</p> <p>a Make sure that the Ethernet or USB cable is securely connected to the computer and the printer.</p> <p>b Resend the scan job.</p> <p>Is the scan job successful?</p>	The problem is solved.	Go to step 2.

Action	Yes	No
<p>Step 2 Check the file you want to scan.</p> <ul style="list-style-type: none"> a Make sure that the file name is not already used in the destination folder. b Make sure that the document or photo you want to scan is not open in another application. c Resend the scan job. <p>Is the scan job successful?</p>	The problem is solved.	Go to step 3.
<p>Step 3 a Make sure that the Append time stamp or the Overwrite existing file check box is selected in the destination configuration settings.</p> <ul style="list-style-type: none"> b Resend the scan job. <p>Is the scan job successful?</p>	The problem is solved.	Contact customer support .

Scanner does not close

Action	Yes	No
<p>Remove obstructions that keep the scanner unit open.</p> <p>Did the scanner unit close correctly?</p>	The problem is solved.	Contact customer support .

Scanning takes too long or freezes the computer

Action	Yes	No
<p>Close all applications that are interfering with the scan.</p> <p>Does scanning take too long or freeze the computer?</p>	Contact customer support .	The problem is solved.

Scanner does not respond

Action	Yes	No
<p>Step 1 a Check if the printer is turned on. b Resolve any error messages that appear on the display. c Copy or scan the document.</p> <p>Is the scanner responding?</p>	The problem is solved.	Go to step 2.

Action	Yes	No
<p>Step 2</p> <p>a Check if the power cord is connected properly to the printer and the electrical outlet.</p> <p> CAUTION—POTENTIAL INJURY: To avoid the risk of fire or electrical shock, connect the power cord to an appropriately rated and properly grounded electrical outlet that is near the product and easily accessible.</p> <p>b Copy or scan the document.</p> <p>Is the scanner responding?</p>	<p>The problem is solved.</p>	<p>Go to step 3.</p>
<p>Step 3</p> <p>a Turn off the printer, wait for about 10 seconds, and then turn it back on.</p> <p>b Copy or scan the document.</p> <p>Is the scanner responding?</p>	<p>The problem is solved.</p>	<p>Contact customer support.</p>

Contacting customer support

Before contacting customer support, make sure to have the following information:

- Printer problem
- Error message
- Printer model type and serial number

Go to <http://support.lexmark.com> to receive e-mail or chat support, or browse through the library of manuals, support documentation, drivers, and other downloads.

Technical support via telephone is also available. In the U.S. or Canada, call 1-800-539-6275. For other countries or regions, go to <http://support.lexmark.com>.

Upgrading and migrating

Hardware

Available internal options

- Memory card
 - DDR3 DIMM
 - Flash memory
 - Fonts
 - Application cards
 - Forms and Bar Code
 - PRESCRIBE
 - IPDS
- Lexmark Internal Solutions Port (ISP)
 - MarkNet™ N8360 (802.11 b/g/n/a wireless print server bundled with LEX-M06-001 Mobile Solutions Module)
 - IEEE 1284-B Parallel Card
 - RS-232C Serial Card

Installing a memory card

⚠ CAUTION—SHOCK HAZARD: To avoid the risk of electrical shock, if you are accessing the controller board or installing optional hardware or memory devices sometime after setting up the printer, then turn the printer off, and unplug the power cord from the electrical outlet before continuing. If you have any other devices attached to the printer, then turn them off as well, and unplug any cables going into the printer.

- 1 Turn off the printer, and then unplug the power cord from the electrical outlet.
- 2 Using a flat-head screwdriver, remove the controller board access cover.

Warning—Potential Damage: Controller board electronic components are easily damaged by static electricity. Touch a metal surface on the printer before touching any controller board components or connectors.

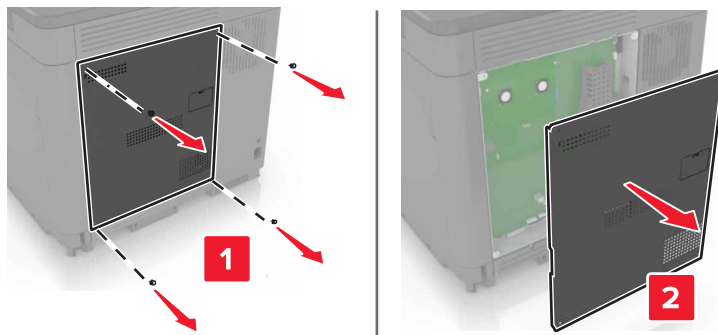

- Unpack the memory card.

Warning—Potential Damage: Avoid touching the connection points along the edge of the card.

- Insert the memory card until it *clicks* into place.

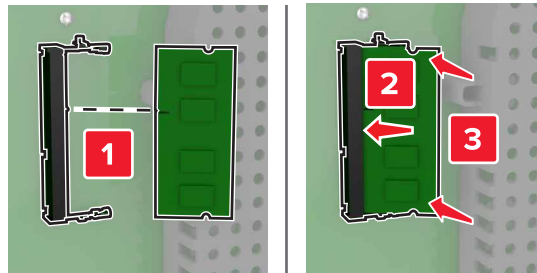

- Reattach the access cover.

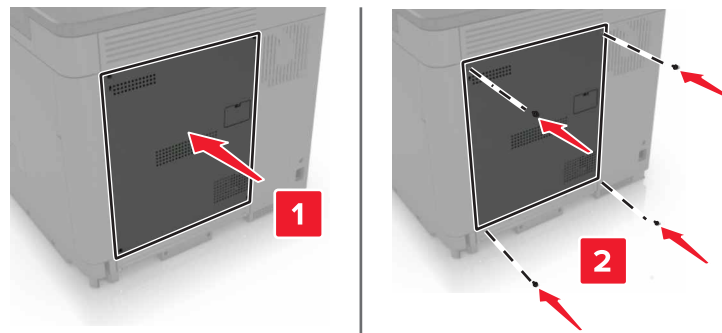

- Connect the power cord to the electrical outlet, and then turn on the printer.

CAUTION—POTENTIAL INJURY: To avoid the risk of fire or electrical shock, connect the power cord to an appropriately rated and properly grounded electrical outlet that is near the product and easily accessible.

Installing an internal solutions port

CAUTION—SHOCK HAZARD: To avoid the risk of electrical shock, if you are accessing the controller board or installing optional hardware or memory devices sometime after setting up the printer, then turn the printer off, and unplug the power cord from the electrical outlet before continuing. If you have any other devices attached to the printer, then turn them off as well, and unplug any cables going into the printer.

- Turn off the printer, and then unplug the power cord from the electrical outlet.
- Using a flat-head screwdriver, remove the controller board access cover.

Warning—Potential Damage: Controller board electronic components are easily damaged by static electricity. Touch a metal surface on the printer before touching any controller board components or connectors.

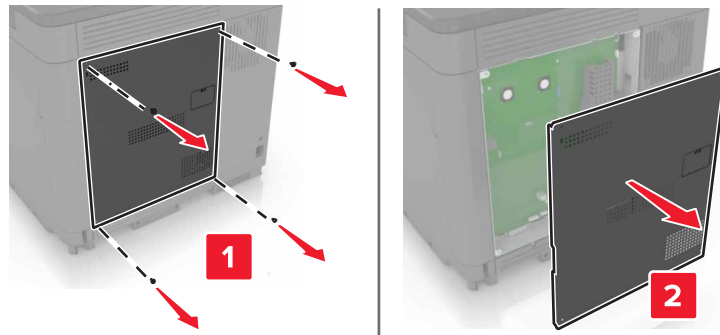

3 Unpack the internal solutions port (ISP) kit.

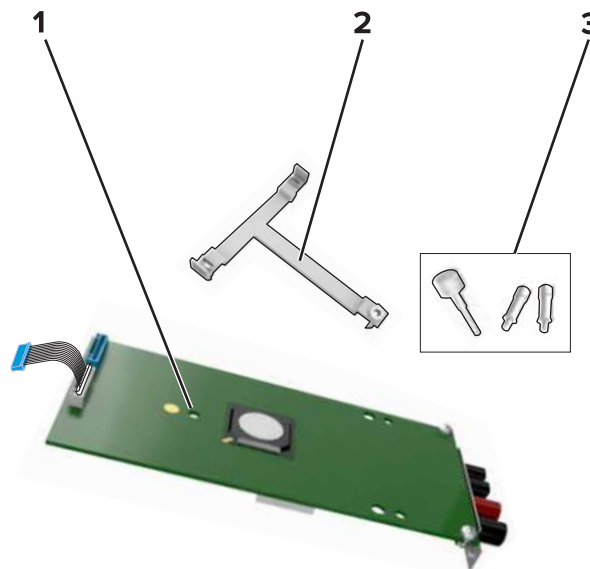

1	ISP
2	Mounting bracket
3	Thumbscrews

4 If necessary, remove the printer hard disk.

5 Insert the bracket into the board until it *clicks* into place.

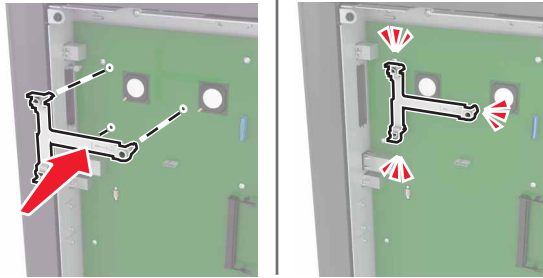

6 Attach the ISP to the bracket.

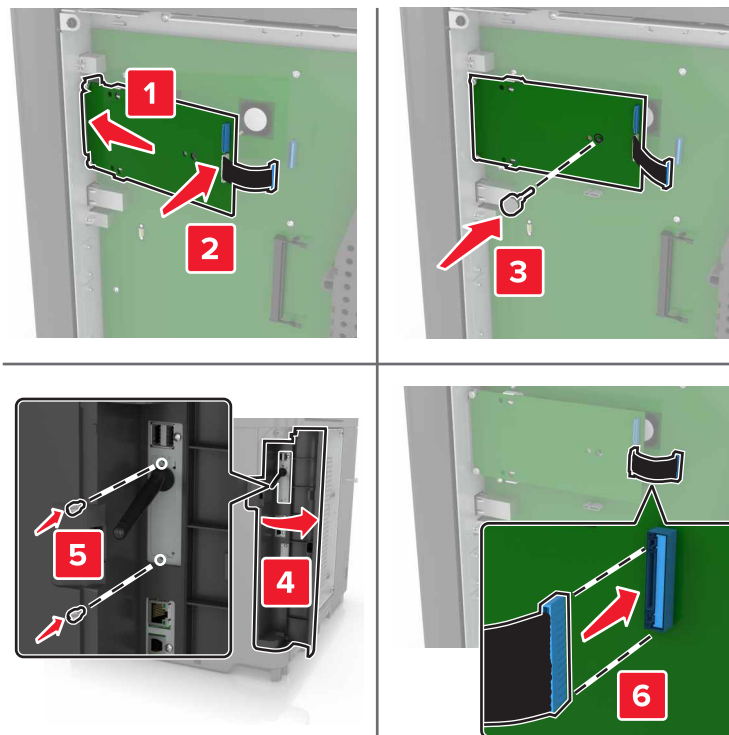

7 If necessary, attach the hard disk to the ISP.

a Remove the hard disk bracket.

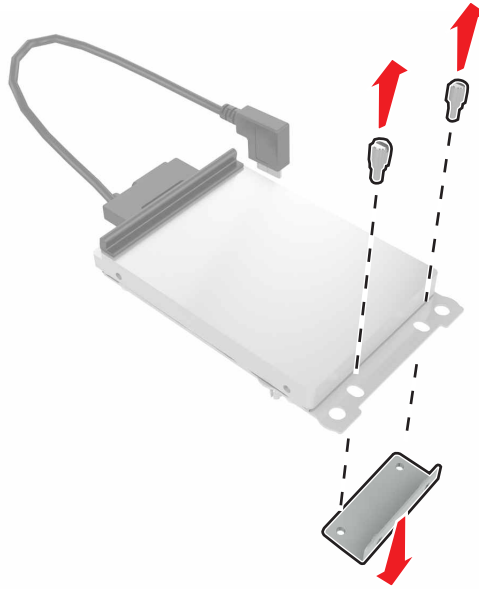

b Connect the hard disk to the ISP.

Warning—Potential Damage: Do not touch or press the center of the hard disk.

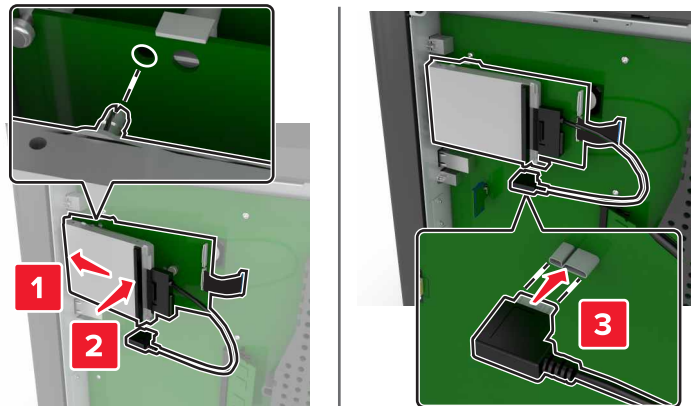

- 8 Reattach the access cover.

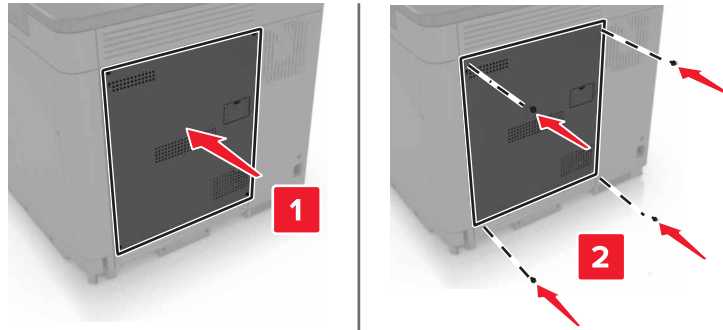

- 9 Connect the power cord to the electrical outlet, and then turn on the printer.

CAUTION—POTENTIAL INJURY: To avoid the risk of fire or electrical shock, connect the power cord to an appropriately rated and properly grounded electrical outlet that is near the product and easily accessible.

Installing an optional card

CAUTION—SHOCK HAZARD: To avoid the risk of electrical shock, if you are accessing the controller board or installing optional hardware or memory devices sometime after setting up the printer, then turn the printer off, and unplug the power cord from the electrical outlet before continuing. If you have any other devices attached to the printer, then turn them off as well, and unplug any cables going into the printer.

- 1 Turn off the printer, and then unplug the power cord from the electrical outlet.
- 2 Using a flat-head screwdriver, remove the controller board access cover.

Warning—Potential Damage: Controller board electronic components are easily damaged by static electricity. Touch a metal surface on the printer before touching any components or connectors.

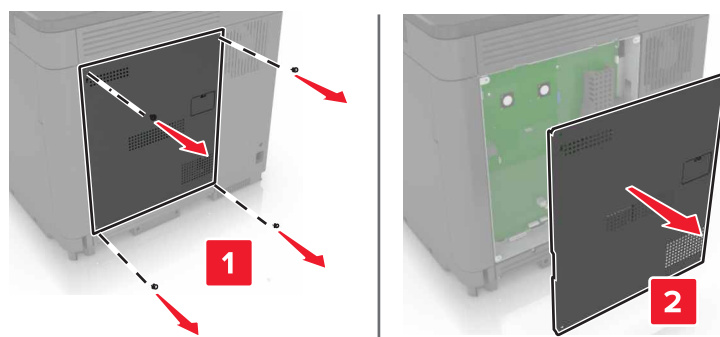

- 3 Unpack the optional card.

Warning—Potential Damage: Avoid touching the connection points along the edge of the card.

- 4 Push the card firmly into place.

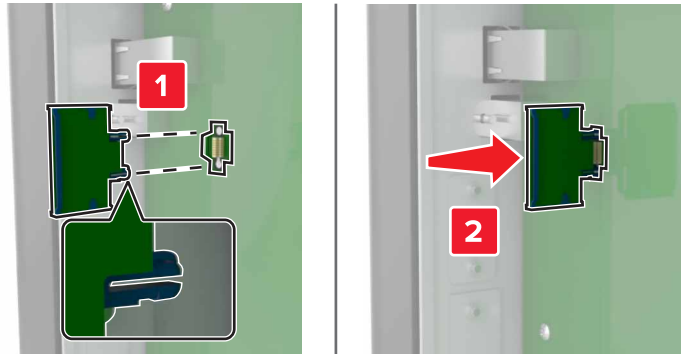

Note: The entire length of the connector on the card must touch and be flush against the controller board.

Warning—Potential Damage: Improper installation of the card may cause damage to the card and the controller board.

- 5 Reattach the access cover.

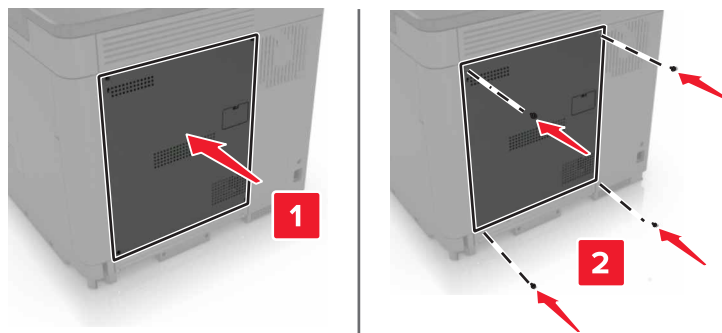

- 6 Connect the power cord to the electrical outlet, and then turn on the printer.

CAUTION—POTENTIAL INJURY: To avoid the risk of fire or electrical shock, connect the power cord to an appropriately rated and properly grounded electrical outlet that is near the product and easily accessible.

Installing a printer hard disk

CAUTION—SHOCK HAZARD: To avoid the risk of electrical shock, if you are accessing the controller board or installing optional hardware or memory devices sometime after setting up the printer, then turn the printer off, and unplug the power cord from the electrical outlet before continuing. If you have any other devices attached to the printer, then turn them off as well, and unplug any cables going into the printer.

- 1 Turn off the printer, and then unplug the power cord from the electrical outlet.
- 2 Using a flat-head screwdriver, remove the controller board access cover.

Warning—Potential Damage: Controller board electronic components are easily damaged by static electricity. Touch a metal surface on the printer before touching any controller board components or connectors.

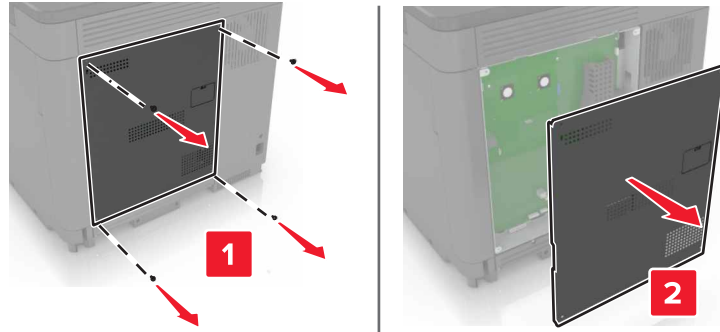

3 Unpack the hard disk.

4 Attach the hard disk to the controller board.

Warning—Potential Damage: Do not touch or press the center of the hard disk.

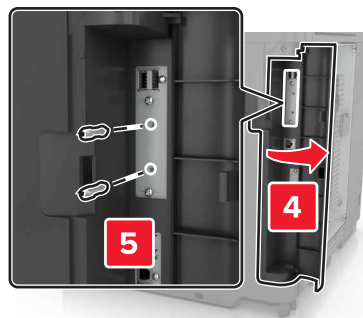
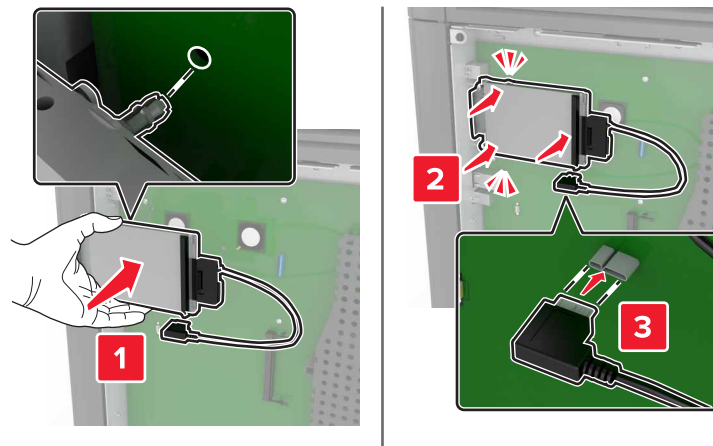

If an internal solutions port (ISP) is installed, then do the following:

- a Remove the hard disk bracket.

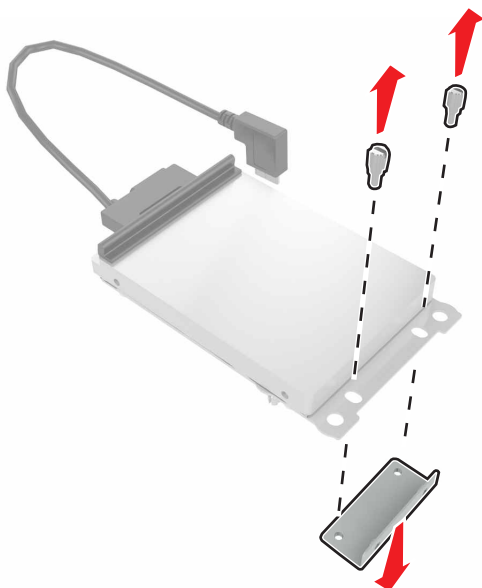

- b Attach the hard disk to the ISP.

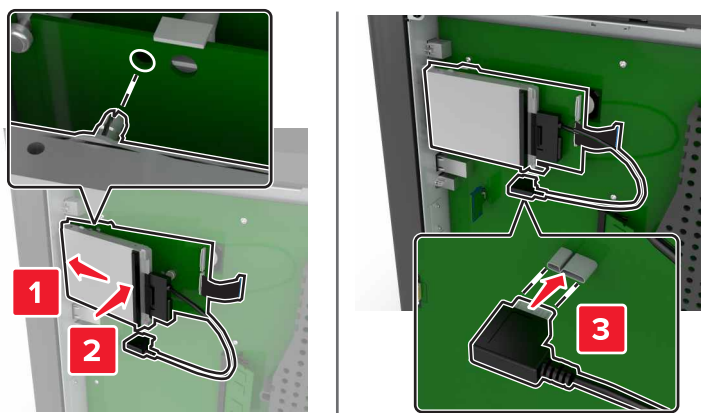

- 5 Reattach the access cover.

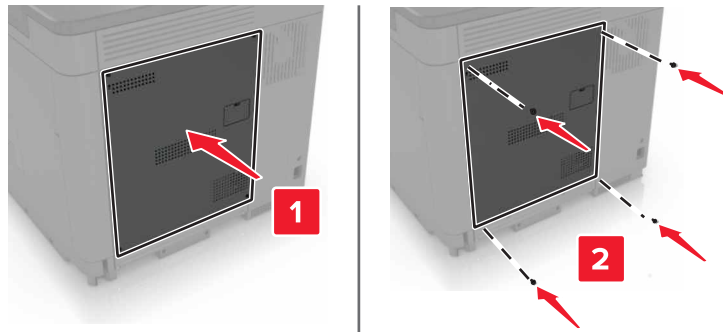

- 6 Connect the power cord to the electrical outlet, and then turn on the printer.

CAUTION—POTENTIAL INJURY: To avoid the risk of fire or electrical shock, connect the power cord to an appropriately rated and properly grounded electrical outlet that is near the product and easily accessible.

Installing optional trays

CAUTION—SHOCK HAZARD: To avoid the risk of electrical shock, if you are accessing the controller board or installing optional hardware or memory devices sometime after setting up the printer, then turn the printer off, and unplug the power cord from the electrical outlet before continuing. If you have any other devices attached to the printer, then turn them off as well, and unplug any cables going into the printer.

CAUTION—TIPPING HAZARD: Installing one or more options on your printer or MFP may require a caster base, furniture, or other feature to prevent instability causing possible injury. For more information on supported configurations, see www.lexmark.com/multifunctionprinters.

- 1 Turn off the printer.
- 2 Unplug the power cord from the electrical outlet, and then from the printer.
- 3 Unpack the optional tray, and then remove all packing material.
- 4 Lift the printer using the side and rear handles.

CAUTION—POTENTIAL INJURY: If the printer weight is greater than 18 kg (40 lb), then it requires two or more trained personnel to lift it safely.

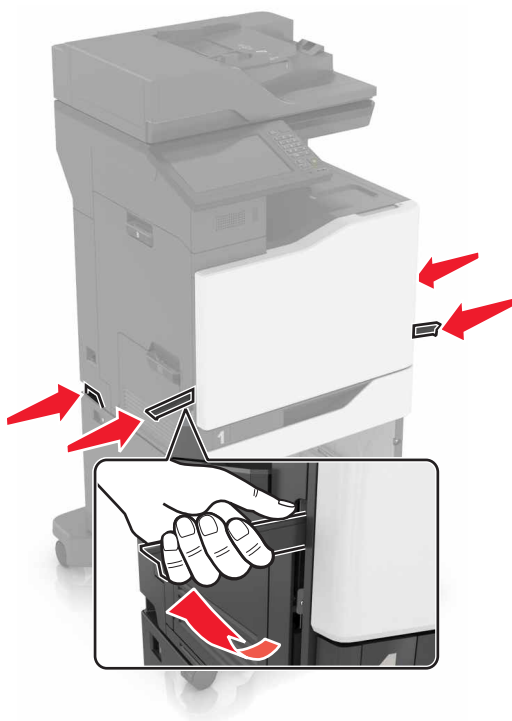

Note: If optional trays are already installed, then unlock them from the printer before lifting the printer. Do not try to lift the printer and trays at the same time.

5 Align the printer with the optional tray, and then lower the printer until it *clicks* into place.

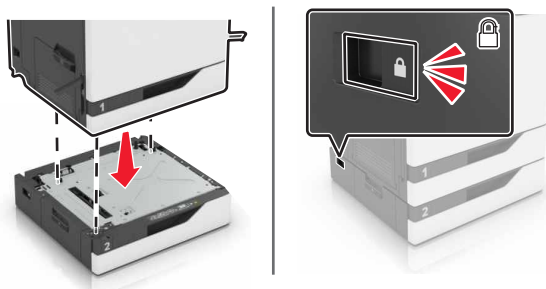

6 Connect the power cord to the printer, and then to the electrical outlet.

⚠ CAUTION—POTENTIAL INJURY: To avoid the risk of fire or electrical shock, connect the power cord to an appropriately rated and properly grounded electrical outlet that is near the product and easily accessible.

7 Turn on the printer.

If necessary, manually add the tray in the print driver to make it available for print jobs. For more information, see [“Adding available options in the print driver” on page 182.](#)

When installing more than one hardware option, follow this order of installation.

- Caster base
- Optional 2200-sheet tray
- Optional 550-sheet tray or envelope tray

- Printer
- Staple finisher

Installing the staple finisher

- 1 Turn off the printer.
- 2 Open door C.

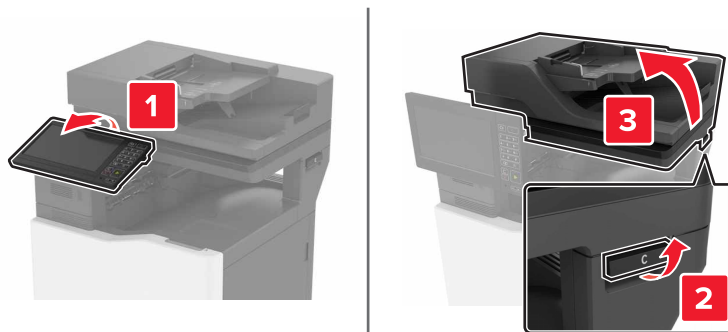

- 3 Open door A.

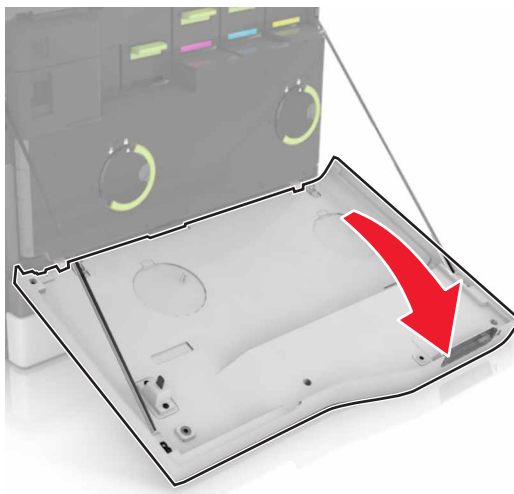

4 Remove the paper bail.

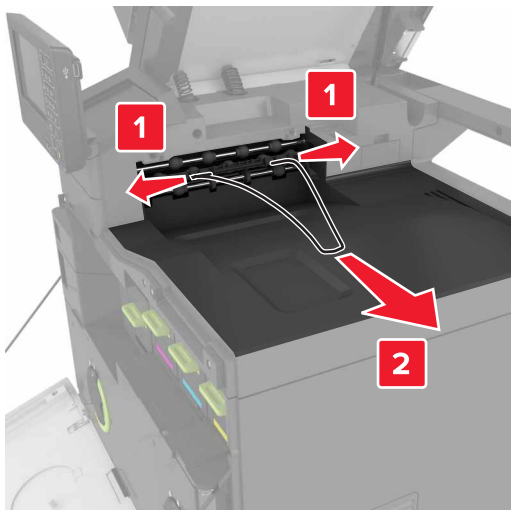

5 Remove the standard bin insert.

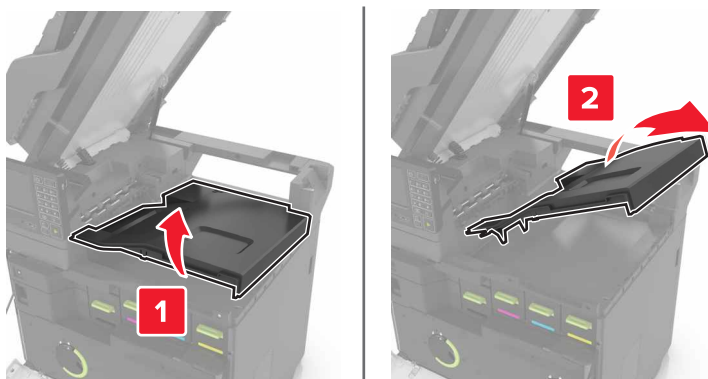

- 6 Remove the staple finisher connector cover.

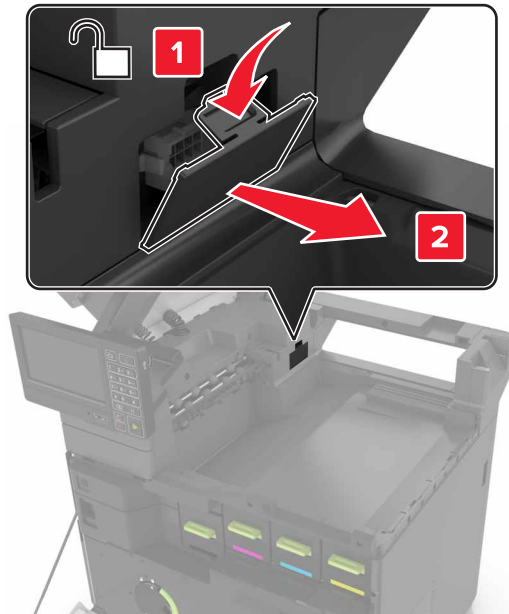

- 7 Unpack the staple finisher, and then remove the packing material.

- 8 Insert the staple finisher until it *clicks* into place.

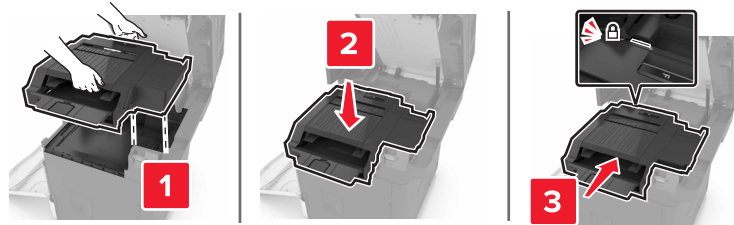

- 9 Close doors A and C.

 **CAUTION—PINCH HAZARD:** To avoid the risk of a pinch injury, keep hands clear of the labeled area when closing door C.

- 10 Turn on the printer.

Installing the keyboard tray

- 1 Turn off the printer.
- 2 Open door A.

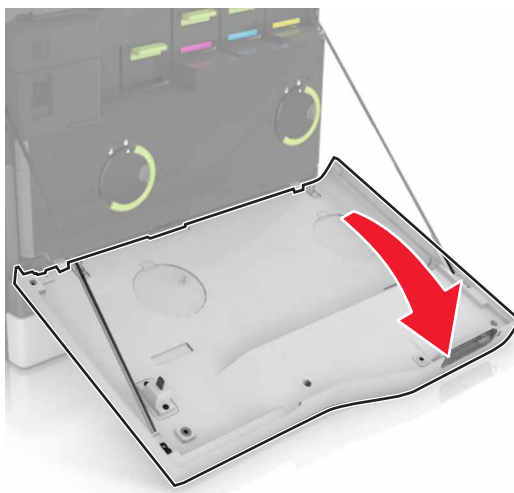

- 3 Remove the keyboard attach cover.

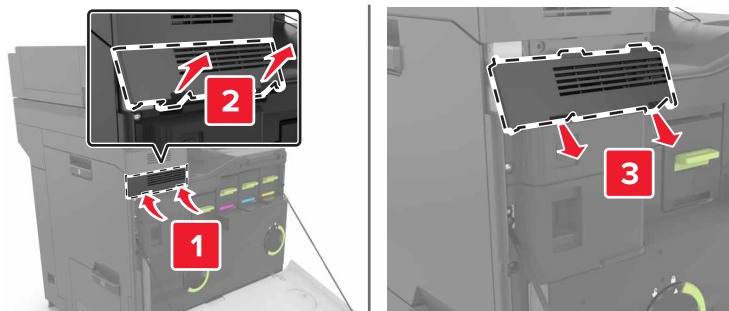

- 4 Unpack the keyboard tray.

5 Attach the keyboard to the base.

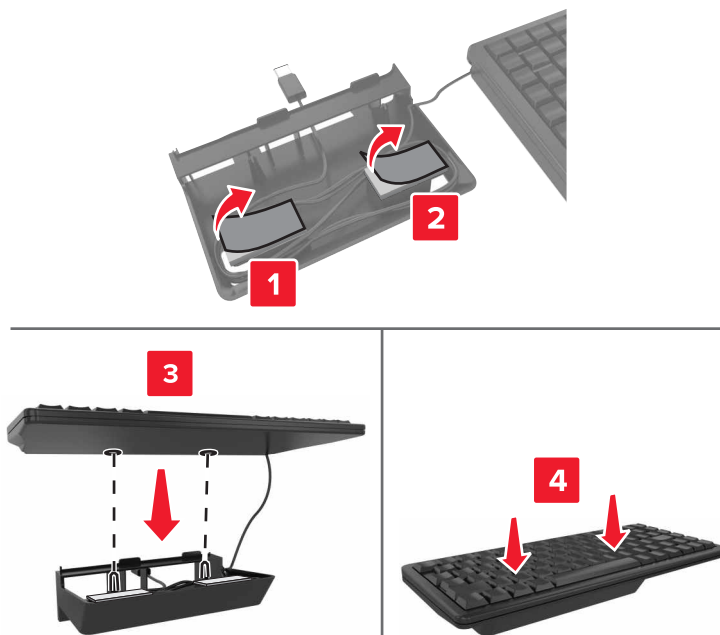

6 Insert the keyboard tray.

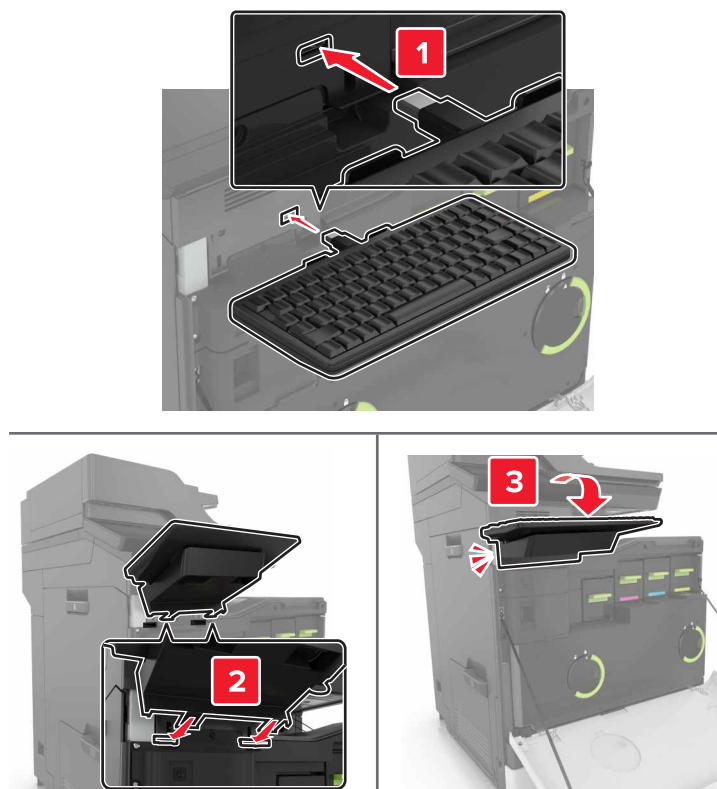

7 Close door A.

8 Turn on the printer.

Software

Installing the printer software

- 1 Obtain a copy of the software installer package.
 - From the software CD that came with your printer.
 - Go to <http://support.lexmark.com>, and then select your printer and operating system.
- 2 Run the installer, and then follow the instructions on the computer screen.
- 3 For Macintosh users, add the printer.

Note: Obtain the printer IP address from the TCP/IP section in the Network/Ports menu.

Adding available options in the print driver

For Windows users

- 1 Open the printers folder.
- 2 Select the printer you want to update, and then do either of the following:
 - For Windows 7 or later, select **Printer properties**.
 - For earlier versions, select **Properties**.
- 3 Navigate to the Configuration tab, and then select **Update Now - Ask Printer**.
- 4 Apply the changes.

For Macintosh users

- 1 From System Preferences in the Apple menu, navigate to your printer, and then select **Options & Supplies**.
- 2 Navigate to the list of hardware options, and then add any installed options.
- 3 Apply the changes.

Firmware

Exporting or importing a configuration file

You can export the configuration settings of your printer into a text file, and then import the file to apply the settings to other printers.

- 1 Open a web browser, and then type the printer IP address in the address field.

Notes:

- View the printer IP address on the printer home screen. The IP address appears as four sets of numbers separated by periods, such as 123.123.123.123.
 - If you are using a proxy server, then temporarily disable it to load the web page correctly.
- 2 Export or import a configuration file for one or multiple applications.

For one application

- a** From the Embedded Web Server, click **Apps** > the application that you want > **Configure**.
- b** Click **Export** or **Import**.

For multiple applications

- a** From the Embedded Web Server, click **Export Configuration** or **Import Configuration**.
- b** Follow the instructions on the screen.

Updating firmware

Some applications require a minimum device firmware level to operate correctly.

For more information on updating the device firmware, contact your Lexmark representative.

- 1** From the Embedded Web Server, click **Settings** > **Device** > **Update Firmware**.
- 2** Browse to locate the required flash file.
- 3** Apply the changes.

Notices

Product information

Product name:

Lexmark CX820de, CX820dtfe, CX827de

Machine type:

7563

Model(s):

136, 137

Edition notice

October 2017

The following paragraph does not apply to any country where such provisions are inconsistent with local law: LEXMARK INTERNATIONAL, INC., PROVIDES THIS PUBLICATION "AS IS" WITHOUT WARRANTY OF ANY KIND, EITHER EXPRESS OR IMPLIED, INCLUDING, BUT NOT LIMITED TO, THE IMPLIED WARRANTIES OF MERCHANTABILITY OR FITNESS FOR A PARTICULAR PURPOSE. Some states do not allow disclaimer of express or implied warranties in certain transactions; therefore, this statement may not apply to you.

This publication could include technical inaccuracies or typographical errors. Changes are periodically made to the information herein; these changes will be incorporated in later editions. Improvements or changes in the products or the programs described may be made at any time.

References in this publication to products, programs, or services do not imply that the manufacturer intends to make these available in all countries in which it operates. Any reference to a product, program, or service is not intended to state or imply that only that product, program, or service may be used. Any functionally equivalent product, program, or service that does not infringe any existing intellectual property right may be used instead. Evaluation and verification of operation in conjunction with other products, programs, or services, except those expressly designated by the manufacturer, are the user's responsibility.

For Lexmark technical support, visit <http://support.lexmark.com>.

For information on supplies and downloads, visit www.lexmark.com.

© 2016 Lexmark International, Inc.

All rights reserved.

GOVERNMENT END USERS

The Software Program and any related documentation are "Commercial Items," as that term is defined in 48 C.F.R. 2.101, "Computer Software" and "Commercial Computer Software Documentation," as such terms are used in 48 C.F.R. 12.212 or 48 C.F.R. 227.7202, as applicable. Consistent with 48 C.F.R. 12.212 or 48 C.F.R. 227.7202-1 through 227.7207-4, as applicable, the Commercial Computer Software and Commercial Software Documentation are licensed to the U.S. Government end users (a) only as Commercial Items and (b) with only those rights as are granted to all other end users pursuant to the terms and conditions herein.

Licensing notices

All licensing notices associated with this product can be viewed from the CD:\NOTICES directory of the installation software CD.

Trademarks

Lexmark, the Lexmark logo, and MarkNet are trademarks or registered trademarks of Lexmark International, Inc. in the United States and/or other countries.

Google Cloud Print and Google Chrome are trademarks of Google Inc.

Macintosh, the Mac logo, and Safari are trademarks of Apple Inc.

Microsoft, Windows, and Internet Explorer are either registered trademarks or trademarks of the Microsoft group of companies in the United States and other countries.

Mopria®, the Mopria® logo, and the Mopria® Alliance logo are registered trademarks and service marks of Mopria Alliance, Inc. in the United States and other countries. Unauthorized use is strictly prohibited.

PCL® is a registered trademark of the Hewlett-Packard Company. PCL is Hewlett-Packard Company’s designation of a set of printer commands (language) and functions included in its printer products. This printer is intended to be compatible with the PCL language. This means the printer recognizes PCL commands used in various application programs, and that the printer emulates the functions corresponding to the commands.

PostScript is a registered trademark of Adobe Systems Incorporated in the United States and/or other countries.

All other trademarks are the property of their respective owners.

AirPrint and the AirPrint logo are trademarks of Apple, Inc.

Noise emission levels

The following measurements were made in accordance with ISO 7779 and reported in conformance with ISO 9296.

Note: Some modes may not apply to your product.

1-meter average sound pressure, dBA	
Printing	One-sided: 54 (mono), 55 (color); Two-sided: 56 (mono), 56 (color)
Scanning	54 (mono); 55 (color)
Copying	57 (mono); 58 (color)
Ready	15

Values are subject to change. See www.lexmark.com for current values.

Static sensitivity notice



This symbol identifies static-sensitive parts. Do not touch the areas near these symbols without first touching a metal surface in an area away from the symbol.

Temperature information

Operating temperature and relative humidity	10 to 32.2°C (50 to 90°F) and 15 to 80% RH 15.3 to 32.2°C (60 to 90°F) and 8 to 15% RH Maximum wet bulb temperature: 22.8°C (73°F)
Shipping temperature	-10 to 40°C (14 to 104°F)
Storage temperature and relative humidity	-10 to 40°C (14 to 104°F) 8 to 80% RH

Laser notice

The printer is certified in the U.S. to conform to the requirements of DHHS 21 CFR, Chapter I, Subchapter J for Class I (1) laser products, and elsewhere is certified as a Class I laser product conforming to the requirements of IEC 60825-1: 2014.

Class I laser products are not considered to be hazardous. The printer contains internally a Class IIIb (3b) AlGaAs laser that is nominally 20 milliwatts operating in the wavelength region of 755–800 nanometers and enclosed in a non-serviceable printhead assembly. The laser system and printer are designed so there is never any human access to laser radiation above a Class I level during normal operation, user maintenance, or prescribed service conditions.

Laser advisory label

A laser notice label may be affixed to this printer as shown:

DANGER - Invisible laser radiation when cartridges are removed and interlock defeated. Avoid exposure to laser beam.

PERIGO - Radiação a laser invisível será liberada se os cartuchos forem removidos e o lacre rompido. Evite a exposição aos feixes de laser.

Opasnost - Nevidljivo lasersko zračenje kada su kasete uklonjene i poništena sigurnosna veza. Izbjegavati izlaganje zracima.

NEBEZPEČÍ - Když jsou vyjmuty kazety a je odblokována pojistka, ze zařízení je vysíláno neviditelné laserové záření. Nevystavujte se působení laserového paprsku.

FARE - Usynlig laserstråling, når patroner fjernes, og spærreanordningen er slået fra. Undgå at blive udsat for laserstrålen.

GEVAAR - Onzichtbare laserstraling wanneer cartridges worden verwijderd en een vergrendeling wordt genegeerd. Voorkom blootstelling aan de laser.

DANGER - Rayonnements laser invisibles lors du retrait des cartouches et du déverrouillage des loquets. Éviter toute exposition au rayon laser.

VAARA - Näkymätöntä lasersäteilyä on varottava, kun värikasetit on poistettu ja lukitus on auki. Vältä lasersäteelle altistumista.

GEFAHR - Unsichtbare Laserstrahlung beim Herausnehmen von Druckkassetten und offener Sicherheitssperre. Laserstrahl meiden.

ΚΙΝΔΥΝΟΣ - Εκκλυση αόρατης ακτινοβολίας laser κατά την αφαίρεση των κασετών και την απασφάλιση της μανδάλωσης. Αποφεύγετε την έκθεση στην ακτινοβολία laser.

VESZÉLY - Nem látható lézersugárzás fordulhat elő a patronok eltávolításakor és a zárószervezet felbontásakor. Kerülje a lézersugárnak való kitettséget.

PERICOLO - Emissione di radiazioni laser invisibili durante la rimozione delle cartucce e del blocco. Evitare l'esposizione al raggio laser.

FARE - Usynlig laserstråling når kassetene tas ut og sperren er satt ut av spill. Unngå eksponering for laserstrålen.

NIEBEZPIECZEŃSTWO - niewidzialne promieniowanie laserowe podczas usuwania kaset i blokady. Należy unikać naświetlenia promieniem lasera.

ОПАСНО! Невидимое лазерное излучение при извлеченных картриджах и снятии блокировки. Избегайте воздействия лазерных лучей.

Pozor - Nebezpečnostvo neviditeľného laserového žiarenia pri odobratých kazetách a odblokovanej poistke. Nevystavujte sa lúčom.

PELIGRO: Se producen radiaciones láser invisibles al extraer los cartuchos con el interbloqueo desactivado. Evite la exposición al haz de láser.

FARA - Osynlig laserstråling när patroner tas ur och spärrmekanismen är upphävd. Undvik exponering för laserstrålen.

危険 - 当移除碳粉盒及互锁失效时会产生看不见的激光辐射, 请避免暴露在激光光束下。

危険 - 移除碳粉匣與安全連續開關失效時會產生看不見的雷射輻射。請避免暴露在雷射光束下。

危険 - カートリッジが取り外され、内部ロックが無効になると、見えないレーザー光が放射されます。このレーザー光に当たらないようにしてください。

Index

A

- activating Voice Guidance 23
- adapter plug 48
- adding contacts 20
- adding groups 21
- adding hardware options
 - print driver 182
- adding internal options
 - print driver 182
- ADF feed roller
 - replacing 94
- ADF pick roller
 - replacing 92
- ADF separator roller
 - replacing 96
- adjusting
 - ADF registration 162
 - scanner registration 161
- adjusting speech rate
 - Voice Guidance 23
- adjusting the brightness
 - printer display 104
- adjusting the brightness of the printer display 104
- adjusting the default headphones volume 59
- adjusting the default speaker volume 59
- adjusting toner darkness 155

AirPrint

- using 30

- answering machine
 - setting up 39
- attaching cables 12
- available internal options 166
- avoiding paper jams 106

B

- blank pages 136
- blocking junk faxes 53

C

- canceling a print job
 - from the computer 33
 - from the printer control panel 33

- cannot open Embedded Web Server 123
- Card Copy
 - setting up 19
- card stock
 - loading 27
- changing port settings
 - internal solutions port 61
- Check tray connection 131
- checking the printer connectivity 124
- checking the status of parts and supplies 67
- cleaning
 - exterior of the printer 62
 - interior of the printer 62
 - scanner 62
- cleaning the printer 62
- collated printing does not work 129
- collating copies 35
- Color Correction
 - manual 155
- Color Correction Content 155
- color quality, troubleshooting
 - print appears tinted 157
- confidential print jobs 32
- configuring
 - fax speaker settings 59
- configuring daylight saving time 51
- configuring e-mail settings 36
- configuring port settings 61
- configuring supply notifications 70
- connecting printer to distinctive ring service 51
- connecting to a wireless network
 - using PIN method 60
 - using Push Button method 60
- conservation settings
 - Eco-Mode 103
 - hibernate mode 103
 - sleep mode 103
- conserving supplies 104
- contacting customer support 165
- contacts
 - adding 20

- deleting 21
- editing 21
- control panel
 - using 14
- copy troubleshooting
 - partial copies of documents or photos 163
 - poor copy quality 163
 - scanner does not respond 164
 - scanner unit does not close 164
- copying
 - creating shortcuts 35
 - on both sides of the paper 34
- copying different paper sizes 34
- copying from
 - selected tray 34
- copying multiple pages
 - onto a single sheet 35
- copying on letterhead 34
- copying photos 34
- creating shortcuts
 - e-mail 37
 - fax destination 52
- customer support
 - contacting 165

D

- date and time
 - fax settings 51
- daylight saving time, configuring 51
- default headphones volume
 - adjusting 59
- default speaker volume
 - adjusting 59
- Defective flash detected 127
- deleting contacts 21
- deleting groups 21
- developer and PC unit combo pack
 - ordering 69
- developer unit
 - ordering 69
 - replacing 70
- different paper sizes, copying 34
- digital subscriber line (DSL)
 - fax setup 43

- digital telephone service
 - fax setup 46
- disposing of printer hard disk 57
- distinctive ring service, fax
 - connecting to 51
- documents, printing
 - from a computer 29
 - from a mobile device 29, 30
- DSL filter 43

E

- Eco-Mode setting 103
- editing contacts 21
- editing groups 21
- emission notices 185
- enabling Magnification mode 23
- enabling personal identification numbers 23
- enabling spoken passwords 23
- enabling the USB port 124
- encrypting the printer hard disk 57
- enlarging copies 35
- envelopes
 - loading 27
- environmental setting
 - Eco-Mode 103
- environmental settings
 - hibernate mode 103
 - sleep mode 103
- erasing printer hard disk memory 56
- exporting a configuration file
 - using the Embedded Web Server 182
- e-mail
 - creating shortcuts 37
 - setting up 36
- e-mailing
 - configuring e-mail settings 36
 - using a shortcut number 36
 - using the address book 36
 - using the printer 36

F

- FAQ about color printing 156
- fax log
 - viewing 53
- fax resolution
 - changing 52

- fax setup
 - country- or region-specific 48
 - digital telephone service 46
 - DSL connection 43
 - standard telephone line
 - connection 39
 - VoIP 44
- fax speaker settings
 - configuring 59
- fax troubleshooting
 - cannot receive faxes 160
 - cannot send faxes 160
 - cannot send or receive faxes 158
 - received fax has poor print quality 161
- faxing
 - adjusting darkness 52
 - blocking junk faxes 53
 - changing resolution 52
 - creating shortcuts 52
 - fax setup 38
 - forwarding faxes 53
 - holding faxes 53
 - setting the date and time 51
 - viewing a fax log 53
- finding more information about the printer 9
- firmware
 - update 183
- firmware card 166
- flash drive
 - printing from 30
 - scanning to 54
- font sample list
 - printing 33
- forms
 - printing 29
- Forms and Favorites
 - setting up 19
- forwarding faxes 53
- FTP address
 - creating shortcuts 54
- FTP server, scanning to
 - using the control panel 54
- fuser
 - replacing 72

G

- Google Cloud Print
 - using 29

- green settings
 - Eco-Mode 103
 - hibernate mode 103
 - sleep mode 103
- groups
 - adding 21
 - deleting 21
 - editing 21

H

- hardware options
 - installing 175
- hardware options, adding
 - print driver 182
- headphones
 - default volume 59
- held jobs 32
 - printing from a Macintosh computer 32
 - printing from Windows 32
- held print jobs
 - printing from a Macintosh computer 32
 - printing from Windows 32
- hibernate mode
 - setting 103
- holding faxes 53
- home screen
 - customizing 19
 - showing icons 19
- home screen icons
 - using 15
- horizontal dark lines 140

I

- icons on the home screen
 - showing 19
- imaging unit
 - replacing 77
- importing a configuration file
 - using the Embedded Web Server 182
- indicator light
 - printer status 15
- installing a memory card 166
- installing a printer hard disk 172
- installing an internal solutions port 167
- installing an optional card 171
- installing optional trays 175

- installing options
 - internal solutions port 167
 - printer hard disk 172
- installing the keyboard tray 180
- installing the printer software 182
- installing the staple finisher 177
- internal options 166
 - installing 171
 - memory card 166
- internal options, adding
 - print driver 182
- internal solutions port
 - installing 167
 - troubleshooting 126

J

- jam, clearing
 - automatic document feeder 111
 - duplex unit 113
 - finisher bin 117
 - fuser 113
 - multipurpose feeder 109
 - standard bin 113
 - staple cartridge 119
 - trays 108

Jams

- avoiding 106
- locating jam areas 107
- locations 107

K

- keyboard on the display
 - using 24
- keyboard tray
 - installing 180

L

- letterhead
 - copying on 34
- Lexmark Mobile Print
 - using 29
- line filter 43
- linking trays 28
- loading
 - card stock 27
 - envelopes 25
 - transparencies 27
 - trays 25
- loading envelopes
 - multipurpose feeder 27

- loading paper
 - multipurpose feeder 27
- locating the security slot 56

M

- Magnification mode
 - enabling 23
- making copies 34
- manual Color Correction
 - applying 155
- memory
 - types installed on printer 57
- memory card 166
 - installing 166
- menu map 16
- menu settings page
 - printing 18
- mobile device
 - printing from 29, 30
- Mopria Print Service
 - using 30
- moving the printer 10, 102
- multipurpose feeder
 - loading 27

N

- navigating the screen
 - using gestures 24
- navigating the screen using gestures 24
- noise emission levels 185
- Non-Lexmark supply 128
- non-volatile memory 57
 - erasing 56
- Not enough free space in flash memory for resources 127
- notices 185, 186

O

- optional card
 - installing 171
- optional trays
 - installing 175
- options
 - firmware cards 166
 - memory card 166
- ordering
 - developer and PC unit combo pack 69
 - developer unit 69
 - photoconductor unit 69

- ordering supplies
 - staple cartridges 69
 - waste toner bottle 70
- ordering toner cartridges 67

P

- paper
 - Universal size setting 25
- paper jam in door B 113
- paper jam in the automatic document feeder 111
- paper jam in the finisher bin 117
- paper jam in the multipurpose feeder 109
- paper jam in the standard bin 113
- paper jam in trays 108
- paper jam, clearing
 - automatic document feeder 111
 - duplex unit 113
 - finisher bin 117
 - fuser 113
 - multipurpose feeder 109
 - standard bin 113
 - trays 108
- paper jams
 - avoiding 106
- paper size
 - setting 25
- paper type
 - setting 25
- parallel interface card
 - troubleshooting 126
- parts status
 - checking 67
- personal identification number method 60
- personal identification numbers
 - enabling 23
- phone splitter 44
- photoconductor unit
 - ordering 69
 - replacing 74
- photos
 - copying 34
- pick roller
 - replacing 80
- placing separator sheets
 - between copies
 - copying 35
- port settings
 - configuring 61

- power button light
 - printer status 15
 - print driver
 - hardware options, adding 182
 - print job
 - canceling from the
 - computer 33
 - canceling from the printer control panel 33
 - print quality
 - cleaning the scanner 62
 - print quality troubleshooting
 - blank pages 136
 - crooked print 146
 - dark print 137
 - ghost images appear on prints 139
 - gray background 139
 - horizontal dark lines 140
 - horizontal white lines 141
 - jagged or uneven characters 143
 - light print 144
 - mottled print and dots 145
 - repeating print defects 147
 - skewed print 146
 - solid color or black images 148
 - text or images cut off 149
 - toner easily rubs off 150
 - uneven print density 150
 - vertical dark lines or streaks appear on prints 151
 - white lines 152
 - white pages 136
 - print troubleshooting
 - confidential and other held documents do not print 133
 - envelope seals when printing 129
 - incorrect margins on prints 142
 - jammed pages are not reprinted 132
 - job prints from the wrong tray 154
 - job prints on the wrong paper 154
 - paper curl 130
 - paper frequently jams 132
 - print jobs do not print 135
 - slow printing 134
 - tray linking does not work 130
 - unable to read flash drive 124
 - printer
 - fully configured 11
 - minimum clearances 10
 - moving 10
 - selecting a location 10
 - shipping 103
 - printer configurations 11
 - printer display
 - adjusting the brightness 104
 - printer hard disk
 - disposing of 57
 - encrypting 57
 - printer hard disk encryption 57
 - printer hard disk memory
 - erasing 56
 - printer information
 - finding 9
 - printer is not responding 153
 - printer menus 16
 - printer messages
 - Check tray connection 131
 - Defective flash detected 127
 - Non-Lexmark supply 128
 - Not enough free space in flash memory for resources 127
 - Replace cartridge, printer region mismatch 127
 - Scanner maintenance required, use ADF Kit 128
 - Unformatted flash detected 127
 - printer options troubleshooting
 - internal option is not detected 125
 - internal solutions port 126
 - parallel interface card 126
 - serial interface card 126
 - printer ports 12
 - printer settings
 - restoring to factory defaults 57
 - printer software, installing 182
 - printing
 - font sample list 33
 - from a computer 29
 - from a flash drive 30
 - menu settings page 18
 - printing a font sample list 33
 - printing a menu settings page 18
 - printing a network setup page 124
 - printing forms 29
 - printing from a computer 29
 - printing from a flash drive 30
 - printing held jobs
 - from a Macintosh computer 32
 - from Windows 32
 - Push Button method 60
- ## R
- recycling
 - Lexmark packaging 104
 - Lexmark products 104
 - toner cartridges 105
 - reducing copies 35
 - repeat print jobs 32
 - printing from a Macintosh computer 32
 - printing from Windows 32
 - repeating print defects 147
 - Replace cartridge, printer region mismatch 127
 - replacing
 - transfer belt 87
 - replacing a developer unit 70
 - replacing a photoconductor unit 74
 - replacing a toner cartridge 79
 - replacing an imaging unit 77
 - replacing parts
 - ADF feed roller 94
 - ADF pick roller 92
 - ADF separator roller 96
 - pick roller 80
 - separator pad 85
 - replacing supplies
 - staple cartridge 97
 - staple cartridge holder 99
 - waste toner bottle 86
 - replacing the ADF feed roller 94
 - replacing the ADF pick roller 92
 - replacing the ADF separator roller 96
 - replacing the fuser 72
 - replacing the pick roller 80
 - replacing the separator pad 85
 - replacing the staple cartridge holder in the staple finisher 99
 - replacing the staple cartridge in the staple finisher 97
 - replacing the transfer belt 87
 - replacing the waste toner bottle 86
 - replacing transfer roller 90

- reserve print jobs
 - printing from a Macintosh computer 32
 - printing from Windows 32
- resetting
 - supply usage counters 128
- resetting the supply usage counters 128
- restoring factory default settings 57
- RJ11 adapter 48

S

- safety information 7, 8
- saving paper 35
- saving toner 35
- Scan Center
 - setting up 20
- Scan to Computer
 - setting up 55
- scan troubleshooting
 - cannot scan from a computer 162
 - partial copies of documents or photos 163
 - poor copy quality 163
 - scan job was not successful 163
 - scanner does not respond 164
 - scanner unit does not close 164
 - scanning freezes the computer 164
 - scanning takes too long 164
- scanner
 - cleaning 62
- Scanner maintenance required, use ADF Kit 128
- scanning
 - to an FTP server 54
 - scanning to a computer 55
 - scanning to a flash drive 54
 - scanning to an FTP server
 - using the control panel 54
- scheduling a fax 52
- security slot
 - locating 56
- selecting a location for the printer 10
- sending a fax
 - scheduled 52
 - using the computer 51
 - using the control panel 51
- sending an e-mail 36

- separator pad
 - replacing 85
- serial interface card
 - troubleshooting 126
- serial printing
 - setting up 61
- setting hibernate mode 103
- setting sleep mode 103
- setting the paper size 25
- setting the paper type 25
- setting the Universal paper size 25
- setting up e-mail function 36
- setting up fax
 - country- or region-specific 48
 - digital telephone service 46
 - DSL connection 43
 - standard telephone line connection 39
 - VoIP connection 44
- setting up fax function 38
- setting up serial printing 61
- shipping the printer 103
- Shortcut Center
 - using 20
- shortcuts, creating
 - copy screen 35
 - FTP address 54
- showing icons on the home screen 19
- speaker
 - default volume 59
- spoken passwords
 - enabling 23
- staple cartridge
 - replacing 97
- staple cartridge holder
 - replacing 99
- staple cartridges
 - ordering 69
- staple jam in door G 119
- staple jam, clearing
 - door G 119
- statement of volatility 57
- storing
 - supplies 102
- storing print jobs 32
- supplies
 - conserving 104
 - storing 102
- supplies status
 - checking 67

- supplies, ordering
 - developer unit 69
 - photoconductor unit 69
 - staple cartridges 69
 - toner cartridges 67
 - waste toner bottle 70
- supply notifications
 - configuring 70
- supply usage counters
 - resetting 128
- supported file types 31
- supported flash drives 31

T

- toner cartridge
 - replacing 79
- toner cartridges
 - ordering 67
 - recycling 105
- toner darkness
 - adjusting 155
- transfer belt
 - replacing 87
- transfer roller
 - replacing 90
- transparencies
 - loading 27
- trays
 - linking 28
 - loading 25
 - unlinking 28
- troubleshooting
 - cannot open Embedded Web Server 123
 - FAQ about color printing 156
 - printer is not responding 153
 - troubleshooting, color quality
 - print appears tinted 157
 - troubleshooting, copy
 - partial copies of documents or photos 163
 - poor copy quality 163
 - scanner does not respond 164
 - scanner unit does not close 164
 - troubleshooting, fax
 - cannot receive faxes 160
 - cannot send faxes 160
 - cannot send or receive faxes 158
 - received fax has poor print quality 161

- troubleshooting, print
 - collated printing does not work 129
 - confidential and other held documents do not print 133
 - envelope seals when printing 129
 - incorrect margins on prints 142
 - jammed pages are not reprinted 132
 - job prints from the wrong tray 154
 - job prints on the wrong paper 154
 - paper curl 130
 - paper frequently jams 132
 - print jobs do not print 135
 - slow printing 134
 - tray linking does not work 130
- troubleshooting, print quality
 - blank pages 136
 - crooked print 146
 - dark print 137
 - ghost images appear on prints 139
 - gray background 139
 - horizontal dark lines 140
 - horizontal white lines 141
 - jagged or uneven characters 143
 - light print 144
 - mottled print and dots 145
 - repeating print defects 147
 - skewed print 146
 - solid color or black images 148
 - text or images cut off 149
 - toner easily rubs off 150
 - uneven print density 150
 - vertical dark lines or streaks appear on prints 151
 - white lines on a page 152
 - white pages 136
- troubleshooting, printer options
 - internal option is not detected 125
 - internal solutions port 126
- troubleshooting, scan
 - cannot scan from a computer 162
 - partial copies of documents or photos 163
 - poor copy quality 163
 - scan job was not successful 163
 - scanner does not respond 164
 - scanner unit does not close 164
 - two-sided copying 34
- U**
 - unable to read flash drive
 - troubleshooting, print 124
 - understanding the status of the power button and indicator light 15
 - uneven print density 150
 - Unformatted flash detected 127
 - Universal paper size setting 25
 - unlinking trays 28
 - updating firmware
 - flash file 183
 - USB port
 - enabling 124
 - using
 - genuine Lexmark parts 67
 - genuine Lexmark supplies 67
 - using the ADF
 - copying 34
 - using the control panel 14
 - using the home screen 15
 - using the keyboard on the display 24
 - using the scanner glass
 - copying 34
- V**
 - verify print jobs 32
 - printing from a Macintosh computer 32
 - printing from Windows 32
 - vertical dark lines or streaks appear on prints 151
 - vertical white lines appear 152
 - viewing a fax log 53
 - Voice Guidance
 - activating 23
 - speech rate 23
 - Voice Guidance speech rate
 - adjusting 23
 - voice mail
 - setting up 39
 - voice over Internet Protocol (VoIP)
 - fax setup 44
- VoIP adapter 44
- volatile memory 57
 - erasing 56
- volatility
 - statement of 57
- W**
 - waste toner bottle
 - ordering 70
 - replacing 86
 - white lines appear 152
 - white pages 136
 - wireless network
 - Wi-Fi Protected Setup 60
 - Wi-Fi Protected Setup
 - wireless network 60