

L10

Enterprise Tablet



User Guide for Android™ 10



ZEBRA

Copyright

ZEBRA and the stylized Zebra head are trademarks of Zebra Technologies Corporation, registered in many jurisdictions worldwide. Google, Android, Google Play and other marks are trademarks of Google LLC; All other trademarks are the property of their respective owners. ©2020 Zebra Technologies Corporation and/or its affiliates. All rights reserved.

COPYRIGHTS & TRADEMARKS: For complete copyright and trademark information, go to zebra.com/copyright.

WARRANTY: For complete warranty information, go to zebra.com/warranty.

END USER LICENSE AGREEMENT: For complete EULA information, go to zebra.com/eula.

Terms of Use

- Proprietary Statement

This manual contains proprietary information of Zebra Technologies Corporation and its subsidiaries ("Zebra Technologies"). It is intended solely for the information and use of parties operating and maintaining the equipment described herein. Such proprietary information may not be used, reproduced, or disclosed to any other parties for any other purpose without the express, written permission of Zebra Technologies.

- Product Improvements

Continuous improvement of products is a policy of Zebra Technologies. All specifications and designs are subject to change without notice.

- Liability Disclaimer

Zebra Technologies takes steps to ensure that its published Engineering specifications and manuals are correct; however, errors do occur. Zebra Technologies reserves the right to correct any such errors and disclaims liability resulting therefrom.

- Limitation of Liability

In no event shall Zebra Technologies or anyone else involved in the creation, production, or delivery of the accompanying product (including hardware and software) be liable for any damages whatsoever (including, without limitation, consequential damages including loss of business profits, business interruption, or loss of business information) arising out of the use of, the results of use of, or inability to use such product, even if Zebra Technologies has been advised of the possibility of such damages. Some jurisdictions do not allow the exclusion or limitation of incidental or consequential damages, so the above limitation or exclusion may not apply to you.

Revision History

Changes to the original guide are listed below:

Change	Date	Description
01EN Rev. A	09/2020	Initial release
02EN Rev. A	11/2020	Correct app list.
03EN Rev.A	12/2020	Correct Charge LED blinking color on page 23.

Table of Contents

Copyright.....	2
Terms of Use.....	2
Revision History	2
About this Guide.....	11
L10 Configurations	11
Key Features Overview.....	11
Optional Features.....	12
Notational Conventions	12
Icon Conventions	12
Service Information	13
Determining Software Versions.....	13
Determining the Serial Number.....	14
Getting Started.....	15
Unpacking the Tablet	15
Overview of the XSLATE Tablet	16
XSLATE Front View.....	16
Overview of the XPAD Tablet	19
XPAD Front View.....	19
XPAD Back View	20
XPAD Left Side.....	21
XPAD Right Side	21
XPAD Top View.....	22
Preparing the Tablet for First Use	22
Inserting a SIM Card.....	22
Powering Up the Tablet	23
Pens for the L10 Tablets.....	24
Capacitive Pens.....	24
Active Digitizer Pens.....	24

Table of Contents

Optional Setup Tasks	25
Attaching the Pen Tether	25
Connecting the Tablet to an External Monitor	25
Back of Battery Charge Indicators	25
Removing and Replacing the Battery	26
Removing the Battery	26
Replacing the Battery	27
Hot Swapping the Battery	27
Using the Device	28
Home Screen	28
Setting Home Screen Rotation	29
Status Bar	29
Notification Icons	30
Status Icons	31
Managing Notifications	32
Opening the Quick Access Panel	33
Quick Access Panel Icons	33
Editing Icons on the Quick Settings Bar	34
Battery Management	34
Checking Battery Status	34
Monitoring Battery Usage	35
Low Battery Notification	35
Interactive Sensor Technology	35
Waking the Device	36
USB Communication	36
Transferring Files	36
Transferring Photos	36
Disconnect from the Host Computer	37
Applications	38
Accessing Apps	41
Switching Between Recent Apps	41
Battery Manager	42
Opening Battery Manager	42
Battery Manager Information Tab	42
Battery Manager Swap Tab	44
Camera	45
Taking Photos	45
Taking a Panoramic Photo	46
Recording Videos	46

Table of Contents

Photo Settings	47
Rear Camera Photo Settings	47
Front Camera Photo Settings.....	48
Video Settings	49
Rear Camera Video Settings	49
Front Camera Video Settings.....	50
DataWedge Demonstration.....	50
Scanner Selection	51
PTT Express Voice Client.....	52
PTT Express User Interface	52
PTT Audible Indicators	53
PTT Notification Icons	53
Enabling PTT Communication.....	53
Selecting a Talk Group.....	54
PTT Communication.....	54
Creating a Group Call	54
Responding with a Private Response	54
Disabling PTT Communication	54
RxLogger.....	55
RxLogger Configuration.....	55
Configuration File	55
Enabling Logging.....	55
Disabling Logging	55
Extracting Log Files	55
Backing Up	55
RxLogger Utility	56
Initiating the Main Chat Head.....	56
Removing the Main Chat Head	56
Viewing Logs.....	56
Removing a Sub Chat Head Icon.....	56
Backing Up In Overlay View.....	56
Sound Recorder	56
Settings.....	58
Accessing Settings.....	58
Display Settings	58
Setting the Screen Brightness Manually.....	58
Setting the Screen Brightness Automatically.....	58
Setting Night Light	58
Setting Screen Rotation.....	59
Setting Screen Timeout	59
Lock Screen Display.....	59

Table of Contents

Setting Font Size	60
Notification LED Brightness Level	60
Touch Panel Mode	60
Setting the Date and Time	61
General Sound Setting.....	61
Sound Options.....	61
Remapping a Button	62
Keyboards.....	62
Keyboard Configuration.....	63
Enabling Keyboards.....	63
Switching Between Keyboards.....	63
Using the Android and Gboard Keyboards.....	63
Edit Text.....	63
Entering Numbers, Symbols, and Special Characters.....	63
Using the Enterprise Keyboard.....	63
Numeric Tab.....	64
Alpha Tab.....	64
Additional Character Tab	64
Scan Tab.....	64
Language Usage.....	64
Changing the Language Setting.....	64
Adding Words to the Dictionary	64
Notifications.....	65
Setting App Notifications	65
Viewing Notification Settings for All Apps	65
Controlling Lock Screen Notifications	65
Blink Light.....	66
Wireless.....	67
Wireless Wide Area Networks.....	67
Sharing the Mobile Data Connection.....	67
Enabling USB Tethering.....	67
Enabling Bluetooth Tethering.....	68
Enabling Wi-Fi Hotspot	68
Configuring the Wi-Fi Hotspot.....	68
Data Usage.....	69
Setting Data Usage Warning.....	69
Setting Data Limit.....	69
Cellular Network Settings	70
Data When Roaming.....	70
Setting Preferred Network.....	70
Using Search for MicroCell	70
Configuring the Access Point Name	70

Table of Contents

Locking the SIM Card.....	71
Default SIM Slot Configuration.....	71
Dual SIM Dual Standby.....	71
Wireless Local Area Networks	72
Connecting to a Wi-Fi Network.....	72
Removing a Wi-Fi Network.....	73
WLAN Configuration	73
Configuring a Secure Wi-Fi Network	73
Manually Adding a Wi-Fi Network	74
Configuring for a Proxy Server	75
Configuring the Device to Use a Static IP Address	76
Wi-Fi Preferences.....	76
Additional Wi-Fi Settings	76
Wi-Fi Direct.....	77
Bluetooth.....	77
Adaptive Frequency Hopping	78
Security.....	78
Bluetooth Profiles	79
Bluetooth Power States	80
Bluetooth Radio Power.....	80
Enabling Bluetooth.....	80
Disabling Bluetooth	80
Discovering Bluetooth Device(s)	80
Changing the Bluetooth Name	81
Connecting to a Bluetooth Device	81
Selecting Profiles on the Bluetooth Device.....	81
Unpairing a Bluetooth Device	81
Cast.....	82
Near Field Communications.....	82
Reading NFC Cards	82
Enterprise NFC Settings.....	83
Data Capture	84
Operational Modes	84
Scanning Considerations	84
Range	85
Angle	85
Imaging.....	85
Integrated Barcode Scanner (XPAD Only).....	86
RS507/RS507X Hands-Free Imager.....	86
RS5100 Ring Scanner	86

Table of Contents

RS6000 Bluetooth Ring Scanner	87
DS3608 Digital Scanner	87
Scanning with the Barcode Scanner (XPAD Only)	88
Scanning with RS507/RS507X Hands-Free Imager	89
Scanning with RS5100 Ring Scanner	90
Scanning with RS6000 Bluetooth Ring Scanner	91
Scanning with the DS3608 Scanner	92
Pairing the RS507/RS5100/RS6000 Ring Scanner	93
Pairing Using Simple Serial Interface (SSI)	93
Pairing Using Bluetooth Human Interface Device	94
Pairing a Bluetooth Scanner	95
Pairing Using Simple Serial Interface	95
Pairing Using Bluetooth Human Interface Device	95
Connecting a USB Scanner	96
Connecting Using Simple Serial Interface	96
Connecting Using HID Mode	96
DataWedge	96
Enabling DataWedge	97
Disabling DataWedge	97
Supported Decoders	97
Accessories	100
Application Deployment	106
Security	106
Secure Certificates	106
Installing a Secure Certificate	106
Configuring Credential Storage Settings	107
Development Tools	107
Android Application Development	107
Development Workstation	107
Enabling Developer Options	107
EMDK for Android	108
StageNow	108
GMS Restricted	108
ADB USB Setup	108
Enabling USB Debugging	108
Application Installation	109
Installing Applications Using a USB Drive	109
Installing Applications Using the USB Connection	110

Table of Contents

Installing Applications Using the Android Debug Bridge	110
Uninstalling an Application	112
Performing a System Update	112
Downloading the System Update Package	112
Performing a System Update Using USB Drive	112
Performing a System Update Using ADB	113
Verifying System Update Installation	114
Enterprise Reset	114
Performing an Enterprise Reset From Device Settings	114
Downloading the Enterprise Reset Package	114
Performing an Enterprise Reset Using ADB	115
Performing a Factory Reset	116
Downloading the Factory Reset Package	116
Performing a Factory Reset Using ADB	117
Storage	118
Random Access Memory	118
Viewing Memory	118
Internal Storage	118
Viewing Internal Storage	118
External Storage	119
Viewing External Storage	119
Formatting a USB Drive as Portable Storage	119
Enterprise Folder	119
Managing Apps	119
App Details	119
Managing Downloads	120
Maintenance and Troubleshooting	121
Introduction	121
Maintaining the L10	121
Operating the Tablet in Cold Ambient Temperatures	121
Battery Safety Guidelines	122
Long-term Battery Storage	122
Disposing of Used Batteries	123
Cleaning	123
Materials Required for Cleaning	123
Cleaning the L10	123
Housing	123
Display	123
Power Connector	123
Cleaning the Cradle Connector	124
Caring for the Display	124

Table of Contents

Caring for the Pen	124
Traveling with the Tablet	125
Troubleshooting	126
Restarting the L10	126
Soft Reset	126
Hard Reset	126
Specifications	128
Index	132

About this Guide

This guide provides information about using the L10 tablet and accessories.



NOTE: Screens and windows pictured in this guide are samples and can differ from actual screens.

L10 Configurations

There are three models in the L10 platform. Each is different from the other two as follows:

- XPAD is distinguished by its integrated hard handle. The handle has space for an integrated barcode reader option, two programmable buttons and a front facing speaker.
- XSLATE has no handle but is otherwise like the XPAD.
- XBOOK is the same as the XSLATE, but includes a companion keyboard and a KickStrap (combination of a kickstand and a hand strap).



IMPORTANT: For all important safety information about the tablet, refer to the L10 Regulatory Guide.

Key Features Overview

The L10 platform is a rugged tablet that provides a range of computing power and a variety of integrated features to support any mobile work flow. The L10 supports the following features:

- Qualcomm SDM660 Platform (CPU).
- 4 or 8 GB of system memory (RAM)
- 64 GB – 128 GB memory storage Adreno 512 graphics processor (GPU)
- 10.1” wide viewing angle display with WUXGA resolution (1920 x 1200); 500 Nit brightness standard, option for 1000 Nit View Anywhere® display for viewing in bright sunlight.
- Capacitive display with 10-point touch input There are three touch modes in **Settings > Display > Advanced > Touch panel mode**:
 - Finger and Wet
 - Finger and Glove
 - Finger and Passive Stylus (default)
- Corning Gorilla Glass 3 for increased display damage resistance; Capacitive Touch Panel with Multi-Touch operation with optional Active Digitizer

- Integrated 13 MP rear camera and 5 MP front camera
- Two USB 2.0 Type A ports, one USB Type-C port, and a microSD card slot
- Dual Nano SIM (4FF) port
- 9-Axis MEMS sensor (Accelerometer, eCompass, Gyroscope) and ambient light sensor
- Hot-swappable battery, 36 Whr standard battery or 98 Whr long-life battery packs
- Integrated 802.11a/g/n/ac, MuMIMO Wi-Fi, Bluetooth 5.0
- Android 10 operating system
- Integrated high-frequency NFC.

Optional Features

The following features are optional and must be ordered with the tablet at the time of purchase:

- A high-performance barcode scanner is available and is integrated into the handle of the XPAD tablet.
- Integrated, active Wacom-digitizer display that provides precision pen input and hover features

See also [Input Devices: Optional Modules on page 103](#). The items in that section must be ordered at time of purchase because they must be factory installed.

Notational Conventions

Notational conventions are used to highlight important information.

- **Bold** text is used to highlight the following:
 - Dialog box, window and screen names
 - Drop-down list and list box names
 - Check box and radio button names
 - Icons on a screen
 - Key names on a keypad
 - Button names on a screen.
- Bullets (•) indicate:
 - Action items
 - Lists of alternatives
 - Lists of required steps that are not necessarily sequential.
- Sequential lists (for example, those that describe step-by-step procedures) appear as numbered lists.

Icon Conventions

The following icons are used throughout the document. The icons and their associated meanings are described below.



NOTE: The text here indicates information that is supplemental for the user to know and that is not required to complete a task.



IMPORTANT: The text here indicates information that is important for the user to know.



CAUTION: If the precaution is not heeded, the user could receive minor or moderate injury.



WARNING: If danger is not avoided, the user CAN be seriously injured or killed.



DANGER: If danger is not avoided, the user WILL be seriously injured or killed.

Service Information

If you have a problem with your equipment, contact Customer Support for your region. Contact information is available at: zebra.com/support.

When contacting support, please have the following information available:

- Serial number of the unit (found on manufacturing label)
- Model number or product name (found on manufacturing label)
- Software type and version number
- IMEI number

Customer Support responds to calls by email or telephone within the time limits set forth in support agreements.

If the problem cannot be solved by Customer Support, the user may need to return the equipment for servicing and will be given specific directions. We are not responsible for any damages incurred during shipment if the approved shipping container is not used. Shipping the units improperly can possibly void the warranty. Remove the SIM card and/or microSD card from the device before shipping for service.

If the device was purchased from a business partner, contact that business partner for support.

Determining Software Versions

Before contacting Customer Support, determine the current software version on your device.

1. Swipe down from the Status bar with two fingers to open the Quick Access panel, and then touch .
2. Touch **Aboutphone**.
3. Scroll to view the following information:
 - **Battery information**
 - **SW components**
 - **Legal information**
 - **Model & hardware**
 - **Android version**
 - **Android security patch level**
 - **Android security patch version**
 - Baseband version
 - **Kernel version**

- **Build number**

To determine the device IMEI information (WWAN only), touch **About phone > IMEI**.

- **IMEI** - Displays the IMEI number for the device.
- **IMEI SV** - Displays the IMEI SV number for the device.

Determining the Serial Number

Before contacting Customer Support, determine the serial number of your device.

Touch **About phone > Model & hardware > Serial number**.

Getting Started

This section explains how to set up the L10 device for the first time.

Unpacking the Tablet

Carefully remove all protective material from around the L10 and save the shipping container for later storage and shipping.

Verify that you received all equipment listed below:

- Tablet with lithium-ion battery
- Regulatory Guide
- Stylus
- Power supply.

Inspect the equipment for damage. If you are missing any equipment or if you find any damaged equipment, contact the Zebra Support Center immediately. See [Service Information on page 13](#) for support information.

Overview of the XSLATE Tablet

The following photos show the location of the external features on the XSLATE tablet. Most of these features are on the XPAD tablet in the same place, except for the handle of the XPAD tablet.

XSLATE Front View

Figure 1 XSLATE Front View



1	Two digital microphones make up the microphone array facing forward.
2	The ambient light sensor (ALS) detects the amount of ambient light, and the device adjusts the screen brightness.
3	The front 5-megapixel camera has FHD resolution if enabled in the settings. You can adjust size and quality of picture.
4	The Power LED indicates the current power state of the tablet.
5	The Battery LED indicates the charging status of the battery.
6	The Reset switch lets you force the tablet to power down.
7	The touchscreen is the standard means for interacting with the operating system and software.
8	The Home button displays the Home screen.

Figure 2 XSLATE Back View



1	The pen holder holds the short, capacitive pen when not in use.
2	The battery latch releases the battery when you slide the latch to the left.
3	This light is a flash for the rear camera and can be used as a flashlight.
4	The rear 13-megapixel camera has Full HD resolution.
5	The Kensington lock slot is a metal-reinforced hole for use with a cable and lock to secure the tablet.
6	Near Field Communication (NFC) allows devices to exchange information by placing them next to one another.
7	The expansion port cover is removed when connecting certain optional accessories to the tablet.
8	This speaker provides sound when no headset or external speakers are in use.
9	The battery powers the tablet when it is not plugged in or docked.

Figure 3 XSLATE Right Side



1	Power input connection for the external power adapter
2	Ethernet jack RJ45 port for LAN connectivity
3	Volume control button
4	The round button is a toggle between screen-rotation lock and auto-rotation of the screen.
5	The oval Power button turns on the tablet. When the tablet is on, press to enter and exit sleep mode.

Figure 4 XSLATE Left View

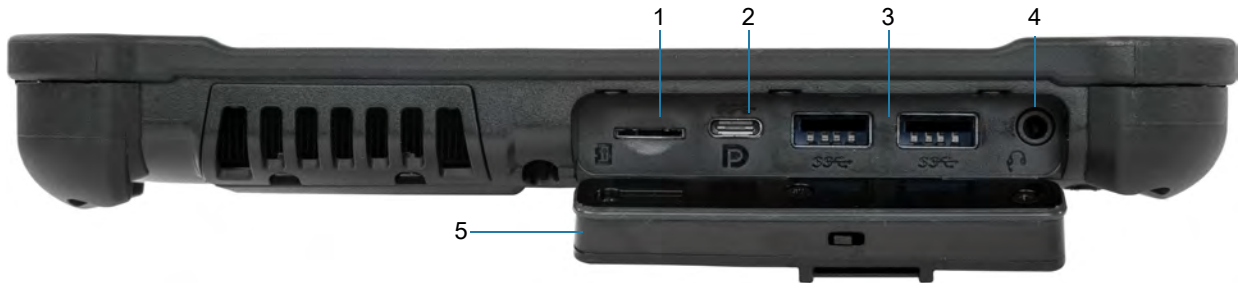

1	The memory card slot reads and writes microSD cards.
2	The USB type-C port provides access to USB 3.1 and DisplayPort output through a type-C connector.
3	Two USB 2.0 type-A ports let you connect devices such as a mouse, keyboard, or external storage.
4	The 3.5 mm audio jack supports stereo output for headset and mono input for an external microphone.
5	This locking door covers the ports on the L10. When the tablet is shipped, the door is locked and the latch shows green. Slide the lock to reveal red and open the door to access the ports. To secure the door for travel or storage, close it firmly and slide the lock until the green appears.

Figure 5 XSLATE and XPAD Bottom View



1	The docking connectors interface to docks.
---	--

Overview of the XPAD Tablet

The following photos show the locations of the external features on the XPAD tablet. In these photos, most of the features are the same on the XSLATE as on the XPAD. Most of the differences are in the handle.

XPAD Front View

Figure 6 XPAD Front View



1	Two digital microphones make up the microphone array facing forward.
2	Programmable function buttons, P1 and P2.
3	The ALS detects the amount of light, and adjusts the screen brightness.
4	Pen holder for the long pen, built in to the handle of the XPAD.
5	The 5-megapixel camera has Full HD resolution.
6	The built-in speaker provides sound when no headset or external speakers are in use.
7	The Power LED indicates the current power state of the tablet
8	The Battery LED indicates the charging status of the battery.
9	The Reset switch lets you force the tablet to shut down, in case nothing else works.
10	The touchscreen is the standard means for interacting with the operating system and software.
11	The Home button displays the Home screen.

XPAD Back View

Figure 7 XPAD Back View

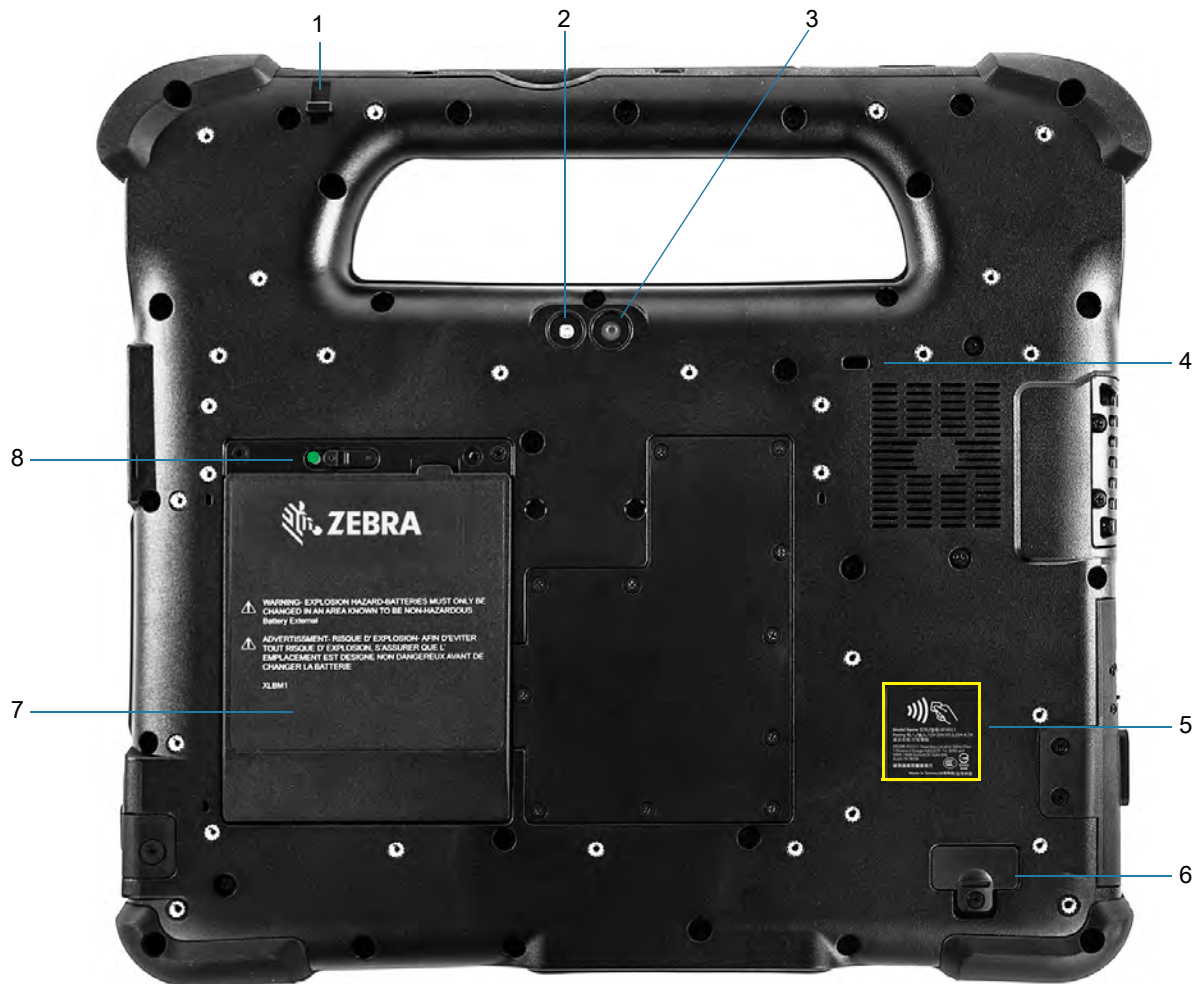

1	The tether post for a pen secures the pen to the tablet by a tether.
2	The camera light functions as a flash for the rear camera as well as a torch light.
3	The rear 13-megapixel camera has Full HD resolution.
4	The Kensington lock slot is a metal-reinforced hole for use with a cable and lock to secure the tablet.
5	NFC is an optional technology that lets devices exchange information.
6	The expansion port cover is removed when connecting certain optional accessories to the tablet.
7	The hot-swappable battery powers the tablet when it is not plugged in or docked.
8	The battery latch releases the battery when you slide the latch to the left.

XPAD Left Side

Figure 8 XPAD Left Side



1	The barcode scanner is the built-in optical interface for reading barcodes.
2	The memory card slot reads and writes microSD cards.
3	The USB type-C port provides access to USB 3.1 and DisplayPort output through a type-C connector.
4	Two USB 2.0 ports (type-A) let you connect devices, such as a mouse, keyboard, or external storage.
5	The 3.5 mm audio jack supports stereo output for headset and mono input for an external microphone.
6	This locking door covers the ports on the L10. When the tablet is shipped, the door is locked and shows green. Slide the lock to reveal red and open it.

XPAD Right Side

Figure 9 XPAD Right Side



1	Power input connection for the external power adapter.
2	Ethernet jack RJ45 port for LAN connectivity.
3	Volume control button.
4	The round button is a toggle between screen-rotation lock and auto-rotation of the screen.
5	The oval Power button turns on the tablet. When the tablet is on, press to enter or exit sleep mode.

XPAD Top View

Figure 10 XPAD Top View



1	Use the pen holder in the handle to hold the long pen when it is not in use.
2	Press the scanner button to activate the barcode scanner (if installed).

Preparing the Tablet for First Use

The following sections explain how to insert a SIM card and power up the tablet.

Inserting a SIM Card



CAUTION: Before you can connect to a mobile broadband network, you must have an active account with a cellular network provider, and a SIM card in your tablet for mobile broadband access. This SIM card works like the SIM card in your cell phone that connects you to a network provider.

The SIM card holder accommodates two Nano SIM (4FF) cards, for use with the mobile broadband option. If inserting only one SIM card, place it in the holder labeled **SIM1**. If inserting two SIM cards, put the card for the primary carrier in **SIM1** and the card for the secondary carrier in **SIM2**.

1. Turn off the tablet.
2. If you have already put the battery in the tablet, remove it.
The SIM card(s) fit into a tray in the battery bay.
3. Find and gently remove the SIM holder tray so the slot is empty.
4. Place the SIM card into the holder so that it is close to flush with the holder. Make sure that the SIM contacts (gold) are facing down and the notched corner is on the right side as shown in this drawing and in the graphic inside the battery bay of the tablet.

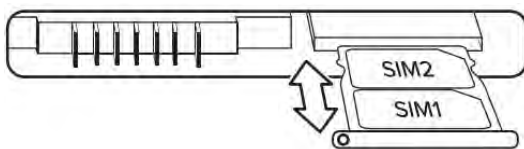

5. Carefully align the SIM holder with the opening of the SIM holder connector. Gently slide the SIM holder tray into the connector until it stops.



6. Install the battery in the tablet. See [Replacing the Battery on page 27](#).

Powering Up the Tablet

This section explains installing the battery, connecting the tablet to external power, and powering up the tablet.

1. If you have not yet inserted the battery, remove it from the packaging. On the back of the tablet, insert the bottom of the battery into the bay. Tilt the tray as shown and press it down until it clicks securely into place.



2. The external power has two parts: the part that plugs into the power source and the adapter with a cord that plugs into your tablet. Join the two parts by plugging the power cord into the adapter to form one long cord.

To connect external power to the tablet, open the port door to expose the power adapter port. Plug the AC adapter into this port on your tablet.



1	Power adapter port.
---	---------------------

1. Plug the power cord into an outlet.

The battery charging indicator on the front of the L10 tablet blinks amber to indicate that the battery is charging. It is solid green when fully charged.

2. Press and release the oval **Power** button in the center of the right side of the tablet to turn it on.



1	Power button
---	--------------

3. Keep the tablet on AC power until the battery is fully charged. However, you don't have to wait until the tablet is fully charged to turn it on. The L10 will charge while you use it.

Pens for the L10 Tablets

All L10 tablets support touch input with your finger. In addition, a pen or stylus is provided with your tablet, and is compatible with the screen configuration that you order. Many people use a pen for more convenience or precision. The pen is particularly effective for precise data entry and navigation.

The XSLATE and XBOOK tablets come with short pens that fit into the pen holder on these devices. The XPAD tablet includes a longer, thicker pen. If you want a longer pen for the XSLATE or XBOOK tablet, a handle accessory can be ordered with the longer pen.

Capacitive Pens

Capacitive pens work with the tablet's touchscreen and are sometimes called passive pens. The short capacitive pen does not need a battery. The long capacitive pen uses a AAAA battery. These two pens do not require a pen digitizer in the tablet. They work with the tablet's touchscreen directly.

Figure 11 Short Capacitive Pen



Figure 12 Long Capacitive ePen with Battery



Active Digitizer Pens

If the tablet is ordered with an active Wacom digitizer built in to the screen, you will receive one of the two pens pictured below. These Wacom-compatible pens allow for a large range of pressure sensitivity, tilt detection, and hover capability. Hover lets you see where the pen is pointing before the tip touches the display. These pens are frequently called active pens. These active pens use all three modes of the touch screen:

- Finger and Wet
- Finger and Glove
- Finger and Passive Stylus (default)

Figure 13 Short Active Digitizer Pen



Figure 14 Long Active Digitizer Pen



Optional Setup Tasks

Attaching the Pen Tether

The pen comes with a tether so that you can attach it to your tablet to avoid misplacing it.

1. Slip one end of the tether through the hole at the end of the pen, and pull the pen through the loop until it is tight.
2. Slip the other end of the tether through the attach point on the tablet, then pull the pen through the loop until it is tight.

Connecting the Tablet to an External Monitor

There is no dedicated port for an external monitor on the L10 tablet. The tablet has a USB Type-C connector which includes a DisplayPort output capability. You need a dongle that supports USB Type-C DisplayPort and converts it to the port necessary to attach the external monitor, which can have one or more of the following ports: HDMI, DVI, DisplayPort, or VGA.

For instance, to connect a monitor with an HDMI port to your tablet, you need a USB Type-C DisplayPort to HDMI output dongle.



NOTE: Some dongles use USB to Video conversion and these use software to enable the external display over USB interface. Care must be taken to ensure the USB Type-C dongle specifically supports USB Type-C DisplayPort input. Look for a dongle that states it is plug-n-play and that no software or drivers are required.

Back of Battery Charge Indicators

You can check the charge of a battery when it is out of the tablet by pressing the battery check button on the back side.



IMPORTANT: If you remove the battery while the tablet is running, you only have one minute to replace it to keep the tablet running. If you need to remove it for a longer period, be sure to save your files. Then shut down or plug in to a power source.

If you have a battery out of the tablet, you can check the charge by looking at the back side and pressing the button to the left of the lights to view the charge level.

Figure 15 Battery Check Button



1	Battery charge indicators
2	Battery check button

The five lights on the back of the battery indicate the current level of charge—from one light (20% charged) to five lights (100% charged).

Removing and Replacing the Battery

Before removing the battery, save your files and power off the tablet, or plug in the AC adapter and continue working while the battery charges. However, if you are hot swapping the battery, you can do so while the tablet is on and running only on battery power. See [Hot Swapping the Battery on page 27](#).

Removing the Battery

To remove the battery:

1. Save files and shut down the tablet.
2. With the back of the tablet facing you, slide the battery latch to the left until the latch stays open and the battery pops out slightly. A red is displayed instead of the green dot.

3. Insert your finger under the pull-out battery tab and pull to remove the battery from the battery compartment.



1	Sliding battery latch
2	Pull-out battery tab

Replacing the Battery

1. Place the tabbed end of the battery into the battery compartment.



2. Press the battery down until it snaps into place.

Hot Swapping the Battery

Replacing a battery while the tablet is on is called hot swapping. You can hot swap a battery only if you have a second, charged battery to replace it with.



IMPORTANT: You have approximately one minute to hot swap the battery. If you have not replaced the battery within one minute, the tablet goes into Sleep mode.

1. Remove the battery.
2. Insert the new battery.

While hot swapping the battery, notice the following behaviors:

- The tablet display gets dimmer. When the charged battery is in the tablet, the display brightens again.
- The battery status LED turns blue when the system is on and no main battery is present. When you put a charged battery in the tablet, the LED lights turn green again.
- The power button is disabled. (The power button is disabled at any time the tablet has no battery and is not running on AC power through the power adapter.)

Using the Device

Home Screen

Turn on the device to display the Home screen. Depending on how your system administrator configured your device, your Home screen may appear differently than the graphics in this section.

After a suspend or screen time-out, the Home screen displays with the lock slider. Touch the screen and slide up to unlock.

The Home screen provides four additional screens to place widgets and shortcuts. Swipe the screen left or right to view the additional screens.



NOTE: By default, AOSP devices do not have the same icons on the Home screen as GMS devices. Icons are shown below for example only.

Home screen icons can be configured by the user and may look different than shown.

Figure 16 Home Screen

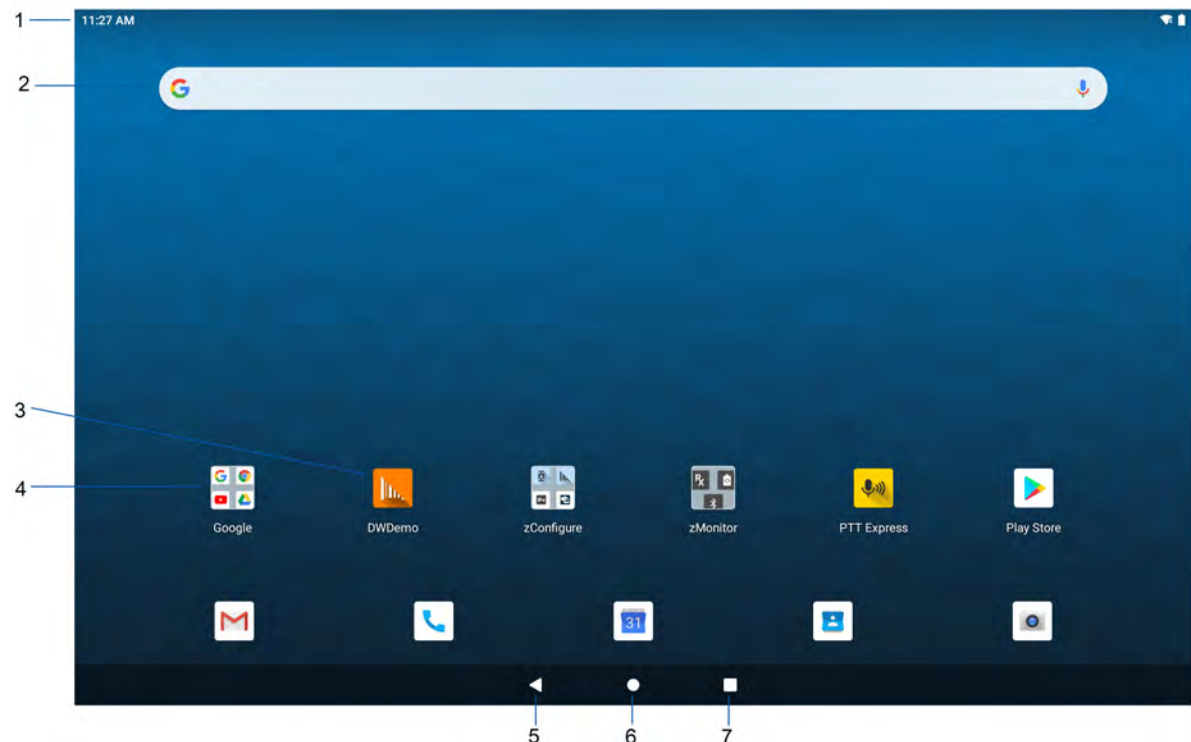

1	Status Bar	Displays the time, status icons (right side), and notification icons (left side). For more information see Notification Icons on page 30 and Managing Notifications on page 32 .
2	Widgets	Launches stand-alone apps that run on the Home screen.
3	Shortcut Icons	Opens apps installed on the device.
4	Folder	Contains apps.
5	Back	Displays the previous screen.
6	Home	Displays the Home screen.
7	Recent	Displays recently used applications.

Setting Home Screen Rotation

By default, the Home screen rotation is disabled.

1. Touch and hold anywhere on the Home screen until the options appear.
2. Touch **Home settings**.
3. Touch the **Allow Home screen rotation** switch.
4. Touch the Home button.
5. Rotate the device.

Status Bar

The Status bar displays the time, notification icons (left side), and status icons (right side).

If there are more notifications than can fit in the Status bar, a dot displays indicating that more notifications exist. Swipe down from the Status bar to open the Notification panel and view all notifications and status.

Figure 17 Notification and Status Icons





















1	Notification Icons. See Notification Icons on page 30 .
2	Status Icons. See Status Icons on page 31 .

Notification Icons

Notification icons indicate app events and messages.























Table 1 Notification Icons

Icon	Description
	Main battery is low.
	More notifications are available for viewing.
	Data is syncing.
	Indicates an upcoming event. AOSP devices only.
	Indicates an upcoming event. GMS devices only.
	Open Wi-Fi network is available.
	Audio is playing.
	Problem with sign-in or sync has occurred.
	Device is uploading data.
	Animated: the device is downloading data. Static: the download is complete.
	Device is connected to or disconnected from a virtual private network (VPN).
	Preparing internal storage by checking it for errors.
	USB debugging is enabled on the device.
	Wired headset with a boom module is connected to the device.
	Wired headset without a boom module is connected to the device.
	PTT Express Voice client status. See the PTT Express PTT Notification Icons for a complete list.
	Indicates the RxLogger app is running.
	Indicates the Bluetooth scanner is connected to the device.
	Indicates the ring scanner is connected to the device in HID mode.

Status Icons

Status icons display system information for the device.

Table 2 Status Icons

Icon	Description
	Alarm is active.
	Main battery is fully charged.
	Main battery is partially drained.
	Main battery charge is low.
	Main battery charge is very low.
	Main battery is charging.
	All sounds, except media and alarms, are muted. Vibrate mode is active.
	Indicates that all sounds except media and alarms are muted.
	Do Not Disturb mode active.
	Airplane Mode is active. All radios are turned off.
	Bluetooth is on.
	The device is connected to a Bluetooth device.
	Connected to a Wi-Fi network. Indicates the Wi-Fi version number.
	Not connected to a Wi-Fi network or no Wi-Fi signal.
	Connected to an Ethernet network.
	Speakerphone enabled.
	Portable Wi-Fi hotspot is active (WWAN only).
	Connected to a 4G LTE/LTE-CA network (WWAN only) ¹ .
	Connected to a DC-HSPA, HSDPA, HSPA+, HSUPA, LTE/LTE-CA or WCDMA network (WWAN only) ¹ .
	Connected to a WCDMA network (WWAN only) ¹ .
	Connected to a DC - HSPA, HSDPA, HSPA+ or HSUPA network (WWAN only) ¹ .
	Connected to an EDGE network (WWAN only) ¹ .

¹Cellular network icon that appears is dependent upon the carrier/network.

Table 2 Status Icons (Continued)

Icon	Description
G	Connected to a GPRS network (WWAN only) ¹ .
R ↓↑	Roaming from a network (WWAN only).
	No SIM card installed (WWAN only).
¹ Cellular network icon that appears is dependent upon the carrier/network.	

Managing Notifications

Notification icons report the arrival of new messages, calendar events, alarms, and ongoing events. When a notification occurs, an icon appears in the Status bar with a brief description. See [Notification Icons on page 30](#) for a list of possible notification icons and their description.

- To view a list of all notifications, open the Notification panel by dragging the Status bar down from the top of the screen.

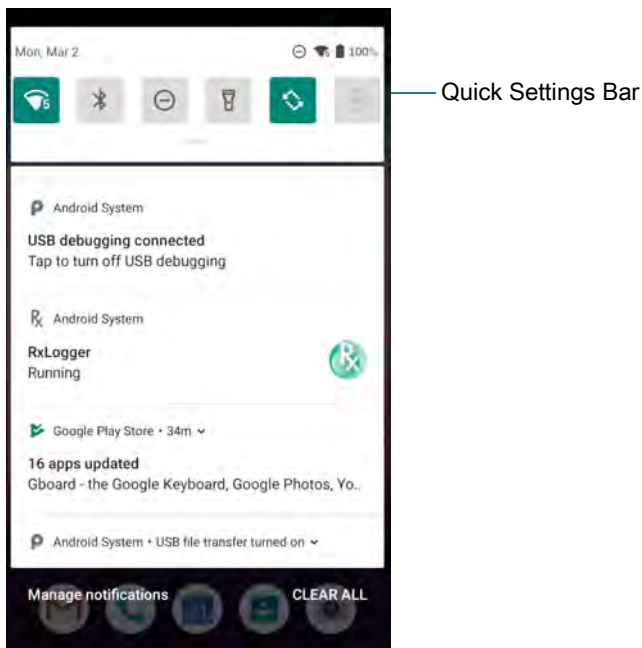
Figure 18 Notification Panel

- To respond to a notification, open the Notification panel and then touch a notification. The Notification panel closes and the corresponding app opens.
- To manage recent or frequently used notifications, open the Notification panel and then touch **Manage notifications**. Touch the toggle switch next to an app to turn off all notifications, or touch an app for more notification options.
- To clear all notifications, open the Notification panel and then touch **CLEAR ALL**. All event-based notifications are removed. Ongoing notifications remain in the list.
- To close the Notification panel, swipe the Notification panel up.

Opening the Quick Access Panel

Use the Quick Access panel to access frequently used settings (for example, Airplane mode). To get to the Quick Access Panel:

- If the device is locked, swipe down once.
- If the device is unlocked, swipe down once with two fingers, or twice with one finger.
- If the Notification panel is open, swipe down from the Quick Settings bar.

Figure 19 Quick Access Panel

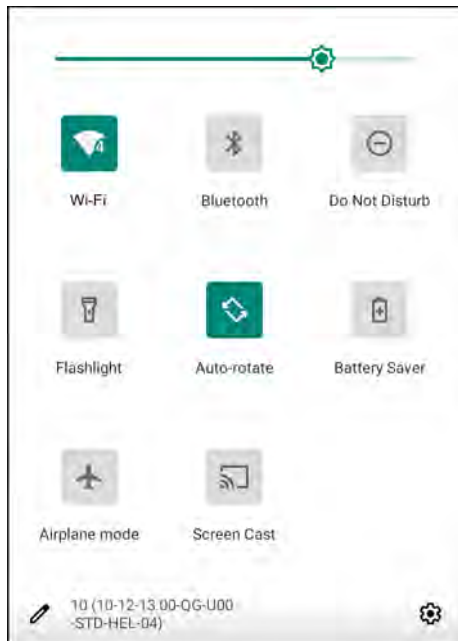

NOTE: Not all icons are pictured. Icons may vary.

Quick Access Panel Icons

- Display brightness - Use the slider to decrease or increase the brightness of the screen.
- Wi-Fi network - Turn Wi-Fi on or off. To open Wi-Fi settings, touch the Wi-Fi network name.
- Bluetooth settings - Turn Bluetooth on or off. To open Bluetooth settings, touch **Bluetooth**.
- Battery saver - Turn Battery saver mode on or off. When Battery saver mode is on the performance of the device is reduced to preserve battery power.
- Invert colors - Invert the display colors.
- Do not disturb - Control how and when to receive notifications.
- Mobile data - Turns cellular radio on or off. To open Mobile data settings, touch and hold (WWAN only).
- Airplane mode - Turn Airplane mode on or off. When Airplane mode is on the device does not connect to Wi-Fi or Bluetooth.
- Auto-rotate - Lock the device's orientation in portrait or landscape mode or set to automatically rotate.
- Flashlight - Turn flashlight on or off. Turn camera flash on or off.

- Location - Enable or disable locationing feature.
- Hotspot - Turn on to share the device's mobile data connection with other devices.
- Data Saver - Turn on to prevent some apps from sending or receiving data in the background.
- Night Light - Tint the screen amber to make it easier to look at the screen in dim light. Set Night Light to turn on automatically from sunset to sunrise, or at other times.
- Screen Cast - Share phone content on Chromecast or a television with Google Cast built-in. Touch cast screen to display a list of devices, then touch a device to begin casting.
- Dark Theme - Toggles dark theme on and off. Dark themes reduce the luminance emitted by the screen, while meeting minimum color contrast ratios. It helps improve visual ergonomics by reducing eye strain, adjusting brightness to current lighting conditions, and facilitating screen use in dark environments, while conserving battery power.
- Focus mode - Turn on to pause distracting apps. To open Focus mode settings, touch and hold.
- Bedtime mode - Turn grayscale on and off. Grayscale turns the screen black and white, reducing phone distractions and improving battery life.
- Nearby Share - Helps find and interact with services and devices close to the device.

Editing Icons on the Quick Settings Bar

The first several setting tiles from the Quick Access panel become the Quick Settings bar.

Open the Quick Access panel and touch  to edit, add, or remove settings tiles.

Battery Management

Observe the recommended battery optimization tips for your device.

- Set the screen to turn off after a short period of non-use.
- Reduce screen brightness.
- Turn off all wireless radios when not in use.
- Turn off automatic syncing for Email, Calendar, Contacts, and other apps.
- Minimize use of apps that keep the device from suspending, for example, music and video apps.



NOTE: Before checking the battery charge level, remove the device from any AC power source (cradle or cable).

Checking Battery Status

- Open **Settings** and touch **About phone** > **Battery Information**.

Or, swipe up from the bottom of the screen and touch  to open the **Battery Manager** app. See [Battery Manager on page 42](#).

- **Battery present status** indicates if the battery is present.
- **Battery level** lists the battery charge (as a percentage of fully charged).
- Swipe down with two fingers from the status bar to open the quick access panel.
 - Battery percentage is displayed next to the battery icon.

Monitoring Battery Usage

The **Battery** screen provides battery charge details and power management options to extend battery life.

1. Go to **Settings**.
2. Touch **Battery**.

Display battery information and power management options for a specific app.

1. Go to **Settings**.
2. Touch **Apps & notifications**.
3. Touch an app.
4. Touch **Advanced > Battery**.

Different apps display different information. Some apps include buttons that open screens with settings to adjust power use. Use the **DISABLE** or **FORCE CLOSE** buttons to turn off apps that consume too much power. Use the **DISABLE** or **FORCE STOP** buttons to turn off apps that consume too much power.

Low Battery Notification

When the battery charge level drops below 10%, the device displays a notice to connect the device to power. The user should charge the battery using one of the charging accessories.

When the battery charge drops below 5%, the device displays a notice to connect the device to power. The user must charge the battery using one of the charging accessories.

When the battery charge drops below 3%, the device turns off. The user must charge the battery using one of the charging accessories.



NOTE: Under conditions of heavy load (scanning quickly and often, RF communication, and other functions.) the device might turn off earlier than a remaining charge of 5%.

Interactive Sensor Technology

The device contains sensors that monitor movement, orientation and ambient light.

- Gyroscope - Measures angular rotational velocity to detect rotation of the device.
- Accelerometer - Measures the linear acceleration of movement to detect the orientation of the device.
- Digital Compass - The digital compass or magnetometer provides simple orientation in relation to the Earth's magnetic field. As a result, the device always knows which way is North so it can auto rotate digital maps depending on the physical orientation of the device.
- Light Sensor - Detects ambient light and adjusts the screen brightness.
- Proximity Sensor - Detects the presence of nearby objects without physical contact. The sensor detects when the device close to your face during a call and turns off the screen, preventing unintentional screen touches.

In order to take advantage of these sensors, applications use API commands. Refer to the Google Android Sensor APIs for more information. For information on the Zebra Android EMDK, go to: techdocs.zebra.com.

Waking the Device

The device goes into Suspend mode when you press the Power button or after a period of inactivity (set in the Display settings window).

1. To wake the device from Suspend mode, press the Power button.

The Lock screen displays.

2. Swipe the screen up to unlock.
 - If the Pattern screen unlock feature is enabled, the Pattern screen appears instead of the Lock screen.
 - If the PIN or Password screen unlock feature is enabled, enter the PIN or password after unlocking the screen.



NOTE: If you enter the PIN, password, or pattern incorrectly five times, you must wait 30 seconds before trying again.

If you forget the PIN, password, or pattern contact your system administrator.

USB Communication

Connect the device to a host computer to transfer files between the device and the host computer.

When connecting the device to a host computer, follow the host computer's instructions for connecting and disconnecting USB devices, to avoid damaging or corrupting files. For information on USB communication accessories available for this device, see [Accessories](#).

Transferring Files

Use Transfer files to copy files between the device and the host computer.

1. Connect the device to a host computer using a USB accessory.
2. On the device, pull down the Notification panel and touch **Charging this device via USB**.
By default, **No data transfer** is selected.
3. Touch **File Transfer**.
4. On the host computer, open a file explorer application.
5. Locate the **device** as a portable device.
6. Open the **Internal storage** folder.
7. Copy files to and from the device or delete files as required.

Transferring Photos

Use **PTP** to copy photos from the device to the host computer.

1. Connect the device to a host computer using a USB accessory.
2. On the device, pull down the Notification panel and touch **Charging this device via USB**.
3. Touch **PTP**.
4. On the host computer, open a file explorer application.
5. Open the **Internal storage** folder.

6. Copy or delete photos as required.

Disconnect from the Host Computer



Carefully follow the host computer's instructions to disconnect USB devices correctly to avoid losing information.

To disconnect the device from the host computer:

1. On the host computer, unmount the device.
2. Remove the device from the USB accessory.

Applications

The **APPS** screen displays icons for all installed apps. See [Application Deployment](#) for information on installing and uninstalling apps. For information on standard Android apps, go to the Google Play [Apps store](#).

The following table describes the apps installed on the device.

Table 3 Apps









Icon	Description
	Battery Manager - Displays battery information, including charge level, status, health and wear level.
	Bluetooth Pairing Utility – Use to pair a Zebra Bluetooth scanner with the device by scanning a barcode.
	Calculator - Provides the basic and scientific arithmetic functions.
	Calendar - Use to manage events and appointments. GMS/GMS-Restricted only.
	Calendar - Use to manage events and appointments. AOSP only.
	Camera - Take photos or record videos. For more information, see Camera on page 45 .
	Chrome - Use to access the Internet or intranet. GMS/GMS-Restricted only.
	Chromium - Use to access the Internet or intranet. AOSP only.
	Clock - Use to schedule alarms for appointments or as a wake-up.

Table 3 Apps (Continued)



Icon	Description
	Contacts - Use to manage contact information.
	DataWedge - Enables data capture using the imager. For more information, see DataWedge Demonstration on page 50 .
	DisplayLink Presenter - Use to present the device screen onto a connected monitor.
	Drive - Upload photos, videos, documents, and other files to personal storage site. GMS/GMS-Restricted only.
	Duo - A one-to-one video calling app (WWAN only). GMS/GMS-Restricted only.
	DWDemo - Provides a way to demonstrate the data capture features using the imager. For more information, see DataWedge Demonstration on page 50 .
	Email - Use to send and receive email. AOSP only.
	Files - Organize and manage files on the device.
	Gallery - Use to view photos stored on the microSD card. AOSP only.
	Gmail - Use to send and receive email using a Google email account. GMS/GMS-Restricted only.
	Google - Launches Google™ search app. GMS/GMS-Restricted only.
	Keep Notes - Use to create, edit, and share notes. GMS/GMS-Restricted only.
	License Manager - Use to manage software licenses on the device.
	Maps - Use to see your location on a map (with public transit, traffic, or satellite overlays). Search for any business or place of interest. Provides turn-by-turn navigation with voice guidance, traffic-avoidance, and alternate routes, for drivers, cyclists, walkers, and users of public transportation. GMS/GMS-Restricted only.

Table 3 Apps (Continued)























Icon	Description
	Messages - Send SMS and MMS messages. WAN devices only. GMS/GMS-Restricted only.
	Messaging - Send SMS and MMS messages. WAN devices only.
	MSRN - Use to verify authenticity of the paired Snap-on MSR and to provision the Snap-on MSR.
	Music - Play music stored on the microSD card or internal storage. AOSP only.
	Music - Play music stored on the microSD card or internal storage. AOSP only.
	Phone - Use to dial a phone number when used with some Voice over IP (VoIP) clients (VoIP telephony ready only).
	Photos - Use to sync photos with Google account. GMS/GMS-Restricted only.
	Play Movies & TV - View movies and video on your device. GMS/GMS-Restricted only.
	Play Music - Use to listen to music. GMS devices only.
	Play Store - Download music, movies, books, and Android apps and games from the Google Play Store. GMS/GMS-Restricted only.
	PTT Express - Use to launch PTT Express client for VoIP communication.
	RxLogger - Use to diagnose device and app issues. For more information, see RxLogger on page 55 .
	Search - Use to search the Web. Requires an Internet connection. AOSP only.
	Settings - Use to configure the device.

Table 3 Apps (Continued)

Icon	Description
	Sound Recorder - Use to record audio. For more information, see Sound Recorder on page 56 .
	StageNow - Allows the device to stage a device for initial use by initiating the deployment of settings, firmware, and software.
	Videos - Use to view videos on the device. AOSP only.
	Voice Search - Use to perform searches by asking questions. GMS/GMS-Restricted only.
	Worry Free Wifi Analyzer - A diagnostic intelligent app. Use to diagnose surrounding area and display network stats, such as coverage hole detection, or AP in vicinity. Refer to the Worry Free Wi-Fi Analyzer Administrator Guide for Android.
	YouTube - Use to view videos on the YouTube™ web site. GMS/GMS-Restricted only.
	YT Music - Use to listen to music. GMS/GMS-Restricted only.
	Zebra Bluetooth Settings - Use to configure Bluetooth logging.
	Zebra Data Services - Use to enable or disable Zebra Data Services. Some options are set by the system administrator.

Accessing Apps

All apps installed on the device are accessed using the **APPS** window.

1. On the Home screen, swipe up from the bottom of the screen.
2. Slide the **APPS** window up or down to view more app icons.
3. Touch an icon to open the app.

Switching Between Recent Apps

Use the Recent button to switch between recently used apps.

1. Touch Recent button.
 - A window appears on the screen with icons of recently used apps.
2. Slide the apps displayed up and down to view all recently used apps.
3. Swipe left or right to remove app from the list and force close the app.

4. Touch an icon to open an app or touch Back button to return to the current screen.

Battery Manager

The **Battery Manager** provides detailed information about the battery and battery swap procedures on supported devices.



Opening Battery Manager

To open the Battery Manager app, swipe up from the bottom of the Home screen, and then touch .

Battery Manager Information Tab

The Battery Manager displays detailed information about battery charging, health, and status.

Table 4 Battery Icon Description

Battery Icon	Description
	Battery charge level is between 85% and 100%.
	Battery charge level is between 19% and 84%.
	Battery charge level is between 0% and 18%.

- **Level** - The current battery charge level as a percentage. Displays -% when level is unknown.
- **Wear** - The health of the battery in graphical form. When the wear level exceeds 80%, the bar color changes to red.
- **Health** - The health of the battery. If a critical error occurs,  appears. Touch to view the error description.
 - **Decommission** - The battery is past its useful life and should be replaced. See system administrator.
 - **Good** - The battery is good.
 - **Charge error** - An error occurred while charging. See system administrator.
 - **Over Current** - An over-current condition occurred. See system administrator.
 - **Dead** - The battery has no charge. Replace the battery.
 - **Over Voltage** - An over-voltage condition occurred. See system administrator.
 - **Below Temperature** - The battery temperature is below the operating temperature. See system administrator.
 - **Failure Detected** - A failure has been detected in the battery. See system administrator.
 - **Unknown** - See system administrator.
- **Charge Status**

- **Not charging** - The device is not connected to AC power.
- **Charging-AC** - The device is connected to AC power and charging.
- **Charging-USB** - The device is connected to a host computer with a USB cable and charging.
- **Discharging** - The battery is discharging.
- **Full** - That the battery is fully charged.
- **Unknown** - The battery status is unknown.
- **Time until Full** - The amount of time until the battery is fully charged.
- **Time since charging** - The amount of time since the device began charging.
- **Time until empty** - The amount of time until the battery is empty.
- **Advanced info** - Touch to view additional battery information.
 - **Battery present status - Indicates that the battery is present.**
 - **Battery level** - The battery charge level as a percentage of scale.
 - **Battery scale** - The battery scale level used to determine battery level (100).
 - **Battery voltage** - The current battery voltage in millivolts.
 - **Battery temperature** - The current battery temperature in degrees Centigrade.
 - **Battery technology** - The type of battery.
 - **Battery current** - The average current into or out of the battery over the last second in mAh.
 - **Battery manufacture date** - The date of manufacture.
 - **Battery serial number** - The battery serial number. The number matches the serial number printed on the battery label.
 - **Battery part number** - The battery part number.
 - **Battery rated capacity** - Lists the rated capacity of the backup battery in mAh.
 - **Battery decommission status** - Indicates if the battery is past its life span.
 - **Battery Good** - The battery is in good health.
 - **Decommissioned Battery** - The battery is past its useful life and should be replaced.
 - **Base cumulative charge** - Cumulative charge using Zebra charging equipment only.
 - **Battery present capacity** - Maximum amount of charge that could be pulled from the battery under the present discharge conditions if the battery were fully charged.
 - **Battery health percentage** - With a range from **0** to **100**, this is the ratio of “present_capacity” to “design_capacity” at a discharge rate of “design_capacity”.
 - **% decommission threshold** - The default % decommission threshold for a gifted battery as 80%.
 - **Battery present charge** - Amount of usable charge remaining in the battery at present under the current discharge conditions.
 - **Battery total cumulative charge** - The total accumulated charge in all chargers.
 - **Battery time since first use** - The time passed since the battery was placed in a Zebra terminal for the first time.
 - **Battery error status** - The error status of the battery.
 - **Battery usage number** - The health of the battery as a result of charging and discharging. A high number indicates low battery health.

- **Usage decommission threshold** - When the Battery usage number is greater than or equal to the Usage decommission threshold, the battery is past its useful life and should be replaced.
- **App version** - The application version number.

Battery Manager Swap Tab



NOTE: The **Swap** tab also appears when the user presses the Power button and selects **Battery Swap**.

Use to place the device in Battery Swap mode when replacing the battery. Follow the instructions on the screen. Touch **Proceed with battery swap** button.

Camera



NOTE: The device saves photos and videos on the microSD card, if installed and the storage path is changed manually. By default, or if a microSD card is not installed, the device saves photos and videos on the internal storage.

This section provides information for taking photos and recording videos using the integrated digital cameras.



Taking Photos

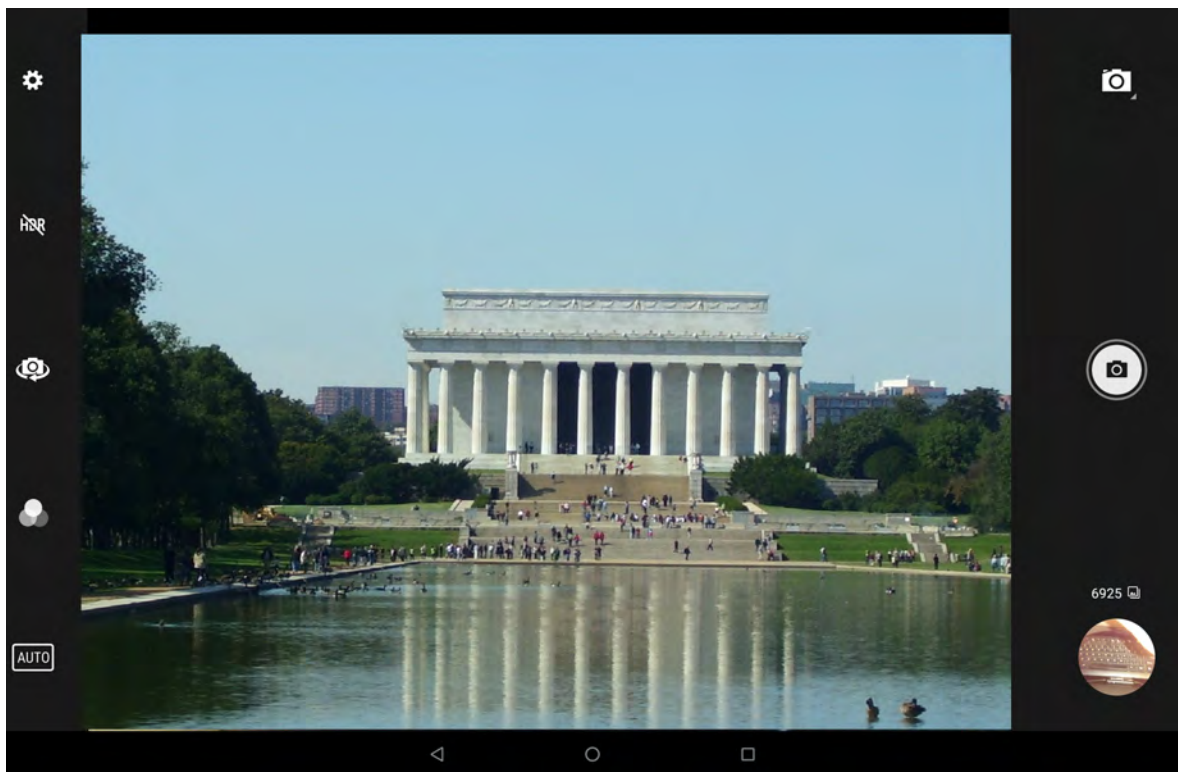

NOTE: See [Photo Settings](#) for camera setting descriptions.

1. Swipe up from the bottom of the Home screen and touch **Camera**.



2. If necessary, touch the Camera Mode icon and touch .
3. Frame the subject on the screen.
4. To zoom in or out, press two fingers on the display and pinch or expand fingers. The zoom controls appear on the screen.
5. Touch an area on the screen to focus. The focus circle appears. The two bars turn green when in focus.
6. Touch .

The camera takes a photo and a shutter sound plays.



The photo momentarily displays as a thumbnail in the lower left corner.

Taking a Panoramic Photo

Panorama mode creates a single wide image by panning slowly across a scene.

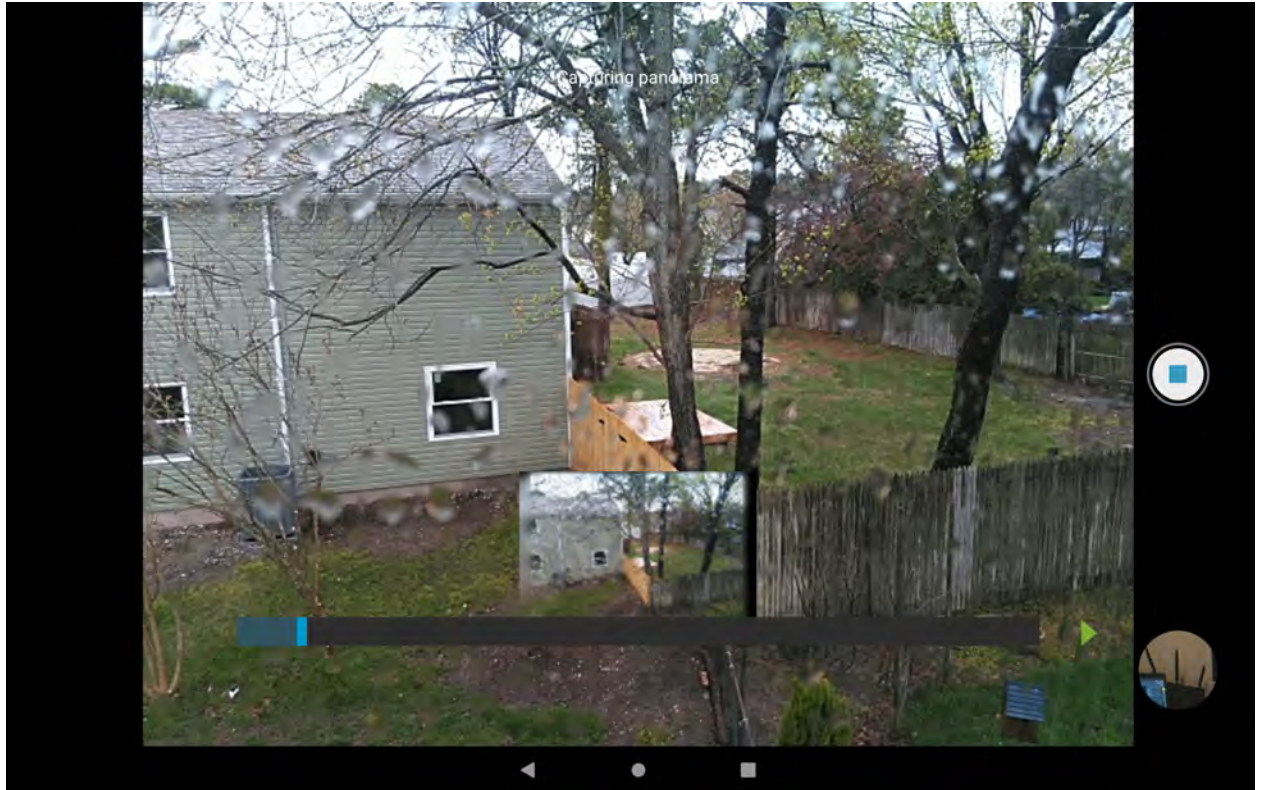
1. Swipe up from the bottom of the Home screen and touch **Camera**.



2. Touch the Camera Mode icon and touch .
3. Frame one side of the scene to capture.
4. Touch  and slowly pan across the area to capture. A small white square appears inside the button indicating the capture is in progress.
If you are panning too quickly, the message **Too fast** appears.
5. Touch  to end the shot. The panorama appears immediately and a progress indicator displays while it saves the image.

Recording Videos

1. Swipe up from the bottom of the Home screen and touch **Camera**.
2. Touch the camera mode menu and touch .

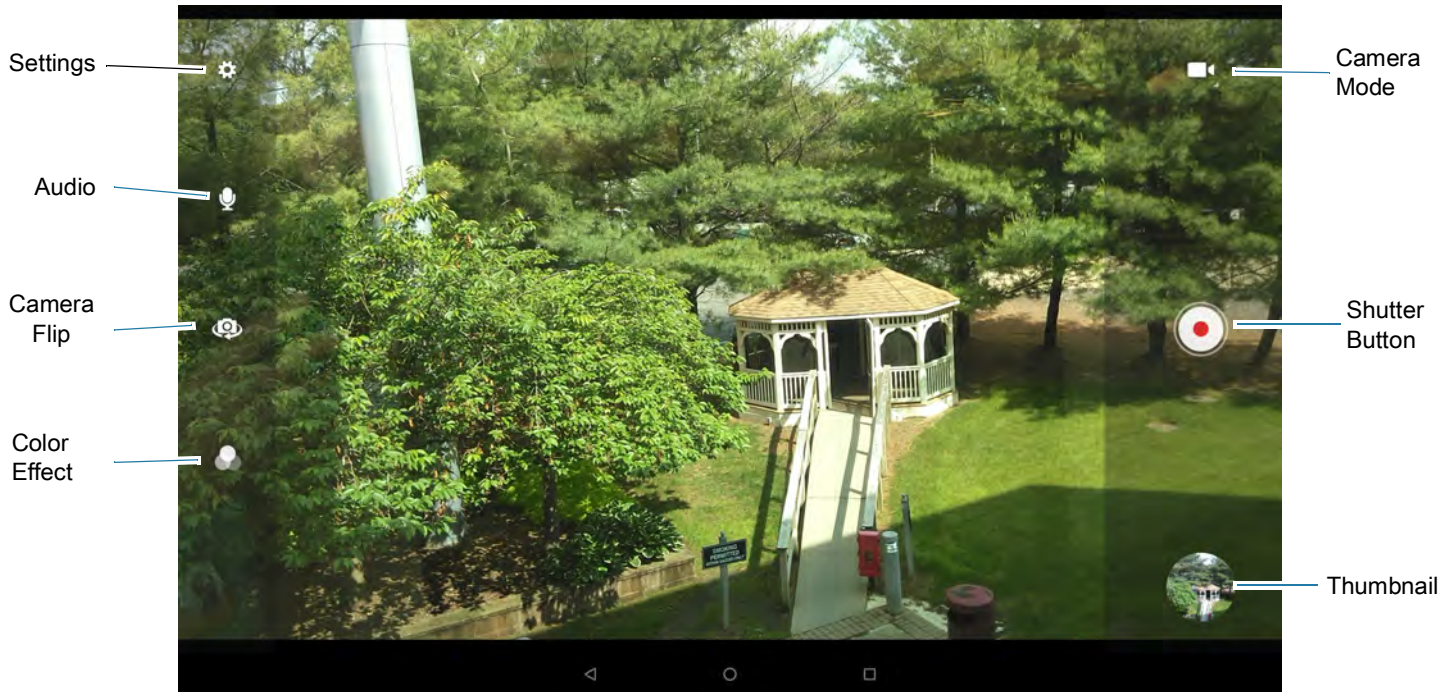













3. Point the camera and frame the scene.
4. To zoom in or out, press two fingers on the display and pinch or expand fingers. The zoom controls appear on the screen.
5. Touch  to start recording.
The video time remaining appears in the top left of the screen.
6. Touch  to end the recording.
The video momentarily displays as a thumbnail in the lower left corner.

Photo Settings

In Photo mode, photo settings appear on screen. Touch  to display the photo settings options.





Rear Camera Photo Settings

- **Flash** - Select whether the camera relies on its light meter to decide whether a flash is necessary, or to turn it on or off for all shots.
 -  **Off** - Disable flash.
 -  **Auto** - Adjust flash automatically depending upon light meter (default).
 -  **On** - Enable flash upon taking a photo.
 -  **Torch** - Turn flash on continuously.
- **GPS location** - Add GPS location information to the photo meta-data. Turn **On** or **Off** (default). (ET56 only).
- **Picture size** - The size (in pixels) of the photo to: **13M pixels** (default), **8M pixels**, **5M pixels**, **3M pixels**, **HD 1080**, **2M pixels**, **HD720**, **1M pixels**, **WVGA**, **VGA**, or **QVGA**.

- **Picture quality** - Set the picture quality setting to: **Low**, **Standard** (default) or **High** (default).
- **Countdown timer** - Select **Off** (default), **2 seconds**, **5 seconds** or **10 seconds**.
- **Storage** – Set the location to store the photo to: **Phone** or **SD Card**.
- **Continuous Shot** - Select to take a series of photos quickly while holding the capture button. **Off** (default) or **On**.
- **Face Detection** - Set the camera to automatically adjust the focus for faces.
- **ISO** - Set camera sensitivity to light to: **Auto** (default), **ISO Auto (HJR)**, **ISO100**, **ISO200**, **ISO400**, **ISO800** or **ISO1600**.
- **Exposure** - Set the exposure settings to: **+2**, **+1**, **0**(default), **-1** or **-2**.
- **White balance** - Select how the camera adjusts colors in different kinds of light, to achieve the most natural-looking colors:
 -  **Incandescent** - Adjust the white balance for incandescent lighting.
 -  **Fluorescent** - Adjust the white balance for florescent lighting.
 -  **Auto** - Adjust the white balance automatically (default).
 -  **Daylight** - Adjust the white balance for daylight.
 -  **Cloudy** - Adjust the white balance for a cloudy environment.
- **Redeye reduction** - Helps eliminate redeye effect. Options: **Disabled** (default), or **Enable**.
- **ZSL** - Set the camera to immediately take a picture when the button is pressed (default – enabled).
- **Shutter Sound** - Select to play a shutter sound when taking a photo. Options: **Disable** (default) or **Enable**.
- **Anti Banding** - Allows the camera to avoid problems caused by artificial light sources that are not constant. These sources cycle (flicker) fast enough to go unnoticed to the human eye, appearing continuous. The camera's eye (its sensor) can still see this flicker. Options: **Auto** (default), **60 Hz**, **50 Hz**, or **Off**.

Front Camera Photo Settings







- **Selfie Flash** - Turns screen white to help produce a little extra light in dimmer settings. Options: **Off** (default), or **On**.
- **GPS location** - **Add GPS location information to the photo meta-data. Options: On or Off (default). (ET56 only).**
- **Picture size** - Set the size (in pixels) of the photo to: **5M pixels** (default), **3M pixels**, **HD1080**, **2M pixels**, **HD720**, **1M pixels**, **WVGA**, **VGA**, or **QVGA**.
- **Picture quality** - Set the picture quality setting to: **Low**, **Standard** (default) or **High** (default).
- **Countdown timer** - Set to: **Off** (default), **2 seconds**, **5 seconds** or **10 seconds**.
- **Storage** – Set location to store the photo to: **Phone** or **SD Card**.
- **Continuous Shot** - Select to take a series of photos quickly while holding the capture button. **Off** (default) or **On**.
- **Face Detection** - Select to turn face detection **Off** (default) or **On**.
- **ISO** - Set how sensitive the camera is to light. Options: **Auto** (default), **ISO Auto (HJR)**, **ISO100**, **ISO200**, **ISO400**, **ISO800** or **ISO1600**.

- **Exposure** - Touch to adjust the exposure settings. Options: **+2**, **+1**, **0** (default), **-1** or **-2**.
- **White balance** - Select how the camera adjusts colors in different kinds of light, to achieve the most natural-looking colors:
 -  **Incandescent** - Adjust the white balance for incandescent lighting.
 -  **Fluorescent** - Adjust the white balance for florescent lighting.
 -  **Auto** - Adjust the white balance automatically (default).
 -  **Daylight** - Adjust the white balance for daylight.
 -  **Cloudy** - Adjust the white balance for a cloudy environment.
- **Redeye reduction** - Helps eliminate redeye effect. Options: **Disabled** (default), or **Enable**.
- **ZSL** - Set the camera to immediately take a picture when the button is pressed (default – enabled)
- **Selfie Mirror** - Select to save a mirror image of the photo. Options: **Disable** (default), or **Enable**.
- **Shutter Sound** - Select to play a shutter sound when taking a photo. Options: **Disable** (default) or **Enable**.
- **Anti Banding** - Allows the camera to avoid problems caused by artificial light sources that are not constant. These sources cycle (flicker) fast enough to go unnoticed to the human eye, appearing continuous. The camera's eye (its sensor) can still see this flicker. Options: **Auto** (default), **60 Hz**, **50 Hz**, or **Off**.

Video Settings





In Video mode, video settings appear on screen. Touch  to display the video settings options.

Rear Camera Video Settings

- **Flash** - Select whether Rear-facing Camera relies on its light meter to decide whether a flash is necessary, or to turn it on or off for all shots.
 -  **Off** - Disable flash (default).
 -  **On** - Enable flash.
- **Video quality** - Set video quality to: **4k DCI**, **4k UHD**, **HD 1080p** (default), **HD 720p**, **SD 480p**, **VGA**, **CIF**, or **QVGA**.
- **Video duration** - Set to: **30 seconds (MMS)**, **10 minutes**, **30 minutes (default)**, or **no limit**.
- **GPS location** - Add GPS location information to the photo meta-data. **Turn On** or **Off (default)**. **(ET56 only)**.
- **Storage** – Set the location to store the photo to: **Phone** (default) or **SD Card**.
- **White balance** - Select how the camera adjusts colors in different kinds of light, to achieve the most natural-looking colors.
 -  **Incandescent** - Adjust the white balance for incandescent lighting.
 -  **Fluorescent** - Adjust the white balance for florescent lighting.
 -  **Auto** - Adjust the white balance automatically (default).
 -  **Daylight** - Adjust the white balance for daylight.

-  **Cloudy** - Adjust the white balance for a cloudy environment.
- **Image Stabilization** - Set to reduce blurry videos due to device movement. Options: **On** or **Off** (default).

Front Camera Video Settings

- **Video quality** - Set video quality to: **HD1080p** (default), **HD 720p**, **SD 480p**, **VGA**, **CIF**, or **QVGA**.
- **Video duration** - Set to: **30 seconds (MMS)**, **10 minutes**, **30 minutes** (default), or **no limit**.
- **GPS location** - **Add GPS location information to the photo meta-data**. Turn **On** or **Off** (default). (ET56 only).
- **Storage** – Set the location to store the photo to: **Phone** (default) or **SD Card**.
- **White balance** - Select how the camera adjusts colors in different kinds of light, to achieve the most natural-looking colors.
 -  **Incandescent** - Adjust the white balance for incandescent lighting.
 -  **Fluorescent** - Adjust the white balance for florescent lighting.
 -  **Auto** - Adjust the white balance automatically (default).
 -  **Daylight** - Adjust the white balance for daylight.
 -  **Cloudy** - Adjust the white balance for a cloudy environment.
- **Image Stabilization** - Set to reduce blurry videos due to device movement. Options: **On** or **Off** (default).

DataWedge Demonstration

Use **DataWedge Demonstration** to demonstrate data capture functionality. To configure DataWedge, refer to techdocs.zebra.com/datawedge/.



NOTE: DataWedge is enabled on the Home screen. To disable this feature, go to the DataWedge settings and disable the **Launcher** profile.

Table 5 DataWedge Demonstration Icons











	Icon	Description
Illumination		Imager illumination is on. Touch to turn illumination off.
		Imager illumination is off. Touch to turn illumination on.
Data Capture		Indicates a USB scanner is connected to the device.
		Indicates a USB scanner is not connected to the device.

Table 5 DataWedge Demonstration Icons (Continued)

	Icon	Description
		A Bluetooth scanner is connected.
		A Bluetooth scanner is not connected.
		The data capture function is through the rear camera.
Scan Mode		Imager is in picklist mode. Touch to change to normal scan mode.
		Imager is in normal scan mode. Touch to change to picklist mode.
Menu		Opens a menu to view the application information or to set the application DataWedge profile.

Scanner Selection

To select a scanner, touch  > **Settings** > **Scanner selection**.

See the Data Capture section for more information.

Press the scanner trigger button or touch the on-screen yellow scan button to capture data. The data appears in the text field below the yellow button.

PTT Express Voice Client



NOTE: Requires a PTT Express License.

PTT Express Voice Client enables Push-To-Talk (PTT) communication between disparate enterprise devices. Leveraging existing Wireless Local Area Network (WLAN) infrastructure, PTT Express delivers simple PTT communication without requiring a voice communication server.

- **Group Call:** Press and hold the PTT (Talk) button to start communicating with other voice client users.
- **Private Response:** Double-press the PTT button to respond to the originator of the last broadcast or to make a Private Response.

PTT Express User Interface

Figure 20 PTT Express Default User Interface

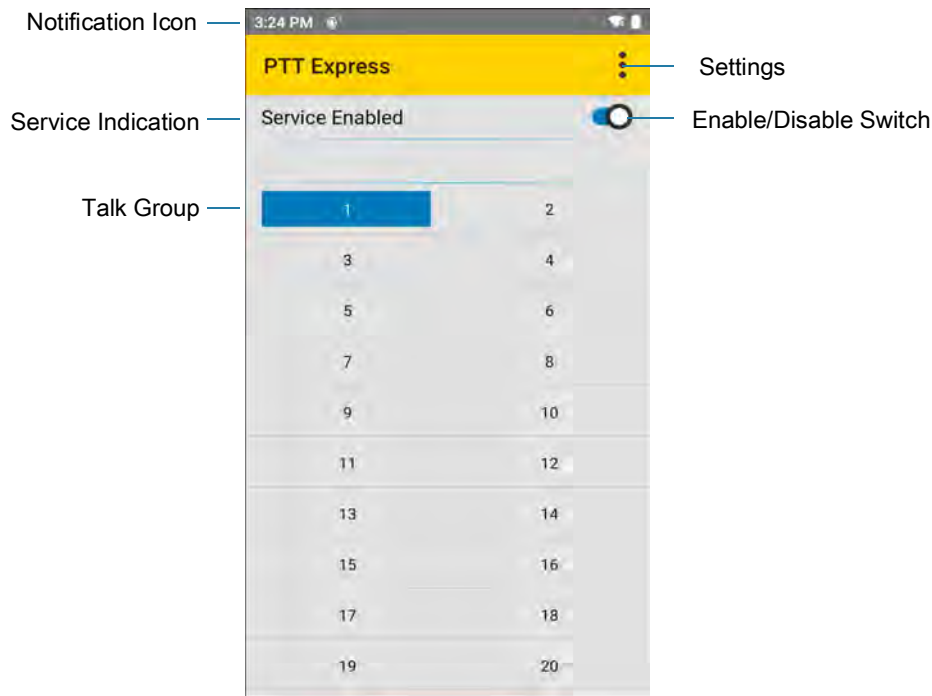

Table 6 PTT Express Default User Interface Descriptions

Item	Description
Notification Icon	Indicates the current state of the PTT Express client.
Service Indication	Indicates the status of the PTT Express client. Options: Service Enabled , Service Disabled or Service Unavailable .
Talk Groups	Lists all 32 Talk Groups available for PTT communication.
Settings	Opens the PTT Express Settings screen.
Enable/Disable Switch	Turns the PTT service on and off.

PTT Audible Indicators







The following tones provide helpful cues when using the voice client.

- **Talk Tone:** Double chirp. Plays when the Talk button is depressed. This is a prompt for you to start talking.
- **Access Tone:** Single beep. Plays when another user just finished a broadcast or response. You can now initiate a Group Broadcast or Private Response.
- **Busy Tone:** Continuous tone. Plays when the Talk button is depressed and another user is already communicating on the same talkgroup. Plays after the maximum allowed talk time is reached (60 seconds).
- **Network Tone:**
 - Three increasing pitch beeps. Plays when PTT Express acquires the WLAN connection and the service is enabled.
 - Three decreasing pitch beeps. Plays when PTT Express loses the WLAN connection or the service is disabled.

PTT Notification Icons

Notification icons indicate the current state of the PTT Express Voice client.

Table 7 PTT Express Icon Descriptions

Status Icon	Description
	The PTT Express Voice client is disabled.
	The PTT Express Voice client is enabled but not connected to a WLAN.
	The PTT Express Voice client is enabled, connected to a WLAN, and listening on the Talk Group indicated by the number next to the icon.
	The PTT Express Voice client is enabled, connected to a WLAN, and communicating on the Talk Group indicated by the number next to the icon.
	The PTT Express Voice client is enabled, connected to a WLAN, and in a private response.
	The PTT Express Voice client is enabled and muted.
	The PTT Express Voice client is enabled but it is not able to communicate due to a VoIP telephony call in progress.

Enabling PTT Communication

1. Swipe up from the bottom of the Home screen and touch .
2. Slide the **Enable/Disable Switch** to the **ON** position. The button changes to **ON**.

Selecting a Talk Group

One of 32 Talk Groups can be selected by PTT Express users. However, only one talk group may be enabled at a time on the device. Touch one of the 32 Talk Groups. The selected Talk Group is highlighted.

PTT Communication



NOTE: This section describes the default PTT Express client configuration. Refer to the PTT Express V1.2 User Guide for detailed information on using the client.

Creating a Group Call



NOTE: When using a wired headset, use only Zebra approved wired headsets with a PTT button.

1. Press and hold the PTT button (or the Talk button on the headset) and listen for the talk tone.
If you hear a busy tone, release the button and wait a moment before making another attempt. Ensure that PTT Express and the WLAN are enabled.
2. Start talking after hearing the talk tone.



NOTE: Holding the button for more than 60 seconds (default) drops the call, allowing others to make Group calls. Release the button when finished talking to allow others to make calls.

Responding with a Private Response

The Private Response can only be initiated once a Group Call has been established. The initial Private Response is made to the originator of the Group Call.

1. Wait for an access tone.
2. Within 10 seconds, double-press the PTT button, and listen for the talk tone.
3. If you hear a busy tone, release the button and wait a moment before making another attempt. Ensure that PTT Express and the WLAN are enabled.
4. Start talking after the talk tone plays.
5. Release the button when finished talking.

Disabling PTT Communication

1. Swipe up from the bottom of the Home screen and touch .
2. Slide the **Enable/Disable Switch** to the **OFF** position. The button changes to **OFF**.
3. Touch the Home button.

RxLogger

RxLogger is a comprehensive diagnostic tool that provides application and system metrics, and diagnoses device and application issues. RxLogger logs the following information: CPU load, memory load, memory snapshots, battery consumption, power states, wireless logging, cellular logging, TCP dumps, Bluetooth logging, GPS logging, logcat, FTP push/pull, ANR dumps, etc. All generated logs and files are saved onto flash storage on the device (internal or external).

RxLogger Configuration

RxLogger is built with an extensible plug-in architecture and comes packaged with a number of plug-ins already built-in. For information on configuring RxLogger, refer to techdocs.zebra.com/rxlogger/.

To open the configuration screen, from the RxLogger home screen touch **Settings**.

Configuration File

RxLogger configuration can be set using an XML file. The `config.xml` configuration file is located in the `RxLogger\config` folder. Copy the file from the device to a host computer using a USB connection. Edit the configuration file and then replace the XML file on the device. There is no need to stop and restart the RxLogger service since the file change is automatically detected.

Enabling Logging

To enable logging:

1. Swipe the screen up and select .
2. Touch **Start**.
3. Touch the Home button.

Disabling Logging

To disable logging:

1. Swipe the screen up and select .
2. Touch **Stop**.
3. Touch the Home button.

Extracting Log Files

1. Connect the device to a host computer using an USB connection.
2. Using a file explorer, navigate to the `RxLogger` folder.
3. Copy the file from the device to the host computer.
4. Disconnect the device from the host computer.

Backing Up

RxLogger Utility allows the user to make a zip file of the `RxLogger` folder in the device, which by default contains all the RxLogger logs stored in the device.

To save the backup data, touch  > **BackupNow**.

RxLogger Utility

RxLogger Utility is a data monitoring application for viewing logs in the device while RxLogger is running. Logs and RxLogger Utility features are accessed using Main Chat Head.

Initiating the Main Chat Head

To initiate the Main Chat Head:

1. Open **RxLogger**.
2. Touch  > **Toggle Chat Head**. The Main Chat Head icon appears on the screen.
3. Touch and drag the Main Chat head icon to move it around the screen.

Removing the Main Chat Head

To remove the Main Chat Head icon:

1. Touch and drag the icon. A circle with an X appears.
2. Move the icon over the circle and then release.

Viewing Logs

To view logs:

1. Touch the Main Chat Head icon. The RxLogger Utility screen appears.
2. Touch a log to open it. The user can open many logs with each displaying a new sub Chat Head.
3. If necessary, scroll left or right to view additional Sub Chat Head icons.
4. Touch a Sub Chat Head to display the log contents.

Removing a Sub Chat Head Icon

To remove a sub chat Head icon, press and hold the icon until it disappears.

Backing Up In Overlay View

RxLogger Utility allows the user to make a zip file of the **RxLogger** folder in the device, which by default contains all the RxLogger logs stored in the device.

The Backup icon is always available in Overlay View.

1. Touch . The Backup dialog box appears.
2. Touch **Yes** to create the back up.

Sound Recorder

Use **Sound Recorder** to record audio messages.

Recordings are saved on the microSD card (if installed) or the internal storage, and are available in the Music application (AOSP devices) or the Play Music application (GMS devices).



Touch  to open options menu.

- **File type** - Select the file type for the recording file.
 - **AMR**
 - **3GPP**
 - **AAC**
 - **WAV**
 - **AMR-WB**
 - **AMR-WB-3GPP.**
- **Storage location** - Select the location for the recording file.
 - **Phone storage**
 - **SD card**

Settings

Accessing Settings

There are multiple ways to access settings on a device.

- Swipe down with two fingers from the top of the Home screen to open the Quick Access panel and touch .
- Double-swipe down from the top of the Home screen to open the Quick Access panel and touch .
- Swipe up from the bottom of the Home screen to open APPS and touch  **Settings**.

Display Settings

Use Display settings to change the screen brightness, enable night light, change the background image, enable screen rotation, set sleep time, and change font size.

Setting the Screen Brightness Manually

Manually set the screen brightness using the touchscreen.

1. Swipe down with two fingers from the Status bar to open the Quick Access panel.
2. Slide the icon to adjust the screen brightness level.

Setting the Screen Brightness Automatically

Automatically adjust the screen brightness using the built-in light sensor.

1. Go to **Settings**.
2. Touch **Display**.
3. If disabled, touch **Adaptive brightness** to automatically adjust the brightness.
By default, **Adaptive brightness** is enabled. Toggle the switch to disable.
4. Touch the Home button.

Setting Night Light

The Night Light setting tints the screen amber, making the screen easier to look at in low light.

1. Go to **Settings**.
2. Touch **Display**.

3. Touch **Night Light**.
4. Touch **Schedule**.
5. Select one of the schedule values:
 - None (default)
 - Turns on at custom time
 - Turns on from sunset to sunrise.
6. By default, **Night Light** is disabled. Touch **TURN ON NOW** to enable.
7. Adjust the tint using the **Intensity** slider.
8. Touch the Home button.

Setting Screen Rotation

By default, screen rotation is enabled.

1. Go to **Settings**.
2. Touch **Display > Advanced**.
3. Touch **Auto-rotate screen**.



NOTE: To change the Home screen rotation, see [Setting Home Screen Rotation on page 29](#).

4. Touch the Home button.

Setting Screen Timeout

Set the screen sleep time.

1. Go to **Settings**.
2. Touch **Display > Advanced > Screen timeout**.
3. Select one of the sleep values.
 - **15 seconds**
 - **30 seconds**
 - **1 minute** (default)
 - **2 minutes**
 - **5 minutes**
 - **10 minutes**
 - **30 minutes**
4. Touch the Home button.

Lock Screen Display

The lock screen display setting wakes the screen when notifications are received.

1. Go to **Settings**.
2. Touch **Display > Advanced**.

3. Touch **Lock screen display**.
4. In the **When to show** section, enable or disable an option using the switch.
5. Touch the Home button.

Setting Font Size

Set the size of the font in system apps.

1. Go to **Settings**.
2. Touch **Display > Advanced**.
3. Touch **Font size**.
4. Select one of the font size values.
 - Small
 - Default
 - Large
 - Largest.
5. Touch the Home button.

Notification LED Brightness Level

Set the brightness of the Notification LED.

1. Go to **Settings**.
2. Touch **Display > Advanced**.
3. Touch **Notification LED Brightness Level**.
4. Use the slider to set the brightness value (default: 15).
5. Touch the Home button.

Touch Panel Mode

The device display is able to detect touches using a finger, a conductive-tip stylus, or gloved finger.



NOTE: A glove can be made of medical latex, leather, cotton, or wool. For optimal performance use a Zebra certified stylus.

1. Go to **Settings**.
2. Touch **Display > Advanced**.
3. Touch **Touch panel mode**.
4. Select:
 - **Finger Only Mode - Moisture optimized - Rain Mode** to use a finger on the screen and when the device may have water on the screen.
 - **Stylus and Finger** to use a finger or a stylus on the screen.
 - **Finger and Stylus** to use a finger or a stylus on the screen.
 - **Finger and Glove** to use a finger or a gloved finger on the screen.

- **Glove and Finger** to use a finger or a gloved finger on the screen.
5. Touch the Home button.

Setting the Date and Time

The date and time is automatically synchronized using an NITZ server when the device is connected to a wireless network. You are only required to set the time zone or set the date and time if the wireless LAN does not support Network Time Protocol (NTP) or when not connected to a wireless network.

1. Go to **Settings**.
2. Touch **System > Date & time**.
3. Touch **Use network-provided time** to disable automatic date and time synchronization.
4. Touch **Use network-provided time zone** to disable automatic time zone synchronization.
5. Touch **Update Interval**.
6. Select the interval time to synchronize your device time from the network.
7. Touch **Date**.
8. In the calendar, set today's date.
9. Touch **OK**.
10. Touch **Time**.
11. Touch the green circle, drag to the current hour and then release.
12. Touch the green circle, drag to the current minute and then release.
13. Touch **AM** or **PM**.
14. Touch **OK**.
15. Touch **Time zone**.
16. Select the current time zone from the list.
17. Touch **Use 24-hour format**.
18. Touch the Home button.



General Sound Setting

Use the **Sound** settings to configure media and alarm volumes.

1. Go to **Settings**.
2. Touch **Sound**.
3. Touch an option to set sounds.

Sound Options

- **Zebra volume controls**
 - **Ring volume** - Controls the ringtone volume.
 - **Media volume** - Controls the music, games, and media volume.
 - **Alarm volume** - Controls the alarm clock volume.

- **Notifications volume** - Controls the notification volume.
- **In call volume** - Controls the volume during a call.
- **Scanner volume** - Controls the scanner volume.
- **Volume presets**
 -  - Mutes the ring, notifications, and scanner so that the device does not make sounds or vibrate.
 -  - All sounds except media and alarms are silenced and vibrate mode is active.
 -  - Enables all sounds at the user defined levels.
- **Do Not Disturb** - Mutes some or all sounds and vibrations.
- **Shortcut to prevent ringing** - Select how the shortcut method prevents ringing.
- **Default notification sound** - Select a sound to play for all system notifications.
- **Default alarm sound** - Select a sound to play for alarms.
- **Other sounds and vibrations**
 - **Screen locking sounds** - Play a sound when locking and unlocking the screen (default – enabled).
 - **Charging sounds and vibration** - Plays a sound and vibrates when power is applied to the device (default - enabled).
 - **Touch sounds** - Play a sound when making screen selections (default – enabled).
 - **Touch vibration** - Vibrate the device when making screen selections (default – disabled).
- **Wireless Emergency alerts** - Touch to configure emergency broadcast settings and notifications.

Remapping a Button

Buttons on the device can be programmed to perform different functions or as shortcuts to installed apps. For a list of key names and descriptions, refer to: techdocs.zebra.com.



NOTE: It is not recommended to remap the scan button.

1. Go to **Settings**.
2. Touch **Key Programmer**. A list of programmable buttons displays.
3. Select the button to remap.
4. Touch the **BUTTON REMAPPING** tab or the **SHORTCUT** tab that lists the available functions and applications.
5. Touch a function or application shortcut to map to the button.



NOTE: If you select an application shortcut, the application icon appears next to the button on the Key Programmer screen.

6. Touch the Home button.

Keyboards

The device provides multiple keyboard options.

- Enterprise Keyboard



NOTE: By default the Enterprise and Virtual Keyboards are disabled.



Keyboard Configuration

Enabling Keyboards

1. Go to **Settings**.
2. Touch **System > Languages & input > Virtual keyboard > Manage keyboards**.
3. Touch a keyboard to enable.

To enable a virtual keyboard like Gboard or Enterprise keyboard:

Switching Between Keyboards

- To switch between keyboards, touch in a text box to display the current keyboard.
- On the Gboard keyboard, touch and hold  (GMS devices only).
- On the Android keyboard, touch and hold  (AOSP devices only).
- On the Enterprise keyboard, touch . Only available with Mobility DNA Enterprise License. Not pre-installed on the device. Contact Zebra Support for more information.

Using the Android and Gboard Keyboards

Use the Android or Gboard keyboards to enter text in a text field.

To configure the keyboard settings, touch and hold , (comma) and then select **Android keyboard settings**.

Edit Text

Edit entered text and use menu commands to cut, copy, and paste text within or across apps. Some apps do not support editing some or all of the text they display; others may offer their own way to select text.

Entering Numbers, Symbols, and Special Characters

1. Enter numbers and symbols.
 - Touch and hold one of the top-row keys until a menu appears then select a number or special character.
 - Touch the Shift key once for a single capital letter. Touch the Shift key twice to lock in uppercase. Touch the Shift key a third time to unlock Capslock.
 - Touch **?123** to switch to the numbers and symbols keyboard.
 - Touch the **=\<** key on the numbers and symbols keyboard to view additional symbols.
2. Enter special characters.
 - Touch and hold a number or symbol key to open a menu of additional symbols. A larger version of the key displays briefly over the keyboard.

Using the Enterprise Keyboard

The Enterprise Keyboard contains multiple keyboard types.

- Numeric

- Alpha
- Special characters
- Data capture.

Numeric Tab

The numeric keyboard is labeled **123**. The keys displayed vary on the app being used. For example, an arrow displays in **Contacts**, however **Done** displays in **Email** account setup.

Alpha Tab

The alpha keyboard is labeled using the language code. For English, the alpha keyboard is labeled **EN**.

Additional Character Tab

The additional characters keyboard is labeled **#*/**.

Touch 😊 to enter emoji icons in a text message.

Touch **ABC** to return to the Symbols keyboard.

Scan Tab

The Scan tab provides an easy data capture feature for scanning barcodes.

Language Usage

Use the **Language & input** settings to change the device's language, including words added to the dictionary.

Changing the Language Setting

1. Go to **Settings**.
2. Touch **System > Languages & input**.
3. Touch **Languages**. A list of available languages displays.
4. If the desired language is not listed, touch **Add a language** and select a language from the list.
5. Touch and hold ☰ to the right of the desired language, then drag it to the top of the list.
6. The operating system text changes to the selected language.

Adding Words to the Dictionary

1. Go to **Settings**.
2. Touch **System > Languages & input > Advanced > Personal dictionary**.
3. If prompted, select the language where this word or phrase is stored.
4. Touch **+** to add a new word or phrase to the dictionary.
5. Enter the word or phrase.
6. In the **Shortcut** text box, enter a shortcut for the word or phrase.
7. Touch the Home button.

Notifications

Setting App Notifications

To set notification settings for a specific app:

1. Go to **Settings**.
2. Touch **Apps & notifications** > **SEE ALL XX APPS**. The **App info** screen displays.
3. Select an app.
4. Touch **Notifications**.

Options vary depending on the app selected.

5. Select an available option:

Show notifications - Select to turn all notifications from this app on (default) or off.

Touch a notification category to display additional options.

- **Alerting** - Allow notifications from this app to make sound or vibrate the device.
 - **Pop on screen** - Allow notifications from this app to pop notifications on the screen.
- **Silent** - Do not allow notifications from this app to make sound or vibrate.
 - **Minimize** - In the Notification panel, collapse notifications to one line.
- **Advanced** - Touch for additional options.
 - **Sound** - Select a sound to play for notifications from this app.
 - **Vibrate** - Allow notifications from this app to vibrate the device.
 - **Blink light** - Allow notifications from this app the light the Notification LED blue.
 - **Show notification dot** - Allow notifications from this app to add a notification dot to the app icon.
 - **Override Do Not Disturb** - Allow these notifications to interrupt when Do Not Disturb is enabled.

Advanced

- **Allow notification dot** - Do not allow this app to add a notification dot to the app icon.
- **Additional settings in the app** - Open the app settings.

Viewing Notification Settings for All Apps

To view the notification settings for all apps:

1. Go to **Settings**.
2. Touch **Apps & Notifications**.
3. Scroll down to **Notifications** to view how many apps have notifications turned off.
4. To set or view notifications settings for a specific app, see [Setting App Notifications on page 65](#).

Controlling Lock Screen Notifications

To control whether notifications can be seen when the device is locked:

1. Go to **Settings**.
2. Touch **Apps & notifications** > **Notifications**.

3. Touch **Notifications on lockscreen** and select one of the following:
 - **Show alerting and silent notifications** (default)
 - **Show alerting notifications only**
 - **Don't show notifications.**

Blink Light

The Notification LED lights blue when an app, such as email and VoIP, generates a programmable notification or to indicate when the device is connected to a Bluetooth device. By default, LED notifications are enabled.

To change the notification setting:

1. Go to **Settings**.
2. Touch **Apps & notifications > Notifications > Advanced**.
3. Touch **Blink light** to toggle the notification on or off.

Wireless

This section provides information on the following wireless features:

- Wireless Wide Area Network (WWAN)
- Wireless Local Area Network (WLAN)
- Bluetooth

Wireless Wide Area Networks

Use Wireless wide area networks (WWANs) to access data over a cellular network. This section provides information on:

- Sharing a data connection
- Monitoring data usage
- Changing Cellular Network settings

Sharing the Mobile Data Connection

The **Tethering & Portable Hotspot** settings allows sharing the mobile data connection with a single computer via USB tethering or Bluetooth tethering. Share the data connection with up to eight devices at once, by turning it into a portable Wi-Fi hotspot. While the device is sharing its data connection, an icon displays at the top of the screen and a corresponding message appears in the notification list.

Enabling USB Tethering



NOTE: USB tethering is not supported on computers running Mac OS. If the computer is running Windows or a recent version of Linux (such as Ubuntu), follow these instructions without any special preparation. If running a version of Windows that precedes Windows 7, or some other operating system, you may need to prepare the computer to establish a network connection via USB.

1. Connect the device to a host computer with the USB cable.
2. The notification **Charging this device via USB** appears in the Notifications panel.
3. Go to **Settings**.
4. Touch **Network & Internet**.
5. Touch **Hotspot & tethering**.
6. Touch the **USB tethering** switch to enable.

The host computer is now sharing the device's data connection.

To stop sharing the data connection, touch the **USB tethering** switch again or disconnect the USB cable.

Enabling Bluetooth Tethering

Use Bluetooth tethering to share the data connection with a host computer.

Configure the host computer to obtain its network connection using Bluetooth. For more information, see the host computer's documentation.

1. Pair the device with the host computer.
2. Go to **Settings**.
3. Touch **Networking & Internet**.
4. Touch **Hotspot & tethering**.
5. Touch the **Bluetooth tethering** switch to enable.

The host computer is now sharing the device's data connection.

To stop sharing the data connection, touch the **Bluetooth tethering** switch again.

Enabling Wi-Fi Hotspot

To enable the Wi-Fi Hotspot:

1. Go to **Settings**.
2. Touch **Network & Internet**.
3. Touch **Hotspot & tethering**.
4. Touch **Wi-Fi hotspot**.
5. Toggle the switch to enable.

After a moment, the device starts broadcasting its Wi-Fi network name (SSID). Connect to it with up to eight computers or other devices. The Hotspot (📶) icon appears in the Status bar.

To stop sharing the data connection, touch the toggle switch again.

Configuring the Wi-Fi Hotspot

1. Go to **Settings**.
2. Touch **Network & Internet**.
3. Touch **Hotspot & tethering**.
4. Touch **Wi-Fi hotspot**.
5. In the **Hotspot name** text field, edit the name for the hotspot.
6. Touch **Security** and select a security method from the drop-down list.
 - **WPA2-Personal**
 - a. Touch **Hotspot password**.
 - b. Enter a password.
 - c. Touch **OK**.
 - **None** - If **None** is selected in the Security option, a password is not required.
7. Touch **Advanced**.

8. If desired, touch **Turn off hotspot automatically** to turn off Wi-Fi Hotspot when no devices are connected.
9. In the **AP Band** drop-down list, select **2.4 GHz Band** or **5.0 GHz Band**.

Data Usage

Data usage refers to the amount of data uploaded or downloaded by the device during a given period. Depending on the wireless plan, you may be charged additional fees when your data usage exceeds your plan's limit.

To monitor your data usage:

1. Go to **Settings**.
2. Touch **Network & internet > Mobile network > Data usage**.



CAUTION: The usage displayed on the data usage settings screen is measured by your device. Your carrier's data usage accounting may differ. Usage in excess of your carrier plan's data limits can result in steep overage charges. The feature described here can help you track your usage, but is not guaranteed to prevent additional charges.

Data usage settings allow:

- Enable Data Saver.
- Set the data usage warning level.
- Set a data usage limit.
- View or restrict data usage by app.
- Identify mobile hotspots and restrict background downloads that may result in extra charges.

By default, the data usage settings screen displays the mobile data settings. That is, the data network or networks provided by your carrier.

Setting Data Usage Warning

To set a warning alert when the device has used a certain amount of mobile data:

1. Go to **Settings**.
2. Touch **Network & internet > Mobile network > Data usage > **.
3. If necessary, touch **Set data warning** to enable it.
4. Touch **Data warning**.
5. Enter a number. To switch between megabytes (MB) and gigabytes (GB), touch the down arrow.
6. Touch **SET**.

When the usage reaches the set level, a notification appears.

Setting Data Limit

1. Go to **Settings**.
2. Touch **Network & internet > Mobile network > Data usage > **.
3. Touch **Set data limit**.
4. Touch **OK**.
5. Touch **Data limit**.

6. Enter a number. To switch between megabytes (MB) and gigabytes (GB), touch the down arrow.
7. Touch **Set**.

When the limit is reached, data automatically turns off and a notification appears.

Cellular Network Settings

Cellular network settings applies to WWAN devices only.

Data When Roaming

Roaming is disabled by default to prevent the device from transmitting data over other carriers' mobile networks when leaving an area that is covered by the carrier's networks. This is useful for controlling expenses if the service plan does not include data roaming.

Enabling Data on GSM Devices

1. Go to **Settings**.
2. Touch **Network & Internet > Mobile network**.
3. Touch **Roaming**.

The switch moves to the on position.

Setting Preferred Network

Change the network operating mode.

1. Go to **Settings**.
2. Touch **Network & Internet > Mobile network > Advanced**.
3. Touch **Automatically select network**.
4. Touch **Network**.
5. In the **Available network** list, select a carrier network.

Using Search for MicroCell

A MicroCell acts like a mini cell tower in a building or residence and connects to an existing broadband Internet service. It improves cell signal performance for voice calls, texts, and cellular data applications like picture messaging and Web surfing.

1. Go to **Settings**.
2. Touch **Network & Internet > Mobile network**.
3. Touch **Search for MicroCell**.

Configuring the Access Point Name



NOTE: Many service provider Access Point Name (APN) data are pre-configured in the device. The APN information for all other service providers must be obtained from the wireless service provider.

To use the data on a network, configure the APN information.

1. Go to **Settings**.
2. Touch **Network & Internet > Mobile network > Advanced**.
3. Touch **Access Point Names**.

4. Touch an APN name in the list to edit an existing APN or touch **+** to create a new APN.
5. Touch each APN setting and enter the appropriate data obtained from the wireless service provider.
6. When finished, touch **:** > **Save**.
7. Touch the radio button next to the APN name to start using it.
8. Touch the Home button.

Locking the SIM Card

Locking the SIM card requires the user to enter a PIN every time the device is turned on. If the correct PIN is not entered, only emergency calls can be made.

1. Go to **Settings**.
2. Touch **Security > SIM card lock**.
3. Touch **Lock SIM card**.
4. Enter the PIN associated with the card. Touch **OK**.
5. Reset the device.

Default SIM Slot Configuration

The device contains SIM slots that can be used for installing up to two SIM cards. A system administrator can set the default SIM slot for the device.

By default, SIM slot configuration is disabled. To allow SIM slot configuration on the device, use Zebra's staging solution, StageNow, to enable the SIM Socket Selection parameter. See techdocs.zebra.com/stagenow.

Setting the Default SIM Slot

1. Go to **Settings**.
2. Touch **About phone > SW components**.
3. Touch **WWAN** five times. The message **Turn ON SIM Slot UI** appears.
4. Touch Back two times.
5. Touch **Network & Internet > Mobile network > Advanced > SIM socket selection**.
6. Select the SIM slot to set as default.

Dual SIM Dual Standby

Dual SIM Dual Standby mode allows a device with two SIM cards to make or receive calls using either SIM card. Both SIM cards remain active while not in use. When a call is initiated using one SIM card, the other SIM card becomes inactive until the call ends.

Dual SIM Dual Standby mode is disabled by default. To activate Dual SIM Dual Standby mode, use Zebra's staging solution, StageNow. For more information, refer to: www.zebra.com/stagenow.

Wireless Local Area Networks

Wireless local area networks (WLANs) allow the device to communicate wirelessly inside a building. Before using the device on a WLAN, the facility must be set up with the required hardware to run the WLAN (sometimes known as infrastructure). The infrastructure and the device must both be properly configured to enable this communication.

Refer to the documentation provided with the infrastructure (access points (APs), access ports, switches, Radius servers, etc.) for instructions on how to set up the infrastructure.

Once the infrastructure is set up to enforce the chosen WLAN security scheme, use the **Wireless & networks** settings configure the device to match the security scheme.

The device supports the following WLAN security options:

- None
- Enhanced Open
- Wireless Equivalent Privacy (WEP)
- Wi-Fi Protected Access (WPA)/WPA2 Personal (PSK)
- WPA3-Personal
- WPA/WPA2/WPA3 Enterprise (EAP)
 - Protected Extensible Authentication Protocol (PEAP) - with MSCHAPV2 and GTC authentication.
 - Transport Layer Security (TLS)
 - Tunneled Transport Layer Security (TTLS) - with Password Authentication Protocol (PAP), MSCHAP and MSCHAPv2 authentication
 - Password (PWD)
 - Lightweight Extensible Authentication Protocol (LEAP).
- WPA3-Enterprise 192-bit

The **Status** bar displays icons that indicate Wi-Fi network availability and Wi-Fi status.



NOTE: To extend the life of the battery, turn off Wi-Fi when not in use.

Connecting to a Wi-Fi Network

To connect to a Wi-Fi network:

1. Go to **Settings**.
2. Touch **Wi-Fi** to open the **Wi-Fi** screen. The device searches for WLANs in the area and lists them.
3. Scroll through the list and select the desired WLAN network.
4. For open networks, touch profile once or press and hold and then select **Connect** or for secure networks enter the required password or other credentials then touch **Connect**. See the system administrator for more information.

The device obtains a network address and other required information from the network using the dynamic host configuration protocol (DHCP) protocol. To configure the device with a fixed internet protocol (IP) address, see [Configuring the Device to Use a Static IP Address on page 76](#).

5. In the Wi-Fi setting field, **Connected** appears indicating that the device is connected to the WLAN.

Removing a Wi-Fi Network

To remove a remembered or connected network:

1. Go to **Settings**.
2. Touch **Network & Internet > W-Fi**.
3. Scroll down to the bottom of the list and touch **Saved networks**.
4. Touch the name of the network.
5. Touch **FORGET**.
6. Touch the Home button.

WLAN Configuration

This section provides information on configuring Wi-Fi settings.

Configuring a Secure Wi-Fi Network

1. Go to **Settings**.
2. Touch **Network & Internet > Wi-Fi**.
3. Slide the switch to the **ON** position.
4. The device searches for WLANs in the area and lists them on the screen.
5. Scroll through the list and select the desired WLAN network.
6. Touch the desired network. If the network security is **Open**, the device automatically connects to the network. For all other network security a dialog box appears.
7. If the network security is WPA/WPA2-Personal, WPA3-Personal, or WEP, enter the required password and then touch **Connect**.
8. If the network security is WPA/WPA2/WPA3 Enterprise:
 - Touch the **EAP method** drop-down list and select one of the following:
 - **PEAP**
 - **TLS**
 - **TTLS**
 - **PWD**
 - **LEAP**
 - Touch the **Phase 2 authentication** drop-down list and select an authentication method.
 - If required, touch **CA certificate** and select a Certification Authority (CA) certificate. Note: Certificates are installed using the **Security** settings.
 - If required, touch **User certificate** and select a user certificate. Note: User certificates are installed using the Security settings.
 - If required, in the **Identity** text box, enter the username credentials.
 - If desired, in the **Anonymous identity** text box, enter an anonymous identity username.
 - If required, in the **Password** text box, enter the password for then given identity.
9. If the network security is **WPA3-Enterprise 192-bit**:

- Touch **CA certificate** and select a Certification Authority (CA) certificate. Note: Certificates are installed using the **Security** settings.
- Touch **User certificate** and select a user certificate. Note: User certificates are installed using the **Security** settings.
- In the **Identity** text box, enter the username credentials.



NOTE: By default, the network Proxy is set to **None** and the IP settings is set to **DHCP**. See Configuring for a Proxy Server for setting connection to a proxy server and see Configuring the Device to Use a Static IP Address for setting the device to use a static IP address.

10. Touch **Connect**.
11. Touch the Home button.

Manually Adding a Wi-Fi Network

Manually add a Wi-Fi network if the network does not broadcast its name (SSID) or to add a Wi-Fi network when out of range.

1. Go to **Settings**.
2. Touch **Network & Internet > Wi-Fi**.
3. Slide the Wi-Fi switch to the **On** position.
4. Scroll to the bottom of the list and select **Add network**.
5. In the **Network name** text box, enter the name of the Wi-Fi network.
6. In the **Security** drop-down list, set the type of security to:
 - **None**
 - **Enhanced Open**
 - **WEP**
 - **WPA/WPA2-Personal**
 - **WPA3-Personal**
 - **WPA/WPA2/WPA3-Enterprise**
 - **WPA3-Enterprise 192-bit**
7. If the network security is **None**, touch **Save**.
8. If the network security is **WEP**, **WPA3-Personal**, or **WPA/WPA2-Personal**, enter the required password and then touch **Save**.
9. If the network security is **WPA/WPA2/WPA3-Enterprise**:
 - Touch the **EAP method** drop-down list and select one of the following:
 - **PEAP**
 - **TLS**
 - **PWD**
 - **LEAP**.
 - Touch the **Phase 2 authentication** drop-down list and select an authentication method.
 - If required, touch **CA certificate** and select a Certification Authority (CA) certificate. Note: Certificates are installed using the **Security** settings.

- If required, touch **User certificate** and select a user certificate. Note: User certificates are installed using the **Security** settings.
 - If required, in the **Identity** text box, enter the username credentials.
 - If desired, in the **Anonymous identity** text box, enter an anonymous identity username.
 - If required, in the **Password** text box, enter the password for the given identity.
10. If the network security is **WPA3-Enterprise 192-bit**:
- Touch **CA certificate** and select a Certification Authority (CA) certificate. Note: Certificates are installed using the **Security** settings.
 - Touch **User certificate** and select a user certificate. Note: User certificates are installed using the **Security** settings.
 - In the **Identity** text box, enter the username credentials.



NOTE: By default, the network Proxy is set to **None** and the IP settings is set to **DHCP**. See [Configuring for a Proxy Server on page 75](#) for setting connection to a proxy server and see [Configuring the Device to Use a Static IP Address on page 76](#) for setting the device to use a static IP address.

11. Touch **Save**. To connect to the saved network, touch and hold on the saved network and select **Connect to network**.
12. Touch the Home button.

Configuring for a Proxy Server

A proxy server is a server that acts as an intermediary for requests from clients seeking resources from other servers. A client connects to the proxy server and requests some service, such as a file, connection, web page, or other resource, available from a different server. The proxy server evaluates the request according to its filtering rules. For example, it may filter traffic by IP address or protocol. If the request is validated by the filter, the proxy provides the resource by connecting to the relevant server and requesting the service on behalf of the client.

It is important for enterprise customers to be able to set up secure computing environments within their companies, making proxy configuration essential. Proxy configuration acts as a security barrier ensuring that the proxy server monitors all traffic between the Internet and the intranet. This is normally an integral part of security enforcement in corporate firewalls within intranets.

1. Go to **Settings**.
2. Touch **Network & Internet > Wi-Fi**.
3. Slide the Wi-Fi switch to the **On** position.
4. In the network dialog box, select and touch a network.
5. Touch **Advanced options**.
6. Touch **Proxy** and select **Manual**.
7. In the **Proxy hostname** text box, enter the address of the proxy server.
8. In the **Proxy port** text box, enter the port number for the proxy server.
9. In the **Bypass proxy for** text box, enter addresses for web sites that are not required to go through the proxy server. Use a comma “,” between addresses. Do not use spaces or carriage returns between addresses.
10. Touch **Connect**.
11. Touch the Home button.

Configuring the Device to Use a Static IP Address

By default, the device is configured to use Dynamic Host Configuration Protocol (DHCP) to assign an Internet protocol (IP) address when connecting to a wireless network.

1. Go to **Settings**.
2. Touch **Network & Internet > Wi-Fi**.
3. Slide the Wi-Fi switch to the **On** position.
4. In the network dialog box, select and touch a network.
5. Touch **Advanced options**.
6. Touch **IP settings** and select **Static**.
7. In the **IP address** text box, enter an IP address for the device.
8. If required, in the **Gateway** text box, enter a gateway address for the device.
9. If required, in the **Network prefix length** text box, enter the prefix length.
10. If required, in the **DNS 1** text box, enter a Domain Name System (DNS) address.
11. If required, in the **DNS 2** text box, enter a DNS address.
12. Touch **Connect**.
13. Touch the Home button.

Wi-Fi Preferences

Use the **Wi-Fi preferences** to configure advanced Wi-Fi settings. From the Wi-Fi screen scroll down to the bottom of the screen and touch **Wi-Fi preferences**.

- **Turn on Wi-Fi automatically** - When enabled, Wi-Fi automatically turns back on when near high quality saved networks.
- **Open network notification** - When enabled, notifies the user when an open network is available.
- **Advanced** - Touch to expand options.
 - **Additional settings** - See Additional Settings.
 - **Install Certificates** - Touch to install certificates.
 - **Network rating provider** - Disabled (AOSP devices). To help determine what constitutes a good Wi-Fi network, Android supports external Network rating providers that provide information about the quality of open Wi-Fi networks. Select one of the providers listed or **None**. If none are available or selected, the Connect to open networks feature is disabled.
 - **Wi-Fi Direct** - Displays a list of devices available for a direct Wi-Fi connection.
 - **MAC address** - Displays the Media Access Control (MAC) address of the device when connecting to Wi-Fi networks.
 - **IP address** - Displays the IP address of the device when connecting to Wi-Fi networks.

Additional Wi-Fi Settings



NOTE: Additional Wi-Fi settings are for the device, not for a specific wireless network.

Use the **Additional Settings** to configure additional Wi-Fi settings. To view the additional Wi-Fi settings, scroll to the bottom of the **Wi-Fi** screen and touch **Wi-Fi Preferences > Advanced > Additional settings**.

- **Regulatory**
 - **Country Selection** - Displays the acquired country code if 802.11d is enabled, else it displays the currently selected country code.
 - **Region code** - Displays the current region code.
- **Band and Channel Selection**
 - **Wi-Fi frequency band** - Set the frequency band to: **Auto** (default), **5 GHz only** or **2.4 GHz only**.
 - **Available channels (2.4 GHz)** - Touch to display the **Available channels** menu. Select specific channels and touch **OK**.
 - **Available channels (5 GHz)** - Touch to display the **Available channels** menu. Select specific channels and touch **OK**.
- **Logging**
 - **Advanced Logging** – Touch to enable advanced logging or change the log directory.
 - **Wireless logs** - Use to capture Wi-Fi log files.
 - **Fusion Logger** - Touch to open the **Fusion Logger** application. This application maintains a history of high level WLAN events which helps to understand the status of connectivity.
 - **Fusion Status** - Touch to display live status of WLAN state. Also provides information about the device and connected profile.
- **About**
 - **Version** - Displays the current Fusion information.

Wi-Fi Direct

Wi-Fi Direct devices can connect to each other without having to go through an access point. Wi-Fi Direct devices establish their own ad-hoc network when required, letting you see which devices are available and choose which one you want to connect to.

1. Go to **Settings**.
2. Touch **Wi-Fi > Wi-Fi preferences > Advanced > Wi-Fi Direct**. The device begins searching for another Wi-Fi Direct device.
3. Under **Peer devices**, touch the other device name.
4. On the other device, select **Accept**.

Connected appears on the device. On both devices, in their respective Wi-Fi Direct screens, the other device name appears in the list.

Bluetooth

Bluetooth devices can communicate without wires, using frequency-hopping spread spectrum (FHSS) radio frequency (RF) to transmit and receive data in the 2.4 GHz Industry Scientific and Medical (ISM) band (802.15.1). Bluetooth wireless technology is specifically designed for short-range (10 m (32.8 ft)) communication and low power consumption.

Devices with Bluetooth capabilities can exchange information (for example, files, appointments, and tasks) with other Bluetooth enabled devices such as printers, access points, and other mobile devices.

The device supports Bluetooth Low Energy. Bluetooth Low Energy is targeted at applications in the healthcare, fitness, security, and home entertainment industries. It provides reduced power consumption and cost while maintaining standard Bluetooth range.

Adaptive Frequency Hopping

Adaptive Frequency Hopping (AFH) is a method of avoiding fixed frequency interferers, and can be used with Bluetooth voice. All devices in the piconet (Bluetooth network) must be AFH-capable in order for AFH to work. There is no AFH when connecting and discovering devices. Avoid making Bluetooth connections and discoveries during critical 802.11b communications. AFH for Bluetooth consists of four main sections:

- Channel Classification - A method of detecting an interference on a channel-by-channel basis, or pre-defined channel mask.
- Link Management - Coordinates and distributes the AFH information to the rest of the Bluetooth network.
- Hop Sequence Modification - Avoids interference by selectively reducing the number of hopping channels.
- Channel Maintenance - A method for periodically re-evaluating the channels.

When AFH is enabled, the Bluetooth radio “hops around” (instead of through) the 802.11b high-rate channels. AFH coexistence allows enterprise devices to operate in any infrastructure.



NOTE: It is not recommended to perform Bluetooth wireless technology inquiry when high rate 802.11b operation is required.

Security

The current Bluetooth specification defines security at the link level. Application-level security is not specified. This allows application developers to define security mechanisms tailored to their specific need. Link-level security occurs between devices, not users, while application-level security can be implemented on a per-user basis. The Bluetooth specification defines security algorithms and procedures required to authenticate devices, and if needed, encrypt the data flowing on the link between the devices. Device authentication is a mandatory feature of Bluetooth while link encryption is optional.

Pairing of Bluetooth devices is accomplished by creating an initialization key used to authenticate the devices and create a link key for them. Entering a common personal identification number (PIN) in the devices being paired generates the initialization key. The PIN is never sent over the air. By default, the Bluetooth stack responds with no key when a key is requested (it is up to user to respond to the key request event). Authentication of Bluetooth devices is based-upon a challenge-response transaction. Bluetooth allows for a PIN or passkey used to create other 128-bit keys used for security and encryption. The encryption key is derived from the link key used to authenticate the pairing devices. Also worthy of note is the limited range and fast frequency hopping of the Bluetooth radios that makes long-distance eavesdropping difficult.

Recommendations are:

- Perform pairing in a secure environment
- Keep PIN codes private and do not store the PIN codes in the device
- Implement application-level security.

Bluetooth Profiles

The device supports the Bluetooth services listed.

Table 8 Bluetooth Profiles

Profile	Description
Service Discovery Protocol (SDP)	Handles the search for known and specific services as well as general services.
Serial Port Profile (SPP)	Allows use of RFCOMM protocol to emulate serial cable connection between two Bluetooth peer devices. For example, connecting the device to a printer.
Object Push Profile (OPP)	Allows the device to push and pull objects to and from a push server.
Advanced Audio Distribution Profile (A2DP)	Allows the device to stream stereo-quality audio to a wireless headset or wireless stereo speakers.
Audio/Video Remote Control Profile (AVRCP)	Allows the device to control A/V equipment to which a user has access. It may be used in concert with A2DP.
Personal Area Network (PAN)	Allows the use of Bluetooth Network Encapsulation Protocol to provide L3 networking capabilities over a Bluetooth link. Only PANU role is supported.
Human Interface Device Profile (HID)	Allows Bluetooth keyboards, pointing devices, gaming devices and remote monitoring devices to connect to the device.
Headset Profile (HSP)	Allows a hands-free device, such as a Bluetooth headset, to place and receive calls on the device.
Hands-Free Profile (HFP)	Allows car hands-free kits to communicate with the device in the car.
Phone Book Access Profile (PBAP)	Allows exchange of Phone Book Objects between a car kit and a mobile device to allow the car kit to display the name of the incoming caller; allow the car kit to download the phone book so you can initiate a call from the car display.
Out of Band (OOB)	Allows exchange of information used in the pairing process. Pairing is initiated by NFC but completed using the Bluetooth radio. Pairing requires information from the OOB mechanism. Using OOB with NFC enables pairing when devices simply get close, rather than requiring a lengthy discovery process.
Out of Band (OOB)	Allows exchange of information used in the pairing process. Pairing is completed using the Bluetooth radio, but requires information from the OOB mechanism.
Symbol Serial Interface (SSI)	Allows for communication with Bluetooth Imager.
File Transfer Profile (FTP)	Provides the capability to browse, manipulate and transfer files in file system of another system. Uses GOEP as a basis.
Generic Attribute Profile (GATT)	Provides profile discovery and description services for Bluetooth Low Energy protocol. It defines how attributes are grouped together into sets to form services.
HID Over GATT Profile (HOGP)	Defines the procedures and features used by Bluetooth low energy HID Devices using GATT and Bluetooth HID Hosts using GATT.

Table 8 Bluetooth Profiles (Continued)

Profile	Description
Scan Parameters Profile (ScPP)	Provides devices with information to assist them in managing their connection idle timeout and advertising parameters to optimize for power consumption and/or reconnection latency.
Dial Up Networking (DUN)	Provides a standard to access the Internet and other dial-up services over Bluetooth.
Generic Access Profile (GAP)	Use for device discovery and authentication.
Object EXchange (OBEX)	Facilitates the exchange of binary objects between devices.

Bluetooth Power States

The Bluetooth radio is off by default.

- Suspend - When the device goes into suspend mode, the Bluetooth radio stays on.
- Airplane Mode - When the device is placed in Airplane Mode, the Bluetooth radio turns off. When Airplane mode is disabled, the Bluetooth radio returns to the prior state. When in Airplane Mode, the Bluetooth radio can be turned back on if desired.

Bluetooth Radio Power

Turn off the Bluetooth radio to save power or if entering an area with radio restrictions (for example, an airplane). When the radio is off, other Bluetooth devices cannot see or connect to the device. Turn on the Bluetooth radio to exchange information with other Bluetooth devices (within range). Communicate only with Bluetooth radios in close proximity.



NOTE: To achieve the best battery life, turn off radios when not in use.

Enabling Bluetooth

1. Swipe down from the Status bar to open the Notification panel.
2. Touch  to turn Bluetooth on.
3. Touch the Home button.

Disabling Bluetooth

1. Swipe down from the Status bar to open the Notification panel.
2. Touch  to turn Bluetooth off.
3. Touch the Home button.

Discovering Bluetooth Device(s)

The device can receive information from discovered devices without pairing. However, once paired, the device and a paired device exchange information automatically when the Bluetooth radio is on.

1. Ensure that Bluetooth is enabled on both devices.
2. Ensure that the Bluetooth device to discover is in discoverable mode.
3. Ensure that the two devices are within 10 meters (32.8 feet) of one another.

4. Swipe down from the Status bar to open the Quick Access panel.
5. Touch and hold **Bluetooth**.
6. Touch **Pair new device**. The device begins searching for discoverable Bluetooth devices in the area and displays them under **Available devices**.
7. Scroll through the list and select a device. The Bluetooth pairing request dialog box appears.
8. Touch **Pair** on both devices.
9. The Bluetooth device is added to the **Paired devices** list and a trusted (“paired”) connection is established.

Changing the Bluetooth Name

By default, the device has a generic Bluetooth name that is visible to other devices when connected.

1. Go to **Settings**.
2. Touch **Connected devices > Connection preferences > Bluetooth**.
3. If Bluetooth is not on, move the switch to turn Bluetooth on.
4. Touch **Device name**.
5. Enter a name and touch **RENAME**.
6. Touch the Home button.

Connecting to a Bluetooth Device

Once paired, connect to a Bluetooth device.

1. Go to **Settings**.
2. Touch **Connected devices > Connection preferences > Bluetooth**.
3. In the list, touch the unconnected Bluetooth device.

When connected, **Connected** appears below the device name.

Selecting Profiles on the Bluetooth Device

Some Bluetooth devices have multiple profiles.

1. Go to **Settings**.
2. Touch **Connected devices > Connection preferences > Bluetooth**.
3. In the **Paired Devices** list, touch  next to the device name.
4. Turn on or off a profile to allow the device to use that profile.
5. Touch the Home button.

Unpairing a Bluetooth Device

Unpairing a Bluetooth device erases all pairing information.

1. Go to **Settings**.
2. Touch **Connected devices > Connection preferences > Bluetooth**.
3. In the **Paired Devices** list, touch  next to the device name.

4. Touch **FORGET**.
5. Touch the Home button.

Cast

Use **Cast** to mirror the device screen on a Miracast enabled wireless display.

1. Go to **Settings**.
2. Touch **Connected devices > Connection preferences > Cast**.
3. Touch **⋮ > Enable wireless display**.
The device searches for nearby Miracast devices and lists them.
4. Touch a device to begin casting.
5. Touch the Home button.

Near Field Communications

NFC/HF RFID is a short-range wireless connectivity technology standard that enables secure transaction between a reader and a contactless smartcard. The technology is based on ISO/IEC 14443 type A and B (proximity), ISO/IEC 15693 (vicinity), and FeliCa standards, using the HF 13.56 MHz unlicensed band.

The device supports the following operating modes:

- Reader mode
- Peer-to-Peer communication
- Card Emulation mode.

Using NFC, the device can:

- Read contactless cards such as contactless tickets, ID cards and ePassport.
- Read and write information to contactless cards such as SmartPosters and tickets, as well as devices with NFC interface such as vending machines.
- Read information from supported medical sensors.
- Pair with supported Bluetooth devices such as printers , ring scanners (ex. RS6000), and headsets (ex. HS3100).
- Exchange data with another NFC device.
- Emulate contactless card such as payment, or ticket.

The device NFC antenna is positioned to read NFC cards from the top of the device while the device is being held.

Reading NFC Cards

Read contactless cards using NFC.

1. Launch an NFC enabled application.
2. Move the card to the NFC antenna on the back of the device.
3. Hold the card steadily until the transaction is complete (usually indicated by the application).

Enterprise NFC Settings

Improve NFC performance or increase battery life by selecting which NFC features to use on the device.

- **Card Detection Mode** - Select a card detection mode.
 - **Low** - Increases battery life by lowering the NFC detection speed.
 - **Hybrid** - Provides a balance between NFC detection speed and battery life (default).
 - **Standard** - Provides the best NFC detection speed, but reduces battery life.
- **Supported Card Technology** - Select an option to detect only one NFC tag type, increasing battery life, but reducing detection speed.
 - **All (Default)** - Detects all NFC tag types.
 - **ISO 14443 Type A/B**
 - **FeliCa**
 - **ISO15693**
- **Other NFC settings available with Zebra administrator tools (CSP)** - Allows configuration of additional Enterprise NFC Settings through staging tools and Mobile Device Management (MDM) solutions with an MX version that supports the Enterprise NFC Settings Configuration Service Provider (CSP). For more information on using the Enterprise NFC Settings CSP, refer to: techdocs.zebra.com.

Data Capture

The L10 supports data capture using the following devices:

- Internal scanner (XPAD model only, built-in)
- RS507x Hands-free Imager
- RS5100 Ring Scanner
- RS6000 Bluetooth Ring Scanner
- DS3578 Bluetooth Scanner
- DS3608 USB Scanner.

Operational Modes

The imager supports two modes of operation, listed below. Activate each mode by pressing the Scan button.

- **Decode Mode:** In this mode, the scanner attempts to locate and decode enabled barcodes within its field of view. The imager remains in this mode as long as you hold the scan button, or until it decodes a barcode.



NOTE: To enable picklist mode, configure this mode in DataWedge or in an application using an API command. The picklist mode is dependent upon the scanner. Refer to the scanner user guide for more information.

- **Picklist Mode:** This mode lets you selectively decode a barcode when more than one barcode is in the scanner's field of view. To accomplish this, move the aiming crosshair or dot over the required barcode to decode only this barcode. This feature is ideal for picklists containing multiple barcodes and manufacturing or transport labels containing more than one barcode type (either 1D or 2D).

Scanning Considerations

Scanning consists of aim, scan, and decode. Scanning performance can be optimized by considering the range and the scanning angle.

Range

Any scanning device decodes well over a particular working range (minimum and maximum distances from the barcode). This range varies according to barcode density and scanning device optics.

Scanning within range brings quick and constant decodes; scanning too close or too far away prevents decodes. Move the scanner closer and further away to find the right working range for the barcodes being scanned. However, the situation is complicated by the availability of various integrated scanning modules. The best way to specify the appropriate working range per barcode density is through a chart called a decode zone for each scan module. A decode zone simply plots working range as a function of minimum element widths of barcode symbols.

Angle

The scan angle is important for optimizing decode performance. When laser beams reflect directly back into the scanner from the barcode, this specular reflection can “blind” the scanner.

To avoid this, scan the barcode so that the beam does not bounce directly back. But do not scan at too sharp an angle; the scanner needs to collect scattered reflections from the scan to make a successful decode. Practice quickly shows what tolerances to work within.



NOTE: Contact the Zebra Global Customer Support if chronic scanning difficulties develop. Decoding of properly printed barcodes should be quick and effortless.

Imaging

The imagers have the following features:

- Omnidirectional (360°) reading of a variety of barcode symbologies, including the most popular linear, postal, PDF417, and 2-D matrix code types.
- The ability to capture and download images to a host for a variety of imaging applications.
- Advanced intuitive laser aiming for easy point-and-shoot operation.

The imager uses digital camera technology to take a digital picture of a barcode, stores the resulting image in its memory, and executes state-of-the-art software decoding algorithms to extract the data from the image.

Integrated Barcode Scanner (XPAD Only)

The optional XPAD L10 scanner is a factory-installed device consisting of a barcode optical image reader and hardware decoder. The SE4710 scanner is built in to the handle of the XPAD L10 tablet.

Figure 21 Barcode Scanner



RS507/RS507X Hands-Free Imager

The RS507/RS507X Hands-free Imager is a wearable barcode scan solution for both 1D and 2D barcode symbologies.

Figure 22 RS507/RS507X Hands-Free Imager

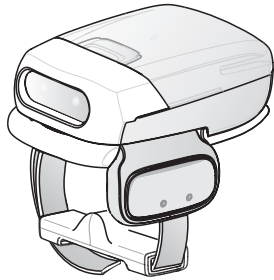

Refer to the RS507/RS507X Hands-free Imager Product Reference Guide for more information.

RS5100 Ring Scanner

The RS5100 Ring Scanner is a wearable barcode scan solution for both 1D and 2D bar code symbologies.

Figure 23 RS5100 Ring Scanner

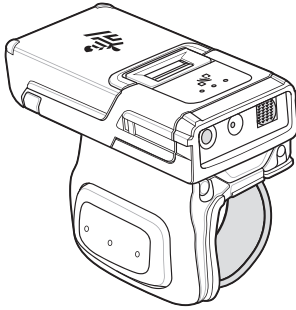

Refer to the RS5100 Ring Scanner Product Reference Guide for more information.

RS6000 Bluetooth Ring Scanner

The RS6000 Bluetooth Ring Scanner is a wearable barcode scan solution for both 1D and 2D barcode symbologies.

Figure 24 RS6000 Bluetooth Ring Scanner

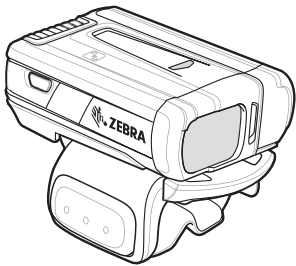

Refer to the RS6000 Bluetooth Ring Scanner Product Reference Guide for more information.

DS3608 Digital Scanner

The corded DS3608 combines superior 1D and 2D omnidirectional barcode scanning performance and advanced ergonomics in a lightweight design. Refer to the DS36X8 Product Reference Guide for more information.

Figure 25 DS3608 Digital Scanner

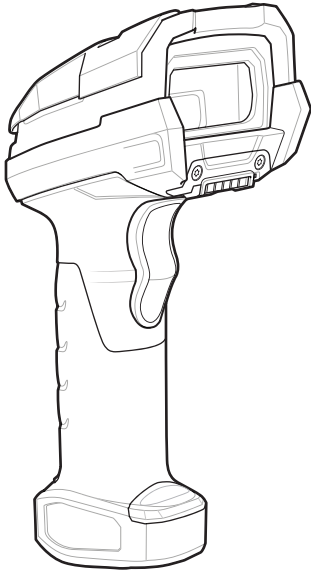

Scanning with the Barcode Scanner (XPAD Only)

To read a barcode, a scan-enabled app is required. Devices that contain the Zebra DataWedge app allows you to enable the scanner to decode barcode data and display the barcode content.

1. On the tablet, open the application software that is going to receive the barcode data and put the active cursor in the appropriate field of that software.
2. Aim the scanner lens at the barcode.
3. Press and hold the Barcode Scanning button on top of the handle. Make sure that the red scan beam covers the entire barcode.



1	barcode scanning button
2	barcode scanner

If the scan is successful, there is a confirmation beep and the data appears in the application.

Scanning with RS507/RS507X Hands-Free Imager

To read a barcode, a scan-enabled app is required. The device contains the DataWedge app that allows you to enable the scanner to decode barcode data and display the barcode content.

To scan with the RS507/RS507X:

1. Pair the RS507/RS507X with the device. [Pairing a Bluetooth Scanner on page 95](#) for more information.
2. Ensure that an app is open on the device and a text field is in focus (text cursor in text field).
3. Point the RS507/RS507X at a barcode.

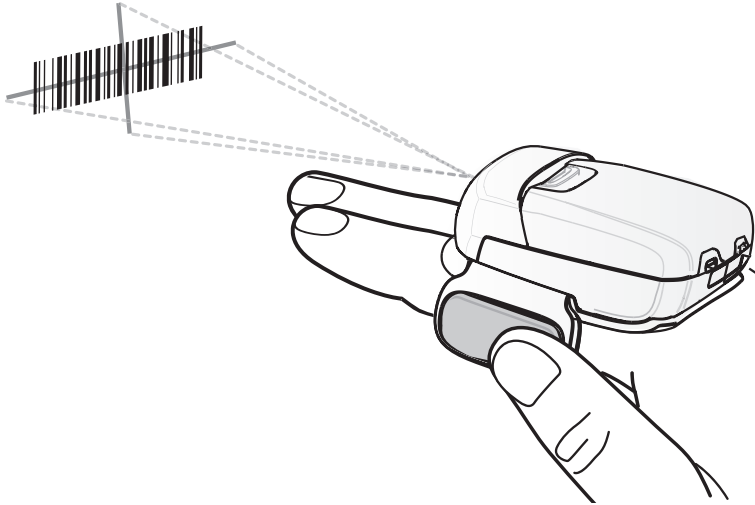

4. Press and hold the trigger.

The red laser aiming pattern turns on to assist in aiming. Ensure the barcode is within the area formed by the cross-hairs in the aiming pattern. The aiming dot increases visibility in bright lighting conditions.

The RS507/RS507X LEDs light green and a beep sounds to indicate the barcode was decoded successfully. When the RS507/RS507X is in Pick List mode, the RS507/RS507X does not decode the barcode until the center of the crosshair touches the barcode.

Figure 26 RS507/RS507X Aiming Pattern



Figure 27 RS507/RS507X Pick List Mode with Multiple Barcodes in Aiming Pattern



5. The captured data appears in the text field.

Scanning with RS5100 Ring Scanner

To read a barcode, a scan-enabled app is required. The device contains the DataWedge app that allows you to enable the scanner to decode barcode data and display the barcode content.

To scan with the RS5100:

1. Pair the RS5100 with the device. See [Pairing a Bluetooth Scanner on page 95](#) for more information.
2. Ensure that an app is open on the device and a text field is in focus (text cursor in text field).
3. Point the RS5100 at a barcode.

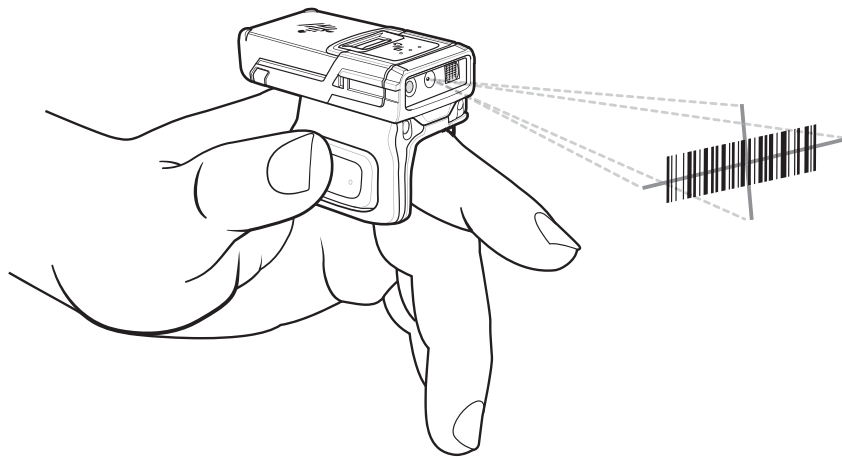

4. Press and hold the trigger.

The red laser aiming pattern turns on to assist in aiming. Ensure the barcode is within the area formed by the cross-hairs in the aiming pattern. The aiming dot increases visibility in bright lighting conditions.

The RS5100 LEDs light green and a beep sounds to indicate the barcode was decoded successfully. When the RS5100 is in Pick List mode, the RS5100 does not decode the barcode until the center of the crosshair touches the barcode.

Figure 28 RS5100 Aiming Pattern**Figure 29** RS5100 Pick List Mode with Multiple Barcodes in Aiming Pattern

5. The captured data appears in the text field.

Scanning with RS6000 Bluetooth Ring Scanner

To read a barcode, a scan-enabled app is required. Devices that contain the Zebra DataWedge app allows you to enable the scanner to decode barcode data and display the barcode content.

To scan with the RS6000:

1. Pair the RS6000 with the device. See [Pairing a Bluetooth Scanner on page 95](#) for more information.
2. Ensure that an app is open on the device and a text field is in focus (text cursor in text field).
3. Point the RS6000 at a barcode.

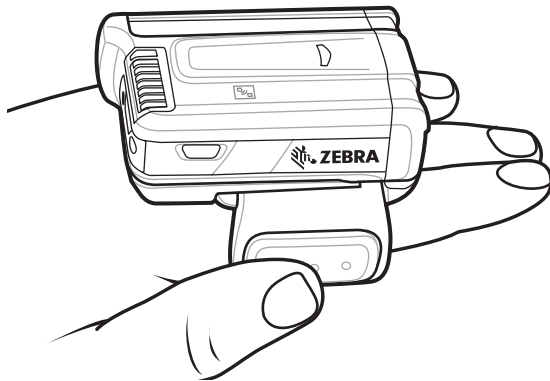

4. Press and hold the trigger.

The red laser aiming pattern turns on to assist in aiming. Ensure the barcode is within the area formed by the cross-hairs in the aiming pattern. The aiming dot increases visibility in bright lighting conditions.

The RS6000 LEDs light green and a beep sounds to indicate the barcode was decoded successfully. When the RS6000 is in Pick List mode, the RS6000 does not decode the barcode until the center of the crosshair touches the barcode.

Figure 30 RS6000 Aiming Pattern

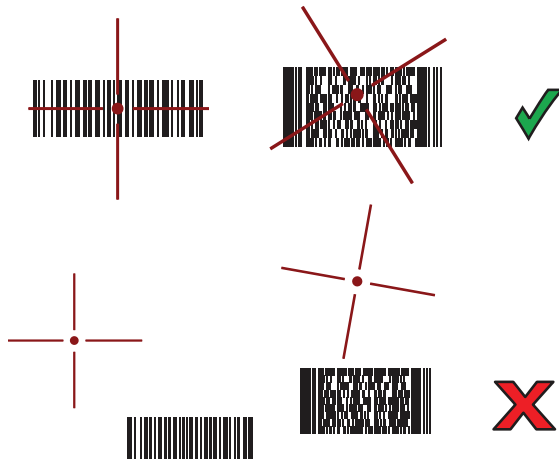

Figure 31 RS6000 Pick List Mode with Multiple Barcodes in Aiming Pattern



5. The captured data appears in the text field.

Scanning with the DS3608 Scanner

To scan:

1. Connect the USB scanner to the device or pair the Bluetooth scanner with the device. For more information, see [Connecting a USB Scanner on page 96](#) for the USB scanners.
2. Ensure that an app is open on the device and a text field is in focus (text cursor in text field).
3. Point the scanner at a barcode.

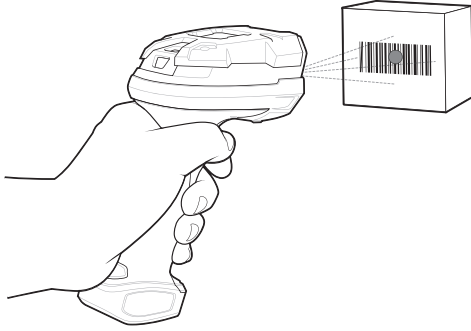

4. Press and hold the trigger.

Ensure the barcode is within the area formed by the aiming pattern. The aiming dot increases visibility in bright lighting conditions.

Figure 32 DS3608 Aiming Pattern

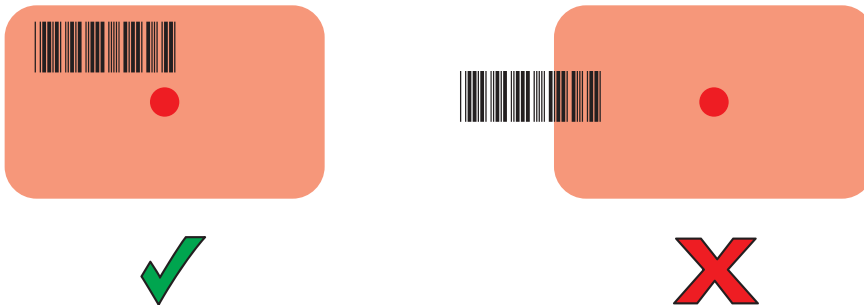
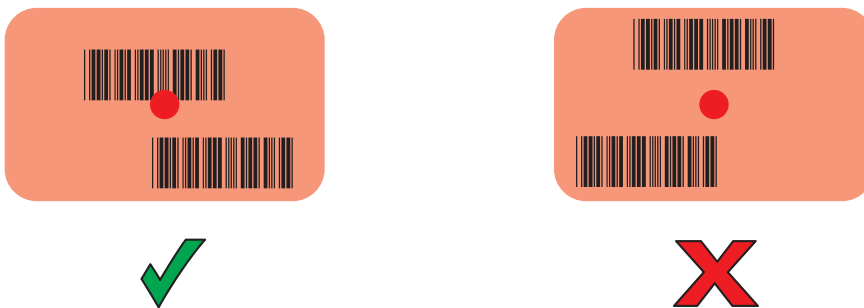

Figure 33 DS3608 Pick List Mode with Multiple Barcodes in Aiming Pattern



5. The captured data appears in the text field.

Pairing the RS507/RS5100/RS6000 Ring Scanner

To connect the ring scanner to the device, use one of the following methods:

- Simple Serial Interface (SSI)
- Bluetooth Human Interface Device (HID) Mode.

Pairing Using Simple Serial Interface (SSI)

To pair the RS507, RS5100, or RS6000 with the device using SSI.

1. Swipe up from the bottom of the Home screen and touch .

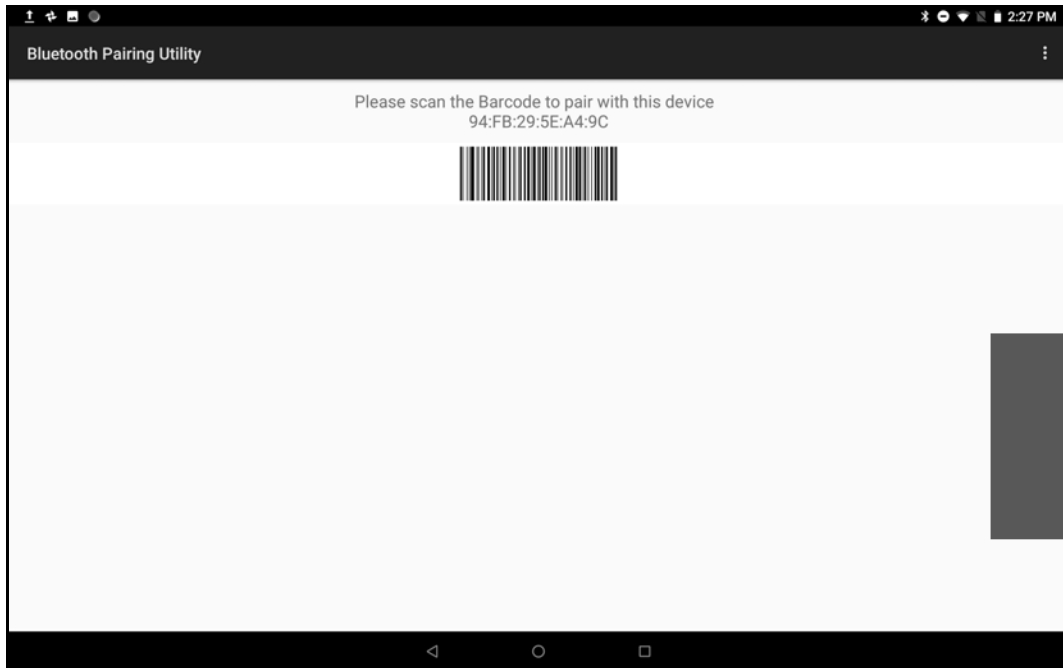

2. Using the ring scanner, scan the barcode on the screen.

The ring scanner emits a string of high/low/high/low beeps. The Scan LED flashes green indicating that the ring scanner is attempting to establish connection with the device. When connection is established, the Scan LED turns off and the ring scanner emits one string of low/high beeps.

A notification appears on the Notification panel and the  icon appears in the Status bar.

Pairing Using Bluetooth Human Interface Device

To pair the ring scanner with the device using Human Interface Device (HID):

1. Ensure that Bluetooth is enabled on both devices.
2. Ensure that the Bluetooth device to discover is in discoverable mode.
3. Ensure that the two devices are within 10 meters (32.8 feet) of one another.
4. Place the ring scanner in HID mode. If the ring scanner is already in HID mode, skip to step 5.
 - a. Remove the battery from the ring scanner.
 - b. Press and hold the Restore key.
 - c. Install the battery onto the ring scanner.
 - d. Keep holding the Restore key for about five seconds until a chirp is heard and the Scan LEDs flash green.
 - e. Scan the barcode below to place the ring scanner in HID mode.

Figure 34 RS507/RS507X Bluetooth HID Barcode

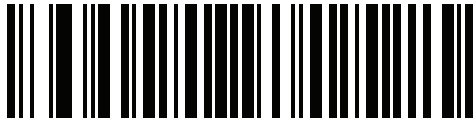

Figure 35 RS5100/RS6000 Bluetooth HID Barcode

5. Remove the battery from the ring scanner.
6. Re-install the battery into the ring scanner.
7. Swipe down from the Status bar to open the Quick Access panel and then touch .
8. Touch **Bluetooth**.
9. Touch **Pair new device**. The device begins searching for discoverable Bluetooth devices in the area and displays them under **Available devices**.
10. Scroll through the list and select the ring scanner.

The device connects to the ring scanner and **Connected** appears below the device name. The Bluetooth device is added to the **Paired devices** list and a trusted (“paired”) connection is established.

A notification appears on Notification panel and the  icon appears in the Status bar.

Pairing a Bluetooth Scanner

Connect the scanner to the device using one of the following methods:

- Simple Serial Interface (SSI) mode
- Bluetooth Human Interface Device (HID) mode.

Pairing Using Simple Serial Interface

To pair the Bluetooth scanner with the device using SSI:

1. Ensure that the two devices are within 10 meters (32.8 feet) of one another.
2. Install the battery into the scanner.
3. On the device swipe up from the bottom of the Home screen and touch .
4. Using the scanner, scan the barcode on the screen.

The scanner emits a high/low/high/low beeps. The Scan LED flashes green indicating that the scanner is attempting to establish connection with the device. When connection is established, the Scan LED turns off and the scanner emits one string of low/high beeps.

5. On the device touch Home.

Pairing Using Bluetooth Human Interface Device

To pair the Bluetooth scanner with the device using HID:

1. Remove the battery from the scanner.
2. Replace the battery.

3. After the scanner reboots, scan the barcode below to place the scanner in HID mode.



4. On the device, swipe down from the Status bar to open the Quick Access panel and then touch .
5. Touch **Bluetooth**.
6. Touch **Pair new device**. The device begins searching for discoverable Bluetooth devices in the area and displays them under **Available devices**.
7. Scroll through the list and select XXXXX xxxxxx, where XXXXX is the scanner and xxxxxx is the serial number.

The device connects to the scanner, the scanner beeps once and **Connected** appears below the device name. The Bluetooth device is added to the **Paired devices** list and a trusted (“paired”) connection is established.

Connecting a USB Scanner

To connect a USB scanner, use one of the following methods:

- Simple Serial Interface (SSI) mode
- Human Interface Device (HID) mode.

Connecting Using Simple Serial Interface

To connect a USB scanner using SSI mode:

1. Connect the scanner cable USB connector to the USB port of the device (using a third-party USC-A to USB-C adapter) or to a vehicle cradle. The scanner beeps.
2. Ensure that the scanner is in SSI mode. Refer to the Refer to the DS36X8 Product Reference Guide and scan the SSI Over USB CDC barcode.

Connecting Using HID Mode

To connect a USB scanner using HID mode:

1. Connect the scanner cable USB connector to the USB port of the device (using a third-party USC-A to USB-C adapter) or to a vehicle cradle. The scanner beeps.
2. Ensure that the scanner is in HID mode. Refer to the Refer to the DS36X8 Product Reference Guide and scan the HID Keyboard barcode or perform a factory reset.

DataWedge

DataWedge is a utility that adds advanced barcode scanning capability to any application without writing code. It runs in the background and handles the interface to built-in barcode scanners. The captured barcode data is converted to keystrokes and sent to the target application as if it was typed on the keypad.

DataWedge allows any app on the device to get data from input sources such as a barcode scanner, MSR, RFID, voice, or serial port and manipulate the data based on options or rules.

Configure DataWedge to:

- Provide data capture services from any app.
- Use a particular scanner, reader or other peripheral device.
- Properly format and transmit data to a specific app.

To configure DataWedge refer to techdocs.zebra.com/datawedge/.

Enabling DataWedge

1. Swipe up from the bottom of the Home screen and touch .
2. Touch **:** > **Settings**.
3. Touch the **DataWedge enabled** checkbox. A blue checkmark appears in the checkbox indicating that DataWedge is enabled.
4. Touch the Home button.

Disabling DataWedge

1. Touch **:**.
2. Touch **Settings**.
3. Touch **DataWedge enabled**.

The blue check disappears from the checkbox indicating that DataWedge is disabled.

Supported Decoders



NOTE: DataWedge supports the decoders listed below but not all are validated on this device.

Table 9 Supported Decoders

Decoders	Internal Imager SE4710	RS5100	RS6000	RS507/RS507X	DS3578	DS3608
Australian Postal	O	O	O	O	O	O
Aztec	X	X	X	X	X	X
Canadian Postal	O	O	O	--	--	--
Chinese 2 of 5	O	O	O	O	O	O

Table 9 Supported Decoders (Continued)

Decoders	Internal Imager SE4710	RS5100	RS6000	RS507/RS507X	DS3578	DS3608
Codabar	X	X	X	X	X	X
Code 11	O	O	O	O	O	O
Code 128	X	X	X	X	X	X
Code 39	X	X	X	X	X	X
Code 93	O	O	O	O	O	O
Composite AB	O	O	O	O	O	O
Composite C	O	O	O	O	O	O
Discrete 2 of 5	O	O	O	O	O	O
Datamatrix	X	X	X	X	X	X
Dutch Postal	O	O	O	O	O	O
DotCode	O	O	O	O	O	O
EAN13	X	X	X	X	X	X
EAN8	X	X	X	X	X	X
Grid Matrix	O	O	O	O	O	O
GS1 DataBar	X	X	X	X	X	X
GS1 DataBar Expanded	X	X	X	X	X	X
GS1 DataBar Limited	O	O	O	O	O	O
GS1 Datamatrix	O	O	O	--	O	O
GS1 QRCode	O	O	O	--	O	O
HAN XIN	--	O	O	--	--	O
Interleaved 2 of 5	O	O	O	O	O	O
Japanese Postal	O	O	O	O	O	O
Korean 3 of 5	O	O	O	O	O	O
MAIL MARK	X	X	X	--	X	X
Matrix 2 of 5	O	O	O	O	O	O
Maxicode	X	X	X	X	X	X
MicroPDF	O	O	O	O	O	O

Table 9 Supported Decoders (Continued)

Decoders	Internal Imager SE4710	RS5100	RS6000	RS507/RS507X	DS3578	DS3608
MicroQR	O	O	O	O	O	O
MSI	O	O	O	O	O	O
PDF417	X	X	X	X	X	X
QR Code	X	X	X	X	X	X
Decoder Signature	O	O	O	O	--	--
TLC 39	O	O	O	O	O	O
Trioptic 39	O	O	O	O	O	O
UK Postal	O	O	O	O	O	O
UPCA	X	X	X	X	X	X
UPCE0	X	X	X	X	X	X
UPCE1	O	O	O	O	O	O
US4state	O	O	O	O	O	O
US4state FICS	O	O	O	O	O	O
US Planet	O	O	O	O	O	O
US Postnet	O	O	O	O	O	O

Key

X = Enabled

O = Disabled

-- = Not Supported

Touch the Back button to return to the previous screen.

Accessories

The L10 accessories provide a variety of product support capabilities. This table lists the available accessories.

Table 10 L10A Accessories

Accessory	Part Number	Description
Docking Solutions		
L10 Vehicle Dock–Cradle	300142 (L10 Vehicle Dock–Cradle, xDIM, CLA) 300144 (L10 Vehicle Dock–Cradle, RF Pass Through, xDIM, CLA)	The L10 Vehicle Dock protects and secures the L10 tablet under heavy shock and vibration. <ul style="list-style-type: none"> • Holds tablet in place under extreme vibration and stress. • Barrel-style keylock to lock tablet into place for secure vehicle docking. Easy one-hand release allows “grab-and-go” transitions between vehicle, field, and office. • Resistant to water and dust.
xDIM G3 Docking Interface Module	300140 (xDIM Module G3, Cigarette Lighter Adapter)	Built for demanding environments. The xDIM G3 docking interface module provides power and connectivity to the vehicle dock and the tablet.
L10 Industrial Dock	300149 (L10 Industrial Dock, NA PWR) 300150 (L10 Industrial Dock, ANZ PWR) 300151 (L10 Industrial Dock, EU PWR)	The Industrial Dock combines the L10 Vehicle Cradle and a sturdy desk stand to hold your Zebra rugged tablet in place. Perfect for touch applications in the plant, warehouse, or office. The dock provides power to the tablet and has two USB ports for expanded connectivity. Add an optional 4K port replicator to gain four USB 3.0 and 2 USB 2.0 ports, DVI, DisplayPort or HDMI, Gigabit Ethernet, microphone in, Stereo speaker out, and security lock slot. <ul style="list-style-type: none"> • Sturdy industrial dock holds the rugged tablet in place while protecting it against drops and other tough usage • Includes xDIM G3 Docking Interface Module, which provides power to the tablet, and two USB ports for attaching a keyboard or other peripherals. • 4K port replicator sold separately

Table 10 L10A Accessories (Continued)

Accessory	Part Number	Description
L10 Industrial Dock	300149 (L10 Industrial Dock, NA PWR) 300150 (L10 Industrial Dock, ANZ PWR) 300151 (L10 Industrial Dock, EU PWR)	4K Port Replicator Front Panel: <ul style="list-style-type: none"> Two always-on USB 2.0 ports (sleep & charge) 3.5mm line-in (microphone/headset) 3.5mm line-out (headphone/headset/speakers) power light USB status light Back Panel: Four USB 3.0 ports RJ-45 10/100/1000 Ethernet Video-out: HDMI (up to 2048x1152) or DisplayPort, DVI-1 (up to 2048x1280), VGA 3 x 3.5mm line-out (5.1 surround sound speakers) DC power in Security lock slot
Power		
L10 Standard Battery: 36 Whr	450148	This battery can be charged while in the rugged tablet or while in the battery charging slot in the docking station. The power meter reports the available battery life. The hot-swappable battery capability allows you to swap the battery without shutting down the tablet. <ul style="list-style-type: none"> This lithium-ion battery has 36 Whr capacity and can power the tablet up to 10 hours (Mobilemark 14). The external LED indicates the approximate remaining battery life. The battery is hot-swappable, so you can change the battery without having to power down the tablet.
L10 Extended Life Battery: 98 Whr	450149	The extended life battery is ideal for working in the field for long periods of time, or for rugged tablets used around the clock for shift work. It powers L10 rugged tablets up to 27 hours on a single charge. This battery attaches to the tablet using the battery bracket kickstand. Large 98 Whr lithium-ion battery keeps the tablet powered for up to 27 hours. The external LED indicates the remaining battery life. It is hot swappable. Requires battery bracket kickstand. Its dimensions are contained within the kickstand; kickstand increases thickness by 0.78 in (0.2cm).
L10 Kickstand and Extended Battery Bracket	410056 (kit)	The kickstand holds your Zebra L10 rugged tablet upright for easy reading and touch while in the field and when using the companion keyboard. When you are ready work while walking, the kickstand folds away. An integrated battery bracket holds the extended battery for up to 27 hours of battery life. You do not need to remove the kickstand and bracket when docking in the Vehicle, office, or industrial docks. It can also be used in combination with the optional soft handle and stylus pen accessory set. Compatible with extended battery and companion keyboard.

Accessories

Table 10 L10A Accessories (Continued)

Accessory	Part Number	Description
L10 Single Bay Battery Charger	450150 (L10 Battery Charger with AC Adapter, US) 450170 (L10 Battery Charger with AC Adapter, AU) 450171 (L10 Battery Charger with AC Adapter, EU) 450172 (L10 Battery Charger with AC Adapter, UK)	Provides maximum power and uptime for your Zebra L10 rugged tablet. This charger keeps your battery powered for maximum performance and industrial use. <ul style="list-style-type: none"> • Can be integrated into the office dock or used as a standalone charger. • Charges either Standard 36 Whr or Extended Life 98 Whr • Standard battery charge time: 2.75 Hrs; extended battery charge time: 3.25 Hrs • Includes power adapter • LED Indicator light for charging status
L10 Power Adapter	450159 (Adapter, US PWR) 450160 (Adapter, ANZ PWR) 450161 (Adapter, EU PWR)	A second AC power adapter lets you keep one adapter in a different location without carrying one with you.
Input Devices		
L10 Back-lit Rugged IP65 Companion Keyboard Available in these languages: <ul style="list-style-type: none"> • US English • UK English • German • French • Spanish 	420095 (Companion Keyboard, US) 420096 (Companion Keyboard, UK) 420097 (Companion Keyboard, DE) 420098 (Companion Keyboard, FR) 420099 (Companion Keyboard, ES)	This keyboard provides a full-travel tactile feedback feel and is spill-resistant. The touch pad supports two-finger and three-finger gestures. This keyboard offers a 2-in-1 laptop/tablet experience for the mobility of a tablet and a notebook-style support for data-intensive tasks. <ul style="list-style-type: none"> • The keyboard is easily removable when docked. • There is no need to charge it, because it is powered by the tablet. • The keyboard closes to cover the display glass for added protection.
Long Active Pen	Pen: 440036 Stylus tip kit: 440042	This active digitizer pen provides precision for writing and annotating on your Zebra L10 tablet. This active digitizer pen provides a range of pressure sensitivity, tilt detection, and hover capability. Hover lets you see where the pen is pointing before the tip touches the display. The attached tether keeps the pen and rugged tablet together. The digitizer pen stores easily in the integrated garage of the XPAD L10 or the soft handle garage of the XSLATE L10 and XBOOK L10.

Table 10 L10A Accessories (Continued)

Accessory	Part Number	Description
Short Active Pen	Pen: 440037 Stylus tip kit: 440042	This compact, active digitizer pen offers precision and comfort when you need to write and annotate on your L10 tablet. This active digitizer pen provides a range of pressure sensitivity, tilt detection, and hover capability. Hover lets you see where the pen is pointing before the tip touches the display. The attached tether keeps the pen and tablet together to prevent loss.
Long Capacitive ePen	440043	This capacitive pen is battery powered and has a 1.5 mm tip that provides pinpoint accuracy for easy writing and annotation on your tablet. It enables pressure sensitivity. This pen fits in the handle of your XPAD L10 tablet. One AAAA battery is included.
Short Capacitive Pen	440007	This compact capacitive pen provides accuracy for easy writing and annotation on your tablet. This pen fits in the handle of your XPAD L10 tablet.
Input Devices: Optional Modules		
Serial, RS232 (optional module)		This module adds true serial capability to your Zebra L10 rugged tablet. It connects from the multifunction port to your legacy serial equipment using a DB9 adapter. This module requires a mounting bracket, which is included with the Extended Battery Kickstand or KickStrap. Note: Must be ordered at the time of tablet purchase. (factory installed)
UHF RFID Reader (AEI) (optional module)		The UHF RFID Reader is a mobile solution designed specifically for Zebra L10 rugged tablets. This solution delivers the mobility and productivity of a hand-held RFID Reader device with the flexibility and functionality of a powerful computer. The UHF RFID (AEI) reader meets safe distance requirements for rail while adding mobility advantages over fixed readers. Note: Must be ordered at the time of tablet purchase. (factory installed)
Carrying Accessories		
L10 KickStrap	410055	This combined kickstand and rotating hand strap provides working comfort for all Zebra L10 rugged tablet models in the field and at a desk. The kickstand closes tightly when you are on the move, and it provides great ergonomics when the tablet is on flat surfaces or when the companion keyboard is attached.

Accessories

Table 10 L10A Accessories (Continued)

Accessory	Part Number	Description
L10 Kickstand	410056	<p>The kickstand holds your Zebra L10 rugged tablet upright when in the field and when using the companion keyboard. The kickstand folds away when you are on the move.</p> <p>You do not need to remove the kickstand/bracket when docking in the vehicle, office, or industrial docks. You can also use it in combination with the soft handle and stylus pen accessory set.</p> <p>An integrated battery bracket holds the extended battery for up to 27 hours of battery life.</p> <p>It can also be used in combination with the optional Soft Handle and Stylus pen accessory set.</p> <ul style="list-style-type: none"> • Holds tablet upright for tablet interactions and for using the companion keyboard. Compatible with all L10 docks. • Easily stored away while on the move. • Excludes standard on-board stylus. • Compatible with top handle and top handle stylus accessory options.
L10 Soft Handle	410052 (L10 Soft Handle w/Coiled tether, without Pen) 410061 (L10 Soft Handle Kit – Active Stylus) 410062 (L10 Soft Handle Kit – ePen)	<p>This handle is available separately. This integrated handle attaches to the top of the tablet, allowing you to carry the tablet easily. The soft handle is made with smooth durable rubber, for a comfortable grip. The handle has a storage slot for either of the long L10 pens. A detachable shoulder strap attaches to the handle for carrying long distances and freeing your hands.</p>
L10 Shoulder Strap	410057	<p>The shoulder strap attaches to the optional top handle. It is ideal for handsfree, long-distance carrying, and is adjustable for height. The wide strap attaches and detaches with clips.</p> <ul style="list-style-type: none"> • It increases your comfort and endurance while standing and walking. • It frees up both hands while carrying the tablet. <p>Length: Adjustable to a maximum length of 4.1 ft (1.28 m)</p>

Table 10 L10A Accessories (Continued)

Accessory	Part Number	Description
L10 Carry Case	410059 (L10 Carry Case - XPAD) 410058 (L10 Carry Case - XSLATE)	<p>This is a professional-grade carrying case designed specifically for your L10 tablet. The integrated handle and optional attachable shoulder strap provide a variety of carrying options. Provides convenient storage for digitizer pens.</p> <p>The carry case lets you work in the field and access the tablet while standing or walking, even when you keep it in the case.</p> <p>Professional Quality</p> <ul style="list-style-type: none"> • Integrated handle for enhanced portability • Lightweight • Support for attachable shoulder strap (sold separately) • Digitizer pen holders (2) for easy storage • Easy access to power button, both cameras and ports
Display Maintenance		
L10 Screen Protector (3 pack)	Contact Zebra for product availability	<p>The L10 Shatter-Resistant Screen Protector Film is an anti-glare, thin protective film with a coating that reduces reflections and gives a clear, sharp display even in brightly-lit conditions.</p> <p>The screen protector works with touch screen and digitizer pen displays to offer additional protection against everyday scratches.</p> <p>Available in a 3-pack for replacement of originally-installed screen protector.</p>
Screen Cleaning Cloth	400000	Keeps your display clean with an approved wiping cloth. These cloths are especially designed to remove dirt and skin oils without damaging the display surface.

Application Deployment

Security

The device implements a set of security policies that determine whether an application is allowed to run and, if allowed, with what level of trust. To develop an application, you must know the security configuration of the device, and how to sign an application with the appropriate certificate to allow the application to run (and to run with the needed level of trust).



NOTE: Ensure the date is set correctly before installing certificates or when accessing secure web sites.

Secure Certificates

If the VPN or Wi-Fi networks rely on secure certificates, obtain the certificates and store them in the device's secure credential storage, before configuring access to the VPN or Wi-Fi networks.

If downloading the certificates from a web site, set a password for the credential storage. The device supports X.509 certificates saved in PKCS#12 key store files with a .p12 extension (if key store has a .pfx or other extension, change to .p12).

The device also installs any accompanying private key or certificate authority certificates contained in the key store.

Installing a Secure Certificate

To install a secure certificate:

1. Copy the certificate from the host computer to the root of the device's internal memory. See [USB Communication on page 36](#) for information about connecting the device to a host computer and copying files.
2. Go to **Settings**.
3. Touch **Security > Advanced > Encryption & credentials**.
4. Touch **Install from storage**.
5. Navigate to the location of the certificate file.
6. Touch the filename of the certificate to install.
7. If prompted, enter the password for credential storage. If a password has not been set for the credential storage, enter a password for it twice and then touch **OK**.
8. If prompted, enter the certificate's password and touch **OK**.

9. Enter a name for the certificate and in the Credential use drop-down, select **VPN and apps** or **Wi-Fi**.
10. Touch **OK**.

The certificate can now be used when connecting to a secure network. For security, the certificate is deleted from the internal memory.

Configuring Credential Storage Settings

1. Go to **Settings**.
2. Touch **Security > Advanced > Encryption & credentials**.
 - **Trusted credentials** - Touch to display the trusted system and user credentials.
 - **User credentials** - Touch to display user credentials.
 - **Install from storage** - Touch to install a secure certificate from the internal storage.
 - **Clear credentials** - Deletes all secure certificates and related credentials.

Development Tools

Development tools for Android include Android Studio, EMDK for Android, and StageNow.

Android Application Development

Development Workstation

Android development tools are available at developer.android.com.

To start developing applications for the device, download Android Studio. Development can take place on a Microsoft® Windows®, Mac® OS X®, or Linux® operating system.

Applications are written in Java or Kotlin, but compiled and executed in the Dalvik virtual machine. Once the Java code is compiled cleanly, the developer tools make sure the application is packaged properly, including the AndroidManifest.xml file.

Android Studio contains a full featured IDE as well as SDK components required to develop Android applications.

Enabling Developer Options

The **Developer options** screen sets development related settings. By default, the Developer Options are hidden.

1. Go to **Settings**.
2. Touch **About phone**.
3. Scroll down to **Build number**.
4. Tap **Build number** seven times. The message **You are now a developer!** appears.
5. Touch the Back button.
6. Touch **System > Advanced > Developer options**.
7. Slide the **USB debugging** switch to the **ON** position.

EMDK for Android

EMDK for Android provides developers with tools to create business applications for enterprise mobile devices. It is designed for use with Google's Android Studio and includes Android class libraries such as Barcode, sample applications with source code, and the associated documentation.

EMDK for Android allows applications to take full advantage of the capabilities that Zebra devices have to offer. It embeds Profile Manager technology within Android Studio IDE, providing a GUI-based development tool designed specifically for Zebra devices. This allows fewer lines of code, resulting in reduced development time, effort, and errors.

For more information go to: techdocs.zebra.com.

StageNow

StageNow is Zebra's next-generation Android Staging Solution built on the MX platform. It allows quick and easy creation of device profiles, and can deploy to devices simply by scanning a barcode, reading a tag, or playing an audio file.

The StageNow Staging Solution includes the following components:

- The StageNow Workstation tool installs on the staging workstation (host computer) and lets the administrator easily create staging profiles for configuring device components, and perform other staging actions such as checking the condition of a target device to determine suitability for software upgrades or other activities. The StageNow Workstation stores profiles and other created content for later use.
- The StageNow Client resides on the device and provides a user interface for the staging operator to initiate staging. The operator uses one or more of the desired staging methods (print and scan a barcode, read an NFC tag or play an audio file) to deliver staging material to the device.

For more information go to: techdocs.zebra.com.

GMS Restricted

GMS Restricted mode deactivates Google Mobile Services (GMS). All GMS apps are removed from the device and communication with Google (analytics data collection and location services) is disabled. It also provides enhanced security and privacy.

Use StageNow to disable or enable GMS Restricted mode. After a device is in GMS Restricted mode, enable and disable individual GMS apps and services using StageNow. To ensure GMS Restricted mode persists after an Enterprise Reset, use the Persist Manager option in StageNow. For more information on StageNow, refer to techdocs.zebra.com.

ADB USB Setup

To use the ADB, install the USB driver. This assumes that the development SDK has been installed on the host computer. Go to developer.android.com/sdk/index.html for details on setting up the development SDK.

ADB driver for Windows and Linux are available on the Zebra Support Central web site at www.zebra.com/support. Download the ADB and USB Driver Setup package. Follow the instructions with the package to install the ADB and USB drivers for Windows and Linux.

Enabling USB Debugging

By default, USB debugging is disabled.

1. Go to **Settings**.
2. Touch **About phone**.
3. Scroll down to **Build number**.
4. Tap **Build number** seven times. The message **You are now a developer!** appears.
5. Touch the Back button.
6. Touch **System > Advanced > Developer options**.
7. Slide the **USB debugging** switch to the **ON** position.
8. Touch **OK**.
9. Connect the device to the host computer using the Rugged Charge/USB Cable.
The **Allow USB debugging?** dialog box appears on the device.
10. On the device, touch **OK**.
11. On the host computer, navigate to the **platform-tools** folder.
12. Type **adb devices**.
The following displays:
List of devices attached
XXXXXXXXXXXXXXXXX device (where XXXXXXXXXXXXXXXXXXXX is the device number).



NOTE: If device number does not appear, ensure that ADB drivers are installed properly.

13. Touch the Home button.

Application Installation

After an application is developed, install the application onto the device using one of the following methods:

- USB drive, see [Installing Applications Using a USB Drive on page 109](#).
- Android Debug Bridge, see [Installing Applications Using the Android Debug Bridge on page 110](#).
- Mobile device management (MDM) platforms that have application provisioning. Refer to the MDM software documentation for details.

Installing Applications Using a USB Drive



IMPORTANT: USB Drive must have FAT32 format.

1. Plug the USB drive into the USB port on the host computer.
2. On the host computer, open a file explorer application.
3. Copy the application **.apk** file from the host computer to the USB drive.



CAUTION: Follow the host computer's instructions to eject the USB drive correctly to avoid losing information.

4. Eject the USB drive from the host computer.

5. Remove the dust cover on the back of the device. See [Figure 4 on page 18](#).
6. Plug the USB drive into the USB port on the device, see [Figure 4 on page 18](#). A notification appears indicating that the device detected the USB drive.
7. Swipe the screen up and select  to view files on the USB drive.
8. Touch **General USB drive**.
9. Locate the application .apk file.
10. Touch the application file.
11. Touch **Continue** to install the app or **Cancel** to stop the installation.
12. To confirm installation and accept what the application affects, touch **Install** otherwise touch **Cancel**.
13. Touch **Open** to open the application or **Done** to exit the installation process. The application appears in the App list.
14. Disconnect the USB drive from the host computer.

Installing Applications Using the USB Connection

1. Pull down the Notification panel and touch **Charging this device via USB**.
2. Touch **File Transfer**.
3. On the host computer, open a file manager application.
4. On the host computer, copy the application .apk file from the host computer to the device.
5. Disconnect the device from the host computer.
6. Swipe the screen up and select  to view files on the Internal Storage.
7. Locate the application .apk file.
8. Touch the application file.
9. Touch **Continue** to install the app or **Cancel** to stop the installation.
10. To confirm installation and accept what the application affects, touch **Install** otherwise touch **Cancel**.
11. Touch **Open** to open the application or **Done** to exit the installation process. The application appears in the App list.

Installing Applications Using the Android Debug Bridge

Use ADB commands to install application onto the device.



CAUTION: When connecting the device to a host computer, follow the host computer's instructions for connecting and disconnecting USB devices, to avoid damaging or corrupting files.

1. Ensure that the ADB drivers are installed on the host computer. See [ADB USB Setup on page 108](#).
2. Using a T10 Torx screwdriver, remove four screws securing the top cover to the device.

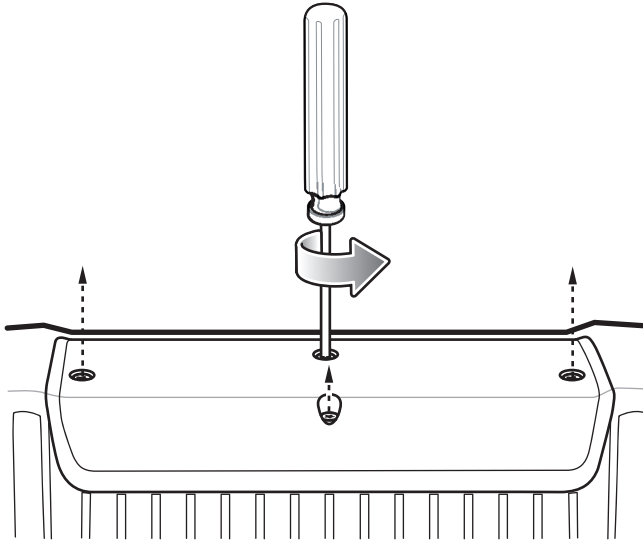
Figure 36 Remove Top Cover

CAUTION: When the user connects a USB cable to the USB-C port on top of the device, the USB and RS-232 ports on the bottom are disabled.

3. Connect the device to a host computer using USB-C cable. See [USB Communication on page 36](#).
4. Go to **Settings**.
5. Touch **System > Advanced > Developer options**.
6. Slide the switch to the **ON** position.
7. Touch **USB Debugging**. A check appears in the check box. The **Allow USB debugging?** dialog box appears.
8. Touch **OK**.
9. On the host computer, open a command prompt window and use the adb command:
`adb install <application>`
 where: <application> = the path and filename of the apk file.
10. Disconnect the device from the host computer. See [USB Communication on page 36](#).
11. Disconnect the USB-C cable from the device.
12. Replace the top cover.
13. Secure the top cover to the device using the four screws.

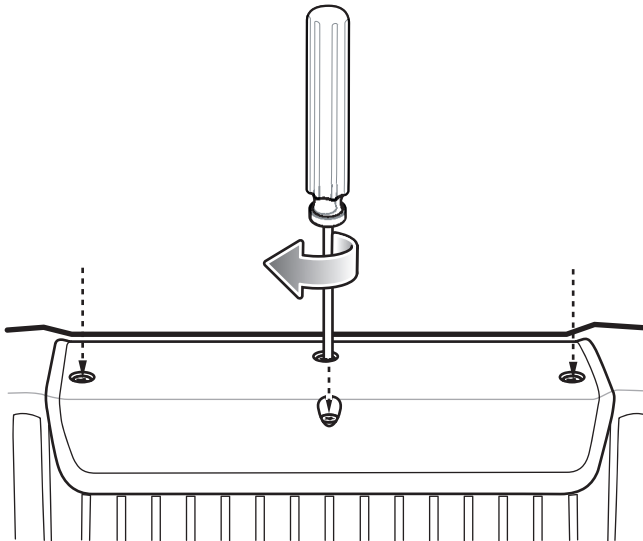
Figure 37 Replace Top Cover

14. Torque the screws to 6kg-cm (5.2lbs-in).

Uninstalling an Application

1. Go to **Settings**.
2. Touch **Apps & notifications**.
3. Touch **See all apps** to view all apps in the list.
4. Scroll through the list to the app.
5. Touch the app. The **App info** screen appears.
6. Touch **Uninstall**.
7. Touch **OK** to confirm.

Performing a System Update

System Update packages can contain either partial or complete updates for the operating system. Zebra distributes the System Update packages on the Zebra Support & Downloads web site. Perform a system update using ADB.

Downloading the System Update Package

1. Go to the Zebra Support & Downloads web site, www.zebra.com/support.
2. Download the appropriate System Update package to a host computer.
3. Press the Up and Down arrow keys to navigate to the System Update file.

Performing a System Update Using USB Drive



WARNING: Do not remove the USB drive during system update. Damage to device can occur.

To update the system using a USB drive:



IMPORTANT: USB drive must have FAT32 format.

1. Install the USB drive into the host computer USB port.
2. Copy the System Update zip file to the root of a USB drive.
3. Properly eject the USB drive from host computer and remove the USB drive.
4. Remove the dust cover from the back of the device.
5. Insert the USB drive into the USB port.
6. Press and hold the Power button until the menu appears.
7. Touch **Restart**. The device resets.
8. Press and hold the **blue+** button until the Zebra logo screen appears. The System Recovery screen appears.
9. Press the Volume Up and Volume Down buttons to navigate to **apply upgrade from USB drive**.
10. Press the Power button.
11. Use the Volume Up and Volume Down buttons to navigate to the System Update zip file.
12. Press the Power button. The System Update installs and then the device returns to the Recovery screen.
13. Press the Power button to reboot the device.

Performing a System Update Using ADB

1. Using a T10 Torx screwdriver, remove four screws securing the top cover to the device.



IMPORTANT: When the user connects a USB cable to the USB-C port on top of the device, the USB and RS-232 ports on the bottom are disabled.

2. Connect the device to a host computer using a USB-C cable.
3. Go to **Settings**.
4. Touch **System > Advanced > Developer options**.
5. Slide the switch to the **ON** position.
6. Touch **USB Debugging**. A check appears in the check box. The **Allow USB debugging?** dialog box appears.
7. Touch **OK**.
8. On the host computer, open a command prompt window and use the adb command:

```
adb devices
```

The following displays:

```
List of devices attached
```

```
XXXXXXXXXXXXXXXXX device (where XXXXXXXXXXXXXXXXXXXX is the device number).
```



NOTE: If device number does not appear, ensure that ADB drivers are installed properly.

- Type:
`adb reboot recovery`
- Press Enter. The System Recovery screen appears on the device.
- Press the Up and Down buttons to navigate to **Apply upgrade from ADB**.
- Use the Up and Down buttons to navigate to **Full OTA Package** or **Diff OTA Package**.
- Press the Power button.
- On the host computer command prompt window type:
`adb sideload <file>`
where: <file> = the path and filename of the zip file.
- Press Enter. The System Update installs (progress appears as percentage in the Command Prompt window) and then the System Recovery screen appears on the device.
- Disconnect the USB-C cable from the device.
- Replace the top cover.
- Secure the top cover to the device using the four screws. See [Figure 37 on page 112](#).
- Torque the screws to 6kg-cm (5.2lbs-in).

Verifying System Update Installation

- Go to **Settings**.
- Touch **About phone**.
- Scroll down to **Build number**.
- Ensure that the build number matches the new system update package file number.

Enterprise Reset

An Enterprise Reset erases all user data in the `/data` partition, including data in the primary storage locations (`/sdcard` and emulated storage).

Before performing an Enterprise Reset, provision all necessary configuration files and restore after the reset.

Perform Enterprise Reset using device settings, or ADB.

Perform Enterprise Reset using device settings, a USB drive, or using ADB.

Performing an Enterprise Reset From Device Settings

- Go to **Settings**.
- Touch **System > Reset options > Erase all data (enterprise reset)**.
- Touch **Erase all data** twice to confirm the Enterprise Reset.

Downloading the Enterprise Reset Package

- Go to the Zebra Support & Downloads web site, www.zebra.com/support.
- Download the Enterprise Reset file to a host computer.

Performing an Enterprise Reset Using a USB Drive

To perform an Enterprise Reset using USB drive:

1. Copy the Enterprise Reset zip file to the root of the USB drive.
 - Copy the zip file to a USB drive using a host computer and then installing the USB drive into the device.
 - Connect the device with a USB drive already installed to the host computer and copy zip file to the USB drive. Disconnect the device from the host computer.
2. Press and hold the Power button until the menu appears.
3. Touch **Restart**. The device resets.
4. Press and hold the **blue** button until the Zebra boot screen appears. The Android Recovery screen appears.
5. Press the Up and Down buttons to navigate to the **apply update from USB drive**.
6. Press the Power button.
7. Press the Up and Down buttons to navigate to the Enterprise Reset file.
8. Press the Power button. The Enterprise Reset occurs and then the device returns to the Recovery screen.
9. Press the Power button.

Performing an Enterprise Reset Using ADB

1. Using a T10 Torx screwdriver, remove four screws securing the top cover to the device. See [Figure 36 on page 111](#).



IMPORTANT: When the user connects a USB cable to the USB-C port on top of the device, the USB and RS-232 ports on the bottom are disabled.

2. Connect the device to a host computer using a micro USB-C cable.
3. Go to **Settings**.
4. Touch **System > Advanced > Developer options**.
5. Slide the switch to the **ON** position.
6. Touch **USB Debugging**. A check appears in the check box. The **Allow USB debugging?** dialog box appears.
7. Touch **OK**.
8. On the host computer, open a command prompt window and type:

```
adb devices.
```

The following displays:

List of devices attached

XXXXXXXXXXXXXXXXX device (where XXXXXXXXXXXXXXXXXXXX is the device number).



NOTE: If device number does not appear, ensure that ADB drivers are installed properly.

9. Type:
`adb reboot recovery`
10. Press Enter. The System Recovery screen appears on the device.
11. Press the Up and Down buttons to navigate to **Apply upgrade from ADB**.
12. Press the Power button.
13. Press the Up and Down buttons to navigate to **Full OTA Package**.
14. Press the Power button.
15. On the host computer command prompt window type:
`adb sideload <file>`
where: <file> = the path and filename of the zip file.
16. Press Enter. The Enterprise Reset package installs and then the System Recovery screen appears on the device.
17. Press the Power button to reboot the device.
18. Disconnect the USB-C cable from the device.
19. Replace the top cover.
20. Secure the top cover to the device using the four screws. See [Figure 37 on page 112](#).
21. Torque the screws to 6kg-cm (5.2lbs-in).

Performing a Factory Reset

A Factory Reset erases all data in the `/data` and `/enterprise` partitions in internal storage and clears all device settings. A Factory Reset returns the device to the last installed operating system image. To revert to a previous operating system version, re-install that operating system image. See [Performing a System Update](#) for more information.

Downloading the Factory Reset Package

To download the Factory Reset package:

1. Go to the Zebra Support & Downloads web site, www.zebra.com/support.
2. Download the appropriate Factory Reset file to a host computer.

Performing a Factory Reset Using a USB Drive

1. Copy the Factory Reset zip file to the root of the USB drive.
 - Copy the zip file to a USB drive using a host computer and then installing the USB drive into the device.
 - Connect the device with a USB drive already installed to the host computer and copy the zip file to the USB drive. Disconnect the device from the host computer.
2. Press and hold the Power button until the menu appears.
3. Touch **Restart**. The device resets.
4. Press and hold the **blue** button until the Zebra boot screen. The System Recovery screen appears.

5. Press the Up and Down buttons to navigate to the **apply update from USB drive**.
6. Press the Power button.
7. Press the Up and Down buttons to navigate to the Android Reset file.
8. Press the Power button. The Factory Reset occurs and then the device returns to the Recovery screen.
9. Press the Power button.

Performing a Factory Reset Using ADB

To perform an Factory Reset using ADB:

1. Using a T10 Torx screwdriver, remove four screws securing the top cover to the device. See [Figure 36 on page 111](#).



IMPORTANT: When the user connects a USB cable to the USB-C port on top of the device, the USB and RS-232 ports on the bottom are disabled.

2. Connect the device to a host computer using a USB-C cable.
3. Go to **Settings**.
4. Touch **System > Advanced > Developer options**.
5. Slide the switch to the **ON** position.
6. Touch **USB Debugging**. A check appears in the check box. The **Allow USB debugging?** dialog box appears.
7. Touch **OK**.
8. On the host computer, open a command prompt window and type:

```
adb devices.
```

The following displays:

```
List of devices attached
```

```
XXXXXXXXXXXXXXXXX device (where XXXXXXXXXXXXXXXXXXXX is the device number).
```



NOTE: If device number does not appear, ensure that ADB drivers are installed properly.

9. Type:

```
adb reboot recovery
```
10. Press Enter. The System Recovery screen appears on the device.
11. Press the Up and Down buttons to navigate to **Apply upgrade from ADB**.
12. Press the Power button.
13. Press the Up and Down buttons to navigate to **Full OTA Package**.
14. Press the Power button.
15. On the host computer command prompt window type:

```
adb sideload <file>
```

where: <file> = the path and filename of the zip file.
16. Press Enter. The Factory Reset package installs and then the System Recovery screen appears on the device.

17. Press the Power button to reboot the device.
18. Disconnect the USB-C cable from the device.
19. Replace the top cover.
20. Secure the top cover to the device using the four screws. See [Figure 37 on page 112](#).
21. Torque the screws to 6 kg-cm (5.2 lbs-in).

Storage

The device contains the following types of file storage:

- Random Access Memory (RAM)
- Internal storage
- External storage
- Enterprise folder.

Random Access Memory

Executing programs use RAM to store data. Data stored in RAM is lost upon a reset. The operating system manages how applications use RAM. It only allows applications and component processes and services to use RAM when required. It may cache recently used processes in RAM, so they restart more quickly when opened again, but it will erase the cache if it needs the RAM for new activities.

The screen displays the amount of used and free RAM.

- **Performance** - Indicates memory performance.
- **Total memory** - Indicates the total amount of RAM available.
- **Average used (%)** - Indicates the average amount of memory (as a percentage) used during the period of time selected (default - 3 hours).
- **Free** - Indicates the total amount of unused RAM.
- **Memory used by apps** - Touch to view RAM usage by individual apps.

Viewing Memory

1. Go to **Settings**.
2. Touch **System > Advanced > Developer options > Memory**.

Internal Storage

The device has internal storage. The internal storage content can be viewed and files copied to and from when the device is connected to a host computer. Some applications are designed to be stored on the internal storage rather than in internal memory.

Viewing Internal Storage

1. Go to **Settings**.
 2. Touch **Storage**.
- **Internal Storage** - Displays the total amount of space on internal storage and amount used.

If the device has removable storage installed, touch **Internal shared storage** to display the amount of internal storage used by apps, photos, videos, audio and other files.

External Storage

The device can have a removable USB drive. The USB drive content can be viewed and files copied to and from when the device is connected to a host computer.

Viewing External Storage

1. Go to **Settings**.
2. Touch **Storage**.

Portable storage displays the total amount of space on the installed USB drive and the amount used.

To unmount the USB drive, touch .

Touch **General USB Drive** to view the contents of the card.

Formatting a USB Drive as Portable Storage

1. Touch **USB drive**.
2. Touch  > **Storage settings**.
3. Touch **Format**.
4. Touch **ERASE & FORMAT**.
5. Touch **DONE**.

Enterprise Folder

The Enterprise folder (within internal flash) is a super-persistent storage that is persistent after a reset and an Enterprise Reset. The Enterprise folder is erased during a Factory Reset. The Enterprise folder is used for deployment and device-unique data. The Enterprise folder is approximately 128 MB (formatted). Applications can persist data after an Enterprise Reset by saving data to the enterprise/user folder. The folder is ext4 formatted and is only accessible from a host computer using ADB or from an MDM.

Managing Apps

Apps use two kinds of memory: storage memory and RAM. Apps use storage memory for themselves and any files, settings, and other data they use. They also use RAM when they are running.

1. Go to **Settings**.
2. Touch **Apps & notifications**.
3. Touch **See all XX apps** to view all apps on the device.
4. Touch  > **Show system** to include system processes in the list.
5. Touch an app, process, or service in the list to open a screen with details about it and, depending on the item, to change its settings, permissions, notifications and to force stop or uninstall it.



App Details

Apps have different kinds of information and controls.

- **Force stop** - Stop an app.
- **Disable** - Disable an app.
- **Uninstall** - Remove the app and all of its data and settings from the device. See [Uninstalling an Application on page 112](#) for information about uninstalling apps.
- **Notifications** - Set the app notification settings.
- **Permissions** - Lists the areas on the device that the app has access to.
- **Storage & cache** - Lists how much information is stored, and includes buttons for clearing it.
- **Mobile data & Wi-Fi** - Provides information about data consumed by an app.
- **Advanced**
 - **Screen time** - Displays the amount of time the app has displayed on the screen.
 - **Battery** - Lists the amount of computing power used by the app.
 - **Open by default** - If you have configured an app to launch certain file types by default, you can clear that setting here.
 - **Display over other apps** - allows an app to display on top of other apps.
 - **App details** - Provides a link to additional app details on the Play store.
 - **Additional settings in the app** - Opens settings in the app.
 - **Modify system settings** - Allows an app to modify the system settings.

Managing Downloads

Files and apps downloaded using the Browser or Email are stored on the USB drive or Internal storage in the Download directory. Use the Downloads app to view, open, or delete downloaded items.

1. Swipe the screen up and touch .
2. Touch  > **Downloads**.
3. Touch and hold an item, select items to delete and touch . The item is deleted from the device.

Maintenance and Troubleshooting

Introduction

This chapter includes instructions on cleaning the L10, storing the tablet, battery maintenance, and troubleshooting solutions for potential problems during L10 operations.

Maintaining the L10

For trouble-free service, observe the following tips when using the L10:

- Protect the L10 from temperature extremes, shock, liquids, and strong magnetic fields.
- Do not store or use the L10 in any location that is extremely dusty, damp, or wet.
- Use a soft lens cloth to clean the screen. If the surface of the L10 screen becomes soiled, clean it with a soft cloth moistened with a diluted window-cleaning solution. Do not use bleach or ammonia.
- Take care not to scratch the screen of the L10.
- The display of the L10 contains glass. Take care not to drop the L10 or subject it to strong impact.
- Don't place heavy objects on top of the tablet.
- If you're storing the tablet for a long time, unplug the power adapter and remove the battery after partially discharging it.
- Don't open the housing that encloses the tablet. There are no user-serviceable components inside. Opening the housing will void your warranty.

Operating the Tablet in Cold Ambient Temperatures

When the tablet is on external power, such as an AC adapter or a powered vehicle dock, performance within the full operating range -20°C to 60°C (-4°F to 140°F) is assured.

However, when the tablet is NOT on external power AND is in temperatures lower than -15°C (5°F), the cold can affect the startup of the tablet and the reporting of the battery capacity.

Battery Safety Guidelines

- The area in which the L10 units are charged should be clear of debris and combustible materials or chemicals. Particular care should be taken where the device is charged in a non-commercial environment.
- Do not use incompatible batteries and chargers. If you have any questions about the compatibility of a battery or a charger, contact Zebra Support. See [Service Information on page 13](#) for contact information.
- Do not crush, puncture, or place a high degree of pressure on the battery.
- Improper battery use may result in a fire, explosion, or other hazard.
- To charge the mobile device battery, the battery and charger temperatures must be between +32°F and +104°F (0°C and +40°C)
- Do not disassemble or open, crush, bend or deform, puncture, or shred.
- Severe impact from dropping any battery-operated device on a hard surface could cause the battery to overheat.
- Do not short circuit a battery or allow metallic or conductive objects to contact the battery terminals.
- Do NOT attempt any of the following activities:
 - Modify or remanufacture this product
 - Insert foreign objects into the battery
 - Immerse or expose this product to water or other liquids
 - Expose to fire, explosion, or other hazard
- Do not leave or store the equipment in or near areas that might get very hot, such as in a parked vehicle or near a radiator or other heat source. Do not place battery into a microwave oven or dryer.
- Battery usage by children should be supervised.
- Please follow local regulations to promptly dispose of used re-chargeable batteries.
- Do not dispose of batteries in fire.
- Seek medical advice immediately if a battery has been swallowed.
- In the event of a battery leak, do not allow the liquid to come in contact with the skin or eyes. If contact has been made, wash the affected area with large amounts of water and seek medical advice.

If you have a problem with your equipment, contact Zebra Global Customer Support for your region. Contact information is available at: zebra.com/support.

Long-term Battery Storage

Don't store any batteries with a full charge, because this can cause a permanent loss of charging capacity. For long-term storage, ensure that the charge level is between 20% and 40% (two LEDs illuminated), and remove the battery from the tablet. Store the battery in a cool, dry environment in the temperature range 0°C to 30°C (32°F to 86°F).

Check stored batteries every 90 days to determine the charge status. If only one LED or no LED is illuminated, recharge the batteries to a level between 20% and 40%. In storage, the batteries will discharge at a rate of 10% of the total capacity per month.

Disposing of Used Batteries

Dispose of a Lithium-ion (Li-ion) battery at a hazardous materials recycling center when it is no longer serviceable. Don't throw it away, because the battery might be put into landfill.

Cleaning



CAUTION: Always wear eye protection.

Read warning label on compressed air and alcohol product before using.

If you have to use any other solution for medical reasons please contact Zebra for more information.



WARNING: Avoid exposing this product to contact with hot oil or other flammable liquids. If such exposure occurs, unplug the device and clean the product immediately in accordance with these guidelines.

Materials Required for Cleaning

- Alcohol wipes
- Lens tissue
- Cotton tipped applicators
- Isopropyl alcohol
- Can of compressed air with a tube

Cleaning the L10

Housing

Using the alcohol wipes, wipe the housing.

Display

The display can be wiped down with the alcohol wipes, but do not allow any pooling of liquid around the edges of the display. Immediately dry the display with a soft, non-abrasive cloth to prevent streaking.

Power Connector

1. Remove the main battery from the tablet.
2. Dip the cotton portion of the cotton tipped applicator in isopropyl alcohol.
3. Use the cotton tipped applicator dipped in alcohol to remove any grease and dirt near the connector area.
4. Repeat steps 2 and 3 a total of three times.
5. Spray compressed air on the connector area by pointing the tube/nozzle about ½ inch away from the surface.



CAUTION: Do not point nozzle at yourself and others, ensure the nozzle or tube is pointed away from your face.

6. Inspect the area for any grease or dirt, repeat if required.

Cleaning the Cradle Connector

Use this procedure to clean the connectors on a cradle:

1. Remove power from the cradle.
2. Dip the cotton portion of the cotton tipped applicator in isopropyl alcohol.
3. Rub the cotton portion of the cotton tipped applicator along the pins of the connector. Slowly move the applicator back-and-forth from one side of the connector to the other. Do not let any cotton residue remain on the connector.
4. All sides of the connector should also be rubbed with the cotton tipped applicator.
5. Spray compressed air in the connector area by pointing the tube/nozzle about ½ inch away from the surface.



CAUTION: Do not point nozzle at yourself and others, ensure the nozzle or tube is pointed away from your face.

6. Ensure that there is no lint left by the cotton tipped applicator.
7. If grease and other dirt can be found on other areas of the cradle, use lint free cloth and alcohol to remove.
8. Allow at least 10 to 30 minutes (depending on ambient temperature and humidity) for the alcohol to air dry before applying power to cradle.
9. If the temperature is low and humidity is high, longer drying time is required. Warm temperature and dry humidity requires less drying time.

Caring for the Display

Follow these suggestions to keep your display clean:

- Clean fingerprints and smudges from the display surface by wiping it with a microfiber cloth.
- If liquid is spilled on the display, wipe it up immediately with a soft microfiber cloth.
- Use only the L10 pen or your finger to write on the display. Any other object could damage the display surface.
- Protect the display surface from unnecessary contact by using a carry case when transporting the tablet.
- Avoid exposing the display to direct sunlight for long periods of time.
- Every L10 ships from factory with a protective display film.

There are a range of products specifically for your L10 tablet. Refer to the accessories online, zebra.com/support.

Caring for the Pen

If you use an active (digitizer) pen with your tablet:

- Store the active (digitizer) pen in the pen holder when not in use.
- Avoid storing the pen vertically on its tip. It can damage the pen-to-digitizer function.
- Keep the pen away from any liquid, because the pen contains electronic components that can be damaged when wet.

- In certain environments, particles or debris can stick to the pen tip or the tablet display. Make sure you wipe off the pen with a soft cloth to avoid scratching the display.

Traveling with the Tablet

Use the following tips when you travel with the tablet:

- Put the L10 tablet in a case to protect the display. Zebra sells a variety of cases for the L10 tablet.
- Store the pen in the pen bay located on the tablet.
- Pack the L10 tablet securely in a briefcase or hand-carried luggage and keep it separate from toiletries, liquids, and food. Don't pack it in checked luggage.
- Before extended use in the field or long trips away from AC power, adjust the power properties to maximize battery conservation.
- For international travel, you need either a travel plug adapter or the AC power cord that is appropriate for the country that you are visiting. The travel plug adapter can be found in most airports and travel stores. The regional AC power cord can be purchased from an Zebra Authorized Reseller.
- You don't need to buy a voltage converter; the AC adapter will automatically adjust to different voltages.
- You might want to carry proof of ownership or a merchandise passport when traveling internationally.
- Consult your insurance and credit card companies to learn about emergency travel assistance in case your tablet becomes lost or disabled.
- Turn off the tablet or place it in airplane mode for takeoff and landing. Check with the airline for rules on using your tablet and Wi-Fi while traveling. You can turn off all of your wireless devices temporarily with airplane mode. See [Opening the Quick Access Panel on page 33](#).



CAUTION: Don't carry your tablet through a metal detector.



DANGER: Don't transport Li-ion batteries in checked baggage. The baggage hold can get very hot, which can cause the Li-ion battery to overheat and result in a possible explosion.

Troubleshooting

Restarting the L10

There are two reset features on the device: Restart and a hard reset switch.

Soft Reset

Reboot the device if applications stop responding.

1. Press the Power button until a small menu appears.
2. Touch **Restart**.

The device restarts.

Hard Reset

If the device is not responsive, use the reset switch on the front of the tablet. This switch turns the power off immediately.



CAUTION: Performing a hard reset with a microSD card installed in the device can cause damage or data corruption to the memory card, causing all data on the microSD card to be lost.

1. If a microSD card installed in the device, remove it before you use the reset switch. To access the microSD card, open the port cover on the left side of the tablet and remove the microSD card. This removal will preserve the data on the memory card.



2. Use the stylus tip on the tablet pen and insert it into the reset hole to press the recessed button until the tablet shuts down. (You can also use a paper clip and unbend it to form a pin.)

Figure 38 Reset Switch on Front of Tablet



1	Hard Reset Button
---	-------------------

3. Press the Power button to restart the device.
4. Replace the microSD card to the slot in the device.

Table 11 Troubleshooting the L10 Tablet

Problem	Cause	Solution
L10 does not turn on.	Battery not charged.	Charge the battery in the device.
	Battery not installed properly.	Ensure battery is installed properly.
	System crash.	Perform a soft reset. If the device still does not turn on, perform a hard reset. See Restarting the L10 on page 126 .
Battery did not charge.	Battery failed.	Replace battery. If the device still does not operate, try a soft reset, then a hard reset. See Restarting the L10 on page 126 .
	Device removed from cradle before charging completed.	Insert the device into the cradle and begin charging. The battery fully charges in approximately four hours.
	Ambient temperature of the cradle is too warm or too cold.	The ambient temperature must be between 0°C and 40°C (32°F and 104°F).
Unable to connect to the wireless network.	SIM card is valid.	Ensure that the micro SIM card is valid and workable if using a mobile network.
	Not within range of network.	Move within the network's service range and the signal strength is good.
	Device is in airplane mode.	Turn the Airplane mode off.
The multi-touch screen responds slowly or improperly.	Finger or screen is wet.	Ensure that your hands are clean and dry when touching the screen. Restart the tablet to try again.
L10 turns itself off.	Device is inactive.	The device turns off after a period of inactivity. If the device is running on battery power.
	Battery is depleted.	Place the device in the cradle to re-charge the battery.
	The battery is low and it powers down to protect memory content.	Place the device in a cradle to charge the battery.
Screen is not rotating.	Screen rotation is disabled.	Enable screen rotation. See XPAD Right Side on page 21 .

Specifications

The following tables summarize the intended operating environment and general technical hardware specifications for the L10 tablet, including the operating ruggedness, connectivity, communications, and other features.

Table 12 Technical Specifications

Item	Description
Physical Characteristics	
Dimensions	XSLATE or XBOOK Tablet 280 mm x 195.2 mm x 22 mm or 11 in. x 7.7 in. x 0.88 in
	XPAD Tablet 280.8 mm x 195.2 mm x 22 mm; 11 in. x 10.0 in. x 0.88 in., including handle
Weight	XSLATE Tablet 1.3 Kg; 2.8 lbs
	XPAD Tablet 1.4 Kg; 3.1 lbs
Display	10.1 in (diagonal), 1920 x 1200 WUVGA; brightness output is 500 nits or an optional 1000 nits View Anywhere display for viewing in bright sunlight.
Touch panel	10-point multi-touch display: capacitive or optional multi-touch active digitizer display. There are three touch modes in Settings > Display > Advanced > Touch panel mode : <ul style="list-style-type: none"> • Finger and Wet • Finger and Glove • Finger and Passive Stylus (default)
Keyboard Options	Virtual, Bluetooth, or USB
Expansion	Integrated connector to easily add accessories

Specifications

Table 12 Technical Specifications (Continued)

Item	Description
Connectivity	<ul style="list-style-type: none"> • MicroSD card slot • USB 3.1 and DisplayPort output through a Type-C connector • Two USB 2.0 Type-A connectors • Dual SIM port, holds two Nano SIM cards • 3.5mm audio jack • Charging port • Ethernet RJ45 port for LAN connectivity DisplayPort; • Docking connectors • Optional factory-configurable option that can function as a serial or HDMI-in connector
Camera notification	LED flash; camera LED indicator
Audio	Speaker and dual microphones; the XPAD has one speaker in front and the XSLATE has one speaker on the back.
Battery	Rechargeable Li-Ion, standard capacity (36 Whr), extended capacity (98 Whr), hot swappable.
Performance Characteristics	
CPU	Qualcomm Snapdragon 660 platform with 4 to 8 GB of RAM; 64 to 128 GB eMMC SSD.
Graphics	Qualcomm Adreno 512 GPU
Operating System	Android Open Source Project (AOSP) version 10 or Google Mobile Services (GMS) version 10.
Memory	MicroSD card slot; supports 16 to 32 GB
Data Capture	
Front Camera	5 MP 1080p full HD
Rear Camera	13 MP autofocus camera with LED flash
Video	1080p (Full HD, 1920 x 1080), frame rate = 30 fps
Scanning	Built-in barcode reader (SE 4710) XPAD only
Operating Temperature	-20°C to 60°C (-4°F to 140°F)
Storage Temperature	-30°C to 70°C (-22°F to 158°F)
Battery Charging	0°C to +40°C (32°F to 104°F)
Environmental Sealing	IP65-rated sealing with battery; able to withstand dust and low-pressure water jets
Drop Specification	MIL STD 810G at 25°C; This specification is for dropping the tablet up to 1.83 m (6 feet) to plywood and up to 1.2 m (4 feet) to concrete.
Electrostatic Discharge (ESD)	± 8 kV direct discharge ± 15 kV air discharge

Specifications

Table 12 Technical Specifications (Continued)

Item	Description
Hazardous Location	C1D2 and ATEX rating for use in hazardous locations
Display	Corning Gorilla Glass 3 for increased display damage resistance
Wireless Communications	
WWAN	Global LTE with WCDMA fallback North America: AT&T LTE with AT&T WCDMA 3G fallback; Verizon LTE
WLAN	WLAN: 802.11 a/b/g/n/d/h/i/k/r/ac, IPv4, IPv6; MU-MIMO, 2x2 <ul style="list-style-type: none"> • 2.4 GHz: 802.11b/g/n - up to 144 Mb per second; Chan 1 - 13 (2412 - 2472 MHz), • 5 GHz: 802.11a/n/ac - up to 866.7 Mb per second; Chan 36 - 165 (5180 - 5825 MHz) • Channel Bandwidth: 20, 40, 80 MHz • Actual operating channels/frequencies depend on regulatory rules and certification agency. • WEP (40 or 104 bit); WPA/WPA2 Personal (TKIP and AES); • WPA/WPA2 Enterprise (TKIP and AES) - EAP-TTLS (PAP, MSCHAP, MSCHAPv2), EAP-TLS, PEAPv0-MSCHAPv2, PEAPv1-EAP-GTC, EAP LEAP.
Bluetooth	Bluetooth v5.0 and BLE (Bluetooth low energy)
Near Field Communication (NFC)	NFC is a subset of RFID with a shorter communication range for better data security. NFC lets you make payments share data. P2P: ISO 18092x. <ul style="list-style-type: none"> • Reader/Writer: ISO 14443 – A-B, MIFARE, FeliCa®, ISO 15693, NFC Forum Tag Types 1 to 5 • Card emulation: ISO 14443 – A-B-B', MIFARE, FeliCa RF • Distance up to 3 cm
Global Navigation Satellite Systems (GNSS)	GPS, Glonass, Galileo, and Beidou
Sensors	
Gyro	Maintains orientation based on principles of conservation of angular momentum.
Motion Sensor	Three-axis accelerometer that enables motion-sensing applications for dynamic screen orientation and power management.
Ambient Light Sensor	A sensor that automatically adjusts display brightness, keypad, and display backlight.
Electronic Compass	An eCompass that does not depend on GPS.
Printers	
Printers	Supports extensive line of Zebra approved printers

Table 13 Supported Symbologies

Barcode Type	Symbologies
1D	Chinese 2 of 5, Codabar, Code 11, Code 128, Code 39, Code 93, Discrete 2 of 5, EAN-8, EAN-13, GS1 Databar, GS1 Databar Expanded, GS1 Databar Limited, Interleaved 2 of 5, Korean 3 of 5, MSI, Matrix 2 of 5, Trioptic39, UPCA, UPCE0, UPCE1.
2D	Aztec, Composite AB, Composite C, DataMatrix, Grid Matrix, GS1 DataMatrix, Dotcode, GS1 QRCode, Maxicode, MicroPDF, Micro QR, PDF417, QRCode, Han Xin.
Postal	Australian Postal, Canadian Postal, Dutch Postal, Japanese Postal, Mail Mark, UK Postal, US4state, US4state FICS, US Planet, US Postnet.

Index

A

active pen	
short digitizer, long digitizer	24
adaptive frequency hopping	78
ambient display setting	59
ambient light	130
ambient light sensor	16, 19
Android Open Source Project (ASOP)	129
Android Open Source Project (ASOP), operating system	129
apn	70
apps	
accessing	41
camera	45
datawedge demonstration	50
PTT Express	52
RxLogger	55
RxLogger Utility	56
sound recorder	56
audio connector	18, 21

B

barcode reader	
built-in	129
barcode scanner	
button (XPAD)	22, 27
barcode scanner (XPAD)	86
barcode scanning	
DS3678	87
barcodes	
supported	131
supported types	131
two dimensional	85
battery	
changing	27
charge level (back of battery)	26
charge level, indicator lights on back	26
charging temperature	129
charging temperatures	122
disposing	123

disposing of	122
hot swappable	17, 20, 21, 129
hot swapping	27
installing, charging,	23
latch	17
LED indicator	16, 19
lithium-ion	15
low battery notification	35
monitor usage	35
operating temperatures	122
out of the tablet	26
removing, replacing	26
safety	122
standard and extended capacity	129
storage, charge level for storage	122
swapping	27
battery charging indicator	
blinking green	23
battery LED indicator	16, 19
battery management	34
battery level	34
battery present status	34
battery optimization	34
bluetooth	67, 77, 130
change name	81
PIN	78
power states	80
profiles	79
security	78
brightness	
sensor	16, 19

C

camera	38, 45
flash, LED indicator	129
front camera photo settings	48
front camera video settings	50
front, 5 MP	129
light	17
light (back of XPAD), flash	20
photo settings	47

- rear camera photo settings 47
 - rear camera video settings 49
 - rear, autofocus, 13 MP 129
 - recording videos 46
 - taking panoramic photos 46
 - taking photos 45
 - video settings 49
 - camera (front) 16, 19
 - camera (rear)
 - 13 megapixels 17, 20
 - camera settings 47, 49
 - capacitive pens 24
 - care
 - maintenance 121
 - care and maintenance
 - active digitizer pen, ePen 124
 - cast 82
 - Central Processing Unit (CPU) 129
 - change bluetooth name 81
 - changing the battery 27
 - charging
 - battery 23
 - cleaning 121, 123
 - cradle connectors 124
 - cold temperature
 - operating tablet, battery power 121
 - compass
 - electronic, eCompass 130
 - connecting
 - external monitor to tablet 25
 - mobile broadband 22
 - Corning Gorilla glass 11
- D**
- damage resistance 11
 - data capture
 - DS3678 87
 - imaging 85
 - two-dimensional bar codes 85
 - datawedge 96
 - decoders 97
 - disabling 97
 - enable 97
 - datawedge demonstration 50
 - decoders 97
 - dimensions 128
 - disconnect host computer 37
 - display
 - damage resistance 11
 - Gorilla Glass 130
 - size, brightness, nits 128
 - display (external)
 - connecting 25
 - display settings 58
 - DisplayPort to HDMI 25
 - disposing of battery 123
 - docking connectors 129
 - dongle
 - for external monitor, for USB type-C to HDMI 25
 - drop specification 129
 - DS3678
 - barcode scanning 87
 - data capture 87
 - pairing 95
 - pairing using Bluetooth HID 95
 - pairing using simple serial interface 95
 - scanning 92
- E**
- EAP 72
 - edit apn 70
 - environmental sealing
 - water, dust 129
 - ePen
 - long capacitive 24
 - equipment problem 122
 - Ethernet 129
 - port 18, 21
 - external monitor
 - connecting 25
- F**
- features
 - CPU, GPU, SSD 11
 - overview 11
 - file transfer 36
 - font size 60
 - function buttons (XPAD)
 - description 19
- G**
- general sound setting 61
 - GNSS 130
 - Google Mobile Services (GMS) 129
 - Gorilla glass 11
 - GPS 130
 - Graphics Processing Unit (GPU) 129
 - gyro 130
- H**
- hard reset 126
 - hazardous rating 130
 - headset
 - jack 18, 21
 - holder

pen	17
home screen	16, 19, 28
rotation	29
hot swapping the battery	27
hot-swappable battery	17, 20, 21

I

imager. See data capture, imaging	
imaging	85
inserting	
SIM card, two SIM cards	22
installing	
battery	23
interactive sensor technology	35

J

jack	
Ethernet	18, 21
headset	18, 21

K

Kensington lock slot	17, 20
keyboard (keypad)	
Bluetooth, USB, virtual	128
keyboard options	128
keyboards	62
additional character tab	64
alpha tab	64
configuration	63
editing text	63
numeric tab	64
kill switch	19

L

L10	
features overview	11
L10 platform	
XPAD, XSLATE, XBOOK	11
light	
ambient light sensor	130
light sensor	16, 19
lithium-ion battery	15
lock screen notifications	65
locking	
Kensington lock slot	20
Kensington slot	17
locking door	
USB cover, left side	18, 21
low battery notification	35

M

maintenance	
tablet	121
managing notifications	32
memory	
microSD	129
microSD card slot	18, 21
messaging	40
microphone input	18, 21
microphones	16, 19, 129
microSD card slot	21
mobile broadband	
connecting, SIM card, WWAN card, cellular	22
monitor (external)	
connecting	25
monitor battery usage	35
motion sensor	130

N

Near Field Communication (NFC)	20
sharing data, make payments	130
near field communications	82
NFC	17, 82
notational conventions	12
notification icons	30
notifications	
lock screen	65
managing	32

O

operating system	129
operating temperature	129
optional external RS507	129
optional features	
barcode scanner	12
integrated UHF NFC reader	12
Wacom-based digitizer	12
overview of XPAD	19
back side	20
left side	21
top side	22
overview of XSLATE	
front side	16
front side, features	16
left side	18
right side	17, 21

P

P1 and P2 (XPAD)	
function buttons description	19
pairing	

- DS3678 95
 - RS507/RS6000 hands-free imager 93
 - using Bluetooth HID (RS507/RS6000) 94
 - using Bluetooth HID(DS3678) 95
 - using simple serial interface (DS3678) 95
 - using simple serial interface(RS507/RS6000) 93
 - panoramic 46
 - parts of the tablet
 - front view 15
 - pen
 - active Stylus Tip Kit 124
 - attaching to tether 25
 - care and maintenance 124
 - holder 17
 - holder (XPAD) 22, 27
 - holder (XPAD), long pen 19
 - long active/digitizer, Wacom compatible 24
 - long capacitive ePen 24
 - short active/digitizer, Wacom compatible 24
 - short capacitive 24
 - tether post (XPAD) 20
 - photo transfer 36
 - photos
 - camera settings 47
 - panoramic 46
 - taking 45
 - platform L10
 - XPAD, XSLATE, XBOOK 11
 - plug adapter
 - travel 125
 - port
 - Ethernet 18, 21
 - power connector 18, 21
 - USB 2.0 18, 21
 - port cover
 - expansion 17, 20
 - power button 18, 21
 - power cord
 - travel 125
 - power input (port)
 - external power adapter 18, 21
 - power LED 16, 19
 - PTT Express
 - audible indicators 53
 - disabling communication 54
 - enabling communication 53
 - group calls 54
 - notification icons 53
 - private response 54
 - talk groups 54
 - user interface 52
 - Voice Client 52
 - PTT-Express
 - PTT communication 54
- Q**
- quick access panel 33
 - quick settings
 - edit icons 34
- R**
- rebooting the tablet 126
 - Regulatory Guide 11
 - remove wi-fi 73
 - removing the battery 26
 - replacing the battery 26
 - reset switch 19, 126
 - force power off 16
 - restarting the tablet 126
 - soft reset, power button 126
 - rotation
 - auto, lock 18, 21
 - RS507 86
 - scanning 89, 90
 - RS507 scanning 89, 90, 92
 - RS507/RS6000
 - pairing 93
 - pairing using Bluetooth HID 94
 - pairing using simple serial interface 93
 - RS6000 91
 - bluetooth ring scanner 87
 - scanning 91
 - RxLogger 55
 - configuration 55
 - configuration file 55
 - disable logging 55
 - enable logging 55
 - extract log files 55
 - RxLogger Utility 56
- S**
- scanner
 - picklist mode, decode mode 84
 - scanners
 - XPAD tablet built-in, RS507X, RS6000, DS3578, DS3608 84
 - scanning 91
 - aiming 85
 - angle 85
 - DS3678 92
 - imaging 85
 - range 85
 - RS507 89, 90
 - RS6000 91
 - screen
 - caring for, protective film 124
 - screen font size 60

security 72
 Kensington lock slot 17, 20

sensor
 light 130
 motion 130

service information 122

setting
 camera 47, 49

setting up
 optional setup tasks 25

settings 58
 accessing 58
 ambient display 59
 camera photos 47
 camera videos 49
 display 58
 general sound 61

sharing data
 NFC 130

SIM card
 inserting, two cards 22

SMS 40

software version 14

software versions 13

sound recorder 56

speaker 129
 built-in 17

speaker (XPAD) 19

specifications
 1D barcodes 131
 2D barcodes 131
 data capture 129
 performance characteristics 129
 physical characteristics 128
 postal barcodes 131
 printers 130
 sensors 130
 SIM port 129
 supported symbologies 131
 touch panel mode 11, 24, 128
 USB connectors 129
 wireless communications 130

status
 system, LED indicator 16, 19

status bar 29

storage
 battery 122

storage temperature 129

storing
 tablet 121

swapping batteries 27

symbologies
 barcode types 131

system status 16, 19

T

tablet specifications
 dimensions, weight 128
 display, touch panel 128
 keyboard types 128
 touch panel 11, 24, 128

taking a panoramic photo 46

temperature
 for battery charging 129

tether
 for pen 25

tether post
 for pen (XPAD) 20

tips
 active digitizer pens 124

touch panel mode
 finger, glove, stylus 11, 24, 128

touchscreen 16, 19
 caring for 124
 cleaning 124

transferring files using USB 36

travel
 plug adapter, power cord, voltage converter 125

traveling with tablet 125

troubleshooting
 battery 127
 screen rotation, 127
 wireless connection 127

U

unpacking the tablet
 equipment in the box 15

USB 36, 129
 2.0 port 18, 21
 display port output 18, 21
 type-C, USB 3.1 18, 21

USB 3.1
 DisplayPort, Type-C connector 129

V

video
 frame rate, (fps), full HD, 1080p 129

videos
 camera settings 49
 recording 46

voltage converter
 travel 125

volume
 control button 18, 21

W

weight of tablet	128
WEP	72
Wi-Fi direct	77
wireless local area network	67
wireless wide area network	67
WLAN	67
WPA	72
WPAN	130
WWAN	67

X

XBOOK

platform L10	11
--------------------	----

XPAD

barcode scanner (built-in)	86
built-in scanner	84
overview, features	19
pen holder, barcode scanner button	22
speaker	19

XSLATE

overview, features	16
--------------------------	----

