

VeriFact-550/555

INSTALLATION AND OPERATING INSTRUCTIONS



**VeriFact-550
Ceiling Mount (Flush)**



**VeriFact-555
Ceiling Mount (Surface)**

DESCRIPTION

Louroe Model VeriFact-550/555 are ceiling mount speakerphones designed to provide 2-way audio (listen/talkback) with various modes of audio/video transmission systems such as:

- DVR's
- IP Network Cameras
- PC
- Soundcards
- Video Servers

The VeriFact-550/555 provide line level audio input and output. It has amplifier that drives the built-in 4" speaker.

The gain of the microphone is factory adjusted. The gain of the audio output can be adjusted using the potentiometer on the PCB on the rear of the unit, the adjustment should be done in small increments. To adjust the audio output of the speaker, rotate the blue potentiometer clockwise (increase) or counterclockwise (decrease) slowly until the desired loudness is attained.

It is recommended to use the device in half duplex mode, however the unit has a built-in echo-cancellation system for when the device is configured for use in full duplex mode such that if the device recognizes that the audio output is beyond a set internal level, the incorporated microphone will be muted till the audio level falls.

The use of headphones or earphones is strongly recommended on the audio monitoring/receiving system to avoid acoustic feedback, this is essential on monitoring systems that do not have echo-cancellation functionality.

INSTALLATION AND OPERATING INSTRUCTIONS

INTERCONNECTION DIAGRAM

CONNECTING LOUROE™ MODEL VERIFACT-550/555
DIRECTLY TO AN IP CAMERA, DVR,
VIDEO SERVER, ETC. USING 3-COND. SHIELDED CABLE

5-PIN TERMINAL BLOCK IDENTIFIER OF VeriFact-550/555

- (black) PWR = 12VDC
- (black w/stripe) GND = Power Ground
- (red) OUT = Audio Output (microphone)
- (bare) GND = Ground (audio) and Ground (speaker) (black wire)
- (white) IN = Speaker in from external device

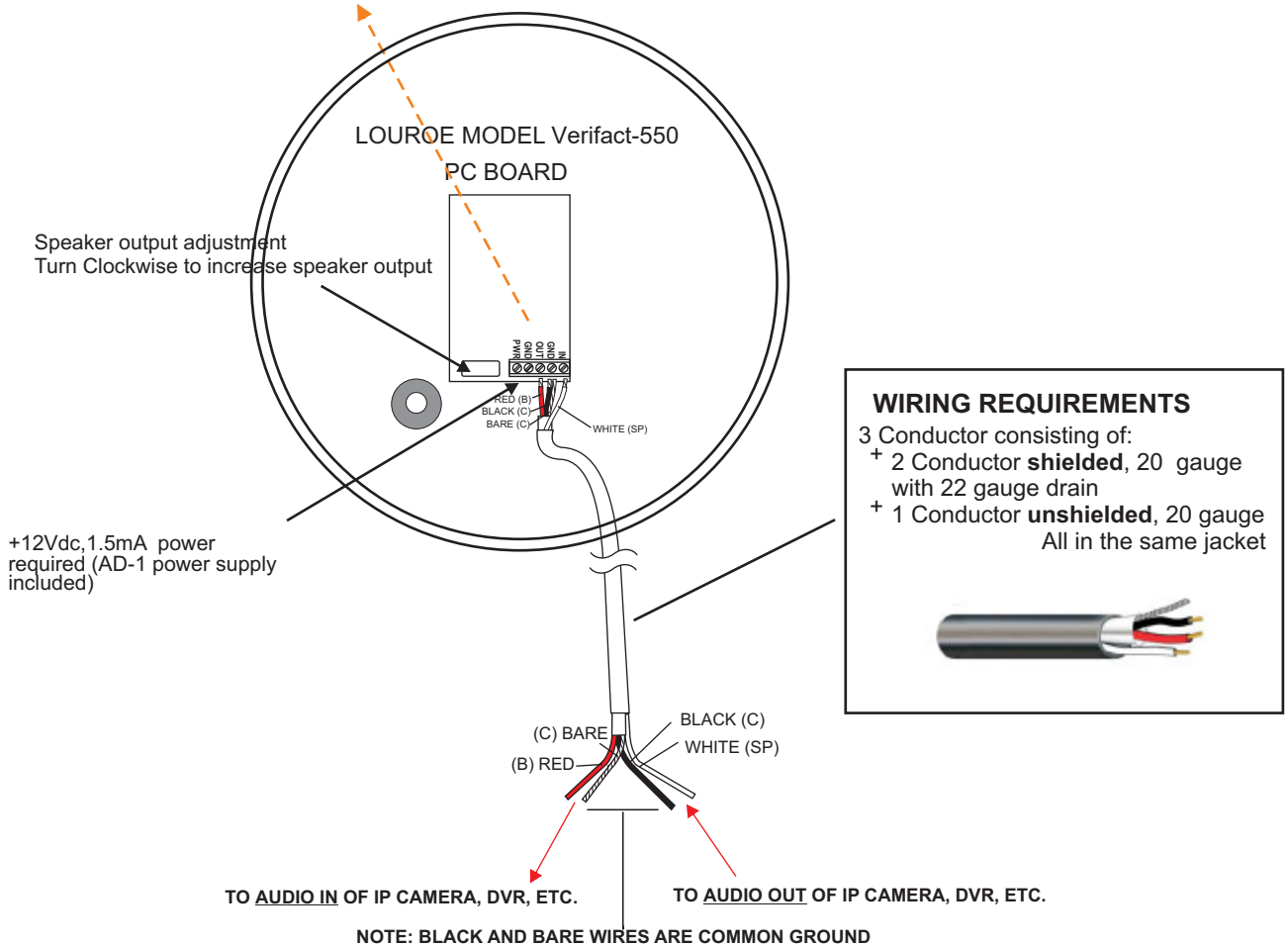

+12Vdc, 1.5mA power required (AD-1 power supply included)

WIRING REQUIREMENTS

3 Conductor consisting of:
 + 2 Conductor **shielded**, 20 gauge with 22 gauge drain
 + 1 Conductor **unshielded**, 20 gauge
 All in the same jacket

3.5mm STEREO CONNECTION

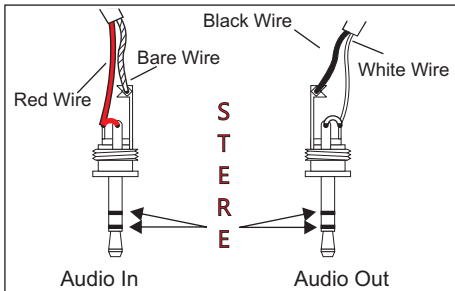

3.5mm MONO CONNECTION

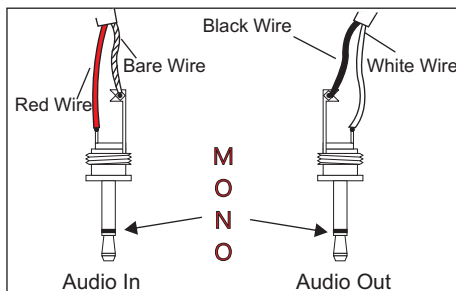

RCA CONNECTION

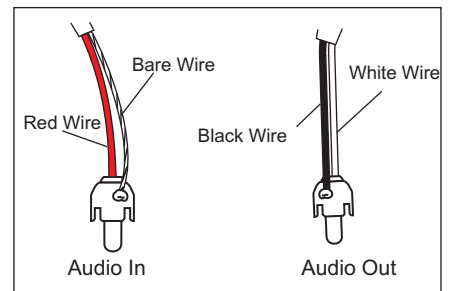

**MOUNTING ASSEMBLY
FOR
LOUROE MODEL VERIFACT-555
SPEAKERPHONE CEILING MOUNT - SURFACE**

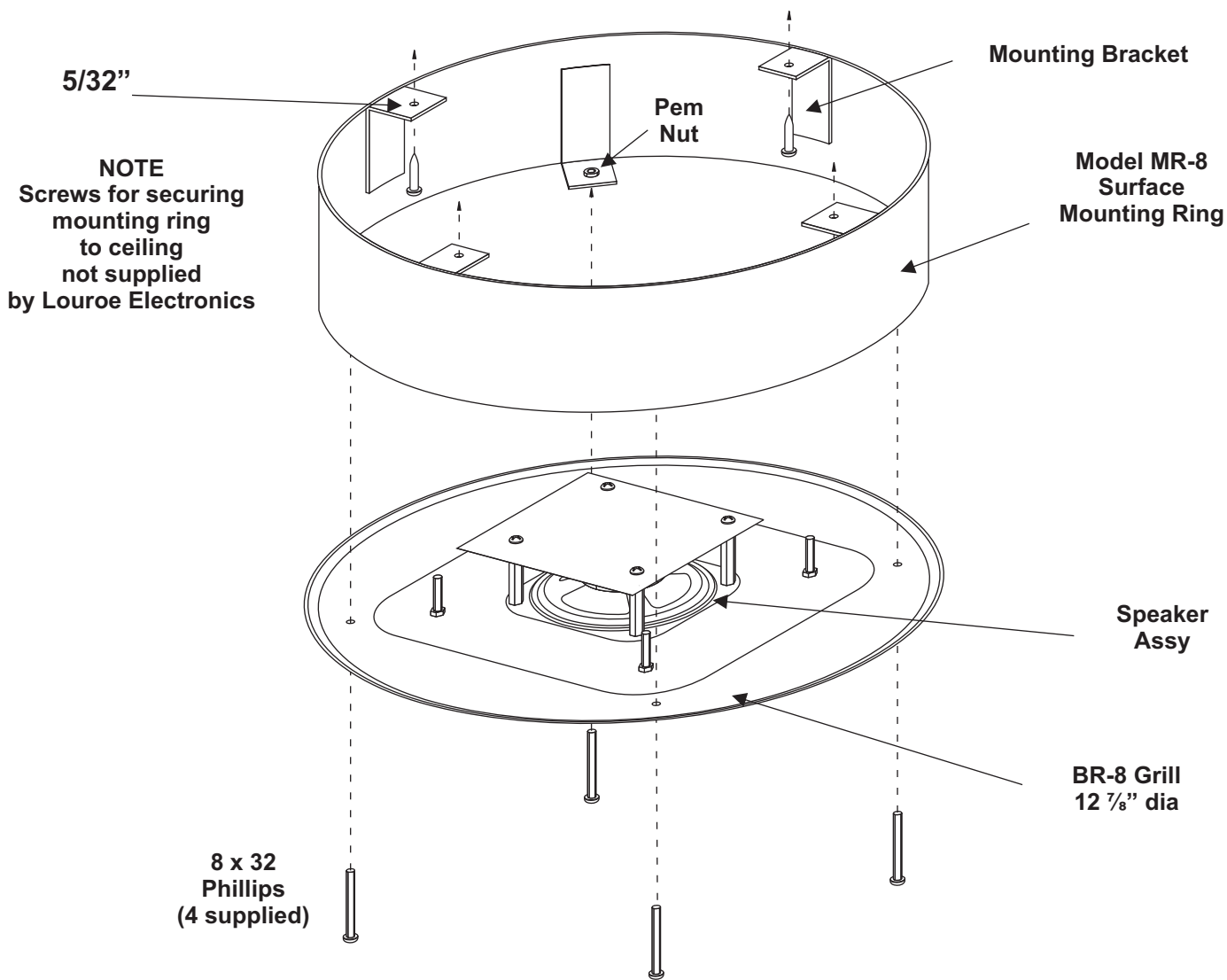

Installation Steps

- 1 First make electrical connections to speakerphone 4-pin terminal block
- 2 Install mounting ring to ceiling
- 3 Mount grill to mounting ring

**MOUNTING ASSEMBLY
FOR
LOUROE MODEL AOP- SPEAKERPHONE
CEILING MOUNT - FLUSH**

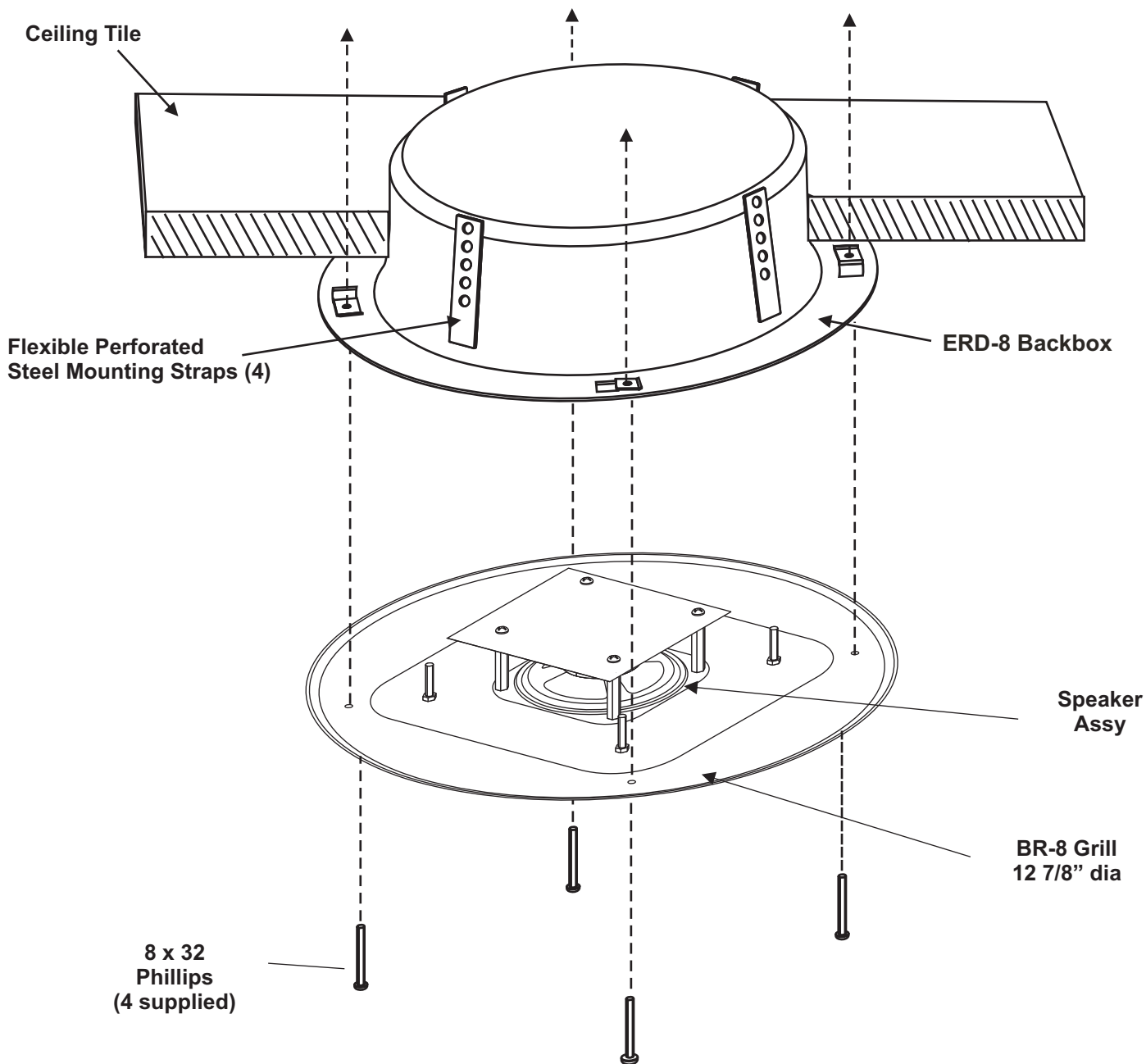

INSTALLATION AND OPERATING INSTRUCTIONS

NOTES

SPECIFICATIONS (Microphone)

■ Type	Electret Condenser
■ Audio output	Line level (0 dB @ 600) unbalanced
■ Microphone element sensitivity	-45 dB
■ Frequency response	40 Hz - 15 kHz
■ Audio Input Impedance	600

SPECIFICATIONS (Speaker)

■ Speaker power output	1W
■ Speaker impedance	8
■ Speaker magnet	Neodymium
■ Speaker size	2"
■ Current Drain	200mA
■ Supply Voltage	12Vdc
■ Dimensions	6.5" H x 4.8" W x 1.9" D
■ Weight	1lb 7 oz
■ Shipping Weight	3 lbs

Listed product - this product must be installed with a listed LPS or Class 2 power supply.

IMPORTANT NOTICE

When this equipment is used as part of an audio monitoring system, the law requires that the public be given notice of AUDIO MONITORING ON THE PREMISES. A decal notice is included with each microphone shipped.



AUDIO
MONITORING
On
These Premises
LOUROE
ELECTRONICS

Federal Law References:
Federal Regulations, US Code, Title 18. Crime and
Criminal Procedure, Sec 2510.

WARRANTY

LOUROE ELECTRONICS warrants that at the time of shipment products manufactured by LOUROE ELECTRONICS to be free of defects in material and workmanship. Should a defect appear within five years (60 months) from date of shipment, LOUROE ELECTRONICS will, at its sole discretion, repair or replace the defective equipment. This equipment shall not be accepted for repair or return without prior notification by LOUROE ELECTRONICS .

This warranty does not extend to any Louroe product that has been subjected to improper or incorrect installation, misuse, accident, or in violation of installation instructions provided by LOUROE ELECTRONICS.

Returned shipments to LOUROE ELECTRONICS shall be at customer's expense. LOUROE ELECTRONICS will return the equipment prepaid via best way.

MANUFACTURED
IN THE

