

MUSICGO[®]

MOVIES MUSIC POWER GO

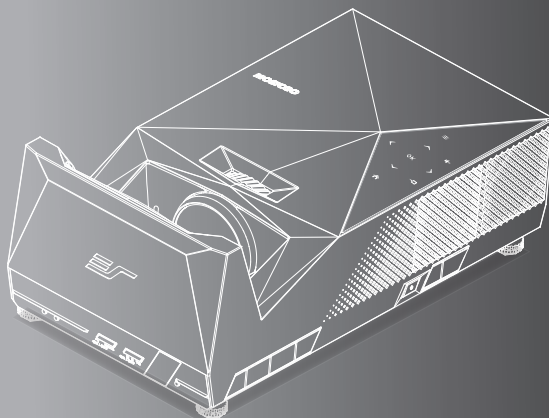

MUSICGO[®] Projector User's Guide

Model: Sport MGFU-S
Lite MGFU-L



For more update user manual:
Electronic file link
www.eliteprojector.com/MGFU/manual



EYE SAFETY WARNINGS

- ⚠ To avoid retinal damage, do not stare directly or indirectly into the projector's light beam.
 - ⚠ Rather than stand in the projector's light beam to point on the screen, use a laser pointer or pointer stick instead.
 - ⚠ Make sure that students and other viewers observe the eye safety warnings and stay out of the direct light beam.
 - ⚠ Use window blinds and turn down interior light sources to reduce the washout glare of ambient light.
-

IMPORTANT SAFETY INSTRUCTIONS

1. The ventilation ports prevent overheating. Never block these ports located on the sides and bottom of the projector.
(See page 12) Direct obstruction, confined spaces or placing on a cluttered surface restricts airflow, and ruins the projector.
2. To reduce risk of fire or electric shock, do not expose the projector to any liquids, rain, snow or airborne moisture.
3. Do not install near heat sources such as radiators, heaters, stoves or any other apparatus such as amplifiers that emit heat.
4. Do not use the projector in direct sunlight.
5. Do not use near any appliance generating a strong magnetic field.
6. Do not use the projector in areas susceptible to excessive dust and dirt.
7. Turn off the product before cleaning.
8. Disconnect the power cord if the product is not being used for a long period of time.
9. Ensure that the ambient room temperature is within 0- 40°C (32-104°F).
10. Ensure that relative humidity is 5 - 35°C (41- 95°F), 80% (Max.), non-condensing.
11. Do not drop, throw or try to bend your product.
12. Dispose of your projector in an environmentally appropriate manner and according to local disposal laws. Disposing the projector in a fire may cause an explosion.
13. Clean only with dry cloth.
14. Only use attachments/accessories specified by the manufacturer.
15. Do not use the unit if it has been physically damaged or abused. Physical damage/abuse would be (but not limited to):
 - ⇒ Unit has been dropped.
 - ⇒ Charger or plug has been damaged.
 - ⇒ Liquid has been spilled on the projector.
 - ⇒ Projector has been exposed to rain or moisture.
 - ⇒ Something has fallen into the projector or something is loose inside.Do not attempt to service the unit yourself. Opening or removing covers may expose you to dangerous voltages or other hazards. Please contact your local reseller or service center before you send the unit for repair.
16. Do not let objects or liquids enter the projector. They may touch dangerous voltage points and short out parts that could result in fire or electric shock.
17. Follow all warnings and cautions in this manual and on the projector.
18. The unit should only be repaired by appropriate service personnel.
19. Projector lamps generate a lot of heat. This causes much of the projector's surface area to heat up. If the projector seems to be excessively hot, turn it off so that it can cool down and then call customer service.

**CAUTION – RISK OF BATTERY EXPLOSION IF INCORRECT TYPE IS USED.
MAKE SURE TO PROPERLY DISCARD USED BATTERIES ACCORDING TO
LOCAL REGULATIONS.**

COPYRIGHT / TRADEMARK

© Copyright 2019. All rights reserved.

The manufacturer reserves the right to make technical changes. The manufacturer assumes no liability for damages incurred directly or indirectly from errors, omissions, or discrepancies between the device and this documentation.

Other brands or logos are trademarks or registered trademarks of their respective companies.

This device is not intended for use in the direct field of view at visual display workplaces.

DECLARATION OF CONFORMITY

We declare under our sole responsibility that this projector conforms to the following directives and norms:

EMC Directive 2014/30/EU

ErP Directive 2009/125/EC

EMC: EN 301489-1

EN 301489-17

EN 55032

EN 55024

Low Voltage Directive : 2014/35/EU

Safety: EN 62368 , EN62133+Annex.M

TRADEMARKS

Apple, Macintosh, iPod, iPod nano, and iPhone are trademarks or registered trademarks of Apple Computer, Inc. IBM is a trademark or registered trademark

Microsoft, PowerPoint, and Windows are trademarks or registered trademarks of Microsoft Corporation. Adobe and Acrobat are trademarks or registered trademarks of Adobe Systems Incorporated.



NOTE: This product is covered electrical and electronic equipment under the European Union's Waste from Electrical and Electronic Equipment ("WEEE") Directive (2002/96/EC). The WEEE Directive requires that covered equipment be collected and managed separately from typical household waste in all EU member states. Please follow the guidance of your local environmental authority or ask the shop where you purchased the product for collection or recycling options.

FCC WARNING

This device complies with part 15 of the FCC Rules. Operation is subject to the following two conditions: (1) This device may not cause harmful interference, and (2) this device must accept any interference received, including interference that may cause undesired operation.

Note: This equipment has been tested and found to comply with the limits for a Class B digital device, pursuant to part 15 of the FCC Rules. These limits are designed to provide reasonable protection against harmful interference in a residential installation. This equipment generates, uses and can radiate radio frequency energy and, if not installed and used in accordance with the instructions, may cause harmful interference to radio communications. However, there is no guarantee that interference will not occur in a particular installation. If this equipment does cause harmful interference to radio or television reception, which can be determined by turning the equipment off and on, the user is encouraged to try to correct the interference by one or more of the following measures:

- Reorient or relocate the receiving antenna.
- Increase the separation between the equipment and receiver.
- Connect the equipment into an outlet on a circuit different from that to which the receiver is connected.
- Consult the dealer or an experienced radio/TV technician for help.

Changes or modifications not expressly approved may void authority to operate the equipment.

FCC CAUTION

Any changes or modifications not expressly approved by the grantee of this device could void the user's authority to operate the equipment

The changes or modifications not expressly approved by the party responsible for compliance could void the user's authority to operate the equipment.

FCC RF exposure warning

This equipment must be installed and operated in accordance with provided instructions and the antenna(s) used for this transmitter must be installed to provide a separation distance of at least 20 cm from all persons and must not be co-located or operating in conjunction with any other antenna or transmitter. End-users and installers must be provide with antenna installation instructions and transmitter operating conditions for satisfying RF exposure compliance.

AGENCY APPROVALS

FCC, CE, and LVD

Other specific Country Approvals may apply. Please see product certification label.

Input ratings: AC 100 - 240V, 6.3A, 50 - 60Hz

Product offerings and specifications may be altered at any time without notice.

PRODUCT OVERVIEW

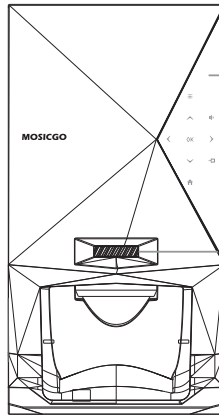
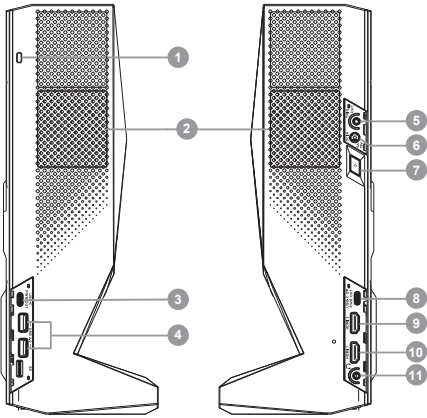

1. Kensington Lock Slot
2. Ventilation Port
3. USB Type C POWER OUT
4. USB
5. 12V Trigger (To Screen)
6. DC IN 19V
7. Power On/Off Switch
8. USB Type C Display Port (DP)/USB Type C POWER OUT
9. HDMI 2
10. HDMI 1
11. Earphone Jack
12. Touch Keypad
13. Focus Ring

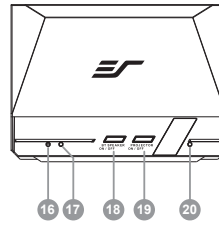
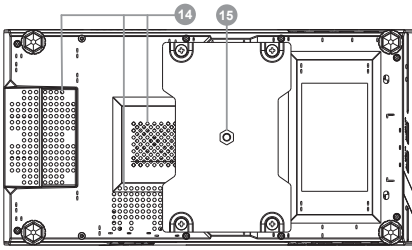

14. Ventilation Port
15. Tripod Mount Hole
16. Wireless Speaker Indicator
17. Projector Indicator
18. Wireless Speaker On/Off Button
19. Projector On/Off Button
20. Battery / Power Status Indicator (Battery indicator only for MGFU-S model)

***Note:**
Follow the steps to open I/O cover.

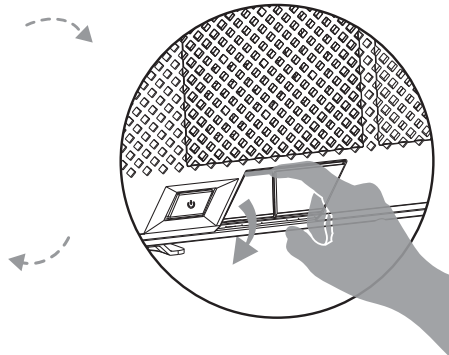
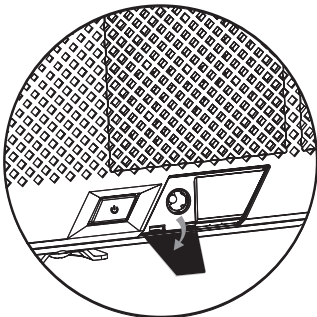
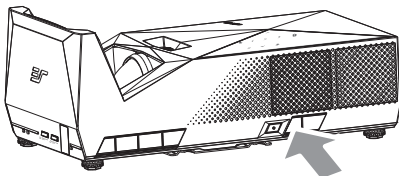

Touch Keypad

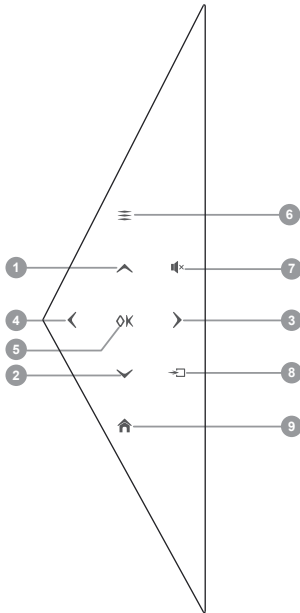

1. Up (adjust keystone up)
2. Down (adjust keystone down)
3. Right
4. Left
5. OK/Enter
6. Menu
7. Mute
8. Input Source Selection
9. Home

Remote Control

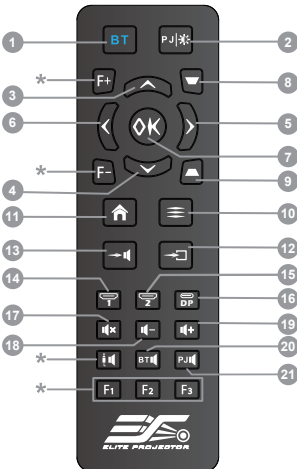





1. Wireless Speaker On/Off, Audio Source Selection(Note)
 2. Projector On/Off, Brightness Adjustment (Note)
 3. Up
 4. Down
 5. Right
 6. Left
 7. OK / Enter
 8. Adjust Keystone Up
 9. Adjust Keystone Down
 10. Menu
 11. Home
 12. Video Source Search
 13. Audio Source Search
 14. HDMI1
 15. HDMI2
 16. DP
 17. Mute
 18. Volume Down
 19. Volume Up
 20. Wireless Audio Input
 21. Projector Audio Input
- * No Function

***Note:**

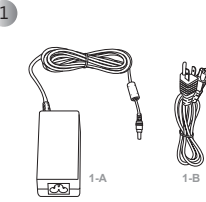
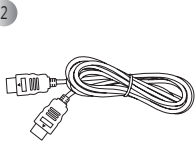
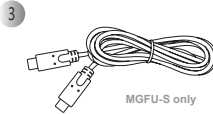
- When projector is off, short press PJ button on remote control to turn on projector.
- When projector is ON, short pressing the PJ button on the remote control will cycle through the following brightness modes: MAX, ECO, and MIN.
- When projector is on, long press PJ button on remote control over 1 second , after prompt message and then short press PJ button again to turn off projector.
- When Wireless Speaker is off, short press BT button on remote control to turn on Wireless Speaker.
- When Wireless Speaker is on, long press BT button on remote control over 1 second to turns off Wireless Speaker.
- When both of projector and wireless speaker are ON, short pressing the BT button will cycle through the source of speaker between projector and wireless audio source.

PRODUCT ACCESSORIES LIST

- 
- 
- 
- 
- 
- 
- 
1. 1-A AC Adaptor
1-B Power Cord
 2. HDMI Cable x1
 3. USB Type C Cable
(*Note: only apply for Sport MGFU-S model)
 4. 4-A Remote Control
4-B Battery (AAx2)
 5. User's Guide (with Warranty Card)
 6. Tripod
 7. Carrying bag

POWER ON/OFF

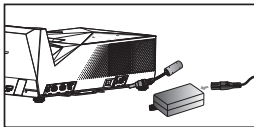

1. Connect the power cord to the DC input jack.

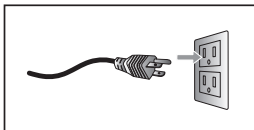

2. Insert the plug into power outlet.

or

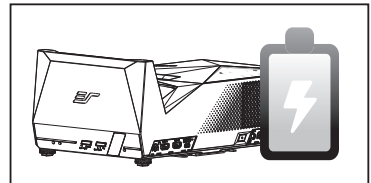

3. MoticGO[®] has an internal battery pack.
Please fully charge the battery before using the projector.
(*Note: Only Sport MGFU-S model has a battery pack)

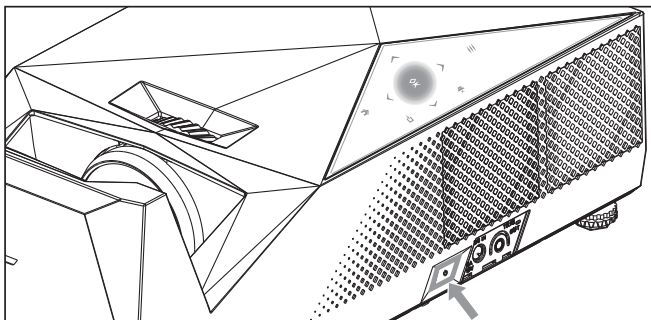

4. Press the Power On/Off Switch. The OK icon on the touch keypad will illuminate.

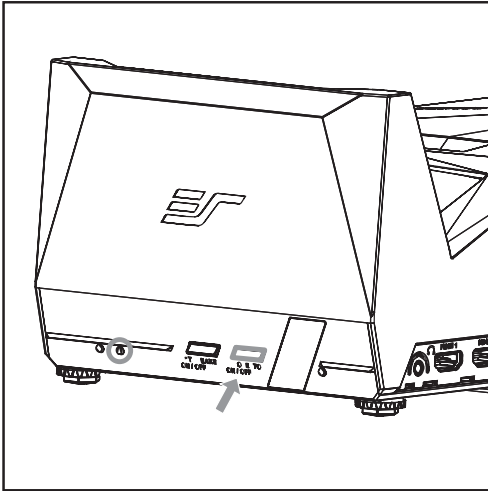

1. Press the PJ button to turn the projector on and the status LED indicator will light up. To turn off the projector, press and hold the PJ button for over 1 second. After seeing prompt message, short press PJ button again to confirm. The MosaicGO logo will show briefly before the device powers off. The status LED indicator light will be flashing as the projector powers down. When projector is ON, short pressing the PJ button on the remote control will cycle through the following brightness modes: MAX, ECO, and MIN.

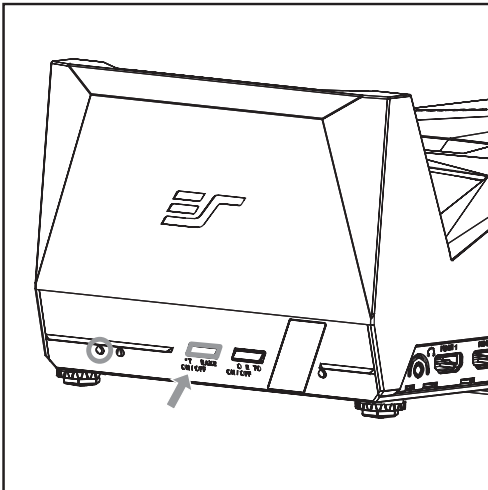

2. Press the Wireless Speaker button to activate this feature. Its blue LED lamp will flash when the Wireless Speaker is in pairing mode. Check "MosaicGO" on your device to connect to MosaicGO Wireless Speaker. When device is connected successfully, the blue LED lamp will light persistently. To turn off the Wireless Speaker, press down and hold the BT button for over 1 second. When both projector and Wireless Speaker are ON, short pressing the Wireless Speaker button on the remote control will switch audio source between projector and Wireless Speaker.

***Note:**
 † An audible tone sounds when the Wireless Speaker powers on/off,
 † or when the projector connects/disconnects to a device.

***Note:**
 † Press the 18 Wireless Speaker button / 19 PJ button to turn off Wireless Speaker / projector before press 7 power off switch.
 † Avoid press 7 power off switch directly when projector / Wireless Speaker still on

BATTERY STATUS INDICATOR

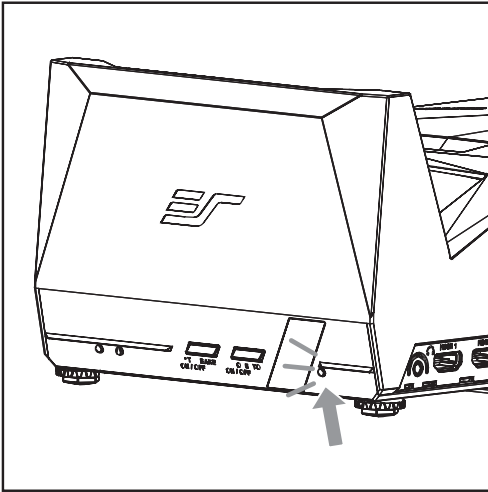

LEDs indicate battery and charging status as following table.

	Adapter Mode	Battery Mode
Green(100%)	Solid	Solid
Green (80% ~)	Flash	Solid
Orange(15%~79%)	Flash	Solid
Red(~14%)	Flash	Solid

In battery mode, MosaicGO will be forced to power off if battery capacity is under 10%. **Suggest charging the battery immediately if LED indicator is Red.**

***Note:**

There is no battery in Lite MGFU-L version. Power LED is green solid when DC adapter is inserted.)

BATTERY FOR POWER SOURCE

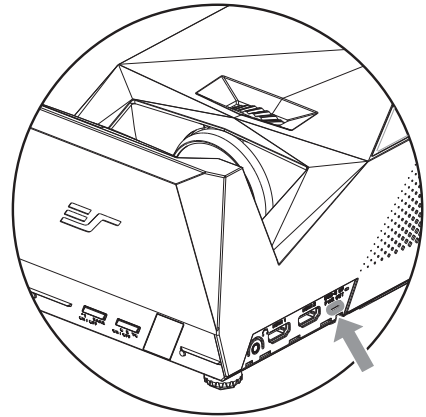
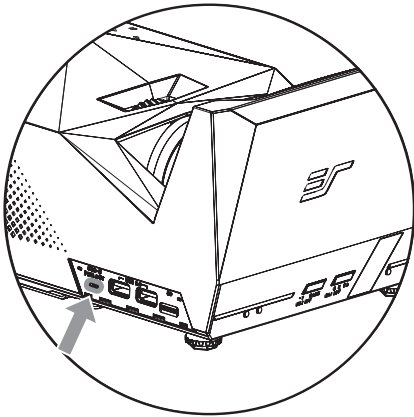

- USB Type C power Delivery:
Type C support PD function. Please refer specification section for details.

***Note:**

When projecting video connect, USB type C ports automatically switch to a lower (5V1A) power rail.

- USB Type A :
Provide 5V/1A max power.

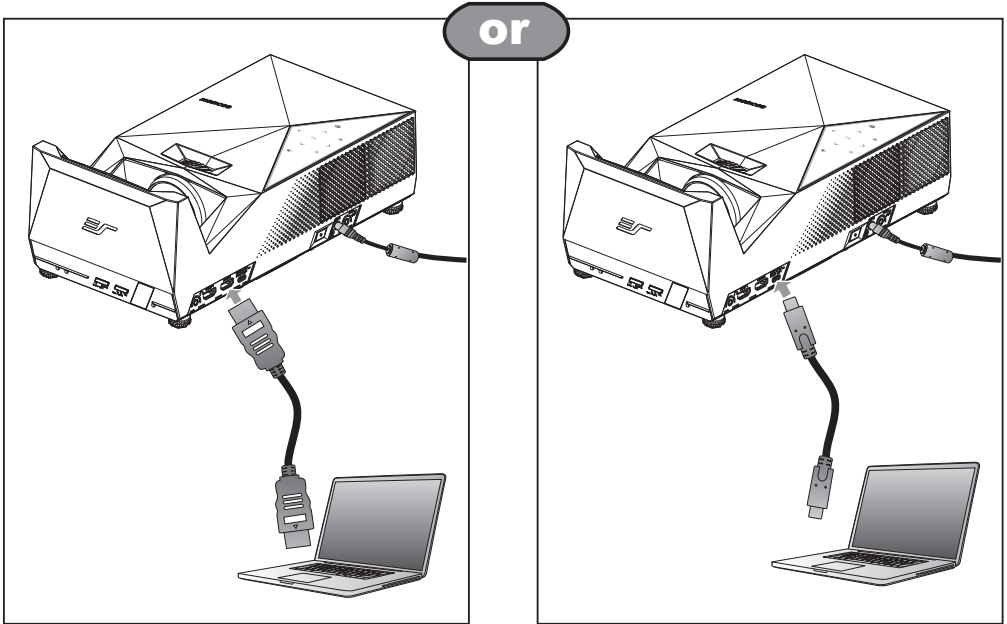

1. Connect the device using HDMI or USB type C cable.

ADJUST PROJECTION IMAGE TILT

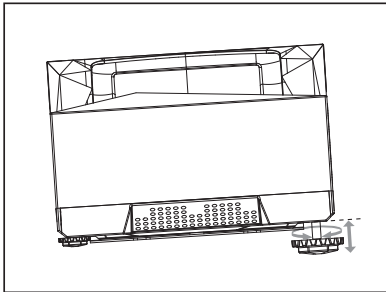

The projector is equipped with four elevator feet for adjusting the projected image tilt.

To adjust the tilt:
Turn the elevator feet to adjust the projected image position to the desired tilt.

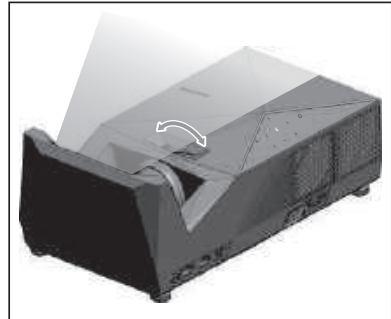

Adjust the focus until the image is clear.

ADJUST THE PROJECTION IMAGE SIZE

A	B	C	D	E	Note
Projector Front Edge Distance to Screen	Screen lower edge to projector table	Projector Screen diagonal	Projector Screen width	Projector Screen height	
inch	inch	inch	inch	inch	
3.82	9.41	60	52.3	29.4	
6.42	10.75	70	61.0	34.3	
9.17	11.89	80	69.7	39.2	
11.97	13.35	90	78.4	44.1	*Note
14.53	14.37	100	87.2	49.0	

A	B	C	D	E	Note
Projector Front Edge Distance to Screen	Screen lower edge to projector table	Projector Screen diagonal	Projector Screen width	Projector Screen height	
cm	cm	cm	cm	cm	
9.7	23.9	152	133	75	
16.3	27.3	178	155	87	
23.3	30.2	203	177	100	
30.4	33.9	229	199	125	*Note
36.9	36.5	254	221	112	

***Note:**

The MosaicGO® (Lite MGFU-L & Sport MGFU-S) portable UST (ultra-short throw) projectors are specifically designed for creating 60-80" imagery in a 16:9 aspect ratio.

Throwing larger (90"-100") images will have corner distortion and is more recommended for videos than in still shot / training presentations.

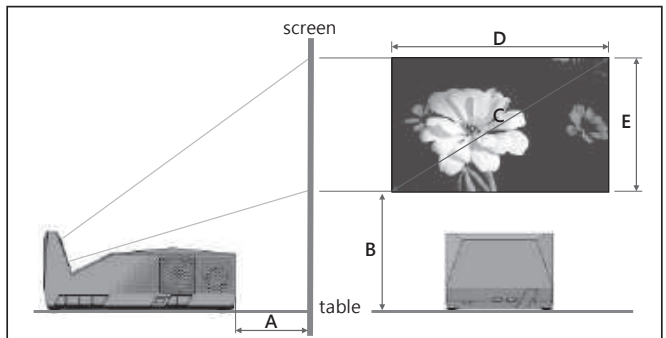
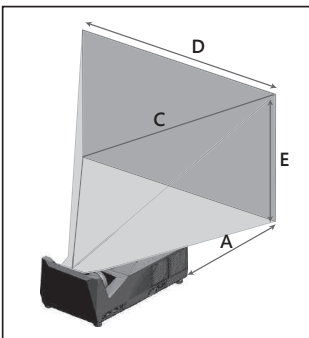

***Note:**

The tolerance is around 5% .

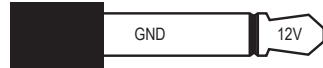
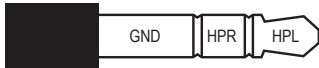

- Earphone, 3.5mm Jack Pin assignment

HPL : Left Channel Audio Signal
 HPR : Right Channel Audio Signal
 GND : Signal Ground

- 12V Trigger Port, 3.5mm Jack Pin assignment

12V : 12V trigger signal for screen rolling up/down
 GND : Signal Ground

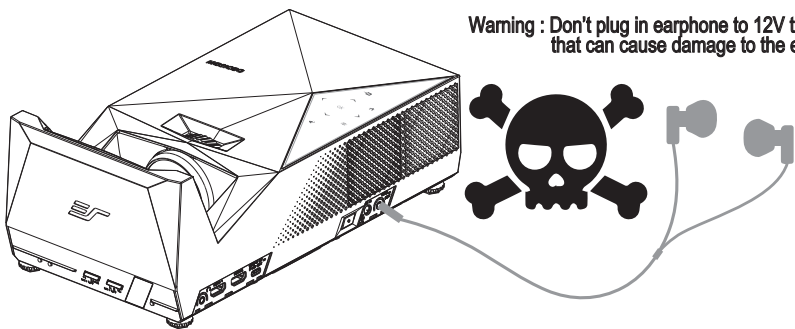
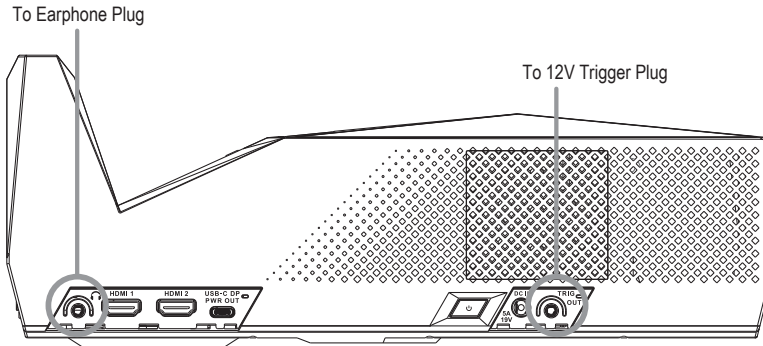

Warning : Don't plug in earphone to 12V trigger port, that can cause damage to the earphone.

MOUNT THE PROJECTOR

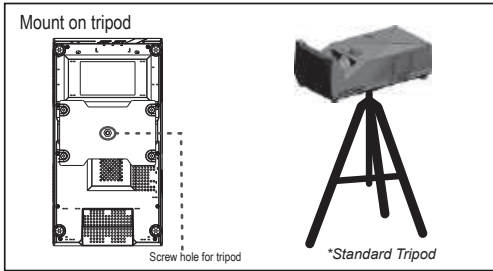

Screw a standard tripod into the screw hole on the projector.

***Note:**

Tripod should support loading above 3Kg, and mounting screw spec is 1/4"

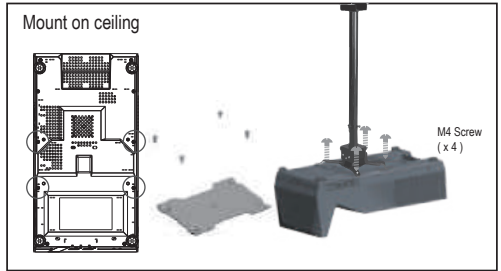

1. Loosen 4 screws to remove metal plate from MosaicGO®.
2. Fasten screws(M4) to ceiling mount kits.

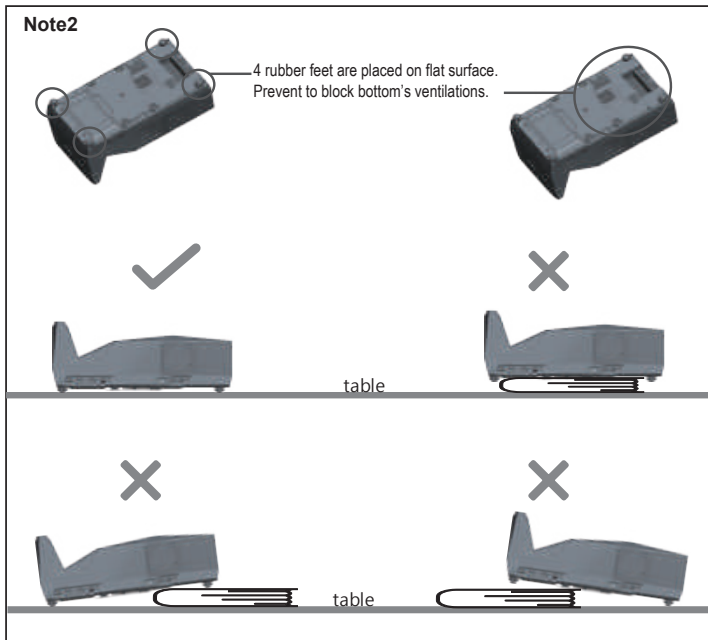
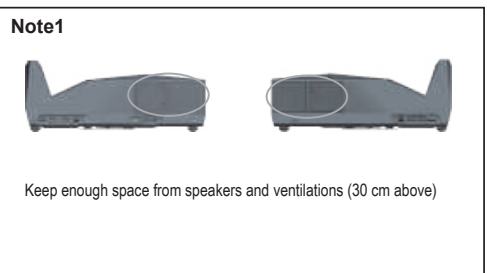
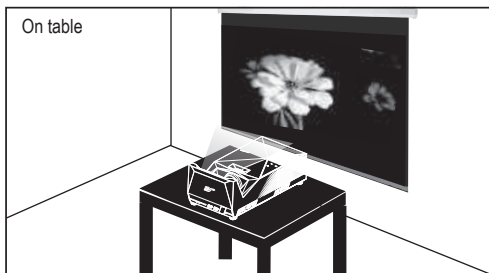

***Note:**
Please keep air vents open for heat ventilation. Otherwise, projector will be turned off if it's over heat.

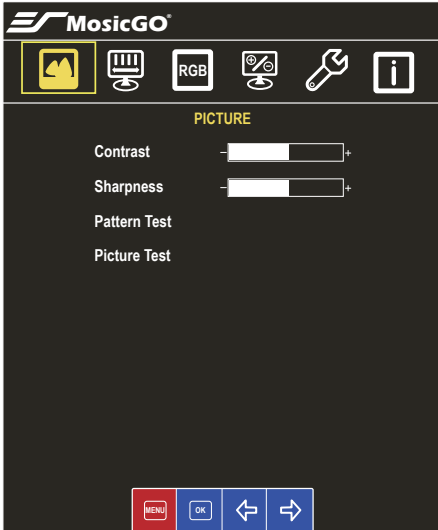

- Contrast: adjust color contrast.
- Sharpness: adjust picture sharpness.
- Pattern Test: present pattern picture to verify focus and color situation of display. Press "OK" will return to current video port.
- Picture Test: circularly present red, green, blue, and white screen to verify picture color. Press "OK" will return to current video port.

***Note:**

1. Contrast and Sharpness can be configured only when video signal is ready.
2. Reset to default setting by selecting 'Menu'->'Other'->'Reset'

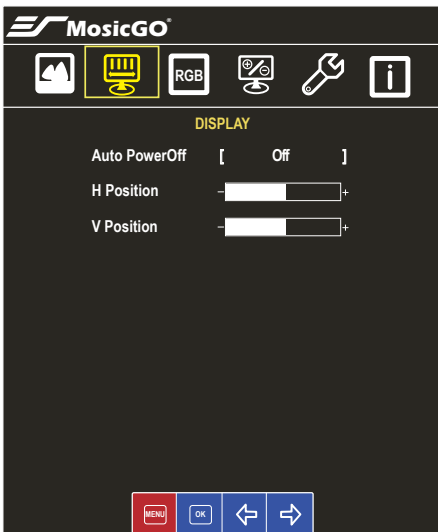

- Auto Power Off: Configure the time before power off if there is no signal to projector.
- H / V Position: Adjust the display position

***Note:**

1. H Position and V Position can be configured only when video signal is ready.
2. Reset to default setting by selecting 'Menu'->'Other'->'Reset'

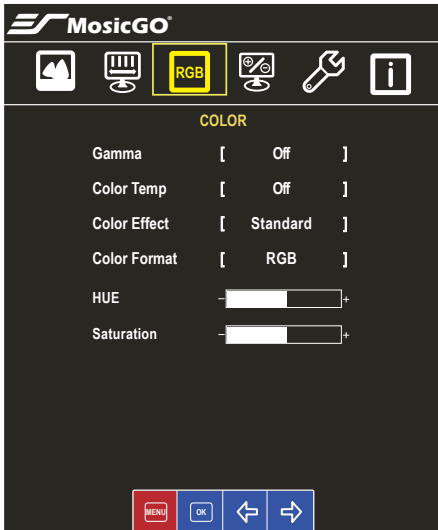

- Configure color properties.

***Note:**
 1. All COLOR Menu can be configured only when video signal is ready.
 2. Some features might not be supported in current model.
 3. Reset to default setting by selecting 'Menu'-'>Other'-'>Reset'

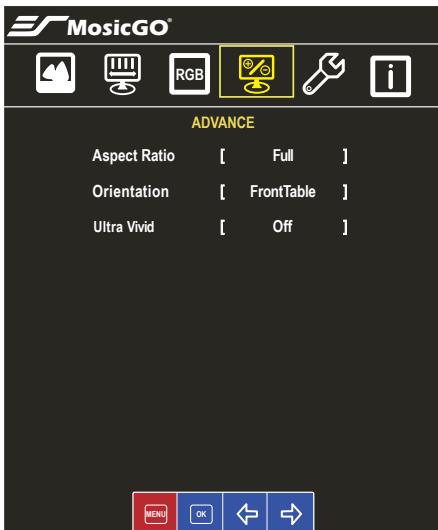

- Set other configuration.
- Aspect Ratio: configure ratio of display area.
- Orientation: according to your projector installation, configure the orientation of display.
- Ultra vivid: enable/disable supporting vivid color.

***Note:**
 1. Aspect Ratio and Ultra Vivid can be configured only when video signal is ready.
 2. Some features might not be supported in current model.
 3. Reset to default setting by selecting 'Menu'-'>Other'-'>Reset'

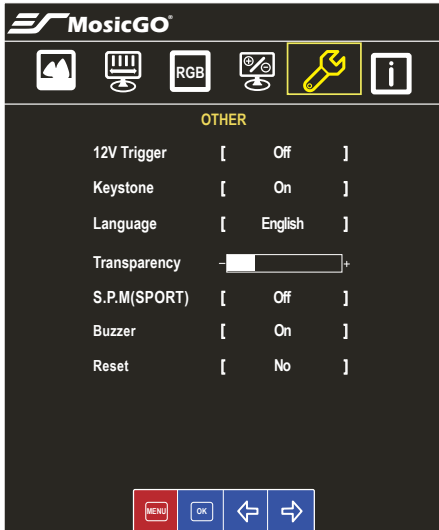

- 12V Trigger: Enable/disable the output of 12V Trigger Out.
- Keystone: adjust the rectangle shape of display.
- Language: configure language
- Transparency: configure the transparency of OSD(on-screen display).
- S.P.M: enable/disable Smart Projector Mode. If enable, MosaicGO[®] will automatically adjust brightness according current battery and power situation.
- Buzzer: enable/disable “beep” alert sound.
- Rest: reset to default setting.

***Note:**

1. Brightness cyclic MAX/ECO/MIN will be disabled when S.P.M is ON.
2. If Keystone is enabled, the projector will automatically adjust the image display within 2-3 seconds. Press up/down key to adjust slightly also.
3. Reset to default setting by selecting 'Menu'-'>'Other'-'>'Reset'

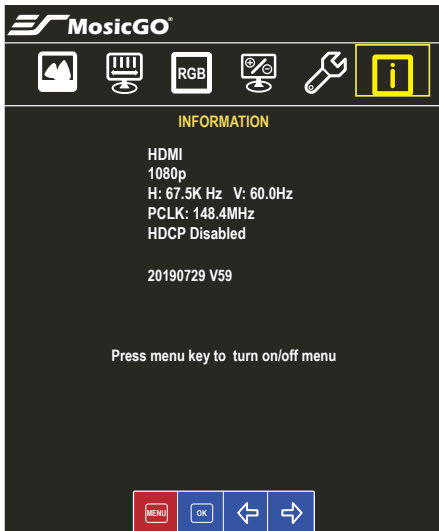

- Present current video signal information.

Item	Description
Imager	DLP
Native Resolution	1920 x 1080 Full-HD
Projection Distance	0.37-0.65 m (1'3" - 2'2") (from screen to lens)
Projection Image Size	1.52-2.54 m (60" - 100") diagonal
Focus	Manual
Throw Ratio	0.3 (80" @ 0.5m)
Keystone	Vertical keystone
Projection Modes	Front Table, Rear Table, Front Ceiling, Rear Ceiling
Standard Input Resolution	Up to FHD (1920 x 1080)
SDTV/EDTV/HDTV	480i, 480p, 576i, 576p, 720p, 1080p
Horizontal Frequency	30.5 - 91.1kHz
Vertical Frequency	50 - 85Hz
Operating Temperature	0 - 40°C
Dimensions (WxHxD)	319 x 168 x 93(back) / 127(front)mm
AC adapter	100 - 240V, 50 - 60Hz
Power Input	19V DC, 6.3A
Power Consumption	Less than 120W
Lamp	RGB LED
Lamp Life	25,000 Hours
Speakers	8W x 2 music power
Battery Capacity	37200mAh (135 Watt-Hours)
Battery Life (for MGFU-S model)	Up to 3 hours play time in Eco mode. Eco Mode: Lowest brightness and low volume.
Input/Output Ports	Alt-DP (USB type C connector) x 1 HDMI 1.4 x 2 USB type A power charging port (5V1A) x 2 USB type C PD power source port x 2 (Note) Earphone out 12V Trigger Out (0.1A output max.) Wireless Speaker audio in x 1
Waterproof	IPX2
Security	Kensington Slot

***Note:**
Power Delivery (PD): maximum 5V/3A, 9V/3A, 15V/3A, 20V/4.35A for port ⑧ USB type-C port
maximum 5V/3A, 9V/3A, 15V/2A, 20V/1.5A for port ⑨ USB type-C port

If you experience a problem with your projector, please refer to the following information. If a problem persists, please contact your local retailer or service center.

★ **No image appears on screen**

- Ensure the power cord is correctly and securely connected.
- Ensure the cable is fine.
- Make sure the projector is switched on.

★ **Image is out of focus**

- Make sure the projection distance is in valid range (refer to page 10).
- Projecting test pattern ("Menu" -> "Picture", press "OK" -> "Pattern Test", press "OK")
- Adjust the focus ring, make the line pattern on four corners and center clear. Exit "Pattern" by press "OK" again.

★ **Image is too small or too large**

- Move the projector closer to or further from the screen.

★ **No sound**

- During music playback, press  /  on the remote control .

★ **Lens with dust or water drops**

- Use a hairdryer on a low heat setting to clear away dust, water or other particles. To Prevent Damaging the Surface Coating, DO-NOT Touch, Wipe or Clean the Lens. If the projection surface is heavily soiled, contact the manufacturer for further assistance.

***Note:**
When the projector's temperature is too high, the projector automatically shuts down due to the built-in temperature protection. This is not a malfunction. Let the projector cool down before switching it on again.

***Note:**
MGFU-S/MGFU-L is splash resistant and was tested under controlled laboratory conditions with a rating of IPX2 under IEC standard 60529. Splash resistance are not permanent conditions and resistance might decrease as a result of normal wear. Do not attempt to charge a wet MGFU-S/MGFU-L; Liquid damage not covered under warranty. To Prevent Damaging the Surface Coating, DO-NOT Touch, Wipe or Clean the Lens. Consult the manufacturer for special cleaning instructions."

Supported HDMI input video signal:

Resolution	Horizontal Frequency (kHz)	Vertical Frequency (Hz)
640 x 350	31.468	70.09
720 x 400	31.469	70.08
640 x 480	31.469	59.94
800 x 600	37.879	60.31
1024 x 768	48.363	60.00
1152 x 864	54.348	60.053
1360 x 768	47.712	60.015
1280 x 1024	63.981	60.020
1920 x 1080	67.5	60

* If an invalid signal is input into the projector, it will not be displayed properly on the screen or a message such as "not support" will be displayed.
* To provide the best picture quality, 1920 x 1080 (1080p) resolution is recommended.

☆ 3 continuous beep sound

You may hear 3 continuous beep sound accompany following icon on the screen



Low battery: projector is turned off immediately. Please plug power adapter to charge the battery. You can turn on the projector during charging.



Battery fail: if the power adapter is plugged. You can turn on and use projector. If you pull out the power adapter, the projector may be turned off without any warning. If the problem still occurs, please check your vendor.



Over heat: projector is turned off immediately. Suggest to let projector be off for a while before it is turned on again.



Fan error: projector is turned off immediately. If the problem still occurs, please check your vendor.

***Note:**

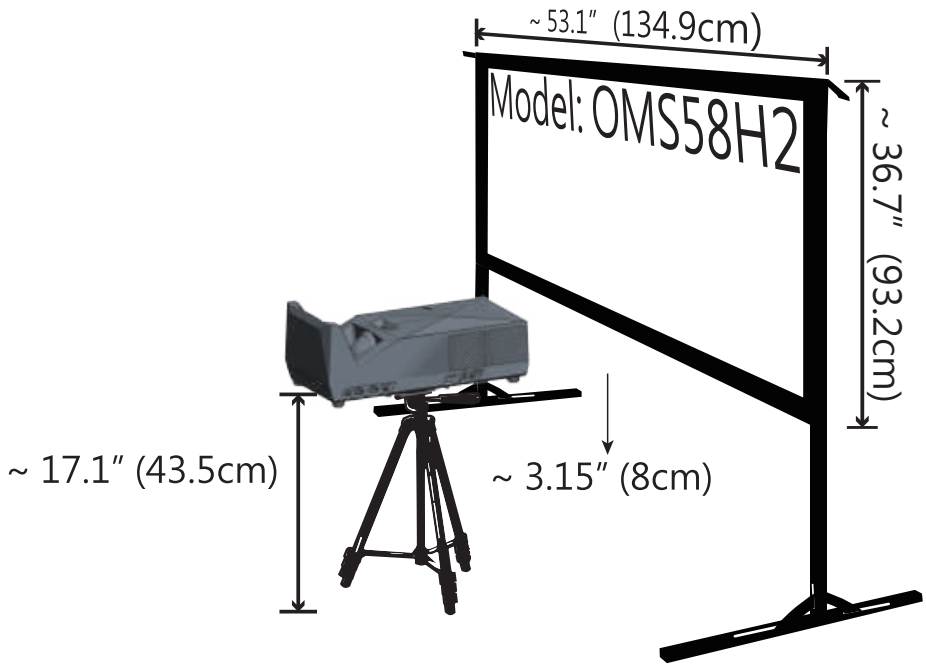

Projector may be over heat and turned off immediately. Suggest to let projector be off for a while before it is turned on again.

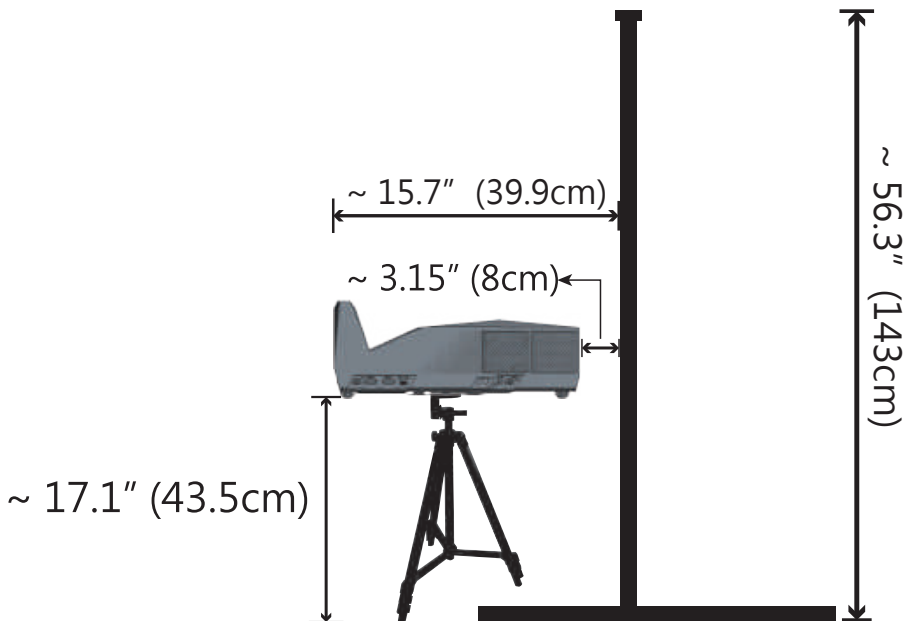

•Actual Height and Distance May Vary



13 Months Warranty Card

Customer's name:	
Phone number:	
Email:	
Address:	
Date of purchase: (M) (D) (Y)	
Model No: S/N:	
<p>* To ensure your right, please ask the Dealer to fill in the information above, and have Dealer's stamp on this card.</p> <p>* If date of purchase cannot be provided with dealer's stamp, the manufacture date as recorded will be deemed to be the start of the Warranty Period.</p>	Dealer's Stamp:
	

Elite Screens Visual & Sound Co., Ltd.

MUSICGO®

MOVIES MUSIC POWER GO



For more update user manual:
Electronic file link
www.eliteprojector.com/MGFU/manual

www.eliteprojector.com
Printed in Taiwan
FBZZ-MG1Z002-05