

Canon

**MULTIMEDIA PROJECTOR
4K6021Z**

User's Manual



Safety Instructions

Before Use

Basic Guide

Projection Procedure

Convenient Projection Features

Installation Guide

Installation Procedure

Connection Procedure

Adjusting the Image

Special Arrangements

Menu Guide

Using Menus

Menu Configuration

Menu Description

Maintenance

Product Specifications

Troubleshooting

ENG

How to Use This Manual

Thank you for purchasing a Canon projector.

The 4K6021Z Multimedia Projector is a high-performance laser projector capable of projecting high-resolution computer screens and high-quality digital images on a large screen.

This Manual

This is the user's manual for 4K6021Z Multimedia Projector (hereafter, "projector"). The "Basic Guide" describes basic steps before projection and introduces features that are convenient in presentations and other situations. The "Installation Guide" covers how to install the projector and join a network, and the "Menu Guide" explains setting menus and how to use them.

Read this manual thoroughly to make the most of your projector. We recommend requesting installation by a qualified technician or the Canon Customer Support Center.

Symbols of Button Operations

The projector can be operated using the buttons on the remote control or on the side of the projector. The remote control allows you to operate all functions of the projector.

In this document, the button's operations are shown as below.

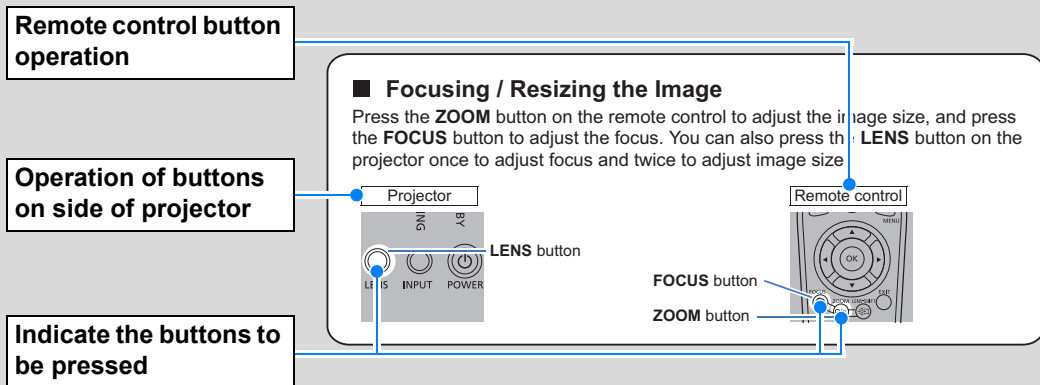

Symbols Used in This Manual

Sections labeled with these symbols give the following kinds of information.

 Indicates precautions and information to note when using the projector.

4K6021Z/4K6020Z/4K5020Z/WUX7000Z/WUX6600Z/ WUX5800Z/WUX7500/WUX6700/WUX5800

Notification of an Addition to Functions with a Firmware Upgrade

4K6021Z (Ver. 01.010100)

4K6020Z/4K5020Z (Ver. 01.040300)

WUX7000Z/WUX6600Z/WUX5800Z (Ver. 01.040400)

WUX7500/WUX6700/WUX5800 (Ver. 01.040200)

■ Addition of a Dynamic Contrast Function (4K6021Z/4K6020Z/ 4K5020Z/WUX7000Z/WUX6600Z/WUX5800Z only)

Refer to “Contrast detail adjustment” in this manual.

■ Addition of a Set Value Copy Function (Common to All Models)

You can copy the set values of a projector to other projectors from a computer via a network by connecting this device to wired LAN or wireless LAN.

You cannot copy the following settings.

- [Input settings] Tab
Input level / Color space / Progressive / PC-free multi projection / Split screen
- [Image adjustment] Tab
Image Priority / Image Mode (*1)
- [Install settings] Tab
Zoom / Keystone / Digital image shift / Professional Settings → RGB alignment, Lens shift mode, Marginal Focus and Edge Blending / Lens position
- [System settings] Tab
User screen settings → User logo / On screen → Menu position / Remote control channel / Other settings
- [Network settings] Tab
Items Other Than PjLink, AMX Device Discovery and Crestron RoomView
- [Information] Tab Contents
- Other
Zoom, Focus, Lens shift, Input, Digital zoom, Mute and Freeze

Steps to Copy Set Values

- 1** Connect the computer and projectors to wired LAN or wireless LAN (*2) (*3).
- 2** Startup the web browser. Input “http://(IP address of the projector for reading)/professional/read” and then press the [Enter] key.
- 3** Input the login username and password on the web screen (*4).
The READ screen will be displayed.
- 4** Press the [Start read] button.
- 5** Press the [OK] button once the reading has been completed.
The read file will be saved in the download folder.
- 6** Input “http://(IP address of the projector for writing)/professional/write” in the address of the web browser and then press the [Enter] key.
Input the login username and password on the web screen in the same way as with step 3.
The WRITE screen will be displayed.
- 7** Press the [Browse] button. Select the set value file you saved in step 5 and then press the [Start write] button.
- 8** Press the [OK] button once the writing has been completed.

* If you wish to copy set values to multiple projectors, repeat steps 6 to 8.

(*1) If the user memory has already been created at the copy source, that content will be reflected in the copy destination. If it has not already been created at the copy source, the user memory at the copy destination will be retained.

(*2) Refer to “Network settings” in this manual for details.

(*3) Operating conditions:

- The projector should be in the projection or standby state (4K6021Z/4K6020Z/4K5020Z/WUX7000Z/WUX6600Z/WUX5800Z)
- The projector should be in the projection state (WUX7500/WUX6700/WUX5800)
- The wired or wireless network function should be on

(*4) Refer to “Password settings” in this manual for details.



Caution

Communications may fail due to a timeout if the standby power settings of the projector are in “Low-power” depending on the browser specifications.

In that case, reload the page and re-read/write.

Table of Contents

How to Use This Manual	2	Connection Procedure	62
Projector Highlights	4	Connecting Other Equipment.....	62
Safety Instructions	6	Connecting to a Network.....	65
Safety Symbols in this Manual	12	Controlling the Projector from a Computer	79
Precautions for Use	13	Adjusting the Image	81
Power Supply	13	Filling the Screen	81
Installation and Use	15	Adjusting Keystone Distortion	81
Laser Light Source	16	Advanced Registration to Adjust Projected Images	85
Remote Control Batteries.....	17	Adjusting Projected Images with Partial Distortion Correction.....	89
Handling.....	17	Adjustment Using a Test Pattern	92
For Safe Use	19	Special Arrangements	93
Carrying and Installation.....	19	Adjusting Peripheral Focus	93
Before Installation	21	Projecting from Multiple Projectors at Once (Edge Blending)	96
Precautions When Carrying / Shipping the Projector	21	Menu Guide	101
Precautions for Installation.....	21	Using Menus	102
Open Source Software	26	Menu Configuration	105
Before Use	27	Menu Description	113
Included Accessories	27	Input settings	113
Projector Part Names and Functions.....	28	Image adjustment	117
Remote Control.....	33	Install settings.....	127
Basic Guide	38	System settings	139
Projection Procedure	39	Network settings	158
Step 1 Connect Other Equipment.....	40	Checking Projector Information	173
Step 2 Turn the Projector On	41	Projector Web Screen Menu	174
Step 3 Select an Input Signal.....	42	Maintenance /	
Step 4 Adjust the Image	43	Product Specifications /	
Step 5 Select the Image Quality (Image Mode).....	44	Troubleshooting	190
Turn the Projector Off.....	46	Maintenance	191
Convenient Projection		Cleaning the Projector.....	191
Features	47	Replacing the Air Filter.....	191
Convenient Features	47	Product Specifications	193
Installation Guide	50	Troubleshooting	205
Installation Procedure	51	LED Indicator Details	205
Relationship Between Projecting Distance and Image Size	51	Symptoms and Solutions	206
Installing / Removing the Lens Unit ...	53	Index	211
Installation	56	Option	213

Projector Highlights

Bright Yet Compact, With a Laser Light Source

A bright projector that is also compact, at 480 x 545 x 196 mm (18.9 x 21.5 x 7.7 in., W x D x H). Features a laser light source that lasts longer than traditional mercury lamps.

Peripheral Focus Adjustment

Image focus can be adjusted on the edges of the screen, enabling use in dome projection.

HDBaseT Input

The projector supports HDBaseT, a next-generation connectivity standard. HDBaseT offers a convenient connection for carrying high-quality video and audio signals equivalent to HDMI across distances up to 70 m (229.7')* over a single LAN cable.

* Maximum distance for 2K signals: 100 m (328.1')

Lens Shift

Lens shift enables motorized image repositioning up, down, left, or right for greater freedom in installation.

Motorized Zoom and Focus Adjustment

Efficient setup using motorized zoom and focus adjustment.

Full Range of Lens Units Available

Choose the optimal lens unit for the projection distance or purpose.

Superior Video Viewing Experience

Refinements in motion blur reduction make video projection more enjoyable to watch.

Scheduling

Automate projector tasks according to your schedules. Turn the projector on or off, switch input signals, and more.

Edge Blending

Blend the overlapping edges of images from multiple projectors to make the overall image more seamless.

Wi-Fi Connectivity

In addition to wired LAN connectivity, the projector also supports Wi-Fi. In Projector Access Point (PJ AP) mode, the projector can be connected to up to five computers without using a wireless access point.

Canon Service Tool for PJ (Canon ST)

An iOS app for easy remote control and status management of projectors over Wi-Fi. Connect to a projector used as an access point (P66), or connect via an existing access point (P66). Note that a password is required when using Canon ST (P174).

DisplayPort

The DisplayPort interface supports 4K_60P_10bit_4:4:4 video signals*, making possible more realistic images and smoother gradients.

* When two DisplayPort 1.2 ports are used together.





Safety Instructions

Before installing and operating the projector, read this manual thoroughly.

This projector provides many convenient features and functions. Operating the projector properly enables you to manage those features and maintain it in good condition for many years to come.

Improper operation may result in not only shortening the product life, but also malfunctions, fire hazards, or other accidents.

If your projector does not seem to be operating properly, read this manual again, check operations and cable connections, and try the solutions in the “Troubleshooting” section in the back of this manual. If the problem still persists, contact the Canon Customer Support Center.

	CAUTION RISK OF ELECTRIC SHOCK DO NOT OPEN	
	THIS SYMBOL INDICATES THAT DANGEROUS VOLTAGE CONSTITUTING A RISK OF ELECTRIC SHOCK IS PRESENT WITHIN THIS UNIT.	
	THIS SYMBOL INDICATES THAT THERE ARE IMPORTANT OPERATING AND MAINTENANCE INSTRUCTIONS FOR THIS UNIT IN THE OWNER'S MANUAL.	

CAUTION

Not for use in a computer room as defined in the Standard for the Protection of Electronic Computer / Data Processing Equipment, ANSI / NFPA 75.

Safety Precautions

WARNING:

- **THIS APPARATUS MUST BE GROUNDED.**
- **TO REDUCE THE RISK OF FIRE OR ELECTRIC SHOCK, DO NOT EXPOSE THIS APPLIANCE TO RAIN OR MOISTURE.**

- This projector produces intense light from the projection lens. Do not stare directly into the lens, otherwise eye damage could result. Be especially careful that children do not stare directly into the beam.
- Install the projector in a proper position. Otherwise it may result in a fire hazard.
- Do not cover the ventilation slots on the projector. Heat build-up can reduce the service life of your projector, and can also be dangerous.
- If the projector is unused for an extended time, unplug the projector from the power outlet.
- Do not project the same image for a long time.

An afterimage may remain on the LCD panels due to the characteristics of the panels of the projector.

CAUTION ON HANGING FROM THE CEILING

When hanging the projector from the ceiling, clean the air intake vents and top of the projector periodically with a vacuum cleaner. If you leave the projector unclean for a long time, the cooling fans can be clogged with dust, and it may cause a breakdown or a disaster.

DO NOT SET THE PROJECTOR IN GREASY, WET, OR SMOKY CONDITIONS SUCH AS IN A KITCHEN TO PREVENT A BREAKDOWN OR A DISASTER. IF THE PROJECTOR COMES IN CONTACT WITH OIL OR CHEMICALS, IT MAY BECOME DETERIORATED.

■ READ AND KEEP THIS OWNER'S MANUAL FOR LATER USE.

All the safety and operating instructions should be read before beginning to operate the product.

Read all of the instructions given here and retain them for later use. Unplug this projector from the AC power supply before cleaning. Do not use liquid or aerosol cleaners on the projector. Use a damp cloth for cleaning.

Follow all warnings and instructions marked on the projector.

For added protection of the projector during a lightning storm, or when it is left unattended or unused for long periods of time, unplug it from the wall outlet. This will prevent damage due to lightning and power surges.

Do not expose this unit to rain or use near water... for example, in a wet basement, near a swimming pool, etc...

Do not use attachments not recommended by the manufacturer as they may result in hazards.

Do not place this projector on an unstable cart, stand, or table. The projector may fall, causing serious injury to a child or adult, and serious damage to the projector. Use only with a cart or stand recommended by the manufacturer, or sold with the projector. Wall or shelf mounting should be carried out in accordance with the manufacturer's directions, and should use a mounting kit approved by the manufacturers.

An appliance and cart combination should be moved with care. Sudden stops, excessive force, and uneven surfaces may cause the appliance and cart combination to overturn.



Slots and openings in the rear and front of the cabinet are provided for ventilation, to insure reliable operation of the equipment and to protect it from overheating.

The openings should never be covered with cloth or other materials, and the bottom opening should not be blocked by placing the projector on a bed, sofa, rug, or other similar surface. This projector should never be placed near or over a radiator or heat register.

This projector should not be placed in a built-in installation such as a book case unless proper ventilation is provided.

Safety Instructions

Never push objects of any kind into this projector through cabinet slots as they may touch dangerous voltage points or short out parts that could result in a fire or electric shock. Never spill liquid of any kind onto the projector.

Do not install the projector near the ventilation duct of air-conditioning equipment.

This projector should be operated using only the type of power source indicated on the marking label. If you are not sure of the type of power supplied, contact the Canon Customer Support Center or local power company.

Do not overload wall outlets and extension cords as this can result in fire or electric shock. Do not allow anything to rest on the power cord. Do not locate this projector where the cord may be damaged by people walking on it.

Do not attempt to service this projector yourself as opening or removing covers may expose you to dangerous voltages or other hazards. Refer all servicing to qualified service personnel.

Unplug this projector from the wall outlet and refer servicing to qualified service personnel under the following conditions:

- a. When the power cord or plug is damaged or frayed.
- b. If liquid has been spilled into the projector.
- c. If the projector has been exposed to rain or water.
- d. If the projector does not operate normally after following the operating instructions. Adjust only those controls that are covered in the operating instructions as improper adjustment of other controls may result in damage and will often require extensive work by a qualified technician to restore the projector to normal operating condition.
- e. If the projector has been dropped or the cabinet has been damaged.
- f. When the projector exhibits a distinct change in performance-this indicates a need for servicing.

When replacement parts are required, be sure the service technician uses replacement parts specified by the manufacturer that have the same characteristics as the original parts. Unauthorized substitutions may result in fire, electric shock, or injury.

Upon completion of any service or repairs to this projector, ask the service technician to perform routine safety checks to determine that the projector is in safe operating condition.

AC Power Cord Requirement

The AC Power Cord supplied with this projector meets the requirements for use in the country you purchased it.

AC Power Cord for the United States and Canada:

The AC Power Cord used in the United States and Canada is listed by the Underwriters Laboratories (UL) and certified by the Canadian Standard Association (CSA).

The AC Power Cord has a grounding-type AC line plug. This is a safety feature to ensure the plug fits into the power outlet. Do not try to tamper with this safety feature. Should you be unable to insert the plug into the outlet, contact your electrician.

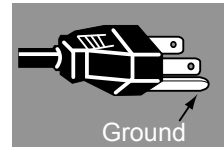

THE SOCKET-OUTLET SHOULD BE INSTALLED NEAR THE EQUIPMENT AND EASILY ACCESSIBLE.



Only for European Union and EEA (Norway, Iceland and Liechtenstein)

These symbols indicate that this product is not to be disposed of with your household waste, according to the WEEE Directive (2012/19/EU), the Battery Directive (2006/66/EC) and/or national legislation implementing those Directives.



If a chemical symbol is printed beneath the symbol shown above, in accordance with the Battery Directive, this indicates that a heavy metal (Hg = Mercury, Cd = Cadmium, Pb = Lead) is present in this battery or accumulator at a concentration above an applicable threshold specified in the Battery Directive.









This product should be handed over to a designated collection point, e.g., on an authorized one-for-one basis when you buy a new similar product or to an authorized collection site for recycling waste electrical and electronic equipment (EEE) and batteries and accumulators. Improper handling of this type of waste could have a possible impact on the environment and human health due to potentially hazardous substances that are generally associated with EEE. Your cooperation in the correct disposal of this product will contribute to the effective usage of natural resources.

For more information about the recycling of this product, please contact your local city office, waste authority, approved scheme or your household waste disposal service or visit

www.canon-europe.com/weee, or www.canon-europe.com/battery.

Safety Symbols in this Manual

This section describes the safety symbols used in this manual. Important projector safety information is identified by the following symbols. Always observe the safety information by these symbols.

 Warning	Denotes the risk of death or serious injury from improper handling if the information is not observed. To ensure safe use, always observe this information.
 Caution	Denotes the risk of injury from improper handling if the information is not observed. To ensure safe use, always observe this information.
	Denotes the risk of electric shock from improper handling if the information is not observed. To ensure safe use, always observe this information.
	Denotes the risk of burns from improper handling if the information is not observed. To ensure safe use, always observe this information.
 Prohibition	Denotes prohibited actions.
 Caution	Denotes required actions or information that must be observed.

Precautions for Use

As this section contains important safety-related information, be sure to read the following carefully beforehand in order to use your projector correctly and safely.

Warning

Power Supply

During installation, keep the projector plug easily accessible so that the projector can be unplugged immediately if necessary, or keep a circuit breaker within reach.

If the following situations occur, turn the power off, remove the power plug from the power outlet and contact the Canon Customer Support Center. Failure to do so could cause a fire or result in an electric shock.



- If smoke is emitted
- If an unusual smell or noise is emitted
- If water or other liquid has entered the projector
- If metal or any other foreign material has entered the projector
- If the projector is knocked over or dropped and the cabinet is damaged

Pay attention to the following points regarding the power source, power plug and handling of the connector. Failure to do so may cause a fire or electric shock.



Prohibition



- Do not place any objects on the power cord and do not allow it to become trapped under the projector.
- Do not cover the power cord with a carpet.
- Do not modify or excessively bend, twist, pull, wind, or bundle the power cord.
- Keep the power cord away from heaters and other sources of heat.
- Do not use a damaged power cord. If the power cord is damaged, contact the Canon Customer Support Center.
- Do not use any power source with a voltage other than the voltage indicated (AC 100 – 240 V).
- Do not insert any metal objects into the contact parts of the power plug or connector.
- The power cord included with this projector is for use exclusively with this product. Do not use this cord for other products.



- Do not remove the power plug or connector with wet hands.

Warning

Pay attention to the following points regarding the power source, power plug and handling of the connector. Failure to do so may cause a fire or electric shock.



- Insert the power plug and connector securely up to the base. Additionally, do not use a damaged power plug or an outlet that is loose.
- Do not pull the power cord and be sure to hold the power plug or connector when removing. Incorrect handling may damage the power cord.
- When using an extension cord, do not exceed the cord's rated capacity.
- Do not exceed the rated capacity of the outlet (as by using it for more than one piece of equipment), which poses a risk of fire from overheating.
- Periodically inspect the power plug and outlet and remove any dust or dirt from between the plug and the outlet.
- Do not touch the projector itself, the power cord, or the cable if lightning strikes.
- Do not move the projector until you have switched off the power, removed the power plug from the power outlet and unplugged any other cables.
- Unplug the projector before cleaning or maintenance.
- Before you install or remove the lens unit, be sure to unplug the power plug of the projector from the power outlet.

Warning

Installation and Use

Pay attention to the following points regarding installation and handling of the projector. Failure to do so may cause a fire, electric shock or personal injury.



- Do not use the projector where it might get wet, such as outdoors or by bathtubs or showers.
- Do not place containers containing a liquid on top of the projector.
- Do not install the projector in a location that is damp or dusty, or where there is a lot of oily smoke or steam. Oil can degrade the plastic, which could result in a ceiling-mounted projector falling from its mounting.
- Make sure to implement anti-fall measures such as an anti-fall wire when installing the projector in high places, for example, installing it on the ceiling.
- Do not remove the cabinet from the projector or disassemble it. The interior of the projector contains high-voltage components as well as parts that are hot. If inspection, maintenance or repair is required, contact the Canon Customer Support Center.
- Do not disassemble or modify the projector (including consumable parts) or the remote control.
- Do not look directly into the exhaust vents during use.
- Do not insert any object into vents in the projector, such as the air intake vent or exhaust vents.
- Do not place a pressurized can in front of the exhaust vents. The pressure of the contents of the can may increase due to heat from the exhaust vents and this could result in an explosion.
- When cleaning off dust or dirt from projector parts such as the lens or filter, never use any spray that is flammable. Internal parts that become hot may ignite and cause a fire.
- Do not use adhesives, lubricants, oils, or alkaline detergents for maintenance of the projector. They could adhere to the cabinet and damage it, possibly resulting in the projector falling from its mounting and causing an accident or personal injury.
- As strong light beams are emitted while the projector is in use, do not look directly into the projector lens. Doing so could cause an eye injury. Pay particular attention to prevent small children from doing so.
- Operators shall control access to the beam within the hazard distance or install the product at a height that will prevent eye exposure within the hazard distance.



Prohibition



Warning

Pay attention to the following points regarding installation and handling of the projector. Failure to do so may cause a fire, electric shock or personal injury.



Prohibition



Caution

- Do not hold or install optical instruments (such as magnifying glasses, reflectors, or glasses) in the path of light from the projector. If projected light is refracted or reflected and enters people's eyes, it may result in eye injury.
- If children may approach the projector or touch it, always ensure the projector is used under adult supervision.
- No direct exposure to the beam shall be permitted.
- Do not lift the projector alone. Have at least one assistant.
- When setting the projector on a high surface for projection, be sure the surface is flat and stable.
- Do not use the projector on a soft surface such as carpet or sponge mat, etc.
- For ceiling mounting or other installation work, request service from a qualified technician or the Canon Customer Support Center. Poor installation work could result in an accident.
- To avoid hazards such as parts falling when the lens of a ceiling-mounted projector is replaced, request service from a qualified technician or the Canon Customer Support Center.
- Do not use where combustible or explosive gases may occur. Internal parts that become hot may ignite and cause a fire.

Warning

Laser Light Source



Prohibition



Caution

- The projector incorporates a laser module. Disassembly or modification is dangerous and must not be attempted.
- Operate and adjust the projector only as described in this manual. Incorrect operation or adjustment poses a risk of exposure to potentially hazardous laser light.
- Do not use when damaged. Even if the projector is used as described in this manual, failure to discontinue use when it is damaged (as indicated by screen abnormalities) may result in fire, electric shock, or eye injury from laser light.
- For assistance when disposing of the projector, contact the Canon Customer Support Center. Do not disassemble the projector yourself when disposing of it.

Warning

Remote Control Batteries

Pay attention to the following points regarding handling of batteries. Failing to do so could result in a fire or personal injury.



- Do not heat, short circuit or disassemble the batteries, or place them in a fire.
- Do not attempt to recharge the batteries that are included with the remote control.
- Remove the batteries when they are flat or when the remote control will not be used for a long period of time.
- When replacing the batteries, replace both at the same time. Also, do not use two batteries of a different type at the same time.
- Insert the batteries with the + and – terminals in the correct directions.
- If any liquid from inside the batteries leaks out and contacts your skin, be sure to wash the liquid off thoroughly.

Caution

Handling

Pay attention to the following points regarding installation and handling of the projector.



- If the projector will not be used for a long period of time, be sure to remove the power plug from the power outlet to ensure safety. Failure to do so presents a risk of fire if dust accumulates on the plug or outlet.
- Do not plug headphones or earphones into the AUDIO OUT terminal. Doing so may cause hearing impairment.
- Do not set the volume too high initially. Doing so may cause hearing impairment from sudden sounds played at high volume. Lower the volume before turning off the projector, and after startup, raise it gradually.
- Do not touch parts of the cabinet around and above the exhaust vents, which may become hot during projection. Pay particular attention in preventing young children from touching these parts. Additionally, do not place any metal objects around or above the exhaust vents. Such objects may become hot from the projector, which may result in burns or other injury.

Caution

Pay attention to the following points regarding installation and handling of the projector.



Prohibition

- Do not place any heavy objects on top of the projector or sit/stand on it. Pay particular attention to prevent small children from doing so. The projector may be knocked over and this could result in damage or a personal injury.
- Do not place the projector on an unstable or slanted surface. Doing so may cause the projector to fall or be knocked over and could result in a personal injury.
- Do not place any objects in front of the lens during projection. Doing so could cause a fire.
- The projector is provided with a lens shift function to move the lens up, down, left, and right using the motor. Do not touch the lens while it is moving. Touching the lens when it is moving may result in personal injury.
- Before replacing the lens unit, wait at least 30 minutes after the projector is turned off to allow the lens unit to cool down. Failure to do so may result in burns or injury.



Caution

Carrying and Installation

Pay attention to the following points when carrying or transporting the projector.



Caution

- If transportation is necessary, the lens unit should be removed before transporting the projector. If the projector is subjected to excessive impacts during transportation, the lens unit or projector may be damaged.
- This projector is a precision instrument. Do not knock it over or subject it to impacts. Doing so may cause a malfunction.
- Retract the adjustable feet before moving the projector. Leaving the feet extended may cause damage.
- When carrying or holding up the projector after attaching the lens unit, be sure not to hold the lens. Doing so may cause damage to the lens unit or projector.
- Do not touch the lens with bare hands. Any smudges or fingerprints on the lens may affect image quality.
- Protection of the projector cannot be guaranteed if used packaging or shock-absorbent materials are reused. Fragments from shock-absorbent material may also enter the interior of the projector which could cause a malfunction.

Caution

Pay attention to the following points when installing or using the projector.

- Be careful of condensation.
If the projector is abruptly taken to a warmer location, or if the room temperature rises abruptly, moisture in the air may condense on the lens or mirror and affect projected images. In this case, wait a while and make sure the moisture has evaporated before resuming use.
- Do not install the projector in a location where the temperature is high or low. Doing so may cause a malfunction. Ranges for the environment of use and storage are as follows.
 - Environment of use: 0°C (32°F) to 45°C (113°F), 20% to 85% RH
 - Storage temperature: -20°C (-4°F) to 60°C (140°F)
- When using the projector at altitudes above 2,300 m (7,545.8'): Adjust projector installation settings from the menu (P133).
- Install the projector leaving at least 50 cm (1.6') between air intake/exhaust vents and walls on each side of the projector. Leave a gap of at least 2 cm (0.8") from the bottom of the projector. There is an air intake underneath the projector. Failure to leave enough space may trap heat inside the projector and damage it.



Caution

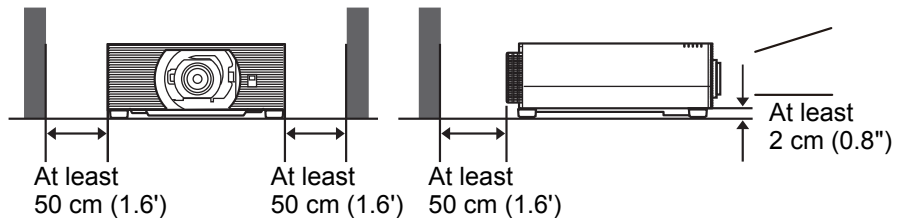

- Do not place any objects on top of the projector that may change shape or color due to heat.
- Do not install the projector near high-voltage electrical power lines or an electrical power source. This may cause malfunction.
- Afterimages may occur when the image changes after the same image has been projected for some time. This is due to the nature of the LCD panels and does not indicate a problem. The afterimage will dissipate after a while during normal projection.

Precautions When Carrying / Shipping the Projector

Prepare the projector as described below before carrying it.



Caution

- **Disconnect the cables connected to the projector. Carrying the projector with the cables attached may cause an accident.**
- **Retract the adjustable feet before moving the projector. Leaving the feet extended may cause damage.**
- **Do not subject the projector to strong impacts or vibrations.**

Precautions for Installation

Be sure to read “Safety Instructions” and “For Safe Use” (P6 – P19). Also take the following precautions during installation.



Caution

- **Do not strike the projector or subject it to impact. Doing so may cause a malfunction.**
- **Do not install the projector standing on one side or in other unsteady positions. The projector may be damaged if it tips over.**

■ Do Not Use in the Following Environments



Caution

- **Locations with excessive humidity, dust, oily smoke or tobacco smoke**
Adhesion to the lens, mirrors or other optical parts may reduce image quality. In addition, oil can degrade the plastic, which could result in a ceiling-mounted projector falling from its mounting.
- **Near high-voltage power lines or sources of electrical power**
This may cause malfunction.
- **On soft surfaces such as carpets or cushioned mats**
This may cause a fire or damage the projector.
- **Locations with excessive temperature or humidity**
- **Locations subject to vibration or impact**
- **Near heat or smoke detectors**
- **Near the ocean, or near air conditioner vents**
- **Locations where corrosive gases occur, such as sulfur gas from hot springs**
This may damage the projector. Acceptable ranges for operating and storage temperature and humidity are as follows.
* Operating temperature and humidity applies to when the projector is projecting or in standby mode.

Operating temperature	Operating humidity	Storage temperature
0°C (32°F) – 45°C (113°F)	20% – 85%	-20°C (-4°F) – 60°C (140°F)

■ Do Not Touch the Lens with Bare Hands



Do not touch the lens with bare hands. Any smudges or fingerprints on the lens may affect image quality.

■ Allow a 30 Min. Warm Up before Focus Adjustment (P43), if Possible

Immediately after startup, the heat of the light source may prevent stable focus. When adjusting focus, it is also helpful to use the test pattern (10) (P92, P138).

■ Install at a Sufficient Distance from Walls and Other Obstructions



If the air intake or exhaust vent is blocked, heat will accumulate inside the projector, possibly resulting in a shortened projector lifetime or a malfunction. Similarly, do not install in narrow, enclosed spaces with poor ventilation. Install in a well-ventilated location. Ensure a minimum clearance of 50 cm (1.6') on both sides, and behind the projector. Also ensure a minimum clearance of 2 cm (0.8") below the projector.

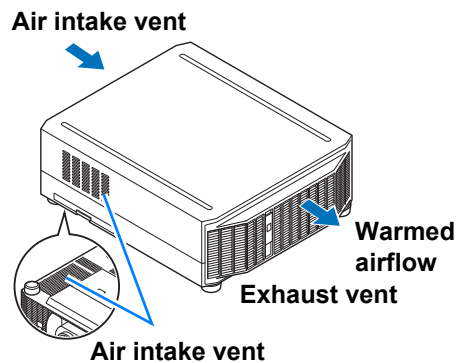

■ Be Careful of Condensation

If the temperature of the room rises suddenly, moisture in the air may condense on the projector lens and mirror, causing the image to become blurred. Wait until the condensation has evaporated for the image projected to return to normal.

■ At Altitudes above 2,300 m (7,545.8'), Adjust the Settings

Projector settings must be adjusted when using the projector at altitudes of 2,300 m (7,545.8') or higher. Specifically, refer to instructions for [High altitude] (P133) in the [Install settings] menu.

■ When Using Mounted on the Ceiling



When the projector is used mounted on the ceiling or installed in a high location, it is necessary to periodically clean the air intake and exhaust vents, and the area around the air filter. Dust that accumulates in intake or exhaust vents may impair ventilation, raising the temperature inside and posing a risk of damage or fire. Use a vacuum cleaner or similar means to remove dust from the intake vent and exhaust vent.

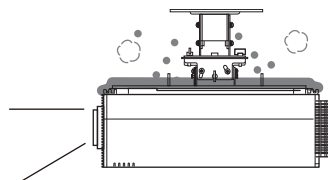

■ Install Facing in the Correct Direction



- Projection is possible upward, downward, or in a variety of directions, but do not block the air intake and exhaust vents. In particular, always ensure a minimum clearance of 2 cm (0.8") from the air intake vent on the bottom of the projector.
- There are no options for installing the projector other than the ceiling attachment.

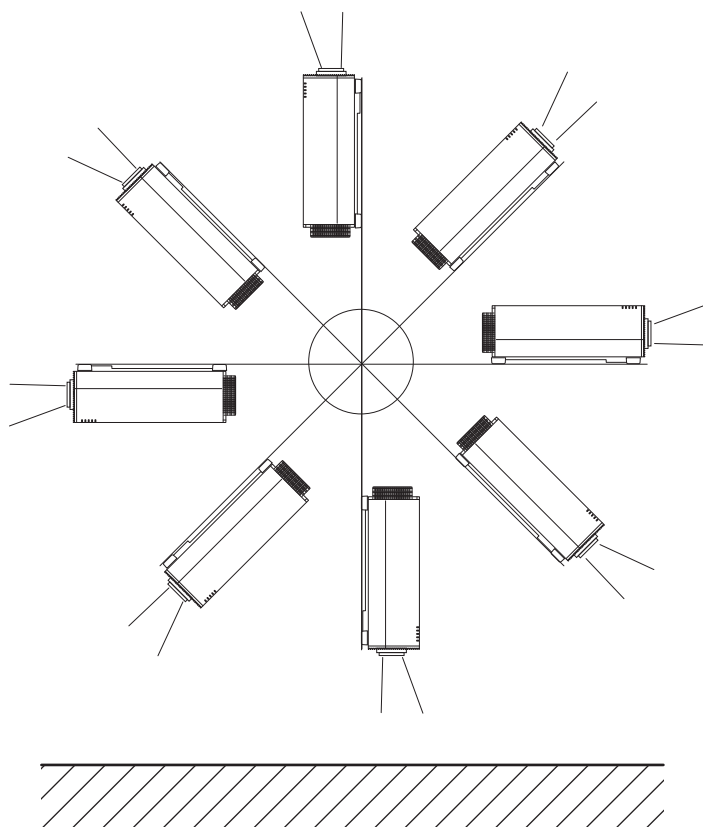

■ Precautions for Portrait (Upright) Installation

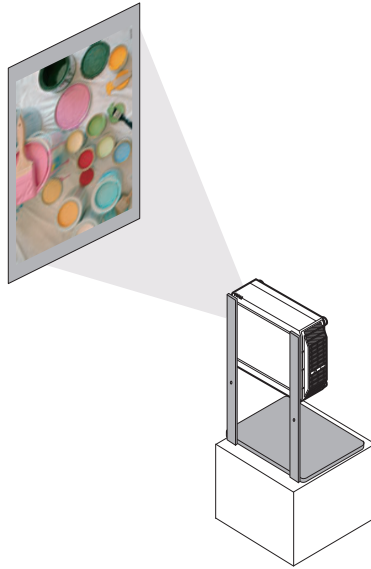

Caution

- Do not block the air intake or exhaust vents. In particular, because there is an air intake vent on the bottom, always ensure a minimum clearance of 2 cm (0.8") from the bottom.
- Note that no mounting brackets or similar accessories for portrait installation are available.

■ Light Source

The projector uses laser as a light source. The laser has the following characteristic.



Caution

Factors such as long-term use and environmental changes may affect image quality. You can counteract changes in brightness from hours of use or the ambient temperature by performing [Light source calibration] in [Calibration] (P156).

Copyright Notice

Please note that enlarging or reducing the size of an image for commercial purposes or public presentation may infringe on the legally protected copyright or the copyright holder of the original material.

Ensure Network Security

Take measures to ensure network security. Note that Canon is not liable in any way for direct or indirect loss from network security incidents, such as unauthorized access.

Before use, configure projector, computer, and network security settings appropriately.

- Set up the projector for connections only within your protected network, behind a firewall or the like, instead of direct Internet connections.
- When using the projector in a wireless network, also configure the Wi-Fi security settings.
- Change the Wi-Fi security key on a regular basis.

About Trademarks

- Ethernet is a registered trademark of Xerox Corporation.
- Microsoft and Windows are registered trademarks or trademarks of Microsoft Corporation in the United States and/or other countries.
- Mac, Mac OS and Macintosh are trademarks of Apple Inc., registered in the United States and/or other countries.
- HDMI, the HDMI logo and High-Definition Multimedia Interface are trademarks or registered trademarks of HDMI Licensing, LLC.
- PJLink is a registered trademark of JBMIA and pending trademark in some countries.
- PJLink is a registered trademark, or an application has been submitted for trademark, in Japan, the United States and/or other countries or regions.
- AMX is a registered trademark of Harman International Industries, Inc.
- Crestron®, Crestron RoomView®, and Crestron Connected™ are registered trademarks of Crestron Electronics, Inc.
- Extron and XTP are trademarks or registered trademarks of RGB Systems, Inc. in the United States and/or other countries.
- HDBaseT™ and the HDBaseT Alliance logo are trademarks of the HDBaseT Alliance.
- Wi-Fi is a registered trademark of the Wi-Fi Alliance.
- Wi-Fi CERTIFIED, WPA, WPA2, and the Wi-Fi CERTIFIED logo are used in reference to methods of configuration developed by the Wi-Fi Alliance.
- All other trademarks are the property of their respective owners.

Open Source Software

Part of this product includes software licensed under the GNU General Public License (GPL)

(1) Please access <<https://global.canon/en/oss/scd/index.html>> to fill the request form so that you receive an e-mail with the URL to download the source code; or

(2) Please send us a letter in writing with the following information, so that you receive the source code via postal mail.

In case you have chosen this (2), WE MAY CHARGE YOU no more than the cost of performing this distribution.

(i) Your Address (Country/Region, ZIP code, Address, Your name)
[mandatory]

(ii) Your e-mail address (for the purpose of possible communication with us)
[optional]

(iii) Product Name / Application Name [mandatory]

(iv) Version [mandatory]

Please check "Firmware" in the "Information" menu.

- Addressee:

Open Source Promotion Division, Canon Inc.

30-2, Shimomaruko 3-chome, Ohta-ku, Tokyo 146-8501, Japan

- Please see Privacy Notice at Canon Global <<https://global.canon/>>.

Included Accessories

Before use, make sure the following items are included in the package.

- Remote control

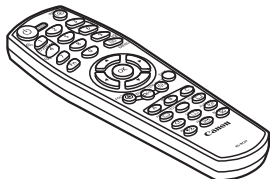

(part no.: RS-RC07)

- Batteries for the remote control (AAA size x2)

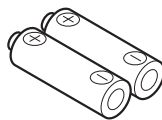

- Power cord (1.8 m / 5.9')

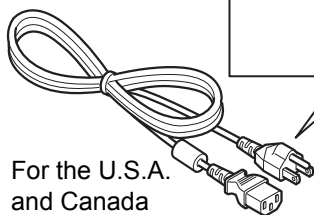

For the U.S.A. and Canada

For Continental Europe

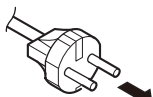

- Important Information



- Warranty Card

Projector Part Names and Functions

■ Front Side

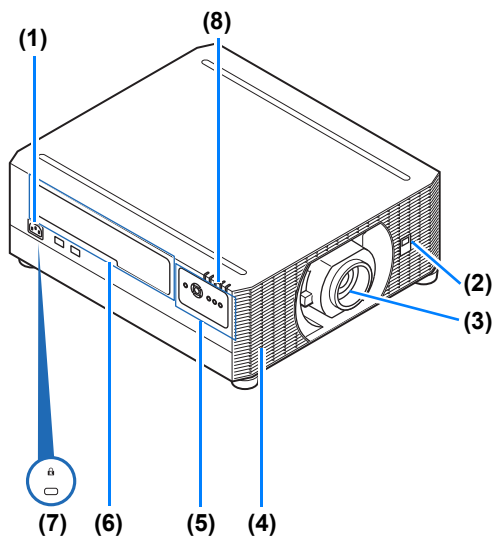

- (1) Power cord connector (P64)
- (2) Infrared remote receiver (P36)
- (3) Lens unit (sold separately)
- (4) Air intake vent



Caution

Do not block the air intake. Doing so may cause a malfunction.

- (5) Side control (P29)
- (6) Terminals and connectors (P32)
- (7) Anti-theft lock hole
An anti-theft wire cable (not included) can be connected.
- (8) LED indicators (P30)

■ Rear Side

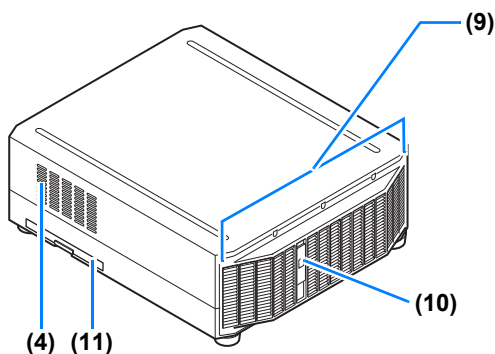

- (9) Exhaust vent



Caution

Do not block the air exhaust. Doing so may cause a malfunction.

- (10) Infrared remote receiver (P36)
- (11) Air filter frame (P191)

■ Bottom Side

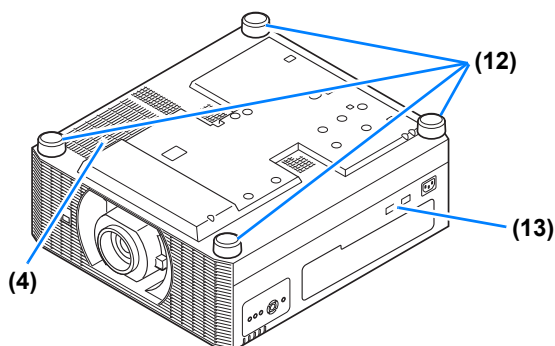

- (12) Adjustable feet (P60)
- (13) Security bar



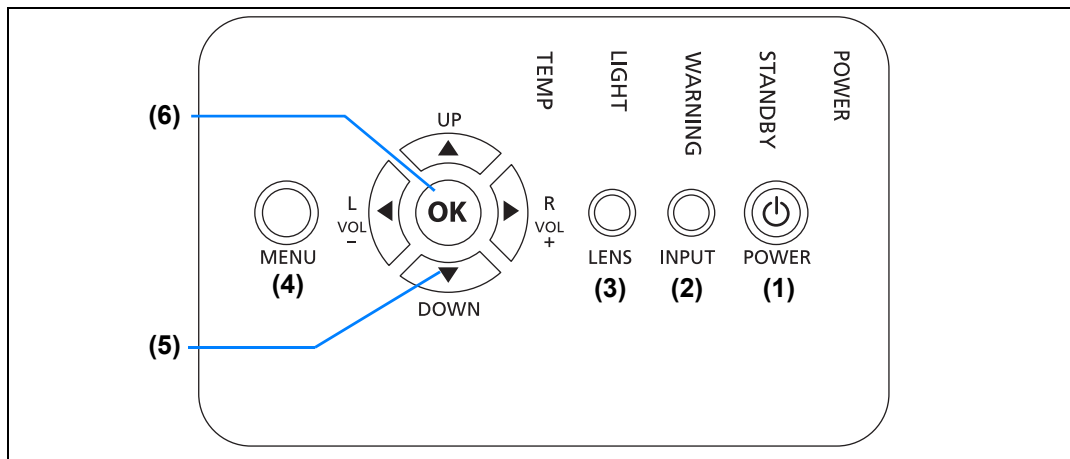

■ Side Control



- (1) **POWER button (P41, P46)**
Turns the projector on or off.
- (2) **INPUT button (P42)**
Switches the input signal.
- (3) **LENS button**
Each time the button is pressed, the screen changes to focus adjustment (P43), zoom (image size) adjustment (P43), or lens shift (image position) adjustment (P56). To adjust, use the [▲] / [▼] or the [◀] / [▶] buttons.
- (4) **MENU button (P104)**
Displays a menu on the screen.
- (5) **Pointer / VOL buttons (P102)**
Up, down, left, or right in menu navigation or other operations. Adjusts the sound volume.
[▲] **VOL+** button: Increases the volume.
[▼] **VOL-** button: Decreases the volume.
- (6) **OK button (P102)**
Determines the item selected from the menu.



■ LED Indicators























































The projector status is shown by the LED indicators (off / lit / flashing).

	POWER	<ul style="list-style-type: none">• POWER (green)	: Illuminated during projection. Otherwise, flashes in the following situations. <ul style="list-style-type: none">• As the projector transitions from standby to projection• While the light source is off in power management mode
	STANDBY		
	WARNING		
	LIGHT		
	TEMP	<ul style="list-style-type: none">• STANDBY (red)	: Illuminated during standby mode. Otherwise, flashes in the following situations. <ul style="list-style-type: none">• As the projector transitions from projection to standby• While the light source is off in power management mode
		<ul style="list-style-type: none">• WARNING (red)	: Lights up or flashes when an error occurs.
		<ul style="list-style-type: none">• LIGHT (orange)	: Lights up or flashes when a problem occurs with the light source.
		<ul style="list-style-type: none">• TEMP (red)	: Lights up or flashes when the internal temperature is high.

LED Indicator Displays

The LED indicators flash or illuminate to indicate the operating status of the projector.

Legend: Example of when the POWER indicator is on; : Off : Lit : Flashing

LED indicator					Operating status
POWER (green)	STANDBY (red)	WARNING (red)	LIGHT (orange)	TEMP (red)	
					Projector not plugged in.
					In standby mode.
					Power is on. (Projecting.)
					Resuming operation (projection) after standby.
					Cooling down while entering standby or power management mode from power on.
					In power management mode, with the light source off. (Flashes green and then red.)
					Internal temperature is high (in standby mode).
					Internal temperature is high (during projection).
					An error has occurred with the light source unit.
					A temperature error has occurred.
					Flashes 3 times: Air filter error Flashes 4 times: Fan error Flashes 5 times: Power error Flashes 6 times: Lens unit error

■ Terminals and Connectors

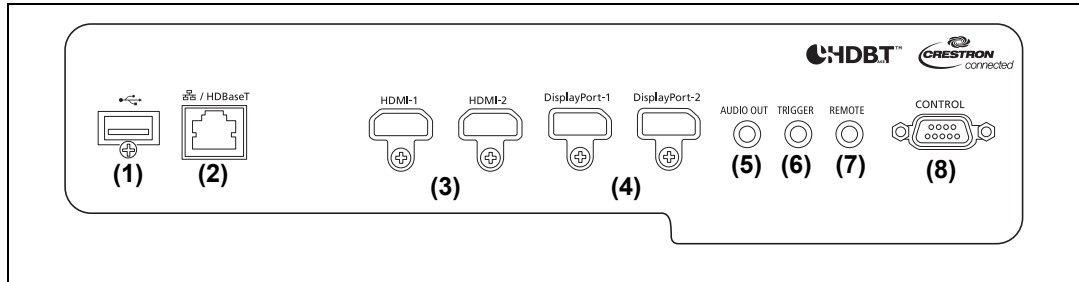

- (1) **USB port (P157)**
Connects a USB flash drive. Used for firmware updates.
- (2) **LAN / HDBaseT port (P63, P65)**
Receives HDBaseT input including digital video and audio signals.
Carries both video and audio signals across a single LAN cable (shielded twisted pair).
This port can also be used to connect the projector to a network.
- (3) **HDMI terminal (HDMI-1, HDMI-2) (P62)**
Receives HDMI input including digital video and audio signals.
Carries both video and audio signals across a single cable.
- (4) **DisplayPort port (DisplayPort-1, DisplayPort-2) (P62)**
Receives DisplayPort input including digital video and audio signals.
Carries both video and audio signals across a single cable.
- (5) **AUDIO OUT terminal (AUDIO OUT) (P64)**
Outputs the audio to external AV equipment. This outputs the audio signal that corresponds to the projected image signal.
- (6) **Trigger terminal (TRIGGER) (P156)**
Used to trigger operation of a screen or other external device when the projector is turned on or off.
- (7) **Terminal for wired remote control (REMOTE) (P37)**
This terminal is used to connect the optional remote control (RS-RC05) using a cable.
- (8) **Service port (P203)**
Used to control the projector with user commands (P203 – P204).

Remote Control

■ Part Names and Functions

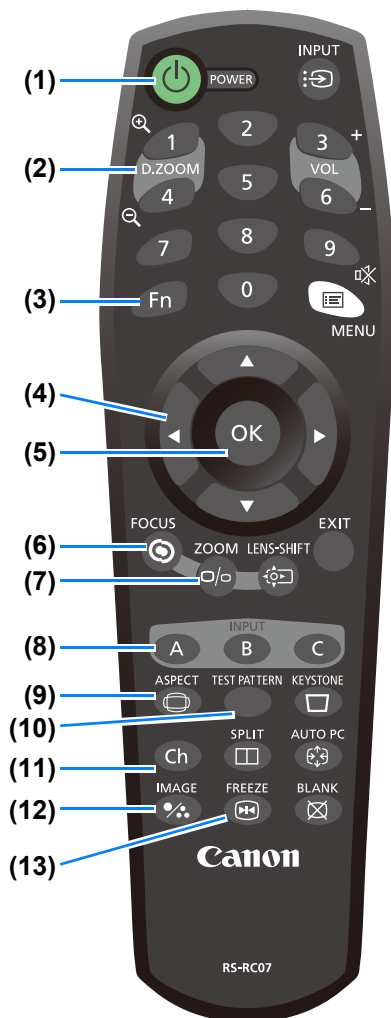

(1) POWER button (P41, P46)

Turns the projector on or off.

(2) D.ZOOM button

Not used with this product.

(3) Fn button

Not used with this product.

(4) Pointer buttons (P102)

Selects the upper, lower, left or right item in the menu. Also used to assign a channel to the remote control.

(5) OK button (P102)

Determines the item selected from the menu.

(6) FOCUS button (P43)

Adjusts focusing.

[▲] / [▶] buttons:

Moves the focus position further away.

[▼] / [◀] buttons:

Moves the focus position nearer.

(7) ZOOM button (P43)

Adjusts the image size.

[▲] / [▶] buttons:

Increase the image size.

[▼] / [◀] buttons:

Decrease the image size.

(8) INPUT A-C button (P145)

Can be assigned to input signal selection (one source for each of the three buttons).

(9) ASPECT button (P81, P113)

Changes the aspect ratio of the projected image.

(10) TEST PATTERN button (P138)

Displays the test pattern.

(11) Ch button (P145)

Changes the remote control channel.

(12) IMAGE button (P44)

Switches the image mode (image quality).

(13) FREEZE button (P47)

Freezes the projected image.

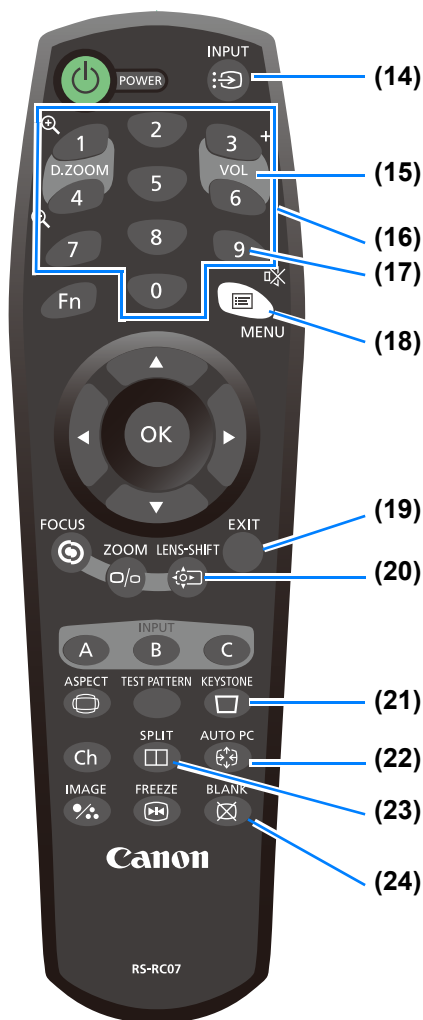

(19) EXIT button (P103)

Cancels functions such as menu display or test pattern during operation and returns to the image display.

(20) LENS-SHIFT button (P56)

Moves the lens up, down, left, or right.

[▲] / [▼] / [◀] / [▶] buttons:

Moves the image.

(21) KEYSTONE button (P81)

Corrects keystone distortion.

The [Keystone] setting enables both horizontal/vertical keystone correction (by adjusting top/bottom/left/right length) and corner correction.

(22) AUTO PC button

Not used with this product.

(23) SPLIT button

Not used with this product.

(24) BLANK button (P47)

Temporarily blacks out the image.

(14) INPUT button (P42)

Switches the input signal.

(15) VOL button (P49)

Adjusts the sound volume.

[3] button: Increases the volume.

[6] button: Decreases the volume.

(16) Number buttons (P150, P159, P161)

Enter password and TCP/IP setting values.

(17) MUTE button (P49)

Mutes the sound.

(18) MENU button (P104)

Displays a menu on the screen.

■ Installing Remote Control Batteries

- 1** **Open the battery compartment lid.**
Slide the lid while pressing it down.

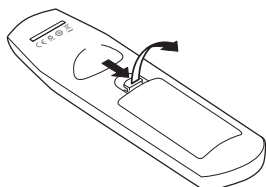

- 2** **Insert batteries.**
Insert 2 new AAA batteries in the compartment with the + and – terminals positioned correctly.

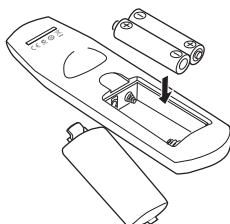

- 3** **Close the compartment lid.**
Slide the lid until you hear a click to securely close it.

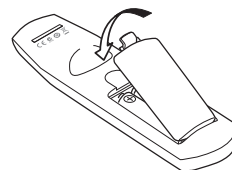

- If buttons on the remote control are inoperative when you attempt to operate the projector, replace the batteries with new ones.
- Do not drop the remote control or subject it to impact.
- Do not spill any liquids on the remote control. Doing so may cause a malfunction.



Warning



Prohibition



Caution

Pay attention to the following points when handling the batteries. Failing to do so could result in a fire or personal injury.

- Do not heat, short circuit or disassemble the batteries, or place them in a fire.
- Do not attempt to recharge the batteries that are included with the remote control.
- Remove the batteries when they are flat or when the remote control will not be used for a long period of time.
- When replacing the batteries, replace both at the same time. Also, do not use two batteries of a different type at the same time.
- Insert the batteries with the + and – terminals in the correct directions.
- If any liquid from inside the batteries leaks out and contacts your skin, be sure to wash the liquid off thoroughly.

■ Remote Control Operating Range

The remote control is an infrared type. Point it at the infrared remote receiver on the front or rear of the projector to operate it.

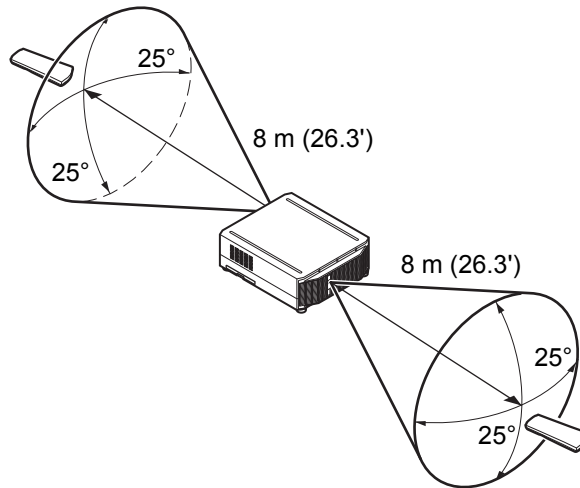

- Use the remote control no further than approximately 8 m (26.3') from the projector.
- Use the remote control within an angle of 25° in any direction from directly in front of the infrared remote receiver.
- The remote control may be inoperative if there is an obstacle between the remote control and the projector or the infrared remote receiver on the projector is exposed to direct sunlight or strong light of lighting equipment.
- When you use 2 or more projectors at the same time, change the channel settings to prevent the 2 remote controls from interfering with each other (P145).

■ Using an Optional Wired Remote (RS-RC05)

To use a wired remote control with the projector, use the RS-RC05, sold separately. Use a cable with a ø3.5 mm stereo mini jack (not included).

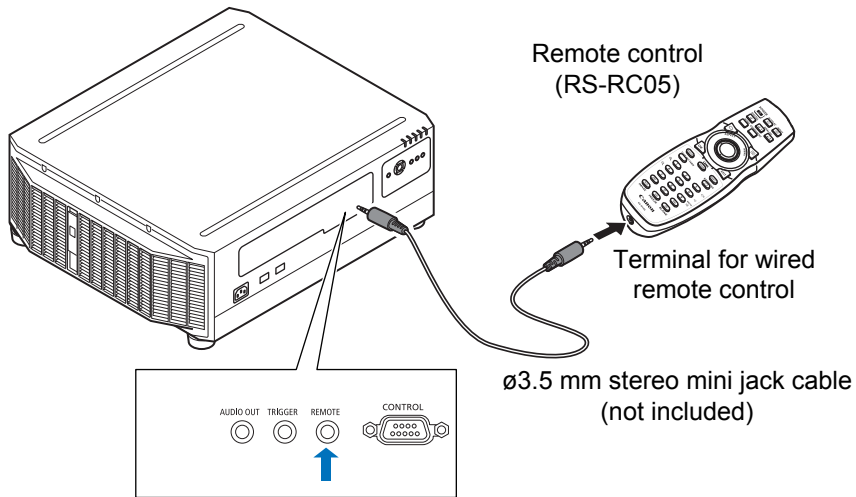

- Infrared operations cannot be performed if a cable is connected to the projector or the remote control.
- Use a cable with a ø3.5 mm stereo mini jack (not included) with a length of 30 m (98.4') or less.

Basic Guide

Projection Procedure

The steps to prepare for projection are as follows.

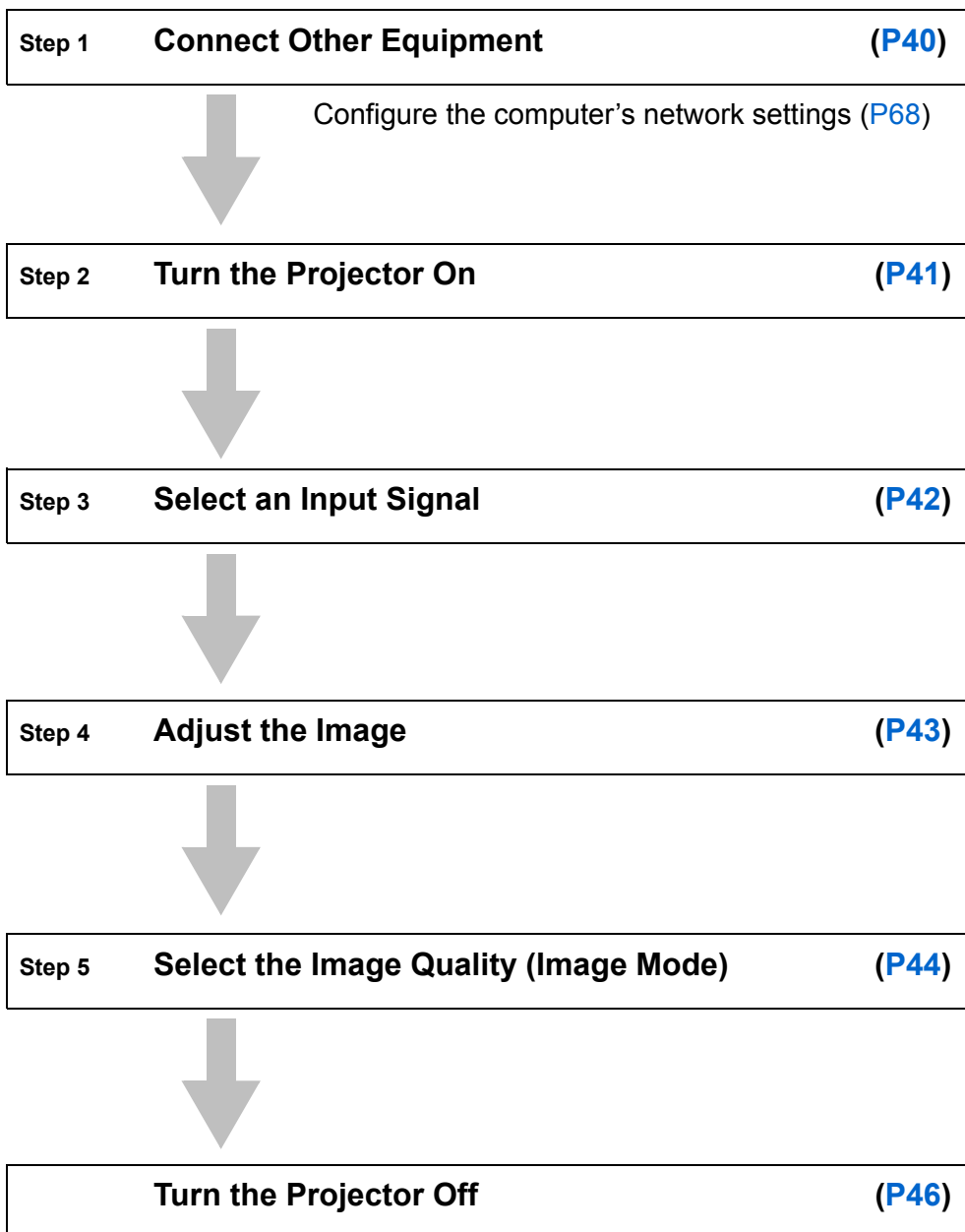

Step 1 Connect Other Equipment

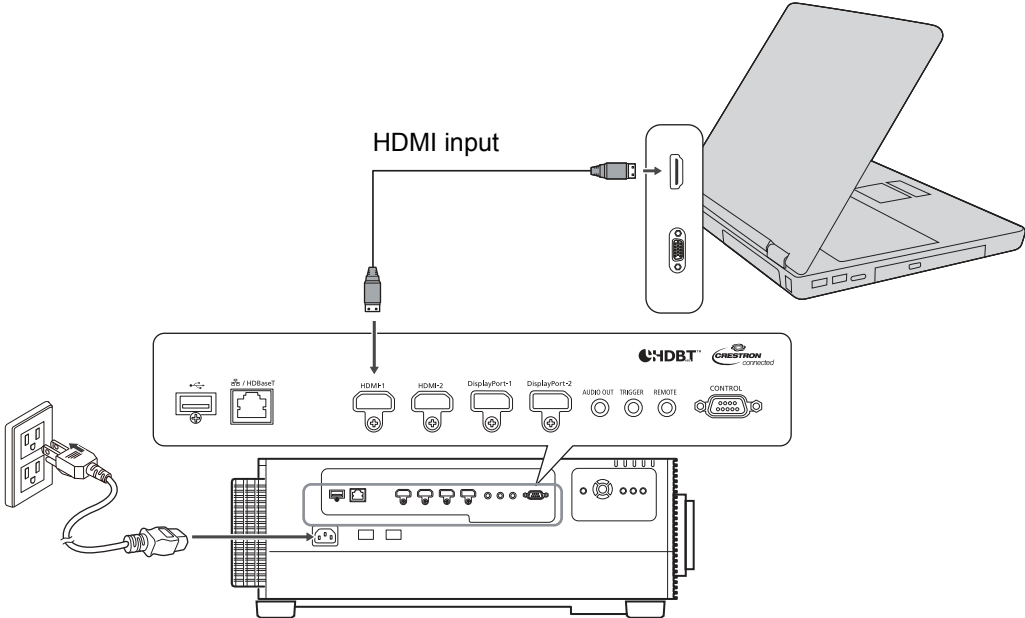

Step 2 Turn the Projector On

1 Press the **POWER** button.

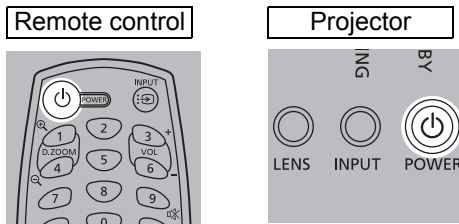

2 Turn on the computer or other equipment.



- If a window is projected for menu language selection, use the pointer buttons to choose a language, and then press the **OK** button.
- If you have set a password, the password input screen appears. Enter your password ([P150](#), [P151](#)).
- When “No signal” appears, press the **INPUT** button to select the input signal.
- If a computer screen is not projected, adjust the display settings on the computer. For details about how to switch display output, refer to the manual for your computer.

Step 3 Select an Input Signal

To switch between signals from connected devices, select an input signal in the [Input] menu.

The selected signal changes each time you press the **INPUT** button, or each time you press the [▲] / [▼] buttons when the [Input] window is shown.

The currently active input signal is marked with a green circle and enclosed by a orange border.

Names of input signals available for projection are displayed in white, and unavailable signal names are grayed out.

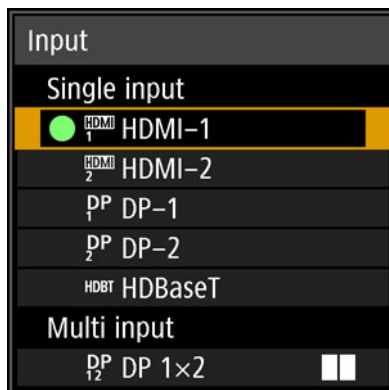
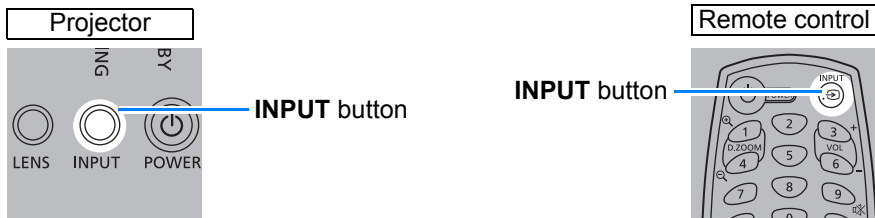

- Input signals can also be selected by using the **INPUT A-C** buttons on the remote control, depending on settings. For details, see “[INPUT A-C] button settings” (P145).
- Using the projector’s multi-input feature, you can supply a single image via two cables. As sources of input for projection at 4K or other resolutions, choose [DP 1x2].
- Signals you supply for Multi Input mode must meet certain conditions.

Step 4 Adjust the Image

■ Adjusting the Computer's Output Resolution

The projector's maximum resolution is 4096x2160 (P193).

For details on adjusting your computer's output resolution, refer to the manual for your computer.

■ Focusing / Resizing the Image

Press the **ZOOM** button on the remote control to adjust the image size, and press the **FOCUS** button to adjust the focus. You can also press the **LENS** button on the projector once to adjust focus and twice to adjust image size.

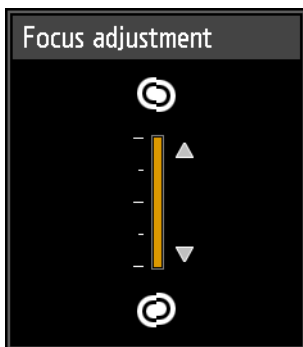
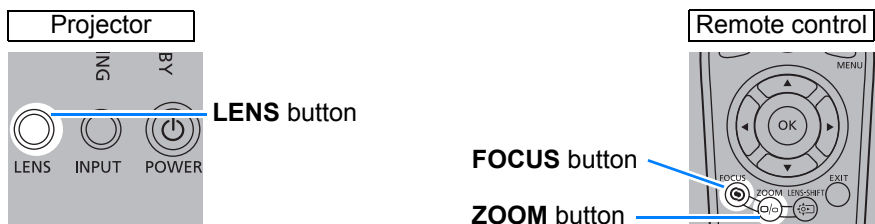

Focus adjustment

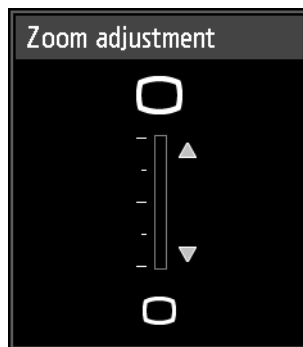
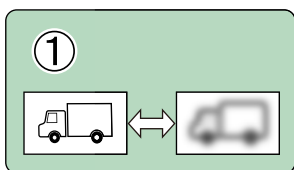

Zoom adjustment

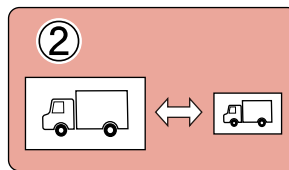

- Correct any keystone distortion by pressing the **KEYSTONE** button (P81).
- Select an image mode depending on the projected image.

Step 5 Select the Image Quality (Image Mode)

Pressing the **IMAGE** button on the remote control, you can select an image mode to suit the projected image.

In each image mode, you can further adjust the brightness, contrast, sharpness, gamma, HDR range, color adjustment, advanced adjustment, light source mode (P125) and brightness level (P125).

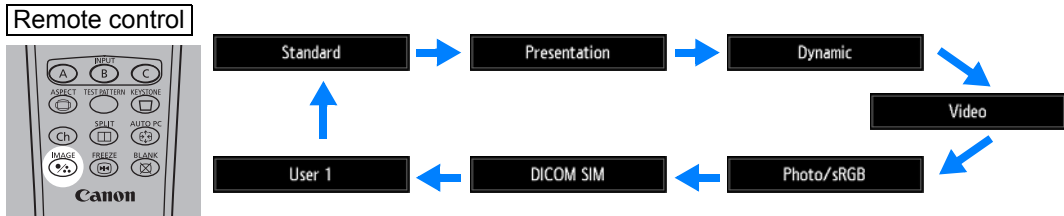

■ Image Modes

Image mode	Details
Standard	(1) Bright (2) Computer screens, or media played with video software (3) Whites and natural colors
Presentation	(1) Bright (2) Images mainly consisting of text (3) Keeps the screen bright
Dynamic	(1) Bright (2) Media played with video software (3) Keeps the screen bright
Video	(1) Somewhat dark (2) Video from camcorders (3) Close to the color space of TVs
Photo/sRGB	(1) Somewhat dark (2) Digital photos from sRGB-compatible cameras (3) Conforms to the sRGB standard
DICOM SIM	(1) Somewhat dark (2) Monochrome images (medical use, for example) (3) Adjusted to the GSDF curve specified in DICOM Standard Part 14
User 1 – 5	Up to 5 user-selected combinations of image quality settings can be stored in the memory (P118). Stored settings can be selected as an image mode.

■ Projecting an Image in the DICOM SIM Mode

In the DICOM simulation mode (hereinafter referred to as “DICOM SIM”), this projector can project a monochrome medical image such as an X ray radiography, CT image, MRI image, etc. in the tone similar to the DICOM (Digital Imaging and Communications in Medicine) standard. Typically, to project the image according to the DICOM standard, it requires the grayscale tone correction using a luminance meter according to the environment. In this projector, there are 21 types of tone settings for various ambient lights. You can correct the tone in a simplified manner by selecting the DICOM test pattern (P92).

It is suited to project an image in a medical lecture, academic conference, in-hospital conference, etc.

This projector is not the display monitor for a medical image. It cannot be used for the radiological image reading or medical examination.



- It is recommended to check the tone everytime when using this projector since it does not have the tone correction and calibration functions against the secular change.
- It may take approximately 30 minutes until the projection brightness of this projector becomes stabled.

Switching the mode to the DICOM SIM Mode

- 1 Press the **IMAGE** button on the remote control until **[DICOM SIM]** is displayed or select **[DICOM SIM]** from **[Image mode]** in the **[Image adjustment]** menu.

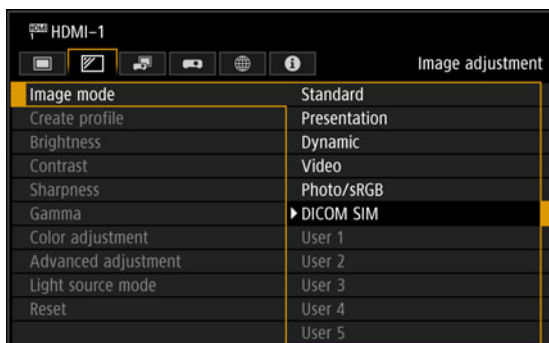

- 2 Display test patterns by pressing the **TEST PATTERN** button on the remote control or selecting **[On]** in **[Test pattern]** of the **[Install settings]** menu. Press the **[▲]** / **[▼]** buttons to select the DICOM test pattern.

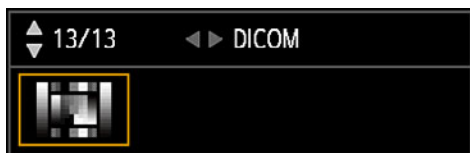

Projection Procedure

- 3 As you view the test pattern, perform [Gamma] (P119) adjustment from the [Image adjustment] menu until the image is optimal.
- 4 Press the OK button after the setting.



Perform one of the followings to obtain an appropriate projection:

- Darken the ambient light
- Reduce the image size
- Reduce the projection distance

Turn the Projector Off

- 1 Press the POWER button.

Remote control



Projector

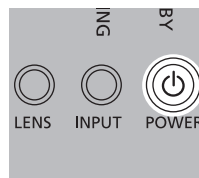

- 2 When this window is displayed, press the POWER button again. After you turn the projector off, projection stops, the [STANDBY] indicator flashes in red, and the projector starts cooling down. After cooling down, the projector enters standby mode. In standby mode, the [STANDBY] indicator remains lit instead of flashing.

! Power off

Push POWER button again to turn off power.



- If you want to continue projecting without turning off the power, press a button other than **POWER**, or else wait until the confirmation message disappears.
- The projector cannot be turned on while cooling down.
- Using the projector for extended periods may shorten the life of the internal optical components.
- Unplug the projector if it will not be used for an extended period. Note that the [Date and time] setting will be reset, so you will need to set it again.
- In power management mode, the projector may go off automatically after some time (P148).

Convenient Features

This section describes convenient features during presentations and in other situations.

Temporarily Blacking Out an Image

Projection can be temporarily blanked after a presentation, or to divert the audience's attention away from the screen.

Remote control



Press the **BLANK** button on the remote control to black out the image.

Press the **BLANK** button again to show the image.

- You can set the screen state while blanking out the image in the menu (P140).

Freezing the Picture

Projection can be temporarily frozen during computer operations that would be distracting, or to pause playback of video or animation.

Remote control



Press the **FREEZE** button on the remote control to freeze the moving image. The following icon appears.

Press the **FREEZE** button again to return to the original display.

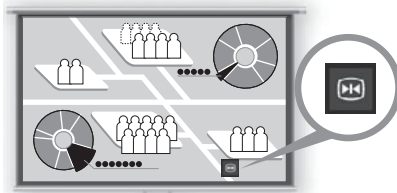

Screen

- It is also cancelled when the input signal is terminated.

Projecting a Test Pattern from the Menu

Even without any input signals, the projector can project a test pattern. Test patterns can be projected during installation to check how the projector is installed. For details on projecting test patterns, see “Test pattern” (P138) or “Adjustment Using a Test Pattern” (P92).

Specifying Power-Saving Settings

Set power-saving settings as needed.

The following four settings are available. For details, refer to the page describing each function.

- **Light source mode (P125)**
Conserve energy by selecting a mode that is less bright.
- **Standby power settings (P147)**
Conserves energy in standby mode by disabling some network functions.
- **Power management mode (P148)**
Automatically turns off the light source or the power after a certain period if the projector is idle without an input signal.
- **Power management duration (P148)**
Specify the period after which the light source or projector should go off automatically if left idle without an input signal when [Power management mode] is set to [Light source off] or [Standby].

Adjusting the Volume

Useful when:

- You want to adjust the volume level of external speakers connected via the audio output terminal.

Remote control



Press the **VOL** button. The following screen appears.



- You can also adjust the volume level with the [◀] / [▶] buttons of the projector.
- Adjust the volume or mute setting on the computer if the volume level is too low.

Muting the Sound

Useful when:

- You want to temporarily mute unnecessary sound.
- You want to immediately mute the sound.

Remote control

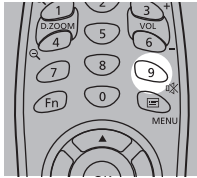

Press the **MUTE** button on the remote control to mute the sound. The following icon appears.

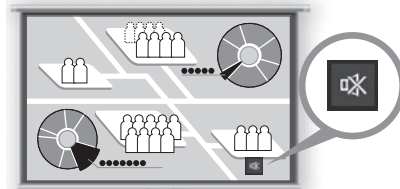

Screen

Press the **MUTE** button again to cancel the mute function.

- You can also mute the sound of the speakers connected via the audio output terminal.

Installation Guide

Before setting up the projector, be sure to read “Before Installation” ([P21](#)).

Installation Procedure

Relationship Between Projecting Distance and Image Size

The projected image size is determined by the distance between the projector and screen (projection distance) and the zoom position. Refer to the following table and decide the distance between the projector and screen.

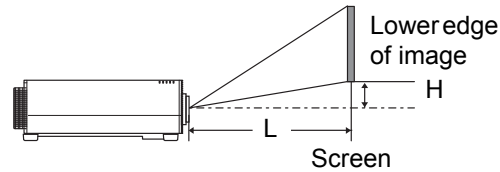
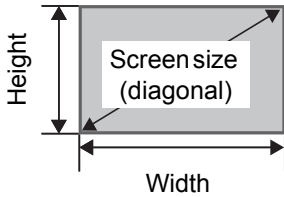

L: Projection distance

H: Height from center of lens to lower edge of image

Lens unit		RS-SL01ST	RS-SL02LZ	RS-SL04UL	RS-SL05WZ	Height H** [cm]					
Projection ratio*		1.38 – 2.07:1	2.03 – 3.46:1	3.29 – 6.43:1	0.93 – 1.39:1	RS-SL01ST RS-SL02LZ RS-SL04UL RS-SL05WZ					
Diagonal	Image size [cm]		Projection distance L [m (feet)]								
	Width	Height	Wide limit	Tele limit	Wide limit		Tele limit	Wide limit	Tele limit	Wide limit	Tele limit
40	90	47	1.23 (4.04)	1.85 (6.07)	1.80 (5.91)	3.08 (10.10)	—	—	0.83 (2.72)	1.23 (4.04)	-34 – 5
60	135	71	1.85 (6.07)	2.79 (9.15)	2.72 (8.92)	4.65 (15.26)	4.48 (14.70)	8.71 (28.58)	1.25 (4.10)	1.86 (6.10)	-51 – 7
80	180	95	2.47 (8.10)	3.72 (12.20)	3.64 (11.94)	6.21 (20.37)	5.94 (19.49)	11.57 (37.96)	1.66 (5.45)	2.49 (8.17)	-68 – 9
100	225	118	3.10 (10.17)	4.65 (15.26)	4.56 (14.96)	7.77 (25.49)	7.39 (24.25)	14.44 (47.38)	2.08 (6.82)	3.12 (10.24)	-85 – 12
150	337	178	4.65 (15.26)	6.99 (22.93)	6.86 (22.51)	11.68 (38.32)	11.02 (36.15)	21.59 (70.83)	3.12 (10.24)	4.69 (15.39)	-128 – 18
200	449	237	6.21 (20.37)	9.32 (30.58)	9.16 (30.05)	15.59 (51.15)	14.65 (48.06)	28.75 (94.32)	4.16 (13.65)	6.27 (20.57)	-171 – 24
250	562	296	7.76 (25.46)	11.65 (38.22)	11.46 (37.60)	19.49 (63.94)	18.28 (59.97)	35.90 (117.78)	5.20 (17.06)	7.84 (25.72)	-213 – 30
300	674	355	9.32 (30.58)	13.99 (45.90)	13.76 (45.14)	23.40 (76.77)	21.91 (71.88)	43.05 (141.24)	6.24 (20.47)	9.41 (30.87)	-256 – 36
350	786	415	10.88 (35.70)	16.32 (53.54)	16.06 (52.69)	27.31 (89.60)	25.54 (83.79)	50.21 (164.73)	7.28 (23.88)	10.99 (36.06)	-299 – 41
400	899	474	12.43 (40.78)	18.65 (61.19)	18.36 (60.24)	31.21 (102.40)	29.17 (95.70)	57.36 (188.19)	8.32 (27.30)	12.56 (41.21)	-341 – 47
450	1011	533	13.99 (45.90)	20.99 (68.86)	20.66 (67.78)	35.12 (115.22)	32.80 (107.61)	64.52 (211.68)	9.36 (30.71)	14.13 (46.36)	-384 – 53
500	1123	592	15.54 (50.98)	23.32 (76.51)	22.96 (75.33)	39.03 (128.05)	36.43 (119.52)	71.67 (235.14)	10.40 (34.12)	15.71 (51.54)	-427 – 59
550	1236	652	17.10 (56.10)	25.65 (84.15)	25.26 (82.87)	42.94 (140.88)	40.06 (131.43)	78.83 (258.63)	11.44 (37.53)	17.28 (56.69)	-469 – 65
600	1348	711	18.65 (61.19)	27.99 (91.83)	27.56 (90.42)	46.84 (153.67)	43.69 (143.34)	85.98 (282.09)	12.48 (40.94)	18.85 (61.84)	-512 – 71

Installation Procedure

Lens unit			RS-SL03WF	RS-SL06UW	RS-SL07RST		Height H** [cm]		
Projection ratio*			0.74:1	0.5:1	1.34 – 2.35:1		RS-SL03WF	RS-SL06UW	RS-SL07RST
Diagonal	Image size [cm]		Projection distance L [m (feet)]						
	Width	Height	Fixed	Fixed	Wide limit	Tele limit			
40	90	47	0.67 (2.20)	0.45 (1.48)	1.20 (3.94)	2.11 (6.92)	-27 – -20	-34 – 16	-58 – 11
60	135	71	1.00 (3.28)	0.67 (2.20)	1.80 (5.91)	3.17 (10.4)	-41 – -31	-51 – 23	-87 – 16
80	180	95	1.34 (4.40)	0.90 (2.95)	2.40 (7.87)	4.23 (13.88)	-54 – -41	-68 – 31	-117 – 22
100	225	118	1.67 (5.48)	1.12 (3.67)	3.00 (9.84)	5.29 (17.36)	-68 – -51	-85 – 39	-146 – 27
150	337	178	2.50 (8.20)	1.69 (5.54)	4.50 (14.76)	7.93 (26.02)	-101 – -76	-128 – 59	-219 – 41
200	449	237	3.33 (10.93)	2.25 (7.38)	6.01 (19.72)	10.57 (34.68)	-135 – -102	-171 – 78	-291 – 55
250	562	296	4.16 (13.65)	2.81 (9.22)	7.51 (24.64)	13.21 (43.34)	-169 – -127	-213 – 98	-364 – 68
300	674	355	4.99 (16.37)	3.38 (11.09)	9.01 (29.56)	15.86 (52.03)	-203 – -153	-256 – 117	-437 – 82
350	786	415	—	—	10.51 (34.48)	18.50 (60.70)	—	—	-510 – 95
400	899	474	—	—	12.01 (39.4)	21.14 (69.36)	—	—	-583 – 109
450	1011	533	—	—	13.51 (44.32)	23.78 (78.02)	—	—	-656 – 123
500	1123	592	—	—	15.01 (49.25)	26.43 (86.71)	—	—	-729 – 136
550	1236	652	—	—	16.52 (54.20)	29.07 (95.37)	—	—	-802 – 150
600	1348	711	—	—	18.02 (59.12)	31.71 (104.04)	—	—	-874 – 164

* Projection ratios are based on projection to 100-inch screens.

** Height (H) is based on [Normal] lens shift mode.

For details on the image position in [Expanded] mode, see “Adjustment Using Lens Shift” (P58).

Installing / Removing the Lens Unit



- Before installing or removing the lens unit, be sure to disconnect the power plug or connector. Failure to do so may result in fire, electric shock, or injury.
- When hanging the projector from a ceiling, put the projector down on the floor or a workbench before attaching or replacing the lens unit. Failure to do so could result in parts falling off the projector and may cause a malfunction or personal injury.



- The projector is provided with a lens shift function to move the lens up, down, left, and right using the motor. Do not touch the lens while it is moving. Touching the lens when it is moving may result in personal injury.
- Before replacing the lens unit, wait at least 30 minutes after the projector is turned off to allow the lens unit to cool down. Failure to do so may result in burns or injury.



- When installing and removing the lens unit, be sure not to touch the surface of the lens with your hands or scratch it.
- Do not apply force to parts (e.g. lead wires) that are connected to the lens unit or lens motor. Doing so may cause a malfunction.
- Do not replace the lens unit in a dusty location. If any dust or dirt enters the projector, this may adversely affect picture quality.
- When carrying or holding up the projector after attaching the lens unit, be sure not to hold the lens. Doing so may cause damage to the lens unit or projector.
- If transportation is necessary, the lens unit should be removed before transporting the projector. If the projector is subjected to excessive impacts during transportation, the lens unit or projector may be damaged.
- For details about which devices the projector is compatible with, contact the Canon Customer Support Center.

■ Installing the Lens Unit

- 1** After confirming that the lens lever is raised, hold the lens unit with the lens connector on the left side and insert it in the projector, keeping the lens connector aligned with the connector in the projector.

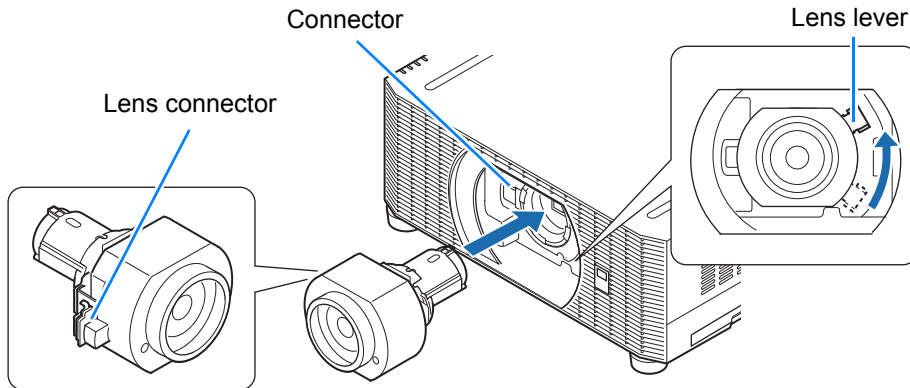

Keep the lens unit level as you insert it straight into the projector. Inserting it crooked may prevent the lens lever from moving freely or make projection blurry.

- 2** Turn the lens lever clockwise to secure the lens unit.

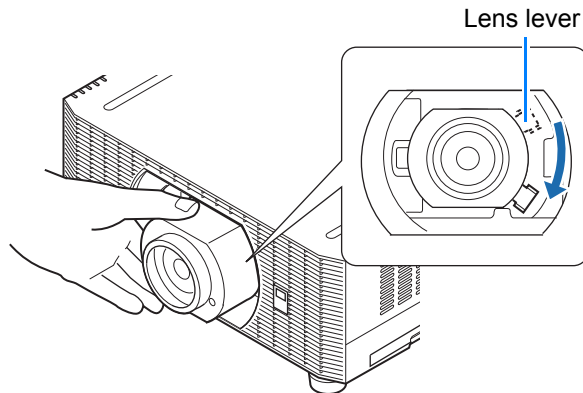

- When securing the lens unit, make sure it is fully inserted in the projector, and then turn the lens lever clockwise (toward the bottom, as shown) to secure it. If it is not fully inserted, this may prevent the lens lever from moving freely or make projection blurry.
- The projector stores certain information about lenses. This information must be set again when lenses are replaced.
After lens replacement, lens shift reset is performed automatically when the projector is restarted, and the lens moves within the range of [Normal] lens shift mode (P58).
- Also refer to instructions included with the replacement lens.

Removing the Lens Unit

- 1** Raise the lens lever by turning it counterclockwise.

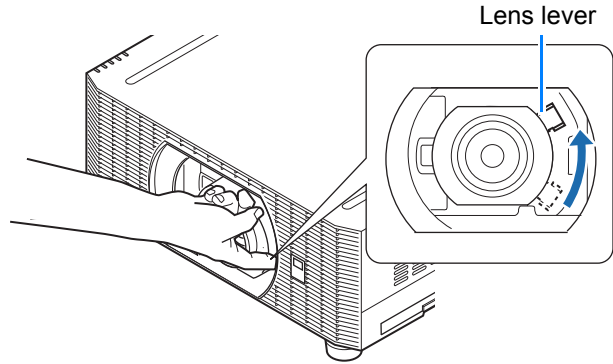

- 2** Hold the lens unit securely as you remove it.



When removing the lens unit, keep it level as you pull it straight out of the projector.

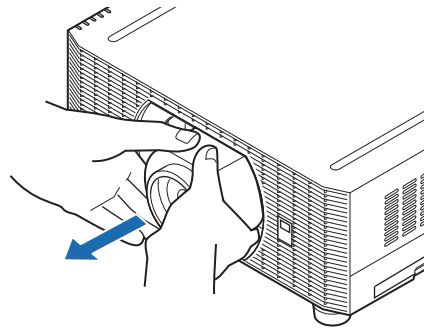

Installation

Place the projector in front of the screen.



- To avoid keystone distortion, install the projector so that it is at right angles to the screen.
- The screen must not be exposed to direct sunlight or light from lighting equipment. In a bright room, it is recommended that lights be turned off, curtains be drawn, and other steps taken to make the screen easier to see.

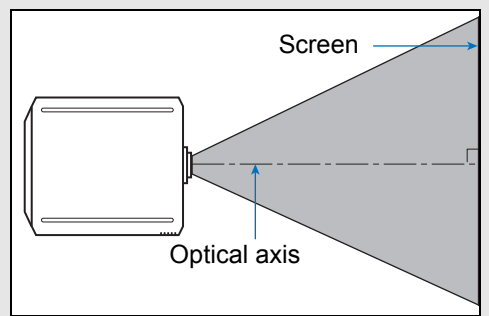

■ Tabletop or Floor Installation (Lower Than the Screen)

To adjust the projection position, use the lens shift function or the adjustable feet.

- 1 Press the LENS-SHIFT button on the remote control to display the lens shift adjustment window.**

Remote control

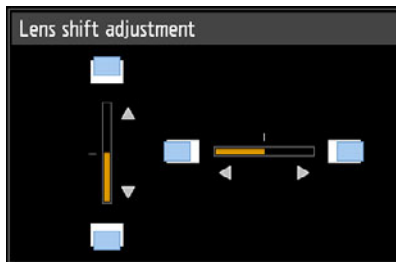
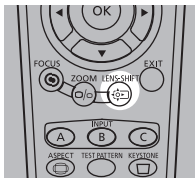

Installation Procedure

Press the **LENS** button on the projector repeatedly to switch between windows for parameters adjusted by controlling the lens.

To access the lens shift adjustment window, press the **LENS** button three times (or four times if you have set [Marginal focus] to [On]).

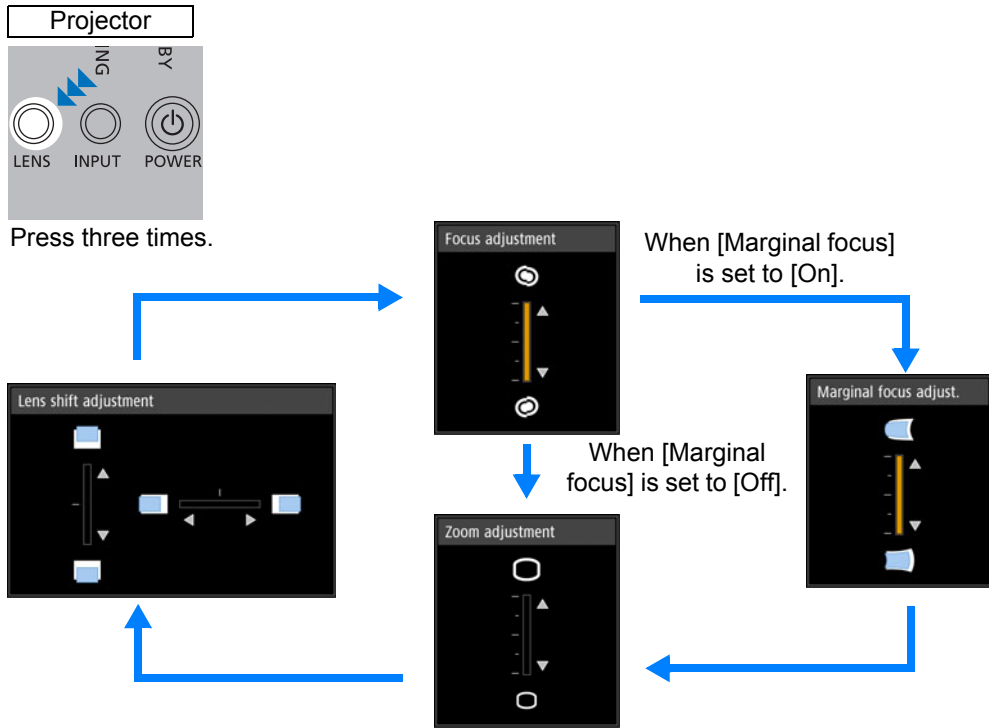

2 Press the pointer buttons to adjust.

To raise or lower the image, use the [▲] / [▼] buttons on the remote control or projector.

To move the image left or right, use the [◀] / [▶] buttons on the remote control or projector.

To continue moving the image in a specific direction, hold down the corresponding button.

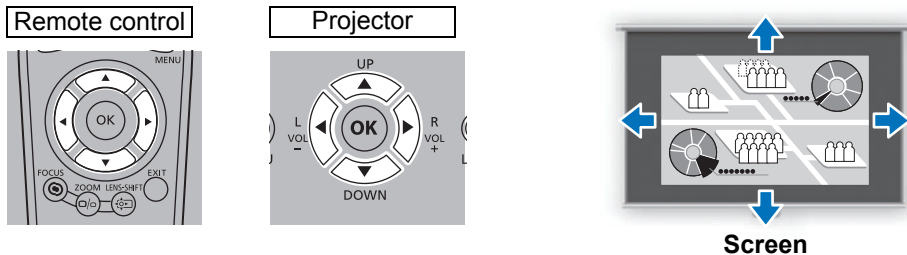

Adjustment Using Lens Shift

You can reposition the image in all directions by shifting the lens up, down, left, or right. This feature is referred to as lens shift. The projector's lens shift range is as follows.

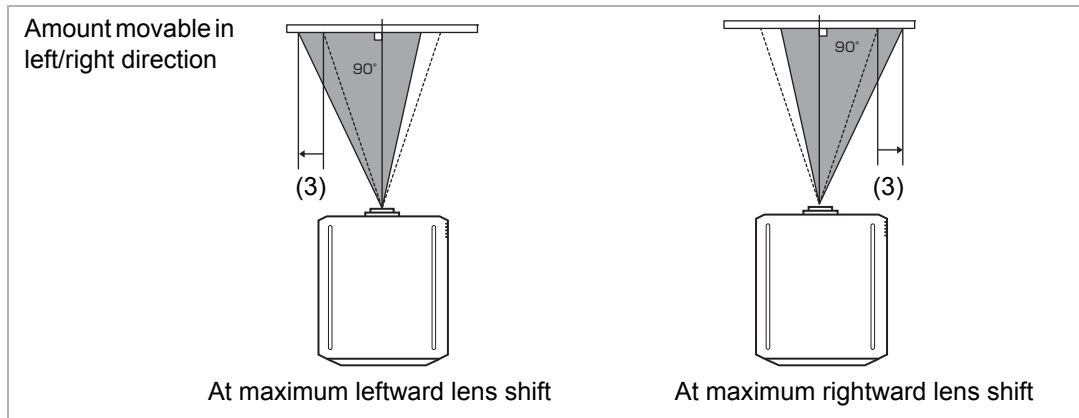
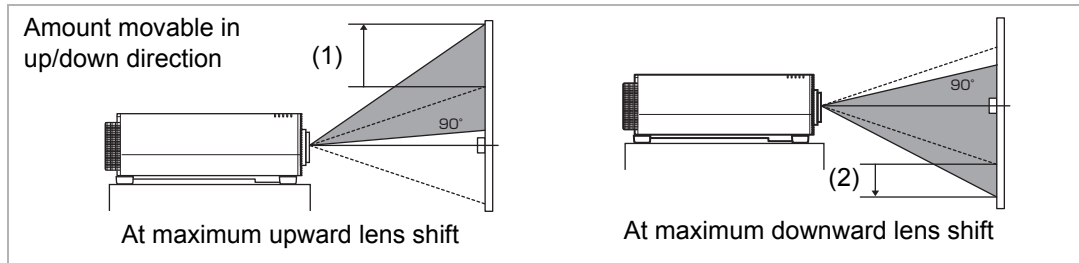

Amount of Lens Shift for Each Replacement Lens

Lens unit	Lens shift mode: Normal	Lens shift mode: Expanded*
RS-SL01ST	Up (1) : +60% Down (2) : -22% Left/right (3) : ±6%	Up (1) : +104% Down (2) : -104% Left/right (3) : ±25%
RS-SL02LZ		
RS-SL04UL		
RS-SL05WZ		
RS-SL03WF	Up (1) : +7% Down (2) : -7% Left/right (3) : ±2%	
RS-SL06UW	Up (1) : +83% Down (2) : -22% Left/right (3) : ±25%	
RS-SL07RST	Up (1) : +73% Down (2) : -73% Left/right (3) : ±11%	

* Image quality may decrease in [Expanded] lens shift mode, depending on the extent of lens shift.



Before using this feature, connect the projector to a computer or AV equipment (P62) and plug the projector in (P64).

Area Outside the Lens Shift Range (in [Normal] Lens Shift Mode*)

- Zoom Lenses: RS-SL01ST/RS-SL02LZ/RS-SL04UL/RS-SL05WZ

When the shift exceeds 49% (*1) in the upward direction, the amount of available shift in the left/right directions decreases. When the lens is shifted upward to the maximum of 60% (*2) (1), the lens cannot be shifted left or right.

For an ultra-wide zoom lens (RS-SL06UW), (*1) is 32% and (*2) is 83%.

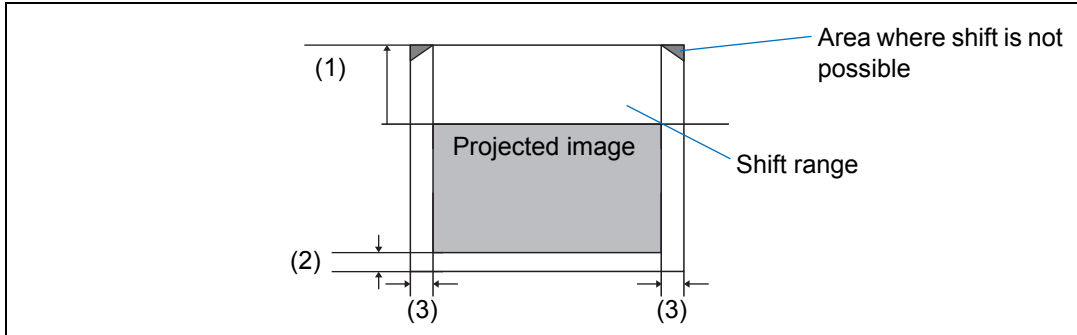

- Short Fixed Lens: RS-SL03WF

The more you shift the lens up or down, the less you can shift it left or right. When the lens is shifted upward or downward to the maximum of 7%, the lens cannot be shifted left or right.

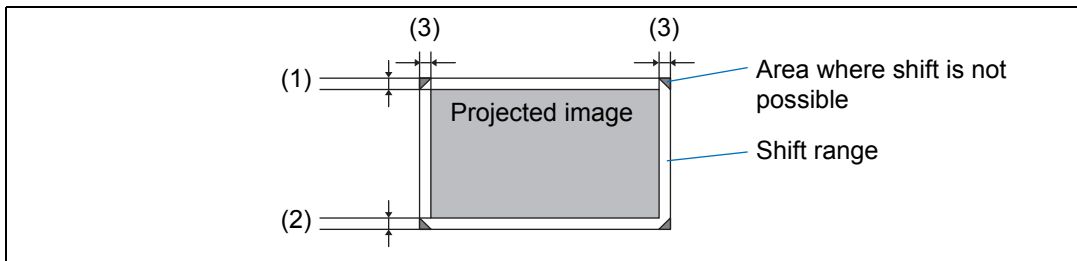

- Standard 4K Zoom Lens: RS-SL07RST

When the shift exceeds 55%/-55% in the upward or downward direction, the amount of available shift in the left/right directions decreases. When the lens is shifted upward or downward to the maximum of 73%/-73% (1), the lens cannot be shifted left or right.

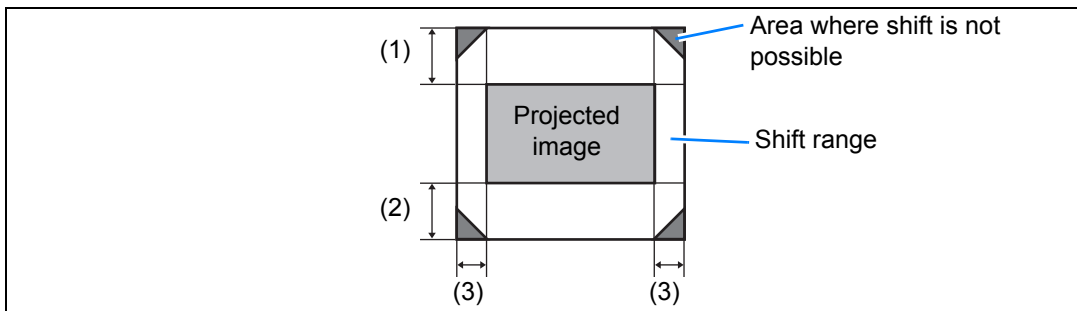

In [Expanded] lens shift mode, the lens can be shifted to each corner position, however image quality may decrease.

Resetting the Position

During screen position adjustment, press and hold the **LENS-SHIFT** button on the remote control or the **LENS** button on the projector to display the [Lens shift reset] window. The selections for the lens currently used are displayed. Use the pointer buttons to select one of them, then press the **OK** button.

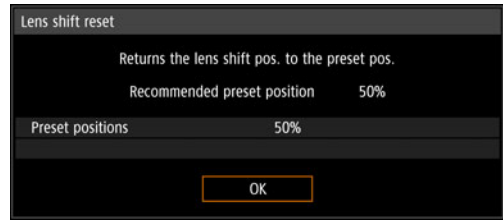

Lens unit type	Available items
RS-SL01ST	50% : Up 50%, left/right 0% 0% : Up/down/left/right 0%
RS-SL02LZ	
RS-SL04UL	
RS-SL05WZ	
RS-SL06UW	
RS-SL07RST	
RS-SL03WF	0% : Up/down/left/right 0%



- After resetting, the lens may be slightly misaligned from your selected position.
- For precise positioning, use the lens shift function to fine-tune the position.

Adjustment Using the Adjustable Feet

Adjustment in a range of $\pm 1.8^\circ$ is possible using the adjustable feet.

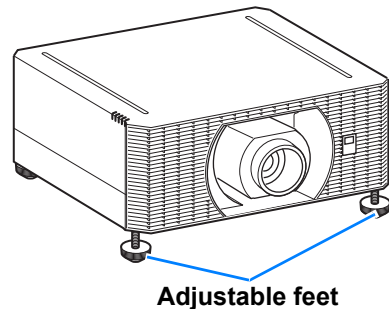

High Installation, Ceiling Mounting, and Rear Projection

Projector features enable projection from a shelf or other high surface. You can also mount the projector on the ceiling (ceiling mounting) with it turned upside down or place it behind the screen (rear projection) if you use a translucent screen. In [Image flip H/V] (P128) in the menu, choose a method of projection that corresponds to how the projector is installed.

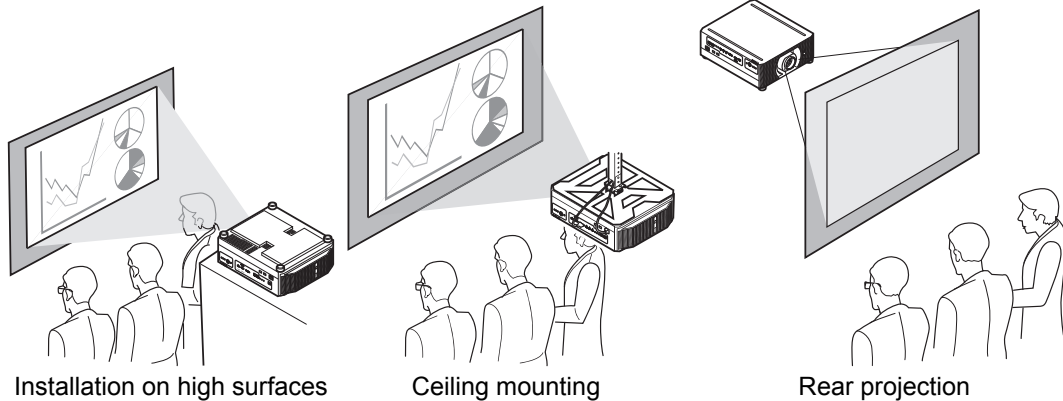

- 1 Press the **MENU** button on the remote control or projector, and then select [Install settings] > [Image flip H/V].
- 2 Select the orientation of how the projector is installed.

Option	Function
None	Select for normal projection, without inversion.
Ceiling mounted	Select when the projector is installed upside-down on the ceiling. The projected image is inverted in both vertical and horizontal directions.
Rear	Select this to project an image from behind the screen. The projected image is inverted in the horizontal direction.
Rear, Ceiling mounted	Select this to project an image from behind the screen with the projector hung from the ceiling. The projected image is inverted in the vertical direction.



When setting the projector on a high surface for projection, be sure the surface is flat and stable. Failure to do so poses a risk of the projector falling and causing accidents or injury.

Ceiling mounting requires an optional ceiling attachment (part no.: RS-CL15) and ceiling-mount arm (part no.: RS-CL17). Depending on the installation environment, an extension pipe (part no.: RS-CL08 or RS-CL09) may also be required. Contact the Canon Customer Support Center for more detailed information.



Caution

- Make sure to use the optional ceiling attachment.
- You should never install the ceiling attachment by yourself.

Connection Procedure

Connecting Other Equipment



Caution

Before connecting the projector to other equipment, turn off both the projector and the other equipment.

■ HDMI Connections

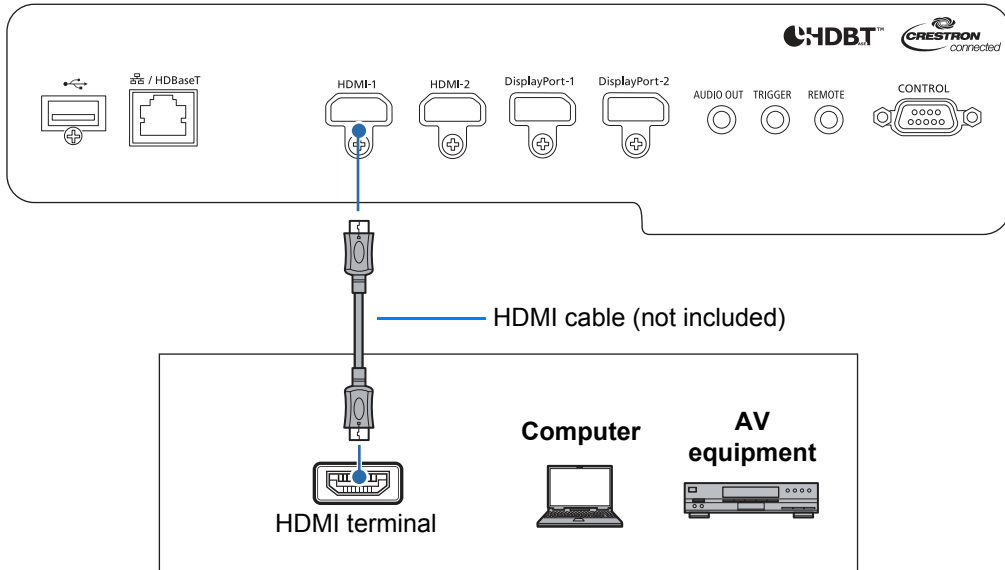

■ DisplayPort Connections

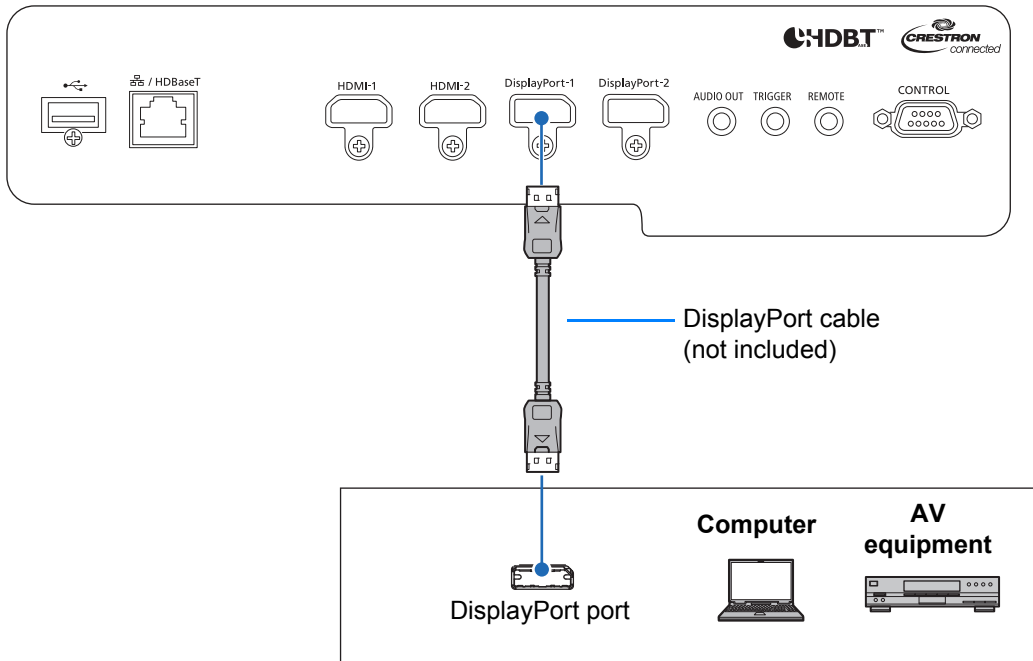

LAN / HDBaseT Connections

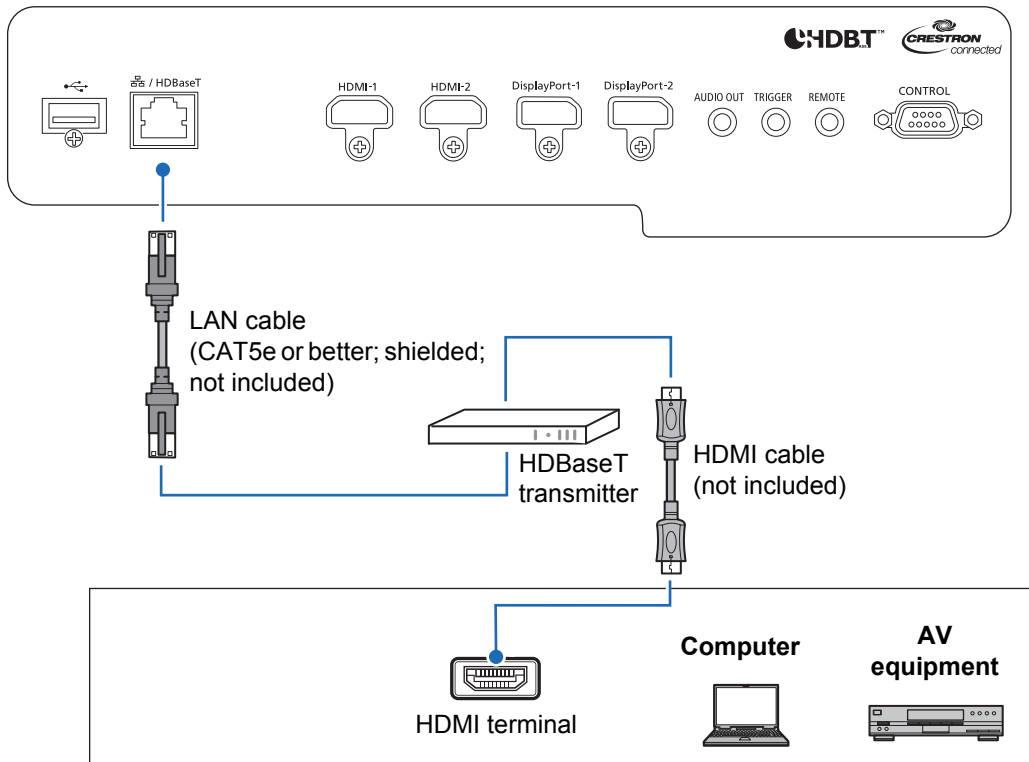

Notes on HDBaseT

- Use a shielded cable rated at CAT5e or better.
- Maximum transmission distance is 70 m (229.7') (maximum distance for 2K signals: 100 m (328.1')).
- However, maximum transmission distance may be shorter in some environments.
- Do not use the LAN cable when it is coiled or bundled.
- Inserting or removing the LAN cable during projection may cause noise.
- Connectivity with all HDBaseT transmitters on the market is not guaranteed.
- Some HDBaseT transmitters may not enable correct projection when used to connect source equipment to the projector.

■ Audio Output Connections

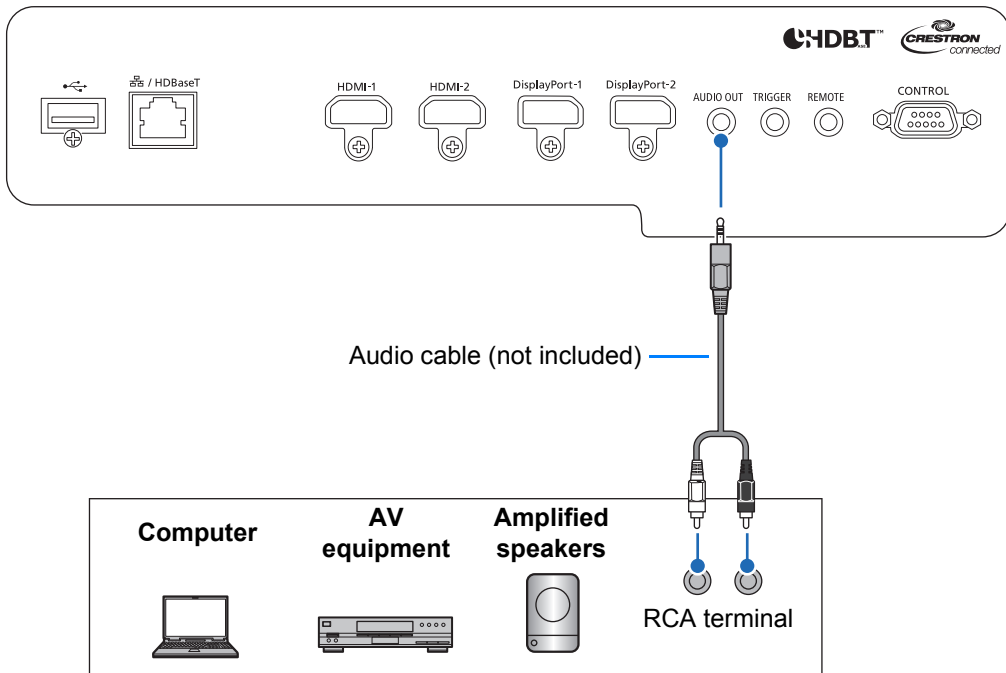

■ Plugging the Projector In

Connect the power cord to the projector and plug it in.

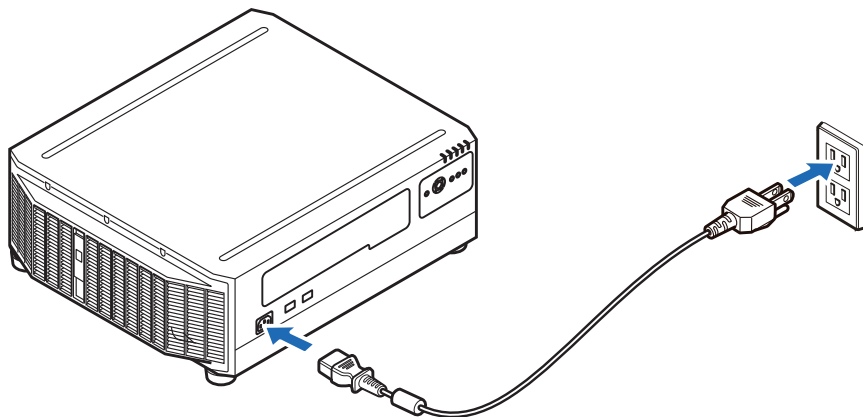

Warning

Insert the power plug and connector securely up to the base.



- Unplug the power cord if the projector will not be used for a long period of time.
- [Date and time settings] may be reset if the power cord is left unplugged for a long period of time (P151).

Connecting to a Network

■ Network Connection Overview

Connecting the projector to a network enables you to control the projector from a computer and receive notification of projector errors via email.

Depending on the method of network connection, preparation on the computer side may be necessary.

■ Connection Methods

The projector can be connected to a wired network with a LAN cable or to a wireless network via Wi-Fi.

Wired Networks

Use a LAN cable to connect the projector and computer to the network. Connect the LAN cable to the projector's LAN / HDBaseT port to enable communication.

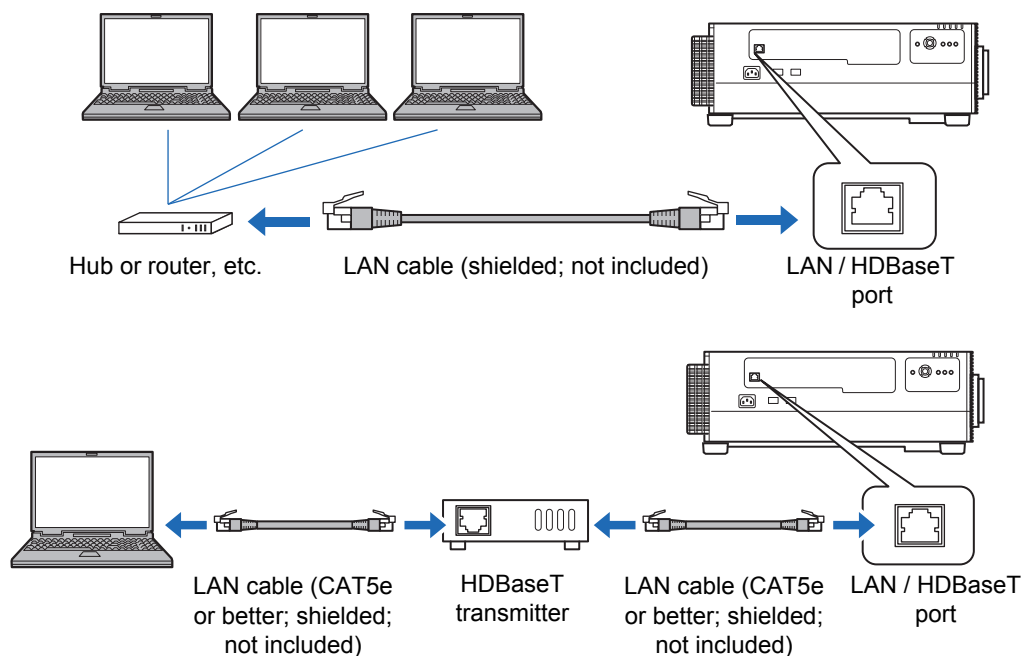

Wireless Networks

• Projector Access Point (PJ AP) Mode

The projector can be used as an access point for direct communication with wireless LAN-compatible computers.

Up to five computers can be connected at once.

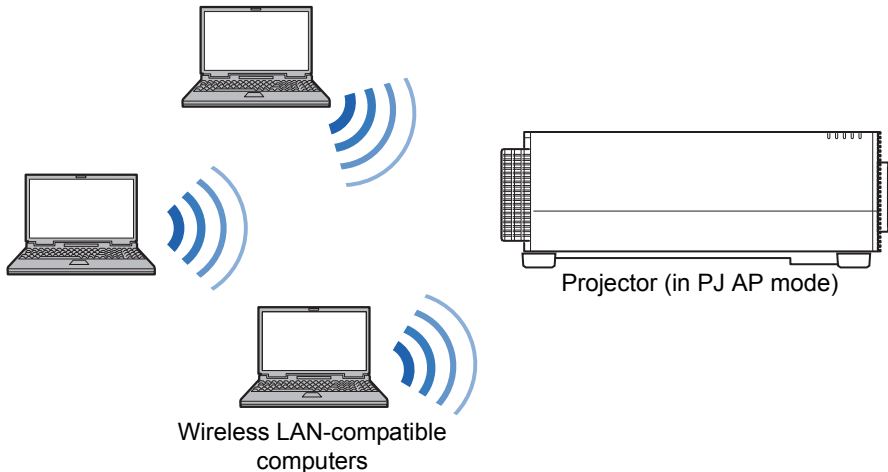

The following network features are available in PJ AP mode.

- Web features
- User commands
- SNMP features

Other network features (PJLink, Mail, AMX Device Discovery and Crestron RoomView) are not available.

• Infrastructure Mode

The projector can also be used as a wireless LAN client for connections to a wireless LAN access point.

In this case, the projector is connected to computers via the wireless LAN access point.

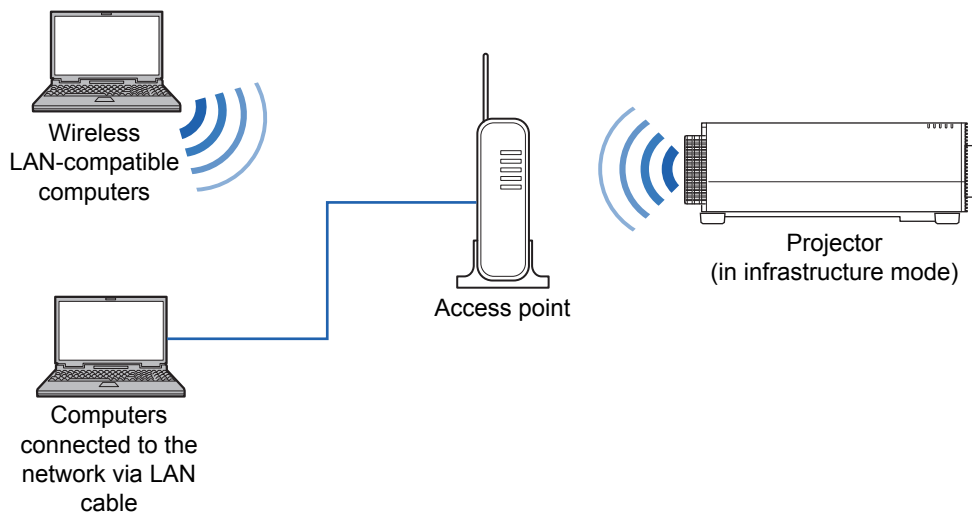

Network connection

- The following network features are available in infrastructure mode.
 - Web features
 - Mail features
 - User commands
 - SNMP features

Other network features (PJLink, AMX Device Discovery and Crestron RoomView) are not available.

- The following restrictions apply in infrastructure mode.
 - Access point SSIDs not in ASCII code (single-byte letters, numbers, or symbols) may cause character corruption in search result display.
 - Connectivity cannot be assured if access point SSIDs include characters not in ASCII code (single-byte letters, numbers, or symbols).

When multiple access points have the same SSID, only search results for the access point with the strongest signal are shown.

- Remember to set your preferred network (wired or wireless) to [On] if [Network (wired/wireless)] on the projector is set to [Off/Off] and the network connection is disabled (P160). For wireless networks, choose the type of connection.
- The LAN / HDBaseT port provides a maximum transfer rate of 100 Mbps.
- Referring to “Checking Projector Information” (P173), confirm that the projector’s IP address is not the same as that of other computers on the network. To set a projector IP address, follow the instructions in “Basic Wired Network Settings [Wired]” (P180) or “Basic Wireless Network Settings [Wireless]” (P182) and use the web screen, or use the projector’s “Detailed settings (wired)” (P161) or “Detailed settings (wireless)” (P165).
- In a network environment where a DHCP server is operating, select [On] in [DHCP] on the projector to enable the DHCP function and connect it (P161, P167).



- Wired LAN features and infrastructure mode cannot be used at the same time.
- PJ AP and infrastructure modes cannot be used at the same time.
- Wired LAN and PJ AP mode cannot be used in the same subnetwork.
- When you connect the computer to the network for the first time, it is also necessary to perform settings on the computer. In this case, consult the network administrator regarding the necessary settings.

■ Configuring the Computer's Network Settings

Instructions for setting a computer's IP address (for wired connections or wireless connections) are as follows for each operating system.

Windows 10

- 1** Click the **Start button (Windows logo)** in the lower left of the screen.
- 2** From **[Windows system tools]** on the Start menu that is displayed, click **[Control Panel]**.
 - On some versions of Windows 10, you must first click **[All Apps]** in order to display **[Windows system tools]**.
- 3** Click **[View network status and tasks]**.
 - In icon view:
Click **[Network and Sharing Center]**.
- 4** Click **[Change adapter settings]**.
- 5** For a wired connection, right-click **[Ethernet]**, or for a wireless connection, right-click **[Wi-Fi]**. Next, click **[Properties]**.
- 6** In the **[This connection uses the following items]** list, select **[Internet Protocol Version 4 (TCP/IPv4)]** and click the **[Properties]** button. Make a note of the original network settings (IP address, subnet mask, default gateway, etc).
- 7** Select **[Use the following IP address]** and set the IP address and subnet mask.

The projector's own default IP address is "192.168.254.254" for wired connections and "192.168.253.254" for wireless connections. Specify a different IP address.
- 8** When the settings are completed, click the **[OK]** button, and then click the **[Close]** button in the **[Ethernet Properties]** window to close it.

Windows 8.1

- 1** Click the down arrow in the lower left of the start screen.
- 2** Click **[Control Panel]**.
 - From the desktop screen:
Press Win+X.
In the shortcut menu displayed in the lower left, click **[Control Panel]**.
- 3** Click **[View network status and tasks]**.
 - In icon view:
Click **[Network and Sharing Center]**.
- 4** Click **[Change adapter settings]**.
- 5** For a wired connection, right-click **[Ethernet]**, or for a wireless connection, right-click **[Wi-Fi]**. Next, click **[Properties]**.
- 6** Select **[Internet Protocol Version 4 (TCP/IPv4)]** and click the **[Properties]** button. Make a note of the original network settings (IP address, subnet mask, default gateway, etc).
- 7** Select **[Use the following IP address]** and set the IP address and subnet mask.

The projector's own default IP address is "192.168.254.254" for wired connections and "192.168.253.254" for wireless connections. Specify a different IP address.
- 8** When the settings are completed, click the **[OK]** button, and then click the **[Close]** button in the **[Local Area Connection Properties]** window to close it.

Windows 7

- 1** From the PC [Start] menu, select [Control Panel].
- 2** Click [Network and Internet], and then click [View network status and tasks].
- 3** From the menu on the left side of the window, click [Change adapter settings].
- 4** For a wired connection, right-click [Local Area Connection], or for a wireless connection, right-click [Wireless Network Connection]. Next, click [Properties].
- 5** Select [Internet Protocol Version 4 (TCP/IPv4)] and click the [Properties] button. Make a note of the original network settings (IP address, subnet mask, default gateway, etc).
- 6** Select [Use the following IP address] and set the IP address and subnet mask.
The projector's own default IP address is "192.168.254.254" for wired connections and "192.168.253.254" for wireless connections. Specify a different IP address.
- 7** When the settings are completed, click the [OK] button, and then click the [Close] button in the [Local Area Connection Properties] window to close it.

Mac OS X

- 1** Open the Apple Menu and select [System Preferences].
- 2** In the System Preferences window, click [Network] to display the Network window.
- 3** For a wired connection, select [Built-in Ethernet], or for a wireless connection, select [Wi-Fi]. Next, select [Detail].
- 4** Click the [TCP/IP] tab. Make a note of the original network settings (IP address, subnet mask, router, DNS server, and so on).
- 5** Create a new network environment and set the IP address and subnet mask.
The projector's own default IP address is "192.168.254.254" for wired connections and "192.168.253.254" for wireless connections. Specify a different IP address.
- 6** Click [OK], then select [Apply] to close the network preference window.

Resetting the IP Address Setting of the Computer

Follow the same procedure as for changing the IP address and reset the values to the original values based on the notes taken before the change.

■ Setting Up the Network

Displaying the Network Configuration Screen

1 Turn on the computer and projector.



Network functions are not available until about 40 seconds after the projector is plugged in.

2 Launch a web browser, enter “http://(projector IP address)” in the address bar, and press the Enter key.

The projector web screen appears.

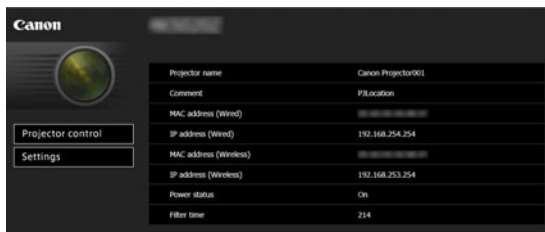

The following information is displayed.

Projector control	Displays the projector control screen.
Settings	Shows the settings screen.
Projector name	The name of the projector on the network
Comment	Relevant notes, such as where the projector is installed
MAC address (Wired)	MAC address of the wired LAN
IP address (Wired)	IP address of the wired LAN (IPv4)
MAC address (Wireless)	MAC address of the wireless LAN
IP address (Wireless)	IP address of the wireless LAN (IPv4)
PowerStatus	The power status of the projector
Filter time	Air filter operating time
Alert	Error message (if an error has occurred) Temperature abnormality Light source abnormality Faulty air filter unit Faulty cooling fan Faulty power supply Faulty lens



The factory default IP address is “192.168.254.254” for wired connections (IPv4) and “192.168.253.254” for wireless connections (IPv4). If DHCP settings are used, ask the network administrator for the projector IP address. It is possible to check the IP address from the projector menu (P161).

Connection Procedure

3 Click [Settings] on the web screen.

The password input window appears.

4 Enter the user name and password on the password input window, then click [OK].

The factory default user name is “root” and the password is “system”.

The settings screen is displayed. Complete the network settings on this screen.

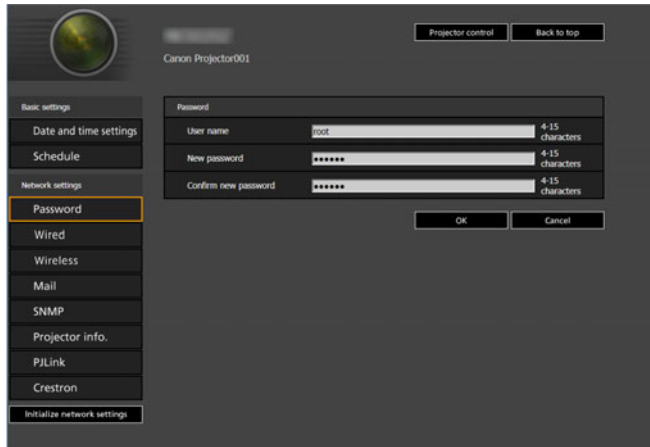

The screenshot shows the web interface for a Canon projector. At the top, there is a "Projector control" button and a "Back to top" button. Below them, the text "Canon Projector001" is displayed. On the left side, there is a navigation menu with the following items: "Basic settings", "Date and time settings", "Schedule", "Network settings", "Password" (highlighted with a yellow border), "Wired", "Wireless", "Mail", "SNMP", "Projector info.", "PiLink", "Crestron", and "Initialize network settings". The main content area is titled "Password" and contains three input fields: "User name" with the value "root" and a character count of "4-15 characters", "New password" with masked characters "*****" and a character count of "4-15 characters", and "Confirm new password" with masked characters "*****" and a character count of "4-15 characters". At the bottom of the form are "OK" and "Cancel" buttons.

For details on the projector’s web screen, see “Projector Web Screen Menu” (P174).



To control the projector from the computer, click [Projector control] (P79).

Network Setting

- 1 Select a function to set up from the settings screen menu.



- 2 Enter setting details in the fields shown (1), and then click [OK] (2).

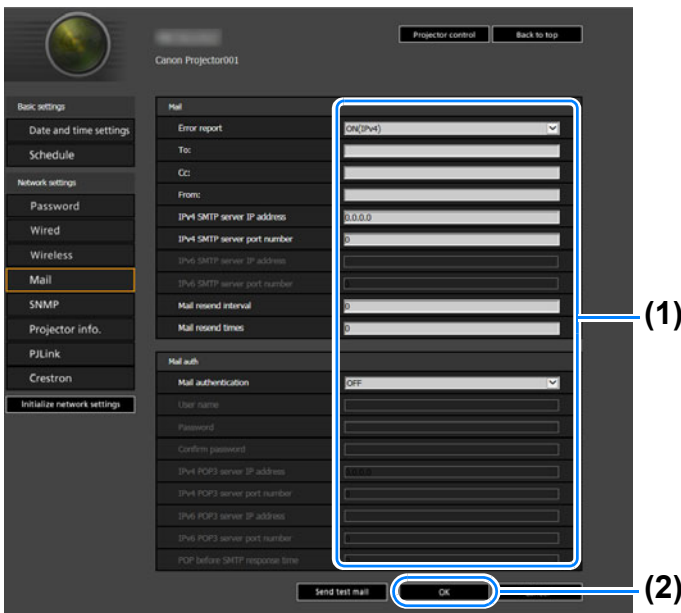

Connection Procedure

- 3 A confirmation window appears. Check the contents and if they are correct, click [Apply].**



The settings are applied to the projector.

Selecting [Wired], [Wireless] or [Password] in the menu will cause this message to be displayed: “Save completed. Please change setting and reconnect.”

If you select functions other than above, “Save completed” is displayed. Click [Back to top] to return to the top page of the web screen.

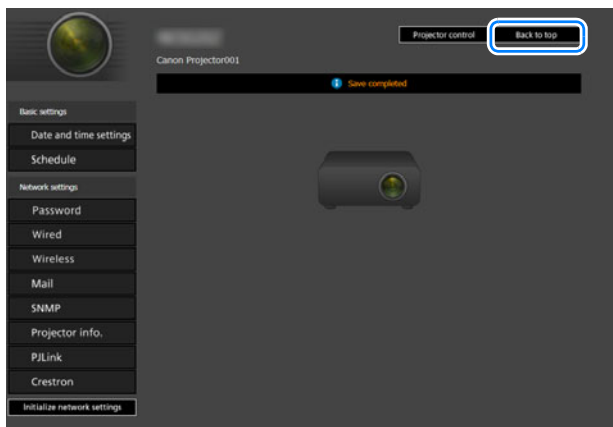

Setting Errors

When a setting-related error occurs, the error name is displayed on the screen, and a “” mark is displayed next to the input field which caused the error.

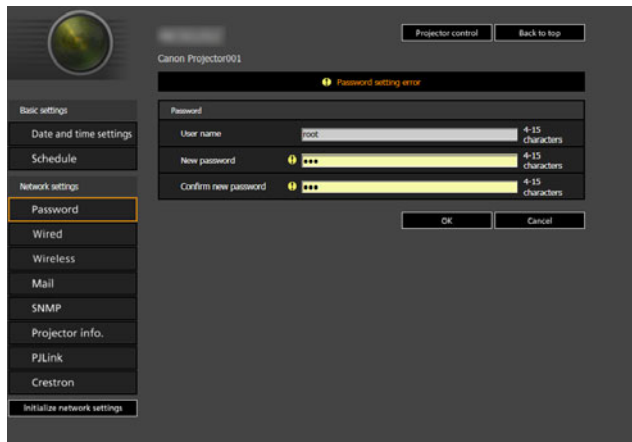

The error meanings are as shown below.

Error	Meaning
Input error	A setting outside the valid range was set on the settings screen.
Password setting error	The set password and confirmation password did not match.
Invalid SMTP	The SMTP server IP address has not been set.
System failed to connect SMTP server.	Failed to connect to the SMTP server attempting to send a test mail.
System failed to connect POP3 server.	Failed to connect to the POP3 server attempting to send a test mail.
System doesn't support this auth type.	An authentication type was set which is not supported by the server.
System failed to authenticate.	Authentication failed attempting to send a test mail.
The system failed to send the test mail.	Sending of test mail failed due to a connection failure with the SMTP server or an error which does not ordinarily occur.
Wired network is down	Wired networking is disabled.
At the time of Monday, it is already set.*	Failed to set the schedule, because operation is already scheduled for the specified time and day.
Wireless network is Projector access point mode	Connected in PJ AP mode.
Wireless network is down	Wireless networking is disabled.

* Messages vary depending on the day.

Resetting Network Settings to the Default Settings

- 1 Perform steps 1 – 3 on “Setting Up the Network” (P71) to display the settings screen.
- 2 Click [Initialize network settings].



- 3 A confirmation window appears. Click [OK].

■ Error Notification Mails

The messages shown in the following error list are sent when an error occurs in the projector.

Error list

Errors related to temperature	Error name	Temperature abnormality
	Text	The temperature inside the projector is too high for some reason or the outside air temperature is higher than the operating range. If the problem is inside the projector, check whether the projector is installed and operating normally, unplug the projector from the power outlet to cool down the projector interior and then restart projection. If the air intake or exhaust vent is blocked, remove the obstacle. If the air filter is clogged, replace it. If the same warning occurs again, there may be a malfunction in the projector. Contact the Canon Customer Support Center.
Errors related to the light source	Error name	Light source abnormality
	Text	The light source does not illuminate. Restart the projector and check projection. If the light source does not illuminate after this, the light source drive circuit may be damaged. Contact the Canon Customer Support Center.
Errors related to the air filter	Error name	Faulty air filter unit
	Text	The air filter is not installed correctly. Install the air filter correctly and restart the projector. If the same warning occurs again, there may be a malfunction in the projector. Contact the Canon Customer Support Center.
Errors related to the fan	Error name	Faulty cooling fan
	Text	There may be a malfunction in the cooling fan or another component. Unplug the projector from the power outlet, then plug it back into the outlet and turn on the projector again. If the same warning occurs again, there may be a malfunction in the projector. Contact the Canon Customer Support Center.

Connection Procedure

Errors related to the power	Error name	Faulty power supply
	Text	Abnormal voltage is applied to some parts in the power supply or another failure may have occurred. Unplug the projector from the power outlet, then plug it back into the outlet and turn on the projector again. If the same warning occurs again, there may be a malfunction in the projector. Unplug the projector from the power outlet. Contact the Canon Customer Support Center.
Errors related to the lens	Error name	Faulty lens
	Text	The lens unit is not installed correctly. Unplug the projector, install the lens unit correctly, and then plug the projector in again. If the same warning occurs again, there may be a malfunction in the projector. Contact the Canon Customer Support Center.

Controlling the Projector from a Computer

The projector can be controlled from a computer over a wired or wireless network connection.

- 1 Turn on the computer and projector.**
- 2 Launch a web browser, enter “http://(projector IP address)” in the address bar, and press the Enter key.**
The projector web screen appears.



The factory default IP address is “192.168.254.254” for wired connections and “192.168.253.254” for wireless connections. If DHCP settings are used, ask the network administrator for the projector IP address. It is possible to check the IP address from the projector menu (P161).

- 3 Click [Projector control] on the web screen.**
The password input window appears.
- 4 Enter the user name and password on the password input window, then click [OK].**
The factory default user name is “root” and the password is “system”.
The projector control screen appears.

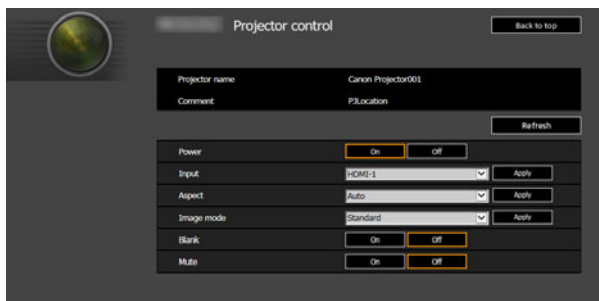

The projector can be controlled from this screen.

Connection Procedure

Item	Explanation
Projector name	The name of the connected projector is displayed (P188).
Comment	Shows notes, such as where the projector is installed (P188).
Refresh	Refreshes the displayed contents with the most recent information.
Power	Turns projector power on or off.
Input	Select an input signal and click [Apply] to change to that input signal (P42).
Aspect	Select an aspect and click [Apply] to change to that aspect (P81).
Image mode	Select an image mode and click [Apply] to change to that image mode (P44).
Blank	Switches the blank setting on or off (P47).
Mute	Switches the mute setting on or off (P49).
Information	The control results and control error information are displayed at the top of the screen.

- 5** When the operations are finished, click [Back to top] to return the initial web screen.

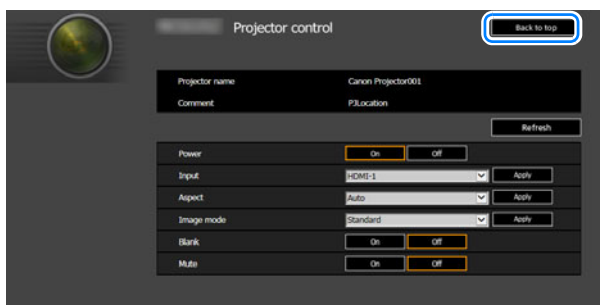

Adjusting the Image

Filling the Screen

■ Selecting an Aspect Ratio

Select an aspect ratio type based on the input signal type, aspect ratio of the screen and resolution.

Press the **ASPECT** button on the remote control to change the aspect ratio type.*



Option	Function
Auto	An image is projected at the aspect ratio of the input signal. Select this mode for normal image projection.
True size*	The image is projected with the original resolution of the input signal. Screens of computers with a lower display resolution than the projector are displayed smaller but clearer than in other aspect ratios.

* There may be some cases when this cannot be selected, depending on the input signal and/or resolution. Menus that are not available are grayed out or hidden.



The aspect ratio type can also be switched from the menu accessed from [Input settings] > [Aspect] (P113).

Adjusting Keystone Distortion

Two types of correction are available: horizontal/vertical correction and corner correction.

Use horizontal/vertical keystone correction to adjust image width or height distortion separately, and use corner correction to adjust the position of each corner of the image.

Keystone correction is also possible by pressing the **KEYSTONE** button on the remote control.

Horizontal/Vertical Keystone Correction

1 Select [Install settings] > [Keystone] > [Horizontal-vertical keystone].

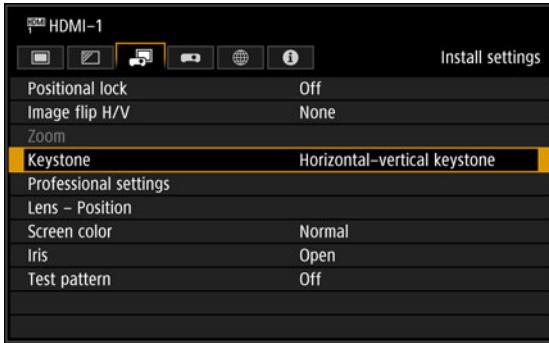

You can also display the [Horizontal-vertical keystone adjustment] window by pressing the **KEYSTONE** button on the remote control.

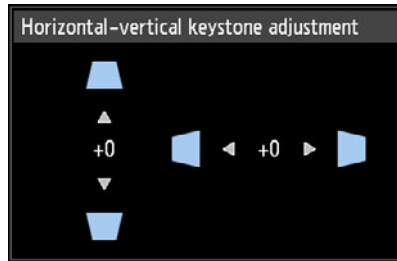
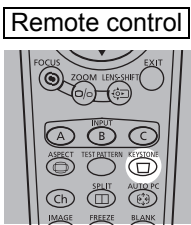

2 Press the pointer buttons to adjust the dimensions, and then press the OK button.

To correct top distortion, press the [▲] button.

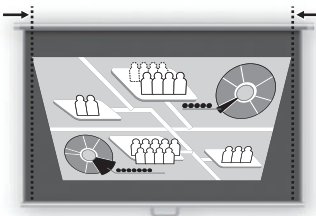

To correct bottom distortion, press the [▼] button.

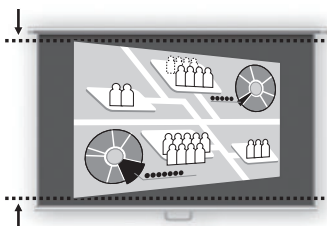
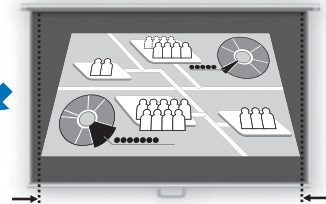

Screen

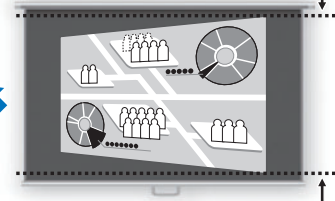

To correct distortion on the left, press the [◀] button.

To correct distortion on the right, press the [▶] button.



- [Zoom] (P128) is not available when [Keystone] is set to [Horizontal-vertical keystone].
- The available horizontal-vertical keystone range may vary depending on the lens, lens zoom position, and shift position.

■ Corner Adjustment

- 1 Select [Install settings] > [Keystone] > [Corner adjustment].

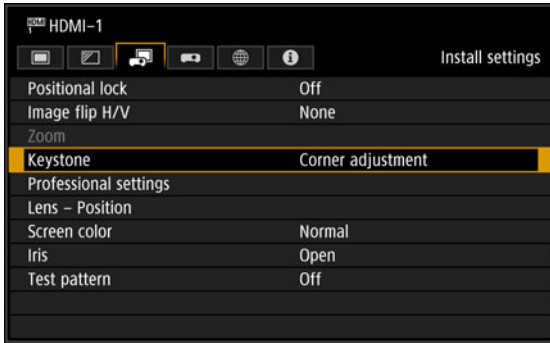

You can also display the [Corner adjustment] window by pressing the **KEYSTONE** button on the remote control.

Remote control

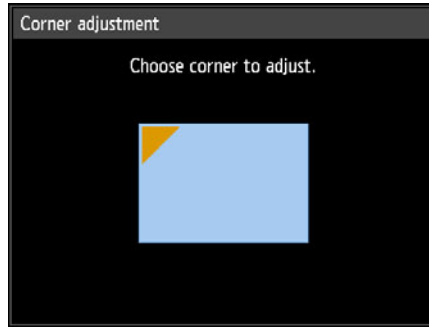
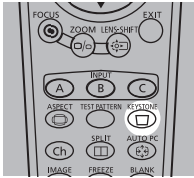

- 2 Press the pointer button of the corner for correction, and then press the OK button.

Remote control

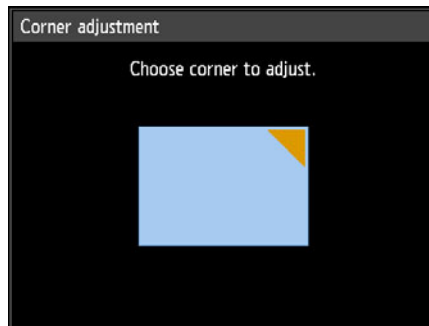

Adjusting the Image

- 3 Press the pointer buttons to adjust the corner, and then press the OK button.



 [Zoom] (P128) is not available when [Keystone] is set to [Corner adjustment].

Resetting the Keystone Adjustment

First, press the **KEYSTONE** button on the remote control twice to display the [Keystone reset] window. Next, select [OK] with the [**◀**] button, and then press the **OK** button.

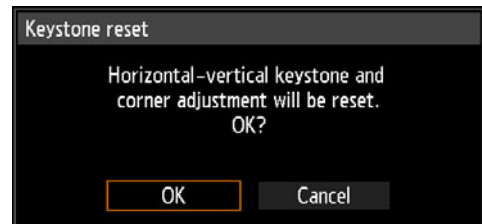

Advanced Registration to Adjust Projected Images

This feature enables precise correction of red, green, or blue misalignment in different areas of the screen by color and area.

Two methods of registration are available: 5-point adjustment (using points in the corners and center of the screen) and more precise manual adjustment based on 54 points (in a 6 x 9 grid).

Any values you set in 5-point adjustment are retained if you subsequently perform manual adjustment. For more precise correction after 5-point adjustment, perform manual adjustment.



- Adjust zoom and lens shift as needed before using [Advanced registration].
- Performing keystone adjustment will prevent accurate adjustment with [Advanced registration]. If keystone adjustment is required, complete adjustment with [Advanced registration] first.

■ Registration Using 5-Point Adjustment

5-point adjustment enables basic correction of color misalignment across the screen, by moving adjustment points in each corner and the center.

- 1** In the [Install settings] menu, select [Professional settings] > [RGB alignment] > [Advanced registration] > [Adjust] > [5-point adjustment] > [Adjust].

The projector enters 5-point adjustment mode, and a chart is displayed.



- With advanced registration, checkered or halftone image areas may be affected by uneven colors or image artifacts.

Adjusting the Image

- 2 Use the [▲] / [▼] / [◀] / [▶] buttons to select the point for correction, and then press the OK button.

The projector enters color selection mode.

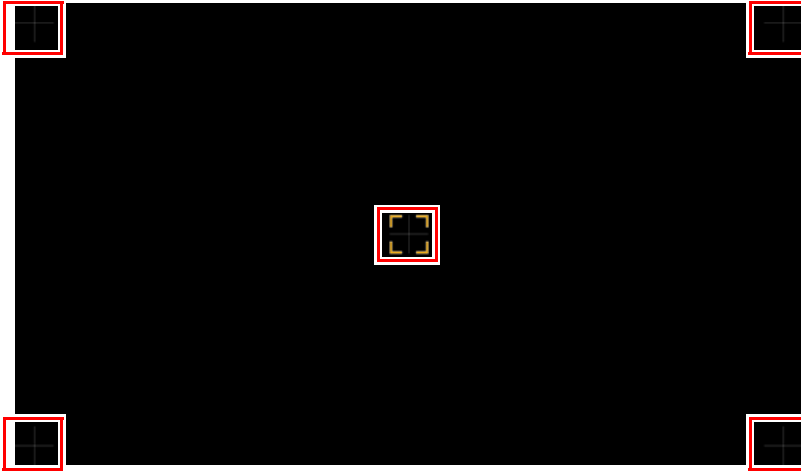

Press the **MENU** button to return to [Advanced registration].

- 3 Select [Red] or [Blue] as the color, and then press the OK button.



- Each time you select [Chart] and press the **OK** button, display switches between the chart and the source signal.
- Accessing the 5-point adjustment window during test pattern projection will show the test pattern instead of your supplied signal.

- 4 Use the [▲] / [▼] / [◀] / [▶] buttons to align the adjustment points.

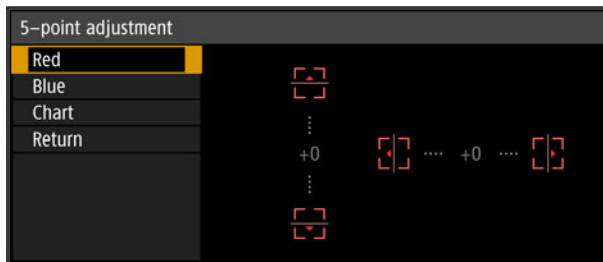

- 5 Press the OK button to return to the window for color selection mode.
- 6 Repeat this process to align the remaining colors and adjustment points.

Manual Registration

Use manual adjustment to correct registration only in certain areas.



Any manual adjustment values set before switching to 5-point adjustment are cleared.

- 1 In the [Install settings] menu, select [Professional settings] > [RGB alignment] > [Advanced registration] > [Adjust] > [Manual adjustment]. The projector enters manual adjustment mode, and a chart is displayed.

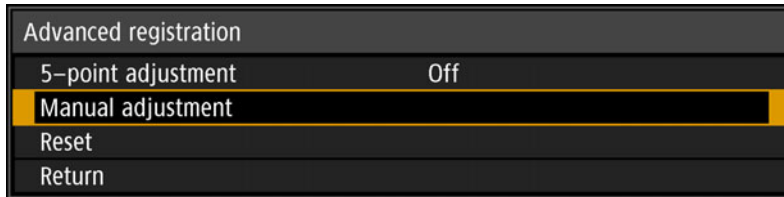

With advanced registration, checkered or halftone image areas may be affected by uneven colors or image artifacts.

- 2 Use the [▲] / [▼] / [◀] / [▶] buttons to select the point for correction, and then press the OK button. The projector enters color selection mode.

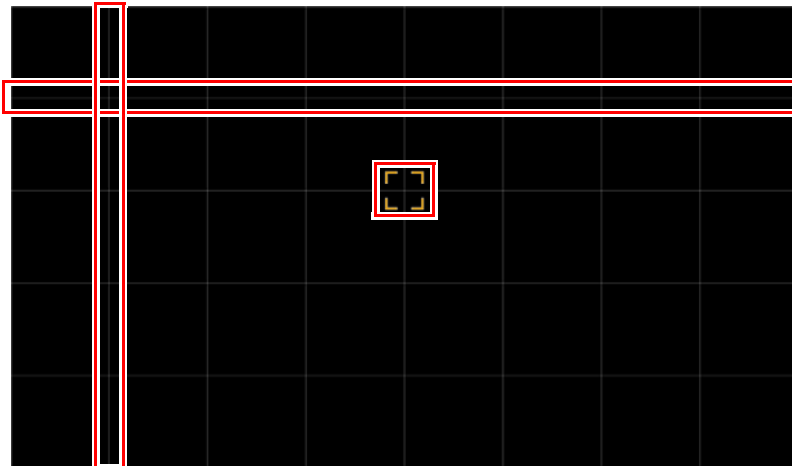

Press the **MENU** button to return to [Advanced registration].

Adjusting the Image

3 Select [Red], [Green], or [Blue] as the color, and then press the OK button.



- Each time you select [Chart] and press the **OK** button, display switches between the chart and the source signal.
- Accessing the manual adjustment window during test pattern projection will show the test pattern instead of your supplied signal.

4 Use the [▲] / [▼] / [◀] / [▶] buttons to align the adjustment points.

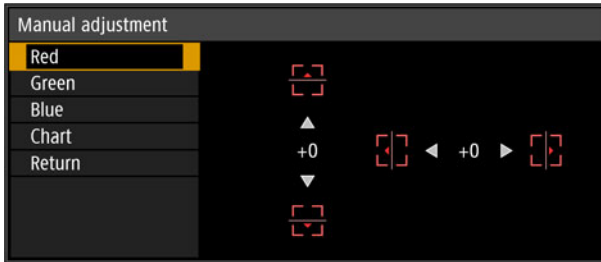

5 Press the OK button to return to the window for color selection mode.

6 Repeat this process to align the remaining colors and adjustment points.

■ Resetting Image Registration

Clears the values set in 5-point adjustment or manual adjustment.

1 In the [Install settings] menu, select [Professional settings] > [RGB alignment] > [Advanced registration] > [Adjust] > [Reset].

A confirmation message for resetting is displayed.

2 Select [OK] to reset the adjustment.

The following tasks are executed.

- Values set in 5-point adjustment are cleared.
- 5-point adjustment is deactivated.
- Values set in manual adjustment are cleared.

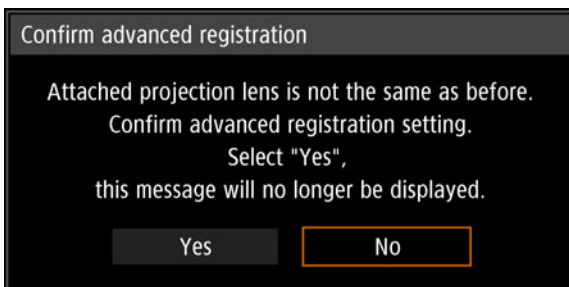

[Advanced registration] setting values are not cleared if you switch lenses. However, on startup after you switch lenses, a message is displayed requesting you to confirm advanced registration settings if, for any adjustment point, [Advanced registration] setting values differ from defaults.

Adjusting Projected Images with Partial Distortion Correction

This feature enables precise correction of partial projected image distortion in your specified areas. Red, green, and blue are adjusted together.



- Correction separate from [Advanced registration] is possible.
- Correction is not possible from adjustment points on the outermost edge toward the outside of the projected image.

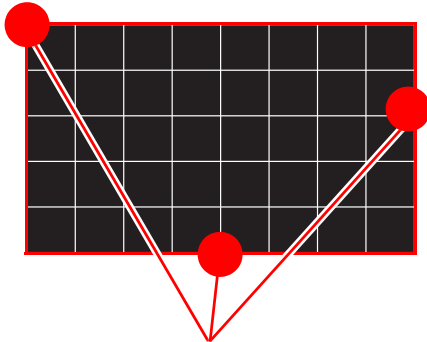

Cannot be specified outside

■ Correcting Partial Distortion

Select one of the 54 adjustment points (in a 6 x 9 grid) for precise distortion correction.

- 1** In the [Install settings] menu, select [Professional settings] > [Partial distortion correction] > [Adjust].

The projector enters partial distortion correction point selection mode, and a window is displayed for selection of areas to correct.

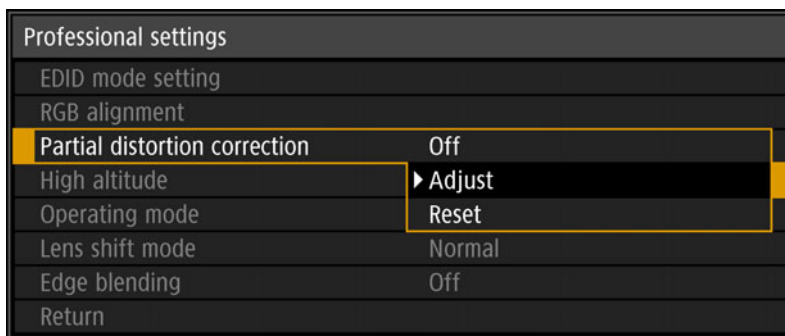

Adjusting the Image

- 2 Use the [▲] / [▼] / [◀] / [▶] buttons to select the point to fine-tune.

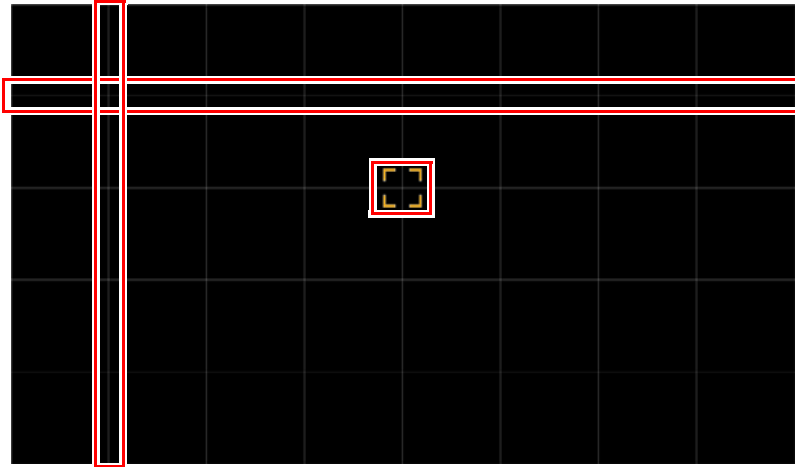

- 3 After selecting the point to fine-tune, press the OK button. The projector is now in partial distortion correction mode.

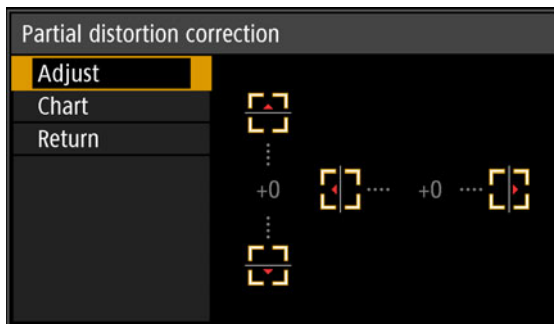

- To return to selection of the point for partial distortion correction, press the **MENU** button.
- Each time you select [Chart] and press the **OK** button, display switches between the chart and the source signal.
- Accessing the partial distortion correction window during test pattern projection will show the test pattern instead of your supplied signal.

- 4 Use the [▲] / [▼] / [◀] / [▶] buttons to fine-tune the adjustment point for partial distortion correction.
- 5 Select [Return] to return to point selection.
- 6 Repeat this process to correct other areas.

■ Resetting Image Registration

Clears the values set in partial distortion correction.

1 In the [Install settings] menu, select [Professional settings] > [Partial distortion correction] > [Reset].

A confirmation message for resetting is displayed.

2 Select [OK] to reset the adjustment.

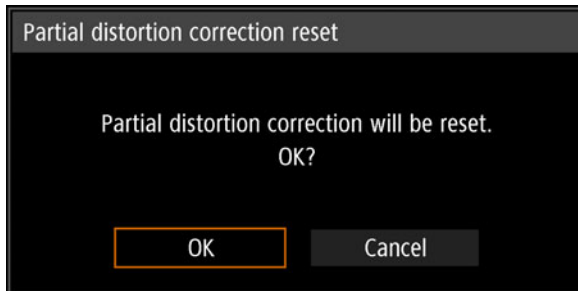

Adjustment Using a Test Pattern

Resolution and colors can be adjusted during installation by using test patterns. To access the test pattern menu, select [Test pattern] > [On] (P138) in the [Install settings] menu or press the **TEST PATTERN** button on the remote control.

While the test pattern is displayed, you can use the [▲] / [▼] buttons to switch patterns. Also, if there is an option pattern available, you can use the [◀] / [▶] buttons to switch pattern. A dialog box is shown during test pattern display that identifies the current test pattern and provides operating instructions.

Watch the test pattern projected as you adjust the image.

The following test patterns can be displayed.

Use [▲] / [▼] to switch patterns

Use [◀] / [▶] to switch option patterns

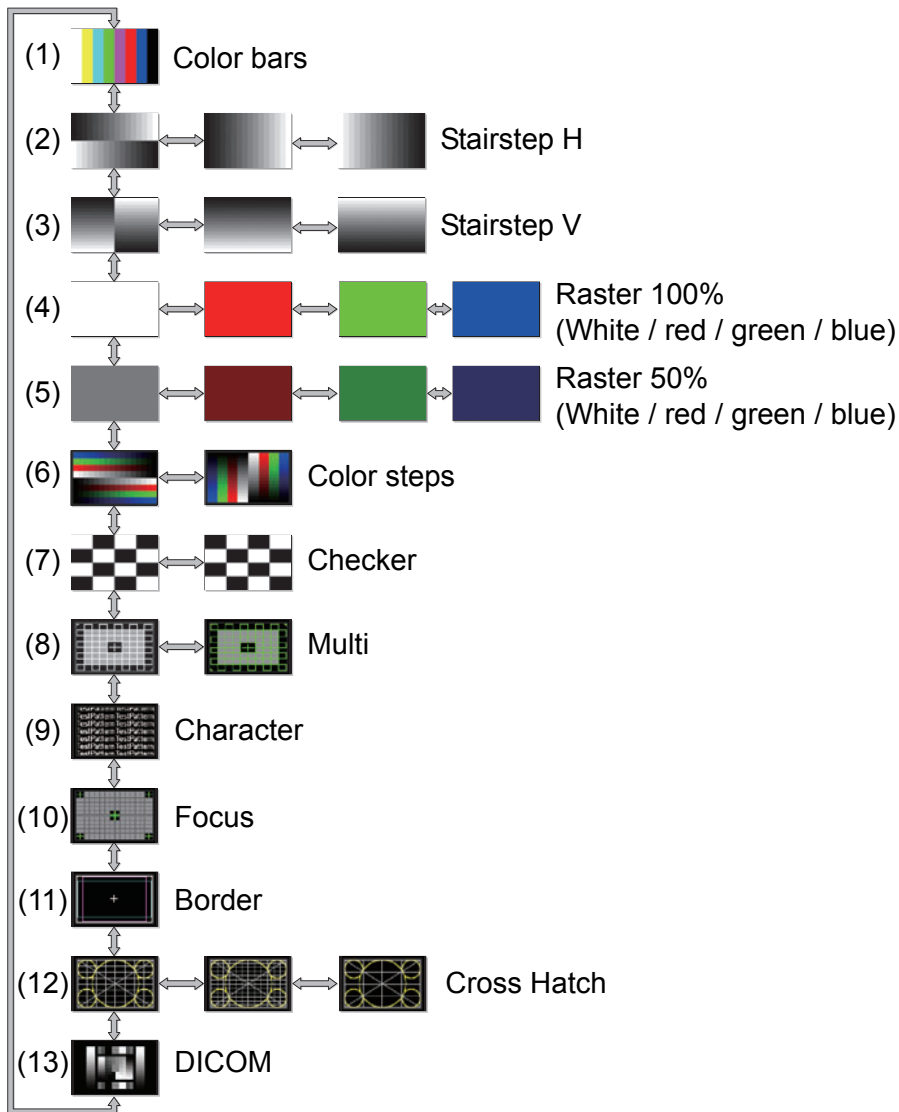

Adjusting Peripheral Focus

This feature enables focus adjustment around the edges of the screen.

- Use marginal focus adjustment for curved screens, such as domes.
- Use marginal focus adjustment to bring images on flat screens into focus if image edges remain warped after you adjust the overall focus.



- The marginal focus feature is not available depending on the type of lens installed.
- [Marginal focus] must be set to [On] in advance ([P134](#)).

■ Bringing Image Edges into Focus

To adjust peripheral focus, press the **FOCUS** button on the remote control or the **LENS** button on the projector.

- 1 Press the FOCUS button on the remote control twice to display the marginal focus adjustment window.**

Remote control



Press twice.

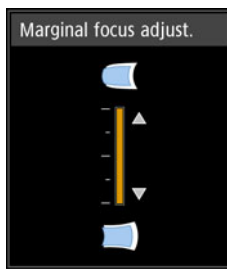

Special Arrangements

Pressing the **LENS** button on the projector repeatedly switches between windows for lens-related parameters.

Press the **LENS** button twice to display the marginal focus adjustment window.

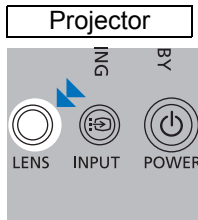

Press twice.

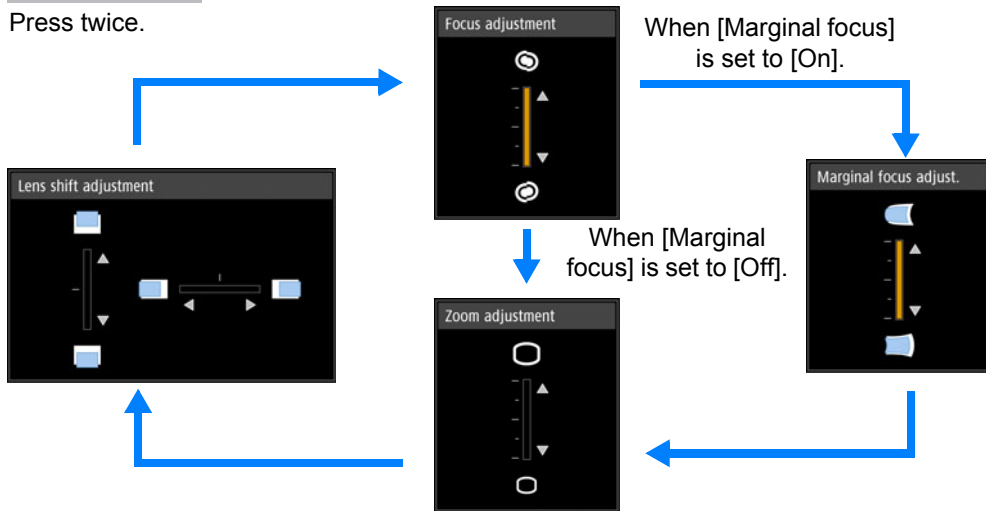

2 Press the pointer buttons to adjust the focus at image edges.

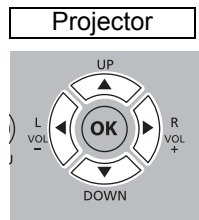
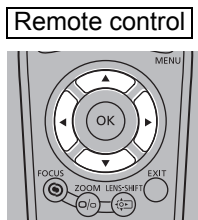

Press the [▲] / [▶] / [▼] / [◀] buttons to adjust peripheral focus.

The focus at the center of the screen may become blurred when the indicator is moved to nearly to the top or bottom edge in the [Marginal focus adjust.] window. If this happens, perform steps (1) to (3) below repeatedly to adjust the focus of the entire screen.

- (1) Use [Focus adjustment] (P43) to adjust the focus at the center of the screen.
- (2) Use [Marginal focus adjust.] to adjust the focus at the edges of the screen.
- (3) Check the focus at the center of the screen.



When using the lens shift adjustment function, the optical axis may be shifted further from the center of the screen than when the function is not used. This can be adjusted by performing steps (1) to (3) repeatedly.

3 Once image edges are in focus, press the OK or FOCUS button.

■ Resetting Adjustment

Clears the values set in marginal focus adjustment and returns the lens marginal focus to the standard position.

In the [Install settings] menu, select [Professional settings] > [Marginal focus] > [Reset] to reset the adjustment.

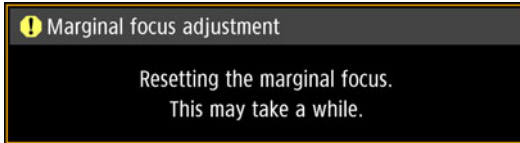

After the above window disappears, the values set in [Marginal focus] are cleared and the lens marginal focus is returned to the standard position. A reset can be applied regardless of whether [Marginal focus] is set to [On] or [Off].



- Setting [Marginal focus] to [Off] will not reset the setting value for marginal focus. Select [Off] to preserve the setting value and prevent further adjustment.
- Even after resetting, the focus may be slightly off at the center and edges of flat screens.
- If necessary, use marginal focus adjustment to bring the center and edges into focus.

Projecting from Multiple Projectors at Once (Edge Blending)

Overlapping edges of images from multiple projectors used together can be blended to make the overall image more seamless. This feature is called edge blending.

Follow these steps for basic edge blending with two projectors side by side.

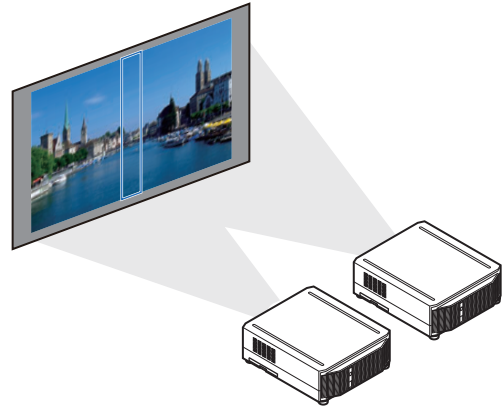

Keep in mind when projecting from multiple projectors that each unit may have a different color balance. Thus, even with the same model, differences in color may be noticeable.

- 1 Select [Install settings] > [Professional settings] > [Edge blending] > [Adjust].

Edge blending		
Side	Width	Start position
Left	0	0
Right	0	0
Top	0	0
Bottom	0	0
Color blending adjustment		
	Off	
Black level adjustment		
	Off	
Marker		
	Off	
Reset		
Return		

- 2 Set [Marker] to [On].

Marker lines are projected on the images. The red marker indicates the start position for adjustment, and the green marker, the end position. Initially, only the red marker is visible when you prepare for edge blending, because it is projected over the green marker.

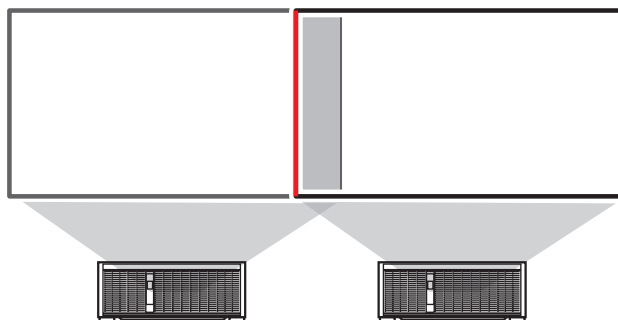

Special Arrangements

- 3** In [Side], select [Start position] and use the [▲] / [▼] buttons to move the start marker to the outer edge of the overlapping area.
Do this for each edge; on the top, bottom, left, and right.

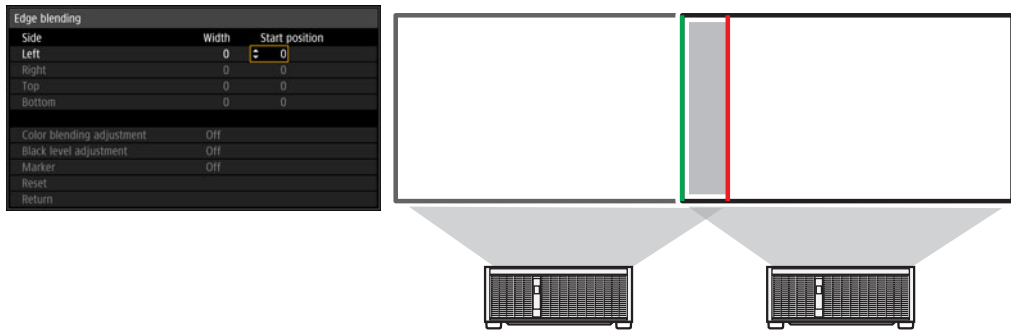

- 4** Select [Width] and use the [▲] / [▼] buttons to move the end marker to the inner edge of the overlapping area.
Do this for each edge; on the top, bottom, left, and right.

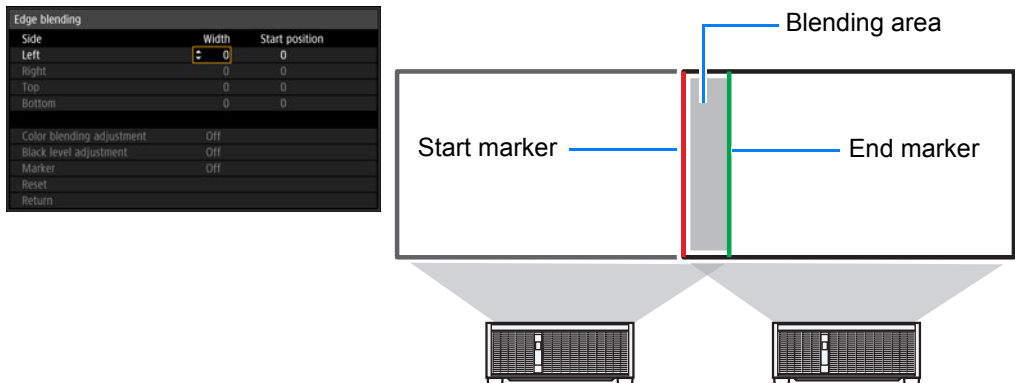

The area between the starting and ending markers is called the blending area. Shading is applied to this area, and the brightness is adjusted to match portions that overlap with other areas. After you complete settings for one image, do the same thing for the other one to specify the blending area. Adjust the settings to make the blending area for each image the same.

- 5** Set [Marker] to [Off].

■ Adjusting the Overlapping Area

Adjust the overlapping area to create a smoother transition between projected images.

Matching Colors in the Overlapping Area

In overlapping projection, portions of images in the overlapping area that pick up other colors or are miscolored may be more noticeable. You can make this overlapping area appear less distracting by performing [Color blending adjustment].

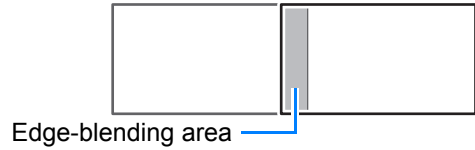

- 1 Select [Install settings] > [Professional settings] > [Edge blending] > [Adjust] > [Color blending adjustment] > [Adjust].



- 2 First adjust red, green, and blue together by changing the [White] value, and then adjust [Red], [Green], and [Blue] values individually.
- 3 Repeat this adjustment on all projectors.

Matching Black in the Overlapping Area

In overlapping projection, dark colors are projected with less intensity than other colors in the overlapping area. You can make this overlapping area less distracting by adjusting the black level of non-overlapping image areas.

Here, the non-overlapping image area (from the end marker toward the center of the image) is called area “D.”

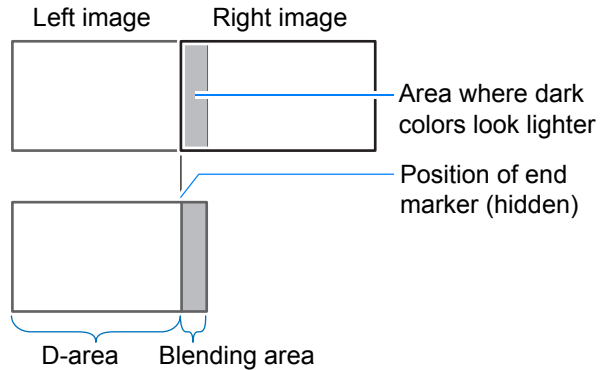

Normally, three areas are identified in the context of end markers: A, B, and C. In the following instructions, only area D is adjusted, and the widths of A, B, and C are left at the default value of 0.



To prepare for adjustment, select [System settings] > [User screen settings] > [No signal screen] > [Black], start projection with no input signal, and turn off the room lights, so that you can check dark image areas.

- 1 Select [Install settings] > [Professional settings] > [Edge blending] > [Adjust] > [Black level adjustment] > [Adjust].
- 2 Select [Adjustment type] > [Black level].
- 3 After selecting [D-area base], as you watch the image, adjust the values so that the brightness and colors of the blending area and area D match.

Black level adjustment	
Adjustment type	Black level
B-area base	0
B-area red	+0
B-area green	+0
B-area blue	+0
D-area base	0
D-area red	+0
D-area green	+0
D-area blue	+0
Return	

- 4 Repeat this adjustment on all projectors.

■ Making Overlapping Edges Less Noticeable

The black level along the right edge of area D (along the blending area) may be more noticeable than that of surrounding areas. By adjusting the black level of area B, you can make the transition smoother. To compensate, adjust each area as follows.

When the projected image has multiple blending areas (on the top, bottom, and each side), the width of areas A, B, and C must be adjusted to suit these blending areas.

In this example, instructions are given for adjusting area B.

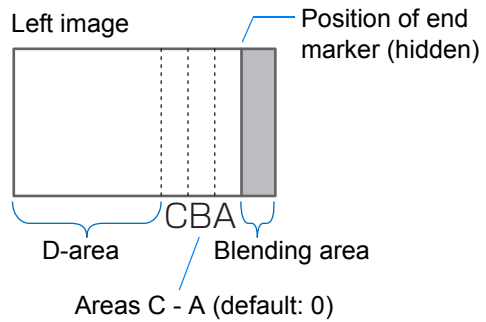

Area A: Black level cannot be adjusted.

Area B: Adjust to a black level different from that of area D.

Area C: Adjust to provide a smooth transition relative to the black levels of areas B and D.

- 1 Select [Install settings] > [Professional settings] > [Edge blending] > [Adjust] > [Black level adjustment] > [Adjust].

Black level adjustment	
Adjustment type	Area
Side	Left
A-width	0
B-width	0
C-width	0
Return	

- 2 Select [Adjustment type] > [Area] > [Side] > [Right].
- 3 Select [B-width], and then adjust the width of area B to roughly match the area where the black level is noticeable.
- 4 Select [Adjustment type] > [Black level]. Adjust [B-area base] as you watch the image.
- 5 As you watch the image, adjust the width of areas A, B, and C.
- 6 Readjust the black level of area B, as needed.



- Results of adjusting the black level of area B are applied to all sides.
- If you perform adjustments using [Color blending adjustment] or other menus, that may not eliminate the distracting colors and differences in brightness in areas where the images overlap.
- Blending can be fine-tuned by adjusting [Adjustment type] > [Black level] > [Red], [Green], and [Blue].

Menu Guide

Using Menus

Use the menus to set the operation of the projector in detail.

1 Press the MENU button to display the menu window.

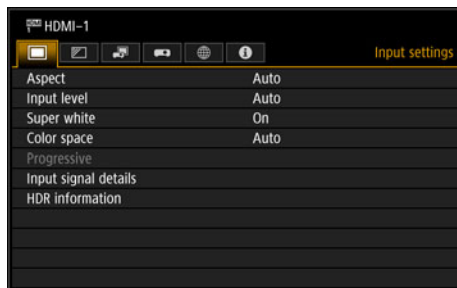
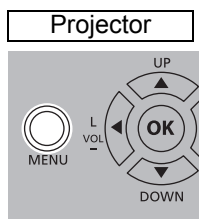
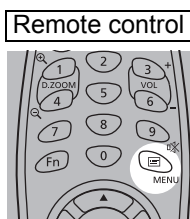

2 Press the [◀] / [▶] buttons to select a tab.

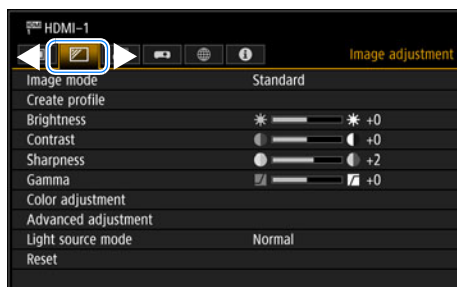
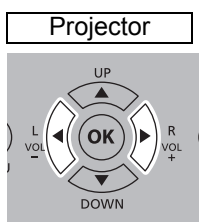
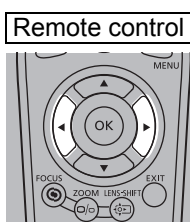

- If the tab position is not highlighted in orange, press the [▲] / [▼] buttons to move the current selection to the top.

3 Press the [▲] / [▼] buttons to select an item.

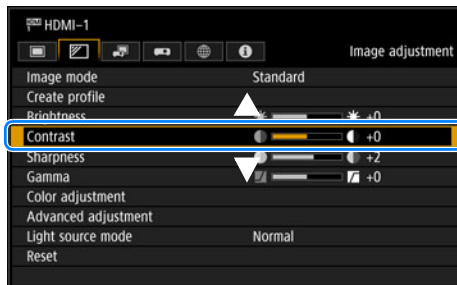
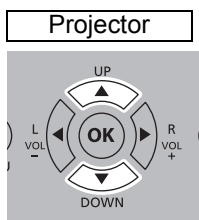
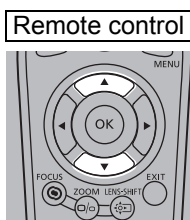

4 Select contents.

How to select the contents varies depending on the item.

Selecting from a list Example: Aspect (P113)

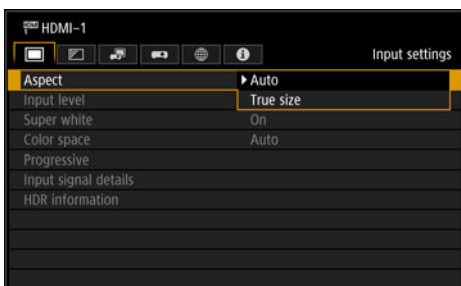

1. Select [Aspect].
2. Press the **OK** button or [▶] button to display a list of the contents.
3. Use the [▲] / [▼] buttons to select the desired contents.
4. When you have found the contents you desired, press the **OK** button or [▶].

Adjusting with the [◀] / [▶] buttons Example: Contrast (P118)



1. Select [Contrast].
2. Use the [◀] / [▶] buttons to adjust the setting.

Selecting from a different screen (1) Example: Logo capture (P140)

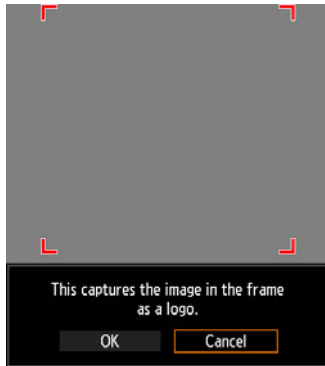

1. Select [Logo capture].
2. Press the **OK** button to display a different screen.
3. Then follow the instruction on the screen.

- 5** Pressing the MENU button causes the menu screen to disappear. The menu screen will also disappear if the EXIT button is pressed.

Using Menus

The menu screen is divided into 6 tabs as shown below.

The diagram shows the projector's menu screen with six tabs: **[Input settings] tab (P113)**, **[Image adjustment] tab (P117)**, **[Install settings] tab (P127)**, **[System settings] tab (P139)**, **[Network settings] tab (P158)**, and **[Information] tab (P173)**. The **[Input settings] tab** is selected, showing a list of menu items: Aspect, Input level, Super white, Color space, Progressive, Input signal details, and HDR information. The **[Image adjustment] tab** shows menu items: Auto, Auto, On, and Auto.

[Input settings] tab (P113)
You can set the type of signal or the method of projection of the images input.

[Image adjustment] tab (P117)
You can adjust the image quality and colors according to your preference.

[Install settings] tab (P127)
This setting is used when installing the projector.

[System settings] tab (P139)
You can set the operation of the projector.

[Network settings] tab (P158)
These settings are for when using the projector from a PC via a network.

[Information] tab (P173)
You can check information about the signal types of the images projected and other information.

Contents of menu

Menu items

Menu Configuration

Input settings (P113)

Menu	Option / Submenu	Details
Aspect	Auto*, True size	P113
Input level	Auto*, Normal, Expanded	P114
Super white	Off, On*	P114
Color space	Auto*, RGB, YCbCr	P114
Progressive	Off, Film/auto*, Video 1, Video 2, 25p/30p(PsF)	P115
Input signal details	Format information, Color/Range information	P115
HDR information	EOTF, Display primaries [0],[1],[2], White point, Max display mastering luminance, Min display mastering luminance, Max content light level, Max frame-average light level	P116

*: Factory default, or state after [Factory defaults] is executed.

Image adjustment (P117)

Menu	Option / Submenu	Details	
Image mode	Standard*, Presentation, Dynamic, Video, Photo/sRGB, DICOM SIM, User 1 – 5	P118	
Create profile / Save profile	User 1, User 2, User 3, User 4, User 5	P118	
Baseline image mode		P118	
Brightness		P118	
Contrast		P118	
Sharpness		P119	
Gamma		P119	
HDR range		P119	
Color adjustment	Color level	P119	
	Color balance	P119	
	Color temperature	P119	
	Color temperature (1)	Preset 1, Preset 2, Preset 3*, Preset 4 (Clear base), Preset 5 (Blue base)	P120
	R Gain		P119
	G Gain		P119
	B Gain		P119
	R Offset		P119
G Offset		P119	
B Offset		P119	

Menu Configuration

Menu	Option / Submenu		Details	
Advanced adjustment	Ambient light (2)	Off*	P120	
		Adjust		Type, Level
	Random noise reduction	Off*, Low, Middle, High		P121
	Digital noise reduction	Off*, MPEG-NR: Low, MPEG-NR: Middle, MPEG-NR: High, Frame-NR: Low, Frame-NR: Middle, Frame-NR: High		P121
	Dynamic gamma	Off* (7), Low (8), Middle, High		P121
	Contrast detail adjustment	Dynamic contrast (*1)	Off*, Low, Middle, High	P122
		Manual light adjustment (3)		
		Manual signal adjustment (3)		
		Light off control (9)	Disabled*, Enabled	
		Light off detection signal level		
		Light off detection time		
	Colorimetry (6)	Auto*, BT.709, BT.2020	P122	
	HDR (6)	Auto*, Off, HDR10, HLG		P123
	Mem. color correct	Flesh	Off* (7), Weak* (8), Middle, Strong	P123
Sky		Off* (7), Weak* (8), Middle, Strong		
Green		Off* (7), Weak* (8), Middle, Strong		
6-axis color adjust	Off*, Adjust, Reset		P123	
Fine-Tune Gamma (4)	Off*, Adjust		P124	
Light source mode	Normal*, Quiet 1, Quiet 2, Adjust		P125	
Brightness level (5)			P125	
Reset	OK, Cancel		P126	

*: Factory default, or state after [Factory defaults] is executed.

Under the following setting, differs from factory defaults.

(*1): [High] when image mode is [Dynamic]

Displayed under the following conditions.

- (1): When image mode is [DICOM SIM]
- (2): When image mode is [Photo/sRGB]
- (3): When dynamic contrast in contrast detail adjustment is [Off]
- (4): When image mode is not [DICOM SIM]
- (5): When the operating mode is not set to [Normal]
- (6): When image mode is [Video]
- (7): When image mode is not [Dynamic]
- (8): When image mode is [Dynamic]
- (9): When dynamic contrast is [High]

Install settings (P127)

Menu	Option / Submenu			Details	
Positional lock	Off*, On			P128	
Image flip H/V	None*, Ceiling mounted, Rear, Rear, Ceiling mounted			P128	
Zoom (12)				P128	
Keystone	Off (10), Horizontal-vertical keystone (11), Corner adjustment			P129	
	Reset	OK, Cancel			
Professional settings	EDID mode setting	HDMI-1 EDID mode	Wide bandwidth (4K60Hz)*, High compatibility	P130	
		HDMI-2 EDID mode	Wide bandwidth (4K60Hz)*, High compatibility	P130	
	RGB alignment	Micro-digital image shift	Off*, Adjust		P130
		Registration	Off*, Adjust		
		Advanced registration	Off*, Adjust		
	Partial distortion correction	Off*, Adjust, Reset			P132
	High altitude	Off*, On			P133
	Operating mode	Normal*, Fixed brightness, Long duration 1, Long duration 2			P133
	Lens shift mode	Normal*, Expanded			P133
	Marginal focus	Off*			P134
		On	OK		
Reset					
Edge blending	Off*			P134	
	Adjust	Left, Right, Top, Bottom, Color blending adjustment, Black level adjustment, Marker, Reset			
Lens - Position	Load position 1 – 3			P137	
	Save position 1 – 3				
	Lens shift reset	Preset positions	XX% (11)(13), 0%		
Screen color	Normal*			P138	
	Greenboard				
	Adjust	R Gain, G Gain, B Gain, R Offset, G Offset, B Offset			
Iris	Open*, Adjust			P138	
Test pattern	Off*, On			P138	

*: Factory default, or state after [Factory defaults] is executed.

(10):When using lenses not equipped with optical zoom, this is the factory default, or state after [Factory defaults] is executed

(11): When using lenses equipped with optical zoom, this is the factory default, or state after [Factory defaults] is executed

(12):Only available in the following cases

- Using lenses not equipped with optical zoom
- Keystone set to [Off]

(13):XX% indicates the preset position of the installed lens.

System settings (P139)

Menu	Option / Submenu		Details	
User screen settings	Logo capture	OK, Cancel	P140	
	Logo position	Upper L, Upper R, Center*, Lower L, Lower R	P140	
	No signal screen	Black, Blue*, User logo	P140	
	Screen when blank	Black, Blue, Light source off*, User logo	P140	
	Projector on	Skip, Canon logo*, User logo	P141	
On screen	Menu position	Upper L, Upper R, Center*, Lower L, Lower R	P141	
	Menu display time	Normal*, Extended	P141	
	Menu rotation	Auto, Off*, 90 degrees counterclockwise, 90 degrees clockwise	P142	
	Guide	Off, On*	P142	
	Show input status	Off, On*	P143	
	Air filter warning display	Off, On*	P143	
	Overheat warning display	Off*, On	P143	
Remote control/Side control	Beep	Off, On*	P143	
	Key repeat	Off, On*	P144	
	Key lock	Off*, Main unit, Remote (wireless)	P144	
	IR receiver settings	All*, Front, Rear	P144	
	Remote control channel	Ch1, Ch2, Ch3, Ch4, Independent*	P145	
	[INPUT A-C] button settings	INPUT A	Disable	P145
			HDMI-1*	
			HDMI-2	
			DP-1	
			DP-2	
			HDBaseT	
		INPUT B	Disable	
			HDMI-1*	
			HDMI-2	
			DP-1	
DP-2				
HDBaseT				
INPUT C		Disable		
		HDMI-1*		
		HDMI-2		
	DP-1			
	DP-2			
	HDBaseT			
Audio in terminal select	HDMI-1	Off, HDMI-1*	P145	
	HDMI-2	Off, HDMI-2*		
	DP-1	Off, DP-1*		
	DP-2	Off, DP-2*		
	HDBaseT	Off, HDBaseT*		
	DP 1x2	Off, DP-1*, DP-2		
	HDBaseT signal quality			P146
Communication settings	Extron XTP	Off*, On	P146	
	Serial communication	Service port*, HDBaseT		
		Detail	Baud rate, Data bits, Parity	
			Stop bit	1*, 2
Command monitor	Off*, On, Display, Clear		P147	

Menu Configuration

Menu	Option / Submenu		Details	
Power supply settings	Standby power setting	Normal, Low-power*	P147	
	Quick startup	Off*, On	P148	
	Power management mode	Disabled, Light source off, Standby*	P148	
	Power management duration	5 min., 10 min., 15 min.*, 20 min., 30 min., 60 min.	P148	
	Direct power on	Off*, On	P148	
Motion blur reduction	Off*, Weak, Strong		P149	
Language	English*, Deutsch, Français, Italiano, Español, Português, Svenska, Русский, Nederlands, Suomi, Norsk, Türkçe, Polski, Magyar, Čeština, Dansk, انجليزية, 中文简体, 中文繁體, 한국어, 日本語		P149	
Other settings	Password settings	Off*, On	P150	
	Register password		P151	
	Date and time settings	Date and time		P151
		Date display format	Year/month/date, Month/date/year, Date/month/year	
		Daylight saving time	Off*, On, Edit	
		Region, Time zone		
	Schedule	SNTP	Off, On (IPv4), On (IPv6)	P152
		Schedule	Default, Off*, On, Edit	
	Calibration	Special period 1 – 5	Off*, On, Edit	P155
		Gamma restore	Off*, Adjust	
		Light source calibration	OK, Cancel	
	Trigger out	Off*, Link with power		P156
	Air filter counter	Reset	Yes, No	P156
Power counter			P156	
Firmware	Yes, No		P157	
Factory defaults	OK, Cancel		P157	

*: Factory default, or state after [Factory defaults] is executed.

Network settings (P158)

Menu	Option / Submenu		Details	
Network settings lock	Unlock	Password input	P159	
	Lock*			
Network password setting	Off, On*		P159	
Register network password	Password input		P159	
Network (wired/wireless)	Off/Off*, On/Off, On/On (Pj AP), Off/On (Pj AP), Off/On (Infra)		P160	
Detailed settings (wired)	MAC address		P161	
	Detailed IPv4 address settings	IP address, Subnet mask, Gateway address		
		DHCP		Off*, On
		TCP/IP settings		IP address, Subnet mask, Gateway address
	IPv6	Off*, On		P162
	Detailed IPv6 address settings	Link local, Auto <1> – <5>, Manual, Gateway		
		Auto settings	Off, On*	
		Manual settings	IP address, Prefix length, Gateway address	
	Network setting initialization	Yes, No		P164
	Detailed settings (wireless)	Mode, SSID, Security, Channel, Signal strength, MAC address		P165
Wi-Fi Protected Setup		PBC	Yes, No	
		PIN	Yes, No	
Manual settings		Mode		
		SSID	Update, Switch page, SSID 1 – 16, SSID input, Manual SSID input	
		Security	Open, WEP, WPA2 AES, WPA/WPA2 TKIP/AES	
		Channel		
		Key ID	1, 2, 3, 4	
		Key type	ASCII, HEX	
		Key		
		Enter		
Detailed IPv4 address settings		IP address, Subnet mask, Gateway address		P167
		DHCP	Off*, On	
		TCP/IP settings	IP address, Subnet mask, Gateway address, Enter	
		IPv6	Off*, On	
Detailed IPv6 address settings		Link local, Auto <1> – <5>, Manual, Gateway		
	Auto settings	Off, On*		
	Manual settings	IP address, Prefix length, Gateway address, Enter		
Network setting initialization	Yes, No			
PJLink	Off, On*		P170	
AMX Device Discovery	Off*, On		P171	
Crestron RoomView	Off*, On		P171	

Menu Configuration

Menu	Option / Submenu		Details	
Information	E-mail sender address		P172	
	E-mail recipient address			
	Detailed information (wired)	IPv4		
		IPv6		Link local, Auto, Manual
	Detailed information (wireless)	IPv4		
		IPv6		Link local, Auto, Manual

*: Factory default, or state after [Factory defaults] is executed.

Information (P173)

Menu
Model name
Input signal
Firmware
Serial no.
Projector usage time
IP address (wired)
IP address (wireless)
Projector name
Comments
System information ID



The following settings are not reset even when factory defaults are restored.

- Selected input signal
- [Image adjustment]
 - Create profile / Save profile
 - Saved values for fine-tuning gamma
- [Install settings]
 - Registration
 - Advanced registration
 - Partial distortion correction
 - High altitude
 - Operating mode
 - Lens shift mode
 - Marginal focus (setting value)
 - Saved values for lens position
- [System settings]
 - Remote control channel
 - Extron XTP
 - Stop bit
 - Standby power setting
 - Quick startup
 - Language
 - Date and time settings
 - Schedule
 - Gamma restore
 - Trigger out
 - Air filter counter
 - Power counter
 - Firmware
- [Network settings]
- [Information]

Input settings

This section describes settings for aspect ratio and resolution.



Menu screen when the input signal is HDMI-1

Menu	Function	Details
Aspect	Select an image aspect ratio.	P113
Input level	Select the input level for HDMI, HDBaseT or DisplayPort signals.	P114
Super white	Select super white mode for HDMI, HDBaseT or DisplayPort signals.	P114
Color space	Select the color space for HDMI, HDBaseT or DisplayPort signals.	P114
Progressive	Select progressive processing for still images in cinematic content or moving images in videos.	P115
Input signal details	Shows input signal details for each input terminal used.	P115
HDR information	Shows the Dynamic Range and Mastering InfoFrame for HDMI signals or HDBaseT signals.	P116

Menus that are not available are grayed out.

Aspect

 > [Input settings] > **[Aspect]**

Select a projection aspect ratio for images.

The **ASPECT** button on the remote control can also be used to select the [Aspect] settings.

Option	Function
Auto	An image is projected at the aspect ratio of the input signal. Suitable for most projection.
True size	The image is projected with the original resolution of the input signal.

Menus that are not available are grayed out.

Input level

 > [Input settings] > **[Input level]**

Adjust the input level for content projected via HDMI, HDBaseT or DisplayPort.

Option	Function
Auto	Automatically switches the input level based on the input signal.
Normal	Limits the input level to 16 – 235.
Expanded	Enables a full input level of 0 – 255.



- In [Auto] mode, the signal level is selected automatically. (Some AV equipment and HDBaseT transmitters may not support this.)
- If your AV equipment HDMI / HDBaseT output can be set to [Normal] or [Expanded], we recommend [Expanded]. The contrast of images will be improved and dark scenes will be rendered more realistically. In this case, set [Input level] to [Auto] or [Expanded]. For more detailed information, refer to the user's manual for the AV equipment connected to the projector.

Super white

 > [Input settings] > **[Super white]**

Select to project white signals in HDMI, HDBaseT or DisplayPort input that are in a range of 16 – 235 at 100% – 109% brightness (235 – 255).

Option	Function
Off	Disable super white. Project white signals with an input level of 235 at 100% brightness. All white signals with an input value exceeding 235 are also projected at 100% brightness.
On	Convert input signals in a range of 16 – 235 so that an input level of 255 is projected as white 109% at 100% brightness.



- Super white has no effect when [Input level] is set to [Expanded].
- Set this option to [Off] if projection looks distorted or unnatural when it is [On].
- Setting this option to [On] will darken the overall image.

Color space

 > [Input settings] > **[Color space]**

Select the color space for HDMI, HDBaseT or DisplayPort signals.

Option	Function
Auto	Selects the optimal color format for input signals.
RGB	Forces the projector to handle the input signal as an RGB signal.
YCbCr	Forces the projector to handle the input signal as a color difference signal.

Progressive



> [Input settings] > **[Progressive]**

Performs progressive processing optimized for still images in cinematic content or moving images in videos, when interlaced HDMI or DisplayPort signals are supplied.

Option	Function
Off	Does not perform progressive processing.
Film/auto	Suitable for still images or typical moving images. Performs progressive processing for video or cinematic content.
Video 1	Suitable for projecting video with high image quality and relatively slow movement. Performs progressive processing optimized for HD video.
Video 2	Suitable for projecting video with faster movement. Performs progressive processing optimized for fast-moving video.
25p/30p(PsF)	Performs progressive processing optimized for 1080 PsF/25 or 1080 PsF/30 video (25 or 30 fps, respectively).



Select [Off] when flickers and horizontal lines are noticeable in media that has a lot of fast-moving action.

Input signal details



> [Input settings] > **[Input signal details]**

Shows details about video signals supplied to the selected input terminal. This menu is displayed for HDMI, DisplayPort, or HDBaseT input.

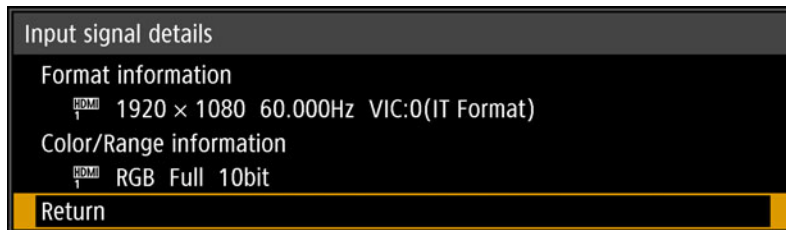

As format information, the resolution, frequency, and Video Identification Code (VIC) are indicated.

As color information, the color format/subsampling and color space are indicated.

As range information, the range and depth are indicated.

HDR information

 > [Input settings] > **[HDR information]**

When HDMI or HDBaseT signals are supplied, shows the Dynamic Range and Mastering InfoFrame information.

The projector determines and indicates whether input signals are SDR or HDR. HDR signals have an area that includes color and luminance information, and this information is indicated. The following information is displayed.

HDR Information		
EOTF	Traditional gamma-SDR	
Display primaries[0]	x:0.2650	y:0.6900
Display primaries[1]	x:0.1500	y:0.0600
Display primaries[2]	x:0.6800	y:0.3200
White point	x:0.3127	y:0.3290
Max display mastering luminance	4000 cd/m ²	
Min display mastering luminance	0.0050 cd/m ²	
Max content light level	1500 cd/m ²	
Max frame-average light level	300 cd/m ²	
Return		

Item	Information Indicated	Details
EOTF	Traditional gamma-SDR	Indicates various gamma information of the video content
	Traditional gamma-HDR	
	SMPTE ST 2084	
	HLG	
Display primaries [0],[1],[2]	x: 0.0000 – 1.0000 y: 0.0000 – 1.0000	Coordinates of the three vertices of the gamut triangle in the color space
White point	x: 0.0000 – 1.0000 y: 0.0000 – 1.0000	Coordinates of “white” in the color space
Max display mastering luminance	1 – 65535 cd/m ²	Maximum luminance of the display used when the video content was produced
Min display mastering luminance	0.0001 – 6.5535 cd/m ²	Minimum luminance of the display used when the video content was produced
Max content light level	1 – 65535 cd/m ²	Maximum luminance of scenes in the video content
Max frame-average light level	1 – 65535 cd/m ²	Maximum value among frames of video content used to determine average luminance

Image adjustment

This section describes image quality settings such as brightness, contrast, and sharpness.

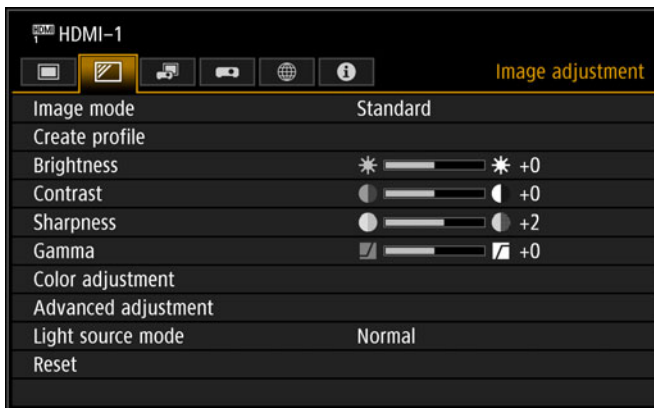

Menu screen when the input signal is HDMI-1

Menu	Function	Details
Image mode*	Select overall image quality to suit the projected image.	P118
Create profile	Save desired image quality settings as profiles.	P118
Baseline image mode	Shows the image mode that is basis of the profile.	P118
Brightness*	Adjust image brightness.	P118
Contrast*	Adjust image contrast.	P118
Sharpness*	Adjust image sharpness.	P119
Gamma*	Correct loss of detail in shadows or highlights.	P119
HDR range*	Within the dynamic range of SMPTE ST 2084, set the range to use.	P119
Color adjustment*	Fine-tune image colors.	P119
Advanced adjustment*	Fine-tune noise reduction and color tone.	P120
Light source mode*	Adjust projection brightness and operating sounds.	P125
Brightness level*	Adjust projection brightness as controlled by the drive current of the laser diode.	P125
Reset	Restore default image settings.	P126

Menus that are not available are grayed out or hidden.

* Any adjustments you make are stored for each combination of input signal and image mode.

Image mode

 > [Image adjustment] > **[Image mode]**

Select the overall image quality for projected images. Can also be selected by pressing the **IMAGE** button on the remote control (P33).

Option	Types of Images	Effect
Standard	Computer screens, or media played with video software	Bright overall; white, with natural colors
Presentation	Images mainly consisting of text	Bright overall
Dynamic	Video content	Bright overall
Video	Video from camcorders	Somewhat dark; colors resemble TV
Photo/sRGB	Digital photos from sRGB-compatible cameras	Somewhat dark; conforms to the sRGB standard
DICOM SIM	Medical or other monochrome images	Conforms to DICOM Standard Part 14. However, the projector cannot be used in diagnosis or similar applications.
User 1 – 5	Up to five user profiles can be stored for your selected image quality settings. Stored profiles are available in this setting as an image mode.	

Menus that are not available are grayed out.



You can adjust the image quality by adjusting the following items in each image mode: [Brightness], [Contrast], [Sharpness], [Gamma], [HDR range], [Color adjustment], [Advanced adjustment], [Light source mode] and [Brightness level]

Create profile / Save profile

 > [Image adjustment] > **[Create profile]**

Save desired image quality settings in up to five user profiles.



- The saved settings are [Brightness], [Contrast], [Sharpness], [Gamma], [HDR range], [Color adjustment], [Advanced adjustment], [Light source mode] and [Brightness level].
- The image mode name which was the basis for the settings change is also saved in the user profile. When a user profile is selected as the image mode, the image mode that was the basis for that user profile is displayed in the menu as [Baseline image mode].

Brightness

 > [Image adjustment] > **[Brightness]**

Adjust image brightness.

Contrast

 > [Image adjustment] > **[Contrast]**

Sharpen or soften image contrast.

Sharpness

 > [Image adjustment] > **[Sharpness]**

Adjust image sharpness.

Gamma

 > [Image adjustment] > **[Gamma]**

Correct image areas that are too dark or too bright to see clearly.



For more detailed adjustment, use “Fine-Tune Gamma” (P124).

HDR range

 > [Image adjustment] > **[HDR range]**

Within the dynamic range of SMPTE ST 2084, set the range to use.

[Gamma] is not shown when the menu includes [HDR range].



[HDR range] can only be set in the following cases.

- Image mode (P118) is set to [Video] and HDR (P123) is [HDR10]
- Image mode (P118) is set to [Video], HDR (P123) is [Auto], and HDR10 signals are supplied
- When you adjust the HDR range, the screen switches to the new range setting after a few seconds.

Color adjustment

 > [Image adjustment] > **[Color adjustment]**

Adjust color-related settings such as color level, color balance, and color temperature.

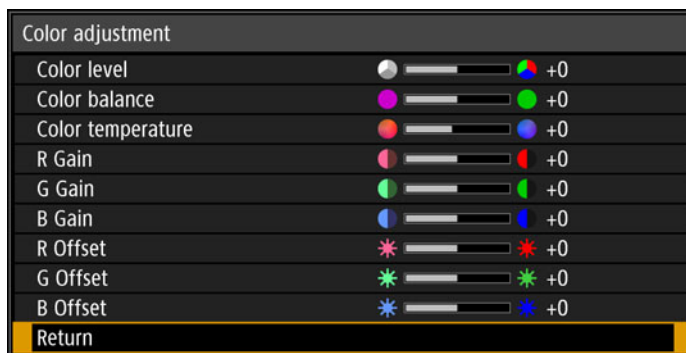

Submenu	Function
Color level	Adjusts the intensity of colors.
Color balance	Adjusts the color balance of a purplish or greenish image.
Color temperature	Adjusts the white color temperature.
R / G / B Gain	Adjust the gain of each color.
R / G / B Offset	Adjusts the color offset of each color.

Menu Description



In [DICOM SIM] image mode, [Color temperature] is not adjusted with numeric values but set to one of the following five presets.

Preset 1: Prioritize brightness, relative to DICOM Standard Part 14.

Preset 2: Prioritize color tone, relative to DICOM Standard Part 14.

Preset 3: Adjust color to conform to DICOM Standard Part 14.

Preset 4: Reproduce colors of X-ray film (Clear base).

Preset 5: Reproduce colors of X-ray film (Blue base).

Advanced adjustment



> [Image adjustment] > **[Advanced adjustment]**

Fine-tune noise reduction and color tone.

Advanced adjustment	
Random noise reduction	Off
Digital noise reduction	Off
Dynamic gamma	Off
Contrast detail adjustment	
Mem. color correct	
6-axis color adjust	Off
Fine-Tune Gamma	Off
Return	

Ambient light

Minimize the effect of ambient light on the screen.

Option	Function		
Off	Projects an image with no correction.		
Adjust	Type	Tungsten	For ambient light from conventional light bulbs or fluorescent light of this color.
		Fluorescent	For ambient light from a "day white" fluorescent source.
	Level	L	For an ordinary brightness of ambient light.
		H	For bright ambient light.

Examples of Ambient Light Level Settings

Level	Example Location
L	Projection room, sports bar, etc.
H	Conference room, lecture room, etc.



- This setting is available when the image mode is set to [Photo/sRGB] (P118).
- This setting is available when the baseline image mode is set to [Photo/sRGB].

Random noise reduction

Reduce random image noise*.

* Effective on noise with an irregular frequency or amplitude.

Option	Function
Off	Disables random noise reduction.
Low Middle High	Specify one of three levels of intensity of the random noise reduction.



Select [Low] for fast-moving images or [High] for slow-moving images.

Digital noise reduction

Reduce digital image noise. Note that compared to MPEG noise reduction, frame noise reduction improves gradation of projected images.

Option	Function
Off	Disables digital noise reduction.
MPEG-NR: Low MPEG-NR: Middle MPEG-NR: High Frame-NR: Low Frame-NR: Middle Frame-NR: High	Specify one of three levels of intensity of MPEG and frame noise reduction

Dynamic gamma

You can adjust the gradation representation of light and dark portions of an image automatically.

Option	Function
Off	Disable dynamic gamma adjustment.
Low Middle High	Specify one of three levels of dynamic gamma adjustment.

Contrast detail adjustment

When the projected image is dark, you can make the dark portions appear even darker by adjusting the luminance of the light source and the amount of signal adjustment. To use [Light off control], [Light off detection signal level], [Light off detection time], and [Light off speed], set [Dynamic contrast] to [High]. The above options are grayed out if another setting is selected.

Submenu	Function						
Dynamic contrast	Automatically increase the contrast as the input signal changes.						
	<table border="1"> <thead> <tr> <th>Option</th> <th>Function</th> </tr> </thead> <tbody> <tr> <td>Off</td> <td>Do not perform dynamic contrast adjustment.</td> </tr> <tr> <td>Low Middle High</td> <td>Specify one of three levels of dynamic contrast strength.</td> </tr> </tbody> </table>	Option	Function	Off	Do not perform dynamic contrast adjustment.	Low Middle High	Specify one of three levels of dynamic contrast strength.
	Option	Function					
Off	Do not perform dynamic contrast adjustment.						
Low Middle High	Specify one of three levels of dynamic contrast strength.						
Manual light adjustment	Adjust the brightness of the light source manually.						
Manual signal adjustment	Adjust the amount of signal processing adjustment manually.						
Light off control	Select whether to enable or disable the [Light off detection signal level], [Light off detection time], and [Light off speed] functions.						
	<table border="1"> <thead> <tr> <th>Option</th> <th>Function</th> </tr> </thead> <tbody> <tr> <td>Disabled</td> <td>Do not use [Light off detection signal level], [Light off detection time], and [Light off speed].</td> </tr> <tr> <td>Enabled</td> <td>Use [Light off detection signal level], [Light off detection time], and [Light off speed].</td> </tr> </tbody> </table>	Option	Function	Disabled	Do not use [Light off detection signal level], [Light off detection time], and [Light off speed].	Enabled	Use [Light off detection signal level], [Light off detection time], and [Light off speed].
	Option	Function					
Disabled	Do not use [Light off detection signal level], [Light off detection time], and [Light off speed].						
Enabled	Use [Light off detection signal level], [Light off detection time], and [Light off speed].						
Light off detection signal level	Specify the internal data level for determining light off.						
Light off detection time	Specify the judgement period in seconds for determining light off.						
Light off speed	Specify the speed of the light reduction process.						
	<table border="1"> <thead> <tr> <th>Option</th> <th>Function</th> </tr> </thead> <tbody> <tr> <td>Normal</td> <td>Turn light off instantly.</td> </tr> <tr> <td>Low speed</td> <td>Turn light off gradually.</td> </tr> </tbody> </table>	Option	Function	Normal	Turn light off instantly.	Low speed	Turn light off gradually.
	Option	Function					
Normal	Turn light off instantly.						
Low speed	Turn light off gradually.						

Colorimetry

Select the input color space.

Option	Function
Auto	Automatically determine the optimal color space (BT.709 or BT.2020) based on input signals.
BT.709	Forces use of the BT.709 color space.
BT.2020	Forces use of the BT.2020 color space.



[Colorimetry] can only be set when the image mode (P118) is [Video].

HDR (High Dynamic Range)

Projection conforms to HDR signals (HDR10 or HLG) with an expanded range of image luminance, preserving detail in highlights and shadows.

Option	Function
Auto	Automatically use HDR when HDR signals are supplied.
Off	Prevent use of HDR.
HDR10	Require HDR 10-compliant projection.
HLG	Require HLG-compliant projection.

 [HDR] can only be set when the image mode (P118) is [Video].



Mem. color correct

Enhances skin tones, blue skies, and greens, so that these colors are more consistent with people's remembered impressions.

Submenu	Function	
Flesh Sky Green	Off	Disable correction.
	Weak	Specify the level of correction.
	Middle Strong	

6-axis color adjust

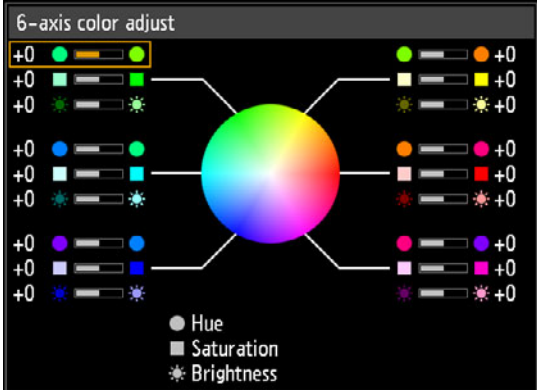
Fine-tune RGB (red, green, blue) and CMY (cyan, magenta, yellow) hues in images.

Option	Function
Off	Disables 6-axis color adjustment.
Adjust	 <p>Use the [▲] / [▼] buttons to select [○ Hue], [■ Saturation], or [☼ Brightness], and use the [◀] / [▶] buttons for adjustment.</p> <ul style="list-style-type: none"> When you are finished adjusting the color, press the OK button. <p> Adjustment is not applied to the projected menu itself.</p>
Reset	Reset the marker settings.

Fine-Tune Gamma

Adjust white, red, green, and blue gamma curves. Red, green, and blue can be adjusted separately. Adjustments to white are also applied to the three other colors. Note that adjusting any color will overwrite previous adjustments.

Use the [▲] / [▼] buttons to select a color, and then press the **OK** button.

Next use the [◀] / [▶] buttons to select a point on the gamma curve, and then use the [▲] / [▼] buttons to adjust the position of the point. When adjustment is finished, press the **OK** button to confirm the setting.

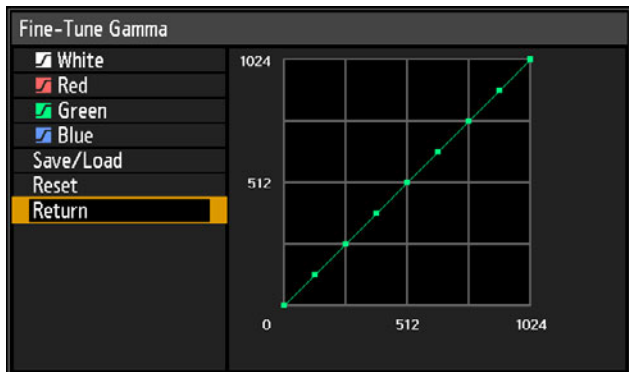

- [Fine-Tune Gamma] is available in image modes other than [DICOM SIM].
- [Fine-Tune Gamma] is available when HDR is set to [Off] or [Auto] and no HDR signals are supplied.
- For details on gamma correction, see “Gamma” (P119).
- Use input signals or a test pattern for adjustment.
- Adjustment is not applied to the projected menu itself.
- Up to five adjustment values can be saved.

Adjustment values can also be saved or loaded by selecting [Save/Load].

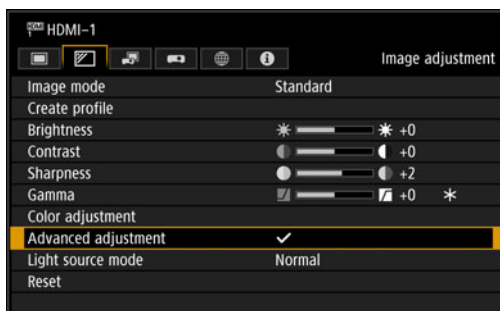
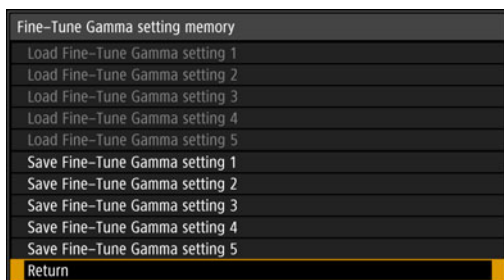



Selecting [Adjust] for Fine-Tune Gamma applies a check mark to the [Advanced adjustment] field at the top and adds an asterisk (*) to the adjustment value.

Light source mode

 > [Image adjustment] > **[Light source mode]**

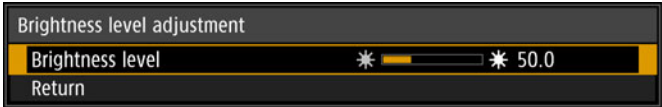
Reducing projection brightness reduces power consumption and fan noise.

Option	Function
Normal	Projects images at full brightness.
Quiet 1	Select to reduce brightness, or when quiet projection is required.
Quiet 2	Reduces brightness and noise further.
Adjust	<p>Fine-tune brightness. Fan speed is adjusted automatically based on your brightness adjustments. Use the [◀] / [▶] buttons to adjust the brightness on the Brightness level adjustment screen that appears.</p>  <p> [Brightness level] is shown when the light source mode is set to [Adjust].</p>

 [Light source mode] is displayed when the operating mode is [Normal]. If the operating mode (P133) is not set to [Normal], [Brightness level] appears instead of [Light source mode].

Brightness level

 > [Image adjustment] > **[Brightness level]**

Control the laser diode to adjust the projection brightness.

Use the [**◀**] / [**▶**] buttons to adjust the brightness.



 [Brightness level] appears instead of [Light source mode] when the operating mode (P133) is not set to [Normal].

Reset



> [Image adjustment] > **[Reset]**

Restore the current image quality settings to the factory defaults.

Option	Function
OK	Resets the image adjustment settings.
Cancel	Cancels resetting of the image adjustment settings.



- Performing reset when [Image mode] is set to a profile from [User 1] to [User 5] will restore the settings originally saved for that user profile.
- Only the setting for the combination of input signal and image mode for the current projection is reset.

Install settings

Adjust projection to suit the screen or the type of images, or how the projector is installed.

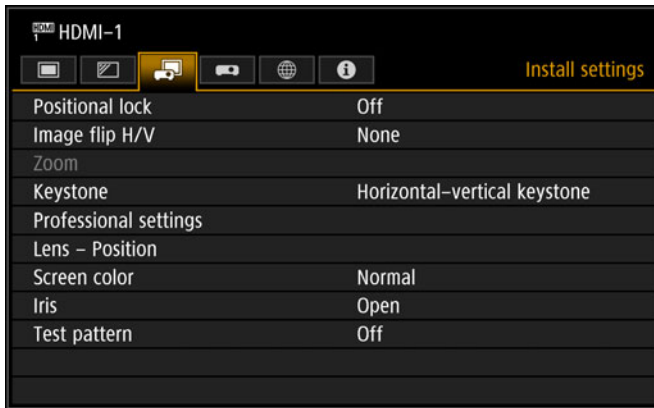

Menu screen when the input signal is HDMI-1

Menu	Function	Details
Positional lock	Operation of installation-related functions can be prohibited.	P128
Image flip H/V	Specify settings for projection from behind the screen, from the ceiling, or both.	P128
Zoom	Digitally reduce images when lenses not equipped with optical zoom are attached.	P128
Keystone	Set the type of keystone correction.	P129
Professional settings	Specify advanced installation settings.	P129
Lens - Position	Store information about the lens position (including focus, zoom, and lens shift settings), which can be used to restore the lens to these positions.	P137
Screen color	Adjust projection colors to suit the screen color.	P138
Iris	The aperture value can be adjusted manually. A smaller aperture reduces brightness but improves contrast.	P138
Test pattern	Project a test pattern to check the resolution and color of projection during installation.	P138

Menus that are not available are grayed out.

Positional lock

 > [Install settings] > **[Positional lock]**

Operation of installation-related functions can be prohibited.

- Image flip H/V
- Focus adjustment
- Lens shift reset
- Zoom adjustment
- Save position (in [Lens - Position])
- Lens shift adjustment
- Professional settings
- Zoom
- Keystone

Option	Function
Off	The positional lock is not used.
On	Prevents adjustment of installation-related functions.

Image flip H/V

 > [Install settings] > **[Image flip H/V]**

Specify the orientation of how the projector is installed.

Option	Function
None	Select for normal projection, without inversion.
Ceiling mounted	Select when the projector is installed upside-down on the ceiling. The projected image is inverted in both vertical and horizontal directions.
Rear	Select this to project an image from behind the screen. The projected image is inverted in the horizontal direction.
Rear, Ceiling mounted	Select this to project an image from behind the screen with the projector hung from the ceiling. The projected image is inverted in the vertical direction.





- When mounting the projector on a ceiling, use the optional ceiling attachment (RS-CL15) and ceiling-mount arm (RS-CL17). Contact the Canon Customer Support Center for more detailed information.
- Image flipping will reset any adjustment for keystone distortion. In this case, redo the adjustment.
- Adjusting the [Image flip H/V] setting does not alter button assignments in the projector's side controls.

Zoom

 > [Install settings] > **[Zoom]**

When lenses not equipped with optical zoom are attached and if projected images do not fit on the screen, you can display the image by electronically reducing its size. This type of zooming reduces overall image dimensions, relative to the center of the image.

Press the [<>] button on the remote control to project images at a reduced size, and press the [>] button to enlarge images to full size. Images can be projected at 75 – 100% of the original size.



- **D.ZOOM** buttons on the remote control cannot be used for this [Zoom] function.
- [Zoom] is not available unless [Keystone] is set to [Off].
- [Zoom] is canceled if, after setting up [Zoom], you change the [Keystone] setting to an option other than [Off].
- Switching to lenses equipped with optical zoom will reset the setting to 100%.

Keystone



> [Install settings] > **[Keystone]**

Two types of keystone correction are available: horizontal/vertical keystone and corner adjustment. Keystone correction can also be reset. Keystone correction can also be applied by pressing the **KEYSTONE** button on the remote control. (P81 – P84)

Submenu	Function
Off	Disables keystone correction.
Horizontal-vertical keystone	Apply horizontal-vertical keystone correction. Image height and length is adjusted.
Corner adjustment	Apply corner adjustment. Each corner of the image can be repositioned.
Reset	Resets the specified keystone value.



The available horizontal-vertical keystone range may vary depending on the lens, lens zoom position, and shift position.

Professional settings



> [Install settings] > **[Professional settings]**

Specify advanced installation settings.

Professional settings	
EDID mode setting	
RGB alignment	
Partial distortion correction	Off
High altitude	Off
Operating mode	Normal
Lens shift mode	Normal
Marginal focus	Off
Edge blending	Off
Return	

Menu screen when the Ultra-wide Zoom Lens (RS-SL06UW) or Standard 4K Zoom Lens (RS-SL07RST) is attached

EDID mode setting

Switch to a mode for compatible signals, as registered in the HDMI-1 or HDMI-2 EDID.

Submenu	Function	
HDMI-1 EDID mode	Option	Function
	Wide bandwidth (4K60Hz)	Wide-bandwidth 9–18 Gbps signals (such as 8-bit 4K YCbCr 4:4:4 at 60 Hz or 10-bit 4K YCbCr 4:4:4 at 24 Hz) are registered in the EDID.
HDMI-2 EDID mode	High compatibility	Select in case of incorrect video or audio output when set to [Wide bandwidth].

RGB alignment

Correct color misalignment.

Submenu	Function	
Micro-digital image shift	Enables adjustment of misalignment in 1-pixel increments.	
	Submenu	Function
	Off	Does not perform micro digital image shift.
	Adjust	Submenu
Adjust		Use the [▲] / [▼] buttons for vertical shift and the [◀] / [▶] buttons for horizontal shift.
Chart		Displays a chart to assist in adjustment. Watch the chart as you fine-tune the position.
Registration	Color misalignment affecting the entire image can be corrected by moving red, green, or blue components into position, in 1-pixel increments.	
	Submenu	Function
	Off	Does not perform image registration.
	Adjust	Submenu
Red / Green / Blue		Use the [▲] / [▼] buttons for vertical shift and the [◀] / [▶] buttons for horizontal shift.
Chart		Displays a chart to assist in adjustment. Watch the chart as you fine-tune the position.



Audio is muted while the chart is shown.

Submenu	Function				
Advanced registration	Sub-menu	Function			
	Off	Disable local correction of color misalignment.			
	Adjust	Display a menu for local correction of color misalignment.			
		Sub-menu	Function		
		5-point adjustment	Sub-menu	Function	
			Off	Disable adjustment.	
			Adjust	Enter 5-point adjustment mode (in screen corners and at the center).	
				Red / Blue	Use the [▲] / [▼] buttons for vertical alignment and the [◀] / [▶] buttons for horizontal alignment.
				Chart	Displays a chart to assist in adjustment. Watch the chart as you fine-tune the position.
			Manual adjustment	Precise adjustment based on 54 points (in a 6 x 9 grid).	
Sub-menu				Function	
Red / Green / Blue				Use the [▲] / [▼] buttons for vertical alignment and the [◀] / [▶] buttons for horizontal alignment.	
Chart	Displays a chart to assist in adjustment. Watch the chart as you fine-tune the position.				
Reset	Restore the original position, before adjustment.				

Submenu	Function
Advanced registration	 <ul style="list-style-type: none"> • With advanced registration, checkered or halftone image areas may be affected by uneven colors or image artifacts. • 5-point adjustment enables basic correction of color misalignment across the screen, by moving adjustment points in the center and each corner. To correct registration only in certain areas, try manual adjustment. • Any values you set in 5-point adjustment are retained if you subsequently perform manual adjustment. For more precise correction after 5-point adjustment, perform manual adjustment. • Any manual adjustment values you set before switching to 5-point adjustment are cleared. • [Advanced registration] setting values are not cleared if you switch lenses. However, on startup after you switch lenses, a message is displayed requesting you to confirm advanced registration settings if, for any adjustment point, [Advanced registration] setting values differ from defaults. <div data-bbox="498 751 1094 1045" style="border: 1px solid black; padding: 10px; background-color: #333; color: white; text-align: center;"> <p>Confirm advanced registration</p> <p>Attached projection lens is not the same as before. Confirm advanced registration setting. Select "Yes", this message will no longer be displayed.</p> <p>Yes No</p> </div>

Partial distortion correction

Precise correction of partial distortion of projected images based on 54 points (in a 6 × 9 grid). For detailed instructions, refer to “Adjusting Projected Images with Partial Distortion Correction” (P89).

Option	Function	
Off	Disables partial distortion correction.	
Adjust	Submenu	Function
	Adjust	Using an adjustment point selected with the [▲] / [▼] / [◀] / [▶] buttons, press the [▲] / [▼] / [◀] / [▶] buttons to align vertically and horizontally.
Chart	Displays a chart to assist in adjustment. Watch the chart as you fine-tune the position.	
Reset	Reset the marker settings.	



With partial distortion correction, checkered or halftone image areas may be affected by image artifacts.

High altitude

Switch the fan mode to suit installation at low or high altitudes (above 2,300 m [7,545.8']).

Option	Function
Off	Setting for altitudes lower than 2,300 m (7,545.8').
On	Setting for altitudes of 2,300 m (7,545.8') or higher.



Incorrect settings may shorten the useful life of the projector components.

Operating mode

Switch the method of controlling the light source and fan.

Option	Function
Normal	Normal drive mode. Brightness will decrease with time.
Fixed brightness	Maintains nearly the same brightness set at installation. Laser diode wear is detected by a sensor, and current is increased to compensate for wear.
Long duration 1	Enables a relatively longer useful life of optical parts by reducing the brightness level of the light source mode and regulating the fan drive.
Long duration 2	Enables an even longer useful life of optical parts by further reducing the brightness level of the light source mode and more aggressively regulating the fan drive.



When using the projector continuously for 24 hours or more, or when turning the projector off by unplugging it, execute light source calibration using one of the settings below. If calibration is not executed, the projector will be unable to maintain fixed brightness.

- Periodically specify [OK] in [Light source calibration] in [Calibration] (P155).
- Specify CALIBRATION in [Schedule] (P152).

Lens shift mode

Switch the available lens shift range as needed.

Option	Function
Normal	Provides a normal lens shift range.
Expanded	Provides an expanded lens shift range.



- Selecting [Expanded] may lower image quality and keystone correction precision, depending on the extent of lens shift.
- Selecting [Normal] when the lens is in the expanded range (outside the normal position) will execute lens shift reset (P137).

Marginal focus

In dome projection, image focus can be adjusted on the edges of the screen, and the remote control can be used to activate and deactivate this focus adjustment. For detailed instructions, refer to “Adjusting Peripheral Focus” (P93).

Option	Function
Off	Disable remote focusing of image edges.
On	Enable remote focusing of image edges. To access the adjustment window, press the LENS button on the projector twice or press the FOCUS button on the remote twice.
Reset	Restore edge focusing to the standard position.



- The marginal focus feature is not available depending on the type of lens installed.
- Setting this function to [Off] only prevents display of the adjustment window. Adjustment values are still retained. Use this setting to prevent remote focusing of image edges.

Edge blending

Brightness and colors of overlapping edges of images from multiple projectors, which form a blending area, can be adjusted for a more seamless appearance. For detailed instructions, see “Projecting from Multiple Projectors at Once (Edge Blending)” (P96).

Option	Function
Off	Disable blending.
Adjust	Display the menu for blending area adjustment.

Edge blending		
Side	Width	Start position
Left	0	0
Right	0	0
Top	0	0
Bottom	0	0
Color blending adjustment	Off	
Black level adjustment	Off	
Marker	Off	
Reset		
Return		

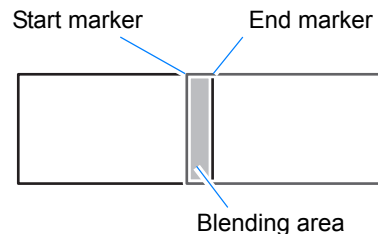

When adjusting the image projected from the right side



- Adjustment may not eliminate different colors or brightnesses in the blending area.
- For best edge-blending results, use all projectors in the same image mode and make the following adjustments.
 - (1) Brightness, contrast, R/G/B gain and offset, black level, blending color, color temperature, color level, color balance, sharpness, and gamma (P119)
 - (2) Color adjustment, by using 6-axis color adjustment (P123)
 - (3) Gamma adjustment, by using fine-tune gamma (P124)
 - (4) Corner adjustment, by using keystone correction (P129)

Submenu	Function													
Side	Left / Right / Top / Bottom Select the direction of the blending area to adjust.													
	Width Specify the width between the start and end markers.													
	Start position Moves the position of the start marker. <div style="border: 1px solid gray; padding: 5px; margin-top: 10px;">  <ul style="list-style-type: none"> Large blending areas may cover input signal dialog boxes and other interface elements. In this case, momentarily set edge blending to [Off] and check the display. Although the starting marker is normally aligned with the image edge, it can also be aligned toward the center of the image. In this case, the black blending area will lie outside of the starting marker. </div>													
Color blending adjustment	Adjust unwanted colors or discrepancies between colors in the blending area.													
	<table border="1"> <thead> <tr> <th>Submenu</th> <th>Function</th> </tr> </thead> <tbody> <tr> <td>Off</td> <td>Do not adjust colors of blended images.</td> </tr> <tr> <td rowspan="3">Adjust</td> <td>Adjust unwanted colors or discrepancies between colors in the blending area.</td> </tr> <tr> <td> <table border="1"> <thead> <tr> <th>Option</th> <th>Function</th> </tr> </thead> <tbody> <tr> <td>White</td> <td>Simultaneously adjust red, green, and blue to correct unwanted colors or discrepancies in the blending area.</td> </tr> <tr> <td>Red / Green / Blue</td> <td>Individually adjust red, green, and blue to correct unwanted colors or discrepancies in the blending area.</td> </tr> </tbody> </table> </td> </tr> </tbody> </table>	Submenu	Function	Off	Do not adjust colors of blended images.	Adjust	Adjust unwanted colors or discrepancies between colors in the blending area.	<table border="1"> <thead> <tr> <th>Option</th> <th>Function</th> </tr> </thead> <tbody> <tr> <td>White</td> <td>Simultaneously adjust red, green, and blue to correct unwanted colors or discrepancies in the blending area.</td> </tr> <tr> <td>Red / Green / Blue</td> <td>Individually adjust red, green, and blue to correct unwanted colors or discrepancies in the blending area.</td> </tr> </tbody> </table>	Option	Function	White	Simultaneously adjust red, green, and blue to correct unwanted colors or discrepancies in the blending area.	Red / Green / Blue	Individually adjust red, green, and blue to correct unwanted colors or discrepancies in the blending area.
	Submenu	Function												
	Off	Do not adjust colors of blended images.												
Adjust	Adjust unwanted colors or discrepancies between colors in the blending area.													
	<table border="1"> <thead> <tr> <th>Option</th> <th>Function</th> </tr> </thead> <tbody> <tr> <td>White</td> <td>Simultaneously adjust red, green, and blue to correct unwanted colors or discrepancies in the blending area.</td> </tr> <tr> <td>Red / Green / Blue</td> <td>Individually adjust red, green, and blue to correct unwanted colors or discrepancies in the blending area.</td> </tr> </tbody> </table>	Option	Function	White	Simultaneously adjust red, green, and blue to correct unwanted colors or discrepancies in the blending area.	Red / Green / Blue	Individually adjust red, green, and blue to correct unwanted colors or discrepancies in the blending area.							
	Option	Function												
White	Simultaneously adjust red, green, and blue to correct unwanted colors or discrepancies in the blending area.													
Red / Green / Blue	Individually adjust red, green, and blue to correct unwanted colors or discrepancies in the blending area.													

Menu Description

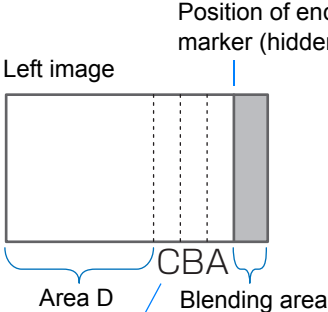
Submenu	Function																						
Black level adjustment	<p>Because black is lighter in the blending area than in other areas, you can adjust the black level outside the blending area to make this difference in brightness less noticeable.</p>  <p>Area A: Black level cannot be adjusted. Area B: Adjust to a black level different from that of area D. Area C: Adjust to provide a smooth transition relative to the black levels of areas B and D.</p> <p>Areas C - A (default: 0)</p>																						
	<table border="1"> <thead> <tr> <th data-bbox="408 705 500 753">Option</th> <th data-bbox="500 705 1201 753">Function</th> </tr> </thead> <tbody> <tr> <td data-bbox="408 753 500 801">Off</td> <td data-bbox="500 753 1201 801">Do not adjust the black level.</td> </tr> </tbody> </table>	Option	Function	Off	Do not adjust the black level.																		
	Option	Function																					
Off	Do not adjust the black level.																						
<table border="1"> <thead> <tr> <th data-bbox="408 801 500 898" rowspan="3">Adjust</th> <th data-bbox="500 801 610 898">Sub-menu</th> <th data-bbox="610 801 1201 898">Function</th> </tr> </thead> <tbody> <tr> <td data-bbox="500 898 610 1284">Adjustment type</td> <td data-bbox="610 898 1201 1284"> <table border="1"> <thead> <tr> <th data-bbox="610 898 706 956">Option</th> <th data-bbox="706 898 1201 956">Function</th> </tr> </thead> <tbody> <tr> <td data-bbox="610 956 706 1284">Area</td> <td data-bbox="706 956 1201 1284"> <p>Adjust areas C - A to smoothen the boundaries of the blending area.</p> <table border="1"> <thead> <tr> <th data-bbox="720 1033 843 1072">Option</th> <th data-bbox="843 1033 1201 1072">Function</th> </tr> </thead> <tbody> <tr> <td data-bbox="720 1072 843 1168">Side</td> <td data-bbox="843 1072 1201 1168">Select the direction to adjust from Left / Right / Top / Bottom.</td> </tr> <tr> <td data-bbox="720 1168 843 1284">A-Width / B-Width / C-Width</td> <td data-bbox="843 1168 1201 1284">Adjust the widths of areas A - C.</td> </tr> </tbody> </table> </td> </tr> <tr> <td data-bbox="610 1284 706 1661">Black level</td> <td data-bbox="706 1284 1201 1661"> <p>Adjust the black level brightness and color of areas B and D.</p> <table border="1"> <thead> <tr> <th data-bbox="720 1362 843 1400">Option</th> <th data-bbox="843 1362 1201 1400">Function</th> </tr> </thead> <tbody> <tr> <td data-bbox="720 1400 843 1477">B/D-area base</td> <td data-bbox="843 1400 1201 1477">Adjust the black level brightness of B/D areas.</td> </tr> <tr> <td data-bbox="720 1477 843 1661">B/D-area red / green / blue</td> <td data-bbox="843 1477 1201 1661">Adjust the red, green, and blue components of B/D area black levels individually.</td> </tr> </tbody> </table> </td> </tr> </tbody> </table> </td> </tr> </tbody> </table>	Adjust	Sub-menu	Function	Adjustment type	<table border="1"> <thead> <tr> <th data-bbox="610 898 706 956">Option</th> <th data-bbox="706 898 1201 956">Function</th> </tr> </thead> <tbody> <tr> <td data-bbox="610 956 706 1284">Area</td> <td data-bbox="706 956 1201 1284"> <p>Adjust areas C - A to smoothen the boundaries of the blending area.</p> <table border="1"> <thead> <tr> <th data-bbox="720 1033 843 1072">Option</th> <th data-bbox="843 1033 1201 1072">Function</th> </tr> </thead> <tbody> <tr> <td data-bbox="720 1072 843 1168">Side</td> <td data-bbox="843 1072 1201 1168">Select the direction to adjust from Left / Right / Top / Bottom.</td> </tr> <tr> <td data-bbox="720 1168 843 1284">A-Width / B-Width / C-Width</td> <td data-bbox="843 1168 1201 1284">Adjust the widths of areas A - C.</td> </tr> </tbody> </table> </td> </tr> <tr> <td data-bbox="610 1284 706 1661">Black level</td> <td data-bbox="706 1284 1201 1661"> <p>Adjust the black level brightness and color of areas B and D.</p> <table border="1"> <thead> <tr> <th data-bbox="720 1362 843 1400">Option</th> <th data-bbox="843 1362 1201 1400">Function</th> </tr> </thead> <tbody> <tr> <td data-bbox="720 1400 843 1477">B/D-area base</td> <td data-bbox="843 1400 1201 1477">Adjust the black level brightness of B/D areas.</td> </tr> <tr> <td data-bbox="720 1477 843 1661">B/D-area red / green / blue</td> <td data-bbox="843 1477 1201 1661">Adjust the red, green, and blue components of B/D area black levels individually.</td> </tr> </tbody> </table> </td> </tr> </tbody> </table>	Option	Function	Area	<p>Adjust areas C - A to smoothen the boundaries of the blending area.</p> <table border="1"> <thead> <tr> <th data-bbox="720 1033 843 1072">Option</th> <th data-bbox="843 1033 1201 1072">Function</th> </tr> </thead> <tbody> <tr> <td data-bbox="720 1072 843 1168">Side</td> <td data-bbox="843 1072 1201 1168">Select the direction to adjust from Left / Right / Top / Bottom.</td> </tr> <tr> <td data-bbox="720 1168 843 1284">A-Width / B-Width / C-Width</td> <td data-bbox="843 1168 1201 1284">Adjust the widths of areas A - C.</td> </tr> </tbody> </table>	Option	Function	Side	Select the direction to adjust from Left / Right / Top / Bottom.	A-Width / B-Width / C-Width	Adjust the widths of areas A - C.	Black level	<p>Adjust the black level brightness and color of areas B and D.</p> <table border="1"> <thead> <tr> <th data-bbox="720 1362 843 1400">Option</th> <th data-bbox="843 1362 1201 1400">Function</th> </tr> </thead> <tbody> <tr> <td data-bbox="720 1400 843 1477">B/D-area base</td> <td data-bbox="843 1400 1201 1477">Adjust the black level brightness of B/D areas.</td> </tr> <tr> <td data-bbox="720 1477 843 1661">B/D-area red / green / blue</td> <td data-bbox="843 1477 1201 1661">Adjust the red, green, and blue components of B/D area black levels individually.</td> </tr> </tbody> </table>	Option	Function	B/D-area base	Adjust the black level brightness of B/D areas.	B/D-area red / green / blue	Adjust the red, green, and blue components of B/D area black levels individually.
Adjust		Sub-menu	Function																				
		Adjustment type	<table border="1"> <thead> <tr> <th data-bbox="610 898 706 956">Option</th> <th data-bbox="706 898 1201 956">Function</th> </tr> </thead> <tbody> <tr> <td data-bbox="610 956 706 1284">Area</td> <td data-bbox="706 956 1201 1284"> <p>Adjust areas C - A to smoothen the boundaries of the blending area.</p> <table border="1"> <thead> <tr> <th data-bbox="720 1033 843 1072">Option</th> <th data-bbox="843 1033 1201 1072">Function</th> </tr> </thead> <tbody> <tr> <td data-bbox="720 1072 843 1168">Side</td> <td data-bbox="843 1072 1201 1168">Select the direction to adjust from Left / Right / Top / Bottom.</td> </tr> <tr> <td data-bbox="720 1168 843 1284">A-Width / B-Width / C-Width</td> <td data-bbox="843 1168 1201 1284">Adjust the widths of areas A - C.</td> </tr> </tbody> </table> </td> </tr> <tr> <td data-bbox="610 1284 706 1661">Black level</td> <td data-bbox="706 1284 1201 1661"> <p>Adjust the black level brightness and color of areas B and D.</p> <table border="1"> <thead> <tr> <th data-bbox="720 1362 843 1400">Option</th> <th data-bbox="843 1362 1201 1400">Function</th> </tr> </thead> <tbody> <tr> <td data-bbox="720 1400 843 1477">B/D-area base</td> <td data-bbox="843 1400 1201 1477">Adjust the black level brightness of B/D areas.</td> </tr> <tr> <td data-bbox="720 1477 843 1661">B/D-area red / green / blue</td> <td data-bbox="843 1477 1201 1661">Adjust the red, green, and blue components of B/D area black levels individually.</td> </tr> </tbody> </table> </td> </tr> </tbody> </table>	Option	Function	Area	<p>Adjust areas C - A to smoothen the boundaries of the blending area.</p> <table border="1"> <thead> <tr> <th data-bbox="720 1033 843 1072">Option</th> <th data-bbox="843 1033 1201 1072">Function</th> </tr> </thead> <tbody> <tr> <td data-bbox="720 1072 843 1168">Side</td> <td data-bbox="843 1072 1201 1168">Select the direction to adjust from Left / Right / Top / Bottom.</td> </tr> <tr> <td data-bbox="720 1168 843 1284">A-Width / B-Width / C-Width</td> <td data-bbox="843 1168 1201 1284">Adjust the widths of areas A - C.</td> </tr> </tbody> </table>	Option	Function	Side	Select the direction to adjust from Left / Right / Top / Bottom.	A-Width / B-Width / C-Width	Adjust the widths of areas A - C.	Black level	<p>Adjust the black level brightness and color of areas B and D.</p> <table border="1"> <thead> <tr> <th data-bbox="720 1362 843 1400">Option</th> <th data-bbox="843 1362 1201 1400">Function</th> </tr> </thead> <tbody> <tr> <td data-bbox="720 1400 843 1477">B/D-area base</td> <td data-bbox="843 1400 1201 1477">Adjust the black level brightness of B/D areas.</td> </tr> <tr> <td data-bbox="720 1477 843 1661">B/D-area red / green / blue</td> <td data-bbox="843 1477 1201 1661">Adjust the red, green, and blue components of B/D area black levels individually.</td> </tr> </tbody> </table>	Option	Function	B/D-area base	Adjust the black level brightness of B/D areas.	B/D-area red / green / blue	Adjust the red, green, and blue components of B/D area black levels individually.		
	Option	Function																					
Area	<p>Adjust areas C - A to smoothen the boundaries of the blending area.</p> <table border="1"> <thead> <tr> <th data-bbox="720 1033 843 1072">Option</th> <th data-bbox="843 1033 1201 1072">Function</th> </tr> </thead> <tbody> <tr> <td data-bbox="720 1072 843 1168">Side</td> <td data-bbox="843 1072 1201 1168">Select the direction to adjust from Left / Right / Top / Bottom.</td> </tr> <tr> <td data-bbox="720 1168 843 1284">A-Width / B-Width / C-Width</td> <td data-bbox="843 1168 1201 1284">Adjust the widths of areas A - C.</td> </tr> </tbody> </table>	Option	Function	Side	Select the direction to adjust from Left / Right / Top / Bottom.	A-Width / B-Width / C-Width	Adjust the widths of areas A - C.																
Option	Function																						
Side	Select the direction to adjust from Left / Right / Top / Bottom.																						
A-Width / B-Width / C-Width	Adjust the widths of areas A - C.																						
Black level	<p>Adjust the black level brightness and color of areas B and D.</p> <table border="1"> <thead> <tr> <th data-bbox="720 1362 843 1400">Option</th> <th data-bbox="843 1362 1201 1400">Function</th> </tr> </thead> <tbody> <tr> <td data-bbox="720 1400 843 1477">B/D-area base</td> <td data-bbox="843 1400 1201 1477">Adjust the black level brightness of B/D areas.</td> </tr> <tr> <td data-bbox="720 1477 843 1661">B/D-area red / green / blue</td> <td data-bbox="843 1477 1201 1661">Adjust the red, green, and blue components of B/D area black levels individually.</td> </tr> </tbody> </table>	Option	Function	B/D-area base	Adjust the black level brightness of B/D areas.	B/D-area red / green / blue	Adjust the red, green, and blue components of B/D area black levels individually.																
Option	Function																						
B/D-area base	Adjust the black level brightness of B/D areas.																						
B/D-area red / green / blue	Adjust the red, green, and blue components of B/D area black levels individually.																						

Submenu	Function						
Marker	Show the blending area markers.						
	<table border="1"> <thead> <tr> <th>Option</th> <th>Function</th> </tr> </thead> <tbody> <tr> <td>Off</td> <td>Hide the blending area markers.</td> </tr> <tr> <td>On</td> <td>Show the blending area markers. The start marker is red, and the end marker is green.</td> </tr> </tbody> </table>	Option	Function	Off	Hide the blending area markers.	On	Show the blending area markers. The start marker is red, and the end marker is green.
	Option	Function					
Off	Hide the blending area markers.						
On	Show the blending area markers. The start marker is red, and the end marker is green.						
Reset	Reset the marker settings.						

Lens - Position



> [Install settings] > **[Lens - Position]**

The projector can save information about the lens position in memory. Up to three sets of lens information (including focus, zoom, and lens shift settings) can be saved, and the lens can be restored to these positions.

Submenu	Function
Load position 1 – 3	Restores the lens to the positions saved using Save position 1 – 3.
Save position 1 – 3	Saves the lens position as Save position1 – 3.
Lens shift reset	Restores the lens to the preset position. <ul style="list-style-type: none"> • The preset position differs depending on the type of lens. • The preset position also changes when the orientation of the projector is changed, due to the ceiling mounted setting, etc. Example: [+50%, 0%] > [-50%, 0%]



- To lock (protect) the saved position, set [Positional lock] (P128) to [On].
- The values of the following settings are saved in addition to the lens position information (including focus, zoom, and lens shift settings):
 - Horizontal-vertical keystone / Corner adjustment
 - Screen color
 - Zoom
- [Load position] is not available unless you perform [Save position] once.
- The original lens position varies depending on the type of lens used.
- When saved lens positions are restored, images may be projected in a slightly different position than the saved position.
- Specifying a somewhat smaller image size than the screen size (image area) enables you to switch among multiple lens positions without having the image extend off the screen.
- When precise positioning is needed, use lens shift, zoom, and focus functions for fine adjustment.

Screen color

 > [Install settings] > **[Screen color]**

You can adjust the color quality of the images projected according to the color of the projection screen.

Submenu	Function
Normal	Select this if a standard type of projection screen is used. The images are projected in a light quality similar to that of natural light.
Greenboard	Select if a dark green surface such as a blackboard is used as the screen. The color quality similar to [Normal] is obtained on the greenboard.
Adjust	Select to fine-tune red, green and blue.

Iris

 > [Install settings] > **[Iris]**

Use this feature for projection emphasizing contrast over brightness.

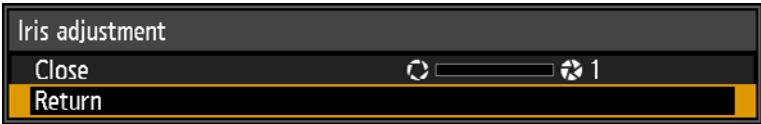
Submenu	Function
Open	Disables aperture adjustment.
Adjust	Specify the aperture value manually. 



The [Iris] setting does not affect power consumption.

Test pattern

 > [Install settings] > **[Test pattern]**

You can project a test pattern (P92) to check resolution, color, and other details even without supplying an input signal. Also available by pressing the **TEST PATTERN** button on the remote control.

Option	Function
Off	Disable test pattern display.
On	Enable test pattern display.



- While the test pattern menu is displayed, you can use the [▲] / [▼] buttons to switch patterns. Additionally, options of test pattern that have options can be changed with the [◀] / [▶] buttons.
- The test pattern menu is no longer displayed after a little while, but you can view it again by pressing the [▲] / [▼] buttons.

System settings

Customize projector and remote control operation, beeping, and other details after startup, during standby, and in other situations.



Menu screen when the input signal is HDMI-1

Menu	Function	Details
User screen settings	Customize user screens shown at startup, when no signal is detected, and in other situations.	P140
On screen	Set the display position and whether to show or hide menus, help information, and warning or caution icons.	P141
Remote control/Side control	Specify operation with remote control or projector buttons.	P143
Audio in terminal select	Select the terminal for audio input.	P145
HDBaseT signal quality	Display the video signal quality of HDBaseT input.	P146
Communication settings	Configure Extron XTP and serial communication settings.	P146
Power supply settings	Specify how power is managed at startup, in standby, and when no signal is supplied.	P147
Motion blur reduction	Motion blur is blurring that occurs during video playback. Motion blur reduction can make this blurring less noticeable.	P149
Language	You can select the language in which the menus are displayed.	P149
Other settings	Set a password, check the air filter replacement timing, and access other settings and information.	P150

Menus that are not available are grayed out or hidden.

User screen settings

 > [System settings] > [User screen settings]

Capture a logo and specify logo display settings.

User screen settings	
Logo capture	
Logo position	Center
No signal screen	Blue
Screen when blank	Black
Projector on	Canon logo
Return	

Logo capture

Registers the current image as a user logo. Registered user logos can be shown when no signal is received, when the **BLANK** button is pressed, or as the startup image.

Option	Function
OK	Display the image for logo registration. Align the image with the red boundary lines indicating the portion that will be stored, and then press the OK button. The portion of the image within the boundary lines is now registered.
Cancel	Cancels logo registration.

Logo position

Specify the position of registered user logos.

You can specify the position after a logo has been registered. Choose from upper left, upper right, center, lower left, or lower right.

No signal screen

Customize the screen shown when no input signals are received.

Option	Function
Black	The screen is all black.
Blue	The screen is all blue.
User logo	The user logo is projected.

Screen when blank

Select the screen shown when projection is temporarily blanked out by pressing the **BLANK** button on the remote control.

Option	Function
Black	The screen is all black.
Blue	The screen is all blue.
Light source off	The light source is turned off.
User logo	The user logo is projected.

Projector on

Select a logo to project after startup until input signals can be projected.

Option	Function
Skip	A black screen is projected.
Canon logo	Displays the Canon logo that was registered in advance at the factory.
User logo	The user logo is projected.

On screen



> [System settings] > [On screen]

Specify display details for on-screen menus, help, and warning or precaution icons.

On screen	
Menu position	Center
Menu display time	Normal
Menu rotation	None
Guide	On
Show input status	On
Air filter warning display	On
Overheat warning display	Off
Return	

Menu position

Reposition menu display.

Choose from upper left, upper right, center, lower left, or lower right.



Only [Center] is available when edge blending is used. Other display positions are grayed out and not available.

Menu display time

Extend menu display from the standard 10 or 30 seconds to 3 minutes.

Option	Function
Normal	The menu is displayed for 10 or 30 seconds.
Extended	The menu is displayed for 3 minutes.

Menu Description

The following display times are also changed.

Item	[Normal]	[Extended]
- Menu screen - Edge blending (P134)	30 seconds	3 minutes
- Input (P42) - Keystone (P81) - Keystone reset (P84) - Focus (P43) - Zoom (P43) - Lens shift (P58) - Lens shift reset (P60) - Marginal focus (P93) - Aspect (P113) - Image mode (P118) - Volume (P29, P34) - Gamma (P119)	10 seconds	3 minutes

Menu rotation

Rotate menu display. When projecting in portrait orientation, for example, with the projector installed at a 90° angle, specify the orientation of projected menus to align them with the top or bottom of projected images.

Option	Function
Auto	Automatically rotates menus as needed after using an accelerometer to determine if the projector is installed in portrait orientation (90° clockwise or counterclockwise) or horizontally.
Off	Menus are not rotated. Menus are shown in a readable orientation for projectors installed horizontally.
90 degrees counterclockwise	Menus are rotated 90°. Menus are shown in a readable orientation for projectors installed in portrait orientation (90° clockwise or counterclockwise).
90 degrees clockwise	



- To determine the orientation of menu rotation, projector orientation is detected immediately after startup or when this setting is switched to [Auto].
- Menus are not rotated automatically in response to changes in projector orientation during projection.

Guide

Shows the guide screen.

Option	Function
Off	Hides the guide screen.
On	Shows the guide screen.



- The guide screen is shown at the following cases.
- No input signal is detected.
 - An invalid button is pressed in [BLANK] or [FREEZE] mode (P33).
 - When positional lock (P128) is set to [On] and buttons locked by this feature are pressed.

Show input status

Specify whether signal status is shown when there is no signal or when you are completing signal settings.

Option	Function
Off	The input status is not displayed.
On	The input status is displayed.

Air filter warning display

Shows a warning to replace the air filter when replacement is required.

Option	Function
Off	The air filter warning is not displayed.
On	The air filter warning is displayed.



Setting [Air filter warning display] to [Off] will disable display of the warning to replace the air filter. We recommend checking the air filter counter (P156) occasionally to know when to replace the filter.

Overheat warning display

Specify whether the icon warning of high temperature (🔥) is shown when the internal temperature is high and the projector may overheat.

Option	Function
Off	Disable high temperature warning icon display.
On	Enable high temperature warning icon display.

Remote control/Side control



> [System settings] > [Remote control/Side control]

Specify which operations are available using buttons on the remote control or in the projector's side controls.

Remote control/Side control	
Beep	On
Key repeat	On
Key lock	Off
IR receiver settings	All
Remote control channel	Independent
[INPUT A-C] button settings	
Return	

Beep

You can select whether a beep sounds or not when you operate the projector.

Option	Function
Off	Disables the beep.
On	Enables the beep.



The beep will not sound if you mute the projector sound with the **MUTE** button on the remote control.

Key repeat

Key repeat enables projector or remote control buttons to be held down instead of pressing them repeatedly.

Option	Function
Off	Key repeat is not enabled.
On	Key repeat is enabled.

Key lock

Lock the projector or remote (wireless) to prevent operation.

Option	Function
Off	Disables key lock. Operation is possible on the projector or from the remote control.
Main unit	Operation is not possible using the projector. Use the remote control.
Remote (wireless)	Disables infrared remote control operations (P36). Use buttons on the projector. Operation is also possible with an optional wired remote control (RS-RC05).

To Unlock Key Lock Function

Turn off the projector and unplug the power plug. Hold down the **OK** button on the projector and plug in the power cord, as you continue to hold down the **OK** button. In a moment, a beep will sound, and the controls will be unlocked.



When you access this setting from the projector's side controls, [Main unit] is not available. Similarly, when you access the setting from the remote control, [Remote (wireless)] is not available.

IR receiver settings

Select the infrared receiver of the projector.

Option	Function
All	Use both the front and the rear receivers on the projector.
Front	Use the front receiver on the projector.
Rear	Use the rear receiver on the projector.

Remote control channel

Separate channels can be assigned to up to four projectors so that a single remote control can be used with each projector.

Selecting the Projector Channel

If a wired remote control is used, there is no need to set the remote control channel.

Option	Function
Ch1	Select the remote control channel to use with this projector.
Ch2	
Ch3	
Ch4	
Independent	Can be controlled from a remote control set to any channel.

Selecting a Channel on the Remote Control

After changing the projector channel from the menu, always change the remote control channel accordingly.

Ch1	Hold down both the Ch button and [1] button for 3 seconds.
Ch2	Hold down both the Ch button and [2] button for 3 seconds.
Ch3	Hold down both the Ch button and [3] button for 3 seconds.
Ch4	Hold down both the Ch button and [4] button for 3 seconds.
Independent	Hold down both the Ch button and [0] button for 3 seconds.

[INPUT A-C] button settings

Select input signals to assign to **INPUT A-C** buttons on the remote control. This enables direct selection of the input signals.

Option	Function
INPUT A	Choose from the following input signals to assign: [Disable], [HDMI-1], [HDMI-2], [DP-1], [DP-2], [HDBaseT] or [DP 1x2].
INPUT B	
INPUT C	

Audio in terminal select

 > [System settings] > **[Audio in terminal select]**

Select the terminal for audio input used with various input signals.

Submenu	Function															
HDMI-1	Select the terminal for audio input.															
HDMI-2																
DP-1																
DP-2																
HDBaseT																
DP 1x2																
		<table border="1"> <thead> <tr> <th>Option</th> <th>Function</th> </tr> </thead> <tbody> <tr> <td>Off</td> <td>No audio is output.</td> </tr> <tr> <td>HDMI-1</td> <td>Audio signals from HDMI-1 are output.</td> </tr> <tr> <td>HDMI-2</td> <td>Audio signals from HDMI-2 are output.</td> </tr> <tr> <td>DP-1</td> <td>Audio signals from DP-1 are output.</td> </tr> <tr> <td>DP-2</td> <td>Audio signals from DP-2 are output.</td> </tr> <tr> <td>HDBaseT</td> <td>Audio signals from HDBaseT are output.</td> </tr> </tbody> </table>	Option	Function	Off	No audio is output.	HDMI-1	Audio signals from HDMI-1 are output.	HDMI-2	Audio signals from HDMI-2 are output.	DP-1	Audio signals from DP-1 are output.	DP-2	Audio signals from DP-2 are output.	HDBaseT	Audio signals from HDBaseT are output.
Option		Function														
Off		No audio is output.														
HDMI-1		Audio signals from HDMI-1 are output.														
HDMI-2	Audio signals from HDMI-2 are output.															
DP-1	Audio signals from DP-1 are output.															
DP-2	Audio signals from DP-2 are output.															
HDBaseT	Audio signals from HDBaseT are output.															

HDBaseT signal quality

 > [System settings] > **[HDBaseT signal quality]**

Display the video signal quality of HDBaseT input. The HDBaseT input signal value received is indicated by a white line.

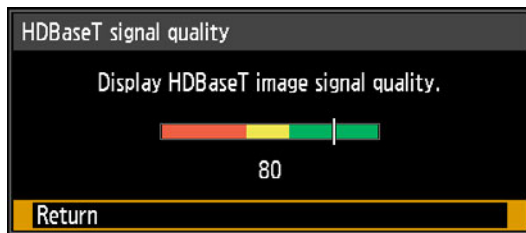

High	Indicated by the green portion. This is the recommended level.
Middle	Indicated by the yellow portion. The signal is fluctuating. Check the cable.
Low	Indicated by the red portion. The signal cannot be used. Fix the cable connection or replace the cable.



Do not coil or bundle cables.

Communication settings

 > [System settings] > **[Communication settings]**

View or configure communication setting values for the service port or HDBaseT serial communication.

Submenu	Function								
Extron XTP	Specify whether to connect to Extron XTP transmitters when connected via HDBaseT.								
Serial communication	Select ports used for serial communication. Otherwise, you can refer to this setting to check setting values for the port selected for serial communication.								
	<table border="1"> <thead> <tr> <th>Option</th> <th>Function</th> </tr> </thead> <tbody> <tr> <td>Service port</td> <td>Use the service port (CONTROL).</td> </tr> <tr> <td>HDBaseT</td> <td>Use the HDBaseT port.</td> </tr> <tr> <td>Detail</td> <td>Display baud rate, data bits, and parity, and change the stop bit (switch between 1 or 2 bits).</td> </tr> </tbody> </table>	Option	Function	Service port	Use the service port (CONTROL).	HDBaseT	Use the HDBaseT port.	Detail	Display baud rate, data bits, and parity, and change the stop bit (switch between 1 or 2 bits).
	Option	Function							
	Service port	Use the service port (CONTROL).							
HDBaseT	Use the HDBaseT port.								
Detail	Display baud rate, data bits, and parity, and change the stop bit (switch between 1 or 2 bits).								

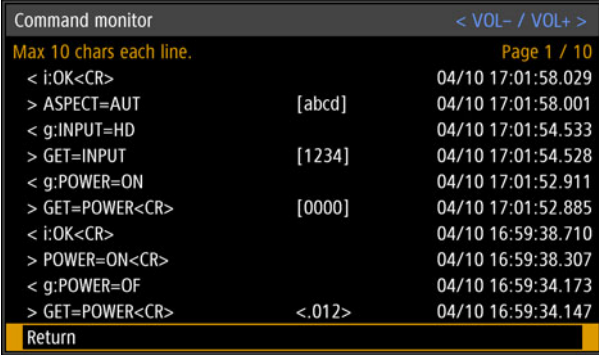
Submenu	Function										
Command monitor	<p>Log, show, hide, or clear user commands.</p>  <p>The screenshot shows a terminal window titled 'Command monitor' with a '< VOL- / VOL+ >' button in the top right. It displays a list of commands and their execution times, such as '< i:OK<CR>' at '04/10 17:01:58.029'. The text 'Max 10 chars each line.' and 'Page 1 / 10' are also visible. A 'Return' button is highlighted at the bottom.</p> <p>You can log and view the type, execution time, and IP address (limited to the last octet at the time of reception) of sent and received user commands.</p> <table border="1"> <thead> <tr> <th>Option</th> <th>Function</th> </tr> </thead> <tbody> <tr> <td>Off</td> <td>Disable user command logging.</td> </tr> <tr> <td>On</td> <td>Enable user command logging.</td> </tr> <tr> <td>Display</td> <td>Show the user command log.</td> </tr> <tr> <td>Clear</td> <td>Clear the entire user command log.</td> </tr> </tbody> </table>	Option	Function	Off	Disable user command logging.	On	Enable user command logging.	Display	Show the user command log.	Clear	Clear the entire user command log.
Option	Function										
Off	Disable user command logging.										
On	Enable user command logging.										
Display	Show the user command log.										
Clear	Clear the entire user command log.										

Power supply settings

 > [System settings] > **[Power supply settings]**

Specify how power is managed at startup, in standby, and when no signal is supplied.

Power supply settings	
Standby power setting	Low-power
Quick startup	Off
Power management mode	Standby
Power management duration	15 min.
Direct power on	Off
Return	

Standby power setting

Specify network function operating status in standby mode.

Option	Function
Normal	All network functions are available when network functions are enabled, including the web screen and PjLink.
Low-power	All functions are disabled except for some wired LAN functions (such as operations over a network).



- [Standby power setting] is set to [Normal] and cannot be changed when scheduling is enabled (P152).
- [Standby power setting] is set to [Normal] and cannot be changed when wireless LAN is enabled (P160).

Quick startup

Enable faster startup next time by leaving some circuits on for 90 minutes after the projector is turned off. However, to avoid sudden surges in intensity, projection is delayed by at least approximately 1.7 seconds.

Option	Function
Off	Disable quick startup.
On	Enable quick startup.

Power management mode

Specify to turn the light source off or enter standby if there is no input signal. This feature automatically turns off the light source or power after a certain period if the remote control or projector is not operated.

Option	Function
Disabled	Disable power management mode.
Light source off	Only turns the light source off.
Standby	Turns the projector off and puts it in standby.



- Projection resumes when the same input signal is restored, when the remote control or projector is operated, or when user commands are sent to turn the projector on.
- After the projector enters standby, restoring projection requires the same steps as when turning the projector on normally.
- When [Disabled] is selected, [Direct power on] is not available.

Power management duration

Specify how much time must pass before the light source goes off or the projector enters standby mode, depending on the [Power management mode] setting.

Option	Function
5 min. – 60 min.	After 30 seconds without an input signal when the projector is idle, the projector starts displaying a countdown of the selected time.



- Can be set to 5 min., 10 min., 15 min., 20 min., 30 min., or 60 min.
- If conditions that would start countdown are met while you are blanking projection, blanking is canceled.

Direct power on

You can turn on the projector by connecting the power cable without pressing the **POWER** button.

Option	Function
Off	The POWER button must be pressed to turn the projector on.
On	You can turn on the projector by connecting the power cable only.



- Before enabling direct power on, be sure to set [Power management mode] to an option other than [Disabled]. When [Disabled] is selected, [Direct power on] is not available.
- The projector is also equipped with a Direct Power Off feature. No damage is caused to the projector even if it is unplugged during projection to turn it off without pressing the **POWER** button. However, setting adjustments made immediately before unplugging the projector may not be stored.

Motion blur reduction

 > [System settings] > **[Motion blur reduction]**

Motion blur is blurring that occurs during video playback. Motion blur reduction can make this blurring less noticeable.

Option	Function
Off	Motion blur reduction is not performed.
Weak	Reduce motion blur for fast-moving images. Note that images may be slightly darker, and flickering may occur.
Strong	Reduce motion blur for images moving faster than with [Weak]. Note that images may be darker, and flickering may occur.



- If setting the projector to [Strong] or [Weak] produces distracting flickering, set it to [Off].
- [Motion blur reduction] is not available in [DICOM SIM] image mode. The menu is grayed out.

Language

 > [System settings] > **[Language]**

Select the menu display language.

Language		
English English	Русский Russian	Čeština Czech
Deutsch German	Nederlands Dutch	Dansk Danish
Français French	Suomi Finnish	إنجليزي Arabic
Italiano Italian	Norsk Norwegian	中文简体 Chinese (Simplified)
Español Spanish	Türkçe Turkish	中文繁體 Chinese (Traditional)
Português Portuguese	Polski Polish	한국어 Korean
Svenska Swedish	Magyar Hungarian	日本語 Japanese

Other settings

 > [System settings] > **[Other settings]**

Register a password, set a password, reset the air filter counter, schedule operation, and access other settings and information.

Other settings	
Password settings	Off
Register password	
Date and time settings	
Schedule	
Calibration	
Trigger out	Off
Air filter counter	
Power counter	3H
Firmware	00.00131
Factory defaults	
Return	

Password settings

Disables the projector unless the correct password is entered.

Option	Function
Off	The projector can be used even if no password is entered.
On	The projector cannot be used unless you enter your password.

To Cancel the Password

Cancellation on the Projector	Turn off the projector and unplug the power plug. Hold down the MENU button on the side control and connect the power on the plug. Make sure to keep holding down the MENU button until a beep sounds. When the projector beeps, the password is canceled. (The entered password is also reset.)
Cancellation on the Remote Control	To forcibly cancel the password from the remote control, in standby state press the MENU button 3 times, then press the POWER button.



- You cannot set [On] unless you have completed [Register password]. Once you set a password, the password entry screen appears at power-on. Enter a 4 digit password.
Enter the password using the [▲] / [▶] / [▼] / [◀] buttons or number buttons on the remote control.
If the password is valid, the projection starts. If you enter a wrong password three times, the power will be turned off.
- The projector also goes off after three minutes of inactivity on the password input screen.

Register password

You can register a password for starting projection.

Enter a 4 digit password.



Enter the password using the pointer buttons [▲] (1) / [▶] (2) / [▼] (3) / [◀] (4) or the number buttons on the remote control.

The 4-digit password is entered from the left to right digits. When the final digit is entered, the password is automatically registered.

Press the **MENU** button to abort the registration.

Date and time settings

Set time settings such as the current date and time, date/time display format, daylight saving time, and time zone.

Submenu	Function								
Date and time	Set the date and time. The date and time currently set are shown and updated each second.								
	 The display is blank if the [Date and time] setting has not been set.								
	<table border="1"> <thead> <tr> <th>Submenu</th> <th>Function</th> </tr> </thead> <tbody> <tr> <td>Date</td> <td>Enter the date.</td> </tr> <tr> <td>Time</td> <td>Enter the time.</td> </tr> <tr> <td>Enter</td> <td>Confirms your entered values. At this time [Date and time] starts operating.</td> </tr> </tbody> </table>	Submenu	Function	Date	Enter the date.	Time	Enter the time.	Enter	Confirms your entered values. At this time [Date and time] starts operating.
	Submenu	Function							
Date	Enter the date.								
Time	Enter the time.								
Enter	Confirms your entered values. At this time [Date and time] starts operating.								
 <ul style="list-style-type: none"> The date/time display format is set in [Date display format]. Settings may be reset if the projector is left unplugged for an extended period. 									
Date display format	Choose [Year/month/date], [Month/date/year], or [Date/month/year] as the date display format shown for the date and time, in schedules, and elsewhere.								
Daylight saving time	Adjusts the time one hour ahead at the beginning of daylight saving time and one hour back at the end. The timing of daylight saving time must be set in advance.								
	<table border="1"> <thead> <tr> <th>Option</th> <th>Function</th> </tr> </thead> <tbody> <tr> <td>Off</td> <td>Disable daylight saving time.</td> </tr> <tr> <td>On</td> <td>Enable daylight saving time.</td> </tr> <tr> <td>Edit</td> <td>Edit when daylight saving time starts and ends. Set the month, day, and time on the editing screen shown next for the starting and ending date/time.</td> </tr> </tbody> </table>	Option	Function	Off	Disable daylight saving time.	On	Enable daylight saving time.	Edit	Edit when daylight saving time starts and ends. Set the month, day, and time on the editing screen shown next for the starting and ending date/time.
	Option	Function							
	Off	Disable daylight saving time.							
On	Enable daylight saving time.								
Edit	Edit when daylight saving time starts and ends. Set the month, day, and time on the editing screen shown next for the starting and ending date/time.								
 [On] in [Daylight saving time] is not available until the starting and ending timing are set.									
Region	Select a city in the time zone where the projector is installed. The time zone of the city selected in [Time zone] is shown.								

Submenu	Function								
SNTP	Select whether to sync the time on the projector using SNTP (Simple Network Time Protocol).								
	<table border="1"> <thead> <tr> <th>Submenu</th> <th>Function</th> </tr> </thead> <tbody> <tr> <td>On (IPv4)</td> <td>Use SNTP over an IPv4 connection.</td> </tr> <tr> <td>On (IPv6)</td> <td>Use SNTP over an IPv6 connection.</td> </tr> <tr> <td>Off</td> <td>Disable SNTP.</td> </tr> </tbody> </table>	Submenu	Function	On (IPv4)	Use SNTP over an IPv4 connection.	On (IPv6)	Use SNTP over an IPv6 connection.	Off	Disable SNTP.
	Submenu	Function							
	On (IPv4)	Use SNTP over an IPv4 connection.							
	On (IPv6)	Use SNTP over an IPv6 connection.							
Off	Disable SNTP.								
 <ul style="list-style-type: none"> • [SNTP] is not available when [Network (wired/wireless)] is set to [Off/Off]. • Use the web screen to set the IP address of the SNTP server. [SNTP] is not available unless the SNTP server IP address has been set. 									

Schedule

Some projector tasks can be automated by scheduling them. As the timing of scheduled tasks, choose from [Default], which is not during a certain period, or one of five special period times that you set up.

Schedule		
When a [Special period (1 to 5)] is specified, the [Default] schedule is suspended during that period.		
Default	Off	
Special period 1	Off	2019/05/08 – 2019/05/17
Special period 2	Off	2019/05/20 – 2019/05/22
Special period 3	Off	2019/05/23 – 2019/05/24
Special period 4	Off	2019/05/27 – 2019/05/31
Special period 5	Off	2019/06/03 – 2019/06/12
Return		



The [Period] setting of a special period cannot be set to overlap with another period.

Option	Function
Default	Set a general schedule that is not during a specific period.
Special period 1 – 5	Set up to five specific periods to schedule operation.



- [On] is grayed out until you set the period in [Special period 1] to [Special period 5].
- [On] and [Off] are grayed out for periods in [Special period 1] to [Special period 5] that have already passed.
- Setting any schedule to [On] changes [Standby power setting] (P147) to [Normal].
- Tasks scheduled under the [Default] setting are not executed while special period schedules are in effect.

Detailed schedule setting

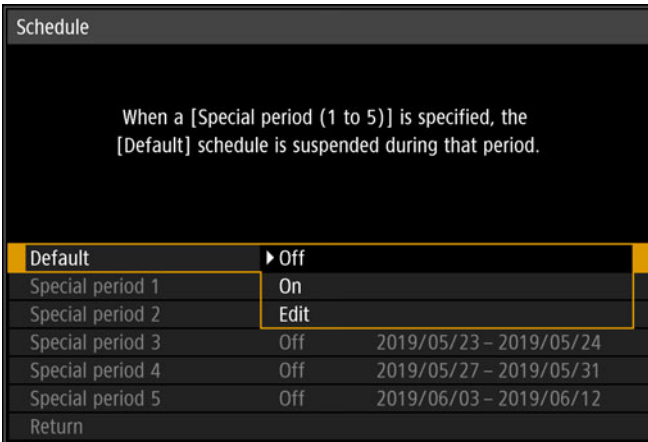

Option	Function																								
Off	Disable the schedule.																								
On	Enable the schedule.																								
Edit	<p>Edit the schedule.</p> <p>■ Default</p> <p>Detailed schedule setting [Default]</p> <p>Day of week ◀ Monday ▶</p> <p>Edit schedule</p> <table border="1"> <tr> <td>08 : 00</td> <td>POWER</td> <td>ON</td> </tr> <tr> <td>08 : 00</td> <td>INPUT</td> <td>HDMI-1</td> </tr> <tr> <td>10 : 00</td> <td>INPUT</td> <td>HDMI-2</td> </tr> <tr> <td>12 : 00</td> <td>INPUT</td> <td>HDMI-1</td> </tr> <tr> <td>14 : 30</td> <td>INPUT</td> <td>HDMI-2</td> </tr> <tr> <td>15 : 00</td> <td>INPUT</td> <td>HDMI-1</td> </tr> <tr> <td>16 : 15</td> <td>INPUT</td> <td>HDMI-2</td> </tr> <tr> <td>17 : 30</td> <td>POWER</td> <td>OFF</td> </tr> </table> <p>Reset</p> <p>Copy schedule to different day</p> <p>Return</p>	08 : 00	POWER	ON	08 : 00	INPUT	HDMI-1	10 : 00	INPUT	HDMI-2	12 : 00	INPUT	HDMI-1	14 : 30	INPUT	HDMI-2	15 : 00	INPUT	HDMI-1	16 : 15	INPUT	HDMI-2	17 : 30	POWER	OFF
08 : 00	POWER	ON																							
08 : 00	INPUT	HDMI-1																							
10 : 00	INPUT	HDMI-2																							
12 : 00	INPUT	HDMI-1																							
14 : 30	INPUT	HDMI-2																							
15 : 00	INPUT	HDMI-1																							
16 : 15	INPUT	HDMI-2																							
17 : 30	POWER	OFF																							

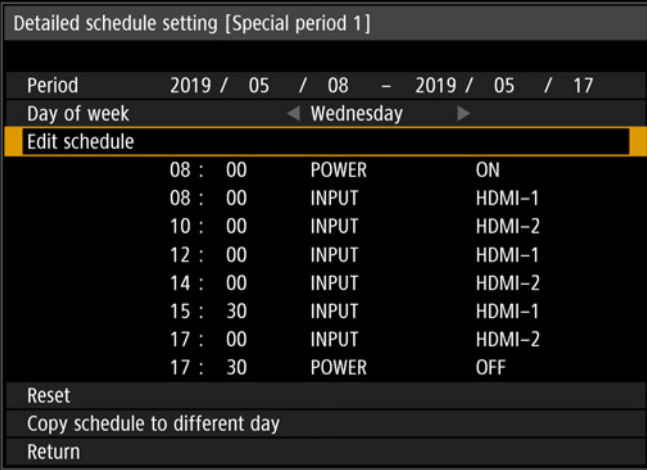
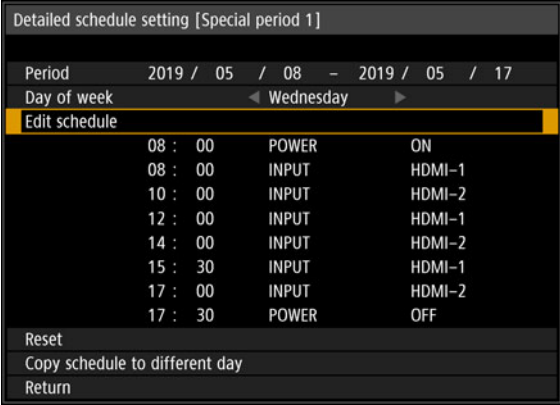
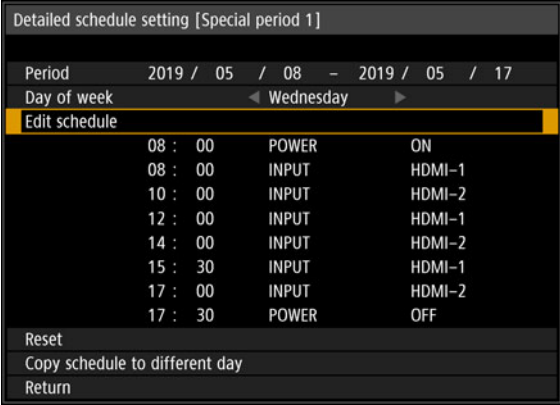
Option	Function							
Edit	<p>■ Special period</p>  <p>Select a day in [Day of week], and select the times, operations, and parameters.</p>							
	<table border="1"> <thead> <tr> <th data-bbox="408 807 577 840">Submenu</th> <th data-bbox="577 807 1188 840">Function</th> </tr> </thead> <tbody> <tr> <td data-bbox="408 840 577 942">Period</td> <td data-bbox="577 840 1188 942">Edit the period (start and end dates) for scheduled operation. Note that no [Period] setting is used for the [Default] schedule.</td> </tr> <tr> <td data-bbox="408 942 577 975">Day of week</td> <td data-bbox="577 942 1188 975">Change the day of the week to edit.</td> </tr> <tr> <td data-bbox="408 975 577 1528">Edit schedule</td> <td data-bbox="577 975 1188 1528"> <p>Edit the tasks scheduled for your selected [Day of week]. You can set or remove listed times, operations, and parameters (POWER ON/OFF, INPUT, CALIBRATION).</p>  </td> </tr> </tbody> </table>	Submenu	Function	Period	Edit the period (start and end dates) for scheduled operation. Note that no [Period] setting is used for the [Default] schedule.	Day of week	Change the day of the week to edit.	Edit schedule
Submenu	Function							
Period	Edit the period (start and end dates) for scheduled operation. Note that no [Period] setting is used for the [Default] schedule.							
Day of week	Change the day of the week to edit.							
Edit schedule	<p>Edit the tasks scheduled for your selected [Day of week]. You can set or remove listed times, operations, and parameters (POWER ON/OFF, INPUT, CALIBRATION).</p> 							

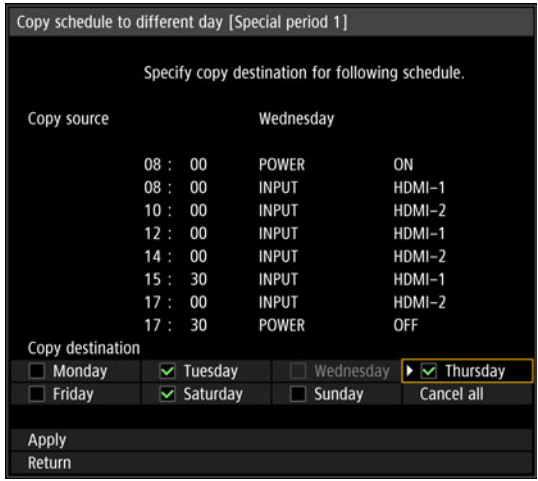
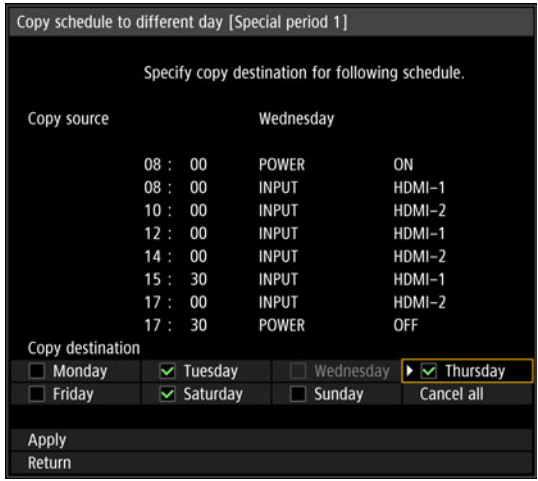
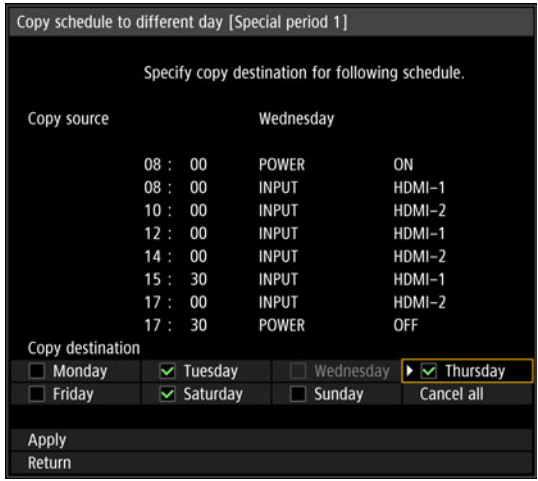

Option	Function						
Edit	<table border="1"> <thead> <tr> <th>Submenu</th> <th>Function</th> </tr> </thead> <tbody> <tr> <td>Reset</td> <td>Clears setting details for the selected schedule. Setting details for [Period] and day of the week are reset.</td> </tr> <tr> <td>Copy schedule to different day</td> <td> <p>Copy the tasks scheduled for your selected [Day of week] to another day in the schedule copying menu.</p>  </td> </tr> </tbody> </table>	Submenu	Function	Reset	Clears setting details for the selected schedule. Setting details for [Period] and day of the week are reset.	Copy schedule to different day	<p>Copy the tasks scheduled for your selected [Day of week] to another day in the schedule copying menu.</p> 
	Submenu	Function					
Reset	Clears setting details for the selected schedule. Setting details for [Period] and day of the week are reset.						
Copy schedule to different day	<p>Copy the tasks scheduled for your selected [Day of week] to another day in the schedule copying menu.</p> 						

Calibration

Calibration adjusts the projector to compensate for changes in image quality from long-term use or differences in the environment of use.

Submenu	Function						
Gamma restore	Restore the original gamma if, after the projector has been used for some time, you notice that tone curves have changed, or if neutral colors have become tinted. Gamma restore can only be used after about 30 minutes of projection.						
	<table border="1"> <thead> <tr> <th>Option</th> <th>Function</th> </tr> </thead> <tbody> <tr> <td>Off</td> <td>Returns to the factory default without performing Gamma restore.</td> </tr> <tr> <td>Adjust</td> <td>Restore the original gamma and apply the result.</td> </tr> </tbody> </table>	Option	Function	Off	Returns to the factory default without performing Gamma restore.	Adjust	Restore the original gamma and apply the result.
	Option	Function					
Off	Returns to the factory default without performing Gamma restore.						
Adjust	Restore the original gamma and apply the result.						
<ul style="list-style-type: none"> Restoring gamma will restore tone curves and neutral colors as closely as possible to defaults, but original projection cannot be matched exactly. If Gamma restore is performed, the adjustment screen will be projected for approximately 6 minutes. To stop Gamma restore, press the POWER or EXIT button. Cancellation will return the setting to [Off]. 							

Menu Description

Submenu	Function						
Light source calibration	Use when there is concern about deterioration of the color and luminance of the light source due to extended use.						
	<table border="1"> <thead> <tr> <th>Option</th> <th>Function</th> </tr> </thead> <tbody> <tr> <td>OK</td> <td>Execute light source calibration.</td> </tr> <tr> <td>Cancel</td> <td>Do not execute light source calibration.</td> </tr> </tbody> </table>	Option	Function	OK	Execute light source calibration.	Cancel	Do not execute light source calibration.
	Option	Function					
OK	Execute light source calibration.						
Cancel	Do not execute light source calibration.						
 Light source calibration can only be used after about 30 minutes of projection.							
<h3>Trigger out</h3> <p>Operation of a screen or other external device can be triggered by turning the projector on or off.</p> <table border="1"> <thead> <tr> <th>Option</th> <th>Function</th> </tr> </thead> <tbody> <tr> <td>Off</td> <td>No output from the trigger terminal.</td> </tr> <tr> <td>Link with power</td> <td>12 V of voltage output from the trigger terminal during projection. Used to trigger operation of a screen or other external device in sync when the projector is turned on or off.</td> </tr> </tbody> </table>		Option	Function	Off	No output from the trigger terminal.	Link with power	12 V of voltage output from the trigger terminal during projection. Used to trigger operation of a screen or other external device in sync when the projector is turned on or off.
Option	Function						
Off	No output from the trigger terminal.						
Link with power	12 V of voltage output from the trigger terminal during projection. Used to trigger operation of a screen or other external device in sync when the projector is turned on or off.						
<h3>Air filter counter</h3> <p>Shows a counter to remind you when to replace the air filter. Also shows a counter reset screen.</p>  <ul style="list-style-type: none"> • After air filter replacement, reset the air filter counter. • For details on replacing the air filter, see P191 – P192. 							
<h3>Power counter</h3> <p>Indicates the total time that the projector has been connected to a power supply.</p>  This value is not reset even if [Factory defaults] is executed.							

Firmware

Update the projector firmware.

Check the version indicated before updating the firmware.

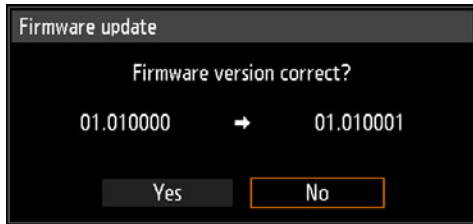

Update the projector firmware as follows.

1. Download updated firmware from the Canon website and store it at the root directory on a USB flash drive.
2. Insert the USB flash drive in the USB port.
3. Follow the instructions shown to complete the update process.



- Firmware versions shown here are for illustration only and differ from actual versions.
- In some cases, it may not be possible to download updates. For details, contact the Canon Customer Support Center.
- Firmware updating takes a few minutes. During the update, the LED indicator will flash in red. Do not turn off the projector while the LED is flashing. After the update, the projector will automatically turn itself off and enter standby mode.

Factory defaults

You can reset the menu item settings and restore the system settings to the factory defaults.

Option	Function
OK	Settings are reset to default.
Cancel	Settings are not reset to default.

Network settings

Settings described in this section apply to wired and wireless network connections, setting a network password, and other aspects of networked projection.

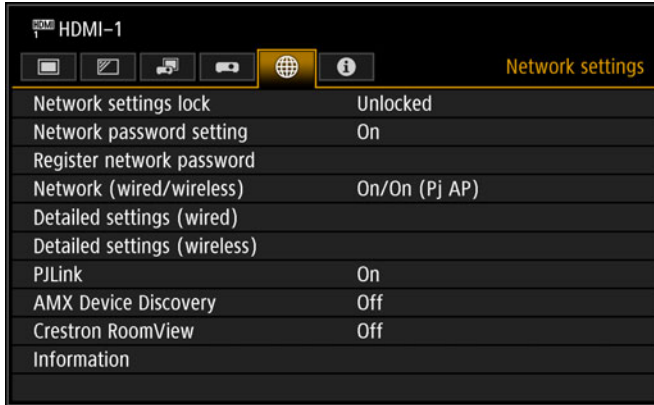

Menu screen when the input signal is HDMI-1

Menu	Function	Details
Network settings lock	Lock or unlock network settings, depending on whether you wish to prevent changes.	P159
Network password setting	Activate or deactivate password protection for network settings.	P159
Register network password	Set a network password.	P159
Network (wired/wireless)	Enable or disable wired or wireless network connectivity and the mode of operation.	P160
Detailed settings (wired)	Display and set advanced settings for wired connections.	P161
Detailed settings (wireless)	Display and set advanced settings for wireless connections.	P165
PJLink*	Enable or disable PJLink.	P170
AMX Device Discovery*	Enable or disable AMX Device Discovery.	P171
Crestron RoomView*	Enable or disable Crestron RoomView.	P171
Information	Display network information.	P172

Menus that are not available are grayed out or hidden.

* Only available for wired connections.

Network settings lock

 > [Network settings] > **[Network settings lock]**

You can lock/unlock the network settings so that they cannot be changed.

Option	Function
Unlock	Cancels the lock and allows other network settings to be changed. The password must be entered in order to cancel the lock. Use the [▲]/[▶]/[▼]/[◀] buttons or number buttons on the remote control to enter the 4-digit network password.
Lock	Lock the settings.



- **Forcibly canceling the network lock**

Press these buttons in the following order to cancel the lock: [▲] [OK] [▶] [OK] [▼] [OK]. This operation resets the network password to [▲] [▲] [▲] [▲] ([1] [1] [1] [1]).

- Setting [Network password setting] to [Off] leaves network settings unlocked.

Network password setting

 > [Network settings] > **[Network password setting]**

You can set whether or not a password is required in order to change the projector network settings.

Option	Function
Off	A network password is not used.
On	A network password is used.

Register network password

 > [Network settings] > **[Register network password]**

Use the [▲] / [▶] / [▼] / [◀] buttons or number buttons on the remote control to enter the projector network password.



Network (wired/wireless)



> [Network settings] > **[Network (wired/wireless)]**

Enable or disable wired or wireless network connectivity and the mode of operation. Specifying [Off] can save energy.

Option	Function
Off/Off	Disable the network function.
On/Off	Enable only wired networking.
On/On (Pj AP)	Enable both wired and wireless (PJ AP mode) networking.
Off/On (Pj AP)	Enable only wireless (PJ AP mode) networking.
Off/On (Infra)	Enable only wireless (infrastructure mode) networking.



Notes When Connected Wirelessly

A message is displayed at the initial startup in PJ AP mode (P66) requesting that you check security key settings.

Detailed settings (wired)

 > [Network settings] > [Detailed settings (wired)]



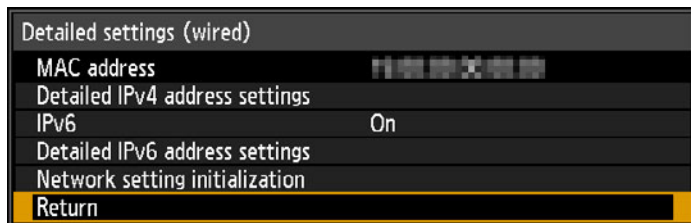

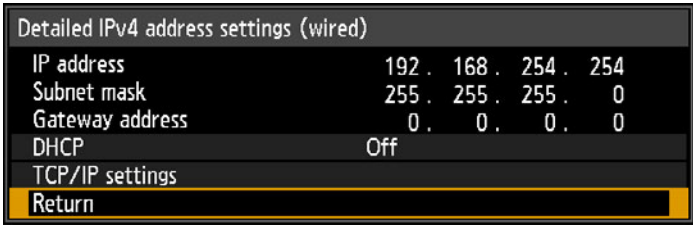
Display and manually change the wired IP address, gateway address, and other settings. Available only when wired networking is [On].

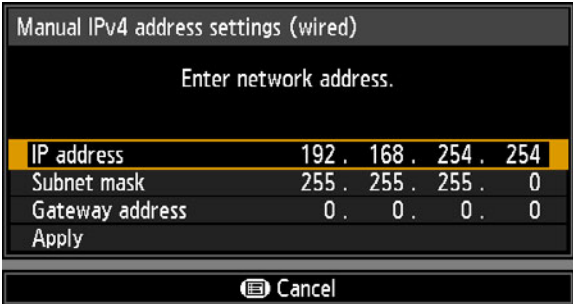
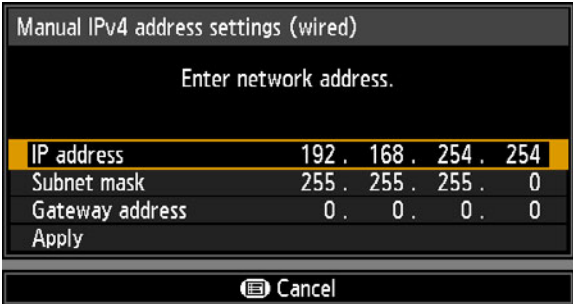
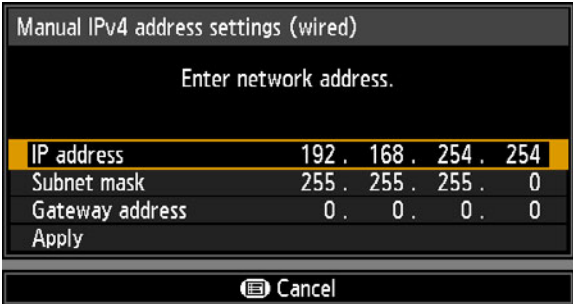

Menu	Function																
MAC address	Wired MAC address of the projector.																
Detailed IPv4 address settings	Configure details of the projector's wired LAN (IPv4) function.																
																	
	<table border="1"> <thead> <tr> <th>Submenu</th> <th>Function</th> </tr> </thead> <tbody> <tr> <td>IP address</td> <td>IP address of the wired LAN (IPv4).</td> </tr> <tr> <td>Subnet mask</td> <td>Subnet mask of the wired LAN (IPv4).</td> </tr> <tr> <td>Gateway address</td> <td>Gateway address of the wired LAN (IPv4).</td> </tr> <tr> <td rowspan="2">DHCP</td> <td> <table border="1"> <thead> <tr> <th>Option</th> <th>Function</th> </tr> </thead> <tbody> <tr> <td>Off</td> <td>Disables the DHCP function. TCP/IP settings can be configured manually.</td> </tr> <tr> <td>On</td> <td>Enables the DHCP function. Searches the DHCP server. It will no longer be possible to enter TCP/IP manual settings (IP address, subnet mask, and gateway address), because the IP address is acquired from the DHCP server.</td> </tr> </tbody> </table> </td> </tr> </tbody> </table>	Submenu	Function	IP address	IP address of the wired LAN (IPv4).	Subnet mask	Subnet mask of the wired LAN (IPv4).	Gateway address	Gateway address of the wired LAN (IPv4).	DHCP	<table border="1"> <thead> <tr> <th>Option</th> <th>Function</th> </tr> </thead> <tbody> <tr> <td>Off</td> <td>Disables the DHCP function. TCP/IP settings can be configured manually.</td> </tr> <tr> <td>On</td> <td>Enables the DHCP function. Searches the DHCP server. It will no longer be possible to enter TCP/IP manual settings (IP address, subnet mask, and gateway address), because the IP address is acquired from the DHCP server.</td> </tr> </tbody> </table>	Option	Function	Off	Disables the DHCP function. TCP/IP settings can be configured manually.	On	Enables the DHCP function. Searches the DHCP server. It will no longer be possible to enter TCP/IP manual settings (IP address, subnet mask, and gateway address), because the IP address is acquired from the DHCP server.
	Submenu	Function															
	IP address	IP address of the wired LAN (IPv4).															
	Subnet mask	Subnet mask of the wired LAN (IPv4).															
	Gateway address	Gateway address of the wired LAN (IPv4).															
	DHCP	<table border="1"> <thead> <tr> <th>Option</th> <th>Function</th> </tr> </thead> <tbody> <tr> <td>Off</td> <td>Disables the DHCP function. TCP/IP settings can be configured manually.</td> </tr> <tr> <td>On</td> <td>Enables the DHCP function. Searches the DHCP server. It will no longer be possible to enter TCP/IP manual settings (IP address, subnet mask, and gateway address), because the IP address is acquired from the DHCP server.</td> </tr> </tbody> </table>	Option	Function	Off	Disables the DHCP function. TCP/IP settings can be configured manually.	On	Enables the DHCP function. Searches the DHCP server. It will no longer be possible to enter TCP/IP manual settings (IP address, subnet mask, and gateway address), because the IP address is acquired from the DHCP server.									
		Option	Function														
	Off	Disables the DHCP function. TCP/IP settings can be configured manually.															
On	Enables the DHCP function. Searches the DHCP server. It will no longer be possible to enter TCP/IP manual settings (IP address, subnet mask, and gateway address), because the IP address is acquired from the DHCP server.																
IP address	IP address of the wired LAN (IPv4).																
Subnet mask	Subnet mask of the wired LAN (IPv4).																
Gateway address	Gateway address of the wired LAN (IPv4).																
DHCP	<table border="1"> <thead> <tr> <th>Option</th> <th>Function</th> </tr> </thead> <tbody> <tr> <td>Off</td> <td>Disables the DHCP function. TCP/IP settings can be configured manually.</td> </tr> <tr> <td>On</td> <td>Enables the DHCP function. Searches the DHCP server. It will no longer be possible to enter TCP/IP manual settings (IP address, subnet mask, and gateway address), because the IP address is acquired from the DHCP server.</td> </tr> </tbody> </table>	Option	Function	Off	Disables the DHCP function. TCP/IP settings can be configured manually.	On	Enables the DHCP function. Searches the DHCP server. It will no longer be possible to enter TCP/IP manual settings (IP address, subnet mask, and gateway address), because the IP address is acquired from the DHCP server.										
	Option	Function															
Off	Disables the DHCP function. TCP/IP settings can be configured manually.																
On	Enables the DHCP function. Searches the DHCP server. It will no longer be possible to enter TCP/IP manual settings (IP address, subnet mask, and gateway address), because the IP address is acquired from the DHCP server.																
Off	Disables the DHCP function. TCP/IP settings can be configured manually.																
On	Enables the DHCP function. Searches the DHCP server. It will no longer be possible to enter TCP/IP manual settings (IP address, subnet mask, and gateway address), because the IP address is acquired from the DHCP server.																

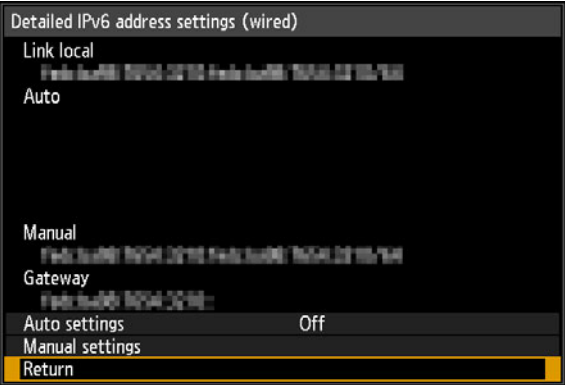
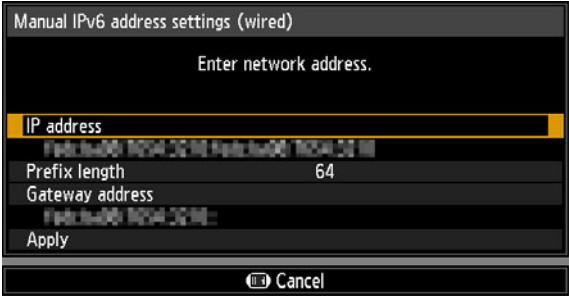
Menu Description

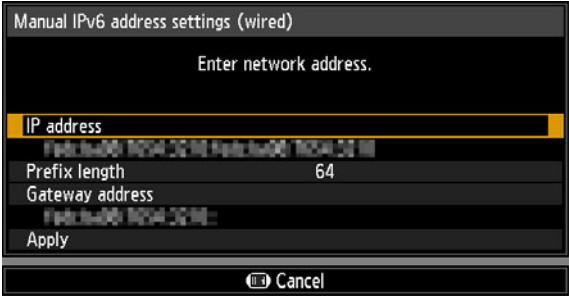
Menu	Function							
Detailed IPv4 address settings	<table border="1"> <thead> <tr> <th data-bbox="389 175 577 218">Submenu</th> <th data-bbox="577 175 1219 218">Function</th> </tr> </thead> <tbody> <tr> <td data-bbox="389 218 577 1058">TCP/IP settings</td> <td data-bbox="577 218 1219 1058"> <p>Change or specify the IP address, subnet mask, and gateway address used for connections.</p>  <ul style="list-style-type: none"> • This menu is not available (grayed out) when [DHCP] (P161) is [On]. • If an invalid value is entered, “Invalid entry.” is displayed. In this case, enter a valid value. • When [Network (wired/wireless)] is set to [On/On (Pj AP)], “Cannot set identical segment IP” is displayed if you specify the same subnetwork as in PJ AP mode. Enter a different subnetwork, or change [Network (wired/wireless)] to [On/Off] before entering the wired IP address again. </td> </tr> </tbody> </table>	Submenu	Function	TCP/IP settings	<p>Change or specify the IP address, subnet mask, and gateway address used for connections.</p>  <ul style="list-style-type: none"> • This menu is not available (grayed out) when [DHCP] (P161) is [On]. • If an invalid value is entered, “Invalid entry.” is displayed. In this case, enter a valid value. • When [Network (wired/wireless)] is set to [On/On (Pj AP)], “Cannot set identical segment IP” is displayed if you specify the same subnetwork as in PJ AP mode. Enter a different subnetwork, or change [Network (wired/wireless)] to [On/Off] before entering the wired IP address again. 			
	Submenu	Function						
TCP/IP settings	<p>Change or specify the IP address, subnet mask, and gateway address used for connections.</p>  <ul style="list-style-type: none"> • This menu is not available (grayed out) when [DHCP] (P161) is [On]. • If an invalid value is entered, “Invalid entry.” is displayed. In this case, enter a valid value. • When [Network (wired/wireless)] is set to [On/On (Pj AP)], “Cannot set identical segment IP” is displayed if you specify the same subnetwork as in PJ AP mode. Enter a different subnetwork, or change [Network (wired/wireless)] to [On/Off] before entering the wired IP address again. 							
IPv6	<table border="1"> <thead> <tr> <th data-bbox="389 1058 577 1101">Option</th> <th data-bbox="577 1058 1219 1101">Function</th> </tr> </thead> <tbody> <tr> <td data-bbox="389 1101 577 1143">Off</td> <td data-bbox="577 1101 1219 1143">Disables the projector’s wired LAN (IPv6) function.</td> </tr> <tr> <td data-bbox="389 1143 577 1242">On</td> <td data-bbox="577 1143 1219 1242">Enables the projector’s wired LAN (IPv6) function. [Detailed IPv6 address settings] is now available.</td> </tr> </tbody> </table>	Option	Function	Off	Disables the projector’s wired LAN (IPv6) function.	On	Enables the projector’s wired LAN (IPv6) function. [Detailed IPv6 address settings] is now available.	
Option	Function							
Off	Disables the projector’s wired LAN (IPv6) function.							
On	Enables the projector’s wired LAN (IPv6) function. [Detailed IPv6 address settings] is now available.							

Menu	Function													
Detailed IPv6 address settings	<p>Configure details of the projector's wired LAN (IPv6) function.</p> 													
	<table border="1"> <thead> <tr> <th data-bbox="408 651 577 683">Submenu</th> <th data-bbox="577 651 1219 683">Function</th> </tr> </thead> <tbody> <tr> <td data-bbox="408 683 577 716">Link local</td> <td data-bbox="577 683 1219 716">Link-local address of the wired LAN (IPv6).</td> </tr> <tr> <td data-bbox="408 716 577 749">Auto</td> <td data-bbox="577 716 1219 749">Automatic addresses (up to 5) of the wired LAN (IPv6).</td> </tr> <tr> <td data-bbox="408 749 577 782">Manual</td> <td data-bbox="577 749 1219 782">Manual address of the wired LAN (IPv6).</td> </tr> <tr> <td data-bbox="408 782 577 815">Gateway</td> <td data-bbox="577 782 1219 815">Gateway address of the wired LAN (IPv6).</td> </tr> <tr> <td data-bbox="408 815 577 906">Auto settings</td> <td data-bbox="577 815 1219 906">Enable/disable automatic address setting of the wired LAN (IPv6).</td> </tr> <tr> <td data-bbox="408 906 577 1433">Manual settings</td> <td data-bbox="577 906 1219 1433"> Manually configure settings of the wired LAN (IPv6). Change or specify the IPv6 address, prefix length, and gateway address.   If an invalid value is entered, "Invalid entry." is displayed. In this case, enter a valid value. </td> </tr> </tbody> </table>	Submenu	Function	Link local	Link-local address of the wired LAN (IPv6).	Auto	Automatic addresses (up to 5) of the wired LAN (IPv6).	Manual	Manual address of the wired LAN (IPv6).	Gateway	Gateway address of the wired LAN (IPv6).	Auto settings	Enable/disable automatic address setting of the wired LAN (IPv6).	Manual settings
Submenu	Function													
Link local	Link-local address of the wired LAN (IPv6).													
Auto	Automatic addresses (up to 5) of the wired LAN (IPv6).													
Manual	Manual address of the wired LAN (IPv6).													
Gateway	Gateway address of the wired LAN (IPv6).													
Auto settings	Enable/disable automatic address setting of the wired LAN (IPv6).													
Manual settings	Manually configure settings of the wired LAN (IPv6). Change or specify the IPv6 address, prefix length, and gateway address.   If an invalid value is entered, "Invalid entry." is displayed. In this case, enter a valid value.													

Menu	Function
<p>Network setting initialization</p>	<p>The following network settings are initialized.</p> <p>Settings configured from the projector menu</p> <ul style="list-style-type: none"> • Network settings lock (P159) • Network password setting (P159) • Register network password (P159) • Network (wired/wireless) (P160) • Detailed settings (wired) (P161) <ul style="list-style-type: none"> - Detailed IPv4 address settings (P161) <ul style="list-style-type: none"> - DHCP (wired LAN (IPv4)) (P161) - TCP/IP settings (P162) <ul style="list-style-type: none"> - IP address (wired LAN (IPv4)) (P161) - Subnet mask (wired LAN (IPv4)) (P161) - Gateway address (wired LAN (IPv4)) (P161) - IPv6 (P162) - Detailed IPv6 address settings (P163) <ul style="list-style-type: none"> - Auto settings (P163) - Manual settings (P163) <ul style="list-style-type: none"> - IP address (wired LAN (IPv6)) (P163) - Prefix length (P163) - Gateway address (wired LAN (IPv6)) (P163) • PJLink (P170) • AMX Device Discovery settings (P171) • Crestron RoomView settings (P171) <p>Settings configured from the web screen</p> <ul style="list-style-type: none"> • [Password] (P174) • [Wired] (P180) <ul style="list-style-type: none"> - IPv4 <ul style="list-style-type: none"> - DHCP (P180) - IP address (P180) - Subnet mask (P180) - Default gateway (P180) - IPv6 <ul style="list-style-type: none"> - IPv6 (P181) - Autoconfiguration (P181) - IP address (P181) - Prefix length (P181) - Default gateway (P181) • [Mail] (P185) • [SNMP] (P187) • [Projector info.] (P188) • [PJLink] (P188)

Detailed settings (wireless)

 > [Network settings] > **[Detailed settings (wireless)]**

Display and manually change the wireless IP address, gateway address, and other settings. Available only when wireless networking is [On].

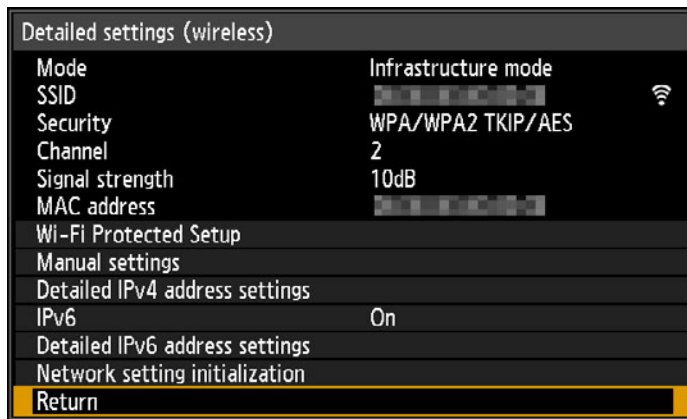

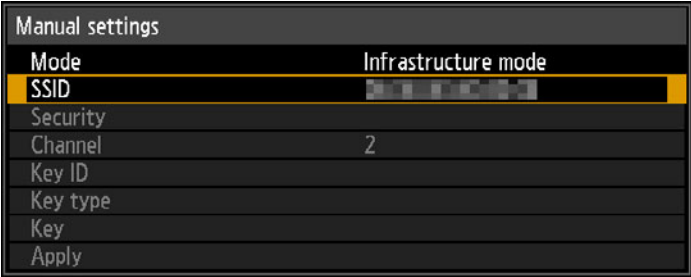
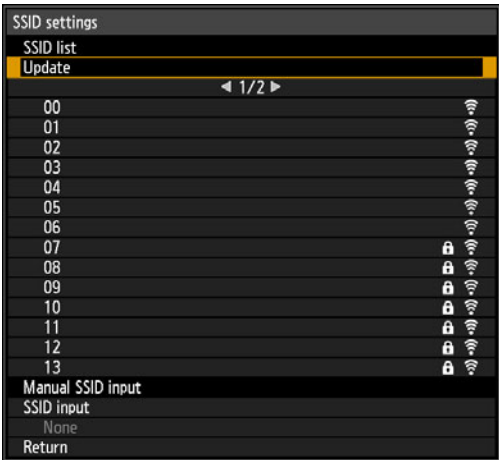
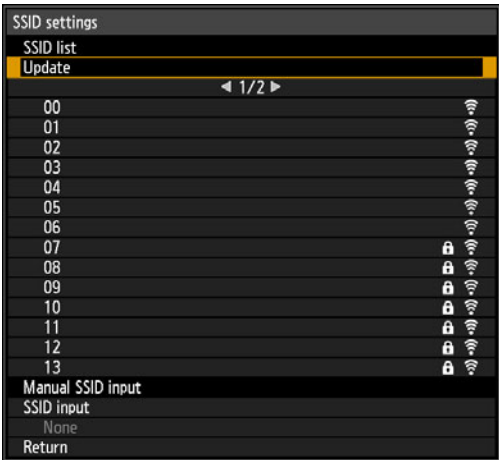
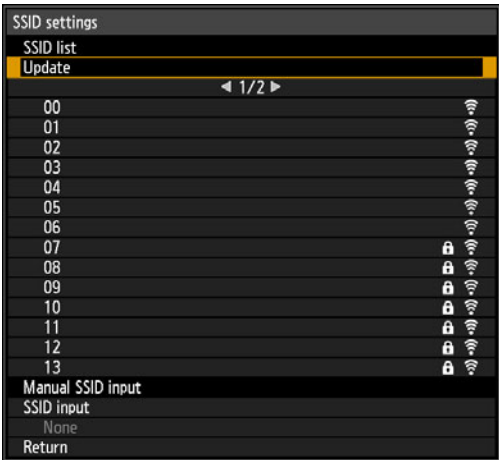

Menu	Function						
Mode	Shows the wireless connection mode (P66).						
SSID	Shows the access point SSID.						
Security	Shows the security setting.						
Channel	Shows the channel used for the connection.						
Signal strength	Shows actual signal strength, as measured.						
MAC address	Wireless MAC address of the projector.						
Wi-Fi Protected Setup	Select the method of connection in infrastructure mode.						
	<table border="1"> <thead> <tr> <th>Submenu</th> <th>Function</th> </tr> </thead> <tbody> <tr> <td>PBC</td> <td>Connect in PBC (push-button) mode. Following the instructions shown, press the button on the wireless base station (access point), and, within 2 minutes, select [OK] on the screen.</td> </tr> <tr> <td>PIN</td> <td>Connect in PIN mode. Following the instructions shown, enter the displayed 8-digit PIN code on the wireless base station (access point), and, within 10 minutes, select [OK] on the screen.</td> </tr> </tbody> </table>	Submenu	Function	PBC	Connect in PBC (push-button) mode. Following the instructions shown, press the button on the wireless base station (access point), and, within 2 minutes, select [OK] on the screen.	PIN	Connect in PIN mode. Following the instructions shown, enter the displayed 8-digit PIN code on the wireless base station (access point), and, within 10 minutes, select [OK] on the screen.
	Submenu	Function					
PBC	Connect in PBC (push-button) mode. Following the instructions shown, press the button on the wireless base station (access point), and, within 2 minutes, select [OK] on the screen.						
PIN	Connect in PIN mode. Following the instructions shown, enter the displayed 8-digit PIN code on the wireless base station (access point), and, within 10 minutes, select [OK] on the screen.						

Menu Description

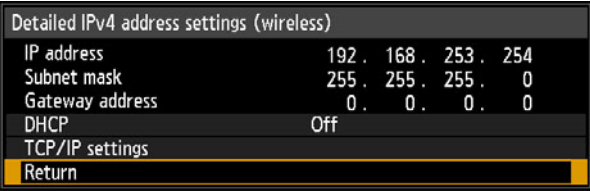
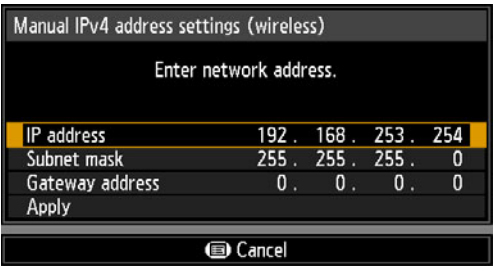
Menu	Function																		
Manual settings	<p>Manually specify the projector's wireless settings.</p> 																		
	<table border="1"> <thead> <tr> <th data-bbox="406 542 577 577">Submenu</th> <th data-bbox="577 542 1211 577">Function</th> </tr> </thead> <tbody> <tr> <td data-bbox="406 577 577 612">Mode</td> <td data-bbox="577 577 1211 612">Shows the wireless connection mode (P66).</td> </tr> <tr> <td data-bbox="406 612 577 1188">SSID</td> <td data-bbox="577 612 1211 1188"> <p>A list of available access point SSIDs is displayed. You can find available access points nearby or use the keyboard to enter an access point SSID.</p>  </td> </tr> <tr> <td data-bbox="406 1188 577 1288">Security</td> <td data-bbox="577 1188 1211 1288">Select the wireless security from [Open], [WEP], [WPA2 AES], or [WPA/WPA2 TKIP/AES]. In PJ AP mode, choose from [Open] or [WPA2 AES].</td> </tr> <tr> <td data-bbox="406 1288 577 1323">Channel</td> <td data-bbox="577 1288 1211 1323">Shows the current wireless channel (1 – 11).</td> </tr> <tr> <td data-bbox="406 1323 577 1396">Key ID</td> <td data-bbox="577 1323 1211 1396">Select the wireless WEP key ID. Only available for when security is set to [WEP].</td> </tr> <tr> <td data-bbox="406 1396 577 1464">Key type</td> <td data-bbox="577 1396 1211 1464">Select the wireless security key input type. Not available when security is set to [Open].</td> </tr> <tr> <td data-bbox="406 1464 577 1532">Key</td> <td data-bbox="577 1464 1211 1532">Enter the wireless security key. Not available when security is set to [Open].</td> </tr> <tr> <td data-bbox="406 1532 577 1578">Apply</td> <td data-bbox="577 1532 1211 1578">Connect with the current settings.</td> </tr> </tbody> </table>	Submenu	Function	Mode	Shows the wireless connection mode (P66).	SSID	<p>A list of available access point SSIDs is displayed. You can find available access points nearby or use the keyboard to enter an access point SSID.</p> 	Security	Select the wireless security from [Open], [WEP], [WPA2 AES], or [WPA/WPA2 TKIP/AES]. In PJ AP mode, choose from [Open] or [WPA2 AES].	Channel	Shows the current wireless channel (1 – 11).	Key ID	Select the wireless WEP key ID. Only available for when security is set to [WEP].	Key type	Select the wireless security key input type. Not available when security is set to [Open].	Key	Enter the wireless security key. Not available when security is set to [Open].	Apply	Connect with the current settings.
	Submenu	Function																	
	Mode	Shows the wireless connection mode (P66).																	
	SSID	<p>A list of available access point SSIDs is displayed. You can find available access points nearby or use the keyboard to enter an access point SSID.</p> 																	
	Security	Select the wireless security from [Open], [WEP], [WPA2 AES], or [WPA/WPA2 TKIP/AES]. In PJ AP mode, choose from [Open] or [WPA2 AES].																	
	Channel	Shows the current wireless channel (1 – 11).																	
	Key ID	Select the wireless WEP key ID. Only available for when security is set to [WEP].																	
	Key type	Select the wireless security key input type. Not available when security is set to [Open].																	
Key	Enter the wireless security key. Not available when security is set to [Open].																		
Apply	Connect with the current settings.																		

Menu	Function																
Detailed IPv4 address settings	<p>Configure details of the projector's wireless LAN (IPv4) function.</p> 																
	<table border="1"> <thead> <tr> <th data-bbox="408 446 577 479">Submenu</th> <th data-bbox="577 446 1211 479">Function</th> </tr> </thead> <tbody> <tr> <td data-bbox="408 479 577 517">IP address</td> <td data-bbox="577 479 1211 517">IP address of the projector's wireless LAN (IPv4).</td> </tr> <tr> <td data-bbox="408 517 577 556">Subnet mask</td> <td data-bbox="577 517 1211 556">Subnet mask of the projector's wireless LAN (IPv4).</td> </tr> <tr> <td data-bbox="408 556 577 624">Gateway address</td> <td data-bbox="577 556 1211 624">Gateway address of the projector's wireless LAN (IPv4).</td> </tr> <tr> <td data-bbox="408 624 577 1020">DHCP</td> <td data-bbox="577 624 1211 1020"> <p>Enable or disable wireless DHCP on the projector.</p> <table border="1"> <thead> <tr> <th data-bbox="595 678 764 710">Option</th> <th data-bbox="764 678 1193 710">Function</th> </tr> </thead> <tbody> <tr> <td data-bbox="595 710 764 778">Off</td> <td data-bbox="764 710 1193 778">Disables the DHCP function. TCP/IP settings can be configured manually.</td> </tr> <tr> <td data-bbox="595 778 764 1014">On</td> <td data-bbox="764 778 1193 1014">Enables the DHCP function. Searches the DHCP server. It will no longer be possible to enter TCP/IP manual settings (IP address, subnet mask, and gateway address), because the IP address is acquired from the DHCP server.</td> </tr> </tbody> </table> </td> </tr> </tbody> </table>	Submenu	Function	IP address	IP address of the projector's wireless LAN (IPv4).	Subnet mask	Subnet mask of the projector's wireless LAN (IPv4).	Gateway address	Gateway address of the projector's wireless LAN (IPv4).	DHCP	<p>Enable or disable wireless DHCP on the projector.</p> <table border="1"> <thead> <tr> <th data-bbox="595 678 764 710">Option</th> <th data-bbox="764 678 1193 710">Function</th> </tr> </thead> <tbody> <tr> <td data-bbox="595 710 764 778">Off</td> <td data-bbox="764 710 1193 778">Disables the DHCP function. TCP/IP settings can be configured manually.</td> </tr> <tr> <td data-bbox="595 778 764 1014">On</td> <td data-bbox="764 778 1193 1014">Enables the DHCP function. Searches the DHCP server. It will no longer be possible to enter TCP/IP manual settings (IP address, subnet mask, and gateway address), because the IP address is acquired from the DHCP server.</td> </tr> </tbody> </table>	Option	Function	Off	Disables the DHCP function. TCP/IP settings can be configured manually.	On	Enables the DHCP function. Searches the DHCP server. It will no longer be possible to enter TCP/IP manual settings (IP address, subnet mask, and gateway address), because the IP address is acquired from the DHCP server.
	Submenu	Function															
	IP address	IP address of the projector's wireless LAN (IPv4).															
Subnet mask	Subnet mask of the projector's wireless LAN (IPv4).																
Gateway address	Gateway address of the projector's wireless LAN (IPv4).																
DHCP	<p>Enable or disable wireless DHCP on the projector.</p> <table border="1"> <thead> <tr> <th data-bbox="595 678 764 710">Option</th> <th data-bbox="764 678 1193 710">Function</th> </tr> </thead> <tbody> <tr> <td data-bbox="595 710 764 778">Off</td> <td data-bbox="764 710 1193 778">Disables the DHCP function. TCP/IP settings can be configured manually.</td> </tr> <tr> <td data-bbox="595 778 764 1014">On</td> <td data-bbox="764 778 1193 1014">Enables the DHCP function. Searches the DHCP server. It will no longer be possible to enter TCP/IP manual settings (IP address, subnet mask, and gateway address), because the IP address is acquired from the DHCP server.</td> </tr> </tbody> </table>	Option	Function	Off	Disables the DHCP function. TCP/IP settings can be configured manually.	On	Enables the DHCP function. Searches the DHCP server. It will no longer be possible to enter TCP/IP manual settings (IP address, subnet mask, and gateway address), because the IP address is acquired from the DHCP server.										
Option	Function																
Off	Disables the DHCP function. TCP/IP settings can be configured manually.																
On	Enables the DHCP function. Searches the DHCP server. It will no longer be possible to enter TCP/IP manual settings (IP address, subnet mask, and gateway address), because the IP address is acquired from the DHCP server.																
<p>Configure the projector's wireless TCP/IP settings.</p> <div style="border: 1px solid gray; padding: 5px; background-color: #f0f0f0;"> <ul style="list-style-type: none"> • This menu is not available (grayed out) when [DHCP] is [On]. • If an invalid value is entered, "Invalid entry." is displayed. In this case, enter a valid value. </div> 																	

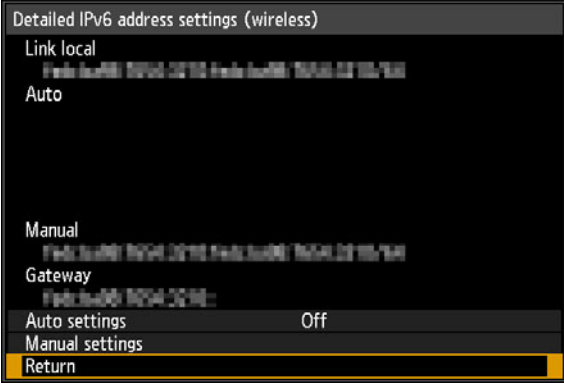
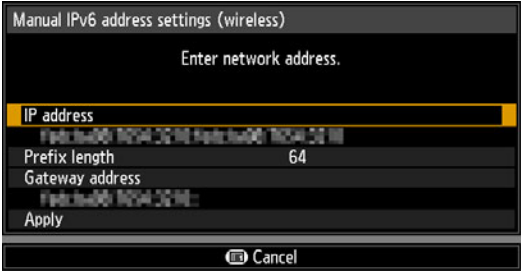
Menu Description

Menu	Function												
IPv6	<table border="1" data-bbox="406 195 1200 340"> <thead> <tr> <th data-bbox="406 195 577 227">Option</th> <th data-bbox="577 195 1200 227">Function</th> </tr> </thead> <tbody> <tr> <td data-bbox="406 227 577 272">Off</td> <td data-bbox="577 227 1200 272">Disables the projector's wireless LAN (IPv6) function.</td> </tr> <tr> <td data-bbox="406 272 577 340">On</td> <td data-bbox="577 272 1200 340">Enables the projector's wireless LAN (IPv6) function. [Detailed IPv6 address settings] is now available.</td> </tr> </tbody> </table> <p data-bbox="422 363 1200 465">  IPv6 connectivity is not available in PJ AP mode (P160). The [IPv6] and [Detailed IPv6 address settings] menus are grayed out. </p>	Option	Function	Off	Disables the projector's wireless LAN (IPv6) function.	On	Enables the projector's wireless LAN (IPv6) function. [Detailed IPv6 address settings] is now available.						
Option	Function												
Off	Disables the projector's wireless LAN (IPv6) function.												
On	Enables the projector's wireless LAN (IPv6) function. [Detailed IPv6 address settings] is now available.												
Detailed IPv6 address settings	<p data-bbox="406 490 1200 517">Configure details of the projector's wireless LAN (IPv6) function.</p> <div data-bbox="406 529 968 909">  </div> <table border="1" data-bbox="406 954 1200 1238"> <thead> <tr> <th data-bbox="406 954 577 987">Submenu</th> <th data-bbox="577 954 1200 987">Function</th> </tr> </thead> <tbody> <tr> <td data-bbox="406 987 577 1031">Link local</td> <td data-bbox="577 987 1200 1031">Link-local address of the wireless LAN (IPv6).</td> </tr> <tr> <td data-bbox="406 1031 577 1095">Auto</td> <td data-bbox="577 1031 1200 1095">Automatic addresses (up to 5) of the wireless LAN (IPv6).</td> </tr> <tr> <td data-bbox="406 1095 577 1139">Manual</td> <td data-bbox="577 1095 1200 1139">Manual address of the wireless LAN (IPv6).</td> </tr> <tr> <td data-bbox="406 1139 577 1184">Gateway</td> <td data-bbox="577 1139 1200 1184">Gateway address of the wireless LAN (IPv6).</td> </tr> <tr> <td data-bbox="406 1184 577 1238">Auto settings</td> <td data-bbox="577 1184 1200 1238">Enable/disable automatic address setting of the wireless LAN (IPv6).</td> </tr> </tbody> </table> <p data-bbox="406 1248 1200 1335"> Manual settings Manually configure settings of the wireless LAN (IPv6). Change or specify the IPv6 address, prefix length, and gateway address. </p> <div data-bbox="594 1348 1112 1619">  </div> <p data-bbox="610 1644 1200 1711">  If an invalid value is entered, "Invalid entry." is displayed. In this case, enter a valid value. </p>	Submenu	Function	Link local	Link-local address of the wireless LAN (IPv6).	Auto	Automatic addresses (up to 5) of the wireless LAN (IPv6).	Manual	Manual address of the wireless LAN (IPv6).	Gateway	Gateway address of the wireless LAN (IPv6).	Auto settings	Enable/disable automatic address setting of the wireless LAN (IPv6).
Submenu	Function												
Link local	Link-local address of the wireless LAN (IPv6).												
Auto	Automatic addresses (up to 5) of the wireless LAN (IPv6).												
Manual	Manual address of the wireless LAN (IPv6).												
Gateway	Gateway address of the wireless LAN (IPv6).												
Auto settings	Enable/disable automatic address setting of the wireless LAN (IPv6).												

Menu	Function
Network setting initialization	<p>The following network settings are initialized.</p> <p>Settings configured from the projector menu</p> <ul style="list-style-type: none"> • Network settings lock (P159) • Network password setting (P159) • Register network password (P159) • Network (wired/wireless) (P160) • Detailed settings (wireless) (P165) <ul style="list-style-type: none"> - Detailed IPv4 address settings (P167) <ul style="list-style-type: none"> - DHCP (wireless LAN (IPv4)) (P167) - TCP/IP settings (P167) <ul style="list-style-type: none"> - IP address (wireless LAN (IPv4)) (P167) - Subnet mask (wireless LAN (IPv4)) (P167) - Gateway address (wireless LAN (IPv4)) (P167) - IPv6 (P168) <ul style="list-style-type: none"> - Detailed IPv6 address settings (P168) <ul style="list-style-type: none"> - Auto settings (P168) - Manual settings (P168) <ul style="list-style-type: none"> - IP address (wireless LAN (IPv6)) (P168) - Prefix length (P168) - Gateway address (wireless LAN (IPv6)) (P168) <p>Settings configured from the web screen</p> <ul style="list-style-type: none"> • [Password] (P174) • [Wireless] (P182) <ul style="list-style-type: none"> - IPv4 <ul style="list-style-type: none"> - DHCP (P182) - IP address (P182) - Subnet mask (P182) - Default gateway (P182) - IPv6 <ul style="list-style-type: none"> - IPv6 (P183) - Autoconfiguration (P183) - IP address (P183) - Prefix length (P183) - Default gateway (P183) • [Mail] (P185) • [Projector info.] (P188)

PJLink



> [Network settings] > **[PJLink]**

You can enable or disable the PJLink network function of the projector.

When the function is turned on, control is possible via the network using commands that meet PJLink standards.

Option	Function
Off	Disables the PJLink function.
On	Enables the PJLink function.



- The projector conforms to Class 2 as defined in PJLink standards established by the Japan Business Machine and Information System Industries Association (JBMIA). This projector supports all commands that are defined by PJLink Class 2, and PJLink compatibility has been verified.
 - The port number for PJLink command transmission is 4352 (TCP).
 - The port number for PJLink device searching is 4352 (UDP).
 - For details on using PJLink, see “Setting PJLink [PJLink]” (P188).

Sources and corresponding input terminals

Input source number	Input signal name
31	HDMI-1
32	HDMI-2
33	DP-1
34	DP-2
35	DP 1x2
51	HDBaseT

What is PJLink?

It allows centralized control of projectors and operation from a controller for all projectors regardless of manufacturer.

The objective is for JB MIA to improve convenience for users and expand the use of projectors through early systemization for network monitoring and control of projectors, which will become the mainstream in the future.

Class 1: Standardization of control and monitoring specifications for basic projector functions

Class 2: Standardizes commands added to Class 1, device searching, state notification, and IPv6 support.

For PJLink specifications, visit the Japan Business Machine and Information System Industries Association website.

PJLink website: <http://pjlink.jbmia.or.jp/english/>

AMX Device Discovery



> [Network settings] > **[AMX Device Discovery]**

This setting enables other equipment compatible with AMX Device Discovery to detect the projector over a network. For networks without AMX Device Discovery, select [Off].

Option	Function
Off	Disables AMX Device Discovery.
On	Enables AMX Device Discovery. The projector will periodically send out AMX beacon packets over the network.



- For details on AMX Device Discovery, visit the AMX website.
<http://www.amx.com>

Crestron RoomView



> [Network settings] > **[Crestron RoomView]**

Crestron RoomView enables centralized management of multiple projectors over a network. Networked projectors can be remotely controlled to troubleshoot issues, or turn the projectors on or off. Specify whether to use Crestron RoomView.

Option	Function
Off	Disable Crestron RoomView.
On	Enables Crestron RoomView. A port for RoomView will be opened, and the projector will respond to CIP packets. Communication is possible via the RoomView Express/Server application or via Crestron Controller (P189).



- For details on Crestron RoomView, visit the Crestron® website.
<http://www.crestron.com>

Information



> [Network settings] > **[Information]**

Shows network information.

Menu		Function	
E-mail sender address		Sender e-mail address for sending error messages (P185).	
E-mail recipient address		[Already set] or [Not set] is shown, indicating whether a recipient e-mail address has been set for error messages (P185).	
Detailed information (wired)	IPv4	IP address of the wired LAN (IPv4).	
	IPv6	Link local	Link-local IP address of the wired LAN (IPv6).
		Auto	Automatic IP address of the wired LAN (IPv6).
		Manual	Manual IP address of the wired LAN (IPv6).
Detailed information (wireless)	IPv4	IP address of the wireless LAN (IPv4).	
	IPv6	Link local	Link-local IP address of the wireless LAN (IPv6).
		Auto	Automatic IP address of the wireless LAN (IPv6).
		Manual	Manual IP address of the wireless LAN (IPv6).



- [Detailed information (wired)] menu information is displayed when [Network (wired/wireless)] is set to [On/*].
- [Detailed information (wireless)] menu information is displayed when [Network (wired/wireless)] is set to [*/On].

Checking Projector Information

You can check information about the signal types of the images projected and other information.

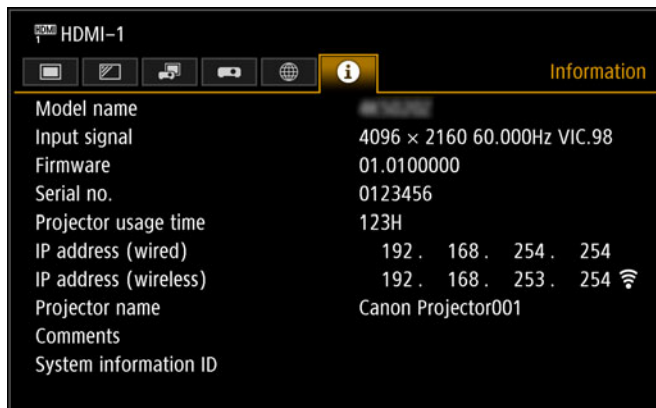

Menu	Function
Model name	Shows the model name.
Input signal	Details of the input signal currently selected Information such as the type, resolution, frequency, and color format of the signal is displayed.
Firmware	Current firmware version
Serial no.	Serial number unique to this projector
Projector usage time	Shows the total time the projector has been on.
IP address (wired)*	IP address (IPv4) for wired connections.
IP address (wireless)*	IP address (IPv4) for wireless connections.
Projector name*	Name which identifies this projector on the network
Comments*	Comments such as the location in which the projector is installed are displayed (P188).
System information ID	System information. Normally this is not displayed.

* No value is displayed when [Network (wired/wireless)] is set to [Off/Off].
Some values may not be displayed, depending on [Network (wired/wireless)] settings. (○: displayed, —: not displayed)

Network (wired/wireless)	Off/Off	On/Off	On/On (Pj AP)	Off/On (Pj AP)	Off/On (Infra)
IP address (wired)	—	○	○	—	—
IP address (wireless)	—	—	○	○	○
Projector name	—	○	○	○	○
Comments	—	○	○	○	○

Projector Web Screen Menu

This section describes the projector's web screen menu.

Setting a Password [Password]

From [Password] in the settings screen, you can set a user name and password for web screen login. For the setting procedure, see “Network Setting” (P73).

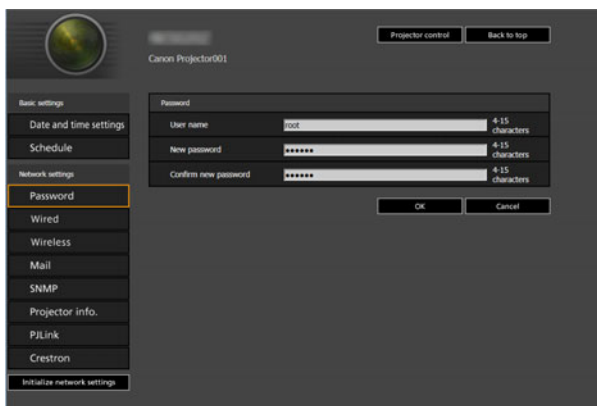

Item	Explanation	Factory default setting
User name	When logging into the web screen, enter the user name in 1-byte alphanumeric characters and symbols (4 – 15 characters).	root
New password	When logging into the web screen, enter the password in 1-byte alphanumeric characters and symbols (4 – 15 characters).	system
Confirm new password	For confirmation, enter the same password that you entered in [New password].	system



We recommend changing the default password.

Setting the Date and Time [Date and time settings]

From [Date and time settings] in the settings screen, you can set time settings such as the current date and time, date/time display format, time zone, and daylight saving time. For the setting procedure, see “Network Setting” (P73).

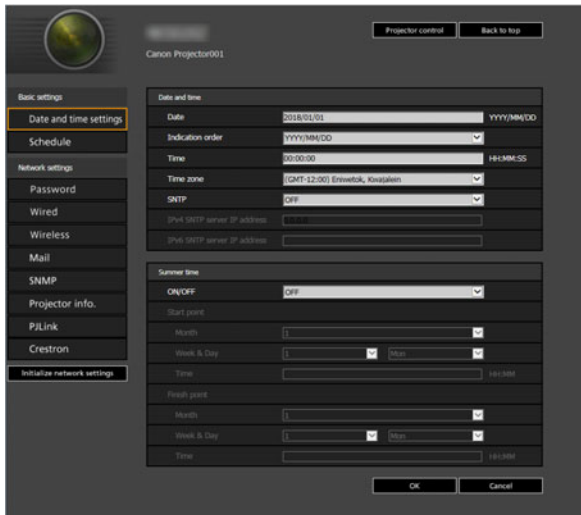

Item	Explanation	Factory default setting	
Date and time	Date	Enter the date in 1-byte numbers.	2018/01/01
	Indication order	Choose [YYYY/MM/DD], [MM/DD/YYYY], or [DD/MM/YYYY] as the date display format.	YYYY/MM/DD
	Time	Enter the time in 1-byte numbers, in the range 00:00:00 to 23:59:59.	00:00:00
	Time zone	Select a city in your time zone.	(GMT) Dublin, Lisbon, London
	SNTP	Select whether to turn the SNTP (Simple Network Time Protocol) function on or off. Choosing [ON (IPv4)] will prevent you from configuring the following settings. [Date] [Time] [IPv6 SNTP server IP address] Choosing [ON (IPv6)] will prevent you from configuring the following settings. [Date] [Time] [IPv4 SNTP server IP address]	OFF
	IPv4 SNTP server IP address	Enter the IPv4 SNTP server IP address in 1-byte numbers.	0.0.0.0
	IPv6 SNTP server IP address	Enter the IPv6 SNTP server IP address in 1-byte numbers.	<Blank>

Projector Web Screen Menu

Item		Explanation	Factory default setting
Summer time	ON / OFF	Select whether to turn the summer time function on or off (Time adjustment one hour ahead at the beginning of daylight saving time and one hour back at the end). Choosing [OFF] will prevent you from configuring the following settings. [Start point Month] [Start point Week] [Start point Day] [Start point Time] [Finish point Month] [Finish point Week] [Finish point Day] [Finish point Time]	OFF
	Start point Month	Select the month when daylight saving time begins.	1
	Start point Week	Select the week when daylight saving time begins.	1
	Start point Day	Select the day when daylight saving time begins.	Mon
	Start point Time	Enter the starting time for daylight saving time in 1-byte numbers, in the range 00:00 to 23:59.	00:00
	Finish point Month	Select the month when daylight saving time ends.	1
	Finish point Week	Select the week when daylight saving time ends.	1
	Finish point Day	Select the day when daylight saving time ends.	Mon
Finish point Time	Enter the ending time for daylight saving time in 1-byte numbers, in the range 00:00 to 23:59.	00:00	

Setting a Scheduling [Schedule]

From [Schedule] in the settings screen, you can automate some projector tasks by scheduling them. As the timing of scheduled operation, choose from [Usually], which is not during a certain period, or one of five special period times (Period.1 – Period.5) that you set up. For the setting procedure, see “Network Setting” (P73).



Item	Explanation	Factory default setting	
Schedule view	Select period	Select a specific period to configure.	Period.1
	Time setting	In the left box, enter the starting date of the specific period you are scheduling, and in the right box, enter the ending date, using 1-byte numbers. Dates of periods cannot be set to overlap.	2018/01/01
	Usually	Shows the usual schedule, which can be turned on or off by selecting the check boxes.	Cleared (OFF)
	Period.1	Shows the timing of the scheduled period 1. Can be turned on or off by selecting the check box.	Cleared (OFF)
	Period.2	Shows the timing of the scheduled period 2. Can be turned on or off by selecting the check box.	Cleared (OFF)
	Period.3	Shows the timing of the scheduled period 3. Can be turned on or off by selecting the check box.	Cleared (OFF)
	Period.4	Shows the timing of the scheduled period 4. Can be turned on or off by selecting the check box.	Cleared (OFF)

Projector Web Screen Menu

Item		Explanation	Factory default setting
Schedule view	Period.5	Shows the timing of the scheduled period 5. Can be turned on or off by selecting the check box.	Cleared (OFF)
Time Schedule		Shows times and days of the week of the usual schedule or period schedule selected in [Schedule view]. Green vertical line: projector on; gray vertical line: projector off; blue vertical line: switch input signals. Up to 8 schedules can be set per day.	—

Clicking an item in [Time Schedule] displays the [Edit schedule] screen, enabling you to edit the schedule of the selected day or time.

The screenshot shows the 'Edit schedule' interface. It includes a 'Day' dropdown set to 'Tue', a 'Time' input field with '03:00' and 'hh:mm' labels, an 'Operation' dropdown set to 'Power', and a 'Parameter' dropdown set to 'ON'. At the bottom, there are three buttons: 'Delete', 'OK', and 'Cancel'.

Item		Explanation	Factory default setting
Edit schedule	Day	Shows the day of the week for the selected schedule.	—
	Time	Enter the automatic execution time in 1-byte numbers, in the range 00:00 to 23:59.	<Blank>
	Operation	As the operation for automatic execution, choose [Power], [Input], or [Calibration].	Power
	Parameter	As parameters for automatic execution, choose from the following options. <ul style="list-style-type: none"> When [Operation] is set to [Power]: [ON] / [OFF] When [Operation] is set to [Input]: [HDMI-1/2] / [DP-1/2/1x2] / [HDBaseT] When [Operation] is set to [Calibration]: [LIGHT] 	ON

Projector Web Screen Menu

Clicking [Add schedule] in [Time Schedule] displays the [Add schedule] screen, enabling you to add a new schedule to the selected usual schedule or period schedule.

Item	Explanation	Factory default setting	
Add schedule	Day	Select a day of the week for automatic execution. Multiple days can be selected.	Cleared
	Time	Enter the automatic execution time in 1-byte numbers, in the range 00:00 to 23:59.	<Blank>
	Operation	As the operation for automatic execution, choose [Power], [Input] or [Calibration].	Power
	Parameter	As parameters for automatic execution, choose from the following options. <ul style="list-style-type: none"> When [Operation] is set to [Power]: [ON] / [OFF] When [Operation] is set to [Input]: [HDMI-1/2] / [DP-1/2/1x2] / [HDBaseT] When [Operation] is set to [Calibration]: [LIGHT] 	ON

Clicking [Copy schedule to different day] in [Time Schedule] displays the [Schedule copy] screen, enabling you to copy a schedule to any day for the selected usual schedule or period schedule.

Projector Web Screen Menu

Item	Explanation	Factory default setting	
Schedule copy	Copy origin	Select the day to copy from.	Mon
	Registration Events	Shows schedule details on the selected day.	<Blank>
	Copy to day	Select the day to copy to. Multiple days can be selected.	Cleared

Basic Wired Network Settings [Wired]

From [Wired] on the settings screen, you can complete basic network information for wired connections. For the setting procedure, see “Network Setting” (P73).

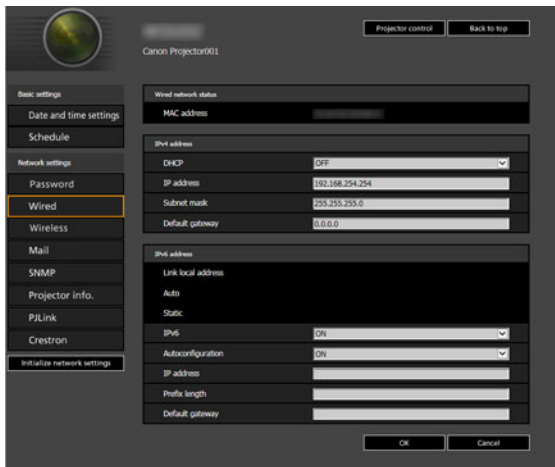

For IPv4

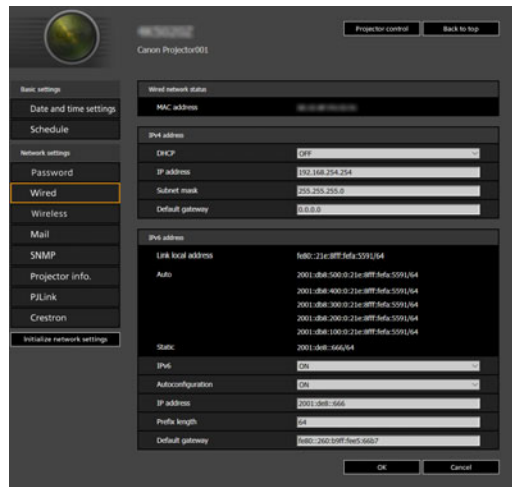

For IPv6

Item	Explanation	Factory default setting	
MAC address	Shows the projector's wired MAC address.	The projector's wired MAC address	
IPv4 address	DHCP	Select whether to turn the DHCP function on or off for wired LAN (IPv4). The following settings cannot be configured manually when this setting is [ON], because the IP address is acquired from the DHCP server. [IP address] [Subnet mask] [Default gateway]	OFF
	IP address	Enter the projector's wired LAN (IPv4) IP address in 1-byte numbers.	192.168.254.254
	Subnet mask	Enter the wired LAN (IPv4) subnet mask in 1-byte numbers.	255.255.255.0
	Default gateway	Enter the wired LAN (IPv4) default gateway address in 1-byte numbers.	0.0.0.0

Item		Explanation	Factory default setting
IPv6 address	Link local address	Shows the projector's wired LAN (IPv6) link-local IP address.	The projector's wired LAN (IPv6) link-local IP address
	Auto	Shows the projector's automatically assigned wired LAN (IPv6) address.	Automatically assigned IP address as acquired for [Auto settings]
	Static	Shows the projector's manually assigned wired LAN (IPv6) address.	<Blank>
	IPv6	Specify on or off for the IPv6 function of the wired LAN (IPv6). Choosing [OFF] will prevent you from configuring the following settings. [Autoconfiguration] [IP address] [Prefix length] [Default gateway]	OFF
	Autoconfiguration	Select on or off for the auto setting function of the wired LAN (IPv6).	ON
	IP address	Enter the wired LAN (IPv6) address in 1-byte numbers or letters between A and F.	<Blank>
	Prefix length	Enter the wired LAN (IPv6) prefix length in 1-byte numbers.	<Blank>
	Default gateway	Enter the wired LAN (IPv6) default gateway address in 1-byte numbers or letters between A and F.	<Blank>



If settings related to TCP/IP were changed, it is necessary to disconnect and reconnect to the network.

If the network subnet mask was changed, select [Subnet mask] in the above screen and set the new subnet mask.

Basic Wireless Network Settings [Wireless]

From [Wireless] on the settings screen, you can complete basic network information for wireless connections. For the setting procedure, see “Network Setting” (P73).

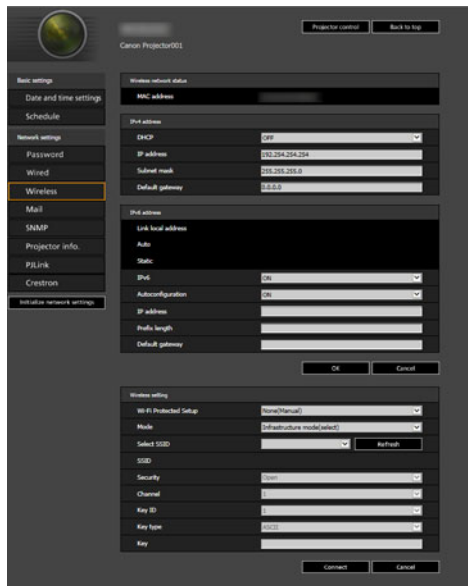

For IPv4



For IPv6

Item		Explanation	Factory default setting
MAC address		Shows the projector's wireless MAC address.	The projector's wireless MAC address
IPv4 address	DHCP	Select whether to turn the DHCP function on or off for wireless LAN (IPv4). The following settings cannot be configured manually when this setting is [ON], because the IP address is acquired from the DHCP server. [IP address] [Subnet mask] [Default gateway]	OFF
	IP address	Enter the projector's wireless LAN (IPv4) IP address in 1-byte numbers.	192.168.253.254
	Subnet mask	Enter the wireless LAN (IPv4) subnet mask in 1-byte numbers.	255.255.255.0
	Default gateway	Enter the wireless LAN (IPv4) default gateway address in 1-byte numbers.	0.0.0.0

Item		Explanation	Factory default setting
IPv6 address	Link local address	Shows the projector's wireless LAN (IPv6) link-local IP address.	The projector's wireless LAN (IPv6) link-local IP address
	Auto	Shows the projector's automatically assigned wireless LAN (IPv6) address.	Automatically assigned IP address as acquired for [Auto settings]
	Static	Shows the projector's manually assigned wireless LAN (IPv6) address.	<Blank>
	IPv6	Specify on or off for the wireless LAN (IPv6) function. Choosing [OFF] will prevent you from configuring the following settings. [Autoconfiguration] [IP address] [Prefix length] [Default gateway]	OFF
	Autoconfiguration	Select on or off for the auto setting function of the wireless LAN (IPv6).	ON
	IP address	Enter the wireless LAN (IPv6) IP address in 1-byte numbers or letters between A and F.	<Blank>
	Prefix length	Enter the wireless LAN (IPv6) prefix length in 1-byte numbers.	<Blank>
	Default gateway	Enter the wireless LAN (IPv6) default gateway address in 1-byte numbers or letters between A and F.	<Blank>

Projector Web Screen Menu

	Item	Explanation	Factory default setting
Wireless setting	Wi-Fi Protected Setup	Select a method of establishing a wireless connection. Not available in PJ AP wireless LAN mode.	None (Manual)
	Mode	Display or select the wireless connection mode. Not available in PJ AP wireless LAN mode.	infrastructure mode (select)
	Select SSID	Select the wireless access point's SSID. Not available in PJ AP wireless LAN mode.	<Blank>
	SSID	Display or select the wireless access point's SSID. Partial SSID editing is supported in PJ AP wireless LAN mode.	<Blank>
	Security	Display or select the wireless security setting value.	Open
	Channel	Display or select the wireless channel number. Not available when the wireless LAN mode is infrastructure mode.	6
	Key ID	Display or select the wireless WEP key ID. Not available when security is set to other than WEP.	1
	Key type	Select the wireless security key input type. Not available in PJ AP wireless LAN mode.	ASCII
	Key	Enter the wireless security key.	<Blank>



- If settings related to TCP/IP were changed, it is necessary to disconnect and reconnect to the network. If the network subnet mask was changed, select [Subnet mask] in the above screen and set the new subnet mask.
- IPv6 connectivity is not available in PJ AP mode (P66). [IPv6 address] is grayed out.
- For partial SSID editing when connected in PJ AP wireless LAN mode (P66), you can edit the portion between PJ- and _Canon0D. Enter 1-byte alphanumeric characters, including hyphens and underscores (1 – 15 characters).



Setting Up Email [Mail]

From [Mail] in the settings screen, you can set the items necessary to send error mails and test mails. For the setting procedure, see “Network Setting” (P73).

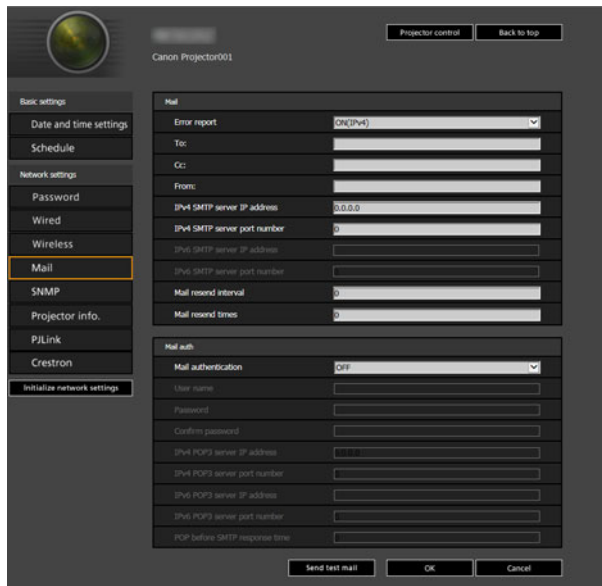

Item	Explanation	Factory default setting
Error report	Select whether to turn the error mail sending function on or off, and IPv4 or IPv6 for the network to use.	OFF
To:	Enter the recipient address for error mails in 1-byte alphanumeric characters and symbols (1 – 63 characters).	MailUserAccount
Cc:	Enter the CC address for error mails in 1-byte alphanumeric characters and symbols (1 – 63 characters).	<Blank>
From:	Enter the sender address for error mails in 1-byte alphanumeric characters and symbols (1 – 63 characters).	Projector@canon.co.jp
IPv4 SMTP server IP address	Enter the SMTP server IP address (IPv4) in 1-byte numbers.	0.0.0.0
IPv4 SMTP server port number	Enter the SMTP server port number (IPv4) in 1-byte numbers (1 – 65535).	25
IPv6 SMTP server IP address	Enter the SMTP server IP address (IPv6) in 1-byte numbers.	<Blank>
IPv6 SMTP server port number	Enter the SMTP server port number (IPv6) in 1-byte numbers (1 – 65535).	25
Mail resend interval*	Enter the interval for resending mail when an error occurred (unit: seconds) within the range of 0 – 59 seconds using 1-byte numbers.	10
Mail resend times	Enter the number of times to resend mail when an error occurred within the range of 0 – 255 using 1-byte numbers.	3

* When the interval is set to 0 seconds, repeated attempts to send mail are made (as set in [Mail resend times]) without pausing between attempts.

Mail Authentication Settings

From [Mail auth] under [Mail] in the settings screen, you can configure the settings for authentication of mail that is sent when an error occurs. For the setting procedure, see “Network Setting” (P73).

Item	Explanation	Factory default setting
Mail authentication	Select the mail authentication method. If [OFF] is selected, the other mail authentication settings cannot be changed.	OFF
User name	Enter the user name to use for mail authentication in 1-byte alphanumeric characters and symbols (1 – 63 characters).	<Blank>
Password	Enter the password for mail authentication in 1-byte alphanumeric characters and symbols (1 – 63 characters).	<Blank>
Confirm password	For confirmation, enter the same password as you entered in [Password].	<Blank>
IPv4 POP3 server IP address	Enter the POP3 server IP address (IPv4) in 1-byte numbers.	0.0.0.0
IPv4 POP3 server port number	Enter the POP3 server port number (IPv4) in 1-byte numbers (1 – 65535).	110
IPv6 POP3 server IP address	Enter the POP3 server IP address (IPv6) in 1-byte numbers.	<Blank>
IPv6 POP3 server port number	Enter the POP3 server port number (IPv6) in 1-byte numbers (1 – 65535).	110
POP before SMTP response time	Enter the SMTP authentication timeout period after POP3 authentication (unit: milliseconds) using 1-byte numbers (0 – 9999 milliseconds).	300

Sending a Test Mail

You can send a test mail to the mail address specified in [Mail] under [Mail] in the settings screen by clicking [Send test mail] at the bottom of the screen.

SNMP Settings [SNMP]

From [SNMP] in the settings screen, you can configure the settings related to control of projectors which use SNMP (Simple Network Management Protocol). For the setting procedure, see “Network Setting” (P73).

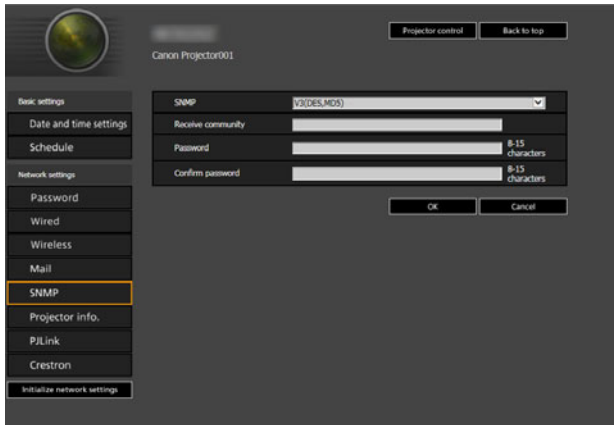

Item	Explanation	Factory default setting
SNMP	Select the SNMP function version. If [OFF] is selected, the other settings in this screen cannot be configured.	OFF
Receive community	Enter the community name which will receive projector information in 1-byte alphanumeric characters and symbols (1 – 15 characters).	<Blank>
Password	Enter the community settings password in 1-byte alphanumeric characters and symbols (8 – 15 characters). It can be set only when the SNMP version is V3.	<Blank>
Confirm password	For confirmation, enter the same password as you entered in [Password].	<Blank>

Setting Projector Information [Projector info.]

From [Projector info.] in the settings screen, you can enter relevant comments such as projector names and locations where projectors are installed so that the information can be used to identify projectors when multiple projectors are installed on the network. For the setting procedure, see “Network Setting” (P73).

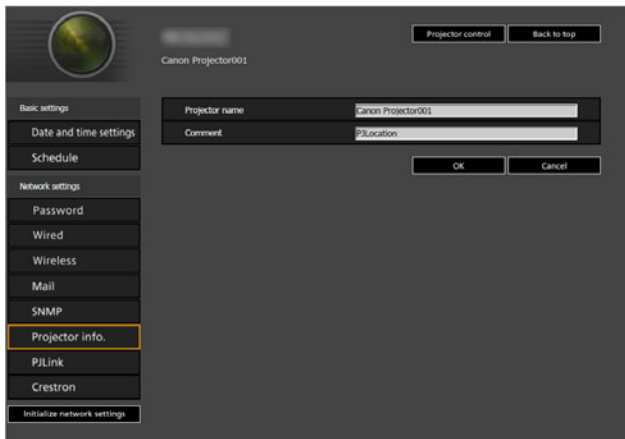

Item	Explanation	Factory default setting
Projector name	Enter the projector name in 1-byte alphanumeric characters and symbols (1 – 63 characters).	Canon Projector001
Comment	Enter any relevant notes, such as where the projector is installed.	<Blank>



Some characters such as # cannot be used for [Projector name] and [Comment].

Setting PJLink [PJLink]

From [PJLink] in the settings screen, you can set the PJLink functions which are the standard for projector management on a network. For the setting procedure, see “Network Setting” (P73). For information about PJLink, see “What is PJLink?” (P170).

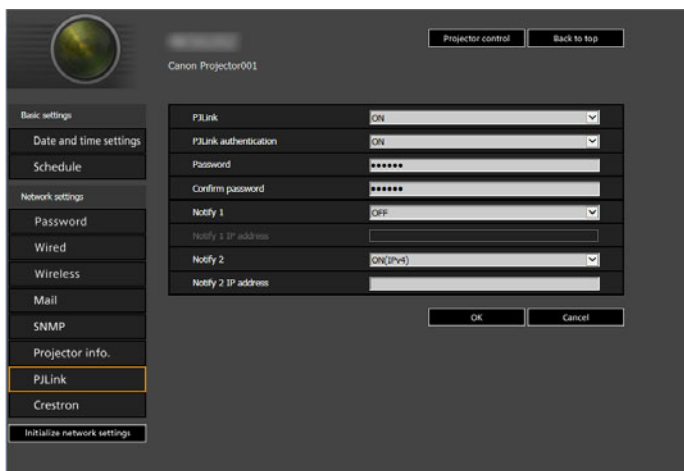

Item	Explanation	Factory default setting
PJLink	Turn the PJLink function on or off. If [OFF] is selected, the other settings in this screen cannot be configured.	ON
PJLink authentication	Select whether to turn the PJLink authentication function on or off. If [OFF] is selected, it is not possible to change the following items. [Password] [Confirm password]	ON
Password	Enter the PJLink authentication password in 1-byte alphanumeric characters (1 – 32 characters).	system
Confirm password	For confirmation, enter the same password that you entered in [Password].	system
Notify 1	Specify whether to send spontaneous state notification. Choosing [OFF] will prevent you from configuring [Notify 1 IP Address].	OFF
Notify 1 IP Address	If [Notify 1] is [ON], specify the IP address to receive notification.	<Blank>
Notify 2	Configure for notification to multiple recipients.	OFF
Notify 2 IP Address	If [Notify 2] is [ON], specify the IP address to receive notification.	<Blank>

Setting Up a Controller Manufactured by Crestron Electronics [Crestron]

The [Crestron e-Control] screen will open. For details on the Crestron Controller, visit the Crestron website.

<http://www.crestron.com>

Maintenance / Product Specifications / Troubleshooting

Cleaning the Projector

Clean the projector frequently to prevent dust from settling on the surface. A dirty lens may ruin the quality of the projected image.



Do not use adhesives, lubricants, oils, or alkaline detergents for maintenance of the projector. They could adhere to the cabinet and damage it, possibly resulting in the projector falling from its mounting and causing an accident or personal injury.



Before cleaning the projector, always turn it off, unplug it after the cooling fan stops, and wait at least one hour. Otherwise, you may get burned because the main unit is very hot immediately after the projector is turned off.

Wipe the projector's main unit softly with a soft cloth. If the projector is heavily soiled, soak the cloth in water with a small amount of detergent in it, squeeze the cloth thoroughly, and then wipe the projector with it. After cleaning, wipe the projector with a dry cloth.

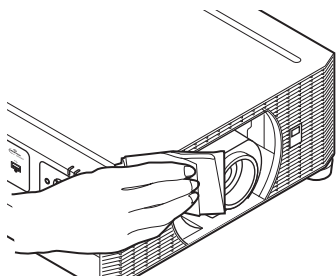

Caution

- Never use volatile cleaning liquid or benzene, as these may damage the finish of the projector.
- Do not use a chemical dust cloth.
- The lens surface is easily damaged, so do not use a hard cloth or tissues.

Replacing the Air Filter

Follow the procedure below when replacing the air filter.

- 1 Turn off the projector power and remove the power plug.**
- 2 Place your finger on the notch under the filter unit on the side of the projector and pull the filter unit out.**

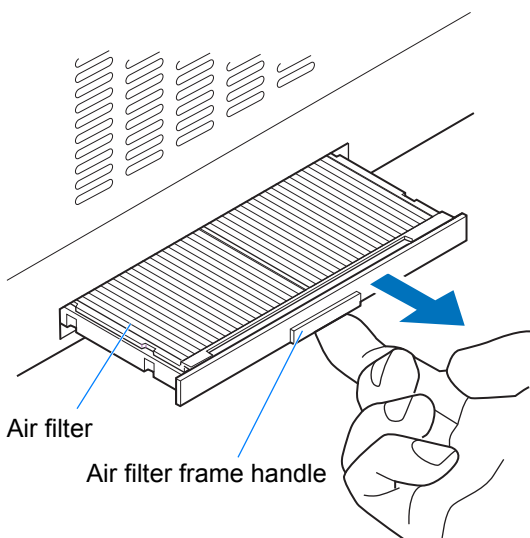
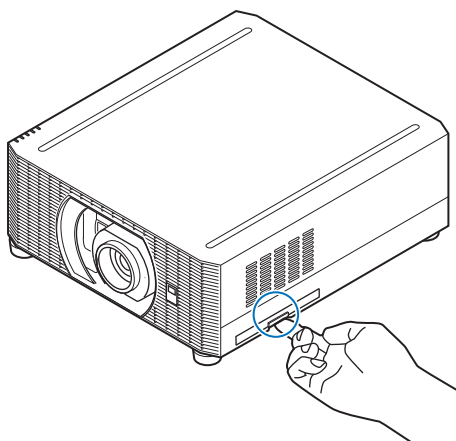

- 3** Press up on the air filter from below and remove it from the air filter frame.

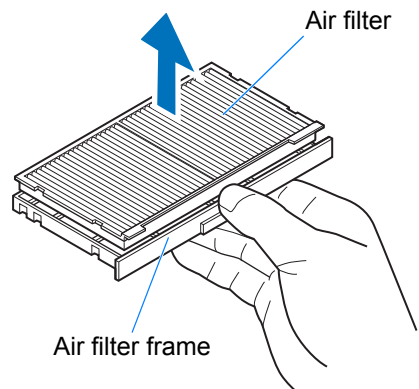

- 4** Install a new air filter in the air filter frame.

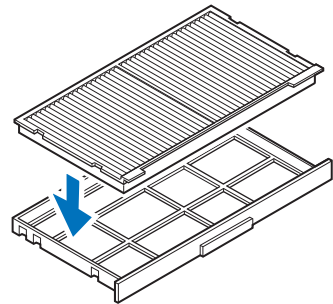

- 5** Securely insert the frame holding the air filter, all the way into the projector.

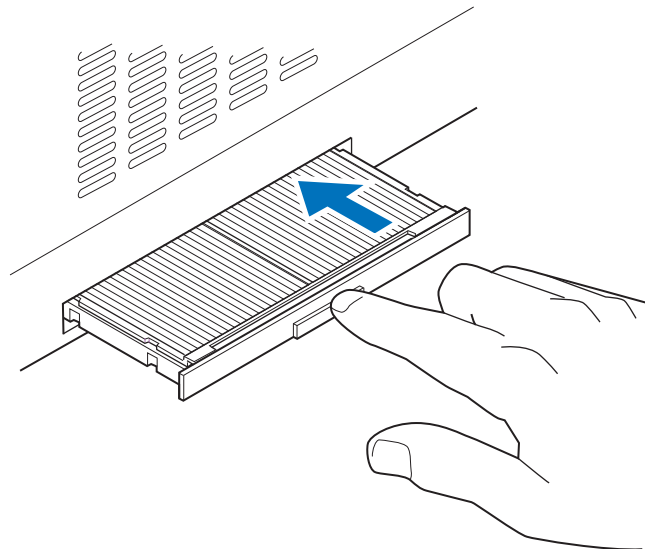

- After air filter replacement, reset [Air filter counter] (P156).
- Handle the air filter carefully. If damaged, the air filter will not work properly.
- To purchase an air filter (part no: RS-FL05), contact the Canon Customer Support Center.

Product Specifications

■ Supported Signal Types

This projector supports the following signal types.

The projector automatically projects input signals correctly from computers or AV equipment compatible with any of these signals.

YCbCr422 can be received at 12-bit color depth for all signal types (excluding frequencies preceded by (*6)).

Compatibility with all computers is not guaranteed.

FP : Front porch

SW : Sync width

BP : Back porch

HDMI

Resolution	Frequency			Blanking information		Supported color depth
	Horizontal	Vertical	Dot clock	Horizontal	Vertical	
	[kHz]	[Hz]	[MHz]	FP, SW, BP	FP, SW, BP	[bit]
640x480	31.469	59.940	25.175	16, 96, 48	10, 2, 33	8/10/12
720x480	31.469	59.940	27.000	16, 62, 60	9, 6, 30	8/10/12
720x576	31.250	50.000	27.000	12, 64, 68	5, 5, 39	8/10/12
800x600	37.879	60.317	40.000	40, 128, 88	1, 4, 23	8/10/12
1280x720	18.000	24.000	59.400	1760, 40, 220	5, 5, 20	8/10/12
	37.500	50.000	74.250	440, 40, 220	5, 5, 20	8/10/12
	45.000	60.000	74.250	110, 40, 220	5, 5, 20	8/10/12
1024x768	48.363	60.004	65.000	24, 136, 160	3, 6, 29	8/10/12
1366x768	47.712	59.790	85.500	70, 143, 213	3, 3, 24	8/10/12
	48.000	(*1)60.000	72.000	14, 56, 64	1, 3, 28	8/10/12
1440x900	55.935	59.887	106.500	80, 152, 232	3, 6, 25	8/10/12
	55.469	59.901	88.750	48, 32, 80	3, 6, 17	8/10/12
1280x1024	63.981	60.020	108.000	48, 112, 248	1, 3, 38	8/10/12
1920x1080(l)	28.125	25.000	74.250	528, 44, 148	4.5, 10, 30.5	8/10/12
	31.250	(*1)25.000	72.000	32, 168, 184	45.5, 10, 114.5	8/10/12
	33.750	30.000	74.250	88, 44, 148	4.5, 10, 30.5	8/10/12
1920x1080	27.000	24.000	74.250	638, 44, 148	4, 5, 36	8/10/12
	56.250	50.000	148.500	528, 44, 148	4, 5, 36	8/10/12
	67.500	60.000	148.500	88, 44, 148	4, 5, 36	8/10/12
2048x1080	66.576	(*1)59.924	147.000	48, 32, 80	3, 10, 18	8/10/12
	67.500	60.000	148.500	44, 44, 64	4, 5, 36	8/10/12
2560x1080	26.400	24.000	99.000	998, 44, 148	4, 5, 11	8/10/12
	56.250	50.000	185.625	548, 44, 148	4, 5, 36	8/10/12
	66.636	(*1)59.978	181.250	48, 32, 80	3, 10, 18	8/10/12
1920x1200	66.000	60.000	198.000	248, 44, 148	4, 5, 11	8/10/12
	74.038	59.950	154.000	48, 32, 80	3, 6, 26	8/10/12
	74.556	59.885	193.250	136, 200, 336	3, 6, 36	8/10/12
2048x1200	74.582	(*1)59.905	205.250	136, 216, 352	3, 10, 32	8/10/12
	74.100	(*1)60.000	157.684	8, 32, 40	21, 8, 6	8/10/12
2560x1440	88.787	59.951	241.500	48, 32, 80	3, 5, 33	8/10/12
2560x1600	98.713	59.972	268.500	48, 32, 80	3, 6, 37	8/10/12
3840x2160	52.593	(*1)23.993	266.750	216, 400, 616	3, 5, 24	8/10/12
	52.438	(*1)23.999	209.750	48, 32, 80	3, 5, 17	8/10/12
	54.000	24.000	297.000	1276, 88, 296	8, 10, 72	8/10/12(*3)
	56.250	25.000	297.000	1056, 88, 296	8, 10, 72	8/10/12(*3)
	67.500	30.000	297.000	176, 88, 296	8, 10, 72	8/10/12(*3)
	112.500	(*2)50.000	594.000	1056, 88, 296	8, 10, 72	8/10/12(*4)
135.000	(*2)60.000	594.000	176, 88, 296	8, 10, 72	8/10/12(*4)	

Product Specifications

Resolution	Frequency			Blanking information		Supported color depth
	Horizontal	Vertical	Dot clock	Horizontal	Vertical	
	[kHz]	[Hz]	[MHz]	FP, SW, BP	FP, SW, BP	[bit]
4096x2160	52.561	(*1)23.979	284.250	224, 432, 656	3, 10, 19	8/10/12
	52.397	(*1)23.980	223.000	48, 32, 80	3, 10, 12	8/10/12
	54.000	24.000	297.000	1020, 88, 296	8, 10, 72	8/10/12(*3)
	56.250	25.000	297.000	968, 88, 128	8, 10, 72	8/10/12(*3)
	67.500	30.000	297.000	88, 88, 128	8, 10, 72	8/10/12(*3)
	112.500	(*2)50.000	594.000	968, 88, 128	8, 10, 72	8/10/12(*4)
	135.000	(*2)60.000	594.000	88, 88, 128	8, 10, 72	8/10/12(*4)

*1: EDID is not supported.

*2: YCbCr420 only in EDID mode when [High compatibility] is selected.

*3: 10- and 12-bit color depth are available in EDID mode when [Wide bandwidth (4K60Hz)] is selected.

*4: 10- and 12-bit color depth are available for YCbCr420 in EDID mode when [Wide bandwidth (4K60Hz)] is selected.

FP : Front porch

SW : Sync width

BP : Back porch

DisplayPort (Single input)

Resolution	Frequency			Blanking information		Supported color depth
	Horizontal	Vertical	Dot clock	Horizontal	Vertical	
	[kHz]	[Hz]	[MHz]	FP, SW, BP	FP, SW, BP	[bit]
640x480	31.469	59.940	25.175	16, 96, 48	10, 2, 33	8/10/12
720x480	31.469	59.940	27.000	16, 62, 60	9, 6, 30	8/10/12
720x576	31.250	50.000	27.000	12, 64, 68	5, 5, 39	8/10/12
800x600	37.879	60.317	40.000	40, 128, 88	1, 4, 23	8/10/12
1280x720	18.000	24.000	59.400	1760, 40, 220	5, 5, 20	8/10/12
	37.500	50.000	74.250	440, 40, 220	5, 5, 20	8/10/12
	45.000	60.000	74.250	110, 40, 220	5, 5, 20	8/10/12
1024x768	48.363	60.004	65.000	24, 136, 160	3, 6, 29	8/10/12
1366x768	47.712	59.790	85.500	70, 143, 213	3, 3, 24	8/10/12
	48.000	(*1)60.000	72.000	14, 56, 64	1, 3, 28	8/10/12
1440x900	55.935	59.887	106.500	80, 152, 232	3, 6, 25	8/10/12
	55.469	59.901	88.750	48, 32, 80	3, 6, 17	8/10/12
1280x1024	63.981	60.020	108.000	48, 112, 248	1, 3, 38	8/10/12
1920x1080(l)	28.125	25.000	74.250	528, 44, 148	4.5, 10, 30.5	8/10/12
	33.750	30.000	74.250	88, 44, 148	4.5, 10, 30.5	8/10/12
1920x1080	27.000	24.000	74.250	638, 44, 148	4, 5, 36	8/10/12
	56.250	50.000	148.500	528, 44, 148	4, 5, 36	8/10/12
	67.500	60.000	148.500	88, 44, 148	4, 5, 36	8/10/12
2048x1080	66.576	(*1)59.924	147.000	48, 32, 80	3, 10, 18	8/10/12
	67.500	60.000	148.500	44, 44, 64	4, 5, 36	8/10/12
2560x1080	26.400	24.000	99.000	998, 44, 148	4, 5, 11	8/10/12
	56.250	50.000	185.625	548, 44, 148	4, 5, 36	8/10/12
	66.636	(*1)59.978	181.250	48, 32, 80	3, 10, 18	8/10/12
	66.000	60.000	198.000	248, 44, 148	4, 5, 11	8/10/12
1920x1200	74.556	59.885	193.250	136, 200, 336	3, 6, 36	8/10/12
	74.038	59.950	154.000	48, 32, 80	3, 6, 26	8/10/12
2048x1200	74.582	(*1)59.905	205.250	136, 216, 352	3, 10, 32	8/10/12
	74.100	(*1)60.000	157.684	8, 32, 40	21, 8, 6	8/10/12
2560x1440	88.787	59.951	241.500	48, 32, 80	3, 5, 33	8/10/12
2560x1600	98.713	59.972	268.500	48, 32, 80	3, 6, 37	8/10/12

Product Specifications

Resolution	Frequency			Blanking information		Supported color depth
	Horizontal	Vertical	Dot clock	Horizontal	Vertical	
	[kHz]	[Hz]	[MHz]	FP, SW, BP	FP, SW, BP	
3840x2160	52.593	(*1)23.993	266.750	216, 400, 616	3, 5, 24	8/10/12
	52.438	(*1)23.999	209.750	48, 32, 80	3, 5, 17	8/10/12
	54.000	24.000	297.000	1276, 88, 296	8, 10, 72	8/10/12
	56.250	25.000	297.000	1056, 88, 296	8, 10, 72	8/10/12
	67.500	30.000	297.000	176, 88, 296	8, 10, 72	8/10/12
	110.500	(*1)49.977	442.000	48, 32, 80	3, 5, 43	8/10/-
	112.500	50.000	594.000	1056, 88, 296	8, 10, 72	8/-/-
	133.187	(*1)59.940	522.092	8, 32, 40	48, 8, 6	8/-/-
	133.313	(*1)59.997	533.250	48, 32, 80	3, 5, 54	8/-/-
133.320	(*1)60.000	522.614	8, 32, 40	48, 8, 6	8/-/-	
135.000	60.000	594.000	176, 88, 296	8, 10, 72	8/-/-	
4096x2160	52.561	(*1)23.979	284.250	224, 432, 656	3, 10, 19	8/10/12
	52.397	(*1)23.980	223.000	48, 32, 80	3, 10, 12	8/10/12
	54.000	24.000	297.000	1020, 88, 296	8, 10, 72	8/10/12
	56.250	25.000	297.000	968, 88, 128	8, 10, 72	8/10/12
	67.500	30.000	297.000	88, 88, 128	8, 10, 72	8/10/12
	110.550	(*1)50.000	470.500	48, 32, 80	3, 10, 38	8/10/-
	112.500	50.000	594.000	968, 88, 128	8, 10, 72	8/-/-
	133.187	(*1)59.940	556.188	8, 32, 40	48, 8, 6	8/-/-
	133.282	(*1)59.983	567.250	48, 32, 80	3, 10, 49	8/-/-
133.320	(*1)60.000	556.744	8, 32, 40	48, 8, 6	8/-/-	
135.000	60.000	594.000	88, 88, 128	8, 10, 72	8/-/-	

*1: EDID is not supported.

FP : Front porch
SW : Sync width
BP : Back porch

DisplayPort (Multi input)

Resolution (*5)	Frequency			Blanking information		Supported color depth
	Horizontal	Vertical	Dot clock	Horizontal	Vertical	
	[kHz]	[Hz]	[MHz]	FP, SW, BP	FP, SW, BP	
1280x480	31.469	59.940	25.175	16, 96, 48	10, 2, 33	8/10/12
2560x1600	98.611	(*1)59.910	142.000	48, 32, 80	3, 10, 33	8/10/12
3840x2160	112.500	(*1)50.000	297.000	528, 44, 148	8, 10, 72	8/10/12
	133.293	(*1)59.988	277.250	48, 32, 80	3, 10, 49	8/10/12
	133.320	(*1)60.000	266.640	8, 32, 40	48, 8, 6	8/10/12
	135.000	60.000	297.000	88, 44, 148	8, 10, 72	8/10/12
4096x2160	112.500	(*1)50.000	297.000	484, 44, 64	8, 10, 72	8/10/12
	133.265	(*1)59.975	294.250	48, 32, 80	3, 10, 49	8/10/12
	133.320	(*1)60.000	283.704	8, 32, 40	48, 8, 6	8/10/12
	135.000	60.000	297.000	44, 44, 64	8, 10, 72	8/10/12

*1: EDID is not supported.

*5: Resolution when using two ports in combination (For example, if the resolution is listed as 1280x480, the single-port resolution is 640x480.)

FP : Front porch
SW : Sync width
BP : Back porch

HDBaseT

Resolution	Frequency			Blanking information		Supported color depth
	Horizontal	Vertical	Dot clock	Horizontal	Vertical	
	[kHz]	[Hz]	[MHz]	FP, SW, BP	FP, SW, BP	
640x480	31.469	59.940	25.175	16, 96, 48	10, 2, 33	8/10/12
720x480	31.469	59.940	27.000	16, 62, 60	9, 6, 30	8/10/12
720x576	31.250	50.000	27.000	12, 64, 68	5, 5, 39	8/10/12
800x600	37.879	60.317	40.000	40, 128, 88	1, 4, 23	8/10/12

Product Specifications

Resolution	Frequency			Blanking information		Supported color depth
	Horizontal	Vertical	Dot clock	Horizontal	Vertical	
	[kHz]	[Hz]	[MHz]	FP, SW, BP	FP, SW, BP	[bit]
1280x720	18.000	24.000	59.400	1760, 40, 220	5, 5, 20	8/10/12
	37.500	50.000	74.250	440, 40, 220	5, 5, 20	8/10/12
	45.000	60.000	74.250	110, 40, 220	5, 5, 20	8/10/12
1024x768	48.363	60.004	65.000	24, 136, 160	3, 6, 29	8/10/12
1366x768	47.712	59.790	85.500	70, 143, 213	3, 3, 24	8/10/12
	48.000	(*1)60.000	72.000	14, 56, 64	1, 3, 28	8/10/12
1440x900	55.935	59.887	106.500	80, 152, 232	3, 6, 25	8/10/12
	55.469	59.901	88.750	48, 32, 80	3, 6, 17	8/10/12
1280x1024	63.981	60.020	108.000	48, 112, 248	1, 3, 38	8/10/12
1920x1080(l)	31.250	(*1)25.000	72.000	32, 168, 184	45.5, 10, 114.5	8/10/12
	28.125	25.000	74.250	528, 44, 148	4.5, 10, 30.5	8/10/12
	33.750	30.000	74.250	88, 44, 148	4.5, 10, 30.5	8/10/12
1920x1080	27.000	24.000	74.250	638, 44, 148	4, 5, 36	8/10/12
	56.250	50.000	148.500	528, 44, 148	4, 5, 36	8/10/12
	67.500	60.000	148.500	88, 44, 148	4, 5, 36	8/10/12
2048x1080	66.576	(*1)59.924	147.000	48, 32, 80	3, 10, 18	8/10/12
	67.500	60.000	148.500	44, 44, 64	4, 5, 36	8/10/12
2560x1080	26.400	24.000	99.000	998, 44, 148	4, 5, 11	8/10/12
	56.250	50.000	185.625	548, 44, 148	4, 5, 36	8/10/12
	66.636	(*1)59.978	181.250	48, 32, 80	3, 10, 18	8/10/12
	66.000	60.000	198.000	248, 44, 148	4, 5, 11	8/10/12
1920x1200	74.556	59.885	193.250	136, 200, 336	3, 6, 36	8/10/12
	74.038	59.950	154.000	48, 32, 80	3, 6, 26	8/10/12
2048x1200	74.582	(*1)59.905	205.250	136, 216, 352	3, 10, 32	8/10/-
	74.100	(*1)60.000	157.684	8, 32, 40	21, 8, 6	8/10/12
2560x1440	88.787	59.951	241.500	48, 32, 80	3, 5, 33	8/-/-
2560x1600	98.713	59.972	268.500	48, 32, 80	3, 6, 37	8/-/-
3840x2160	52.593	(*1)23.993	266.750	216, 400, 616	3, 5, 24	8/-/-
	52.438	(*1)23.999	209.750	48, 32, 80	3, 5, 17	8/10/-
	54.000	24.000	297.000	1276, 88, 296	8, 10, 72	8/-/-
	56.250	25.000	297.000	1056, 88, 296	8, 10, 72	8/-/-
	67.500	30.000	297.000	176, 88, 296	8, 10, 72	8/-/-
	112.500	(*6)50.000	594.000	1056, 88, 296	8, 10, 72	8/-/-
	135.000	(*6)60.000	594.000	176, 88, 296	8, 10, 72	8/-/-
4096x2160	52.561	(*1)23.979	284.250	224, 432, 656	3, 10, 19	8/-/-
	52.397	(*1)23.980	223.000	48, 32, 80	3, 10, 12	8/10/-
	54.000	24.000	297.000	1020, 88, 296	8, 10, 72	8/-/-
	56.250	25.000	297.000	968, 88, 128	8, 10, 72	8/-/-
	67.500	30.000	297.000	88, 88, 128	8, 10, 72	8/-/-
	112.500	(*6)50.000	594.000	968, 88, 128	8, 10, 72	8/-/-
	135.000	(*6)60.000	594.000	88, 88, 128	8, 10, 72	8/-/-

*1: EDID is not supported.

*6: YCbCr420 only

* HDBaseT signals are signals conforming to the HDBaseT specification. They are carried in a cable as HDBaseT signals and supplied to the projector before conversion to HDMI signals. Any HDBaseT signals received by the projector that cannot be converted back to HDMI signals listed in the table may not be projected correctly.

■ Projector

Model name		4K6021Z
Display system		Reflective liquid crystal panel (LCOS) : 3 panels
Optical system		Color separation by dichroic mirror / polarizing beam splitter and color composition by prism
Display device	Effective display area size	0.74" / approx. 17:9
	Effective number of pixels	8,847,360 (4096 x 2160)
	Other features	Active matrix system
Projection lens	Zoom (*4)	1.76x
	Focus	Electric
	Lens shift (*4)(*5)	V: -73% to +73% (Electric), H: ±11% (Electric)
	Focal length (*4)	22.67 to 39.79 mm (0.9" - 1.6")
	F value (*4)	F2.1 to F2.4
Light source	Type	Blue laser diode + yellow phosphor
Image size / Projection distance (*4)		Minimum: 101.6 cm (40") to Maximum: 1524 cm (600"), Projection distance: 1.2 m to 31.7 m (3.9'- 104.0')
Number of colors		1,073,000,000 colors
Brightness (*1) (*2)		6000lm
Contrast ratio (*1) (*3)		6,000,000:1
Ratio of brightness at periphery to center (*1) (*4)		80% or more
Supported input signal types		See "Supported Signal Types" (P193 – P196)
Display resolution	Computer signal input	Maximum input resolution 4096 x 2160 dots
	Video signal input	Maximum input resolution 4096 x 2160 dots
Video signals	Digital image input	640 x 480, 720 x 480, 720 x 576, 800 x 600, 1280 x 720, 1024 x 768, 1366 x 768, 1440 x 900, 1280 x 1024, 1920 x 1080, 2048 x 1080, 2560 x 1080, 1920 x 1200, 2048 x 1200, 2560 x 1440, 2560 x 1600, 3840 x 2160, 4096 x 2160
Video signal input terminal	HDMI x 2	Digital PC, Digital Video
	DisplayPort x 2	Digital PC, Digital Video
	RJ-45	HDBaseT input (video / audio / control / network)
Other terminals and connectors	Mini jack	Trigger out
	Mini jack	AUDIO OUT
	Mini jack	Wired remote control
	RS-232C	CONTROL (Dsub9)
	USB	USB Type A
Noise (Light source mode: Normal / Quiet 1 / Quiet 2)		38 / 33 / 29 dB
Operating temperature		0°C (32°F) to 45°C (113°F)
Power supply		AC100V to 240V 50 / 60Hz
Maximum power consumption		625W

Product Specifications

Model name		4K6021Z
Power consumption in standby mode	Networking off, Serial communication: Service port	0.25W
	Networking on, Serial communication: Service port	1.6W
	Networking off, Serial communication: HDBaseT	1.5W
	Networking on, Serial communication: HDBaseT	1.6W
Standard dimensions		480 mm (W) x 196 mm (H) x 545 mm (D) / 18.9 (W) x 7.7 (H) x 21.5 (D) in 480 mm (W) x 175 mm (H) x 545 mm (D) / 18.9 (W) x 6.9 (H) x 21.5 (D) in (excluding protrusions)
Weight		Approx. 19 kg / 41.9 lbs (not including projection lens unit)
Accessories		Remote control, remote control dry-cell batteries, power cord, Important Information and Warranty Card
Wireless connectivity	Standards	IEEE802.11b/g/n
	Supported channels	1 CH - 11 CH
	Frequency band	2.4 GHz

(*1) Compliance with ISO21118-2012

(*2) When using a Standard 4K Zoom Lens (RS-SL07RST) under the following conditions:
[Image mode] > [Presentation], [Motion blur reduction] > [Off], [Light source mode] > [Normal]
To protect the projector, light output may be lowered as the ambient temperature rises.

(*3) When using a Standard 4K Zoom Lens (RS-SL07RST) under the following conditions:
[Image mode] > [Presentation], [Motion blur reduction] > [Off], [Light source mode] > [Normal],
[Iris] > [Open], [Dynamic contrast] > [High], [Light off control] > [Enabled]

(*4) When using a Standard 4K Zoom Lens (RS-SL07RST).

(*5) In [Normal] lens shift mode

* 99.99% or more of the LCD panel pixels are effective. During projection, 0.01% or less of pixels may stay lit or unlit due to the characteristics of the LCD panel.

* Using the projector continuously for an extended period of time may accelerate the deterioration of optical parts.

* Product specifications and appearance are subject to change without prior notice.

■ Remote Control

Type	RS-RC07
Power supply	DC 3.0V, using two AAA-size batteries
Operating range	Approx. 8 m ±25° horizontal and vertical (to infrared remote receiver)
Dimensions	46.5 mm (W) x 23 mm (H) x 159 mm (D) / 1.8 (W) x 0.9 (H) x 6.3 (D) in.
Weight	56 g / 2.0 oz

■ Specification of Each Lens Unit (Option)

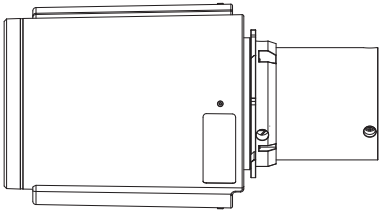
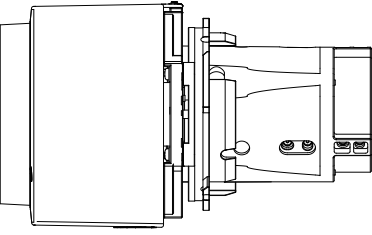
Name	Standard 4K Zoom Lens*	Long Zoom Lens
Model number	RS-SL07RST	RS-SL02LZ
External View		
Focal length	22.67 – 39.79 mm (0.9 – 1.6")	34.0 – 57.7 mm (1.3 – 2.3")
F number	2.1 – 2.4	1.99 – 2.83
Width	104 mm (4.1")	143.4 mm (5.6")
Height	126 mm (5.0")	106.7 mm (4.2")
Length	229 mm (9.0")	175.3 mm (6.9")
Weight	Approx. 1900 g (4.2 lbs)	Approx. 925 g (2.0 lbs)
Zoom ratio	1.76x	1.7x
Projection distance	1.20 – 31.71 m (3.9 – 104.0')	1.80 – 46.84 m (5.9 – 153.7')
Size 100 projection distance	3.00 – 5.29 m (9.8 – 17.4')	4.58 – 7.77 m (15.0 – 25.5')
Marginal focus	Supported	Unsupported

* For optimal projector performance, a Standard 4K Zoom Lens is recommended.

Product Specifications

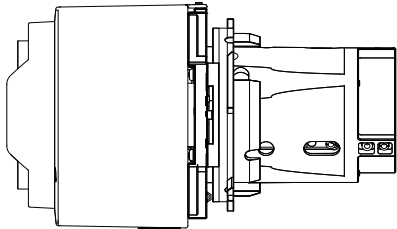
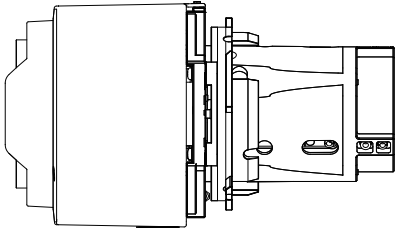
Name	Ultra-long Zoom Lens	Wide Zoom Lens
Model number	RS-SL04UL	RS-SL05WZ
External View		
Focal length	53.6 – 105.6 mm (2.1 – 4.2")	15.56 – 23.34 mm (0.6 – 0.9")
F number	2.34 – 2.81	2.09 – 2.34
Width	143.4 mm (5.6")	143.4 mm (5.6")
Height	106.7 mm (4.2")	106.7 mm (4.2")
Length	183.7 mm (7.2")	183.7 mm (7.2")
Weight	Approx. 1110 g (2.4 lbs)	Approx. 1065 g (2.3 lbs)
Zoom ratio	1.97x	1.5x
Projection distance	4.48 – 85.98 m (14.7 – 282.1')	0.83 – 18.85 m (2.7 – 61.8')
Size 100 projection distance	7.39 – 14.44 m (24.2 – 47.4')	2.08 – 3.12 m (6.8 – 10.2')
Marginal focus	Unsupported	Unsupported

For details about the amount of lens shift, see “Adjustment Using Lens Shift” ([P58](#)).

Product Specifications

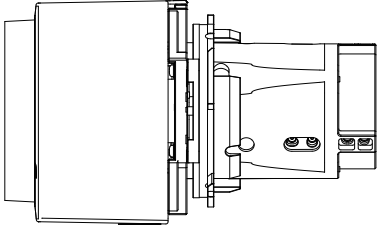
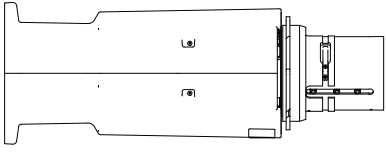
Name	Short Fixed Lens	Ultra-wide Zoom Lens
Model number	RS-SL03WF	RS-SL06UW
External View		
Focal length	12.8 mm (0.5")	8.39 mm (0.33")
F number	2.0	2.40
Width	143.4 mm (5.6")	143.4 mm (5.6")
Height	106.7 mm (4.2")	113.7 mm (4.8")
Length	175.3 mm (6.9")	304.3 mm (12.0")
Weight	Approx. 1060 g (2.3 lbs)	Approx. 1520 g (3.3 lbs)
Zoom ratio	—	—
Projection distance	0.67 – 4.99 m (2.2 – 16.4')	0.45 – 3.38 m (1.5 – 11.1')
Size 100 projection distance	1.66 m (5.4')	1.12 m (3.7')
Marginal focus	Unsupported	Supported

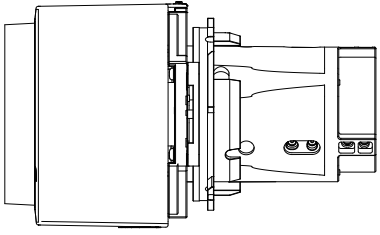
Name	Standard Zoom Lens*
Model number	RS-SL01ST
External View	
Focal length	23.0 – 34.5 mm (0.9 – 1.4")
F number	1.89 – 2.65
Width	143.4 mm (5.6")
Height	106.7 mm (4.2")
Length	175.3 mm (6.9")
Weight	Approx. 725 g (1.6 lbs)
Zoom ratio	1.5x
Projection distance	1.23 – 27.99 m (4.0 – 91.8')
Size 100 projection distance	3.10 – 4.65 m (10.2 – 15.3')
Marginal focus	Unsupported

* Though not a Standard 4K Zoom Lens, this lens offers good focus performance. For details about the amount of lens shift, see “Adjustment Using Lens Shift” (P58).

External View

4K6021Z

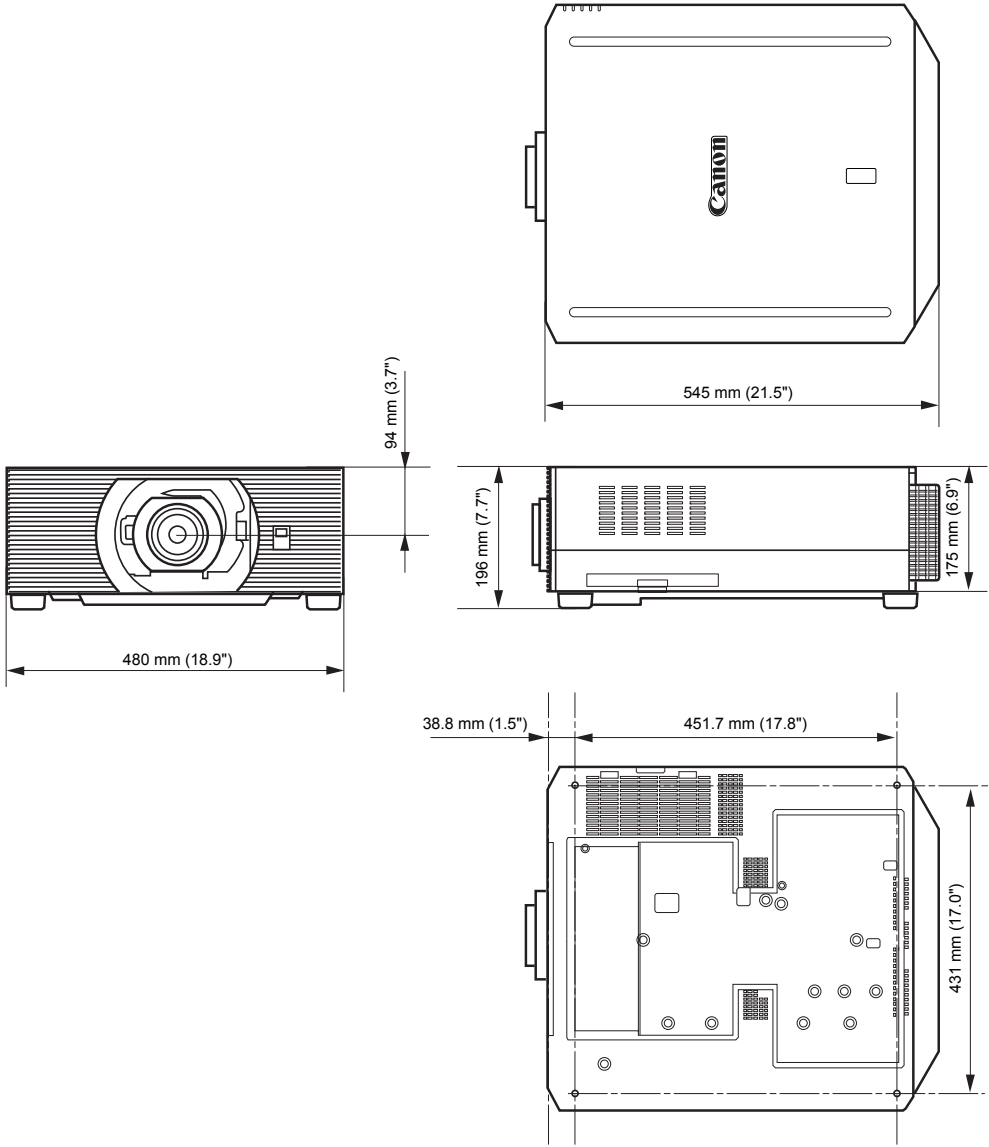

■ Service Port (CONTROL)

Pin assignment

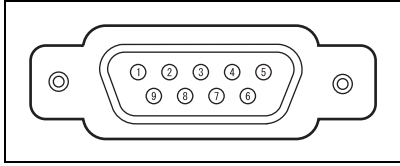

Pin No.	Signal
1	OPEN
2	RxD
3	TxD
4	OPEN
5	GND
6	OPEN
7	Internal pull-up
8	OPEN
9	OPEN

Communication format

Communication mode : RS-232C, asynchronous, half-duplex communication

Communication speed : 19200bps

Character length : 8 bits

Stop bits : Switchable between 1 bit and 2 bits. Factory default, or state after [Factory defaults] is executed, is 1 bit.

Parity : None

Flow control : None

User commands

Commands		ASCII representation	Binary representation
Power supply	Power on	POWER=ON<CR>	50h 4Fh 57h 45h 52h 3Dh 4Fh 4Eh 0Dh
	Power off	POWER=OFF<CR>	50h 4Fh 57h 45h 52h 3Dh 4Fh 46h 46h 0Dh
Power status acquisition		GET=POWER<CR>	47h 45h 54h 3Dh 50h 4Fh 57h 45h 52h 0Dh
Input source	HDBaseT	INPUT=HDBT<CR>	49h 4Eh 50h 55h 54h 3Dh 48h 44h 42h 54h 0Dh
	HDMI-1	INPUT=HDMI1<CR>	49h 4Eh 50h 55h 54h 3Dh 48h 44h 4Dh 49h 31h 0Dh
	HDMI-2	INPUT=HDMI2<CR>	49h 4Eh 50h 55h 54h 3Dh 48h 44h 4Dh 49h 32h 0Dh
	DP-1	INPUT=DP1<CR>	49h 4Eh 50h 55h 54h 3Dh 44h 50h 31h 0Dh
	DP-2	INPUT=DP2<CR>	49h 4Eh 50h 55h 54h 3Dh 44h 50h 32h 0Dh
	DP 1x2	INPUT=DP1X2<CR>	49h 4Eh 50h 55h 54h 3Dh 44h 50h 31h 58h 32h 0Dh
Input source acquisition		GET=INPUT<CR>	47h 45h 54h 3Dh 49h 4Eh 50h 55h 54h 0Dh

Product Specifications

Commands		ASCII representation	Binary representation
Image Mode	Standard	IMAGE=STANDARD<CR>	49h 4Dh 41h 47h 45h 3Dh 53h 54h 41h 4Eh 44h 41h 52h 44h 0Dh
	Presentation	IMAGE=PRESENTATION<CR>	49h 4Dh 41h 47h 45h 3Dh 50h 52h 45h 53h 45h 4Eh 54h 41h 54h 49h 4Fh 4Eh 0Dh
	Dynamic	IMAGE=DYNAMIC<CR>	49h 4Dh 41h 47h 45h 3Dh 44h 59h 4Eh 41h 4Dh 49h 43h 0Dh
	Video	IMAGE=VIDEO<CR>	49h 4Dh 41h 47h 45h 3Dh 56h 49h 44h 45h 4Fh 0Dh
	Photo/sRGB	IMAGE=PHOTO_SRGB<CR>	49h 4Dh 41h 47h 45h 3Dh 50h 48h 4Fh 54h 4Fh 5Fh 53h 52h 47h 42h 0Dh
	DICOM SIM	IMAGE=DCM_SIM<CR>	49h 4Dh 41h 47h 45h 3Dh 44h 43h 4Dh 5Fh 53h 49h 4Dh 0Dh
	User 1	IMAGE=USER_1<CR>	49h 4Dh 41h 47h 45h 3Dh 55h 53h 45h 52h 5Fh 31h 0Dh
	User 2	IMAGE=USER_2<CR>	49h 4Dh 41h 47h 45h 3Dh 55h 53h 45h 52h 5Fh 32h 0Dh
	User 3	IMAGE=USER_3<CR>	49h 4Dh 41h 47h 45h 3Dh 55h 53h 45h 52h 5Fh 33h 0Dh
	User 4	IMAGE=USER_4<CR>	49h 4Dh 41h 47h 45h 3Dh 55h 53h 45h 52h 5Fh 34h 0Dh
	User 5	IMAGE=USER_5<CR>	49h 4Dh 41h 47h 45h 3Dh 55h 53h 45h 52h 5Fh 35h 0Dh
Image mode acquisition		GET=IMAGE<CR>	47h 45h 54h 3Dh 49h 4Dh 41h 47h 45h 0Dh
Brightness	Brightness value setting	BRI=<Value><CR>	42h 52h 49h 3Dh <numeric code> 0Dh
Brightness acquisition		GET=BRI<CR>	47h 45h 54h 3Dh 42h 52h 49h 0Dh
Sharpness	Sharpness value setting	SHARP=<Value><CR>	53h 48h 41h 52h 50h 3Dh <numeric code> 0Dh
Sharpness acquisition		GET=SHARP<CR>	47h 45h 54h 3Dh 53h 48h 41h 52h 50h 0Dh
Contrast	Contrast value setting	CONT=<Value><CR>	43h 4Fh 4Eh 54h 3Dh <numeric code> 0Dh
Contrast acquisition		GET=CONT<CR>	47h 45h 54h 3Dh 43h 4Fh 4Eh 54h 0Dh
Aspect	Auto	ASPECT=AUTO<CR>	41h 53h 50h 45h 43h 54h 3Dh 41h 55h 54h 4Fh 0Dh
	True size	ASPECT=TRUE<CR>	41h 53h 50h 45h 43h 54h 3Dh 54h 52h 55h 45h 0Dh
Aspect value acquisition		GET=ASPECT<CR>	47h 45h 54h 3Dh 41h 53h 50h 45h 43h 54h 0Dh
Blank	Blank On	BLANK=ON<CR>	42h 4Ch 41h 4Eh 4Bh 3Dh 4Fh 4Eh 0Dh
	Blank Off	BLANK=OFF<CR>	42h 4Ch 41h 4Eh 4Bh 3Dh 4Fh 46h 46h 0Dh
Blank acquisition		GET=BLANK<CR>	47h 45h 54h 3Dh 42h 4Ch 41h 4Eh 4Bh 0Dh

LED Indicator Details

When there is a problem with the projector, the LED indicator on the side of the projector illuminates or flashes continuously after the projector is turned off.

- Wait until the cooling fan stops and disconnect the power plug from the power outlet before dealing with the problem.

LED indicator status	Meaning	Cause and countermeasure
WARNING and TEMP are lit.	Temperature abnormality	The temperature inside the projector is too high for some reason or the outside air temperature is higher than the operating range. If the problem is inside the projector, check whether the projector is installed and operating normally, unplug the projector from the power outlet to cool down the projector interior and then restart projection. If the air intake or exhaust vent is blocked, remove the obstacle. If the air filter is clogged, replace it (P191). If the same warning occurs again, there may be a malfunction in the projector.*
WARNING and LIGHT are lit.	Faulty light source	The light source does not illuminate. Restart the projector and check projection. If the light source does not illuminate after this, the light source drive circuit may be damaged.*
WARNING (only) flashes 3 times repeatedly.	Filter error	The air filter is not installed correctly. Install the air filter correctly and restart the projector. If the same warning occurs again, there may be a malfunction in the projector.*
WARNING (only) flashes 4 times repeatedly.	Faulty cooling fan	There may be a malfunction in the cooling fan or another component. Unplug the projector from the power outlet, then plug it back into the outlet and turn on the projector again. If the same warning occurs again, there may be a malfunction in the projector.*
WARNING (only) flashes 5 times repeatedly.	Faulty power supply	Abnormal voltage is applied to some parts in the power supply or another failure may have occurred. Unplug the projector from the power outlet, then plug it back into the outlet and turn on the projector again. If the same warning occurs again, there may be a malfunction in the projector. Unplug the projector from the power outlet.*

LED indicator status	Meaning	Cause and countermeasure
WARNING (only) flashes 6 times repeatedly.	Problem with lens unit installation	The lens unit is not installed correctly. Unplug the projector, install the lens unit correctly, and then plug the projector in again. If the same warning occurs again, there may be a malfunction in the projector.*

* Contact the Canon Customer Support Center.

Symptoms and Solutions

■ You Cannot Turn on the Projector

Cause	Countermeasure
The power cord is not connected correctly.	Check whether the power cord is connected correctly (P64).
The power cord has just been connected.	Wait at least one second after plugging the projector in until you press the POWER button. You cannot turn the projector on immediately after plugging it in (P41).
The safety device is activated because the air intake or the exhaust vent is blocked and the internal temperature of the projector has increased.	When the safety device is active, the [POWER] indicator does not turn on when you connect the power cord. You cannot disable this safety device. Remove any obstacle that is blocking the air intake or exhaust vent.*
The lens unit is not attached correctly.	The lens unit is not installed correctly. Unplug the projector, install the lens unit correctly, and then plug the projector in again. If the same warning occurs again, there may be a malfunction in the projector.*
The air filter is not installed correctly.	Check whether the air filter is installed correctly (P191).
Key lock is enabled.	Check that Key lock (P144) is not enabled for the projector or the remote control.

* Contact the Canon Customer Support Center.

■ You Cannot Project an Image from the Projector

Cause	Countermeasure
A cable is not connected correctly.	Check whether the projector is connected to the computer or AV equipment correctly (P62 – P64).
20 seconds have not elapsed since the projector was turned on.	When the projector is turned on, the opening window is displayed for approximately 20 seconds. To project an image immediately, press the OK button on the remote control or side control (P29, P33).
No image is sent from the AV equipment.	Check whether an image is played on the connected video camcorder, DVD, etc.
Connection with the input terminal has not been performed correctly.	Check whether the AV equipment is connected to the projector input terminal correctly (P32).
No input signal type has been selected for the connected AV equipment.	Check that the same input signal has been correctly selected for the connected AV equipment from the [Input] menu (P42).
The input signal type is incorrect.	Check whether the selected input signal type is correct (P193).
The BLANK function has been selected.	Press the BLANK button on the remote control (P47).
No image is projected due to a problem with the computer.	Turn first the projector and then the computer off and then back on again.
The external monitor output is not set on the computer correctly.	Turn on the external monitor output on the computer. To turn on the external monitor output, press the [LCD] or [VGA] function key or a key with an icon for the external monitor, while holding down the [Fn] key on the keyboard of the computer. With Windows 10 / Windows 8.1 / Windows 7, you can turn on image output by holding down the Windows logo key and pressing the [P] key. The combination of keys used to perform this operation varies depending on the model of computer. For more detailed information, refer to the manual that came with your computer.
The LAN cable (shielded twisted pair) is not connected correctly.	When [HDBaseT] is selected in the [Input] menu, check whether the LAN cable (shielded twisted pair) is connected to the projector correctly (P65).

■ There is no Sound

Cause	Countermeasure
The MUTE function is enabled.	Press the MUTE button on the remote control (P34).
The volume level is adjusted to the minimum.	Press the VOL button on the remote control or the VOL+ button on the side control to adjust the volume level (P29, P34).
Audio in terminal select is [Off].	Change the Audio In terminal to the appropriate setting (P145).

■ The Projected Image Is Blurred

Cause	Countermeasure
The image is out of focus.	Adjust the focus (P43).
The distance to the screen is too short.	Check whether the distance to the screen is appropriate (P51).
The projector is not placed straight in front of the screen.	Check whether the projector is placed obliquely to the screen. A slight error in the projection angle can be corrected through the keystone adjustment function (P81).
The projector has been moved to a place where the temperature varies a lot.	When the projector is moved from a location where the temperature is low to a location where the temperature is high, condensation may form on the lens. The condensation will evaporate after a period of time and the projector will be able to project a normal image.
The lens is stained.	Clean the lens (P191).
Video is blurred.	Activate motion blur reduction (P149).
Motion blur reduction is not available.	[Motion blur reduction] is not available in [DICOM SIM] image mode. The menu is grayed out.
The lens unit is not installed correctly.	Check whether the lens unit is installed correctly (P53).
The lens lever is not engaged.	Check whether the lens unit is installed correctly (P53).

■ You Cannot Project an Image Appropriately

Cause	Countermeasure
The projected image is inverted in the vertical or horizontal direction.	The ceiling mounted / rear projection setting is incorrect. Check the [Image flip H/V] setting in the [Install settings] menu (P128).
A computer cable is used in which some pins are not connected.	Use a computer cable in which all pins are connected.

■ The Projector Power Turns Off

Cause	Countermeasure
The air intake or exhaust vent is blocked.	Check whether the air intake or exhaust vent is blocked. If the air intake or exhaust vent is blocked, the temperature inside the projector will increase and the power is automatically turned off to protect the projector (The [WARNING] indicator and [TEMP] indicator are lit.). Wait until the projector temperature drops, then make sure that the intake and exhaust vents are not blocked and turn on the projector (P22, P28).
The air filter is dirty.	Check whether the air filter is clogged with dust. If the air filter is clogged, replace the air filter (P191).
The operating environment is inappropriate.	Check whether the operating temperature is between 0°C (32°F) and 45°C (113°F) (P21). Projector settings must be adjusted when using the projector at altitudes of 2,300 m (7,545.8') or higher. In the [Install settings] menu, set [High altitude] under [Professional settings] to [On] (P133).

■ The Projector Cannot Join the Network

Cause	Countermeasure
The LAN cable (shielded twisted pair) is not connected correctly.	Check whether the LAN cable (shielded twisted pair) is connected to the projector correctly (P65).
The projector has not been on long enough (less than about 40 seconds).	Network functions are not available until about 40 seconds after the projector is plugged in. Wait at least 40 seconds, and then try to connect again (P71).

Cause	Countermeasure
The projector cannot join a wireless network.	Follow the instructions in “Network Setting” (P73 – P74) and “Detailed settings (wireless)” (P165 – P169) to set up the projector again. In PJ AP mode, try changing the wireless channel on the projector (P165 – P169). In infrastructure mode, try changing the wireless channel on the access point. If connection is still not possible, contact the Canon Customer Support Center.
A HDBaseT transmitter or similar device is not on.	Check the power of the HDBaseT transmitter.

■ You Cannot Operate the Remote Control

Cause	Countermeasure
Batteries are not installed properly or they have run out.	Check whether batteries are installed correctly. If batteries are installed correctly, replace them with new batteries (P35).
You are operating the remote control from the outside of the remote control operating range.	Check whether you are operating the remote control within the remote control operating range of the main unit of the projector (P36).
There is an obstacle between the projector and the remote control.	Remove the obstacle between the infrared remote receiver of the main unit of the projector and the remote control or point the remote control in an obstacle-free path.
You are operating the remote control in an unsuitable operating environment.	Check whether the infrared remote receiver of the main unit of the projector is exposed to direct sunlight or strong light of lighting apparatus (P36).
The channel setting of the remote control does not match the setting of the projector.	Check whether the channel setting of the remote control has been changed. You can check the [Remote control channel] setting in the [System settings] menu (P145).
The key lock function is preventing operation of the remote control.	Check whether [Key lock] is enabled to disable the remote control operation. In the [System settings] menu, set [Key lock] to [Off] (P144).
Light from the room lights is entering the infrared remote receiver.	Block the light.

Numerics

6-axis color adjust 123

A

Adjusting the Volume 49

Advanced registration 131

Air filter 191

Ambient light 120

AMX Device Discovery 171

AUDIO OUT terminal 32

B

BLANK 47

Brightness 118

C

Calibration 155

Ceiling mounted 128

Contrast 118

Crestron RoomView 171

D

Date and time settings 151

DICOM SIM 45

Digital noise reduction 121

Digital zoom 33

Direct power on 148

Display resolution (Preparing the
computer) 43

DisplayPort 32, 62

Dynamic gamma 121

E

Edge blending 4, 96, 134

Effect of ambient light 120

F

Firmware 157

FREEZE 47

G

Gamma 119

H

HDBaseT 4, 146

HDBaseT terminal 32, 63, 65

HDMI terminal 32, 62

HDR 123

HDR10 123

High altitude 133

HLG 123

I

Image adjustment 104, 117

Information 104, 173

Input settings 104, 113

Input terminal 32

Install settings 104, 127

Iris 138

K

Key lock 144

Keystone 129

L

Language 149

LED indicator 30, 205

Lens - Position 137

Light source mode 125

Logo display 141

M

Marginal focus 134

Memory color correction 123

MENU 102

Menu 102

MUTE 49

Muting the sound 49

N

Network password 159

Network settings 104, 158

O

On screen 141

Operating mode 133

P

Partial distortion correction 132

Password 150, 151

PJLink 170, 188

Power counter 156

Power supply settings 147

Power-Saving Settings 48

Projector on 141

R

Random noise reduction 121

Rear projection 128

Remote control 33, 35, 145

Reset 126, 157

S

Schedule 152

Screen color 138

Selecting a language 149

Setting display status 113

Sharpness 119

Side control 29

Signal type 193

Supported Signal Types 193

System settings 104, 139

T

Terminals and connectors 32

Test pattern 92

U

USB Port 32, 157

W

WARNING indicator 30, 205

Wireless Networks 66, 165

Option

- | | |
|--|--|
| <ul style="list-style-type: none">• Ceiling attachment
Part No.: RS-CL15*¹• Ceiling-mount arm
Part No.: RS-CL17*¹• Ceiling-mount pipe
(350 – 550 mm / 13.8 – 21.7 in)
Part No.: RS-CL08*²• Ceiling-mount pipe
(550 – 950 mm / 21.7 – 37.4 in)
Part No.: RS-CL09*² | <ul style="list-style-type: none">• Air filter
Part No.: RS-FL05• Remote control
Part No.: RS-RC07• Remote control
Part No.: RS-RC05 |
|--|--|

*1 When mounting the projector on the ceiling, both ceiling attachment (RS-CL15) and ceiling-mount arm (RS-CL17) are required.

*2 Use the above materials to hang the projector from the ceiling.



CANON INC.

30-2, Shimomaruko 3-chome, Ohta-ku, Tokyo 146-8501, Japan

CANON U.S.A. INC.

One Canon Park, Melville, New York 11747, U.S.A.

For all inquires concerning this product, call toll free in the U.S. 1-800-OK-CANON

CANON EUROPE LTD.

3 The Square, Stockley Park, Uxbridge, Middlesex, UB11 1ET United Kingdom

CANON EUROPA N.V.

Bovenkerkerweg 59, 1185 XB Amstelveen, The Netherlands