



# Preface

## Audience

This guide is for the network or computer technician responsible for installing the Perle IRG5540/5540+/5541/5541+ router also generically referred to as the IRG554x within this document. All “+” models support worldwide global coverage for LTE. Models IRG5541/5541+ also have integrated Wireless LAN 2.4/5 GHz capabilities. Familiarity with the concepts and terminology of LTE, GNSS, Ethernet, and LAN (local area networks) is required.

## Purpose

Perle routers provide users, networking equipment, as well as M2M & IoT appliances with network connectivity for fixed locations (i.e. buildings, POS, Kiosks, ...etc.) and mobile (i.e. vehicle, trains, robots) applications. In vehicular applications, the router provides connectivity and does not interact with the vehicle’s operation or vehicle operators.

This document describes the hardware and physical characteristics of the Perle IRG554x router. It covers hardware features as well as installation and operation. This document does not cover how to configure your Perle IRG554x router. Information to configure your Perle router can be found in the Perle IRG7000/5000 5G/LTE Router User’s Guide and the Perle IRG7000/5000 5G/LTE Router Command Line Reference Guide on the Perle website. Quick Start information can be found in the 554x that comes with your product.

## Key Features

- Supports bridging/switching, and routing
- LTE coverage spanning 21 frequency bands in North America/EMEA (IRG5541/5541+)
- LTE coverage spanning 30 frequency bands for global coverage (IRG5541/5541+)
- Fully automatic network switching supporting dual network SIMs
- Routing with Primary/Backup route
- LTE and VPN Fail-over
- Provides network connectivity via LTE, Ethernet, and USB-C
- Active GPS for tracking equipment
- Low voltage Standby function to prevent battery drain
- One GPIO pin for remote monitoring/control and one IGN (Ignition) pin
- Two digital Inputs and one Relay contact
- RS485 half-duplex capabilities
- Wireless LAN 2.4/5 GHz support (models IRG5541/5541+)
- Security via remote authentication (Radius/RadSec and TACACS+)
- Processor Power Saving Mode—this feature optimizes idle power consumption, saving energy by reducing performance where possible
- Power Saving Features including; LED power saving mode, Smart Standby Mode, Power saving strategies such as turning off unused interfaces (USB, Serial, Ethernet), turning off GPS and adjusting the Ethernet rate
- Meets industry-grade certifications

## Additional Documentation

<b>Document</b>	<b>Description</b>
Perle IRG7000/5000 5G/LTE Router User's Guide	User's guide explaining how to configure the IRG554x features using the Web Manager application. New users should use this method to configure the router.
Perle IRG7000/5000 5G/LTE Router Command Line Reference Guide	Command Line Interface Reference Guide using CLI commands to configure the IRG554x (this is an advanced way to configure the router).

## Document Conventions

This document contains the following conventions:

Most text is presented in the typeface used in this paragraph. Other typefaces are used to help you identify certain types of information. The other typefaces are:

**Note:** *Means reader take note:* notes contain helpful suggestions.

**Caution:** Means reader be careful. In this situation, you might perform an action that could result in equipment damage or loss of data.

### **Warning: IMPORTANT SAFETY INSTRUCTIONS**

Means danger. You are in a situation that could cause bodily injury. Before you work on any equipment, be aware of the hazards involved with electrical circuitry and be familiar with standard practices for preventing accidents.

### **Important Notice**

Due to the nature of wireless communications, transmission and reception of data can never be guaranteed. Data may be delayed, corrupted (i.e., have errors) or be totally lost. Although significant delays or losses of data are rare when cellular devices such as the Perle IRG554x Series Routers are used in a normal manner with a well-constructed network. The Perle IRG554x Series Routers should not be used in situations where failure to transmit or receive data could result in damage of any kind to the user or any other party, including but not limited to personal injury, death, or loss of property. Perle accepts no responsibility for damages of any kind resulting from delays or errors in data transmitted or received using our products.

### **Safety and Hazards**

The driver or operator of any vehicle should not operate the IRG554x while in control of a vehicle. Doing so will detract from the driver or operator's control and operation of that vehicle. The IRG554x is Listed to UL121201 and CSA C22.2 No. 213 and are suitable for use in Class I, Division 2, Groups A, B, C and D Hazardous Locations.

The following warnings and instructions apply:

### **Limitation of Liability**

The information in this manual is subject to change without notice and does not represent a commitment on the part of Perle for any and all direct, indirect, special, general, incidental, consequential, punitive or exemplary damages including, but not limited to loss of profits or revenue or anticipated profits or revenue arising out of the use or inability to use any Perle IRG554x series router even if Perle has been advised or the possibility of such damages or they are foreseeable or for claims by any third party.



Notwithstanding the foregoing, in no event shall Perle aggregate liability arising under or in connection with the Perle product, regardless of the number of events, occurrences, or claims giving rise to liability, be in excess of the price paid by the purchaser for the Perle product.

Copyright © 2023 Perle. All rights reserved.

Windows® is a registered trademarks of Microsoft Corporation.

Other trademarks are the property of their respective owners

## General cautions and warnings

13		IEC 60417-5041 (2002-10)	“WARNING: HOT SURFACE. DO NOT TOUCH.” / ATTENTION: Surface chaude. Ne pas toucher.”
14			Refer to manual/safety

**Warning:** Power sources must be off prior to beginning the power connection steps. Read the installation instructions before you connect the unit to its power source.

**Avertissement:** Les sources d'alimentation doivent être éteintes avant de commencer les étapes de connexion d'alimentation. Veuillez lire les instructions d'installation avant de connecter l'appareil à sa source d'alimentation.

**Warning:** Ensure that the voltage and current ratings of the intended power source are appropriate for the IRG554x Series of Routers as indicated on the product label.

**Avertissement:** Assurez-vous que les valeurs nominales de tension et de courant de la source d'alimentation prévue conviennent aux routeurs de la série IRG554x, comme indiqué sur l'étiquette du produit.

**Warning:** Ensure that the installation and electrical wiring of the equipment is performed by trained and qualified personnel and that the installation complies with all local and national electrical codes.

**Avertissement:** Assurez-vous que l'installation et le câblage électrique de l'équipement sont effectués par du personnel formé et qualifié et que l'installation est conforme à tous les codes électriques locaux et nationaux.

**Warning:** This equipment must be used in the matter specified by the manufacturer.

**Avertissement:** Cet équipement doit être utilisé dans les matières spécifiées par le fabricant.

**Warning:** In case of malfunction or damage, no attempts at repair should be made by the user. Do not dismantle this product. In case of malfunction or damage, contact Perle Technical support at

[https://www.perle.com/support\\_services/support\\_request.aspx](https://www.perle.com/support_services/support_request.aspx)

or email at

[https://www.perle.com/support\\_services/support\\_request.aspx#form](https://www.perle.com/support_services/support_request.aspx#form)

**Avertissement:** En cas de dysfonctionnement ou de détérioration, aucune tentative de réparation ne doit être effectuée par l'utilisateur. Ne démontez pas ce produit. En cas de dysfonctionnement ou de dommage, contactez le support technique de Perle à l'adresse

[https://www.perle.com/support\\_services/support\\_request.aspx](https://www.perle.com/support_services/support_request.aspx)

ou par courrier électronique à

[https://www.perle.com/support\\_services/support\\_request.aspx#form](https://www.perle.com/support_services/support_request.aspx#form)

**Warning:** “Equipment is intended for installation in Restricted Access Area when equipment is installed in ambient exceeding 50°C (122°F)”. The unit should be installed in a restricted access loca-

tion where access can only be gained by service personnel or users who have been instructed about the reasons for the restrictions applied to the location and about any precautions that shall be taken; and access is through the use of a tool or lock and key, or any means of security, and is controlled by the authority responsible for the location.

**Avertissement:** L'équipement est destiné à être installé dans une zone d'accès restreint lorsque l'équipement est installé dans une température ambiante supérieure à 50 °C (122 °F). L'unité doit être installée dans un emplacement à accès restreint, auquel seul le personnel de service ou les utilisateurs informés des raisons des restrictions appliquées peuvent accéder. sur le lieu et sur les précautions à prendre; et l'accès se fait au moyen d'un outil ou d'un verrou et d'une clé, ou de tout moyen de sécurité, et est contrôlé par l'autorité responsable du lieu.

**Warning:** The working voltage inputs are designed for operation with Safety extra low Voltage (SELV). Connect only to SELV circuits with voltage restrictions in line with IEC/EN 62368-1.

**Avertissement:** Les entrées de tension sont conçues pour fonctionner avec une tension de sécurité très basse (SELV). Connectez uniquement aux circuits SELV avec des restrictions de tension conformes à IEC / EN 62368-1.

**Warning:** For equipment installed within the same end-product enclosure ensure leads are segregated or insulated the leads from different circuits.

**Avertissement:** Pour les équipements installés dans le même boîtier de produit final, assurez-vous que les conducteurs sont séparés ou isolés des conducteurs de circuits différents.

## Hazardous Location Warnings

### Specific Conditions of Use

1. The IRG5540/5540+/5541/5541+ Routers are intended for installation into an IECEx/ATEX certified and IP54 minimum rated enclosure in accordance with IEC/EN IEC 60079-0 and accessible only by the use of a tool. Les modèles de routeurs IRG5540/5540+/5541/5541+ sont destinés à être installés dans un boîtier certifié IECEx/ATEX qui conforme à la norme IP54 conformément à la norme IEC/EN IEC 60079-0 et accessible uniquement à l'aide d'un outil.
2. The IRG5540/5540+/5541/5541+ Routers shall only be used in an area of not more than pollution degree 2, as defined in IEC/EN 60664-1. L'équipement ne doit être utilisé que dans une zone où le degré de pollution n'est pas supérieur à 2, tel que défini dans la IEC/EN 60664-1.

**Warning:** These devices are open-type devices that are to be installed in an enclosure with tool removable cover or door, suitable for the environment.

**Avertissement:** Ces périphériques sont des périphériques de type ouvert à installer dans un boîtier avec un couvercle ou une porte amovible pour outils, adapté à l'environnement.

**Warning:** This equipment is suitable for use in Class I, Division 2, Groups A, B, C, D, or only non hazardous locations.

**Avertissement:** Cet équipement est adapté à une utilisation dans les zones non dangereuses de classe I, division 2, groupes A, B, C, D

**Warning:** WARNING-EXPLOSION HAZARD - Do not connect or disconnect equipment unless power has been removed or the area is known to be non-hazardous.

**Avertissement:** DANGER D'EXPLOSION ET D'AVERTISSEMENT - Ne pas connecter ou déconnecter l'équipement tant que l'alimentation n'est pas débranchée ou que la zone n'est pas dangereuse.

**Warning:** WARNING-EXPLOSION HAZARD - Substitution of any components on this unit may impair suitability for Class I, Division 2.

**Avertissement:** DANGER DANGER D'EXPLOSION - La substitution de tout composant de cet appareil peut compromettre l'adéquation à la Classe I, Division 2.

**Warning:** Power supply of the equipment must be rated appropriately (see Appendix for specifications) with limited power. Limited power means complying with one of the following requirements.

Class 2 circuit according to Canadian Electrical Code, Part 1, C22.1

Class 2 circuit according to National Electrical Code, NFPA-70

Limited Power Supply (LPS) according to EN/IEC 60950-1;

Limited-energy circuit according to EN/IEC 61010-1

**Avertissement:** l'alimentation de l'équipement doit être correctement dimensionnée (voir annexe pour les spécifications) avec une puissance limitée. Une puissance limitée signifie que vous vous conformez à l'une des exigences suivantes.

Circuit de classe 2 selon le code électrique Canadien, partie 1, C22.1

Circuit de classe 2 selon le code électrique national NFPA-70

Alimentation électrique limitée (LPS) selon EN / IEC 60950-1;

Circuit à énergie limitée selon EN / IEC 61010-1

**Warning:** If this equipment is used in a manner not specified by the manufacturer, the protection provided by the equipment may be impaired.

**Avertissement:** Si cet équipement est utilisé d'une manière non spécifiée par le fabricant, la protection fournie par l'équipement peut être altérée.

**Warning:** In case of malfunction or damage, no attempts at repair should be made. Do not dismantle the product. All repairs need to be made by a qualified Perle representative. Contact Perle Systems Technical support at [https://www.perle.com/support\\_services/support\\_request.aspx](https://www.perle.com/support_services/support_request.aspx) or email at [https://www.perle.com/support\\_services/support\\_request.aspx#form](https://www.perle.com/support_services/support_request.aspx#form)

**Avertissement:** En cas de dysfonctionnement ou de dommage, aucune tentative de réparation ne doit être effectuée. Ne démontez pas le produit. Toutes les réparations doivent être effectuées par un représentant qualifié de Perle. Contactez le support technique de Perle Systems à l'adresse [https://www.perle.com/support\\_services/support\\_request.aspx](https://www.perle.com/support_services/support_request.aspx) ou par courrier électronique à [https://www.perle.com/support\\_services/support\\_request.aspx#form](https://www.perle.com/support_services/support_request.aspx#form)

**Warning:** This router is not intended for use close to the human body. The unit should be mounted in such that Antennas are at least 20cm (8 inches) away from any person.

**Avertissement:** Ce routeur n'est pas destiné à être utilisé à proximité du corps humain. L'appareil devrait être monté de façon à ce que les antennes soient à au moins 20 cm (8 po) de toute personne.

**Warning:** Explosion hazard. Do not connect or disconnect while the circuit is live or unless the area is free of ignitable concentrations.

**Avertissement:** Risque d'explosion. Ne pas connecter ou déconnecter le circuit est sous tension ou à moins que la zone ne présente aucune concentration inflammable.

**Warning:** Do not use the USB connector unless the area is free of ignitable concentrations.

**Avertissement:** N'utilisez pas le connecteur USB à moins que la zone ne soit exempte de concentrations inflammables.

**Warning:** Do not use the reset button unless the area is free of ignitable concentrations.

**Avertissement:** N'utilisez pas le bouton de réinitialisation à moins que la zone ne soit exempte de concentrations inflammables.

## RF Exposure

In accordance with FCC/IC requirements of human exposure to radio frequency fields, the radiating element shall be installed such that a minimum separation distance of 20 cm should be maintained from the antenna and the user's body.

Conformément aux exigences de la FCC/IC relatives à l'exposition humaine aux champs de radiofréquences, l'élément de rayonnement doit être installé de manière à ce qu'une distance de séparation minimale de 20 cm soit maintenue par rapport à l'antenne et au corps de l'utilisateur.

THE SPECIFICATIONS AND INFORMATION REGARDING THE PRODUCTS IN THIS GUIDE ARE SUBJECT TO CHANGE WITHOUT NOTICE. ALL STATEMENTS, INFORMATION, AND RECOMMENDATIONS IN THIS GUIDE ARE BELIEVED TO BE ACCURATE BUT ARE PRESENTED WITHOUT WARRANTY OF ANY KIND, EXPRESS OR IMPLIED. USERS MUST TAKE FULL RESPONSIBILITY FOR THEIR APPLICATION OF ANY PRODUCTS.

This equipment has been tested and found to comply with the limits for a Class B digital device, pursuant to part 15 of the FCC rules. These limits are designed to provide reasonable protection against harmful interference when the equipment is operated in a commercial environment. This equipment generates, uses, and can radiate radio-frequency energy and, if not installed and used in accordance with this hardware guide may cause harmful interference to radio communications.

Modifications to this product not authorized by Perle could void the FCC approval and negate your authority to operate the product.

Perle reserves the right to make changes without further notice, to any products to improve reliability, function, or design.

Perle, the Perle logo, and IRG554x Series of Routers are trademarks of Perle.

Copyright ©2023 Perle.

60 Renfrew Drive, Markham, Ontario, L3R 0E1, Canada

All rights reserved. No part of this document may be reproduced or used in any form without written permission from Perle.



## Publishing History

<b>Date</b>	<b>Revision</b>	<b>Update Details</b>
March 2020	A.03.23.2020	Initial release.
Dec 2020	A.12.31.2020	Updates
June 2021	A.03.06.2021	Update to label
Jan 2022	A.01.30.2022	Added IRG7440 model (5G) and updates to other models
March 2022	A.03.17.2022	Updated Hot warning
April 2022	A.04.08.2022	Updated Restricted Access Area warning
June 2023	A.06.13.2023	Added DHCP/BOOTP (ZTP mode) support for factory default mode

# Table Of Contents

<b>Preface</b> .....	<b>I</b>
<b>Overview</b> .....	<b>1</b>
What's Included .....	1
What You Need to Supply .....	1
<b>Hardware</b> .....	<b>2</b>
Front View .....	2
SIM Card/s .....	6
Antenna/s .....	7
USB-C Port .....	7
Ethernet LAN Ports .....	7
Ethernet Link Status .....	7
GNSS Connector .....	7
Connecting the Power .....	8
AUX/IO .....	9
Relay Alarm .....	9
<b>Installation</b> .....	<b>10</b>
Inserting the SIM card .....	10
Connecting to the Ethernet Ports .....	11
Connecting to the Serial Port .....	11
Female Serial Pin out .....	12
Connecting to the USB-C port in Console Mode .....	12
Connecting to the USB-C port as an Ethernet over USB Port .....	12
Connecting the Power .....	13
<b>Operation</b> .....	<b>14</b>
Reset / Factory Default / Safe Mode / DHCP/BOOTP (ZTP mode) .....	14
<b>Fast Setup</b> .....	<b>15</b>
<b>Managing the IRG554x</b> .....	<b>16</b>
WebManager .....	16
CLI .....	16
SNMP .....	16
Fast Setup Mode .....	16
PerleView .....	16
IRG554x Router Deployment Modes .....	17
Fixed Installation without I/O .....	17
Recommended Vehicle Installation (Ignition Mode) .....	17
Fixed Installation with Analog Input .....	18
<b>I/O Configurations</b> .....	<b>19</b>
Pulse Counter / Digital Input .....	19
High Side Pull-up / Dry Contact Switch Input .....	19
Digital Output / Low Side Current Sink .....	20
Digital Output / Open Drain .....	21
<b>AUX /I/O</b> .....	<b>22</b>
Pulse Counter / Digital Input .....	22
High Side Pull-up / Dry Contact Switch Input .....	23

---

Relay Alarm .....	23
<b>Appendix A—Technical Specifications .....</b>	<b>24</b>
<b>Appendix B—Sample Labels .....</b>	<b>32</b>
<b>Appendix C—Mounting the IRG554x .....</b>	<b>33</b>
<b>Appendix D—Mechanical .....</b>	<b>35</b>
<b>Appendix E—Maintaining and Troubleshooting .....</b>	<b>36</b>

## Overview

The IRG554x router is a compact, rugged, fully featured communications platform for real-time wireless capabilities. It has multiple communication ports including Serial, Ethernet, and a USB port that can be used as a console port or as an additional Ethernet port. It supports LTE/4G wireless solutions for both fixed and mobile applications (IoT). The IRG5540/5541 LTE/4G supports Cat-12 technology with peak download rates of 600 Mbps and uploads speeds of 150 Mbps. It offers global coverage of frequency bands, supports Cat-12 technology with automatic fall-back to 3G (HSPA+, UMTS) networks. The IRG5540+/5541+ also includes integrated GNSS receiver (GPS, GLONASS, Beidou, and Galileo) satellite support.

### Application uses:

- Monitoring and controlling remote equipment such as pipelines, meters, pumps, and valves in energy, utility, or industrial applications
- Tracking the location of heavy equipment and assets in the field
- Providing reliable Internet access to a mobile workforce

### What's Included

The following components **may** be included with your product. Components will vary depending for each model. See the Perle website for updates.

- The router
- Quick Start Guide that came with your product
- LTE SMA antenna pack (#08000120) 2 WiFi antennas (#08000140)
- GPIO Cable with 4 Pin plug (#2500468)
- GPIO Cable with 8 Pin plug (#2500476)
- 12VDC/2A 4 Pin (NA-#08000150, EU #08000160, UK #08000170, #08000180) power supply
- GNSS PASV RP-Antenna SMA/CA (#08000130) order-able from Perle

### What You Need to Supply

Before you can begin, you need to have the following:

- A SIM card/s (provided by your mobile network operator)
- #1 Phillips screwdriver (if you are installing the SIM card)
- Computer or laptop computer with Ethernet interface and cable
- An Ethernet CAT5e or CAT6 10/100/1000BASE-T cable/to connect the router to the network

# Hardware

## Front View

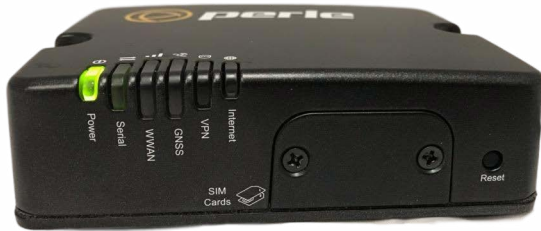



## LEDs





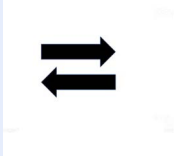

LTE only models

Models including WiFi

Power LED 	Function	Normal	Low Power Mode	Meaning
	No Power	Off	N/A	
	Boot	Red—solid	N/A	
	Green— Blip	N/A	N/A	
	Powering up	Amber—flashing	N/A	
	Normal Operation	Green—solid	Green—blip starting after a boot is complete	
	Normal operation but no config	Green—flashing		Unit is powered up normally—unit has no config. Unit is in Safe mode or Factory default mode.
	Fatal error	Red—solid	Red—solid	

	Setup Mode	Amber—solid	Amber—solid	When you press and hold the reset button for 5 seconds. The solid amber led indicate the time to release to initiates setup mode.
	Factory Reset	Red—solid	Red—solid	When you press and hold the reset button for 20 seconds. The solid red indicates the time to release to imitate reset to factory.
	Overheat Standby	Red—blip	Red—blip	Overheat caused the unit to go into Standby mode. Router will restart when temp is below the threshold.
	No Config	Green-flashing	N/A	Unit is powered up normally—unit has no config. Unit is in safe mode or factory default mode.
<b>Serial</b> 	<b>Function</b>	<b>Normal</b>	<b>Low Power Mode</b>	<b>Meaning</b>
	Disabled or not in use	Off	Off	Always off in power saving mode.
	Serial port/s TX/RX	Green—flashing	Off	
<b>WWAN</b> 	<b>Function</b>	<b>Normal</b>	<b>Low Power Mode</b>	<b>Meaning</b>
	Disabled	Off	Off	

	Connected—good signal	Color—solid	Off—once a connection is established, it will come on for 5 secs then go off	Colour will depend on signal strength. Green = Good signal— $\geq -80\text{dBm}$ Amber = Fair signal— $> -94\text{dBm} < -80\text{dBm}$ red="Poor" signal— $\leq -94\text{dBm}$ < body>
	Connection in progress	Green, Amber or Red flashing	Off	Signal strength flash
	Not connected or not connecting	Green, Amber, or Red blips	Off	Signal strength blip
<b>GNSS</b> 	<b>Function</b>	<b>Normal</b>	<b>Low Power Mode</b>	<b>Meaning</b>
	Disabled	Off	Off	No GPS activated or in power saving mode.
	Initializing	Green—blip	Off	
	Attempting to get a fix or unable to get a fix	Amber—flashing	Amber—blip	
	GPS fix	Green—solid	Off—green solid for 5 seconds then off	
<b>VPN</b> 	<b>Function</b>	<b>Normal</b>	<b>Low Power Mode</b>	<b>Meaning</b>
	No VPN	Off	Off	No VPN configured or enabled
	VPN established	Green—solid	Off	VPN established—at least 1 VPN connection is up.
	VPN failed	Red—solid	Red—blip	Internet is up, but VPN failed

<b>WLAN</b> 	<b>Function</b>	<b>Normal</b>	<b>Low Power Mode</b>	<b>Meaning</b>
	5.0GHz	Green—solid	Off	Client mode connected—AP Radio mode.
	5.0 TX/RX	Green—flashing	Off	Client or AP activity.
	2.4GHz	Amber—solid	Off	Client mode connected—AP-radio active.
	2.4 TX/RX	Amber—flashing	Off	Client or AP activity.
	No connection	Off	Off	Client mode—no connection; AP mode not enabled.
<b>Internet</b> 	<b>Function</b>	<b>Normal</b>	<b>Low Power Mode</b>	<b>Meaning</b>
	Disconnected	Off	Off	No connection by intention <ul style="list-style-type: none"> <li>• disabled or radio off</li> <li>• disconnect requested</li> </ul>
	Connected	Green—solid	Off	<ul style="list-style-type: none"> <li>• LTE primary if no WAN</li> <li>• Primary connection if WAN</li> </ul>
	Backup mode	Amber—solid	Off	Backup connection if WAN.



	Connection failure	Red—solid	Red—blip	<p>A connection was attempted, but it failed.</p> <ul style="list-style-type: none"> <li>• APN incorrect</li> <li>• SIM card missing</li> <li>• insufficient signal</li> <li>• no service</li> <li>• modem failure</li> <li>• data connection failed—waiting to retry</li> <li>• Pin incorrect SIM blocked, bad unlock code</li> <li>• SIM locked</li> <li>• SIM blocked, unblock code incorrect</li> </ul>
--	--------------------	-----------	----------	---

### SIM Card/s

The IRG554x supports two SIM cards. See [Inserting the SIM card](#) for the installation procedure.



SIM/ Interface 1.8V/3V

### Back View (IRG5541/5541+)

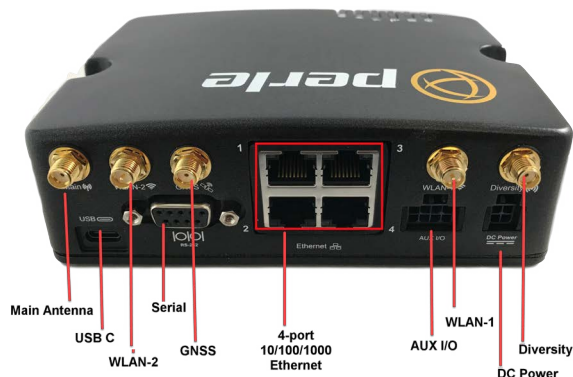

**Note:** IRG5540 models do not have the WLAN-1 and WLAN-2 antennas.

## Antenna/s

The IRG5540 has three SMA antenna connectors, Main, Div/GNSS1, and GNSS. WiFi models have two additional connectors WLAN-1 and WLAN-2 antennas. For more information on connecting the antennas see the Technical Specifications section [Connecting the Antenna/s](#).

## USB-C Port

In console mode, the IRG554x USB port provides direct access to the Command Line Interface (CLI) as well as provides statuses, logging, and troubleshooting information. Alternative, this port can be set as an Ethernet over USB port.

See [Connecting to the Serial Port](#) and [Connecting to the USB-C port as an Ethernet over USB Port](#).



## Ethernet LAN Ports

Once the ports are connected and the link is established, the speed LED will turn on. The LED indicates a 10, 100, or 1000 Mbps link on the Ethernet port.

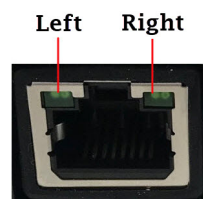

## Ethernet Link Status

Link/Speed Indicator		Description
Left LED Green	Link + Flashing with activity	1000 Mbps
Both LEDs	Link + Flashing with activity	100 Mbps
Right LED Green	Link + Flashing with activity	10 Mbps
Off	Off	No LAN connected

## GNSS Connector

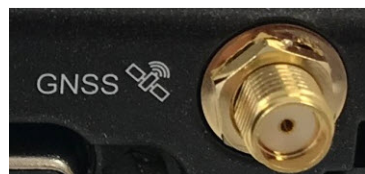

GPS+GLONAS+GAILEO

Passive Antenna—SMA(M) straight connector

See [Appendix A—Technical Specifications](#) for electrical details.

## Connecting the Power

Some models ship with a DC power cable or a pigtail cable.

The GPIO connector can be configured as a high side pull-up/dry contact digital input, analog input, low side current sink output, digital output/open drain, or pulse counter depending on your application. Pin 3—IGN can be configured as vehicle ignition sense or as analog input.

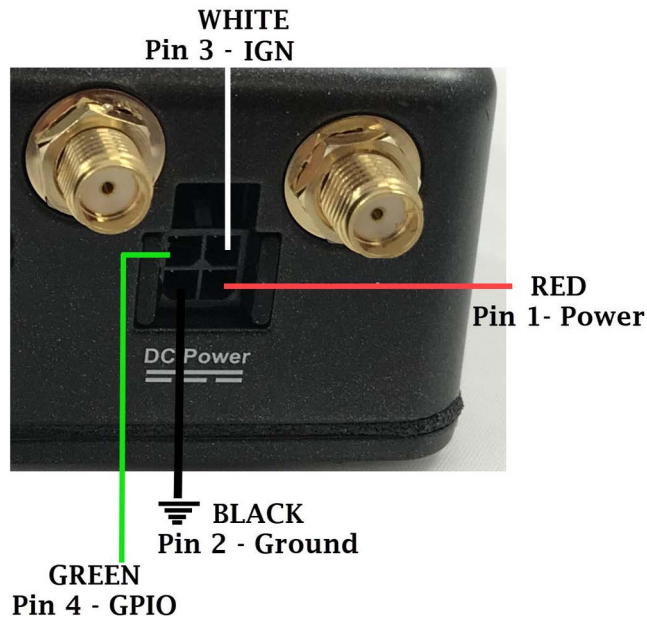

**Warning:** Before servicing this product ensure the power source has been disconnected.

Pin	Name	Associated DC Cable Wire color	Description	Type
1	Power	Red	Main power supply for device. <i>Note: If you want to turn the IRG554x on/off using a control line, such as a vehicle ignition line, we recommend that you connect the control/ignition line to Pin 3 and apply continuous power On Pin 1</i>	PWR
2	Ground	Black	Main device ground.	GND
3	IGN	White	Connect to the vehicle ignition or an external switch. This input can be configured to put the router into a Standby mode when the signal goes low and take it out of Standby mode when it goes high. Alternatively it can be used simply as an analog input.	IGN
4	GPIO	Green	User configurable digital input/output or analog voltage sensing input. Connect to switch, relay or external device.	GPIO

**Note:** Use copper conductors only.

## AUX/IO

The AUX/IO connector allows a connection for an RS485 device, 2 digital input devices (A and B), and 1 relay device. The two digital input connectors allow (NO) normally open relay.



<b>Pin Numbers</b>	8	7	6	5
<b>Pin Description</b>	RS485 -	GND	Input B	Relay NO (normally open)
<b>Pin Numbers</b>	4	3	2	1
<b>Pin Description</b>	RS485 +	GND	Input A	Relay NO (normally open)

**Warning:** Before connecting wiring, ensure the power source has been disconnected.

## Relay Alarm

The Router has one Normally Open (NO) relay (Pin 5 and Pin 1). The relay switch can be connected to an external powered device such as a siren or light to provide visual or audible notification of an alarm status.

Ensure the power source is off prior to connection.

## Installation

The steps for a typical installation are:

1. Inserting the SIM card/s. See [Inserting the SIM card](#).
2. Connecting the antenna/s. See [Connecting the Antenna/s](#).
3. Connecting the Ethernet Ports. See [Ethernet LAN Ports](#).
4. Connecting the Serial Port. See [Connecting to the Serial Port](#).
5. Connecting to the Console Port in Console Mode. See [Female Serial Pin out](#).
6. Using the Console port as a virtual Ethernet port. See [Connecting to the USB-C port as an Ethernet over USB Port](#).
7. Connecting the power. See [Connecting the Power](#).
8. Logging into the IRG554x See [Fast Setup](#) or [Female Serial Pin out](#).

### Inserting the SIM card

The IRG554x comes with two SIM sockets for 2mini-SIM (2FF) cards.

**Note:** Ensure the power is disconnected before you insert the SIM card/s.

1. Using your Phillips screwdriver, removed the two screws cover from the panel covering the SIM slots.

Gently pry the cover loose from the opening.

2. Align the SIM card so that the SIM card will slide into the top slot (slot#1). The SIM card has a notched corner for orientation and the SIM card can only be inserted the correct way. You will hear an audible click when the SIM is inserted correctly. Always populate slot#1 first. Add a second SIM card if your network setup requires it.
3. Align the SIM cover plate and secure the plate with the screws.



**Note:** Do not force the SIM card in or you may damage the card or your IRG554x router.

### Connecting the Antenna/s



1. Connect your cellular antenna to the SMA cellular antenna connector labeled **Main**.
2. Connect your GPS antenna to the SMA GPS antenna connector labeled **GNSS**.
3. Mount the GPS antenna where it has a good view of the sky (at least 90°).

4. Connect the diversity antenna to the SMA diversity antenna labeled **Diversity**. For models that have WLAN connectors, connect the WLAN antennas to **WLAN-1** and **WLAN-2**. When attaching the antennas to the SMA connectors, line the inner hole within the antenna, then slide onto the pin encased in the connector on the router, gently push to connect, then turn only the securing ring and not the antenna to secure it to the router.



**Warning:** For Zone 2 and/or Class I, Division 2 hazardous location applications. Antennas intended for use with the product must be installed within the end use enclosure. For remote mounting of the antennas in unclassified or classified locations, routing and installation of the antennas shall be in accordance with the appropriate location regulations.

## Connecting to the Ethernet Ports

The Ethernet RJ45 ports provides the standard Ethernet interface speeds of 10/100/1000 Mbps through twisted pair (UTP) cables of up to 100 meters (328ft) in length. Cat5e or Cat6 cables are recommended for 1000 Mbps connections.

## Connecting to the Serial Port

The serial port has a 9-pin female port connector allowing you to directly connect to most computers or devices with a standard serial straight-through cable.

It is used for:

- Connect a serial device
- Connect as a console port
- As a GNSS output device

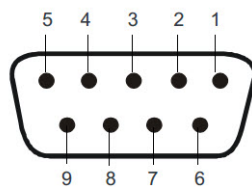

**Note:** When connecting to a DCE device, a crossover cable is needed.

## Female Serial Pin out

Name	Pin	Description	Type
DCD	1	Data Carrier Detect	OUT
TXD	2	Transmit Data	OUT
RXD	3	Receive Data	IN
DTR	4	Data Terminal Ready	IN
GND	5	Ground	GND
DSR	6	Data Set Ready	OUT
RTS	7	Request to Send	IN
CTS	8	Clear to Send	OUT
RI	9	Not Connected	-

### Connecting to the USB-C port in Console Mode

By default, the USB-C port is set to console mode.

In this mode, the USB-C port acts as a console port.

1. Connect the power. See [Connecting the Power](#).
2. Allow the router to complete the boot up sequence.
3. Connect a USB cable to the PC's USB port, then connect the other end of the cable to the router's USB-C connector.
4. On the PC Choose Start -> Control Panel -> Hardware and Sound (or equivalent) on the Windows Operating System. Choose the Device Manager, and expand the Ports section. The assigned COM port can be identified.
5. Start a terminal emulation program (such as Putty or SecureCRT) on the com port where you have connect the cable to the PC.
6. Press the Enter key on the keyboard and the prompt will display.

**See the Perle IRG7000/5000 5G/LTE Router CLI Reference Guide for more information on using CLI commands.**

**Warning: If you connect or disconnect the console cable with the power applied to the router or any device on the network, an electrical arc can occur. This could cause an explosion when installed in a hazardous location. Ensure the power is removed from all devices prior to making any cable connections.**

**Warning: Do not use the USB port in a potentially explosive environment.**

### Connecting to the USB-C port as an Ethernet over USB Port

In this mode, the USB-C port behaves like a PC is connected to the Ethernet port, allowing access to networks and the Internet.

See the Perle IRG7000/5000 5G/LTE Router User's Guide and the Perle IRG7000/5000 5G/LTE Router CLI Reference Guide for more information on setting this parameter.



## Connecting the Power

The wire colors shown are for the power/GPIO cable that is included with the IRG554x. Other wiring setups may have different colors. See [Appendix A—Technical Specifications](#).

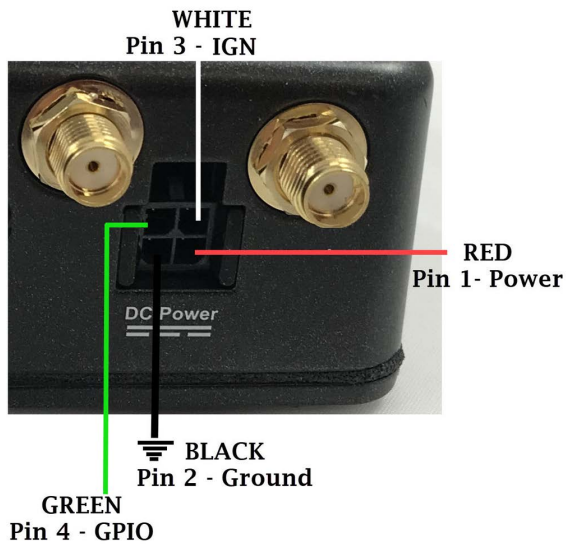

Molex part number 2451320420 or equivalent  
Rectangular socket to socket 6.56' (2.00m)

**Note:** Before servicing this product ensure the power source has been disconnected. Electrical installations should be performed by personnel thoroughly trained in safe electrical wiring procedures.



## Operation

### Reset / Factory Default / Safe Mode / DHCP/BOOTP (ZTP mode)

This table below shows how the reset button is used.

#### Reset Button



Mode	Description	LEDs	System Status
Restart	In router normal running state, press and Release the Reset button	Power LED will begin to blink amber	Reboots. All configuration and files will remain the same.
Factory Default	In router normal running state, press the Reset button and Hold for 10 seconds	When all LEDs flash Amber, release the Reset button, Power LED flashes Amber	Reboots and resets the configuration to the Perle factory default configuration. All configuration, User IDs, passwords, and security certificates are deleted.
DHCP/BOOTP (ZTP mode)	Set router in factory default mode, press and hold the reset button for 5 seconds	All LEDs will flash green, then release the reset button	Reboots the router into Fast setup DHCP/BOOTP (ZTP mode) running config will be copied to startup configuration router sends out DHCP client requests until it get a DHCP offer
Safe Mode	Press the Reset button while powering up	All LEDs, except Power blink Amber	<ul style="list-style-type: none"> <li>• Saves the startup config</li> <li>• Boots with no config file</li> <li>• Allows you to do setup mode</li> </ul>

## Fast Setup

Fast Setup mode allows you to quickly configure basic operating parameters on your router.

Your Perle router has been shipped to you in Factory Default mode. On power up, your router is in “Fast Setup” mode with the Power LED flashing green. Make a connection to your router via the console port or a Web browser, then answer basic setup operating parameters such as your initial user ID and password.

To connect to the console port, follow the instructions provided in—*Connecting to the Serial Port*.

To connect using a Web browser, connect your PC’s Ethernet cable directly to an Ethernet port on the router. Configure the PC to use DHCP for obtaining its IP address. The router will act as a DHCP server and assign an IP address to the PC. Next, launch the Web browser and browse to “http://192.168.0.1”. The Fast Setup screen appears.

Refer to the Quick Start Guide or the Perle IRG7000/5000 5G/LTE Router User’s Guide for more information on setup instructions.

## Managing the IRG554x

The IRG554x can be configured, operated, and monitored using any of the following methods. See the Perle IRG7000/5000 5G/LTE Router User's Guide for more details on these methods.

### WebManager

The Perle WebManager—an embedded Web based application provides an easy to use browser interface for configuring and managing the IRG554x. The WebManager is accessible through any standard desktop web browser. Configured a valid IP address on the IRG554x before connecting with the WebManager.

### CLI

A text-based Command Line Interface based on industry standard syntax and structure. The CLI is accessed from the console port. Once a valid IP address is configured on the IRG554x, Telnet, SSH, or the WebManager interface is used to access the IRG554x for administration purposes. See the Perle IRG7000/5000 5G/LTE Router CLI Reference Guide for more information.

### SNMP

The IRG554x can be managed with an SNMP compatible management station that is running platforms such as HP OpenView.

### Fast Setup Mode

If your router is in “Factory Default” mode, when you first connect, you will be in “Fast setup mode”. For more details, see—[Fast Setup](#).

### PerleView

A Windows server-based centralized management package that simplifies the configuration, administration, monitoring, and troubleshooting of Perle Managed Media Converters, Ethernet Copper Extenders, Industrial Switches, IOLAN SCR/SCG and the IRG Series of Perle Routers. Your internet browser can securely access PerleVIEW and manage 10's, 100's or 1000's of Perle devices from a centralized server.

# IRG554x Router Deployment Modes

## Fixed Installation without I/O

For fixed installations, connect the wires as shown in the figure below. You configure Low Voltage Standby Mode (LVS) to force the IRG554x into Standby mode on low voltage. Voltage is monitored on Pin 3 and 4.

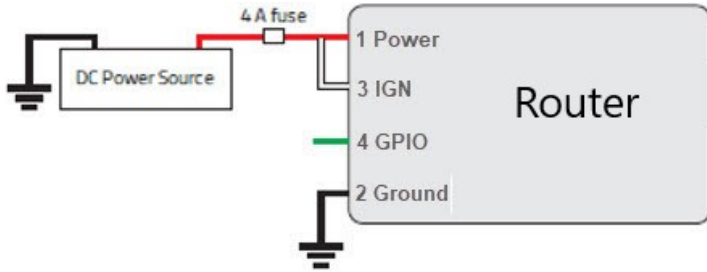

- Pin 1 (Power)—Use the Red wire in the DC cable to connect Pin 1 to the power source. Include a 4.0A fast acting fuse to the input line. A continuous (unswitched) DC power source is recommended.
- Pin 2 (Ground)—Use the Black wire in the DC cable to connect Pin 2 to Ground.
- Pin 3 (IGN–Ignition)—Connect to Power for voltage sensing.

## Recommended Vehicle Installation (Ignition Mode)

For vehicle installations, connect the white IGN wire to the vehicle’s ignition switch as shown in the diagram below. This allows the IRG554x to operate with the vehicle. When the vehicle’s ignition is off the IRG554x enters Standby mode. Configure a time delay between the vehicle’s ignition shut off, and the time the IRG554x goes into Standby mode. A delayed Standby is used if you want to maintain a network connection while the vehicle’s engine is shut off for short periods of time—such as in a delivery vehicle.

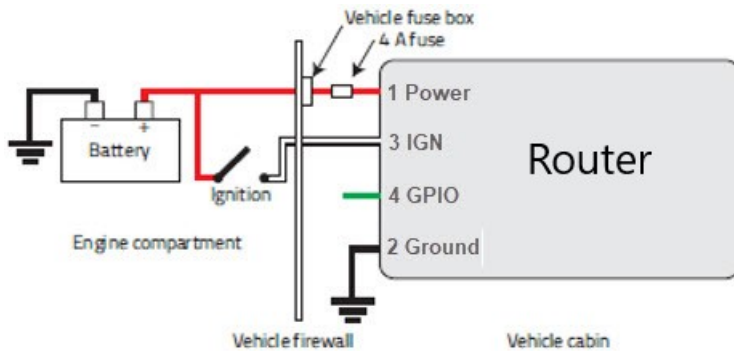

- Pin 1 (Power)—Use the Red wire in the DC cable to connect Pin 1 to the power source. Include a 4.0A fast acting fuse in the input power line. continuous (unswitched) DC power source is recommended.
- Pin 2 (Ground)—Use the Black wire in the DC cable to connect Pin 2 to Ground.
- Pin 3 (IGN–Ignition)—It is recommended to use the IGN wire (Pin 3) to initiate Standby mode on the IRG554x.

## Fixed Installation with Analog Input

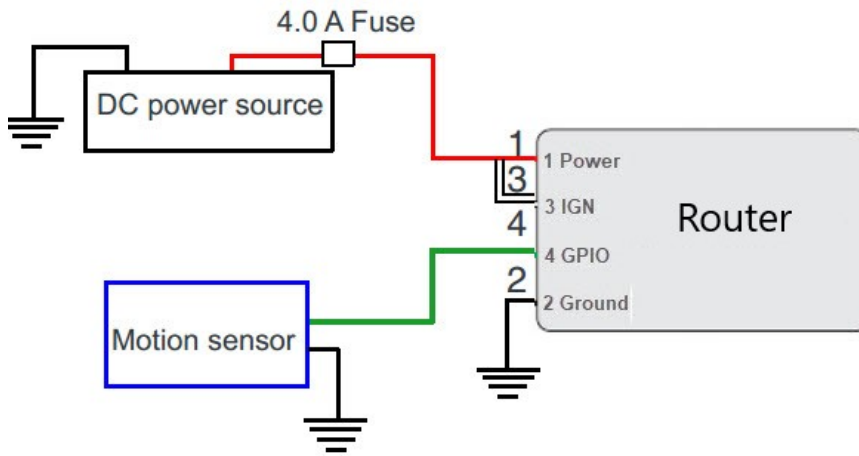

- Pin 1 (Power)—Use the Red wire in the DC cable to connect Pin 1 to the power source. Include a 4.0 fast acting fuse in the input power line. continuous (unswitched) DC power source is recommended.
- Pin 2 (Ground)—Use the Black wire in the DC cable to connect Pin 2 to Ground.
- Pin 3 (IGN—Ignition)—Connect to Power.
- Pin 4 (GPIO)— In this example, the GPIO (green) used as an analog input to enter and exit Standby Mode.

For more information on configuring Standby Mode, Timed Standby Mode and Event Handling see the Perle IRG7000/5000 5G/LTE Router User's Guide.

## I/O Configurations

You can configure Pin 4 (GPIO) green wire as:

- Pulse counter
- Digital input
- High side pull-up/dry contact switch input
- Analog input
- Digital Output / Low Side Current Sink
- Digital Output/Open Drain

### Pulse Counter / Digital Input

You can connect pin4–GPIO:

- a pulse counter to monitor frequencies up to 512 Hz, with duty cycle between 25%-75%
- a digital input to detect the state of a switch
- a monitor to an external device such as a motion detector, a remote solar panel, or a remote camera.

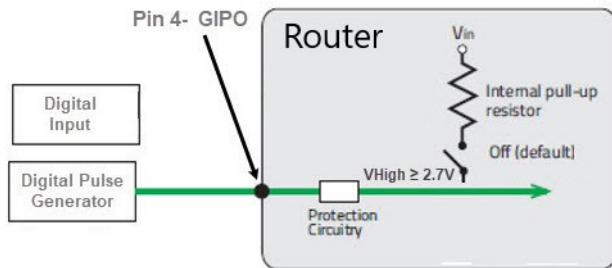

Input Range	State
0 - 1V	Low
2.7 - 36V	High

### High Side Pull-up / Dry Contact Switch Input

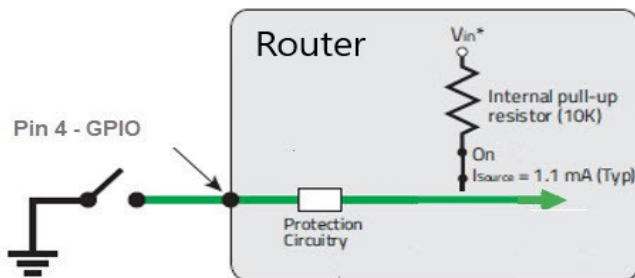

The voltage on Pin 4 when the high side pull-up is enabled (depends on the  $V_{in}$  and power consumption).

	Minimum	Typical	Maximum	Units
Source Current	0.6 $V_{in} = 7\text{ V}$	1.1 $V_{in} = 12\text{ V}$	3.5 $V_{in} = 36\text{ V}$	mA

## Analog Input

Connect the green wire—GPIO to an analog source. The router monitors voltages from the input source and transform them into analog values. Pin 4 can detect inputs of 0.5–36 V referenced to ground. By transforming the voltages, with the user defined formulas, the GPIO Pin can monitor measurements such as temperatures, sensors, or input voltages.

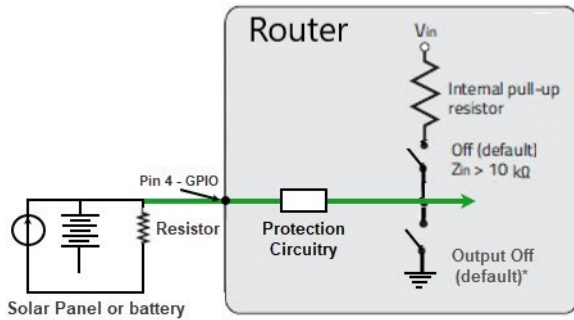

	Minimum	Maximum
Analog Input Range	0.5V	36V

## Digital Output / Low Side Current Sink

Use Pin 4 - GPIO as a low side current sink.

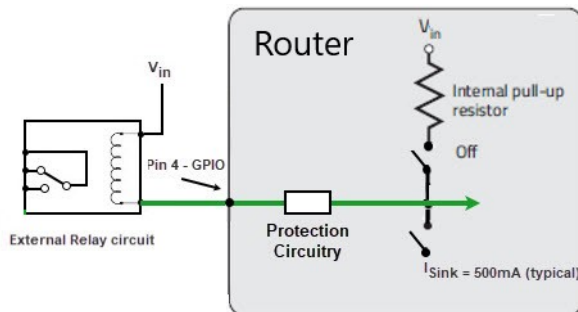

State	Minimum	Typical	Maximum	Comments
On	200mA	500	850mA	I_Typical = 25°C I_Min = 70°C I_Max = -40°C
Off	—	0	—	V <sub>in</sub> =12

## Digital Output / Open Drain

You can use Pin 4—GPIO as an open drain to drive an external digital device.

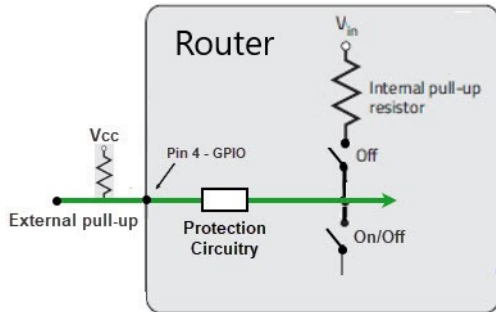

Pull-up	State	Minimum	Typical	Maximum	Units
Off	Off	Open Circuit	—	—	—
	Active Low	—	—	0.5	V



## AUX I/O

Two inputs configurable as high side pull-ups/digital inputs or pulse counters. One normally open (NO) relay contact.



Pins	8	7	6	5
	RS485 -	GND	Input B	Relay NO (normally open)
Pins	4	3	2	1
	RS485 +	GND	Input A	Relay NO (normally open)

**Warning:** Before connecting wiring, ensure the power source has been disconnected.

## Pulse Counter / Digital Input

You can connect Pin 6 or Pin 2 - AUX/IO to a pulse counter to monitor frequencies to 140 Hz, Duty cycle 20%-40%. digital input to detect the state of a switch such as a vehicle ignition, or to monitor an external device such as a motion detector, a remote solar panel, or a remote camera. Digital input can also be used with the Standby Timer.

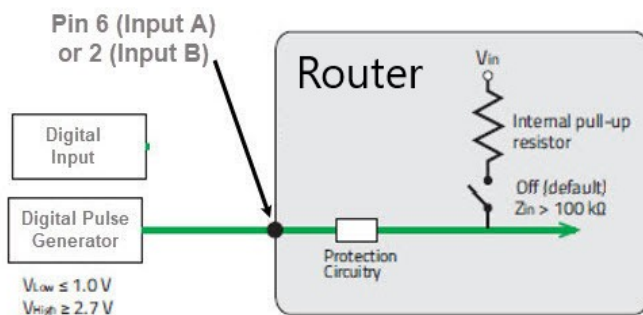

Pull-up	State	Minimum	Typical	Maximum	Units
Off	Low	—	—	1.0	V
	High	2.7	—	$V_{in}$	V

## High Side Pull-up / Dry Contact Switch Input

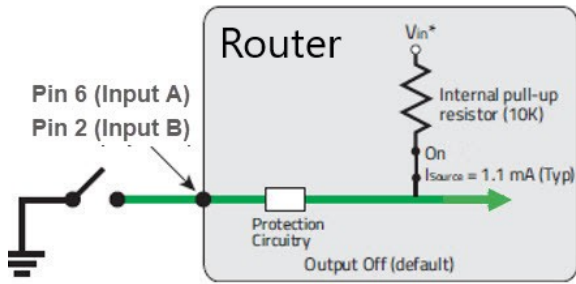

Maximum current the voltage output can provide (depends on  $V_{in}$ )

The voltage on Pin 6 or Pin 2 when the high side pull-up is enabled (depends on the  $V_{in}$  and power consumption).

\*Depending on the load, this value can range from  $V_{in}$  to  $V_{in} - 2.5$

	Minimum	Typical	Maximum	Units
Source Current	0.6 $V_{in} = 7\text{ V}$	1.1 $V_{in} = 12\text{ V}$	3.5 $V_{in} = 36\text{ V}$	mA
$V_{out}$	$V_{in} - 2.5$	—	$V_{in}$	V

## Relay Alarm

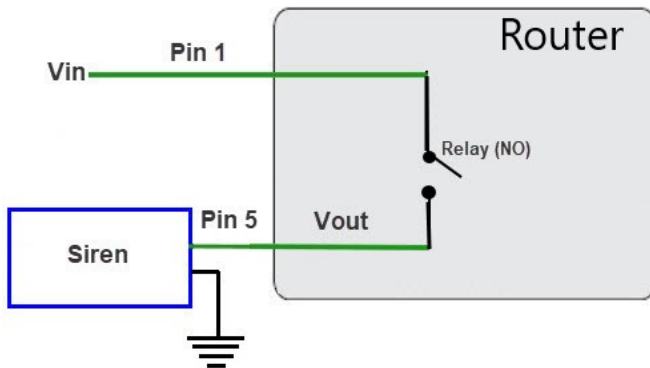

Normally Open (NO) dry contact 1A@24VDC

## Appendix A—Technical Specifications

<b>Technical Specifications</b>			
<b>Cellular</b>	<b>IRG5000</b>	<b>IRG5500+</b>	<b>IRG5500+ FN</b>
<b>LTE</b>	LTE-A-CAT6, 300Mbps downlink and 50Mbps uplink speeds	LTE-A PRO CAT12, 600 Mbps downlink and 150 Mbps uplink speeds	FirstNet Ready certified for Band 14 (B14). LTE-A PRO CAT 12, 600Mbps downlink and 150Mbps uplink speeds
<b>Frequency Bands</b>  <b>Data &amp; SMS Operation over 4G LTE with fallback networks DC-HSPA+/HSPA/UMTS (WCDMA)</b>	<b>4G/LTE Bands</b> 2100(B1), 1900(B2), 1800(B3), AWS(B4), 850(B5), 2600(B7), 900(B8), 700(B12), 700(B13), 800(B20), 850(B25), 700(B26), 700(B29), 2300(B30), TDD B41 <b>3G HSPA/HSPA+ Bands</b> 2100(B1), 1900(B2), 1800(B3), AWS(B4), 850(B5), 800(B8)  <b>Public Safety Bands</b> 26	<b>4G/LTE Bands</b> 2100(B1), 1900(B2), 1800(B3), AWS(B4), 850(B5), 2600(B7), 900(B8), 700(B12), 700(B13), 850(B18), 850(B19), 800(B20), 850(B26), 850(B28), 700(B29), 2300(B30), 1500(B32), TDD B41, TDD B42, TDD B43, TDD B46, CBRS B48, 1700(B66)	<b>4G/LTE Bands</b> 2100(B1), 1900(B2), 1800(B3), AWS(B4), 850(B5), 2600(B7), 900(B8), 1800(B9), 700(B12), 700(B13), 700(B14), 850(B18), 850(B19), 800(B20), 700(B26), 700(B29), 2300(B30), 1500(B32), TDD B41. TDD B42, TDD B43, TDD B46, CBRS B48, 1700(B66)

<b>Technical Specifications</b>			
<b>Frequency Bands</b>  <b>Data &amp; SMS Operation over 4G LTE with fallback networks DC-HSPA+/HSPA/UMTS (WCDMA)</b>		<b>4G HSPA/HSPA+ Bands</b> 2100(B1), 1900(B2), 1800(B3), AWS(B4), 850(B5), 800(B6), 900(B8), 1700(B9), 850(B19) <b>Public Safety Bands</b> 26, 28	<b>4G HSPA/HSPA+ Bands</b> 2100(B1), 1900(B2), AWS(B4), 850(B5), 800(B6), 900(B8), 1700(B9), 850(B19) <b>Public Safety Bands</b> 14, 26
<b>SIM</b>	Dual Mini-SIM 15 x 25mm (or 2FF)		
<b>GPS/GNSS</b>			
<b>GPS/GNSS</b>	Wide-band GNSS: 1559-1606 MHz GPS: 1575.42 MHz / GLONASS: 1602 MHz / BeiDou: 1561.098 MHz / Galileo: 1575.42 MHz / QZSS: 1575.42 MHz Active GNSS antenna support Reports: NMEA 0183 V3.0, TAIP		
<b>GPS / GNSS Passive Antenna</b>	GNSS Applications: GPS, Glonass, Galileo, Beidou Frequency Range: 1561MHz~1606 MHz Gain: 4 dBi (typical) Impedance: 50 Ohm Voltage Standing Wave Ratio: 2.0 (typical) Polarization: RHCP SMA (M) (straight) Dimensions: 41.9 x 47.3 x 16.3 mm / 1.65 x 1.86 x 0.64 in RG-174 Cable length: 5m / 16ft		
<b>Wi-Fi</b>	<b>IRG5000</b>	<b>IRG5500+</b>	<b>IRG5500+ FN</b>
<b>Models with Intergrated Wi-Fi</b>	IRG5521 IRG5541	IRG5521 IRG5541+	IRG5521+ IRG5541+ FN
<b>LAN standards</b>	IEEE 802.11ac complaint & backward compatible with 802.11a/b/g/n		

<b>Technical Specifications</b>			
<b>Power/Current Consumption Idle Mode (connected with Activity)</b>	IRG5540: 0.34A / 4.07W IRG5541: 0.35A / 4.16W	IRG5540+: 0.38A / 4.52W IRG5521+: 0.42A / 5.09W	IRG5541+ FN: 0.41A / 5.09W
<b>Power/Current Consumption Idle Mode (connected/ no Activity)</b>	IRG5540: 0.32A / 3.86W IRG5541: 0.37A / 4.46W	IRG5540+: 0.35A / 4.14W IRG5521+: 0.39A / 4.67W	IRG5541+ FN: 0.39A / 4.679W
<b>Note:</b> up to 0.08A /1W more in power savings can be achieved through shutting down the USB port, LEDs, GPS, as well as turning down the router processor speed.			
<b>Power/Current Consumption Standby Mode (no Activity with all ports shutdown)</b>	All models: 3.9mA / 46.8mW		
<b>One GPIO Input</b>	Digital Input & Pulse Counting VDC: 0 for $\leq 1V$ , 1 for $\geq 2.7V$ Dry Contact Max Current range: min 0.6mA @ 7V and max 3.5mA @ 36V Current Sink Output: 0.5A @ 12v		
<b>Ignition Sense</b>	Analog Input: 0.5V to 36V		
<b>Ethernet Port</b>	4 Ethernet 10/100/1000 MBPS Ethernet RJ45 copper Auto-neg Isolation 1.5 kV IEEE 802.3 for 10Base-T IEEE 802.3u for 100Base-TX and 100Base-FX IEEE 802.3ab for 1000Base-T IEEE 802.3x for Flow Control		
<b>USB</b>	1 x USB, Type-C Can be used as a console or additional Ethernet port.		
<b>RS232 Serial</b>	1 DB9 Female connector Speeds 300bps-230Kbps or custom 15Kv ESD protection		
<b>RS485</b>	half-duplex		

<b>Technical Specifications</b>			
<b>Power and Auxiliary Connectors</b>			
<b>GPIO</b>	Digital Input & Pulse Counting VDC: 0 for $\leq 1V$ , 1 for $\geq 2.7V$ Dry Contact Max Current range: min 0.6mA @ 7V and max 3.5mA @ 36V Current Sink Output: 0.5A @ 12V		
<b>Power/Current Consumption</b>	Standby (no activity / all ports shutdown): 3.9mA / 46.8mW Idle Mode (connected/no Activity): 0.23A / 2.70W Typical Use (connected/with Activity): 0.24A / 2.88W	Standby (no activity / all ports shutdown): 3.9mA / 46.8mW Idle Mode (connected/no Activity): 0.25A / 2.94W Typical Use (connected/with Activity): 0.28A / 3.30W	
<b>Note:</b> up to 0.05A / 0.6W more in power savings can be achieved through shutting down the USB port, LEDs, GPS, as well as turning down router processor speed			
<b>Two Digital Inputs</b>	Digital Input & Pulse Counting VDC: 0 for $\leq 1V$ , 1 for $\geq 2.7V$		
<b>One Alarm Relay</b>	Normally Open (NO) dry contact: 1A @ 24VDC		
<b>External Power Supply (optional)</b>	110/220 VAC Power supply		
<b>Power Input</b>	12/24 VDC Nominal (7 to 36 VDC Range)		
<b>External Power Supply (optional)</b>	110 / 220 VAC Power Supply		
<b>Power Input</b>	12/24 VDC Nominal (7-36 VDC range)		
<b>Power Line Protection</b>	Fast transients 1.5KV (ENG61000-4-4 Criteria B) Surge 2KV (EN61000-4-5 common mode), 1.5KV (EN61000-4-5 differential and common modes)		
<b>Vehicle Transient voltage protection</b>	Built-in protection against voltage transient including 5 VDC engine cranking and +200 VDC load dump		
<b>Power Line Protection</b>	Surge: 8V (EN61000-4-5 common mode), 2KV (EN61000-4-5 differential and common modes)		

<b>Technical Specifications</b>		
<b>Ignition Sense</b>	VDC voltage variation with On/Off timer	
<b>Reverse polarity protection</b>	YES	
<b>WLAN (Wireless) IRG5541/5541+ models</b>	2.4GHz 24 dBm and 5GHz 23dBm output power IEEE 802.11 compliant and backwards compatible with 802.11 a/b/g/n	
<b>Environmental Specifications</b>		
<b>Operating Temperature Ranges</b>	-40°C to 70°C (40°F to 158°F)	
<b>Storage Temperature</b>	-40°C to 85°C (40°F to 185°F)	
<b>Operating Humidity Ranges</b>	0% to 95% non-condensing	
<b>Storage Humidity Ranges</b>	0% to 95% non-condensing	
<b>Operating Altitude</b>	Up to 3,048 meters (10,000 feet)	
<b>Cooling</b>	EN 60068-2-1	
<b>Dry heat</b>	EN 60068-2-2	
<b>Damp</b>	EN 60068-2-30	
<b>MTBF</b>	MTBF (no Wi-Fi): > 234,435 hours MTBF (with Wi-Fi): > 192,137 hours (Calculation model based on MIL-HDBK-217-FN2 @ 30°C/86°F)	
<b>Regulatory Approvals</b>		
<b>Cellular/Telecom</b>	FCC/ICES, RED, PTCRB/CTIA, CE	
<b>Cellular Certifications</b>	Verizon, AT&T	
<b>Carrier Certifications IRG5500+ FN</b>	AT&T	
<b>Cellular/Telecom Regulatory Approvals</b>	IRG5000/IRG5000+ FCC/ICES, RED, PTCRB/CTIA, CE	IRG5500+ FN FCC/ICES, PTCRB/CTIA
<b>Shock and Vibration</b>	EN 61373 (Shock, Vibration long-life / functional-random) MIL-STD-810G (Shock: test method 516.6. Operational Vibration: test method 514.6) SAE J1455 (Vibration: Section 4.10.4.1 and 4.10.4.2 Cab Mount, Shock: Section 4.11.3.4 Operational Shock)	
<b>Hazloc</b>	IECEX/IECx, ATEX Class 1 Zone 2, Directive 2014/34/EU ANSI/ISA 12.12.01, Class 1 Division 2 Groups A-D, ISA 12.12.01-2015	









<b>Technical Specifications</b>	
<b>Vehicle Usage</b>	E-Mark (UN ECE Regulation 10.04, ISO 7637-2:2011 and ISO 16750-2:2012)
<b>Velocity</b>	< 100m/s
<b>Railway</b>	EN 50155: 2017 Clause 4.3.6 EN 50121-1: 2017 EN 50121-3-2: 2016 EN 50121-4: 2016 IEC 60571:2012 For Clause 12.2.8 & 12.2.9 IEC 62236-1: 2018 IEC 62236-3-2: 2008 IEC 62236-4: 2018
<b>Emissions</b>	FCC 47 Part 15, Subpart B, Class A ICES-003 Issue 6 Class A (Canada) FCC Part 15.247 Subpart C (2.4 Ghz) FCC Part 15.407 Subpart E (5 Ghz) ANSI C63.4 Class A (Radio-Noise Emissions from Low-Voltage Electrical and Electronic Equipment in the Range of 9 kHz to 40 GHz) EN61000-3-2: 2014 (Limits for Harmonic Current Emissions) EN61000-3-3: 2013 (Limits of Voltage Fluctuations and Flicker) EN 61000-6-4:2007 + A1:2011 CISPR 32:2015/EN 55032:2015 Class A (Electromagnetic compatibility of multimedia equipment - Emission requirements)











<b>Technical Specifications</b>	
<b>Immunity</b>	CISPR 25:2016/EN55025: (Vehicles, boats and internal combustion engines - RDC) CISPR 35:2016/EN 55035:2017 (IR) EN 61000-4-2:2009 (ESD) +/-2 kV, +/-4 kV, +/-6 kV, +/-8 kV (Contact) +/-15 kV (Air) EN 61000-4-3: 2006 + A1:2007 + A2:2010(RS) EN 61000-4-4:2012 (EFT) 2 KV (Criteria A) EN 61000-4-5:2014+AMD1:2017 (Surge) 2KV (line to earth), 1.5KV (line to line) EN 61000-4-6: 2013 (CS) EN 61000-4-8: 2009 (PFMF) EN 61000-4-9: 2016 (PMF) EN 61000-4-11: 2004 + A1:2017 EN 61000-4-16 EN 61000-6-4: 2007 + A1: 2011 ISO 7637-2:2004
<b>Safety</b>	UL/ULC/EN 62368-1 (including CB) CE Mark CAN/CSA-C22.2 No. 62368-1-14 UL 61010-1 and 61010-2-201
<b>Cellular / WWAN Radio Standards</b>	EN 301 489-1 (V2.1.1:2017-02), ETSI EN 301 489-1 V2.1.1 (2017-02) EN 301 489-17 (V3.2.0:2017-03), ETSI EN 301 489-17 V3.1.1 (2017-02) EN 301 489-19 (V2.1.1:2019) EN 301 908-1 v11.1.7:2018-12, ETSI EN 301 908-1 V7.1.1 (2015-03) (Radiated emissions RF control and monitoring) EN 301 908-2 v11.1.2:2017-08, ETSI EN 301 908-2 V11.1.2 (2017-08) (RF conducted) EN 301 908-13 v11.1.2:2017-07, ETSI EN 301 908-13 V11.1.2 (2017-07) (RF Conducted) EN 62311:2019, IEC 62311 Ed. 1.0 b:2007 (Human exposure restrictions for radio frequency electromagnetic fields)
<b>Cellular/Telecom Regulatory Approvals</b>	IRG5540/5541+FCC/ICES, RED, PTCRB/CTIA, CE IRG5541+ FN FCC/ICES, PTCRB/CTIA
<b>Environment Testing</b>	

<b>Technical Specifications</b>	
<b>IP rating</b>	Complaint to IP54
<b>Drop</b>	ISTA 2A 2001 test categorizes 1, 4,5, and 6
<b>Digital input and pulse counting</b>	Digital Input & Pulse Counting VDC: 0 for $\leq 1V$ , 1 for $\geq 2.7$
<b>Relay</b>	Normally Open (NO) dry contact 1A@24VDC
<b>Bandwidth</b>	45 MHz
<b>Impedance</b>	50 Ohm
<b>VSWR</b>	2.0 Typical
<b>Gain</b>	RHCP
<b>Polarization</b>	4 dBic (typical)
<b>Axial Ratio at elevation</b>	5 dB (typical)
<b>Vehicle Usage</b>	E-Mark (UN ECE Regulation 10.04, ISO 7637-2:2011 and ISOk 16750-2:2012)
<b>Vehicle Velocity</b>	224 mph for cellular connectivity

## Appendix B—Sample Labels

 <b>IRG5541</b> P/N: 08000090 S/N: 350-091319T00001 	Contains: FCC-ID: N7NEM7455 IC: 2417C-EM7455	
		
IMEI: 861824563918022 	DEMKO 19 ATEX 2287 X II 3 G Ex ec nC IIC T4 Gc -40c ≤ Tamb. ≤ 70c 60 Renfrew Drive, Markham, Ontario, Canada. L3R 0E1	
MAC : 004002930003 		
SSID: IRG5541_93000F Wireless Password: <b>67885274</b> Input : 7-36VDC, 1000mA max.	IND. CONT. EQ. FOR HAZ. LOC. Class I, Division 2, Groups A,B,C and D Temp Code:T4A Max. Ambient 70Deg.C Min. Ambient -40Deg.C	
 <b>10R-053094</b> Model: IRG5500	Made in Taiwan	

 <b>IRG5541+</b> P/N: 08000100 S/N: 350-101319T00001 	Contains: FCC-ID: N7NEM75 IC: 2417C-EM75	
		
IMEI: 861824563918022 	DEMKO 19 ATEX 2287 X II 3 G Ex ec nC IIC T4 Gc -40c ≤ Tamb. ≤ 70c 60 Renfrew Drive, Markham, Ontario, Canada. L3R 0E1	
MAC : 004002930003 		
SSID: IRG5541+_93000F Wireless Password: <b>67885274</b> Input : 7-36VDC, 1000mA max.	IND. CONT. EQ. FOR HAZ. LOC. Class I, Division 2, Groups A,B,C and D Temp Code:T4A Max. Ambient 70Deg.C Min. Ambient -40Deg.C	
 <b>10R-053094</b> Model: IRG5500+	Made in Taiwan	

## Appendix C—Mounting the IRG554x

### Option One

1. Attached the two DIN Rail screws to the holding plate. The DIN rail can be positioned either with the snap on connector in the down or up position on the holding plate in the up position.



2. Position the router so that the top hooks of the DIN rail clip attach onto the top of the DIN rail.
3. Rotate the bottom of the router towards the rail to snap the bottom hooks of the DIN rail clip onto the bottom of the DIN rail.

### Option Two

1. Attached the two DIN Rail screws to the holding plate. The DIN rail can be positioned either with the snap on connector in the down or up position on the holding plate in the up position.



2. Slide the two screws into the holding plate, then attach that holding plate to the router. Slide the two screws into the holding plate, then attach that holding plate to the router.



3. Position the router such that the top hooks of the DIN Rail clip attach onto the top of the DIN Rail.
4. Rotate the bottom of the router towards the rail. This will snap the bottom hooks of the DIN Rail clip into the bottom of the DIN Rail.

## Appendix D—Mechanical

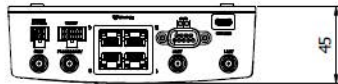
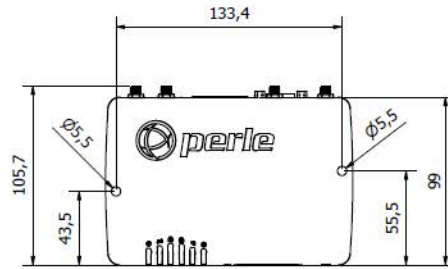
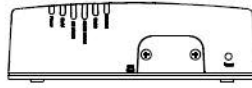
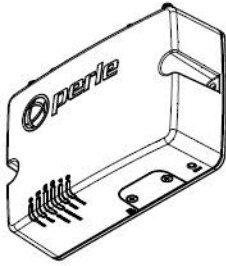

## Appendix E—Maintaining and Troubleshooting

### Maintaining

- Ensure easy access to the cables
- Ensure cables are not bent, constricted, close to high amperages, or exposed to extreme temperatures
- Check that the Front panel LEDs are easily visible
- Wipe case clean with a dry cloth—do not use solvents or cleaning agents