

# DSM0400

Fixed Mount Area Imager  
Bar Code Reader



## **Datalogic S.r.l.**

Via S. Vitalino, 13  
40012 Calderara di Reno  
Italy  
Tel. +39 051 3147011  
Fax +39 051 3147205

### **©2019 Datalogic S.p.A. and/or its affiliates**

◆ All rights reserved. ◆ Without limiting the rights under copyright, no part of this documentation may be reproduced, stored in or introduced into a retrieval system, or transmitted in any form or by any means, or for any purpose, without the express written permission of Datalogic S.p.A. and/or its affiliates. Owners of Datalogic products are hereby granted a non-exclusive, revocable license to reproduce and transmit this documentation for the purchaser's own internal business purposes. Purchaser shall not remove or alter any proprietary notices, including copyright notices, contained in this documentation and shall ensure that all notices appear on any reproductions of the documentation. Should future revisions of this manual be published, you can acquire printed versions by contacting your Datalogic representative. Electronic versions may either be downloadable from the Datalogic website ([www.datalogic.com](http://www.datalogic.com)) or provided on appropriate media. If you visit our website and would like to make comments or suggestions about this or other Datalogic publications, please let us know via the "Contact Datalogic" page.

### **Disclaimer**

Datalogic has taken reasonable measures to provide information in this manual that is complete and accurate, however, Datalogic reserves the right to change any specification at any time without prior notice.

Datalogic and the Datalogic logo are registered trademarks of Datalogic S.p.A. in many countries, including the U.S.A. and the E.U.

All other trademarks and brands are property of their respective owners.

### **Patents**

See [www.patents.datalogic.com](http://www.patents.datalogic.com) for patent list.

See the Regulatory Addendum included with your product for additional regulatory, safety and legal information.



# Table of Contents

- INTRODUCTION..... 1**
  - About the Scanner ..... 1
  - Using the DSM0400 ..... 1
  - About this Manual ..... 1
  - Overview ..... 2
    - Manual Conventions ..... 2
  - Technical Support ..... 3**
    - Support through the Website ..... 3
    - Reseller Technical Support ..... 3
    - Telephone Technical Support ..... 3
- SETUP..... 5**
  - Unpacking ..... 5
  - Setting Up the Scanner ..... 5**
    - Connect Host Interface ..... 6
      - RS-232 Serial Connection ..... 6
      - USB Connection ..... 6
    - DSM0400 Mounting using brackets ..... 7
      - Multi side Mounting Bracket ..... 7
      - Angular Bracket (-17° to 25° Angle Mounting) ..... 8
      - Both Brackets applied ..... 8
  - Using the DSM0400 ..... 9
  - Interface Selection ..... 10**
    - Configuring the Interface ..... 10
  - Customizing Configuration Settings ..... 12**
    - Using the Programming Bar Codes ..... 12
      - Datalogic DESP protocol SDK ..... 12
      - DespDemoApp ..... 12
      - Datalogic Aladdin™ Utility ..... 12
    - Interface Settings ..... 13
    - Configuring Other Features ..... 13
    - Software Version Transmission ..... 13
    - Resetting the Product Configuration to Defaults ..... 13
- CONFIGURATION USING BAR CODES ..... 15**
  - Configuration Parameters ..... 15**
    - RS-232 ONLY Interface ..... 17**
      - Baud Rate ..... 17
      - Data Bits ..... 18
      - Stop Bits ..... 19
      - Parity ..... 19
      - Handshaking Control ..... 20
    - USB Keyboard ONLY Interface ..... 21**
      - Country Mode ..... 22
      - Setting Country Mode ..... 23
      - Setting Encoding Type ..... 37
      - Setting ALT Input Type ..... 44
      - Setting ALT Output Type ..... 44
      - Keyboard Numeric Keypad ..... 45
      - Keyboard Send Control Characters ..... 45
    - USB-OEM ONLY Interface..... 47**
      - Introduction ..... 47
      - USB-OEM Device Usage ..... 48
  - Data Format ..... 49**
    - Global Prefix/Suffix ..... 50
    - Global AIM ID ..... 51
    - GS1-128 AIM ID ..... 52
  - Reading Parameters ..... 53**

Double Read Timeout .....	54
LED AND SPEAKER INDICATORS .....	56
Good Read Speaker Volume .....	56
Enable/Disable Green Spot (Good Read) LED Indicator .....	57
Enable/Disable Trigger LED indicator .....	57
Enable/Disable Power LED Indicator .....	58
SCANNING FEATURES .....	59
Scan Mode .....	59
Flash On Time .....	60
Flash Off Time .....	61
Stand Mode Sensitivity .....	62
Scanning Active Time .....	63
Pick Mode .....	64
Aiming Pointer .....	65
Green Spot Duration .....	65
Enhanced Mobile Phone Mode .....	66
Decode Negative Image .....	67
<b>Disable all Symbologies .....</b>	<b>68</b>
<b>1D Symbologies .....</b>	<b>69</b>
CODE EAN/UPC .....	72
Coupon Control .....	72
UPC-A .....	72
UPC-A Enable/Disable .....	72
UPC-A Check Character Transmission .....	73
Expand UPC-A to EAN-13 .....	73
UPC-A Number System Character Transmission .....	74
UPC-E .....	74
UPC-E Enable/Disable .....	74
UPC-E Check Character Transmission .....	75
Expand UPC-E to EAN-13 .....	75
Expand UPC-E to UPC-A .....	76
UPC-E Number System Character Transmission .....	76
GTIN FORMATTING .....	77
EAN 13 (JAN 13) .....	78
EAN 13 Enable/Disable .....	78
EAN 13 Check Character Transmission .....	78
EAN-13 ISBN Conversion .....	79
ISSN .....	79
ISSN Enable/Disable .....	79
EAN 8 (JAN 8) .....	80
EAN 8 Enable/Disable .....	80
EAN 8 Check Character Transmission .....	80
Expand EAN 8 to EAN 13 .....	80
UPC/EAN GLOBAL SETTINGS .....	81
UPC/EAN Price Weight Check .....	81
ADD-ONS .....	82
Optional Add-ons .....	82
Optional Add-On Timer .....	83
CODE 39 .....	86
Code 39 Enable/Disable .....	86
Code 39 Check Character Calculation .....	86
Code 39 Check Character Transmission .....	87
Code 39 Start/Stop Character Transmission .....	88
Code 39 Full ASCII .....	88
Code 39 Quiet zones .....	89
Code 39 Length Control .....	90
Code 39 Set Length 1 .....	91
Code 39 Set Length 2 .....	92
Code 39 Interdigit Ratio .....	93
CODE 32 (ITAL PHARMACEUTICAL CODE) .....	95
Code 32 Enable/Disable .....	95
Code 32 Feature Setting Exceptions .....	95
Code 32 Check Char Transmission .....	96
Code 32 Start/Stop Character Transmission .....	96
CODE 39 CIP (FRENCH PHARMACEUTICAL) .....	97
Code 39 CIP Enable/Disable .....	97
CODE 128 .....	98

Code 128 Enable/Disable .....	98
Code 128 Check Character Transmission .....	98
Code 128 Function Character Transmission .....	99
Code 128 Quiet Zones .....	99
Code 128 Length Control .....	100
Code 128 Set Length 1 .....	101
Code 128 Set Length 2 .....	102
GS1-128 .....	103
GS1-128 Enable .....	103
CODE ISBT 128 .....	104
ISBT 128 Concatenation .....	104
ISBT 128 Concatenation Mode .....	104
ISBT 128 Dynamic Concatenation Timeout .....	105
ISBT 128 Advanced Concatenation Options .....	105
INTERLEAVED 2 OF 5 (I 2 OF 5) .....	106
I 2 of 5 Enable/Disable .....	106
I 2 of 5 Check Character Calculation .....	106
I 2 of 5 Check Character Transmission .....	107
I 2 of 5 Length Control .....	108
I 2 of 5 Set Length 1 .....	109
I 2 of 5 Set Length 2 .....	110
FOLLETT 2 OF 5 .....	111
Follett 2 of 5 Enable/Disable .....	111
INTERLEAVED 2 OF 5 CIP HR .....	111
Interleaved 2 of 5 CIP HR Enable/Disable .....	111
STANDARD 2 OF 5 .....	112
Standard 2 of 5 Enable/Disable .....	112
Standard 2 of 5 Check Character Calculation .....	112
Standard 2 of 5 Check Character Transmission .....	112
Standard 2 of 5 Length Control .....	113
Standard 2 of 5 Set Length 1 .....	114
Standard 2 of 5 Set Length 2 .....	115
INDUSTRIAL 2 OF 5 .....	116
Industrial 2 of 5 Enable/Disable .....	116
Industrial 2 of 5 Check Character Calculation .....	117
Industrial 2 of 5 Check Character Transmission .....	117
Industrial 2 of 5 Length Control .....	118
Industrial 2 of 5 Set Length 1 .....	119
Industrial 2 of 5 Set Length 2 .....	120
CODE IATA .....	121
IATA Enable/Disable .....	121
IATA Check Character Transmission .....	121
DATALOGIC 2 OF 5 .....	122
Datalogic 2 of 5 Enable/Disable .....	122
Datalogic 2 of 5 Check Character Calculation .....	122
Datalogic 2 of 5 Length Control .....	123
Datalogic 2 of 5 Set Length 1 .....	124
Datalogic 2 of 5 Set Length 2 .....	125
CODABAR .....	126
Codabar Enable/Disable .....	126
Codabar Check Character Calculation .....	126
Codabar Check Character Transmission .....	127
Codabar Start/Stop Character Transmission .....	128
Codabar Start/Stop Character Match .....	128
Codabar Quiet Zones .....	129
Codabar Length Control .....	130
Codabar Set Length 1 .....	131
Codabar Set Length 2 .....	132
ABC CODABAR .....	133
ABC Codabar Enable/Disable .....	133
ABC Codabar Concatenation Mode .....	133
ABC Codabar Dynamic Concatenation Timeout .....	134
ABC Codabar Force Concatenation .....	135
CODE 11 .....	136
Code 11 Enable/Disable .....	136
Code 11 Check Character Calculation .....	136
Code 11 Check Character Transmission .....	137

Code 11 Length Control .....	137
Code 11 Set Length 1 .....	138
Code 11 Set Length 2 .....	139
GS1 DATABAR™ OMNIDIRECTIONAL .....	140
GS1 DataBar™ Omnidirectional Enable/Disable .....	140
GS1 DataBar™ Omnidirectional GS1-128 Emulation .....	140
GS1 DATABAR™ EXPANDED .....	141
GS1 DataBar™ Expanded Enable/Disable .....	141
GS1 DataBar™ Expanded GS1-128 Emulation .....	141
GS1 DataBar™ Expanded Length Control .....	142
GS1 DataBar™ Expanded Set Length 1 .....	143
GS1 DataBar™ Expanded Set Length 2 .....	144
GS1 DATABAR™ LIMITED .....	145
GS1 DataBar™ Limited Enable/Disable .....	145
GS1 DataBar™ Limited GS1-128 Emulation .....	145
CODE 93 .....	146
Code 93 Enable/Disable .....	146
Code 93 Check Character Calculation .....	146
Code 93 Check Character Transmission .....	147
Code 93 Length Control .....	147
Code 93 Set Length 1 .....	148
Code 93 Set Length 2 .....	149
Code 93 Quiet Zones .....	150
MSI .....	151
MSI Enable/Disable .....	151
MSI Check Character Calculation .....	151
MSI Check Character Transmission .....	152
MSI Length Control .....	152
MSI Set Length 1 .....	153
MSI Set Length 2 .....	154
PLESSEY .....	155
Plessey Enable/Disable .....	155
Plessey Check Character Calculation .....	156
Plessey Check Character Transmission .....	156
Plessey Length Control .....	157
Plessey Set Length 1 .....	158
Plessey Set Length 2 .....	159
<b>2D Symbolgies .....</b>	<b>160</b>
2D Global Features .....	161
2D Structured Append .....	162
2D Normal/Inverse Symbol Control .....	163
2D Symbolgy Selection .....	164
AZTEC CODE .....	164
Aztec Code Enable / Disable .....	164
Aztec Code Length Control .....	165
Aztec Code Set Length 1 .....	166
Aztec Code Set Length 2 .....	167
HAN XIN CODE .....	168
Han Xin Code Enable / Disable .....	168
Han Xin Code: Code Length Control .....	169
Han Xin Code Set Length 1 .....	170
Han Xin Code Set Length 2 .....	171
DATA MATRIX .....	172
Data Matrix Enable / Disable .....	172
Data Matrix Square/Rectangular Style .....	173
Data Matrix Length Control .....	174
Data Matrix Set Length 1 .....	175
Data Matrix Set Length 2 .....	176
MAXICODE .....	177
Maxicode Enable / Disable .....	177
Maxicode Primary Message Transmission .....	177
Maxicode Length Control .....	178
Maxicode Set Length 1 .....	179
Maxicode Set Length 2 .....	180
PDF417 .....	181
PDF417 Enable / Disable .....	181
PDF417 Length Control .....	181

PDF417 Set Length 1 .....	182
PDF417 Set Length 2 .....	183
MICRO PDF417 .....	184
Micro PDF417 Enable / Disable .....	184
Micro PDF417 Code 128 GS1-128 Emulation .....	185
Micro PDF417 Length Control .....	186
Micro PDF417 Set Length 1 .....	187
Micro PDF417 Set Length 2 .....	188
QR CODE .....	189
QR Code Enable / Disable .....	189
QR Code Length Control .....	189
QR Code Set Length 1 .....	190
QR Code Set Length 2 .....	191
MICRO QR CODE .....	192
Micro QR Code Enable/Disable .....	192
Micro QR Code Length Control .....	193
Micro QR Code Set Length 1 .....	194
Micro QR Code Set Length 2 .....	195
UCC COMPOSITE .....	196
UCC Optional Composite Timer .....	196
POSTAL CODE SELECTION .....	197
Postnet BB Control .....	200
NewZealand Postal Control .....	200
<b>REFERENCES .....</b>	<b>201</b>
<b>RS-232 Parameters .....</b>	<b>201</b>
RS-232 Only .....	201
Baud Rate .....	201
Data Bits .....	202
Stop Bits .....	202
Parity .....	202
Handshaking Control .....	202
<b>Data Format .....</b>	<b>203</b>
Data Editing .....	203
Global Prefix/Suffix .....	204
Example: Setting a Prefix .....	204
Global AIM ID .....	205
<b>Scanning Features .....</b>	<b>206</b>
Scan Mode .....	206
Flash On Time .....	207
Flash Off Time .....	208
<b>Symbologies .....</b>	<b>209</b>
Set Length .....	209
Set Length 1 .....	209
Set Length 2 .....	210
<b>TECHNICAL SPECIFICATIONS .....</b>	<b>211</b>
<b>Technical Features .....</b>	<b>211</b>
DSM04X1 models (WVGA) .....	214
DSM04X2-DL models (MP) .....	214
DSM04X2-WA models (MP) .....	215
RS-232 Electrical Connections .....	215
External Trigger (DSM045X models only) .....	216
<b>LED and Beeper Indications .....</b>	<b>216</b>
Button and LED Status .....	216
<b>Indicators .....</b>	<b>217</b>
<b>Troubleshooting .....</b>	<b>218</b>
<b>DSM0400 Dimensions .....</b>	<b>219</b>
Multi-face Bracket for Mounting in 5 sides .....	220
Angular Mounting Bracket .....	221
<b>Ergonomic Recommendations .....</b>	<b>222</b>
<b>Standard Cable Pinouts for DSM049X models .....</b>	<b>223</b>
<b>SAMPLE BAR CODES.....</b>	<b>225</b>
1D Bar Codes .....	225
1D Bar Codes - continued .....	226
<b>GS1 DataBar™ (RSS) .....</b>	<b>227</b>
<b>GS1 DataBar™-14 .....</b>	<b>227</b>
<b>2D Bar Codes .....</b>	<b>228</b>

## Contents

---

ASCII Chart .....	229
<b>KEYPAD</b> .....	<b>231</b>
HID Variable PIN Code .....	233



# Chapter 1

## Introduction

### About the Scanner

With rich feature sets and extensive model options, the DSM0400 product series from Datalogic is a fully self-contained standard range 2D bar code scanning module for use in self-service kiosks or other semi-automated equipment requiring the ability to read a bar code. It is intended to be an easy integration by system designers with little expertise in scanning technology, with RS232 or USB (COM, Composite, Keyboard, OEM) possible interfaces. DSM0400 uses the latest and fastest imaging technology and offers Datalogic's Green Spot for good read feedback.

The scanning technology is essentially the same as the HALOGEN™ family SCAN ENGINES area imagers, with Datalogic decoding platform and some enhancements for presentation reading and improved motion tolerance. The enclosure is designed for ease of integration, is sealed IP54 grade for cleaning, and is constructed of a solvent- and disinfectant-tolerant resin. DSM0400 represents the premium level of data collection equipment for general purpose applications, retail and also light industrial environments.

### Using the DSM0400

To read a symbol or capture an image, simply aim the reader and trigger the scanner, using the button on top or a trigger command through the communication interface. The DSM0400 is a powerful omni-directional reader, so the orientation of the symbol is not important. Datalogic's exclusive patented 'Green Spot' for good-read feedback helps to improve productivity in noisy environments or in situations where silence is required.

The DSM0400 reliably decodes all standard 1D (linear) and 2D bar codes, including DataBar™ codes (Omnidirectional, Expanded, Stacked), Postal Codes (China Post). The data stream – acquired from decoding a symbol – is rapidly sent to the host. The reader is immediately available to read another symbol.

### About this Manual

This Product Reference Guide (PRG) is provided for users seeking advanced technical information, including connection, programming, maintenance and specifications. The Quick Reference Guide (QRG) and other publications associated with this product are can be downloaded for free on [www.datalogic.com](http://www.datalogic.com).

Typically, units are factory-programmed for the most common terminal and communications settings. If you need to modify any programmable settings,

custom configuration can be accomplished by scanning the programming bar codes within this guide.

Programming can also be performed using the protocol “Decoded Engine Serial Protocol” (DESP) or using Datalogic Aladdin™ Configuration application, downloadable from the Datalogic website. This multi-platform utility programs allow device configuration using a PC. It communicates with the device using a serial or USB cable and can also create configuration barcodes to print.

## Overview

**Chapter 1**, Introduction provides a product overview, information about Technical Support and manual.

**Chapter 2**, Setup presents information about unpacking and setting up the scanner, and interface configuration bar codes and details.

**Chapter 3**, Configuration Using Bar Codes provides instructions and bar code labels for customizing your scanner. There are different sections for interface types, default factory settings, general features, data formatting and symbology specific features.

**Chapter 4**, References provides details concerning programmable features.

**Appendix A** Technical Specifications lists physical and performance characteristics, as well as environmental and regulatory specifications. It also provides standard cable-pin-outs and descriptions of the functions and behaviors of the scanner’s LED and Speaker indicators.

**Appendix B** Sample Bar Codes offers sample bar codes of several common symbologies.

**Appendix C** Keypad includes numeric bar codes to be scanned for certain parameter settings.

## Manual Conventions

The following conventions are used in this document:

The symbols listed below are used in this manual to notify the reader of key issues or procedures that must be observed when using the reader:



**NOTE**

Notes contain information necessary for properly diagnosing, repairing and operating the reader.



**CAUTION**

The CAUTION symbol advises you of actions that could damage equipment or property.

## Technical Support

### Support through the Website

Datalogic provides several services as well as technical support through its website. Log on to [www.datalogic.com](http://www.datalogic.com).

For quick access, from the home page click on the search icon  , and type in the name of the product you're looking for. This allows you access to download Data Sheets, Manuals, Software & Utilities, and Drawings.

Hover over the Support & Service menu for access to Services and Technical Support.

### Reseller Technical Support

An excellent source for technical assistance and information is an authorized Datalogic reseller. A reseller is acquainted with specific types of businesses, application software, and computer systems and can provide individualized assistance.

### Telephone Technical Support

If you do not have internet or email access, you may contact Datalogic technical support or check the back cover of your manual for more contact information.





## Chapter 2 Setup

### Unpacking

Check carefully to ensure the device and any cables or accessories ordered are present and undamaged. If any damage occurred during shipment, contact "Technical Support" on page 3.

KEEP THE PACKAGING. Should the unit ever require service, it should be returned in its original shipping container.

### Setting Up the Scanner

Figure 1 Cable Connection/Disconnection to the Scanner (DSM049X only)

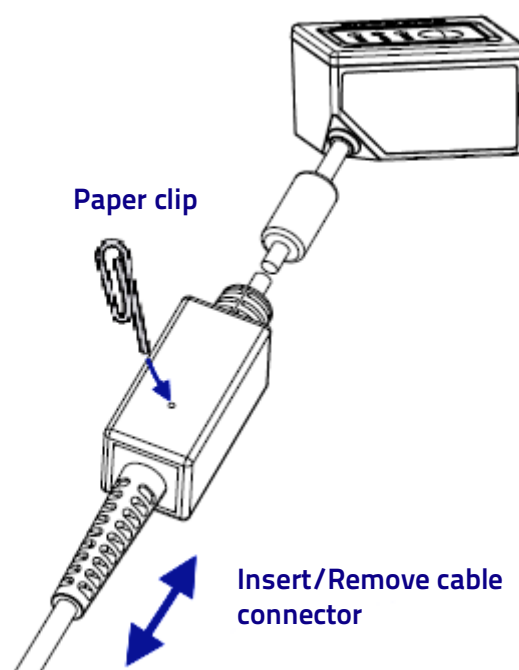

Follow the steps provided in this section to connect and get your scanner up and communicating with its host:

1. (DSM049X Models only) **IMPORTANT:** First of all, connect the Datalogic Interface Cable (not included – to be selected among the possible accessories) to the scanner as shown in Figure 1. To insert/remove the cable, insert a paper clip or similar object into the opening shown.

2. Connect the other end to the Host (see the next section [Connect Host Interface](#) on page 6, and Figure 2).
3. Modify [Customizing Configuration Settings](#) on page 12 (only if modifications are needed from factory settings).

## Connect Host Interface

The scanner kit you ordered to match your interface should provide a compatible cable for your installation. If this is not so, contact [Technical Support](#). The scanner can communicate using the following interfaces:

### RS-232 Serial Connection

Turn off power to the terminal/PC and connect the scanner to the terminal/PC serial port via the RS-232 cable as shown in Figure 2. If the terminal will not support POT (Power Off the Terminal) to supply scanner power, use the approved power supply (AC Adapter). Plug the AC Adapter barrel connector into the socket on the RS-232 cable connector and the AC Adapter plug into a standard power outlet as shown in Figure 2.

**RS-232:** The scanner can communicate with a standard RS-232 host.

### USB Connection

Connect the scanner to a USB port on the terminal/PC using the USB connector at the end of the cable.

**USB:** Select to communicate either by USB Composite (Keyboard + COM), USB OEM, USB COM STD, or USB Keyboard only interface types by scanning the appropriate interface type bar codes available in this manual. The default interface is USB Composite (Keyboard + COM).



NOTE

Specific cables are required for connection to different hosts. The connections illustrated in Figure 2 are examples only. Actual connectors may vary from those illustrated, but the steps to connect the scanner remain the same.

Figure 2 - Connection to Host Interface

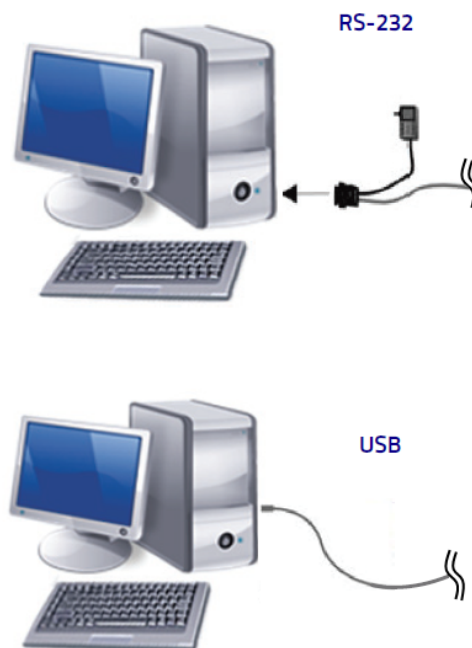

## DSM0400 Mounting using brackets

The brackets are included for mounting the DSM0400 onto a stationary surface, on all sides or with different angles. Attach the desired bracket to the bottom of the reader using the provided screws, as shown in the figures below. See [Appendix A](#) for the mechanical drawings.

### Multi side Mounting Bracket

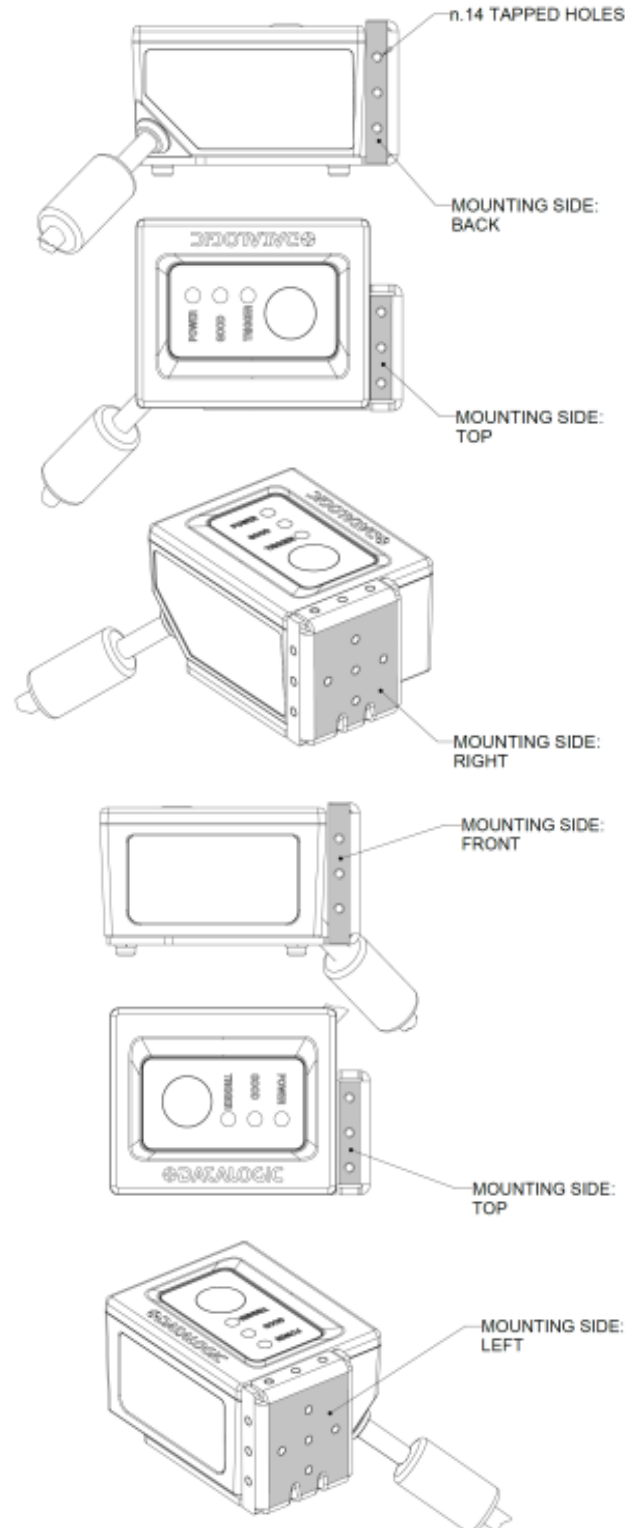

## Angular Bracket (-17° to 25° Angle Mounting)

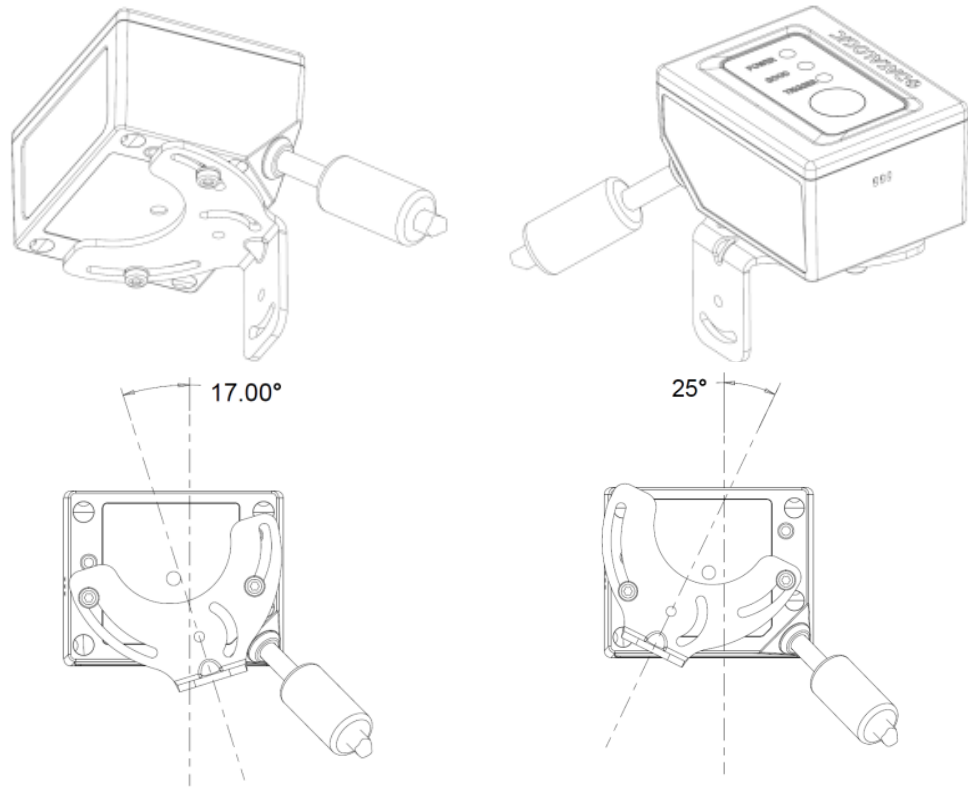

### Both Brackets applied

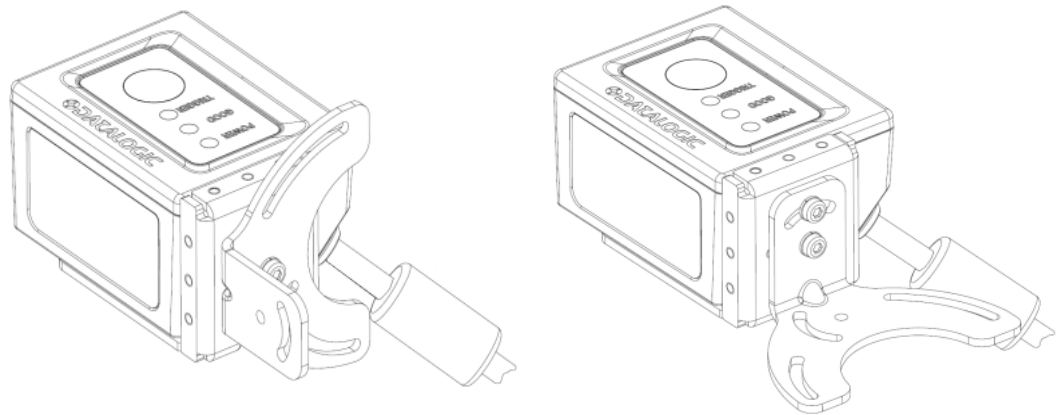

N.4 M2x0.4X4 ISO14583 NYLOK 180 T6 SCREWS, N.4 LOCK WASHERS UNI 1751 INCLUDED

## Using the DSM0400

The DSM0400 normally functions by capturing and decoding codes. The aiming system is activated on trigger pull and indicates the center of the field of view which should be positioned over the bar code:

**Aiming System**

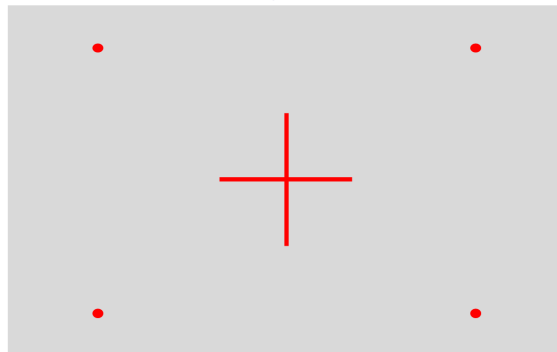

**Relative Size and Location of Aiming System Pattern**

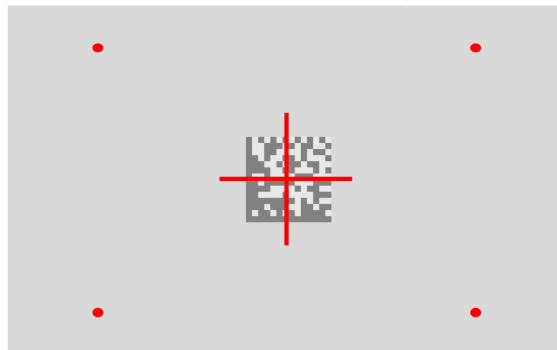

**2D Matrix Symbol**

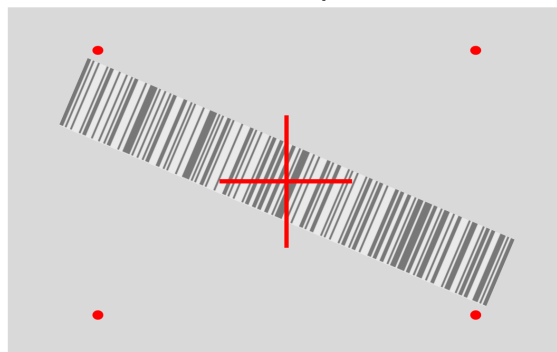

**Linear Bar**

A red beam illuminates the label. The field of view indicated by the aiming system will be smaller when the reader is closer to the bar code and larger when it is farther from the code. Symbologies with smaller bars or elements (mil size) should be read closer to the unit. If the aiming system is centered and the entire bar code is within the aiming field, you will get a good read. Successful reading is signaled by an audible tone plus a good-read green spot LED indicator.

### Relative Size and Location Green Spot

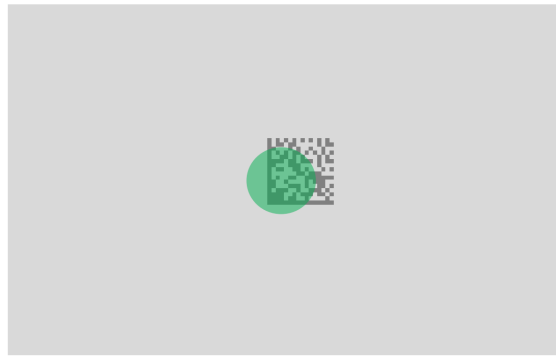

## Interface Selection

Upon completing the physical connection between the scanner and its host, proceed directly to "Configuring the Interface" on page 10 for information and programming for the desired interface type and scan the appropriate bar code in that section to select your system's correct interface type.

The scanner, depending upon the model, will support one of the following sets of host interfaces:

- USB (Keyboard, COM, OEM)
- USB Composite (Keyboard + COM)
- RS-232 STD

For an improved ease of installation, the DSM0400 features a cable auto-recognition procedure at the startup:

- if a RS232 cable is used, the device will always boot in the RS232 interface configuration.
- If a USB cable is used the device will always boot in the preferred USB interface configuration, as described in "Configuring the Interface" (default is USB composite interface). Scan the appropriate barcode for your reader's interface type from the following section.

## Configuring the Interface

Scan the programming bar code from the following section which selects the appropriate interface type to match the system the scanner will be connected to. Next, proceed to the corresponding chapter in this manual (also listed in the table) to configure any desired settings and features associated with that interface. The default interface of DSM0400 is USB-Composite



### NOTE

Thanks to the cable auto-recognition feature, there is no need to scan RS-232 interface because it is automatically selected at power-up; the RS-232 label is anyway provided for reference in case of specific needs.



NOTE

Unlike some other programming features and options, interface selections require that you scan only one programming bar code label. DO NOT scan an ENTER/EXIT Programming Mode bar code prior to scanning an interface selection bar code.

Table 1. Available Interfaces

<p>RS-232 standard interface (Interface features starting on page 17)</p>	 Select RS232-STD
 Select USB-COM	<p>USB Com emulating RS-232 standard interface</p>
<p>USB-OEM (can be used for OPOS/UPOS/JavaPOS) (Interface features starting on page 47)</p>	 Select USB-OEM
 Select USB-Keyboard	<p>USB-Keyboard with standard key encoding (Interface features starting on page 21)</p>
<p>USB-Composite (combines USB-Keyboard and USB-COM)</p> 	 Select USB-Composite

---

## Customizing Configuration Settings

### Using the Programming Bar Codes

This manual contains feature descriptions and bar codes which allow you to reconfigure your scanner. Some programming bar code labels, like "Resetting the Product Configuration to Defaults" on page 13, require only the scan of that single label to enact the change. Most of the programming labels in this manual, however, require the scanner to be placed in Programming Mode prior to scanning them. Scan an ENTER/EXIT Programming Mode bar code once to enter Programming Mode. Once the scanner is in Programming Mode, you can scan a number of parameter settings before scanning the ENTER/EXIT bar code a second time, which will then accept your changes, exit Programming Mode and return the scanner to normal operation.



**NOTE**

There are some exceptions to the typical programming sequence described above. Please read the description and setting instructions carefully when configuring each given programmable feature.

### Datalogic DESP protocol SDK

The Decoded Engine Serial Protocol (DESP) is a serial communication protocol developed by Datalogic, independent from both the platform and the physical layer. DESP is also available as a software library, in order to enhance the application development. The provided APIs covers the most common activities, such as acquisition and configuration, so that DSM0400 can be controlled and configured using its communication interface with the host. The SDK can also be used for software update.

### DespDemoApp

This demo application is a GUI-based software that implements the DESP library. It is available for Windows platforms and for RS-232 and USB-COM communication protocols. This application covers all the main features of the protocol and it is very useful to let the user familiarize with the DESP protocol and the product.

### Datalogic Aladdin™ Utility

Programming can alternatively be performed using the Datalogic Aladdin™ Configuration application which is available for free download from the Datalogic website listed on the back cover of this manual. This multi-platform utility program allows device configuration using a PC. It communicates to the device using a serial or USB cable and can also create configuration bar codes to print.

Datalogic Aladdin™ is a multi-platform utility program providing a quick and user-friendly configuration method via the RS-232/USB-COM interface. The Aladdin utility is available on the Datalogic website. Aladdin allows you to program the scanner by selecting configuration commands through a user-friendly graphical interface running on a PC. These commands are sent to the scanner over the selected communication interface, or they can be printed as bar codes to be scanned.

Aladdin also provides the ability to perform a software upgrade for the connected device (see the Datalogic Aladdin™ Help On-Line for more details).

## Interface Settings

The scanner is typically factory-configured with a set of default features standard to the interface type you ordered. See [Using the DSM0400 on page 9](#).

[Configuration Using Bar Codes](#) provides settings configurable by all interface types. If your installation requires you to further customize your scanner, you can select other options through use of the instructions and programming bar codes available in the appropriate section for your interface.

- [RS-232 ONLY Interface, starting on page 17](#)
- [USB Keyboard ONLY Interface, starting on page 21](#)
- [USB-OEM ONLY Interface, starting on page 47](#)

## Configuring Other Features

If your installation requires different programming than the standard factory default settings, the following sections of this manual allow configuration of non-interface-specific settings you might require:

[Configuration Using Bar Codes: General Features](#) includes programming for scanning, speaker and LED indicators and other such universal settings.

[Reading Parameters: Reading Parameters](#) include programming for scanning, speaker and LED indicators and other universal settings.

[2D Symbologies:](#) Includes options concerning the bar code label types (symbologies). These settings allow you to enable/disable symbologies, set label lengths, require check digit, etc.

## Software Version Transmission

The software version of the device can be transmitted over the RS-232, Keyboard and USB interfaces by scanning the following label.



Transmit Software Version

## Resetting the Product Configuration to Defaults

If you aren't sure what programming options are in your scanner, or you've changed some options and want to restore the Default Configuration, scan the [Restore Default Configuration](#) bar code below. This will restore the factory configuration for the currently active interface.



**NOTE**

Defaults are based on the interface type. Configure the scanner for the correct interface before scanning this label.



Restore Default Configuration

The DSM0400 decoder supports either DM configuration or C128 configuration barcodes. In this manual only C128 labels are included.

The DSM0400 default uses C128 labels for configuration. To switch back and forth between the two barcode types, scan the following barcodes:

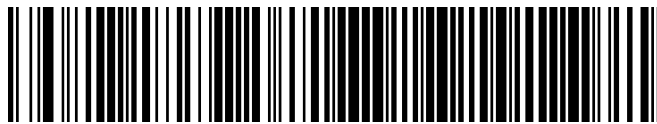

C128 switches to DM configuration



DM switches to C128 configuration



## Chapter 3

# Configuration Using Bar Codes

This and following sections provide programming bar codes to configure your scanner by changing the default settings. For details about additional methods of programming, see "Customizing Configuration Settings" on page 12.



**NOTE**

You must first enable your scanner to read bar codes in order to use this section. If you have not done this, go to Setup, starting on page 5 and complete the appropriate procedure.

## Configuration Parameters

Once the scanner is set up, you can change the default parameters to meet your application needs. Refer to "Resetting the Product Configuration to Defaults" on page 13 for initial configuration in order to set the default values and select the interface for your application.

The following configuration parameters are divided into logical groups, making it easy to find the desired function based on its reference group.

### Interface Configuration:

- "RS-232 ONLY Interface" on page 17
- "USB Keyboard ONLY Interface" on page 21
- "USB-OEM ONLY Interface" on page 47

### Parameters common to all interface applications:

- "Global Prefix/Suffix" on page 50
- "Data Format" on page 49 offers advanced configuration options for customization of scanned data output.
- "Reading Parameters" on page 53 control various operating modes and indicators status functioning.

### Symbology-specific parameters:

"2D Symbologies" on page 160 defines options for all symbologies and provides the programming bar codes necessary for configuring these features.



#### NOTE

You must first enable your scanner to read bar codes in order to use this section. If you have not done this, go to Setup, starting on page 5 and complete the appropriate procedure.

### To program features:

1. Scan the ENTER/EXIT PROGRAMMING MODE bar code, available at the top of each programming page, when applicable.
2. Scan the bar code to set the desired programming feature. You may need to cover unused bar codes on the page, and possibly the facing page, to ensure that the scanner reads only the bar code you intend to scan.
3. If additional input parameters are needed, go to [Appendix C](#), and scan the appropriate characters from the keypad.



#### NOTE

Additional information about many features can be found in Chapter 4, "References".

If you make a mistake before the last character, scan the CANCEL bar code to abort and not save the entry string. You can then start again at the beginning.

4. Complete the programming sequence by scanning the ENTER/EXIT PROGRAMMING MODE bar code to exit Programming Mode.

For more detailed description, programming information and examples for setting selected configuration items, see [Chapter 4, References](#).



## RS-232 ONLY INTERFACE

Use the programming bar codes in this chapter if modifications to the standard RS-232 interface settings are necessary to meet your system's requirements.

<b>BAUD RATE</b> on page 17	<b>PARITY</b> on page 19
<b>DATA BITS</b> on page 18	<b>HANDSHAKING CONTROL</b> on page 20
<b>STOP BITS</b> on page 19	

### Baud Rate

Baud rate is the number of bits of data transmitted per second. Set the scanner's baud rate to match the baud rate setting of the host device. With an improper baud rate setting, data may not reach the host correctly.

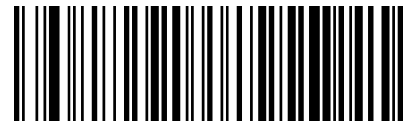

Baud Rate = 1200



Baud Rate = 2400



Baud Rate = 4800



Baud Rate = 9600



Enter/Exit Programming Mode

---

## Baud Rate (continued)



Baud Rate = 19,200

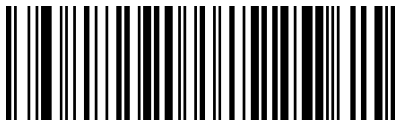

Baud Rate = 38,400

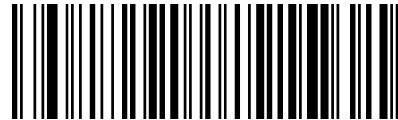

Baud Rate = 57,600



Baud Rate = 115,200



## Data Bits

This parameter allows the reader to interface with devices requiring a 7-bit or 8-bit ASCII protocol for sending and receiving data.



7 Data Bits



8 Data Bits





## Stop Bits

The stop bit(s) at the end of each transmitted character marks the end of transmission of one character and prepares the receiving device for the next character in the serial data stream. The number of stop bits selected (one or two) depends on the number the receiving terminal is programmed to accommodate. Set the number of stop bits to match host device requirements.

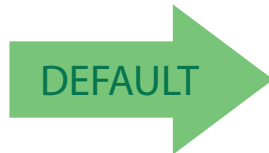

1 Stop Bit



2 Stop Bits

## Parity

This feature specifies parity required for sending and receiving data. A parity check bit is the most significant bit of each ASCII coded character. Select the parity type according to host device requirements.

- Select None when no parity bit is required.
- Select Odd parity and the parity bit value is set to 0 or 1, based on data, to ensure that an odd number of 1 bits are contained in the coded character.
- Select Even parity and the parity bit value is set to 0 or 1, based on data, to ensure that an even number of 1 bits are contained in the coded character.

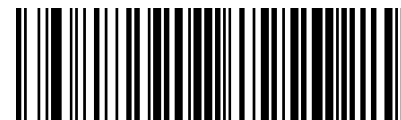
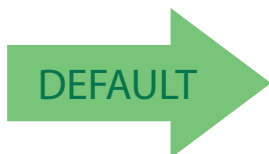

Parity = None



Parity = Even



Parity = Odd



## Handshaking Control

The data interface consists of an RS-232 port designed to operate either with or without the hardware handshaking lines, Request to Send (RTS), and Clear to Send (CTS). Handshaking Control includes the following options:

- None – No HW flow control
- RTS — RTS is asserted during transmissions. CTS is ignored.
- RTS/CTS — RTS is asserted during transmissions. CTS gates transmissions.
- RTS On/CTS — RTS is always asserted. CTS gates transmissions.

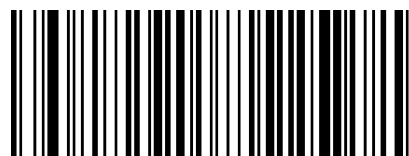
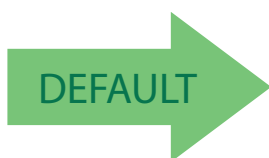

Handshaking Control = None



Handshaking Control = RTS



Handshaking Control = RTS/CTS

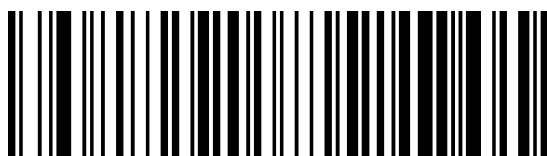

Handshaking Control = RTS On/CTS



## USB KEYBOARD ONLY INTERFACE

Use the programming bar codes in this chapter to select options for USB Keyboard only Interface.

<b>COUNTRY MODE</b> on page 22
<b>SETTING ALT INPUT TYPE</b> on page 44
<b>SETTING ALT OUTPUT TYPE</b> on page 44
<b>KEYBOARD NUMERIC KEYPAD</b> on page 45
<b>KEYBOARD SEND CONTROL CHARACTERS</b> on page 45



## Country Mode

This feature specifies the country/language supported by the keyboard. The Country Mode setting is ignored if the interface uses alternate key encoding.

### Setup on PC to use ALT Universal

1. Open Registry Edit

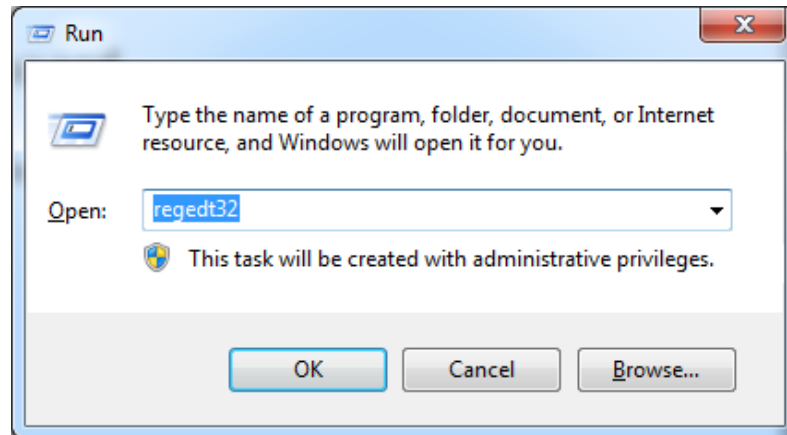

2. Set EnableHexNumpad to 1 as follows:

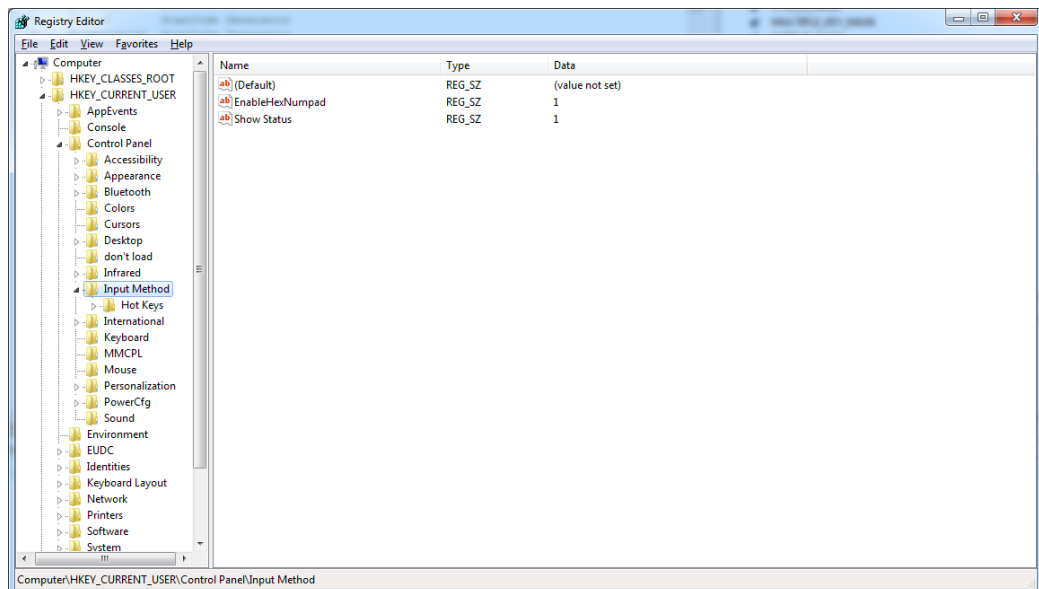

3. Reset the PC.



## Setting Country Mode

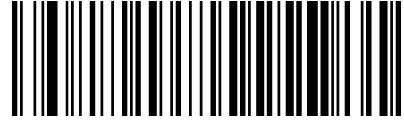
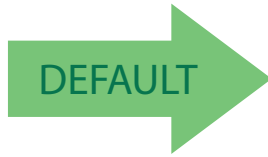

United States



French International (Belgian French)



United Kingdom



Danish

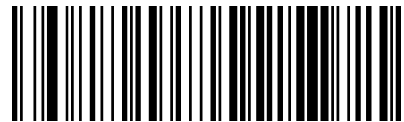

French (France)



German



Italian



Enter/Exit Programming Mode

---

## Setting Country Mode (continued)



Norwegian



Portuguese Portugal



Spanish



Swedish



Swiss French



Japanese ASCII



Hungarian



Enter/Exit Programming Mode

---

## Setting Country Mode (continued)

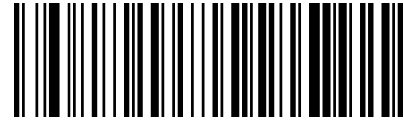

Czech



Slovak

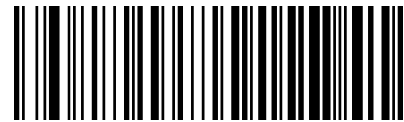

Romanian



Croatian



Polish\_214



Canadian French Win7



Lithuanian



Enter/Exit Programming Mode

---

## Setting Country Mode (continued)



Vietnamese



Russian



Arabic 101



Chinese ASCII



Thai-Kedmanee



Albanian



Arabic 102



## Setting Country Mode (continued)

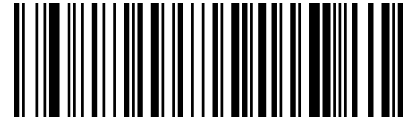

Arabic 102 AZERTY



Azeri Cyrillic

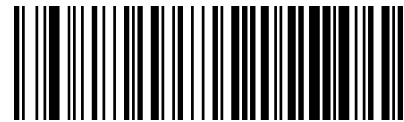

Azeri Latin

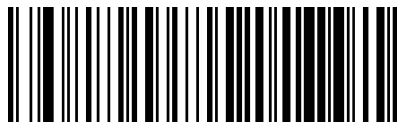

Belarusian



Bosnian Cyrillic



Bosnian Latin



Bulgarian Cyrillic



Enter/Exit Programming Mode

---

## Setting Country Mode (continued)



Bulgarian Latin



Canadian French (Legacy)



Canadian Multilingual



Chinese (Simplified)



Chinese (Traditional)



Czech Programmers



Czech QWERTY



## Setting Country Mode (continued)

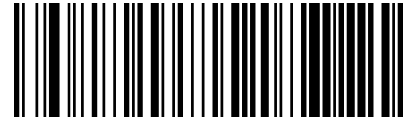

Dutch Netherland



Estonian

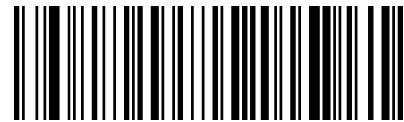

Faeroese

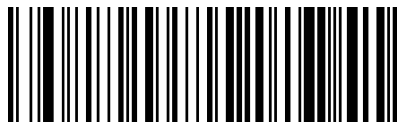

Finnish



French (Canada) 2000/XP



French (Canada) 95/98



Galician



Enter/Exit Programming Mode

---

## Setting Country Mode (continued)



Greek



Greek Latin



Greek Polytonic



Greek220



Greek220 Latin



Greek319



Greek319 Latin



## Setting Country Mode (continued)

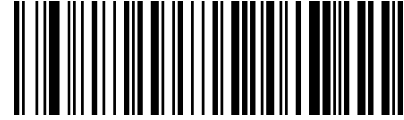

Hebrew Israel

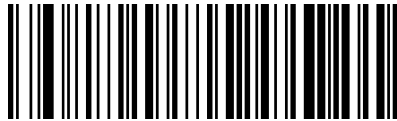

Hungarian\_101KEY

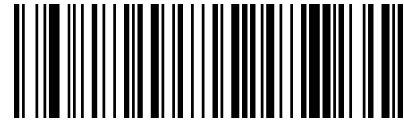

Icelandic



Irish

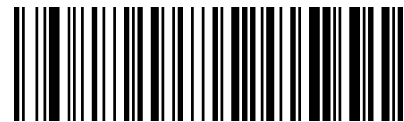

Italian\_142



Japanese (Shift-JIS)

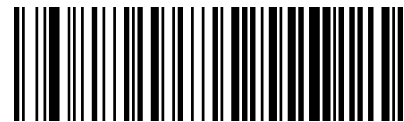

Kazakh



Enter/Exit Programming Mode

---

## Setting Country Mode (continued)



Korean (Hangul)



Korean ASCII



Kyrgyz Cyrillic



Latin America



Latvian



Latvian QWERTY



Lithuanian\_IBM



Enter/Exit Programming Mode

---

## Setting Country Mode (continued)

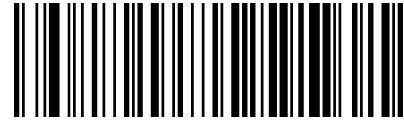

Macedonian -FYROM



Maltese\_47KEY

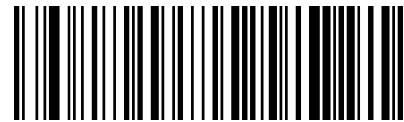

Mongolian-Cyrillic

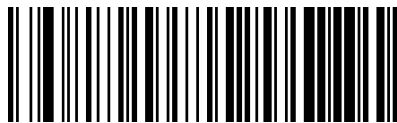

Polish Programmer



Portuguese Brazil



Portuguese Brazilian ABNT



Portuguese Brazilian ABNT2



Enter/Exit Programming Mode

---

## Setting Country Mode (continued)



Romanian Legacy



Romanian Programmer



Romanian Standard



Russian Typewriter



Serbian Cyrillic



Serbian Latin



Slovak QWERTY



Enter/Exit Programming Mode

---

## Setting Country Mode (continued)

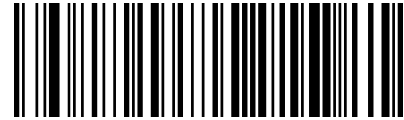

Slovenian



Spanish Variation

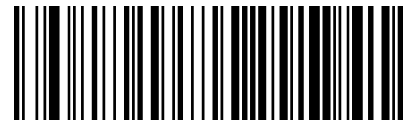

Swiss German

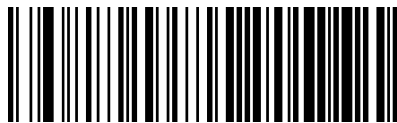

Tatar



Turkish F



Turkish Q



Ukrainian



## Setting Country Mode (continued)



US Dvorak



US Dvorak Left Hand



US Dvorak Right Hand



US English (Mac)



US English (North American)



US International



Uzbek Cyrillic



## Setting Encoding Type.

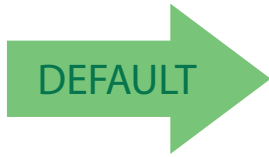

Don't use encoding



UTF\_8

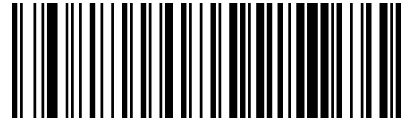

Windows 874



Windows 932



Windows 936



Windows 949



Windows 950



## Setting Encoding Type. (continued)



Windows 1250



Windows 1251



Windows 1252



Windows 1253



Windows 1254



Windows 1255



Windows 1256



## Setting Encoding Type (continued)



Windows 1257



Windows 1258

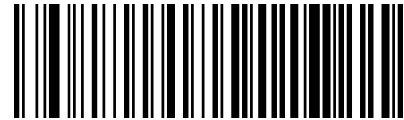

Windows 20866



ISO 8859-1



ISO 8859-2



ISO 8859-3



ISO 8859-4



## Setting Encoding Type. (continued)



ISO 8859-5



ISO 8859-6



ISO 8859-7



ISO 8859-8



ISO 8859-9



ISO 8859-10



ISO 8859-11



## Setting Encoding Type (continued)



ISO 8859-13



ISO 8859-14

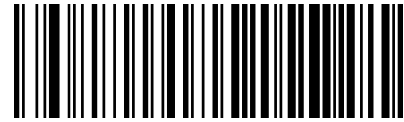

ISO 8859-15



ISO 8859-16

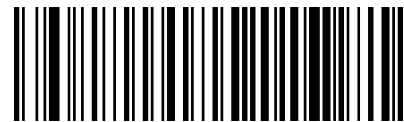

MS-DOS 437



MS-DOS 737



MS-DOS 775



## Setting Encoding Type. (continued)



MS-DOS 850



MS-DOS 852



MS-DOS 855



MS-DOS 857



MS-DOS 860



MS-DOS 861



MS-DOS 862



## Setting Encoding Type (continued)



MS-DOS 863



MS-DOS 865



MS-DOS 866



MS-DOS 869



Mac CP10000



### Setting ALT Input Type

This option specifies Usb Keyboard input type to Alt Mode. (Be aware that the scanner may switch automatically between ALT mode & Normal Keyboard Scancode, to correctly display some characters that are not present in the current Keyboard Country).



Disable ALT Mode



Enable ALT Mode

### Setting ALT Output Type

This option specifies the encode type of ALT Mode when the scanner sends Output Keyboard Data in Alt Mode. (Be aware that the scanner may switch automatically between ALT mode & Normal Keyboard Scancode, to correctly display some characters that are not present in the current Keyboard Country).



ALT Codepage: (use on non Unicode application: Notepad)

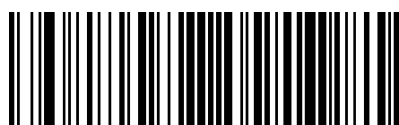

ALT Unicode: (use on Unicode application: Word)

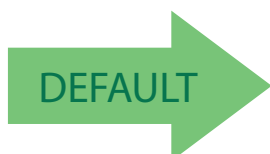

ALT Universal: (Use for all)



## Keyboard Numeric Keypad

This feature specifies if numeric characters will be sent using the standard keys or the numeric keypad.

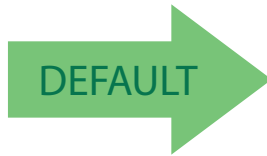

Keyboard Numeric Keypad = Standard Keys



Keyboard Numeric Keypad = Numeric Keypad

## Keyboard Send Control Characters

This feature is used by USB Keyboard only interface. It specifies how the scanner transmits ASCII control characters to the host.

Options are as follows:

**Send Ctrl+Key** . ASCII characters from 00H to 0x1FH inclusive are transmitted in the format Ctrl+Key. Special keys are available in the range from 81H to A1.

**Send Ctrl+Shift+Key** . The behavior is the same as above, but control keys are sent in the format Ctrl+Shift+Keys.

**Send Special Function Key** . Send characters between 00H and 1FH according to the special function key mapping table. This is used to send keys that are not in the normal ASCII set. A unique set is provided for each available scancode set.

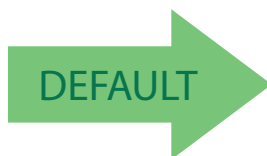

Keyboard Send Control Characters = Send Ctrl+Key



Keyboard Send Control Characters = Send Ctrl+Shift+Key



Keyboard Send Control Characters = Send Special Function Key

---

# NOTES



# USB-OEM ONLY INTERFACE

<b>INTRODUCTION</b> on page 47
<b>USB-OEM DEVICE USAGE</b> on page 48

## Introduction

Feature settings for USB interfaces differ depending upon which host type the scanner will be connected with. Use the feature settings in this chapter to specifically configure for the USB-OEM interface. Other USB interfaces are included in the appropriate chapter for their host type.



## USB-OEM Device Usage

The USB-OEM protocol allows for the scanner to be identified as one of two different types of bar code scanners. Depending on what other scanners you may already have connected to a USB-OEM POS, you may need to change this setting to enable all devices to communicate.

Options are:

- Tabletop Scanner
- Handheld Scanner



**NOTE**

It may be necessary to switch device usage when connecting two scanners of the same type to a POS system.

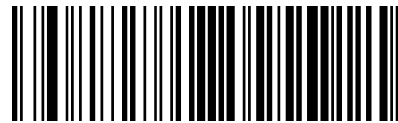
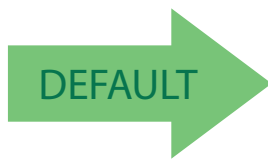

USB-OEM Device Usage = Tabletop Scanner



USB-OEM Device Usage = Handheld Scanner



## DATA FORMAT

<b>GLOBAL PREFIX/SUFFIX</b> on page 50
<b>GLOBAL AIM ID</b> on page 51
<b>GS1-128 AIM ID</b> on page 52

The features in this chapter can be used to build specific user-defined data into a message string.

See [Chapter 4, References](#) for more detailed instructions on setting these features.



### Global Prefix/Suffix

Up to 20 ASCII characters may be added as a prefix (in a position before the bar code data) and/or as a suffix (in a position following the bar code data).

Set the value "00" (two '0' characters) to have no Global Prefix/Suffix. The default is <CR> character suffix. See "Global Prefix/Suffix" on [Chapter 4, References](#) for more detailed programming instructions.

To configure this feature, scan the ENTER/EXIT bar code above, then the bar code at left followed by digits from the Alphanumeric characters in [Appendix C](#) representing your desired character(s). End by scanning the ENTER/EXIT bar code again and then exit programming mode by scanning it one more time.



Set Global Prefix

To configure this feature, scan the ENTER/EXIT bar code above, then the bar code at left followed by digits from the Alphanumeric characters in [Appendix C](#) representing your desired character(s). End by scanning the ENTER/EXIT bar code again and then exit programming mode by scanning it one more time.



Set Global Suffix

Did you make a mistake? Scan the CANCEL bar code to abort and not save the entry string. You can then start again at the beginning.

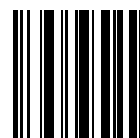

CANCEL

The default is <CR> character suffix. For setting <CR> character as global Suffix, enter Programming Mode, then read the following bar code and then exit Programming Mode

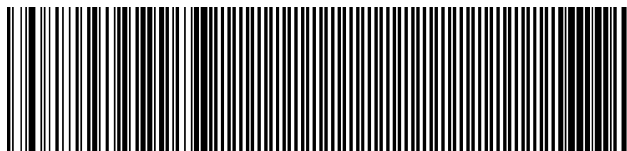
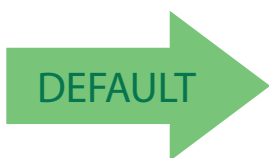

Global Suffix: OD (hex code for <CR>)



## Global AIM ID



This feature enables/disables addition of AIM IDs for all symbology types.

### NOTE

AIM label identifiers (as opposed to custom characters you select yourself as with label identifiers) can be included with scanned bar code data. See "Global AIM ID" on [Chapter 4, References](#) for more detailed programming instructions.

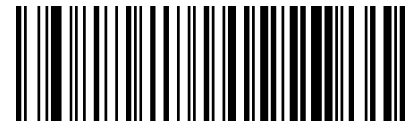

Global AIM ID = Disable



Global AIM ID = Enable



## GS1-128 AIM ID

If Global AIM ID is disabled, the AIM ID for GS1-128 can be enabled/disabled independently. The AIM ID for GS1-128 is a ]C1, ]C2 or ]C3.

AIM IDs for other symbologies can be enabled/disabled independently as well. Contact Customer Support for assistance.



GS1-128 AIM ID = Disable



GS1-128 AIM ID = Enable





## READING PARAMETERS

<b>DOUBLE READ TIMEOUT</b> on page 54
<b>LED AND SPEAKER INDICATORS</b> on page 56
<b>GOOD READ SPEAKER VOLUME</b> on page 56
<b>ENABLE/DISABLE GREEN SPOT (GOOD READ) LED INDICATOR</b> on page 57
<b>ENABLE/DISABLE TRIGGER LED INDICATOR</b> on page 57
<b>ENABLE/DISABLE POWER LED INDICATOR</b> on page 58
<b>SCANNING FEATURES</b> on page 59
<b>SCAN MODE</b> on page 59
<b>FLASH ON TIME</b> on page 60
<b>FLASH OFF TIME</b> on page 61
<b>STAND MODE SENSITIVITY</b> on page 62
<b>SCANNING ACTIVE TIME</b> on page 63
<b>PICK MODE</b> on page 64



## Double Read Timeout

To prevent a double read of the same label, the Double Read Timeout sets the minimum time allowed between reads of labels of the same symbology and data. If the unit reads a label and sees the same label again within the Double Read Timeout, the second read of the label will be ignored. Double Read Timeout does not apply to scan modes that require a trigger pull for each label that is read.



Double Read Timeout = 0.1 Second



Double Read Timeout = 0.2 Second



Double Read Timeout = 0.3 Second



Double Read Timeout = 0.4 Second



## Double Read Timeout (continued)



Double Read Timeout = 0.5 Second



Double Read Timeout = 0.6 Second



Double Read Timeout = 0.7 Second



Double Read Timeout = 0.8 Second



Double Read Timeout = 0.9 Second



Double Read Timeout = 1 Second





Enter/Exit Programming Mode

---

## LED AND SPEAKER INDICATORS

### Good Read Speaker Volume

Selects the speaker volume (loudness) upon a good read beep. There are three selectable volume levels.



Good Read Speaker Volume = Speaker Off



Good Read Speaker Volume = Low



Good Read Speaker Volume = Medium



Good Read Speaker Volume = High





## Enable/Disable Green Spot (Good Read) LED Indicator

Enable/Disable the green spot (good read) LED indicator.



Green Spot = Disable



Green Spot = Enable



## Enable/Disable Trigger LED indicator

Enable/Disable Trigger LED Indicator (blue LED)



Trigger LED = Disable



Trigger LED = Enable





Enter/Exit Programming Mode

---

## Enable/Disable Power LED Indicator

Enable/Disable Power LED Indicator (yellow LED)

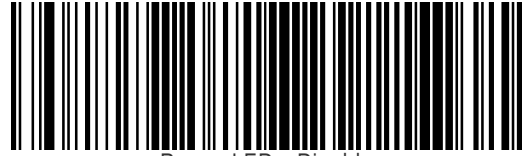

Power LED = Disable

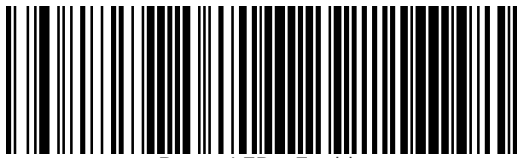

Power LED = Enable





## SCANNING FEATURES

### Scan Mode

See "Scan Mode" on [Chapter 4, References](#) for more details.



Scan Mode = Trigger Single



Scan Mode = Trigger Hold Multiple



Scan Mode = Trigger Pulse Multiple



Scan Mode = Flashing



Scan Mode = Always On



Scan Mode = Stand Mode



## Flash On Time

This feature specifies the ON time for the indicator LED while in Flash Mode. The selectable range is 100 to 9,900 milliseconds (0.1 to 9.9 seconds), in 100 millisecond increments. Always use two digits (e.g.: scan the barcode '0' and the barcode '2' for setting 0.2 seconds). For more detailed programming instructions, see "Flash On Time" on [Chapter 4, References](#).



Select Flash ON Time Setting

To configure this feature, scan the ENTER/EXIT bar code above, then the bar code at left followed by digits from the Alphanumeric characters in [Appendix C](#) representing your desired character(s). End by scanning the ENTER/EXIT bar code again.

Make a mistake? Scan the CANCEL bar code to abort and not save the entry string. You can then start again at the beginning.

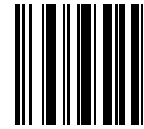

CANCEL

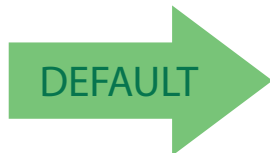

**10 = Flash is ON for 1 Second**



## Flash Off Time

This feature specifies the OFF time for the indicator LED while in Flash Mode. The selectable range is 100 to 9,900 milliseconds (0.1 to 9.9 seconds), in 100 millisecond increments. Always use two digits (e.g.: scan the barcode '0' and the barcode '2' for setting 0.2 seconds.) For more detailed programming instructions, see "Flash Off Time" on [Chapter 4, References](#).



Select Flash OFF Time Setting

To configure this feature, scan the ENTER/EXIT bar code above, then the bar code at left followed by digits from the Alphanumeric characters in [Appendix C](#) representing your desired character(s). End by scanning the ENTER/EXIT bar code again.

Make a mistake? Scan the CANCEL bar code to abort and not save the entry string. You can then start again at the beginning.

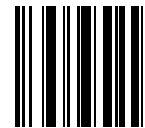

CANCEL

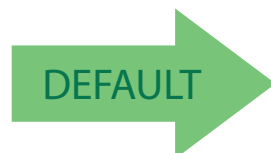

**05 = Flash is OFF for 500ms**



## Stand Mode Sensitivity

Sets the sensitivity level for stand mode wakeup. Choices are low, medium and high.



Stand Mode Sensitivity = Low



Stand Mode Sensitivity = Medium



Stand Mode Sensitivity = High



## Scanning Active Time

This setting specifies the amount of time that the reader stays in scan ON state once the state is entered. Here the labels for quick configuration on 3, 5 or 8 seconds. More options are available using DESP or Aladdin configuration protocols.



Scanning Active Time = 3 seconds



Scanning Active Time = 5 seconds



Scanning Active Time = 8 seconds



## Pick Mode

Specifies the ability of the reader to decode labels only when they are close to the center of the aiming pattern. This allows the reader to accurately target labels when they are placed close together, such as on a pick sheet.

The Pick Mode can be enabled only in Trigger Single Scan Mode.



NOTE

This feature is not compatible with Multiple Labels Reading in a Volume.

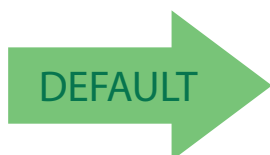

Pick Mode = Disable



Pick Mode = Enable



## Aiming Pointer

Enables/disables the aiming pointer for all symbologies.



Aiming Pointer = Disable



Aiming Pointer = Enable



## Green Spot Duration

Specifies the duration of the good read pointer beam after a good read.



Green Spot Duration = Disable (Green Spot is Off)



Green Spot Duration = Short (300 msec)



Green Spot Duration = Medium (500 msec)



Green Spot Duration = Long (800 msec)



Enter/Exit Programming Mode

---

## Enhanced Mobile Phone Mode

This mode is useful for improving reading performances when scanning bar codes displayed on a mobile phone.

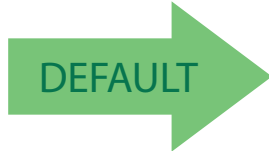

Enhanced Mobile Phone Mode = Disable

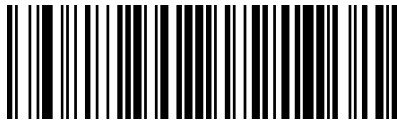

Enhanced Mobile Phone Mode = Enable



## Decode Negative Image

Enable/Disable the ability to decode a negative image for all symbologies. When this feature is enabled, you will be unable to read normally-printed labels or programming labels in this manual. Scan the "Disable" bar code below to return the scanner to its default for this feature. To set decoding for only 2D codes, go to "2D Normal/Inverse Symbol Control" on page 163. For additional options, see the Aladdin configuration application.



**NOTE**

Unlike some programming features and options, Decode Negative Image selections require that you scan only one programming bar code label. **DO NOT** scan an ENTER/EXIT bar code prior to scanning a Decode Negative Image bar code.



**CAUTION**

When this feature is enabled, you will be unable to read other programming labels in this manual.

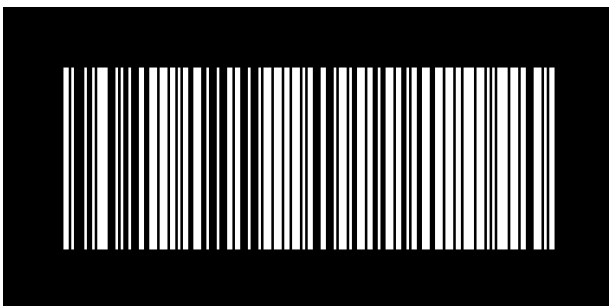

Decode Negative Image = Disable



Decode Negative Image = Enable



## DISABLE ALL SYMBOLOGIES

Use this feature to disable all symbologies.

1. Scan the ENTER/EXIT PROGRAMMING MODE barcode below.
2. Scan the Disable All Symbologies barcode.
3. Complete the programming sequence by scanning the ENTER/EXIT PROGRAMMING barcode.

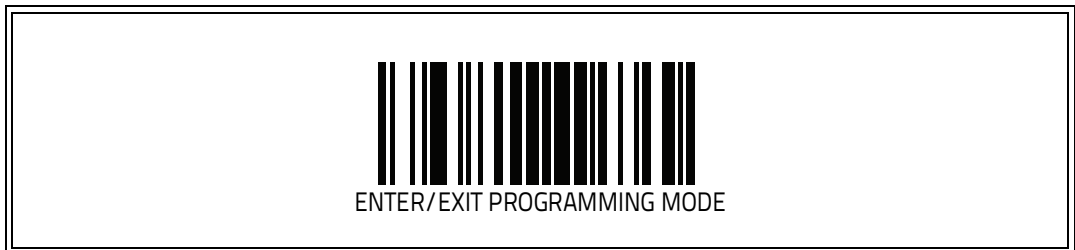

### NOTE

This does not disable the reading of programming labels.



# 1D SYMBOLOGIES

The decoder supports the following symbologies (barcode types). Symbology-dependent options for each symbology are included in this chapter.

<b>CODE EAN/UPC</b> on page 72
•Coupon Control on page 72
•UPC-A on page 72
•UPC-E on page 74
•EAN 13 (Jan 13) on page 78
•ISSN on page 79
•EAN 8 (Jan 8) on page 80
•UPC/EAN Global Settings on page 81
<b>CODE 39</b> on page 86
•Code 32 (ITAL Pharmaceutical Code) on page 95
•Code 39 CIP (French Pharmaceutical) on page 97
<b>CODE 128</b> on page 98
•GS1-128 on page 103
<b>CODE ISBT 128</b> on page 104
<b>INTERLEAVED 2 OF 5 (I 2 OF 5)</b> on page 106
•Follett 2 of 5 on page 111
•Interleaved 2 of 5 CIP HR on page 111
<b>STANDARD 2 OF 5</b> on page 112
<b>INDUSTRIAL 2 OF 5</b> on page 116
•Code IATA on page 121



<b>DATALOGIC 2 OF 5</b> on page 122
<b>CODABAR</b> on page 126
•ABC Codabar on page 133
<b>CODE 11</b> on page 136
<b>GS1 DATA BAR™ OMNIDIRECTIONAL</b> on page 140
•GS1 DataBar™ Omnidirectional on page 140
•GS1 DataBar™ Expanded on page 141
•GS1 DataBar™ Limited on page 145
<b>CODE 93</b> on page 146
<b>MSI</b> on page 151
<b>PLESSEY</b> on page 155



Default settings are indicated at each feature/option with a green arrow. That section also provides space to record any custom settings needed or implemented for your system.

To set most features:

1. Scan the ENTER/EXIT PROGRAMMING barcode at the top of applicable programming pages.
2. Scan the correct barcode to set the desired programming feature or parameter. You may need to cover unused barcodes on the page, and possibly the facing page, to ensure that the reader reads only the barcode you intend to scan.
3. If additional input parameters are needed, go to [Appendix C](#), and scan the appropriate characters from the keypad.



**NOTE**

Additional information about many features can be found in the "References" chapter. If you make a mistake before the last character, scan the CANCEL barcode to abort and not save the entry string. You can then start again at the beginning.

4. Complete the programming sequence by scanning the ENTER/EXIT PROGRAMMING barcode to exit Programming Mode.



## CODE EAN/UPC

### Coupon Control

This feature is used to control the reader's method of processing coupon labels.

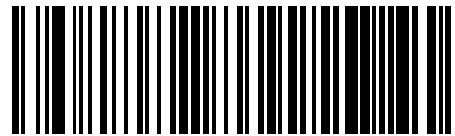

Coupon Control = Allow all coupon barcodes to be decoded

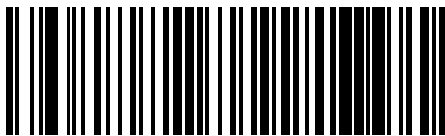

Coupon Control = Enable only UPCA coupon decoding



Coupon Control = Enable only GS1 DataBar™ coupon decoding

### UPC-A

The following options apply to the UPC-A symbology.

#### UPC-A Enable/Disable

When disabled, the reader will not read UPC-A barcodes.

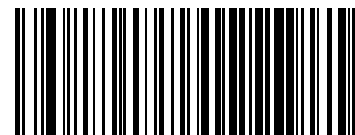

UPC-A = Disable



UPC-A = Enable





## UPC-A Check Character Transmission

Enable this option to transmit the check character along with UPC-A barcode data.

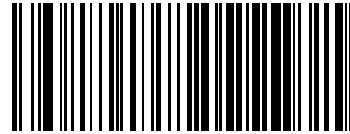

UPC-A Check Character Transmission = Don't Send

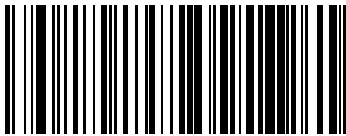

UPC-A Check Character Transmission = Send



## Expand UPC-A to EAN-13

Expands UPC-A data to the EAN-13 data format. Selecting this feature also changes the symbology ID to match those required for EAN-13.

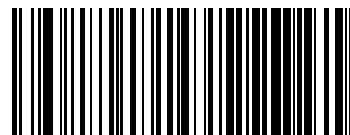

UPC-A to EAN-13 = Don't Expand

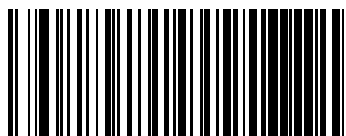

UPC-A to EAN-13 = Expand



## UPC-A Number System Character Transmission

This feature enables/disables transmission of the UPC-A number system character.

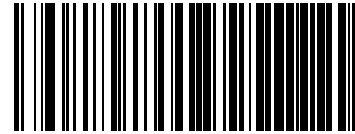

UPC-A Number System Character = Do not transmit

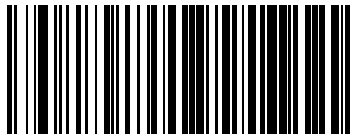

UPC-A Number System Character = Transmit



## UPC-E

The following options apply to the UPC-E symbology.

### UPC-E Enable/Disable

When disabled, the reader will not read UPC-E barcodes.

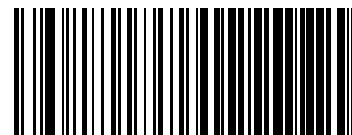

UPC-E = Disable

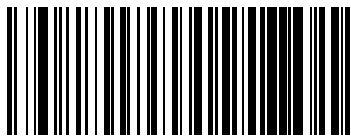

UPC-E = Enable





## UPC-E Check Character Transmission

Enable this option to transmit the check character along with UPC-E barcode data.

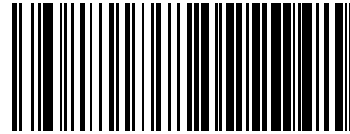

UPC-E Check Character Transmission = Don't Send

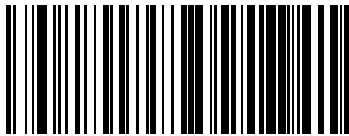

UPC-E Check Character Transmission = Send



## Expand UPC-E to EAN-13

Expands UPC-E data to the EAN-13 data format. Selecting this feature also changes the symbology ID to match those required for EAN-13.

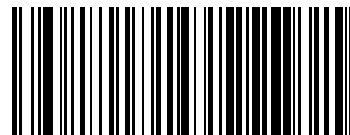
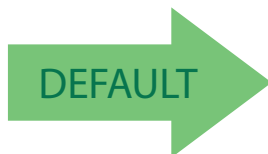

UPC-E to EAN-13 = Don't Expand

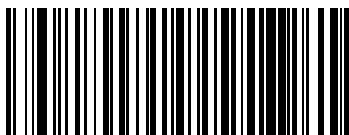

UPC-E to EAN-13 = Expand



## Expand UPC-E to UPC-A

Expands UPC-E data to the UPC-A data format.

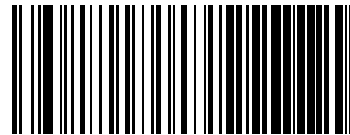
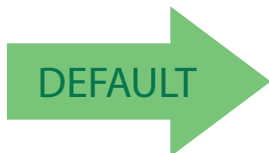

UPC-E to UPC-A = Don't Expand

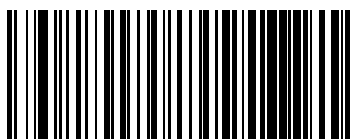

UPC-E to UPC-A = Expand

## UPC-E Number System Character Transmission

This feature enables/disables transmission of the UPC-E system number character.



UPC-E Number System Character = Do not transmit

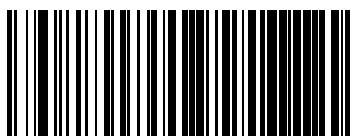

UPC-E Number System Character = Transmit



## GTIN FORMATTING

This feature enables/disables the ability to convert UPC-E, UPC-A, EAN 8, and EAN 13 labels into the GTIN 14-character format.



### NOTE

If add-on information is present on the base label prior to the conversion taking place, the add-on information will be appended to the converted GTIN label.

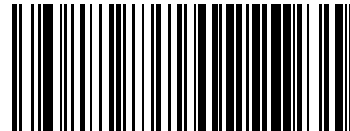
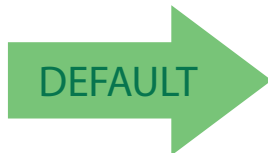

GTIN Formatting = Disable

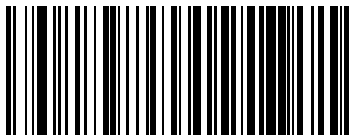

GTIN Formatting = Enable



## EAN 13 (JAN 13)

The following options apply to the EAN 13 (Jan 13) symbology.

### EAN 13 Enable/Disable

When disabled, the reader will not read EAN 13/JAN 13 barcodes.

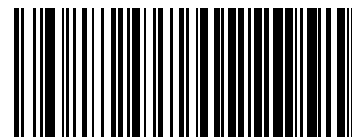

EAN 13 = Disable



EAN 13 = Enable



### EAN 13 Check Character Transmission

Enable this option to transmit the check character along with EAN 13 barcode data.

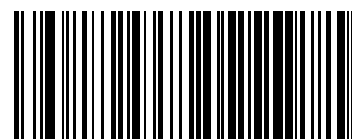

EAN 13 Check Character Transmission = Don't Send



EAN 13 Check Character Transmission = Send





## EAN-13 ISBN Conversion

This option enables/disables conversion of EAN 13/JAN 13 Bookland labels starting with 978 to ISBN labels.

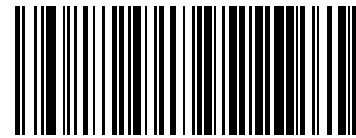
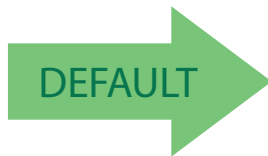

EAN-13 ISBN Conversion = Disable

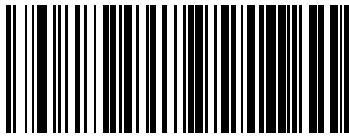

EAN-13 ISBN Conversion = Convert to ISBN

## ISSN

The following options apply to the ISSN symbology.

### ISSN Enable/Disable

Enables/disables conversion of EAN/JAN13 Bookland labels starting with 977 to ISSN labels.

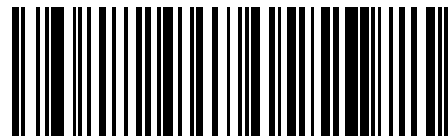
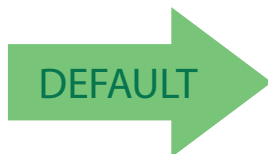

ISSN = Disable



ISSN = Enable



## EAN 8 (JAN 8)

The following options apply to the EAN 8 (Jan 8) symbology.

### EAN 8 Enable/Disable

When disabled, the reader will not read EAN 8/JAN 8 barcodes.



### EAN 8 Check Character Transmission

Enable this option to transmit the check character along with EAN 8 barcode data.

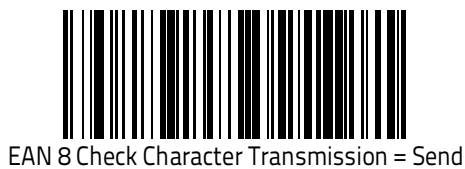

### Expand EAN 8 to EAN 13

Enable this option to expand EAN 8/JAN 8 labels to EAN 13/JAN 13.

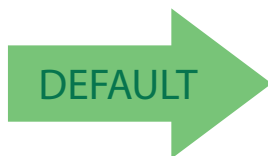



## UPC/EAN GLOBAL SETTINGS

This section provides configuration settings for UPC-A, UPC-E, EAN 13 and EAN 8 symbologies, and affects all of these unless otherwise marked for each feature description.

### UPC/EAN Price Weight Check

This feature enables/disables calculation and verification of price/weight check digits.

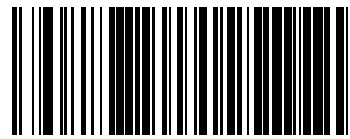
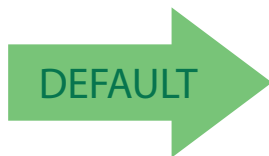

Price Weight Check = Disabled

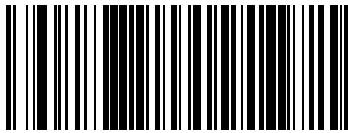

Price Weight Check = 4-digit price-weight check

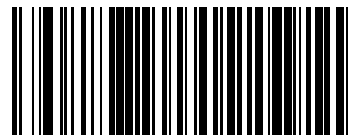

Price Weight Check = 5-digit price-weight check

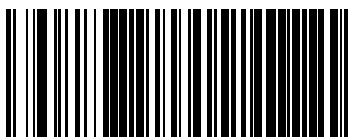

Price Weight Check = European 4-digit price-weight check

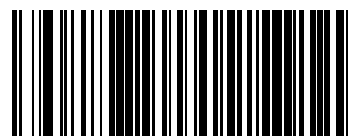

Price Weight Check = European 5-digit price-weight check



## ADD-ONS

Contact Customer Support for advanced programming of optional and conditional add-ons.

### Optional Add-ons

The reader can be enabled to optionally read the following add-ons (supplementals):



**NOTE**

If a UPC/EAN base label and an add-on are both decoded, the reader will transmit the base label and add-on. If a UPC/EAN base label is decoded without an add-on, the base label will be transmitted without an add-on.

Conditional add-on settings (if enabled) are considered by the reader before optional add-on settings.

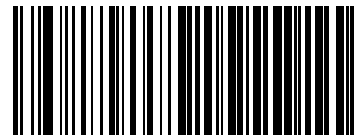
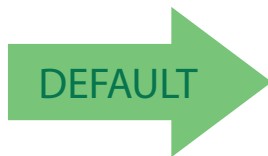

Optional Add-Ons = Disable P2

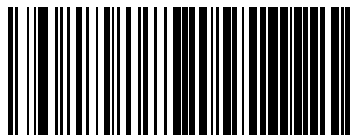

Optional Add-Ons = Enable P2

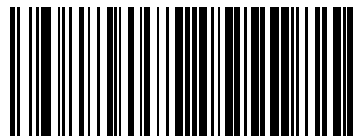
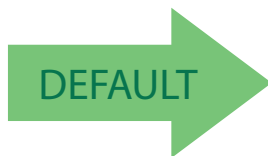

Optional Add-Ons = Disable P5

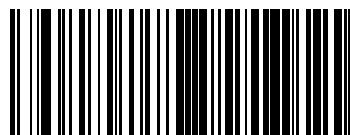

Optional Add-Ons = Enable P5



## Optional Add-On Timer

This option sets the time the reader will look for an add-on when an add-on fragment has been seen and optional add-ons are enabled.)

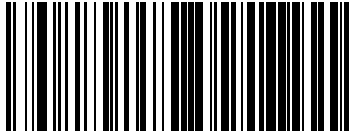

Optional Add-on Timer = 10ms

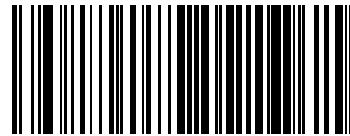

Optional Add-on Timer = 20ms

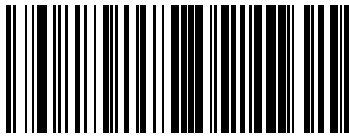

Optional Add-on Timer = 30ms

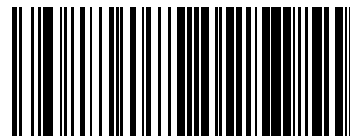

Optional Add-on Timer = 40ms

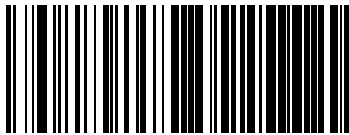

Optional Add-on Timer = 50ms



Enter/Exit Programming Mode

---

## Optional Add-On Timer (continued)

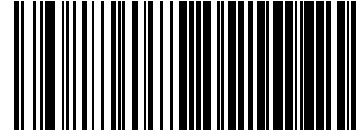

Optional Add-on Timer = 60ms

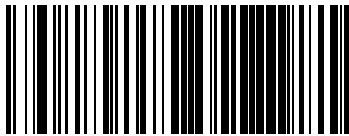

Optional Add-on Timer = 70ms

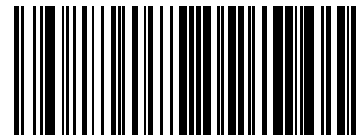

Optional Add-on Timer = 100ms

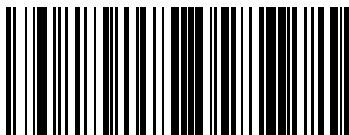

Optional Add-on Timer = 120ms

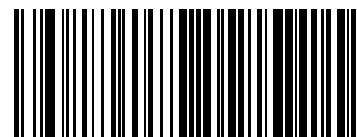

Optional Add-on Timer = 140ms

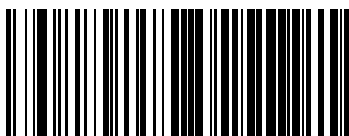

Optional Add-on Timer = 160ms



## Optional Add-On Timer (continued)

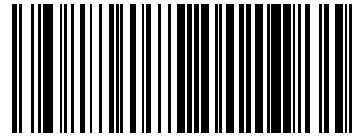

Optional Add-on Timer = 180ms

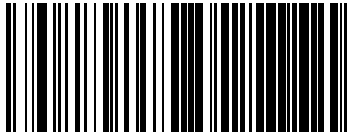

Optional Add-on Timer = 200ms

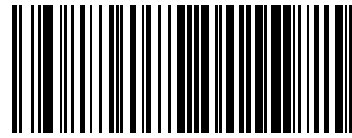

Optional Add-on Timer = 220ms

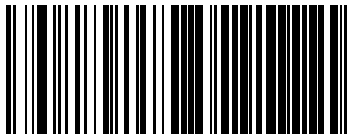

Optional Add-on Timer = 240ms

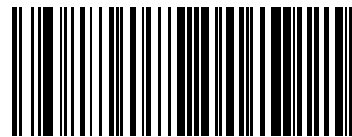

Optional Add-on Timer = 260ms

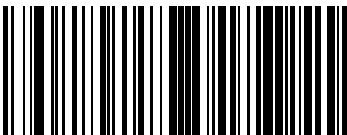

Optional Add-on Timer = 280ms

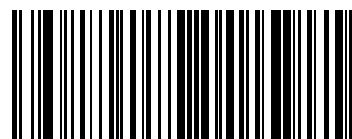

Optional Add-on Timer = 300ms



## CODE 39

The following options apply to the Code 39 symbology.

### Code 39 Enable/Disable

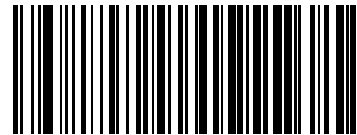

Code 39 = Disable

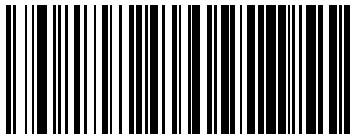

Code 39 = Enable



### Code 39 Check Character Calculation

Enable this option to enables/disables calculation and verification of an optional Code 39 check character. When disabled, any check character in the label is treated as a data character

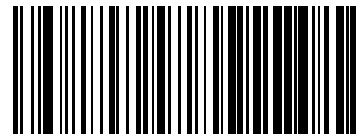
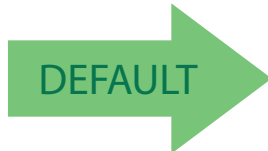

Code 39 Check Character Calculation = Don't Calculate

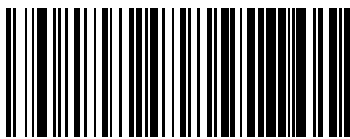

Code 39 Check Character Calculation = Calculate Std Check

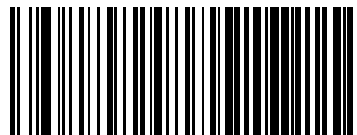

Code 39 Check Character Calculation = Calculate Mod 7 Check



Enter/Exit Programming Mode

---

## Code 39 Check Character Calculation (continued)

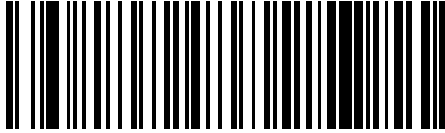

Code 39 Check Character Calculation = Enable Italian Post  
Check

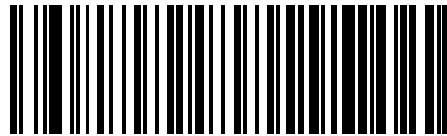

Code 39 Check Character Calculation = Enable Daimler  
Chrysler Check

## Code 39 Check Character Transmission

Enable this option to transmit the check character along with Code 39 barcode data.

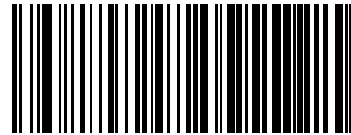

Code 39 Check Character Transmission = Don't Send

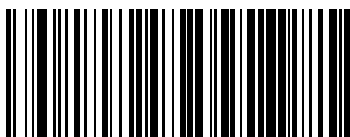

Code 39 Check Character Transmission = Send





## Code 39 Start/Stop Character Transmission

Enable this option to enable/disable transmission of Code 39 start and stop characters.

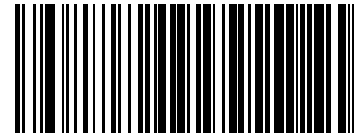
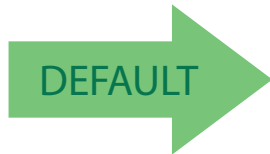

Code 39 Start/Stop Character Transmission = Don't Transmit

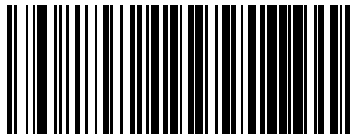

Code 39 Start/Stop Character Transmission = Transmit

## Code 39 Full ASCII

Enables/disables the translation of Code 39 characters to Code 39 full-ASCII characters.

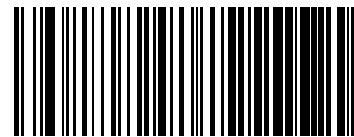

Code 39 Full ASCII = Disable

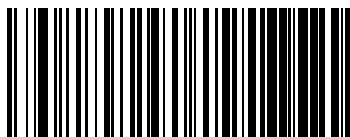

Code 39 Full ASCII = Enable



## Code 39 Quiet zones

This feature specifies the number of quiet zones for Code 39 labels. Quiet zones are blank areas at the ends of a bar code, typically 10 times the width of the narrowest bar or space in the label.

Read the Enter/Exit Programming Mode bar code at the top of this page and then one of the following bar codes.

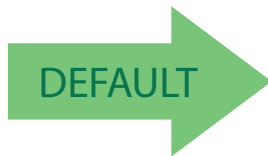

Quiet zones = Auto

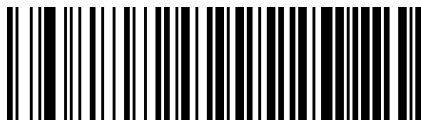

Quiet Zones = Small Quiet Zones on two side



## Code 39 Length Control

This feature specifies either variable length decoding, fixed length decoding or no check length decoding for the Code 39 symbology.

**Variable Length:** For variable length decoding, a minimum and maximum length may be set.

**Fixed Length:** For fixed length decoding, two different lengths may be set.

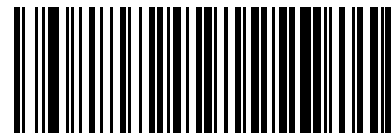

Code 39 Length Control = Variable Length

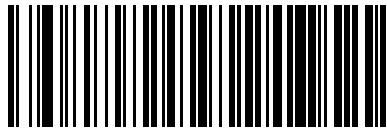

Code 39 Length Control = Fixed Length



Code 39 Length Control = No check



## Code 39 Set Length 1

This feature specifies one of the barcode lengths for Code 39. Length 1 is the minimum label length if in [Variable Length on page 90 Mode](#), or the first fixed length if in [Fixed Length on page 90 Mode](#). Length includes the barcode's data characters only. The length can be set from 0 to 50 characters. For more detailed programming instructions, see "Set Length" on [Chapter 4, References](#).

Table 1 provides examples for setting Length 1.

**Table 1. Code 39 Length 1 Setting Examples**

STEP	ACTION	EXAMPLES			
1	Desired Setting	00 Characters	07 Characters	15 Characters	50 Characters
2	Scan ENTER/EXIT PROGRAMMING MODE				
3	Scan SELECT CODE 39 LENGTH 1 SETTING				
4	Scan Two Characters From Appendix C	'0' and '0'	'0' and '7'	'1' and '5'	'5' AND '0'
5	Scan ENTER/EXIT PROGRAMMING MODE				

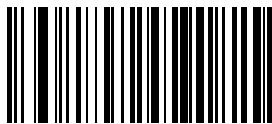

Select Code 39 Set Length 1 Setting

Make a mistake? Scan the CANCEL barcode to abort and not save the entry string. You can then start again at the beginning.

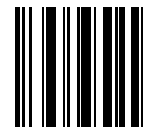

CANCEL

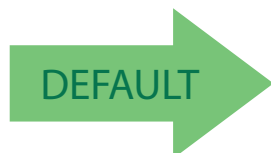

01 = Length 1 is 1 Characters



## Code 39 Set Length 2

This feature specifies one of the barcode lengths for Code 39. Length 2 is the maximum label length if in [Variable Length on page 90 Mode](#), or the second fixed length if in [Fixed Length on page 90 Mode](#). Length includes the barcode's check, data, and full-ASCII shift characters. The length does not include start/stop characters. For more detailed programming instructions, see "Set Length" on [Chapter 4, References](#).

Table 2 provides examples for setting Length 2.

**Table 2. Code 39 Length 2 Setting Examples**

STEP	ACTION	EXAMPLES			
1	<b>Desired Setting</b>	00 (Ignore This Length)	07 Characters	15 Characters	50 Characters
2	<b>Scan ENTER/EXIT PROGRAMMING MODE</b>				
3	<b>Scan SELECT CODE 39 LENGTH 2 SETTING</b>				
4	<b>Scan Two Characters From Appendix C</b>	'0' and '0'	'0' and '7'	'1' and '5'	'5' AND '0'
5	<b>Scan ENTER/EXIT PROGRAMMING MODE</b>				

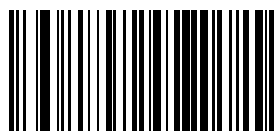

Select Code 39Length 2 Setting

Make a mistake? Scan the CANCEL barcode to abort and not save the entry string. You can then start again at the beginning.

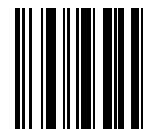

CANCEL



**50 = Length 2 is 50 Characters**



## Code 39 Interdigit Ratio

This feature specifies the ratio between an intercharacter space and module for Code 39 labels.

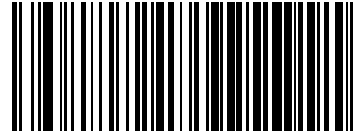

Code 39 Interdigit Ratio = Disable

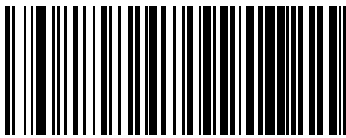

Code 39 Interdigit Ratio = 1

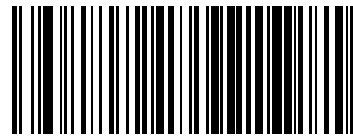

Code 39 Interdigit Ratio = 2

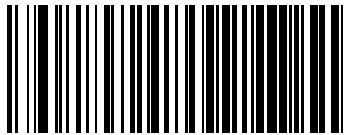

Code 39 Interdigit Ratio = 3

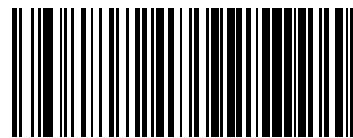
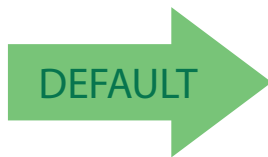

Code 39 Interdigit Ratio = 4

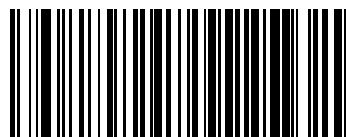

Code 39 Interdigit Ratio = 5



Enter/Exit Programming Mode

---

## Code 39 Interdigit Ratio (continued)

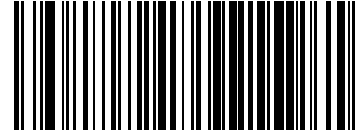

Code 39 Interdigit Ratio = 6

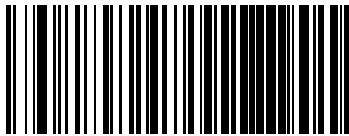

Code 39 Interdigit Ratio = 7

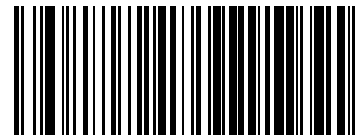

Code 39 Interdigit Ratio = 8

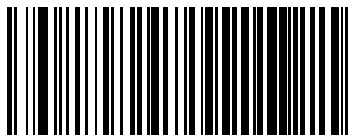

Code 39 Interdigit Ratio = 9

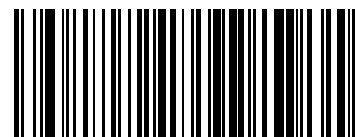

Code 39 Interdigit Ratio = 10



## CODE 32 (ITAL PHARMACEUTICAL CODE)

The following options apply to the Code 32 (Italian Pharmaceutical Code) symbology.

### Code 32 Enable/Disable

When disabled, the reader will not read Code 32 barcodes.

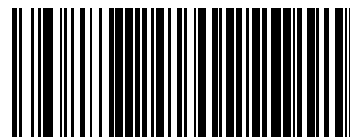
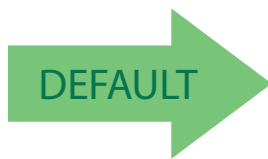

Code 32 = Disable

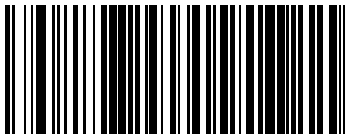

Code 32 = Enable

### Code 32 Feature Setting Exceptions



#### NOTE

The following features are set for Code 32 by using these Code 39 settings:

"Code 39 Length Control" on page 90

"Code 39 Interdigit Ratio" on page 93



## Code 32 Check Char Transmission

Enable this option to transmit the check character along with Code 32 barcode data.

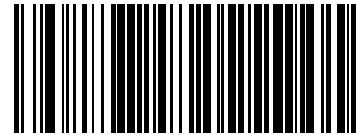
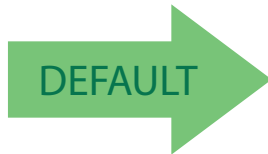

Code 32 Check Character Transmission = Don't Send

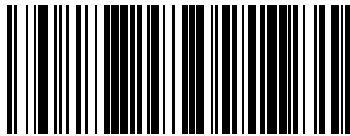

Code 32 Check Character Transmission = Send

## Code 32 Start/Stop Character Transmission

This option enables/disables transmission of Code 32 start and stop characters.

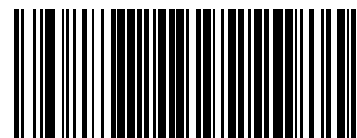
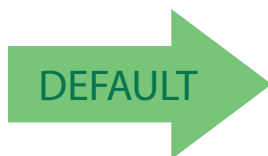

Code 32 Start/Stop Character Transmission = Don't Transmit

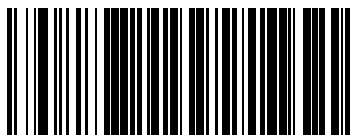

Code 32 Start/Stop Character Transmission = Transmit



## CODE 39 CIP (FRENCH PHARMACEUTICAL)

The following options apply to the Code 39 CIP symbology.

### Code 39 CIP Enable/Disable

Enables/Disables ability of the reader to decode Code 39 CIP labels.

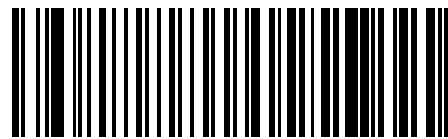
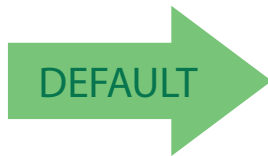

Code 39 CIP = Disable

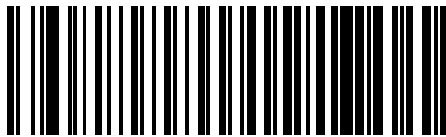

Code 39 CIP = Enable



## CODE 128

The following options apply to the Code 128 symbology.

### Code 128 Enable/Disable

When disabled, the reader will not read Code 128 barcodes.



Code 128 = Disable

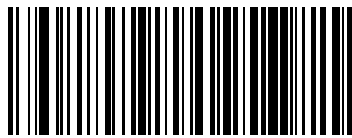

Code 128 = Enable



### Code 128 Check Character Transmission

Enable this option to transmit the check character along with Code 128 barcode data.

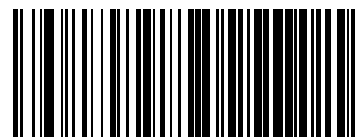
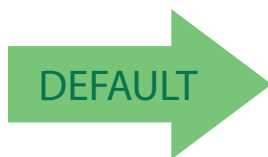

Code 128 Check Character Transmission = Don't Send

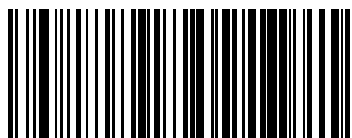

Code 128 Check Character Transmission = Send



## Code 128 Function Character Transmission

Enables/disables transmission of Code128 function characters 1, 2, 3, and 4.

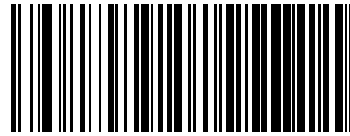
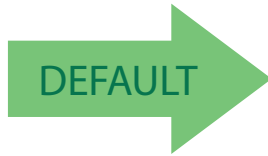

Code 128 Function Character Transmission = Don't Send

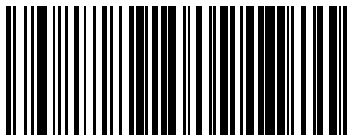

Code 128 Function Character Transmission = Send

## Code 128 Quiet Zones

This feature specifies the number of quiet zones for Code 128 labels. Quiet zones are blank areas at the ends of a barcode and are typically 10 times the width of the narrowest bar or space in the label.

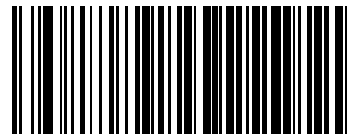

Code 128 Quiet Zones = No Quiet Zones

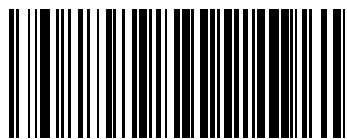

Code 128 Quiet Zones = Auto





## Code 128 Length Control

This feature specifies either variable length decoding, fixed length decoding or no check length decoding for the Code 128 symbology.

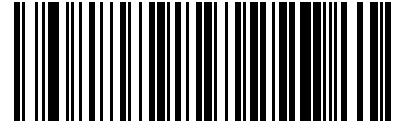

Code 128 Length Control = Variable Length

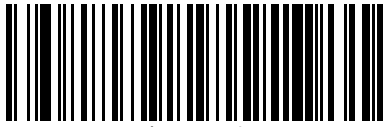

Code 128 Length Control = Fixed Length

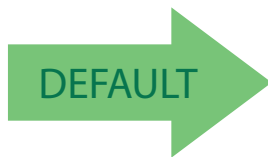

Code 128 Length Control = No Check



## Code 128 Set Length 1

Specifies one of the barcode lengths for Code 128. Length 1 is the minimum label length if in [Variable Length on page 90 Mode](#), or the first fixed length if in [Fixed Length on page 90 Mode](#). Length includes the barcode's data characters only. The length can be set from 1 to 80 characters. For more detailed programming instructions, see "Set Length" on [Chapter 4, References](#).

Table 3 provides some examples for setting Length 1.

**Table 3. Code 128 Length 1 Setting Examples**

STEP	ACTION	EXAMPLES			
1	<b>Desired Setting</b>	01 Character	07 Characters	15 Characters	80 Characters
2	<b>Scan ENTER/EXIT PROGRAMMING MODE</b>				
3	<b>Scan SELECT CODE 128 LENGTH 1 SETTING</b>				
4	<b>Scan Two Characters From Appendix C</b>	'0' and '1'	'0' and '7'	'1' and '5'	'8' and '0'
5	<b>Scan ENTER/EXIT PROGRAMMING MODE</b>				

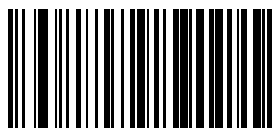

Select Code 128 Set Length 1 Setting

Make a mistake? Scan the CANCEL barcode to abort and not save the entry string. You can then start again at the beginning.

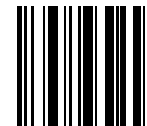

CANCEL

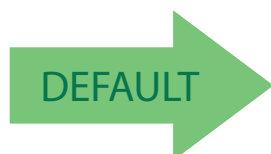

**01 = Length 1 is 1 Character**



## Code 128 Set Length 2

This feature specifies one of the barcode lengths for Code 128. Length 2 is the maximum label length if in [Variable Length on page 90 Mode](#), or the second fixed length if in [Fixed Length on page 90 Mode](#). Length includes the barcode's data characters only.

The length can be set from 1 to 80 characters. A setting of 0 specifies to ignore this length (only one fixed length). For more detailed programming instructions, see "Set Length" on [Chapter 4, References](#).

Table 4 provides examples for setting Length 2.

**Table 4. Code 128 Length 2 Setting Examples**

STEP	ACTION	EXAMPLES			
1	<b>Desired Setting</b>	00 (Ignore This Length)	07 Characters	15 Characters	80 Characters
2	<b>Scan ENTER/EXIT PROGRAMMING MODE</b>				
3	<b>Scan SELECT CODE 128 LENGTH 2 SETTING</b>				
4	<b>Scan Two Characters From Appendix C</b>	'0' and '0'	'0' and '7'	`1' and `5'	`8' and `0'
5	<b>Scan ENTER/EXIT PROGRAMMING MODE</b>				

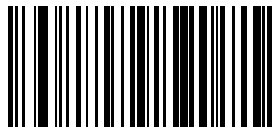

Select Code 128 Length 2 Setting

Make a mistake? Scan the CANCEL barcode to abort and not save the entry string. You can then start again at the beginning.

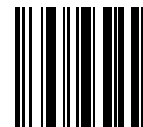

CANCEL



**80 = Length 2 is 80 Characters**



## GS1-128

The following options apply to the GS1-128 symbology. (Also known as USS-128, GS1-128, GTIN-128, UCC-128, EAN-128.)

### GS1-128 Enable

This option enables/disables the ability of the reader to translate GS1-128 labels to the GS1-128 data format. Options are:

- Transmit GS1-128 labels in Code 128 data format.
- Transmit GS1-128 labels in GS1-128 data format.
- Do not transmit GS1-128 labels.

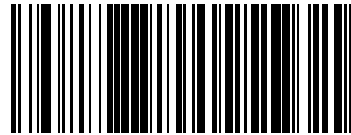

GS1-128 = Transmit in Code 128 data format

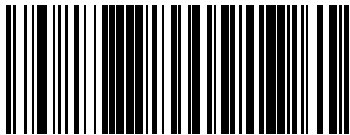

GS1-128 = Transmit in GS1-128 data format

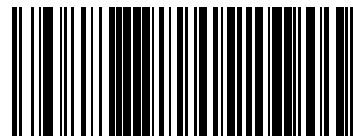

GS1-128 = Do not transmit GS1-128 labels



## CODE ISBT 128

The following options apply to the ISBT 128 symbology.

### ISBT 128 Concatenation

Use this option to enable/disable ISBT128 concatenation of 2 labels.

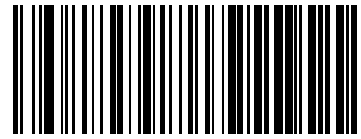
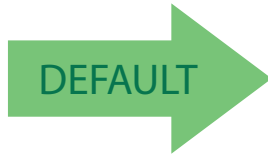

ISBN 128 Concatenation = Disable

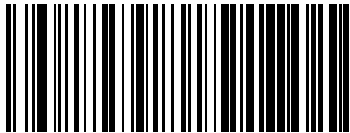

ISBN 128 Concatenation = Enable

### ISBT 128 Concatenation Mode

Specifies the concatenation mode between Static and Dynamic.



**NOTE**

This option is only valid when ISBT 128 Concatenation on page 104 is enabled (see page 8-104).

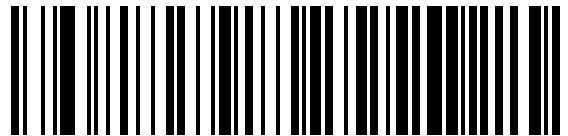

ISBN 128 Concatenation Mode = Static

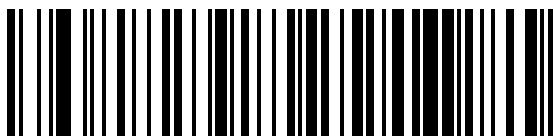

ISBN 128 Concatenation Mode = Dynamic



## ISBT 128 Dynamic Concatenation Timeout

Specifies the timeout used by the ISBT 128 Dynamic Concatenation Mode.

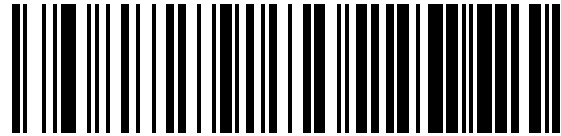

ISBT 128 Dynamic Concatenation Timeout = 50 msec

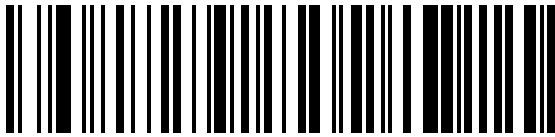

ISBT 128 Dynamic Concatenation Timeout = 100 msec

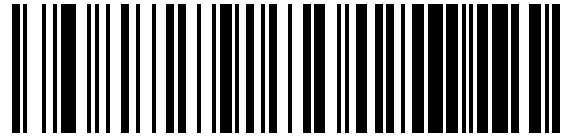
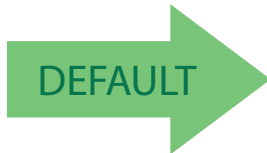

ISBT 128 Dynamic Concatenation Timeout = 200 msec

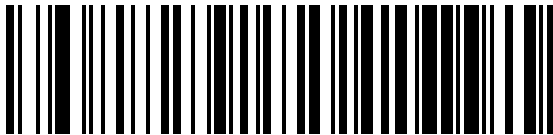

ISBT 128 Dynamic Concatenation Timeout = 500 msec

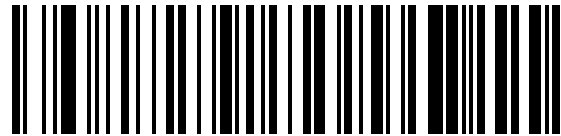

ISBT 128 Dynamic Concatenation Timeout = 750 msec

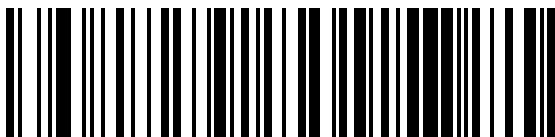

ISBT 128 Dynamic Concatenation Timeout = 1 second

## ISBT 128 Advanced Concatenation Options



To set up pairs of label types for concatenation, use the Datalogic Aladdin configuration application or contact Datalogic Technical Support.

### NOTE



## INTERLEAVED 2 OF 5 (I 2 OF 5)

The following options apply to the I 2 of 5 symbology.

### I 2 of 5 Enable/Disable

When disabled, the reader will not read I 2 of 5 barcodes.

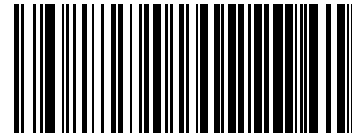
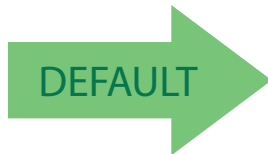

I 2 of 5 = Disable

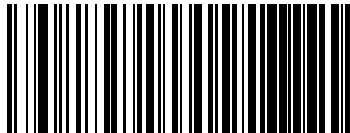

I 2 of 5 = Enable

### I 2 of 5 Check Character Calculation

This option enables/disables calculation and verification of an optional I 2 of 5 check character.

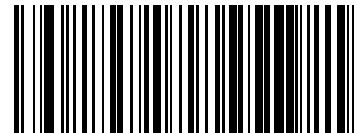

I 2 of 5 Check Character Calculation = Disable

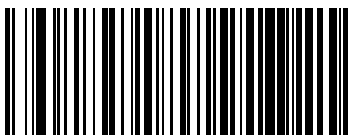

I 2 of 5 Check Character Calculation = Check Standard  
(Modulo 10)

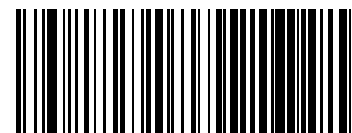

I 2 of 5 Check Character Calculation = Check German Parcel



## I 2 of 5 Check Character Calculation (continued)

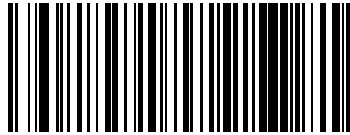

I 2 of 5 Check Character Calculation = Check DHL

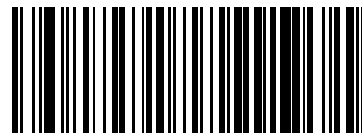

I 2 of 5 Check Character Calculation = Check Daimler Chrysler

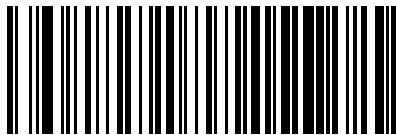

I 2 of 5 Check Character Calculation = Check Bosch

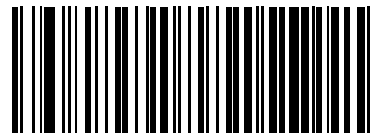

I 2 of 5 Check Character Calculation = Italian Post

## I 2 of 5 Check Character Transmission

Enable this option to transmit the check character along with I 2 of 5 barcode data.

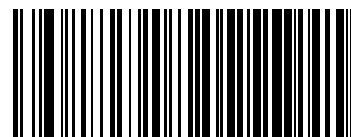

I 2 of 5 Check Character Transmission = Don't Send

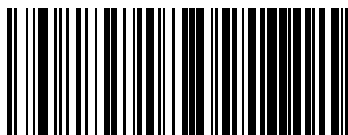

I 2 of 5 Check Character Transmission = Send





## I 2 of 5 Length Control

This feature specifies either variable length decoding, fixed length decoding or no check length decoding for the I 2 of 5 symbology.

**Variable Length:** For variable length decoding, a minimum and maximum length may be set.

**Fixed Length:** For fixed length decoding, two different lengths may be set.

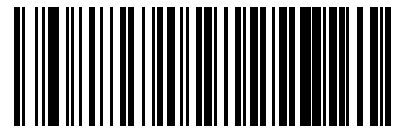

I 2 of 5 Length Control = Variable Length

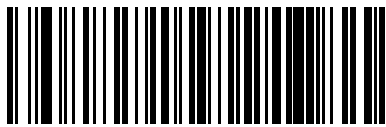

I 2 of 5 Length Control = Fixed Length

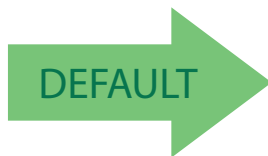

I 2 of 5 Length Control = No Check



## I 2 of 5 Set Length 1

This feature specifies one of the barcode lengths for I 2 of 5 Length Control on page 108. Length 1 is the minimum label length if in Variable Length on page 123 Mode, or the first fixed length if in Fixed Length on page 90 Mode. The length includes the barcode’s check and data characters. The length can be set from 2 to 50 characters in increments of two. For more detailed programming instructions see, Set Length on Chapter 4, References.

Table 5 provides some examples for setting Length 1.

Table 5. I 2 of 5 Length 1 Setting Examples

STEP	ACTION	EXAMPLES			
1	Desired Setting	2 Characters	6 Characters	14 Characters	50 Characters
2	Pad with leading zeroes to yield two digits	02	06	14	50
3	Scan ENTER/EXIT PROGRAMMING MODE				
4	Scan SELECT I 2 of 5 LENGTH 1 SETTING				
5	Scan Two Characters From Appendix C	'0' and '2'	'0' and '6'	'1' and '4'	'5' AND '0'
6	Scan ENTER/EXIT PROGRAMMING MODE				

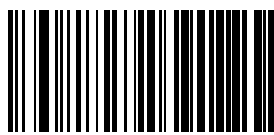

Select I 2 of 5 Length 1 Setting

Make a mistake? Scan the CANCEL barcode to abort and not save the entry string. You can then start again at the beginning.

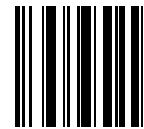

CANCEL

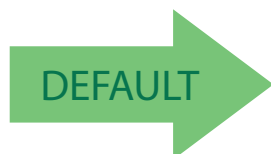

06 = Length 1 is 6 Characters



## I 2 of 5 Set Length 2

This feature specifies one of the barcode lengths for I 2 of 5 Length Control on page 108. Length 2 is the maximum label length if in Variable Length on page 90 Mode, or the second fixed length if in Fixed Length on page 90 Mode. The length includes the barcode's check and data characters.

The length can be set from 2 to 50 characters. A setting of 0 specifies to ignore this length (only one fixed length). For more detailed programming instructions see "Set Length" on Chapter 4, References.

Table 6 provides examples for setting Length 2.

Table 6. I 2 of 5 Length 2 Setting Examples

STEP	ACTION	EXAMPLES			
1	Desired Setting	Ignore This Length	4 Characters	14 Characters	50 Characters
2	Pad with leading zeroes to yield two digits	00	04	14	50
3	Scan ENTER/EXIT PROGRAMMING MODE				
4	Scan SELECT I 2 OF 5 LENGTH 2 SETTING				
5	Scan Two Characters From Appendix C	'0' and '0'	'0' and '4'	'1' and '4'	'5' AND '0'
6	Scan ENTER/EXIT PROGRAMMING MODE				

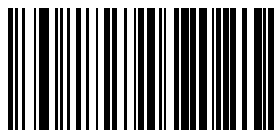

Select I 2 of 5 Length 2 Setting

Make a mistake? Scan the CANCEL barcode to abort and not save the entry string. You can then start again at the beginning.

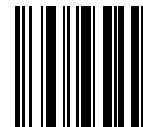

CANCEL



50 = Length 2 is 50 Characters



## FOLLETT 2 OF 5

The following options apply to the Follett 2 of 5 symbology.

### Follett 2 of 5 Enable/Disable

Enables/Disables ability of imager to decode Follett 2 of 5 labels.

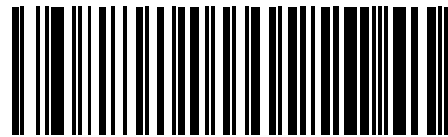
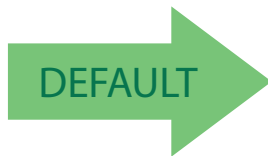

Follett 2 of 5 = Disable

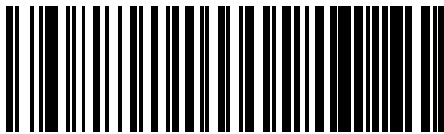

Follett 2 of 5 = Enable

## INTERLEAVED 2 OF 5 CIP HR

The following options apply to the Interleaved 2 of 5 CIP HR symbology.

### Interleaved 2 of 5 CIP HR Enable/Disable

Enables/Disables ability of reader to decode Interleaved 2 of 5 CIP HR labels.

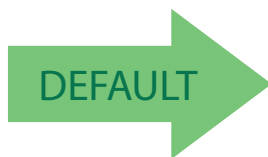

Interleaved 2 of 5 CIP HR = Disable



Interleaved 2 of 5 CIP HR = Enable



## STANDARD 2 OF 5

The following options apply to the Standard 2 of 5 symbology.

### Standard 2 of 5 Enable/Disable

When disabled, the reader will not read Standard 2 of 5 barcodes.

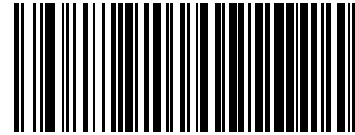
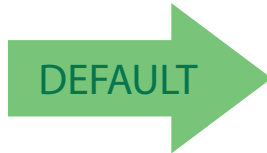

Standard 2 of 5 = Disable

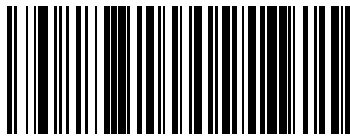

Standard 2 of 5 = Enable

### Standard 2 of 5 Check Character Calculation

This option enables/disables calculation and verification of an optional Standard 2 of 5 check character.

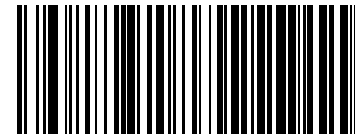

Standard 2 of 5 Check Character Calculation = Disable

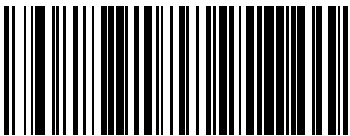

Standard 2 of 5 Check Character Calculation = Enable

### Standard 2 of 5 Check Character Transmission

This feature enables/disables transmission of an optional Standard 2 of 5 check character.

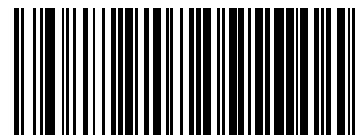

Standard 2 of 5 Check Character Transmission = Don't Send

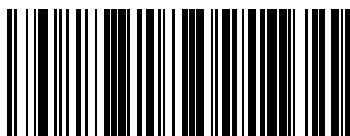

Standard 2 of 5 Check Character Transmission = Send





## Standard 2 of 5 Length Control

This feature specifies either variable length decoding, fixed length decoding or no check length decoding for the Standard 2 of 5 symbology.

**Variable Length:** For variable length decoding, a minimum and maximum length may be set.

**Fixed Length:** For fixed length decoding, two different lengths may be set.



Standard 2 of 5 Length Control = Variable Length

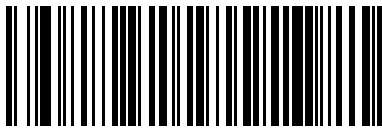

Standard 2 of 5 Length Control = Fixed Length

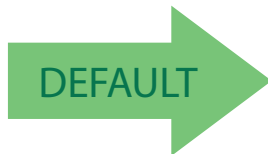

Standard 2 of 5 Length Control = No Check



## Standard 2 of 5 Set Length 1

This feature specifies one of the barcode lengths for Standard 2 of 5. Length 1 is the minimum label length if in [Variable Length on page 113 Mode](#), or the first fixed length if in [Fixed Length on page 90 Mode](#). Length includes the barcode's check and data characters. The length can be set from 1 to 50 characters. For more detailed programming instructions see, "Set Length" on [Chapter 4, References](#).

Table 7 provides some examples for setting Length 1.

Table 7. Standard 2 of 5 Length 1 Setting Examples

STEP	ACTION	EXAMPLES			
1	Desired Setting	01 Character	07 Characters	15 Characters	50 Characters
2	Scan ENTER/EXIT PROGRAMMING MODE				
3	Scan SELECT STANDARD 2 OF 5 LENGTH 1 SETTING				
4	Scan Two Characters From Appendix C	'0' and '1'	'0' and '7'	'1' and '5'	'5' AND '0'
5	Scan ENTER/EXIT PROGRAMMING MODE				

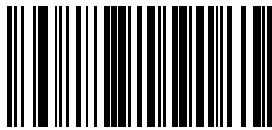

Select Standard 2 of 5 Length 1 Setting

Make a mistake? Scan the CANCEL barcode to abort and not save the entry string. You can then start again at the beginning.

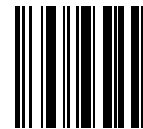

CANCEL



06 = Length 1 is 6 Characters



## Standard 2 of 5 Set Length 2

This feature specifies one of the barcode lengths for for Standard 2 of 5. Length 2 is the maximum label length if in [Variable Length on page 113 Mode](#), or the second fixed length if in [Fixed Length on page 90 Mode](#). Length includes the barcode's check and data characters.

The length can be set from 1 to 50 characters. A setting of 0 specifies to ignore this length (only one fixed length). For more detailed programming instructions see, "Set Length" on [Chapter 4, References](#).

Table 8 provides examples for setting Length 2.

**Table 8. Standard 2 of 5 Length 2 Setting Examples**

STEP	ACTION	EXAMPLES			
1	<b>Desired Setting (pad with leading zeroes)</b>	00 (Ignore This Length)	07 Characters	15 Characters	50 Characters
2	<b>Scan ENTER/EXIT PROGRAMMING MODE</b>				
3	<b>Scan SELECT STANDARD 2 OF 5 LENGTH 2 SETTING</b>				
4	<b>Scan Two Characters From Appendix C</b>	'0' and '0'	'0' and '7'	'1' and '5'	'5' AND '0'
5	<b>Scan ENTER/EXIT PROGRAMMING MODE</b>				

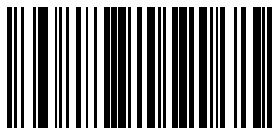

Select Standard 2 of 5 Length 2 Setting

Make a mistake? Scan the CANCEL barcode to abort and not save the entry string. You can then start again at the beginning.

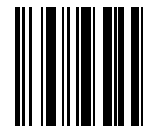

CANCEL



**50 = Length 2 is 50 Characters**



## INDUSTRIAL 2 OF 5

The following options apply to the Industrial 2 of 5 symbology.

### Industrial 2 of 5 Enable/Disable

Enables/Disables ability of reader to decode Industrial 2 of 5 labels.

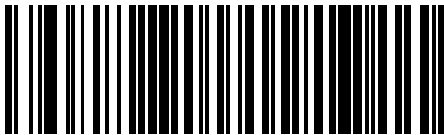
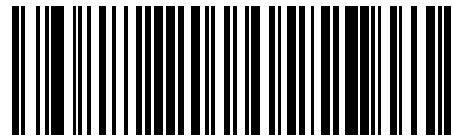
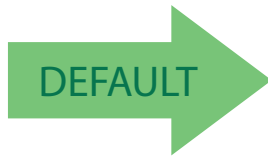



## Industrial 2 of 5 Check Character Calculation

Enables/Disables calculation and verification of an optional Industrial 2 of 5 check character.

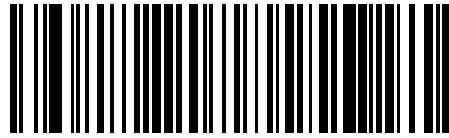
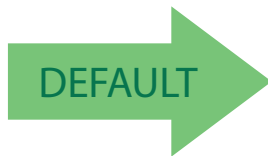

Industrial 2 of 5 Check Character Calculation = Disable

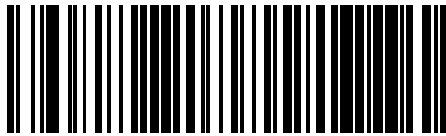

Industrial 2 of 5 Check Character Calculation = Enable

## Industrial 2 of 5 Check Character Transmission

Enables/disables transmission of an Industrial 2 of 5 check character.

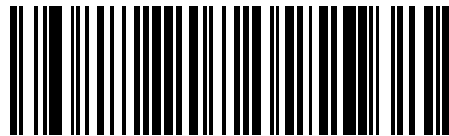

Industrial 2 of 5 Check Character Transmission = Disable

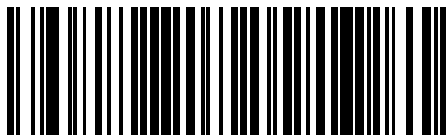

Industrial 2 of 5 Check Character Transmission = Enable





## Industrial 2 of 5 Length Control

This feature specifies either variable length decoding, fixed length decoding or no check length decoding for the Industrial 2 of 5 symbology.

**Variable Length:** For variable length decoding, a minimum and maximum length may be set.

**Fixed Length:** For fixed length decoding, two different lengths may be set.

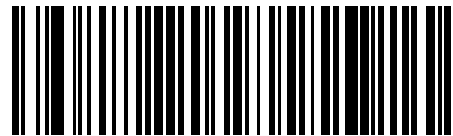

Industrial 2 of 5 Length Control = Variable Length

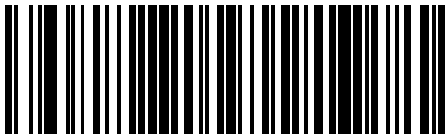

Industrial 2 of 5 = Fixed Length

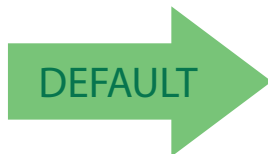

Industrial 2 of 5 Length Control = No Check



## Industrial 2 of 5 Set Length 1

This feature specifies one of the barcode lengths for Industrial 2 of 5. Length 1 is the minimum label length if in [Variable Length on page 90 Mode](#), or the first fixed length if in [Fixed Length on page 90 Mode](#). Length includes the barcode's data characters only. The length can be set from 0 to 50 characters. For more detailed programming instructions see, "Set Length" on [Chapter 4, References](#).

Table 9 provides some examples for setting Length 1.

**Table 9. Industrial 2 of 5 Length 1 Setting Examples**

STEP	ACTION	EXAMPLES			
1	Desired Setting	00 Characters	07 Characters	15 Characters	50 Characters
2	Scan ENTER/EXIT PROGRAMMING MODE				
3	Scan SELECT INDUSTRIAL 2 OF 5 LENGTH 1 SETTING				
4	Scan Two Characters From Appendix C	'0' and '0'	'0' and '7'	'1' and '5'	'5' AND '0'
5	Scan ENTER/EXIT PROGRAMMING MODE				

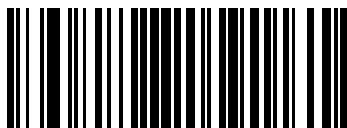

Select Industrial 2 of 5 Set Length 1 Setting

*Make a mistake? Scan the CANCEL barcode to abort and not save the entry string. You can then start again at the beginning.*

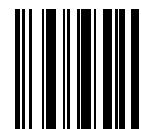

CANCEL

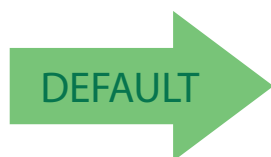

**06 = Length 1 is 6 Characters**



## Industrial 2 of 5 Set Length 2

This feature specifies one of the barcode lengths for Industrial 2 of 5. Length 2 is the maximum label length if in [Variable Length on page 90 Mode](#), or the second fixed length if in [Fixed Length on page 90 Mode](#). Length includes the barcode's check, data, and full-ASCII shift characters. The length does not include start/stop characters.

The length can be set from 1 to 50 characters. A setting of 0 specifies to ignore this length (only one fixed length). For more detailed programming instructions see, "Set Length" on [Chapter 4, References](#).

Table 10 provides examples for setting Length 2.

**Table 10. Industrial 2 of 5 Length 2 Setting Examples**

STEP	ACTION	EXAMPLES			
1	<b>Desired Setting</b>	00 (Ignore This Length)	07 Characters	15 Characters	50 Characters
2	<b>Scan ENTER/EXIT PROGRAMMING MODE</b>				
3	<b>Scan SELECT INDUSTRIAL 2 OF 5 LENGTH 2 SETTING</b>				
4	<b>Scan Two Characters From Appendix C</b>	'0' and '0'	'0' and '7'	'1' and '5'	'5' AND '0'
5	<b>Scan ENTER/EXIT PROGRAMMING MODE</b>				

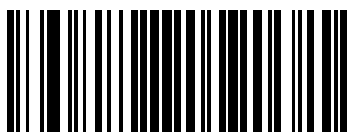

Select Industrial 2 of 5 Length 2 Setting

*Make a mistake? Scan the CANCEL barcode to abort and not save the entry string. You can then start again at the beginning.*

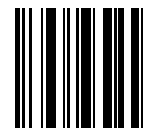

CANCEL



**50 = Length 2 is 50 Characters**



## CODE IATA

The following options apply to the IATA symbology.

### IATA Enable/Disable

Enables/Disables the ability of the reader to decode IATA labels.

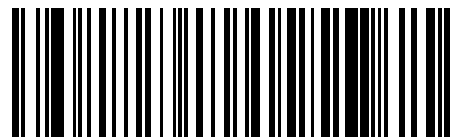
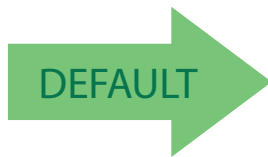

IATA = Disable

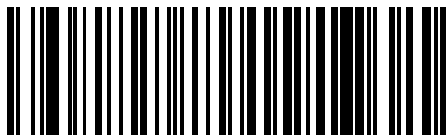

IATA = Enable

### IATA Check Character Transmission

Enables/Disables calculation and verification of an optional Industrial 2 of 5 check character.

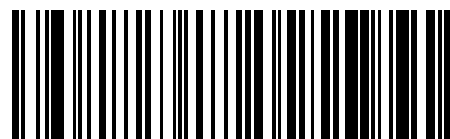

IATA Check Character Transmission = Disable



IATA Check Character Transmission = Enable





## DATALOGIC 2 OF 5

The following options apply to the Datalogic 2 of 5 symbology.

### Datalogic 2 of 5 Enable/Disable

When disabled, the reader will not read Datalogic 2 of 5 barcodes.

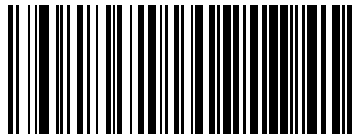
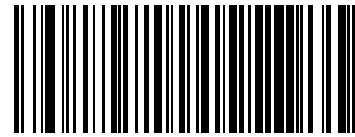
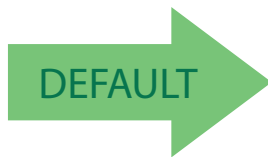

### Datalogic 2 of 5 Check Character Calculation

This option enables/disables calculation and verification of an optional Datalogic 2 of 5 check character.

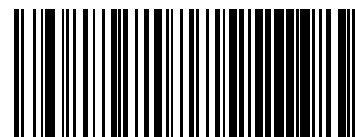
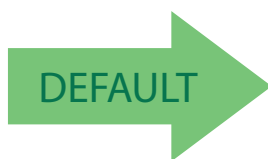



## Datalogic 2 of 5 Length Control

This feature specifies either variable length decoding, fixed length decoding or no check length decoding for the Datalogic 2 of 5 symbology.

**Variable Length:** For variable length decoding, a minimum and maximum length may be set.

**Fixed Length:** For fixed length decoding, two different lengths may be set.

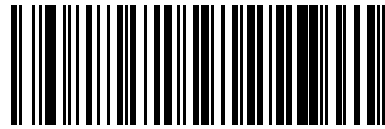

Datalogic 2 of 5 Length Control = Variable Length

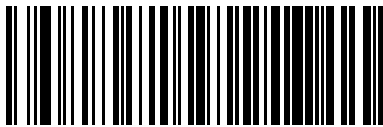

Datalogic 2 of 5 Length Control = Fixed Length

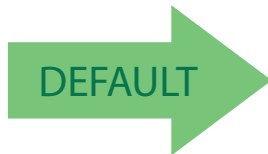

Datalogic 2 of 5 Length Control = No Check



### Datalogic 2 of 5 Set Length 1

This feature specifies one of the barcode lengths for Datalogic 2 of 5. Length 1 is the minimum label length if in Variable Length on page 108 Mode, or the first fixed length if in Fixed Length on page 108 Mode. The length includes the barcode's check and data characters. The length can be set from 2 to 50 characters in increments of two. For more detailed programming instructions see, "Set Length" on Chapter 4, References.

Table 11 provides some examples for setting Length 1.

**Table 11. Datalogic 2 of 5 Length 1 Setting Examples**

STEP	ACTION	EXAMPLES			
1	<b>Desired Setting</b>	2 Characters	6 Characters	14 Characters	50 Characters
2	<b>Pad with leading zeroes to yield two digits</b>	02	06	14	50
3	<b>Scan ENTER/EXIT PROGRAMMING MODE</b>				
4	<b>Scan SELECT Datalogic 2 of 5 LENGTH 1 SETTING</b>				
5	<b>Scan Two Characters From Appendix C</b>	'0' and '2'	'0' and '6'	'1' and '4'	'5' AND '0'
6	<b>Scan ENTER/EXIT PROGRAMMING MODE</b>				



Select Datalogic 2 of 5 Length 1 Setting

Make a mistake? Scan the CANCEL barcode to abort and not save the entry string. You can then start again at the beginning.

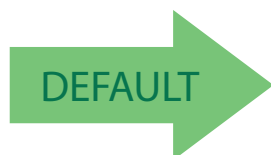

**01 = Length 1 is 1 Character**



## Datalogic 2 of 5 Set Length 2

This feature specifies one of the barcode lengths for Datalogic 2 of 5 Length Control on page 123. Length 2 is the maximum label length if in Variable Length on page 108 Mode, or the second fixed length if in Fixed Length on page 108 Mode. The length includes the barcode's check and data characters.

The length can be set from 2 to 50 characters. A setting of 0 specifies to ignore this length (only one fixed length). For more detailed programming instructions see "Set Length" on Chapter 4, References.

Table 12 provides examples for setting Length 2.

**Table 12. Datalogic 2 of 5 Length 2 Setting Examples**

STEP	ACTION	EXAMPLES			
1	Desired Setting	Ignore This Length	4 Characters	14 Characters	50 Characters
2	Pad with leading zeroes to yield two digits	00	04	14	50
3	Scan ENTER/EXIT PROGRAMMING MODE				
4	Scan SELECT DATALOGIC 2 OF 5 LENGTH 2 SETTING				
5	Scan Two Characters From Appendix C	'0' and '0'	'0' and '4'	'1' and '4'	'5' AND '0'
6	Scan ENTER/EXIT PROGRAMMING MODE				



Select Datalogic 2 of 5 Length 2 Setting

Make a mistake? Scan the CANCEL barcode to abort and not save the entry string. You can then start again at the beginning.

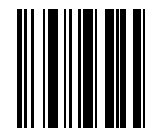

CANCEL

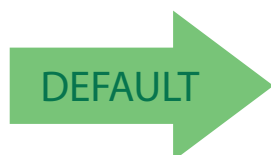

**50 = Length 2 is 50 Characters**



## CODABAR

The following options apply to the Codabar symbology.

### Codabar Enable/Disable

When disabled, the reader will not read Codabar barcodes.

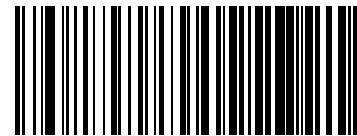
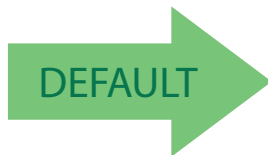

### Codabar Check Character Calculation

Enable this option to enables /disables calculation and verification of an optional Codabar check character. When disabled, any check character in the label is treated as a data character

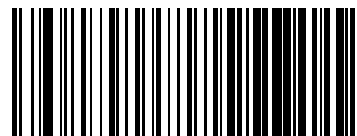
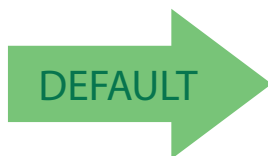

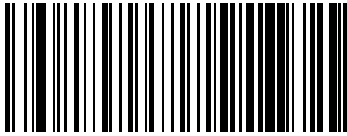

Codabar Check Character Calculation = Enable AIM standard check char.

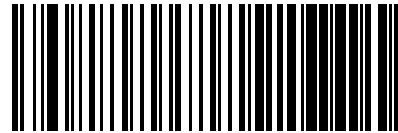

Codabar Check Character Calculation = Enable Modulo 10 check char.

### Codabar Check Character Transmission

Enable this option to transmit the check character along with Codabar barcode data.

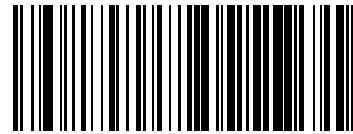

Codabar Check Character Transmission = Don't Send

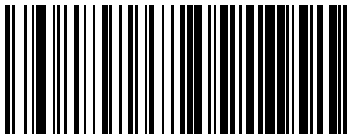

Codabar Check Character Transmission = Send





## Codabar Start/Stop Character Transmission

Enable this option to enable/disable transmission of Codabar start and stop characters.

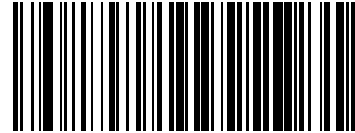

Codabar Start/Stop Character Transmission = Don't Transmit

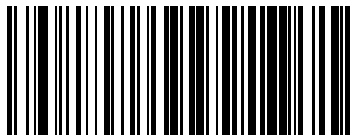

Codabar Start/Stop Character Transmission = Transmit



## Codabar Start/Stop Character Match

When enabled, this option requires that start and stop characters match.

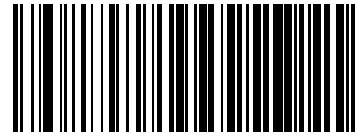
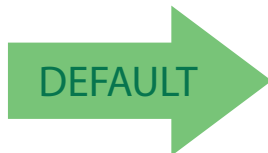

Codabar Start/Stop Character Match = Don't Require Match

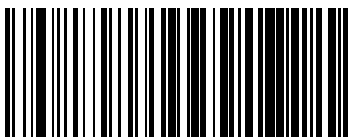

Codabar Start/Stop Character Match = Require Match



## Codabar Quiet Zones

Specifies the number of quiet zones for Codabar labels. Quiet zones are blank areas at the ends of a barcode and are typically 10 times the width of the narrowest bar or space in the label.

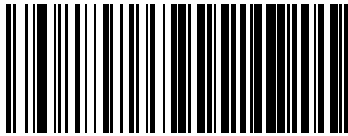

Codabar Quiet Zones = Auto

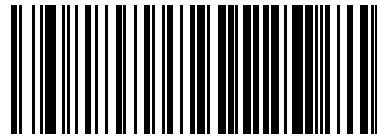

Codabar Quiet Zones = Small Quiet Zones on two sides



## Codabar Length Control

This feature specifies either variable length decoding or fixed length decoding for the Codabar symbology.

**Variable Length:** For variable length decoding, a minimum and maximum length may be set.

**Fixed Length:** For fixed length decoding, two different lengths may be set.

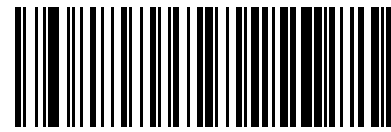

Codabar Length Control = Variable Length

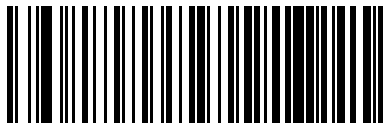

Codabar Length Control = Fixed Length



Codabar Length Control = No Check



## Codabar Set Length 1

This feature specifies one of the barcode lengths for Codabar. Length 1 is the minimum label length if in [Variable Length on page 90 Mode](#), or the first fixed length if in [Fixed Length on page 90 Mode](#). Length includes the barcode's start, stop, check and data characters. The length must include at least one data character. The length can be set from 3 to 50 characters. For more detailed programming instructions see, "Set Length" on [Chapter 4, References](#).

Table 13 provides some examples for setting Length 1.

**Table 13. Codabar Length 1 Setting Examples**

STEP	ACTION	EXAMPLES			
1	Desired Setting (and pad with leading zeroes)	03 Characters	09 Characters	15 Characters	50 Characters
2	Scan ENTER/EXIT PROGRAMMING MODE				
3	Scan SELECT CODABAR LENGTH 1 SETTING				
4	Scan Two Characters From Appendix C	'0' and '3'	'0' and '9'	'1' and '5'	'5' AND '0'
5	Scan ENTER/EXIT PROGRAMMING MODE				

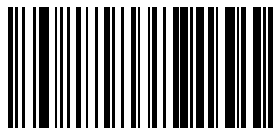

Select Codabar Length 1 Setting

Make a mistake? Scan the CANCEL barcode to abort and not save the entry string. You can then start again at the beginning.

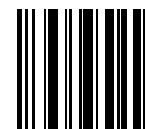

CANCEL



**01 = Length 1 is 1 Character**



## Codabar Set Length 2

This feature specifies one of the barcode lengths for Codabar. Length 2 is the maximum label length if in [Variable Length on page 90 Mode](#), or the second fixed length if in [Fixed Length on page 90 Mode](#). The length includes the barcode's start, stop, check and data characters. The length must include at least one data character.

The length can be set from 3 to 50 characters. A setting of 0 specifies to ignore this length (only one fixed length). For more detailed programming instructions see, "Set Length" on [Chapter 4, References](#).

Table 14 provides examples for setting Length 2.

**Table 14. Codabar Length 2 Setting Examples**

STEP	ACTION	EXAMPLES			
1	<b>Desired Setting (and pad with leading zeroes)</b>	00 Ignore This Length	07 Characters	15 Characters	50 Characters
2	<b>Scan ENTER/EXIT PROGRAMMING MODE</b>				
3	<b>Scan SELECT CODABAR LENGTH 2 SETTING</b>				
4	<b>Scan Two Characters From Appendix C</b>	'0' and '0'	'0' and '7'	'1' and '5'	'5' AND '0'
5	<b>Scan ENTER/EXIT PROGRAMMING MODE</b>				



Select Codabar Length 2 Setting

Make a mistake? Scan the CANCEL barcode to abort and not save the entry string. You can then start again at the beginning.

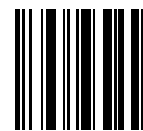

CANCEL

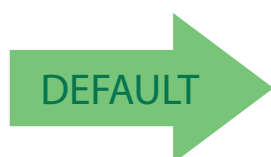

**50 = Length 2 is 50 Characters**



## ABC CODABAR

The following options apply to the ABC Codabar symbology.

### ABC Codabar Enable/Disable

Enables/Disables ability of reader to decode ABC Codabar labels.

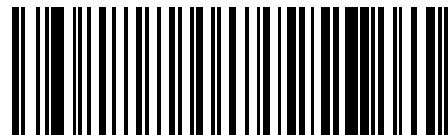
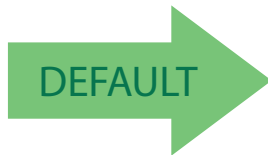

ABC Codabar = Disable

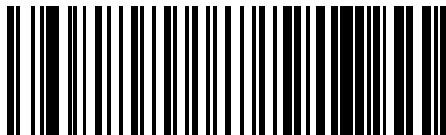

ABC Codabar = Enable

### ABC Codabar Concatenation Mode

Specifies the concatenation mode between Static and Dynamic.

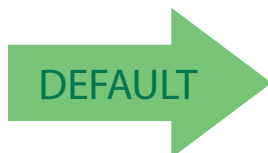

ABC Codabar Concatenation Mode = Static



ABC Codabar Concatenation Mode = Dynamic



## ABC Codabar Dynamic Concatenation Timeout

Specifies the timeout in 10-millisecond ticks used by the ABC Codabar Dynamic Concatenation Mode.

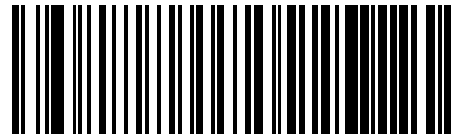

ABC Codabar Dynamic Concatenation Timeout = 50 msec

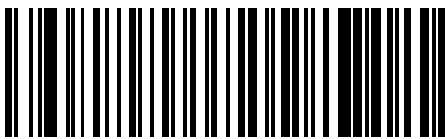

ABC Codabar Dynamic Concatenation Timeout = 100 msec

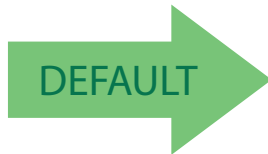

ABC Codabar Dynamic Concatenation Timeout = 200 msec

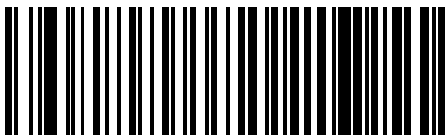

ABC Codabar Dynamic Concatenation Timeout = 500 msec

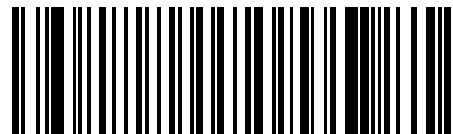

ABC Codabar Dynamic Concatenation Timeout = 750 msec

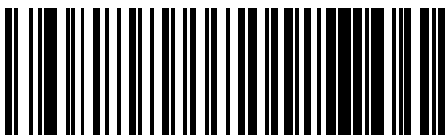

ABC Codabar Dynamic Concatenation Timeout = 1 Second



## ABC Codabar Force Concatenation

Forces labels starting or ending with D to be concatenated.

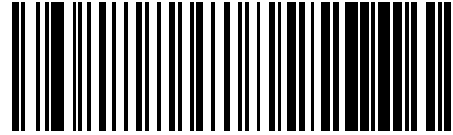
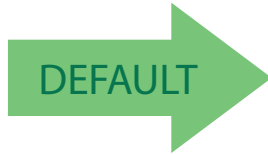

ABC Codabar Force Concatenation = Disable

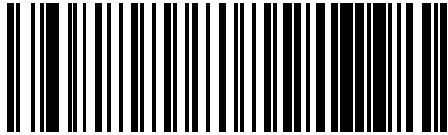

ABC Codabar Force Concatenation = Enable



## CODE 11

The following options apply to the Code 11 symbology.

### Code 11 Enable/Disable

When disabled, the reader will not read Code 11 barcodes.

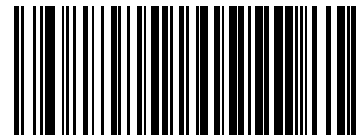
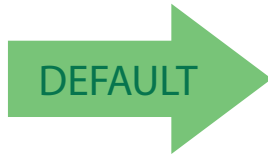

Code 11 = Disable

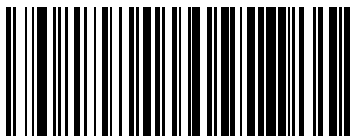

Code 11 = Enable

### Code 11 Check Character Calculation

This option enables/disables calculation and verification of optional Code 11 check character.

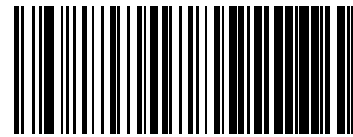

Code 11 Check Character Calculation = Disable

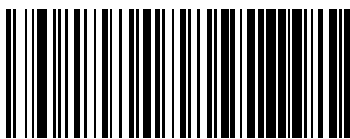

Code 11 Check Character Calculation = Check C

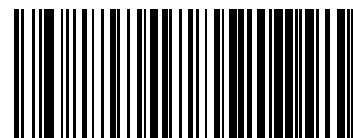

Code 11 Check Character Calculation = Check K



Code 11 Check Character Calculation = Check C and K





### Code 11 Check Character Transmission

This feature enables/disables transmission of an optional Code 11 check character.

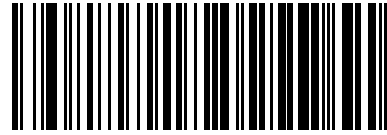

Code 11 Check Character Transmission = Don't Send

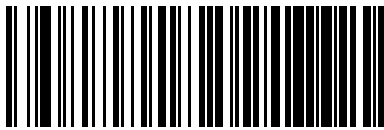

Code 11 Check Character Transmission = Send



### Code 11 Length Control

This feature specifies either variable length decoding, fixed length decoding or no check length decoding for the Code 11 symbology.

**Variable Length:** For variable length decoding, a minimum and maximum length may be set.

**Fixed Length:** For fixed length decoding, two different lengths may be set.



Code 11 Length Control = Variable Length

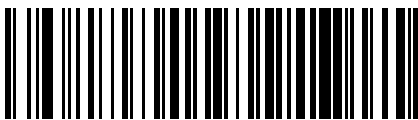

Code 11 Length Control = Fixed Length

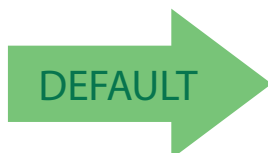

Code 11 Length Control = No Check



## Code 11 Set Length 1

This feature specifies one of the barcode lengths for Code 11. Length 1 is the minimum label length if in [Variable Length on page 90 Mode](#), or the first fixed length if in [Fixed Length on page 90 Mode](#). Length includes the barcode's check and data characters. The length can be set from 2 to 50 characters. For more detailed programming instructions see, "Set Length" on [Chapter 4, References](#).

Table 15 provides some examples for setting Length 1.

**Table 15. Code 11 Length 1 Setting Examples**

STEP	ACTION	EXAMPLES			
1	Desired Setting (pad with leading zeroes)	02 Characters	07 Characters	15 Characters	50 Characters
2	Scan ENTER/EXIT PROGRAMMING MODE				
3	Scan SELECT CODE 11 LENGTH 1 SETTING				
4	Scan Two Characters From Appendix C	'0' and '2'	'0' and '7'	'1' and '5'	'5' AND '0'
5	Scan ENTER/EXIT PROGRAMMING MODE				

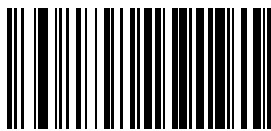

Select Code 11 Set Length 1 Setting

Make a mistake? Scan the CANCEL barcode to abort and not save the entry string. You can then start again at the beginning.

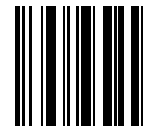

CANCEL

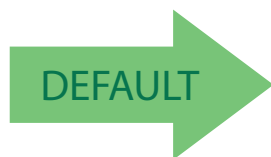

**01 = Length 1 is 1 Character**



## Code 11 Set Length 2

This feature specifies one of the barcode lengths for Code 11. Length 2 is the maximum label length if in Variable Length on page 90 Mode, or the second fixed length if in Fixed Length on page 90 Mode. Length includes the barcode's check and data characters.

The length can be set from 2 to 50 characters. A setting of 0 specifies to ignore this length (only one fixed length). For more detailed programming instructions see "Set Length" on Chapter 4, References.

Table 16 provides examples for setting Length 2.

Table 16. Code 11 Length 2 Setting Examples

STEP	ACTION	EXAMPLES			
1	Desired Setting (pad with leading zeroes)	00 (Ignore This Length)	07 Characters	15 Characters	50 Characters
2	Scan ENTER/EXIT PROGRAMMING MODE				
3	Scan SELECT CODE 11 LENGTH 2 SETTING				
4	Scan Two Characters From Appendix C	'0' and '0'	'0' and '7'	'0' and 'F'	'3' AND 2'
5	Scan ENTER/EXIT PROGRAMMING MODE				

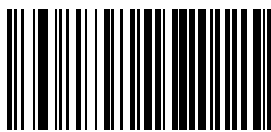

Select Code 11 Length 2 Setting

Make a mistake? Scan the CANCEL barcode to abort and not save the entry string. You can then start again at the beginning.

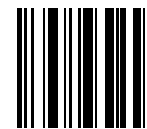

CANCEL

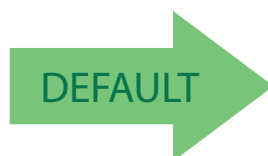

50 = Length 2 is 50 Characters



## GS1 DATABAR™ OMNIDIRECTIONAL

The following options apply to the GS1 DataBar™ Omnidirectional (formerly RSS-14) symbology.

### GS1 DataBar™ Omnidirectional Enable/Disable

When disabled, the reader will not read GS1 DataBar™ Omnidirectional barcodes.

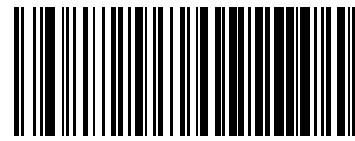
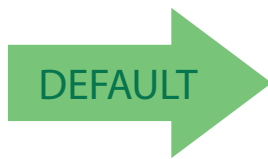

### GS1 DataBar™ Omnidirectional GS1-128 Emulation

When enabled, GS1 DataBar™ Omnidirectional barcodes will be translated to the GS1-128 label data format.

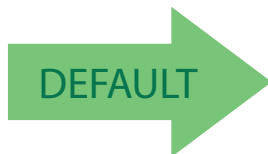



## GS1 DATABAR™ EXPANDED

The following options apply to the GS1 DataBar™ Expanded (formerly RSS Expanded) symbology.

### GS1 DataBar™ Expanded Enable/Disable

When disabled, the reader will not read GS1 DataBar™ Expanded barcodes.

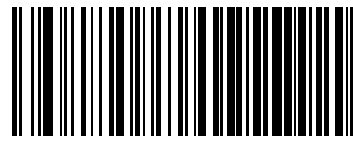
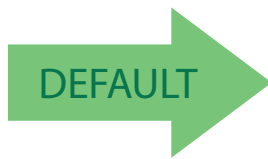

GS1 DataBar™ Expanded = Disable

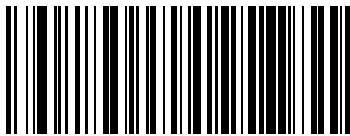

GS1 DataBar™ Expanded = Enable

### GS1 DataBar™ Expanded GS1-128 Emulation

When enabled, GS1 DataBar™ Expanded barcodes will be translated to the GS1-128 label data format.

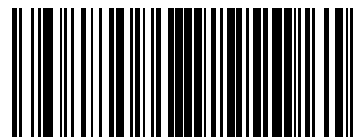
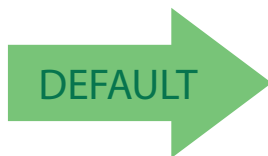

GS1 DataBar™ Expanded GS1-128 Emulation = Disable

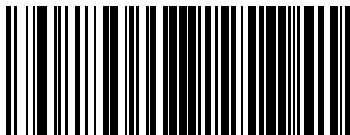

GS1 DataBar™ Expanded GS1-128 Emulation = Enable



## GS1 DataBar™ Expanded Length Control

This feature specifies either variable length decoding, fixed length decoding or no check length decoding for the GS1 DataBar™ Expanded symbology.

**Variable Length.** For variable-length decoding, a minimum length may be set.

**Fixed Length.** For fixed-length decoding, two different lengths may be set.

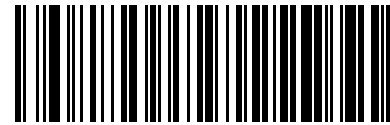

GS1 DataBar™ Expanded Length Control = Variable Length

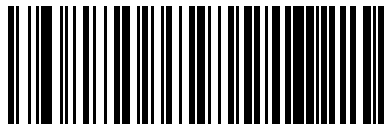

GS1 DataBar™ Expanded Length Control = Fixed Length

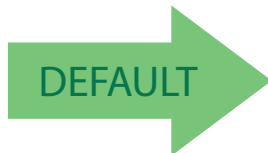

GS1 DataBar™ Expanded Length Control = No check



## GS1 DataBar™ Expanded Set Length 1

This feature specifies one of the barcode lengths for GS1 DataBar™ Expanded. Length 1 is the minimum label length if in Variable Length on page 90 Mode, or the first fixed length if in Fixed Length on page 90 Mode. Length includes the barcode's data characters only. The length can be set from 1 to 74 characters. For more detailed programming instructions see, "Set Length" on Chapter 4, References.

Table 17 provides some examples for setting Length 1.

Table 17. GS1 DataBar™ Expanded Length 1 Setting Examples

STEP	ACTION	EXAMPLES			
1	Desired Setting	01 Character	07 Characters	52 Characters	74 Characters
2	Scan ENTER/EXIT PROGRAMMING MODE				
3	Scan SELECT GS1 DataBar™ EXPANDED LENGTH 1SETTING				
4	Scan Two Characters From Appendix C	'0' and '1'	'0' and '7'	'5' and '2'	'7' AND '4'
5	Scan ENTER/EXIT PROGRAMMING MODE				

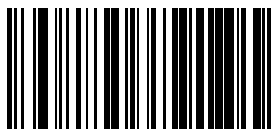

Select GS1 DataBar™ Expanded Set Length 1 Setting

Make a mistake? Scan the CANCEL barcode to abort and not save the entry string. You can then start again at the beginning.

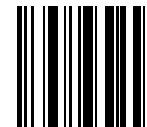

CANCEL

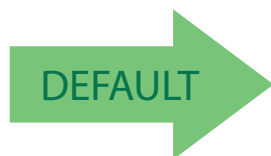

01 = Length 1 is 1 Character



## GS1 DataBar™ Expanded Set Length 2

This feature specifies one of the barcode lengths for GS1 DataBar™ Expanded Length Control on page 142. Length 2 is the maximum label length if in Variable Length on page 90 Mode, or the second fixed length if in Fixed Length on page 90 Mode. Length includes the barcode’s data characters only. The length can be set from 1 to 74 characters. A setting of 0 specifies to ignore this length (only one fixed length). For more detailed programming instructions see, "Set Length" on Chapter 4, References.

Table 18 provides examples for setting Length 2.

Table 18. GS1 DataBar™ Expanded Length 2 Setting Examples

STEP	ACTION	EXAMPLES			
1	Desired Setting	00 (ignore second length)	07 Characters	52 Characters	74 Characters
2	Scan ENTER/EXIT PROGRAMMING MODE				
3	Scan SELECT GS1 DataBar™ EXPANDED LENGTH 2 SETTING				
4	Scan Two Characters From Appendix C	'0' and '0'	'0' and '7'	'5' and '2'	'7' and '4'
5	Scan ENTER/EXIT PROGRAMMING MODE				

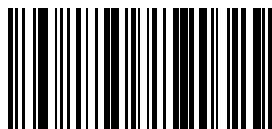

Select GS1 DataBar™ Expanded Set Length 2 Setting

Make a mistake? Scan the CANCEL barcode to abort and not save the entry string. You can then start again at the beginning.

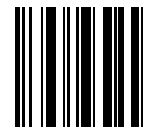

CANCEL



74 = Length 2 is 74 Characters



## GS1 DATABAR™ LIMITED

The following options apply to the GS1 DataBar™ Limited (formerly RSS Limited) symbology.

### GS1 DataBar™ Limited Enable/Disable

When disabled, the reader will not read GS1 DataBar™ Limited barcodes.

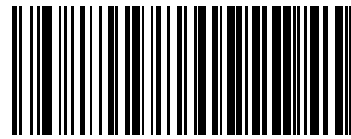
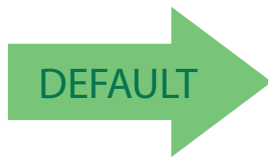

### GS1 DataBar™ Limited GS1-128 Emulation

When enabled, GS1 DataBar™ Limited barcodes will be translated to the GS1-128 label data format.

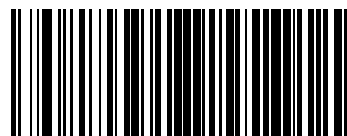
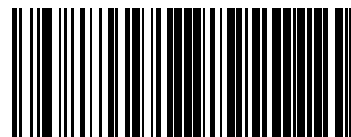
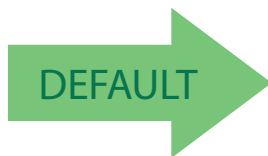



## CODE 93

The following options apply to the Code 93 symbology.

### Code 93 Enable/Disable

Enables/Disables ability of reader to decode Code 93 labels.

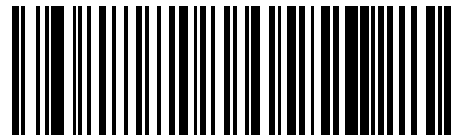
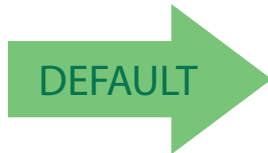

Code 93 = Disable

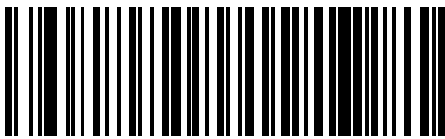

Code 93 = Enable

### Code 93 Check Character Calculation

Enables/disables calculation and verification of an optional Code 93 check character.



Code 93 Check Character Calculation = Disable

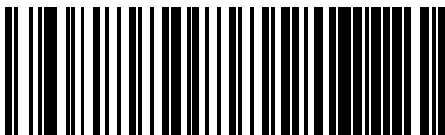

Code 93 Check Character Calculation = Enable Check C

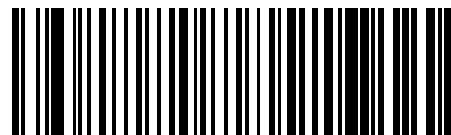

Code 93 Check Character Calculation = Enable Check K

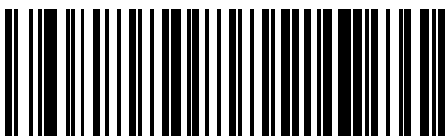

Code 93 Check Character Calculation = Enable Check C and K





## Code 93 Check Character Transmission

Enables/disables transmission of an optional Code 93 check character.

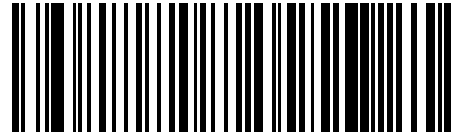
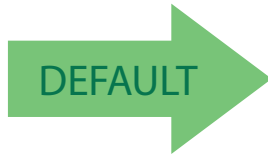

Code 93 Check Character Transmission = Disable

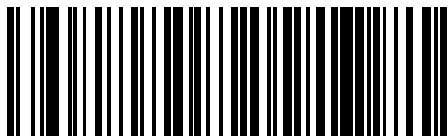

Code 93 Check Character Transmission = Enable

## Code 93 Length Control

This feature specifies either variable length decoding, fixed length decoding or no check length decoding for the Code 93 symbology.

**Variable Length:** For variable length decoding, a minimum and maximum length may be set.

**Fixed Length:** For fixed length decoding, two different lengths may be set.

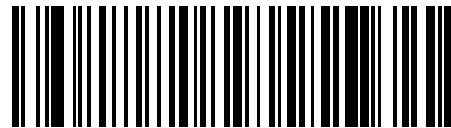

Code 93 Length Control = Variable Length

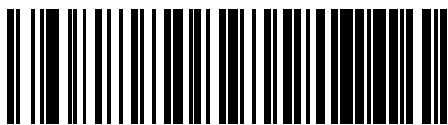

Code 93 = Fixed Length

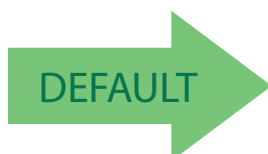

Code 93 Length Control = No Check



## Code 93 Set Length 1

Specifies one of the barcode lengths for Code 93. Length 1 is the minimum label length if in Variable Length on page 90 Mode, or the first fixed length if in Fixed Length on page 90 Mode. Length includes the barcode's data characters only. The length can be set from 01 to 50 characters. For more detailed programming instructions see "Set Length" on Chapter 4, References.

Table 19 provides some examples for setting Length 1.

Table 19. Code 93 Length 1 Setting Examples

STEP	ACTION	EXAMPLES			
1	Desired Setting	01 Characters	07 Characters	15 Characters	50 Characters
2	Scan ENTER/EXIT PROGRAMMING MODE				
3	Scan SELECT CODE 93 LENGTH 1 SETTING				
4	Scan Two Characters From Appendix C	'0' and '1'	'0' and '7'	'1' and '5'	'5' AND '0'
5	Scan ENTER/EXIT PROGRAMMING MODE				

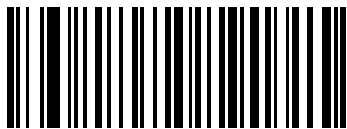

Select Code 93 Set Length 1 Setting

Make a mistake? Scan the CANCEL barcode to abort and not save the entry string. You can then start again at the beginning.

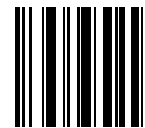

CANCEL

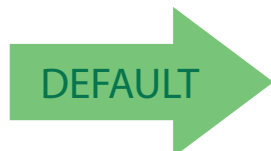

01 = Length 1 is 1 Character



## Code 93 Set Length 2

This feature specifies one of the barcode lengths for Code 93. Length 2 is the maximum label length if in [Variable Length on page 90 Mode](#), or the second fixed length if in [Fixed Length on page 90 Mode](#). Length includes the barcode’s check, data, and full-ASCII shift characters. The length does not include start/stop characters. The length can be set from 1 to 50 characters. A setting of 0 specifies to ignore this length (only one fixed length). For more detailed programming instructions see, "Set Length" on [Chapter 4, References](#).

Table 20 provides examples for setting Length 2.

**Table 20. CODE 93 Length 2 Setting Examples**

STEP	ACTION	EXAMPLES			
1	Desired Setting	00 (Ignore This Length)	07 Characters	15 Characters	50 Characters
2	Scan ENTER/EXIT PROGRAMMING MODE				
3	Scan SELECT CODE 93 LENGTH 2 SETTING				
4	Scan Two Characters From Appendix C	'0' and '0'	'0' and '7'	'1' and '5'	'5' AND '0'
5	Scan ENTER/EXIT PROGRAMMING MODE				

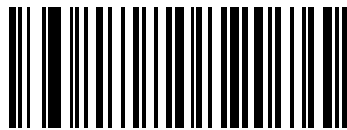

Select Code 93 Length 2 Setting

Make a mistake? Scan the CANCEL barcode to abort and not save the entry string. You can then start again at the beginning.

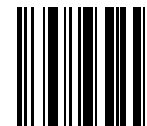

CANCEL

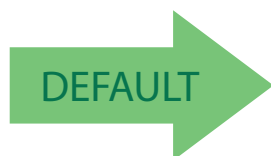

50 = Length 2 is 50 Characters



## Code 93 Quiet Zones

Enables/disables quiet zones for Code 93.

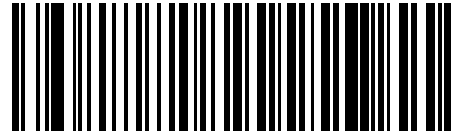

Code 93 Quiet Zones = No Quiet Zones

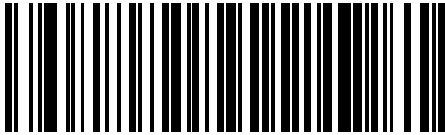

Code 93 Quiet Zones = Auto





## MSI

The following options apply to the MSI symbology.

### MSI Enable/Disable

Enables/Disables ability of reader to decode MSI labels.

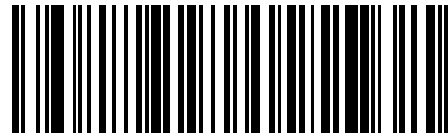

MSI = Disable



MSI = Enable

### MSI Check Character Calculation

Enables/Disables calculation and verification of an optional MSI check character.

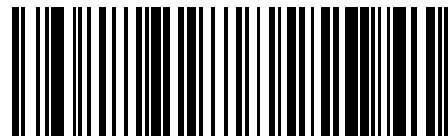

MSI Check Character Calculation = Disable



MSI Check Character Calculation = Enable Mod10



MSI Check Character Calculation = Enable Mod11/10



MSI Check Character Calculation = Enable Mod10/10



## MSI Check Character Transmission

Enables/disables transmission of an MSI check character.

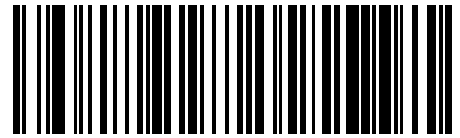

MSI Check Character Transmission = Disable

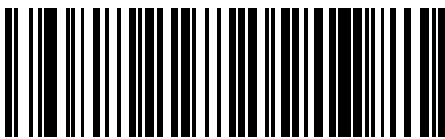

MSI Check Character Transmission = Enable



## MSI Length Control

This feature specifies either variable length decoding, fixed length decoding or no check length decoding for the MSI symbology.

**Variable Length:** For variable length decoding, a minimum and maximum length may be set.

**Fixed Length:** For fixed length decoding, two different lengths may be set.

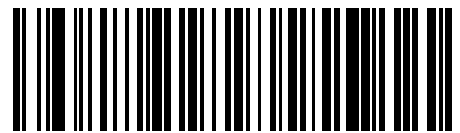

MSI Length Control = Variable Length

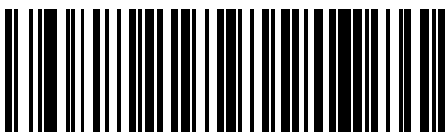

MSI = Fixed Length

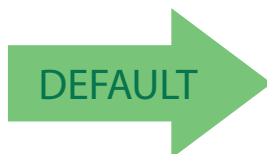

MSI Length Control = No Check



## MSI Set Length 1

This feature specifies one of the barcode lengths for MSI. Length 1 is the minimum label length if in [Variable Length on page 90 Mode](#), or the first fixed length if in [Fixed Length on page 90 Mode](#). Length includes the barcode's data characters only. The length can be set from 01 to 50 characters. For more detailed programming instructions see, "Set Length" on [Chapter 4, References](#).

Table 21 provides some examples for setting Length 1.

**Table 21. MSI Length 1 Setting Examples**

STEP	ACTION	EXAMPLES			
1	Desired Setting	01 Characters	07 Characters	15 Characters	50 Characters
2	Scan ENTER/EXIT PROGRAMMING MODE				
3	Scan SELECT MSI LENGTH 1 SETTING				
4	Scan Two Characters From Appendix C	'0' and '1'	'0' and '7'	'1' and '5'	'5' AND '0'
5	Scan ENTER/EXIT PROGRAMMING MODE				

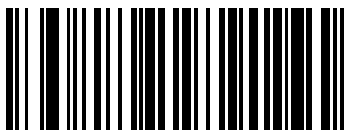

Select MSI Set Length 1 Setting

Make a mistake? Scan the CANCEL barcode to abort and not save the entry string. You can then start again at the beginning.

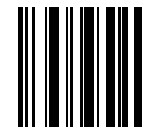

CANCEL

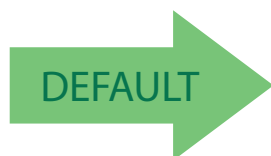

01 = Length 1 is 1 Character



## MSI Set Length 2

This feature specifies one of the barcode lengths for MSI. Length 2 is the maximum label length if in [Variable Length on page 90 Mode](#), or the second fixed length if in [Fixed Length on page 90 Mode](#). Length includes the barcode’s check, data, and full-ASCII shift characters. The length does not include start/stop characters.

The length can be set from 1 to 50 characters. A setting of 0 specifies to ignore this length (only one fixed length). For more detailed programming instructions see, "Set Length" on [Chapter 4, References](#).

Table 22 provides examples for setting Length 2.

**Table 22. MSI Length 2 Setting Examples**

STEP	ACTION	EXAMPLES			
1	Desired Setting	00 (Ignore This Length)	07 Characters	15 Characters	50 Characters
2	Scan ENTER/EXIT PROGRAMMING MODE				
3	Scan SELECT MSI LENGTH 2 SETTING				
4	Scan Two Characters From Appendix C	'0' and '0'	'0' and '7'	'1' and '5'	'5' AND '0'
5	Scan ENTER/EXIT PROGRAMMING MODE				

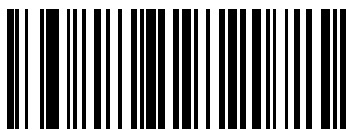

Select MSI Length 2 Setting

Make a mistake? Scan the CANCEL barcode to abort and not save the entry string. You can then start again at the beginning.

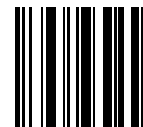

CANCEL

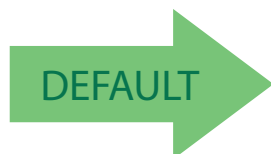

**50 = Length 2 is 50 Characters**



## PLESSEY

The following options apply to the Plessey symbology.

### Plessey Enable/Disable

Enables/Disables ability of reader to decode Plessey labels.

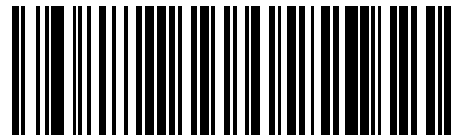
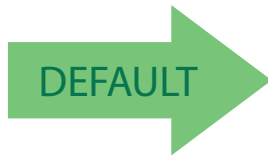

Plessey = Disable

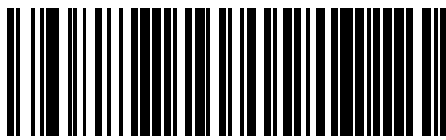

Plessey = Enable



## Plessey Check Character Calculation

Enables/Disables calculation and verification of an optional Plessey check character.

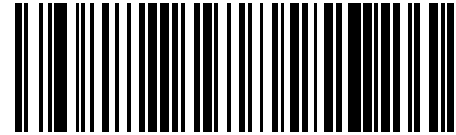

Plessey Check Character Calculation = Disable

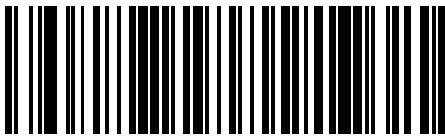

Plessey Check Character Calculation =  
Enable Plessey std. check char. verification

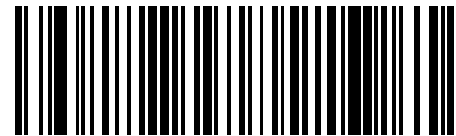

Plessey Check Character Calculation =  
Enable Anker check char. verification

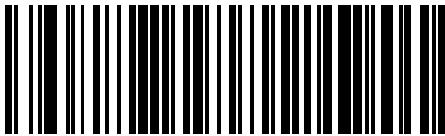

Plessey Check Character Calculation =  
Enable Plessey std. and Anker check char verification

## Plessey Check Character Transmission

Enables/disables transmission of an MSI check character.



Plessey Check Character Transmission = Disable



Plessey Check Character Transmission = Enable



## Plessey Length Control

This feature specifies either variable length decoding, fixed length decoding or no check length decoding for the Plessey symbology.

**Variable Length:** For variable length decoding, a minimum and maximum length may be set.

**Fixed Length:** For fixed length decoding, two different lengths may be set.

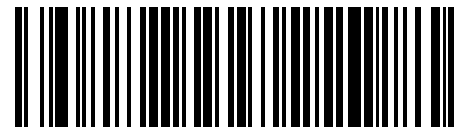

Plessey Length Control = Variable Length

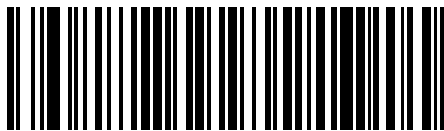

Plessey = Fixed Length

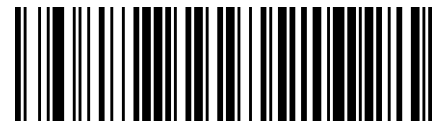

Plessey Length Control = No Check



### Plessey Set Length 1

This feature specifies one of the barcode lengths for Plessey Length Control on page 157. Length 1 is the minimum label length if in Variable Length on page 90 Mode, or the first fixed length if in Fixed Length on page 90 Mode. Length includes the barcode's data characters only. The length can be set from 01 to 50 characters. For more detailed programming instructions see, "Set Length" on Chapter 4, References.

Table 23 provides some examples for setting Length 1.

Table 23. Plessey Length 1 Setting Examples

STEP	ACTION	EXAMPLES			
1	Desired Setting	01 Characters	07 Characters	15 Characters	50 Characters
2	Scan ENTER/EXIT PROGRAMMING MODE				
3	Scan SELECT Plessey LENGTH 1 SETTING				
4	Scan Two Characters From Appendix C	'0' and '1'	'0' and '7'	'1' and '5'	'5' AND '0'
5	Scan ENTER/EXIT PROGRAMMING MODE				

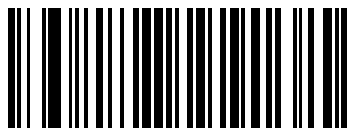

Select Plessey Set Length 1 Setting

Make a mistake? Scan the CANCEL barcode to abort and not save the entry string. You can then start again at the beginning.

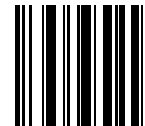

CANCEL



01 = Length 1 is 1 Character



## Plessey Set Length 2

This feature specifies one of the barcode lengths for Plessey Length Control on page 157. Length 2 is the maximum label length if in Variable Length on page 90 Mode, or the second fixed length if in Fixed Length on page 90 Mode. Length includes the barcode's check, data, and full-ASCII shift characters. The length does not include start/stop characters. For more detailed programming instructions see, "Set Length" on Chapter 4, References.

The length can be set from 1 to 50 characters. A setting of 0 specifies to ignore this length (only one fixed length).

Table 24 provides examples for setting Length 2.

**Table 24. Plessey Length 2 Setting Examples**

STEP	ACTION	EXAMPLES			
1	Desired Setting	00 (Ignore This Length)	07 Characters	15 Characters	50 Characters
2	Scan ENTER/EXIT PROGRAMMING MODE				
3	Scan SELECT PLESSEY LENGTH 2 SETTING				
4	Scan Two Characters From Appendix C	'0' and '0'	'0' and '7'	'1' and '5'	'5' AND '0'
5	Scan ENTER/EXIT PROGRAMMING MODE				

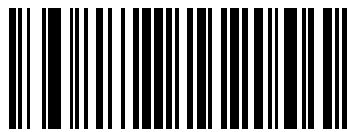

Select Plessey Length 2 Setting

Make a mistake? Scan the CANCEL barcode to abort and not save the entry string. You can then start again at the beginning.

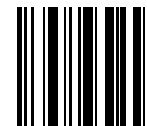

CANCEL



**50 = Length 2 is 50 Characters**



## 2D SYMBOLOGIES

<b>2D Global Features</b>
• <b>2D STRUCTURED APPEND</b> on page 162
• <b>2D NORMAL/INVERSE SYMBOL CONTROL</b> on page 163

The reader supports the following 2D symbologies (bar code types). Symbology-dependent options for each symbology are included in this chapter.

<b>2D Symbology Selection</b>
• <b>AZTEC CODE</b> on page 164
• <b>HAN XIN CODE</b> on page 168
• <b>DATA MATRIX</b> on page 172
• <b>MAXICODE</b> on page 177
• <b>PDF417</b> on page 181
• <b>MICRO PDF417</b> on page 184
• <b>QR CODE</b> on page 189
• <b>MICRO QR CODE</b> on page 192
• <b>UCC COMPOSITE</b> on page 196
• <b>POSTAL CODE SELECTION</b> on page 197



## 2D Global Features

The following features are common to all, or in some cases, most of the available 2D symbologies. Default settings are indicated at each feature/option with a green arrow. To set most features:

1. Scan the ENTER/EXIT PROGRAMMING bar code at the top of applicable programming pages.
2. Scan the correct bar code to set the desired programming feature or parameter. You may need to cover unused bar codes on the page, and possibly the facing page, to ensure that the reader reads only the bar code you intend to scan.
3. If additional input parameters are needed, go to [Appendix C](#), and scan the appropriate characters from the keypad.



### NOTE

**Additional information about many features can be found in the "References" chapter.**

**If you make a mistake before the last character, scan the CANCEL bar code to abort and not save the entry string. You can then start again at the beginning.**

Complete the programming sequence by scanning the ENTER/EXIT PROGRAMMING bar code to exit Programming Mode.



## 2D Structured Append

Enables/disables ability of reader to append multiple 2D Codes labels in a structured format. The structured append property is globally applied to the following symbologies, if these are enabled:

- Aztec
- Data Matrix
- PDF 417
- QR Code

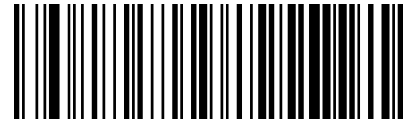
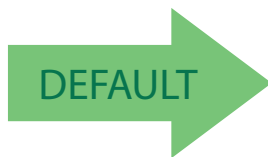

Structured Append = Disable



Structured Append = Enable



## 2D Normal/Inverse Symbol Control

Specifies the options available for decoding normal/negative printed 2D symbols. This configuration item applies globally to all the 2D symbologies that support that feature according to Standard AIM Specification: Data Matrix, QR, MicroQR, Aztec and Han Xin Code .

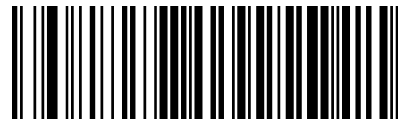

Normal/Inverse Symbol Control = Normal

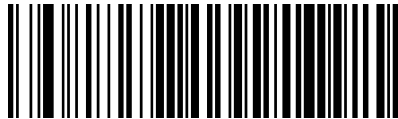

Normal/Inverse Symbol Control = Inverse

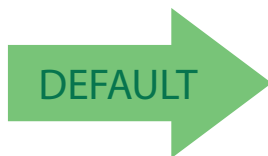

Normal/Inverse Symbol Control =  
Both Normal and Inverse



## 2D Symbology Selection

### AZTEC CODE

#### Aztec Code Enable / Disable

Enables/disables the ability of the reader to decode Aztec Code labels.

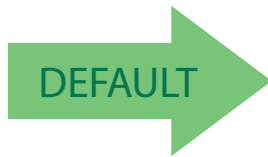

Aztec Code = Disable

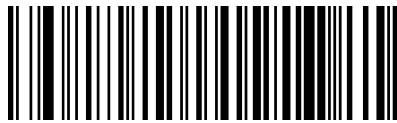

Aztec Code = Enable



## Aztec Code Length Control

This feature specifies either variable length decoding, fixed length decoding or no check length decoding for this symbology.

**Variable Length.** For variable length decoding, a minimum and maximum length may be set.

**Fixed Length.** For fixed length decoding, two different lengths may be set.



Aztec Code Length Control = Variable Length

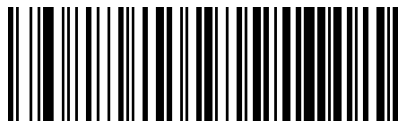

Aztec Code Length Control = Fixed Length

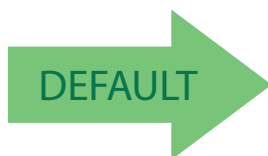

Aztec Code Length Control = No Check



## Aztec Code Set Length 1

Specifies one of the bar code lengths for Aztec Code. Length 1 is the minimum label length if in [Variable Length Mode](#), or the first fixed length if in [Fixed Length Mode](#). Characters can be set from 0001 to 3,832 characters in increments of 0001 (pad with zeroes). Always use four digits (e.g.: scan the barcodes '0', '0', '0', '2' for setting length = 2). For more detailed programming instructions see "Set Length" on [Chapter 4, References](#).



Select Aztec Code Length 1 Setting

To configure this feature, scan the ENTER/EXIT PROGRAMMING MODE bar code above, then the bar code at left followed by the digits from the Alphanumeric characters in [Appendix C](#) representing your desired character(s). End by scanning the ENTER/EXIT bar code again.

Make a mistake? Scan the CANCEL bar code to abort and not save the entry string. You can then start again at the beginning.

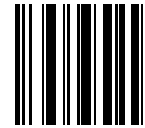

CANCEL

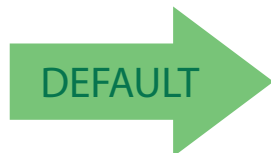

0001 = Length 1 is 1 Character



## Aztec Code Set Length 2

This feature specifies one of the bar code lengths for Aztec Code. Length 2 is the maximum label length if in Variable Length Mode, or the second fixed length if in Fixed Length Mode. Characters can be set from 0001 to 3,832 characters in increments of 0001 (pad with zeroes). Always use four digits (e.g.: scan the barcodes '0', '0', '0', '2' for setting length = 2). For more detailed programming instructions see, "Set Length" on [Chapter 4, References](#).



Select Aztec Code Length 2 Setting

To configure this feature, scan the ENTER/EXIT PROGRAMMING MODE bar code above, then the bar code at left followed by the digits from the Alphanumeric characters in [Appendix C](#) representing your desired character(s). End by scanning the ENTER/EXIT bar code again.

Make a mistake? Scan the CANCEL bar code to abort and not save the entry string. You can then start again at the beginning.

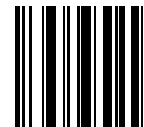

CANCEL

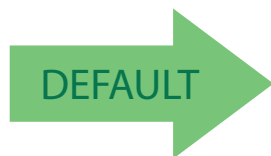

**Length 2 is 3,832 Characters**



## HAN XIN CODE

### Han Xin Code Enable / Disable

Enables/disables the ability of the reader to decode Han Xin Code labels.

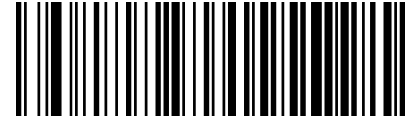
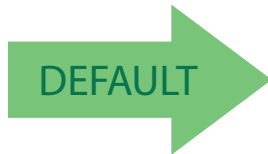

Han Xin Code = Disable



Han Xin Code = Enable



## Han Xin Code: Code Length Control

This feature specifies either variable length decoding, fixed length decoding or no check length decoding for this symbology.

**Variable Length.** For variable length decoding, a minimum and maximum length may be set.

**Fixed Length.** For fixed length decoding, two different lengths may be set.

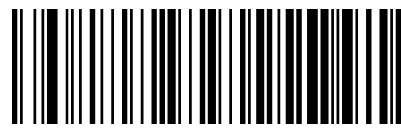

Han Xin Code Length Control = Variable Length

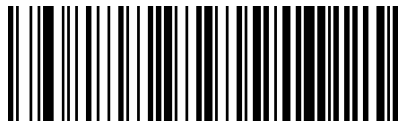

Han Xin Code Length Control = Fixed Length



Han Xin Code Length Control = No Check



## Han Xin Code Set Length 1

Specifies one of the bar code lengths for Han Xin Code. Length 1 is the minimum label length if in **Variable Length Mode**, or the first fixed length if in **Fixed Length Mode**. Characters can be set from 0001 to 7,827 characters in increments of 0001 (pad with zeroes). Always use four digits (e.g.: scan the barcodes '0', '0', '0', '2' for setting length = 2). For more detailed programming instructions see, "Set Length" on [Chapter 4, References](#).



Select Han Xin Code Length 1 Setting

To configure this feature, scan the ENTER/EXIT PROGRAMMING MODE bar code above, then the bar code at left followed by the digits from the Alphanumeric characters in [Appendix C](#) representing your desired character(s). End by scanning the ENTER/EXIT bar code again.

Make a mistake? Scan the CANCEL bar code to abort and not save the entry string. You can then start again at the beginning.

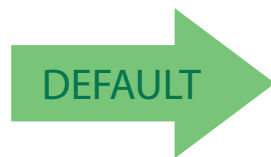

**0001 = Length 1 is 1 Character**



## Han Xin Code Set Length 2

This feature specifies one of the bar code lengths for Han Xin Code. Length 2 is the maximum label length if in Variable Length Mode, or the second fixed length if in Fixed Length Mode. Characters can be set from 0001 to 7,827 characters in increments of 0001 (pad with zeroes). Always use four digits (e.g.: scan the barcodes '0', '0', '0', '2' for setting length = 2). For more detailed programming instructions see, "Set Length" on [Chapter 4, References](#).



Select Han Xin Code Length 2 Setting

To configure this feature, scan the ENTER/EXIT PROGRAMMING MODE bar code above, then the bar code at left followed by the digits from the Alphanumeric characters in [Appendix C](#) representing your desired character(s). End by scanning the ENTER/EXIT bar code again.

Make a mistake? Scan the CANCEL bar code to abort and not save the entry string. You can then start again at the beginning.

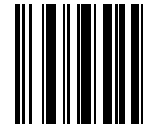

CANCEL

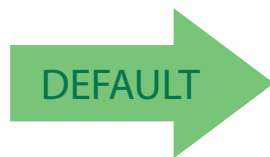

**Length 2 is 7,827 Characters**



## DATA MATRIX

### Data Matrix Enable / Disable

Enables/disables ability of reader to decode Data Matrix labels.



Data Matrix = Disable



Data Matrix = Enable





## Data Matrix Square/Rectangular Style

Specifies the options available when reading Data Matrix with different form factors. Choices are:

- Square Style
- Rectangular Style
- Both Square and Rectangular Style

The configuration item can also be configured as a bit mask to filter one or more Data Matrix labels with different symbol size AND shape styles.



Data Matrix Dimensions Mask = Square Style

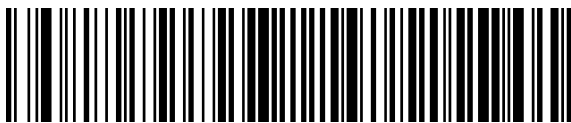

Data Matrix Dimensions Mask = Rectangular Style

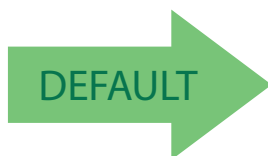

Data Matrix Dimensions Mask =  
Both Square and Rectangular Style



## Data Matrix Length Control

This feature specifies either variable length decoding, fixed length decoding or no check length decoding for this symbology.

**Variable Length.** For variable length decoding, a minimum and maximum length may be set.

**Fixed Length.** For fixed length decoding, two different lengths may be set.



Data Matrix Length Control = Variable Length



Data Matrix Length Control = Fixed Length



Data Matrix Length Control = No Check



## Data Matrix Set Length 1

Specifies one of the bar code lengths for Data Matrix. Length 1 is the minimum label length if in **Variable Length Mode**, or the first fixed length if in **Fixed Length Mode**. Characters can be set from 0001 to 3,116 characters in increments of 0001 (pad with zeroes). Always use four digits (e.g.: scan the barcodes '0', '0', '0', '2' for setting length = 2). For more detailed programming instructions see "Set Length" on [Chapter 4, References](#).



Select Data Matrix Length 1 Setting

To configure this feature, scan the ENTER/EXIT PROGRAMMING MODE bar code above, then the bar code at left followed by the digits from the Alphanumeric characters in [Appendix C](#) representing your desired character(s). End by scanning the ENTER/EXIT bar code again.

Make a mistake? Scan the CANCEL bar code to abort and not save the entry string. You can then start again at the beginning.

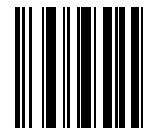

CANCEL

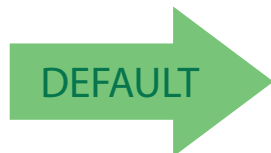

**0001 = Length 1 is 1 Character**



## Data Matrix Set Length 2

This feature specifies one of the bar code lengths for Data Matrix. Length 2 is the maximum label length if in Variable Length Mode, or the second fixed length if in Fixed Length Mode. Characters can be set from 0001 to 3,116 characters in increments of 0001 (pad with zeroes). Always use four digits (e.g.: scan the barcodes '0', '0', '0', '2' for setting length = 2). For detailed programming instructions see, "Set Length" on [Chapter 4, References](#).



Select Data Matrix Length 2 Setting

To configure this feature, scan the ENTER/EXIT PROGRAMMING MODE bar code above, then the bar code at left followed by the digits from the Alphanumeric characters in [Appendix C](#) representing your desired character(s). End by scanning the ENTER/EXIT bar code again.

Make a mistake? Scan the CANCEL bar code to abort and not save the entry string. You can then start again at the beginning.

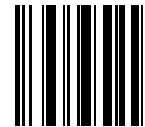

CANCEL



**Length 2 is 3,116 Characters**



## MAXICODE

### Maxicode Enable / Disable

Enables/disables ability of reader to decode Maxicode labels.

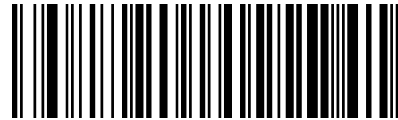
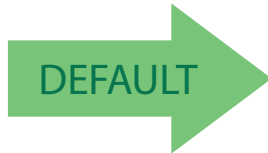

Maxicode = Disable



Maxicode = Enable

### Maxicode Primary Message Transmission

Enables/disables the transmission of only the Primary Message when the Secondary Message is not readable.



Maxicode Primary Message Transmission = Disable



Maxicode Primary Message Transmission = Enable



## Maxicode Length Control

This feature specifies either variable length decoding, fixed length decoding or no check length decoding for this symbology.

**Variable Length.** For variable length decoding, a minimum and maximum length may be set.

**Fixed Length.** For fixed length decoding, two different lengths may be set.

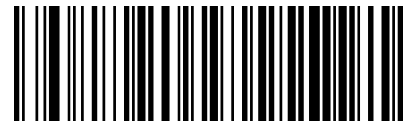

Maxicode Length Control = Variable Length

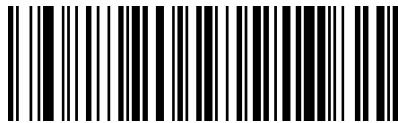

Maxicode Length Control = Fixed Length

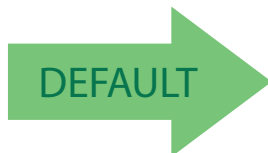

Maxicode Length Control = No Check



## Maxicode Set Length 1

Specifies one of the bar code lengths for Maxicode. Length 1 is the minimum label length if in **Variable Length Mode**, or the first fixed length if in **Fixed Length Mode**. Characters can be set from 0001 to 0145 characters in increments of 0001 (pad with zeroes). Always use four digits (e.g.: scan the barcodes '0', '0', '0', '2' for setting length = 2). For more detailed programming instructions see, "Set Length" on [Chapter 4, References](#).



Select Maxicode Length 1 Setting

To configure this feature, scan the ENTER/EXIT PROGRAMMING MODE bar code above, then the bar code at left followed by the digits from the Alphanumeric characters in [Appendix C](#) representing your desired character(s). End by scanning the ENTER/EXIT bar code again.

Make a mistake? Scan the CANCEL bar code to abort and not save the entry string. You can then start again at the beginning.

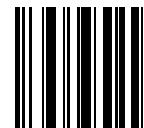

CANCEL

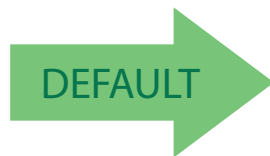

0001 = Length 1 is 1 Character



## Maxicode Set Length 2

This feature specifies one of the bar code lengths for Maxicode. Length 2 is the maximum label length if in Variable Length Mode, or the second fixed length if in Fixed Length Mode. Characters can be set from 0001 to 0145 characters in increments of 0001 (pad with zeroes). Always use four digits (e.g.: scan the barcodes '0', '0', '0', '2' for setting length = 2). For more detailed programming instructions see, "Set Length" on [Chapter 4, References](#).



Select Maxicode Length 2 Setting

To configure this feature, scan the ENTER/EXIT PROGRAMMING MODE bar code above, then the bar code at left followed by the digits from the Alphanumeric characters in [Appendix C](#) representing your desired character(s). End by scanning the ENTER/EXIT bar code again.

Make a mistake? Scan the CANCEL bar code to abort and not save the entry string. You can then start again at the beginning.



**Length 2 is 0145 Characters**



## PDF417

### PDF417 Enable / Disable

Enables/disables the ability of the reader to decode PDF417 labels.

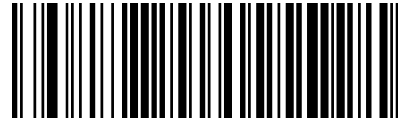

PDF417 = Disable



PDF417 = Enable



### PDF417 Length Control

This feature specifies either variable length decoding, fixed length decoding or no check length decoding for this symbology.

**Variable Length.** For variable length decoding, a minimum and maximum length may be set.

**Fixed Length.** For fixed length decoding, two different lengths may be set.



PDF417 Length Control = Variable Length



PDF417 Length Control = Fixed Length

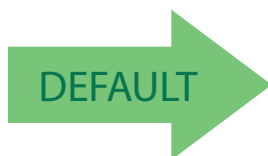

PDF417 Length Control = No Check



## PDF417 Set Length 1

Specifies one of the bar code lengths for PDF417. Length 1 is the minimum label length if in [Variable Length Mode](#), or the first fixed length if in Fixed Length Mode. Length includes the bar code's data characters only. Characters can be set from 0001 to 2,710 characters (pad with zeroes) in increments of 01. Any value greater than 2,710 will be considered to be 2,710. Always use four digits (e.g.: scan the barcodes '0', '0', '0', '2' for setting length = 2). For more detailed programming instructions see "Set Length" on [Chapter 4, References](#).



Select PDF417 Length 1 Setting

To configure this feature, scan the ENTER/EXIT PROGRAMMING MODE bar code above, then the bar code at left followed by the digits from the Alphanumeric characters in [Appendix C](#) representing your desired character(s). End by scanning the ENTER/EXIT bar code again.

Make a mistake? Scan the CANCEL bar code to abort and not save the entry string. You can then start again at the beginning.

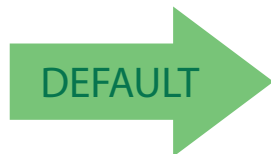

0001 = Length 1 is 1 Character



## PDF417 Set Length 2

This feature specifies one of the bar code lengths for PDF417. Length 2 is the maximum label length if in Variable Length Mode, or the second fixed length if in Fixed Length Mode. Length includes the bar code's check, data, and full-ASCII shift characters. The length does not include start/stop characters. Characters can be set from 01 to 2,710 characters (pad with zeroes) in increments of 01. Any value greater than 2,710 will be considered to be 2,710. Always use four digits (e.g.: scan the barcodes '0', '0', '0', '2' for setting length = 2). For more detailed programming instructions see, "Set Length" on [Chapter 4, References](#).



Select PDF417 Length 2 Setting

To configure this feature, scan the ENTER/EXIT PROGRAMMING MODE bar code above, then the bar code at left followed by the digits from the Alphanumeric characters in [Appendix C](#) representing your desired character(s). End by scanning the ENTER/EXIT bar code again.

Make a mistake? Scan the CANCEL bar code to abort and not save the entry string. You can then start again at the beginning.

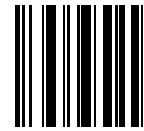

CANCEL

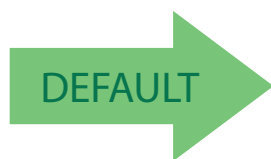

**Length 2 is 2,710 Characters**



## MICRO PDF417

### Micro PDF417 Enable / Disable

Enables/disables the ability of the reader to decode Micro PDF417 labels.

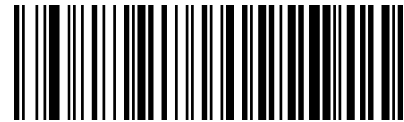
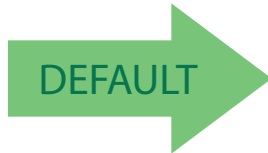

Micro PDF417 = Disable

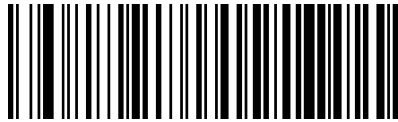

Micro PDF417 = Enable



## Micro PDF417 Code 128 GS1-128 Emulation

Specifies which AIM ID to use for MicroPDF labels when doing Code 128 or GS1-128 emulation.

Emulation choices are:

- Micro PDF AIM ID and label type
- Code 128 / EAN128 AIM Id and label type

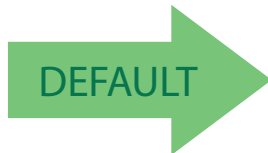

Micro PDF417 Code 128 GS1-128 Emulation =  
Micro PDF AIM ID and label type



Micro PDF417 Code 128 GS1-128 Emulation =  
Code 128 / EAN128 AIM ID and label type



## Micro PDF417 Length Control

This feature specifies either variable length decoding, fixed length decoding or no check length decoding for this symbology.

**Variable Length.** For variable length decoding, a minimum and maximum length may be set.

**Fixed Length.** For fixed length decoding, two different lengths may be set.

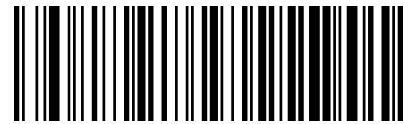

Micro PDF417 Length Control = Variable Length

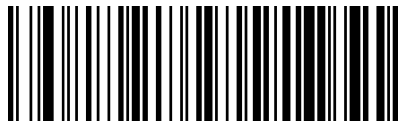

Micro PDF417 Length Control = Fixed Length

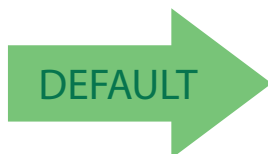

Micro PDF417 Length Control = No Check



## Micro PDF417 Set Length 1

Specifies one of the bar code lengths for Micro PDF417. Length 1 is the minimum label length if in [Variable Length Mode](#), or the first fixed length if in Fixed Length Mode. Length includes the bar code's data characters only. Characters can be set from 0001 to 0366 characters (pad with zeroes) in increments of 01. Any value greater than 0366 will be considered to be 0366. Always use four digits (e.g.: scan the barcodes '0', '0', '0', '2' for setting length = 2). For more detailed programming instructions see, "Set Length" on [Chapter 4, References](#).



Select Micro PDF417 Length 1 Setting

To configure this feature, scan the ENTER/EXIT PROGRAMMING MODE bar code above, then the bar code at left followed by the digits from the Alphanumeric characters in [Appendix C](#) representing your desired character(s). End by scanning the ENTER/EXIT bar code again.

Make a mistake? Scan the CANCEL bar code to abort and not save the entry string. You can then start again at the beginning.

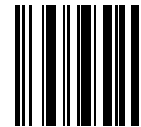

CANCEL

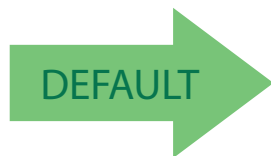

0001 = Length 1 is 1 Character



## Micro PDF417 Set Length 2

This feature specifies one of the bar code lengths for Micro PDF417. Length 2 is the maximum label length if in Variable Length Mode, or the second fixed length if in Fixed Length includes the bar code's data characters only. Characters can be set from 0001 to 0366 characters (pad with zeroes) in increments of 01. Any value greater than 0366 will be considered to be 0366. Always use four digits (e.g.: scan the barcodes '0', '0', '0', '2' for setting length = 2). For more detailed programming instructions see, "Set Length" on [Chapter 4, References](#).



Select Micro PDF417 Length 2 Setting

To configure this feature, scan the ENTER/EXIT PROGRAMMING MODE bar code above, then the bar code at left followed by the digits from the Alphanumeric characters in [Appendix C](#) representing your desired character(s). End by scanning the ENTER/EXIT bar code again.

Make a mistake? Scan the CANCEL bar code to abort and not save the entry string. You can then start again at the beginning.

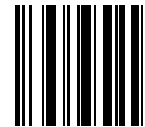

CANCEL

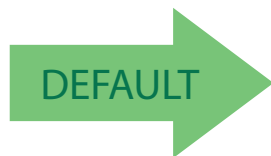

**Length 2 is 0366 Characters**



## QR CODE

### QR Code Enable / Disable

Enables/disables the ability of the reader to decode QR Code labels.

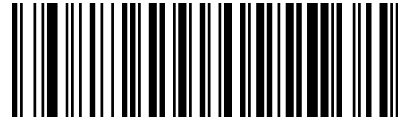

QR Code = Disable



QR Code = Enable

### QR Code Length Control

This feature specifies either variable length decoding, fixed length decoding or no check length decoding for this symbology.

**Variable Length.** For variable length decoding, a minimum and maximum length may be set.

**Fixed Length.** For fixed length decoding, two different lengths may be set.



QR Code Length Control = Variable Length



QR Code Length Control = Fixed Length

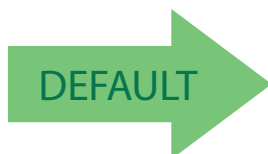

QR Code Length Control = No Check



## QR Code Set Length 1

Specifies one of the bar code lengths for QR Code Length Control on page 189. Length 1 is the minimum label length if in Variable Length Mode, or the first fixed length if in Fixed Length Mode. Characters can be set from 0001 to 7,089 characters in increments of 0001 (pad with zeroes). Always use four digits (e.g.: scan the barcodes '0', '0', '0', '2' for setting length = 2). For more detailed programming instructions see, "Set Length" on Chapter 4, References.



Select QR Code Length 1 Setting

To configure this feature, scan the ENTER/EXIT PROGRAMMING MODE bar code above, then the bar code at left followed by the digits from the Alphanumeric characters in Appendix C representing your desired character(s). End by scanning the ENTER/EXIT bar code again.

Make a mistake? Scan the CANCEL bar code to abort and not save the entry string. You can then start again at the beginning.

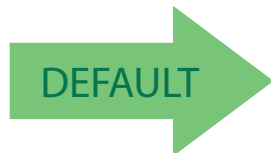

0001 = Length 1 is 1 Character



## QR Code Set Length 2

This feature specifies one of the bar code lengths for [QR Code Length Control on page 189](#). Length 2 is the maximum label length if in Variable Length Mode, or the second fixed length if in Fixed Length Mode. Characters can be set from 0001 to 7,089 characters in increments of 0001 (pad with zeroes). Always use four digits (e.g.: scan the barcodes '0', '0', '0', '2' for setting length = 2). For more detailed programming instructions see, "Set Length" on [Chapter 4, References](#).



Select QR Code Length 2 Setting

To configure this feature, scan the ENTER/EXIT PROGRAMMING MODE bar code above, then the bar code at left followed by the digits from the Alphanumeric characters in [Appendix C](#) representing your desired character(s). End by scanning the ENTER/EXIT bar code again.

Make a mistake? Scan the CANCEL bar code to abort and not save the entry string. You can then start again at the beginning.

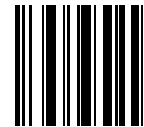

CANCEL

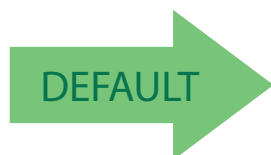

**Length 2 is 7,089 Characters**



## MICRO QR CODE

### Micro QR Code Enable/Disable

Enables/disables the ability of the reader to decode Micro QR Code labels.

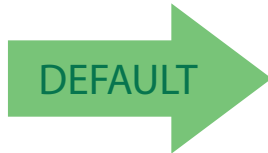

Micro QR Code = Disable

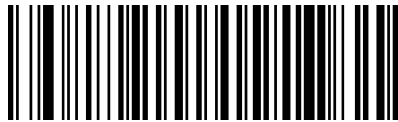

Micro QR Code = Enable



## Micro QR Code Length Control

This feature specifies either variable length decoding, fixed length decoding or no check length decoding for this symbology.

**Variable Length.** For variable length decoding, a minimum and maximum length may be set.

**Fixed Length.** For fixed length decoding, two different lengths may be set.



Micro QR Code Length Control = Variable Length

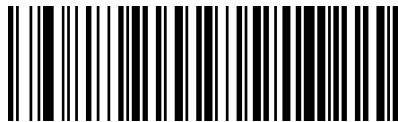

Micro QR Code Length Control = Fixed Length



Micro QR Code Length Control = No Check



## Micro QR Code Set Length 1

Specifies one of the bar code lengths for Micro QR Code. Length 1 is the minimum label length if in [Variable Length Mode](#), or the first fixed length if in [Fixed Length Mode](#). Characters can be set from 0001 to 0035 characters in increments of 0001 (pad with zeroes). Always use four digits (e.g.: scan the barcodes '0', '0', '0', '2' for setting length = 2). For more detailed programming instructions see, "Set Length" on [Chapter 4, References](#).



Select Micro QR Code Length 1 Setting

To configure this feature, scan the ENTER/EXIT PROGRAMMING MODE bar code above, then the bar code at left followed by the digits from the Alphanumeric characters in [Appendix C](#) representing your desired character(s). End by scanning the ENTER/EXIT bar code again.

Make a mistake? Scan the CANCEL bar code to abort and not save the entry string. You can then start again at the beginning.



CANCEL

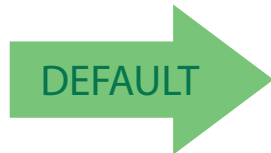

**0001 = Length 1 is 1 Character**



## Micro QR Code Set Length 2

This feature specifies one of the bar code lengths for Micro QR Code. Length 2 is the maximum label length if in Variable Length Mode, or the second fixed length if in Fixed Length Mode. Characters can be set from 0001 to 0035 characters in increments of 0001 (pad with zeroes). Always use four digits (e.g.: scan the barcodes '0', '0', '0', '2' for setting length = 2). For more detailed programming instructions see, "Set Length" on [Chapter 4, References](#).

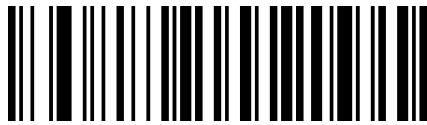

Select Micro QR Code Length 2 Setting

To configure this feature, scan the ENTER/EXIT PROGRAMMING MODE bar code above, then the bar code at left followed by the digits from the Alphanumeric characters in [Appendix C](#) representing your desired character(s). End by scanning the ENTER/EXIT bar code again.

Make a mistake? Scan the CANCEL bar code to abort and not save the entry string. You can then start again at the beginning.

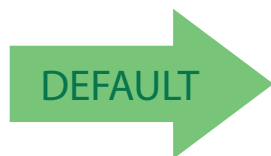

Length 2 is 0035 Characters



## UCC COMPOSITE

### UCC Optional Composite Timer

Specifies the amount of time the system will wait for the stacked part of a UCC Composite label before transmitting the linear label without an add-on.



UCC Optional Composite Timer = Timer Disabled



UCC Optional Composite Timer = 100msec



UCC Optional Composite Timer = 200msec



UCC Optional Composite Timer = 300msec



UCC Optional Composite Timer = 400msec



UCC Optional Composite Timer = 500msec



## POSTAL CODE SELECTION

Enables/disables the ability of the scanner to decode labels of a specific postal symbology.

- Postnet
- Planet
- Royal Mail
- Kix
- Australian Post
- Japanese Post
- IMB
- Swedish Post
- Portuguese Post
- PostNet BB
- NewZealand Postal



PostNet = Enable



PostNet = Disable



Planet = Enable



Planet = Disable



RoyalMail = Enable



RoyalMail = Disable





## Postal Code Selection (continued)



Kix = Disable



Kix = Enable

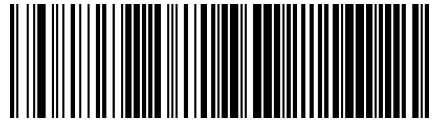

Australian Post = Enable

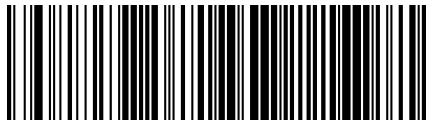

Australian Post = Disable



Japanese Post = Enable



Japanese Post = Disable





## Postal Code Selection (continued)



IMB Post = Disable



IMB Post = Enable

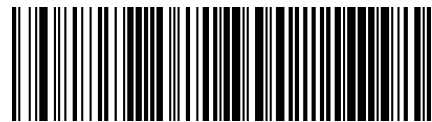

Swedish Postal = Enable

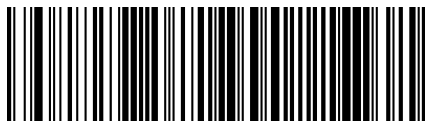

Swedish Postal = Disable



Portugal Post = Enable



Portugal Post = Disable



### Postnet BB Control

Controls the ability of the scanner to decode B and B' fields of Postnet labels.



PostNet BB = Enable



PostNet BB = Disable

### NewZealand Postal Control

Controls the ability of the scanner to decode NewZealand Postal labels.

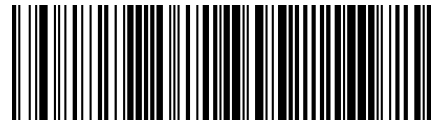

NewZealand Postal = Enable



NewZealand Postal = Disable



## Chapter 4 References

This section contains explanations and examples of selected bar code features. See [Configuration Using Bar Codes on page 15](#) for the actual bar code labels used to configure the scanner.

<b>RS-232 PARAMETERS</b> on page 201 <ul style="list-style-type: none"><li>▪ <a href="#">RS-232 Only on page 201</a></li></ul>
<b>DATA FORMAT</b> on page 203 <ul style="list-style-type: none"><li>▪ <a href="#">Data Editing on page 203</a></li><li>▪ <a href="#">Global Prefix/Suffix on page 204</a></li><li>▪ <a href="#">Global AIM ID on page 205</a></li></ul>
<b>SCANNING FEATURES</b> on page 206 <ul style="list-style-type: none"><li>▪ <a href="#">Scanning Features on page 206</a></li></ul>
<b>SCANNING FEATURES</b> on page 206 <ul style="list-style-type: none"><li>▪ <a href="#">Scan Mode on page 206</a></li><li>▪ <a href="#">Flash On Time on page 207</a></li><li>▪ <a href="#">Flash Off Time on page 208</a></li></ul>
<b>SYMBOLOGIES</b> on page 209 <ul style="list-style-type: none"><li>▪ <a href="#">Set Length on page 209</a></li><li>▪ <a href="#">Set Length on page 209</a></li></ul>

### RS-232 Parameters

#### RS-232 Only

##### Baud Rate

Baud rate is the number of bits of data transmitted per second. Set the scanner's baud rate to match the baud rate setting of the host device. With an improper baud rate setting, data may not reach the host correctly.

### Data Bits

This parameter allows the reader to interface with devices requiring a 7-bit or 8-bit ASCII protocol for sending and receiving data.

### Stop Bits

The stop bit(s) at the end of each transmitted character marks the end of transmission of one character and prepares the receiving device for the next character in the serial data stream. The number of stop bits selected (one or two) depends on the number the receiving terminal is programmed to accommodate. Set the number of stop bits to match host device requirements.

### Parity

This feature specifies parity required for sending and receiving data. A parity check bit is the most significant bit of each ASCII coded character. Select the parity type according to host device requirements.

- Select None when no parity bit is required.
- Select Odd parity and the parity bit value is set to 0 or 1, based on data, to ensure that an odd number of 1 bits are contained in the coded character.
- Select Even parity [ASCII Chart on page 229](#) the parity bit value is set to 0 or 1, based on data, to ensure that an even number of 1 bits are contained in the coded character.

### Handshaking Control

The data interface consists of an RS-232 port designed to operate either with or without the hardware handshaking lines, Request to Send (RTS), and Clear to Send (CTS). Handshaking Control includes the following options:

- – None – no hardware handshaking lines, only TX and RX communication lines are used.
- RTS — RTS is asserted during transmissions. CTS is ignored.
- RTS/CTS — RTS is asserted during transmissions. CTS gates transmissions.
- RTS On/CTS — RTS is always asserted. CTS gates transmissions.

## Data Format

### Data Editing

When a bar code is scanned, additional information can be sent to the host computer along with the bar code data. This combination of bar code data and supplementary user-defined data is called a “message string.” The Data Editing features can be used to build specific user-defined data into a message string. There are several types of selectable data characters that can be sent before and after scanned data. You can specify if they should be sent with all symbologies, or only with specific symbologies. The following shows the available elements you can add to a message string:

Figure 1. Breakdown of a Message String

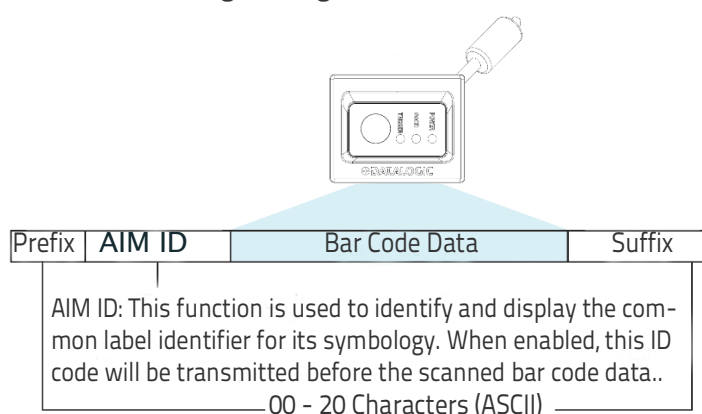

#### NOTE

Additional advanced editing is available. Contact Technical Support (see page 3) for more information.

#### Please Keep In Mind...

- Modifying a message string is not a mandatory requirement. Data editing is a sophisticated feature allowing highly customizable output for advanced users. Factory default settings for data editing is typically set to NONE.
- A prefix or suffix may be applied across all symbologies (set via the Global features in [Configuration Using Bar Codes on page 15](#)).
- You can add any character from the [ASCII Chart on page 229](#) (from 00–FF) on the inside back cover of this manual as a prefix or suffix.
- Enter prefixes and suffixes in the order in which you want them to appear on the output.

---

## Global Prefix/Suffix

Up to 20 ASCII characters may be added as a prefix (in a position before the bar code data) and/or as a suffix (in a position following the bar code data) as indicated.

### Example: Setting a Prefix

In this example, we'll set a prefix for all symbologies.

1. Determine which ASCII character(s) are to be added to scanned bar code data. In this example, we'll add a dollar sign ('\$') as a prefix.
2. Go to [page 50](#) and scan the ENTER/EXIT PROGRAMMING MODE bar code, then scan the SET GLOBAL PREFIX bar code.
3. Reference the [ASCII Chart on page 229](#) on the inside back cover of this manual to find the hex value assigned to the desired character. The corresponding hex number for the '\$' character is 24. To enter this selection code, scan the '2' and '4' bar codes from [Appendix C](#).



#### NOTE

If you make a mistake before the last character, scan the CANCEL bar code to abort and not save the entry string. You can then start again at the beginning.

4. If less than the expected string of 20 characters are selected, scan the ENTER/EXIT bar code to terminate the string.
5. Scan the ENTER/EXIT bar code once again to exit Programming Mode.
6. The resulting message string would appear as follows:  
Scanned bar code data: **12345**  
Resulting message string output: **\$12345**

## Global AIM ID



This feature enables/disables addition of AIM IDs for all symbology types.

### NOTE

AIM label identifiers (as opposed to custom characters you select yourself as with label identifiers) can be included with scanned bar code data. AIM label identifiers consist of three characters as follows:

- A close brace character (ASCII ']'), followed by...
- A code character (see the table below), followed by...
- A modifier character (the modifier character is symbol dependent).

SYMBOLGY	CHAR	SYMBOLGY	CHAR
UPC/EAN	E <sup>a</sup>	Code 128/GS1-128	C
Code 39 and Code 32	A	DataBar Omnidirectional, DataBar Expanded	e
Codabar	F	Standard 2 of 5	S
Interleaved 2 of 5	I	ISBN	X <sup>b</sup>
Code 93	G	Code 11	H

- UPC-A and UPC-E labels are converted to EAN 13 when adding AIM IDs.
- ISBN (X with a 0 modifier character)

---

## Scanning Features

### Scan Mode

Selects the scan operating mode for the reader. Selections are:

**Trigger Single:** scanning is activated when the button is pushed or through a DESP command or through an external trigger (DSB045X models only). When the device is triggered, AIM and illumination are turned on and the scanner attempts to read a label. Scanning is activated until one of the following events occurs:

- the programmable Scanning Active Time has elapsed.
- a label has been read
- the trigger is deactivated (button released, stop command, external trigger line low.)

**Trigger Hold Multiple :** When the trigger is pulled, scanning starts and the product scans until the trigger is released or **Scanning Active Time** has elapsed. Reading a label does not disable scanning. **Double Read Timeout** prevents undesired multiple reads of the same label while in this mode.

**Trigger Pulse Multiple:** When the trigger is pulled, continuous scanning is activated until **Scanning Active Time** has elapsed or the trigger has been released and pulled again. **Double Read Timeout** prevents undesired multiple reads of the same label while in this mode.

**Flashing:** The reader flashes<sup>1</sup> on and off regardless of the trigger status. Flash rate is controlled by **Flash On Time** and **Flash Off Time**. When Flash is ON the reader reads continuously. When Flash is OFF scanning is deactivated.

**Always On:** No trigger pull is required to read a bar code. Scanning is continuously on. **Double Read Timeout** prevents undesired multiple reads of the same label while in this mode.



CAUTION

**IMPORTANT:** Always On mode is not recommended for continuous and prolonged operations. Use Stand Mode (Automatic - Object Sense.). If you use Always On mode, make sure that DSM0400 is installed and mounted in the correct way for heat dissipation (e.g.:metal brackets or supports are recommended.)

**Stand Mode:** No trigger is required to read a bar code. Scanning turns on automatically when an item is placed in reader's field of view. While in this mode, the reader AIM is always on. The illumination LED goes off to on when a movement is detected in the field of view.

<sup>1</sup>Controlled by **Flash On Time**.

## Flash On Time

This feature specifies the ON time for the indicator LED while in Flash Mode. The selectable range is 100 to 9,900 milliseconds (0.1 to 9.9 seconds), in 100 millisecond increments.

Follow these instructions to set this feature.

1. Determine the desired setting in milliseconds.
2. Divide the desired setting by 100 (setting is in 100ms increments). Pad the result with leading zeroes to yield two digits. For example: 0 = 00, 5 = 05, 20 = 20, etc.
3. Scan the ENTER/EXIT PROGRAMMING MODE bar code to enter Programming Mode.
4. Scan the bar code: SELECT FLASH ON TIME SETTING on [page 60](#)
5. Scan the appropriate two digits from the keypad in [Appendix C](#) representing the duration which was determined in the steps above. You will hear a two-beep indication after the last character.



### NOTE

If you make a mistake before the last character, scan the CANCEL bar code to abort and not save the entry string. You can then start again at the beginning.

6. Scan the ENTER/EXIT PROGRAMMING MODE bar code to exit Programming Mode.

This completes the procedure. See the table below for examples of how to set this feature.

**Table 1. Flash On Time Setting Examples**

STEP	ACTION	EXAMPLES			
1	Desired Setting	500ms	1,000ms (1 sec.)	5200ms (5.2 sec.)	9,900ms (9.9 sec.)
2	Divide by 100 (and pad with leading zeroes to yield two digits)	05	10	52	99
3	Scan ENTER/EXIT PROGRAMMING MODE				
4	Scan SELECT FLASH ON TIME SETTING				
5	Scan Two Characters From Appendix C	'0' and '5'	'1' and '0'	'5' and '2'	'9' and '9'
6	Scan ENTER/EXIT PROGRAMMING MODE				

## Flash Off Time

This feature specifies the OFF time for the indicator LED while in Flash Mode. The selectable range is 100 to 9,900 milliseconds (0.1 to 9.9 seconds), in 100 millisecond increments.

Follow these instructions to set this feature.

1. Determine the desired setting in milliseconds.
2. Divide the desired setting by 100 (setting is in 100ms increments). Pad the result with leading zeroes to yield two digits. For example: 0 = 00, 5 = 05, 20 = 20, etc.
3. Scan the ENTER/EXIT PROGRAMMING MODE bar code to enter Programming Mode.
4. Scan the bar code: SELECT FLASH OFF TIME SETTING on [page 61](#).
5. Scan the appropriate two digits from the keypad in [Appendix C](#), that represent the duration which was determined in the steps above. You will hear a two-beep indication after the last character.



### NOTE

If you make a mistake before the last character, scan the CANCEL bar code to abort and not save the entry string. You can then start again at the beginning.

6. Scan the ENTER/EXIT PROGRAMMING MODE bar code to exit Programming Mode.

This completes the procedure. See the table below for examples of how to set this feature.

**Table 2. Flash Off Time Setting Examples**

STEP	ACTION	EXAMPLES			
1	Desired Setting	500ms	1,000ms (1 sec.)	5200ms (5.2 sec.)	9,900ms (9.9 sec.)
2	Divide by 100 (and pad with leading zeroes to yield two digits)	05	10	52	99
3	Scan ENTER/EXIT PROGRAMMING MODE				
4	Scan SELECT FLASH OFF TIME SETTING				
5	Scan Two Characters From Appendix C	'0' and '5'	'1' and '0'	'5' and '2'	'9' and '9'
6	Scan ENTER/EXIT PROGRAMMING MODE				

# Symbologies

## Set Length

Length Control allows you to select either variable length decoding or fixed length decoding for the specified symbology.

**Variable Length:** For variable length decoding, a minimum and maximum length may be set.

**Fixed Length:** For fixed length decoding, two different lengths may be set.

### Set Length 1

This feature specifies one of the bar code lengths for a given symbology. Length 1 is the minimum label length if in Variable Length Mode, or the first fixed length if in Fixed Length Mode.

Reference the [1D Symbologies on page 70](#) section to view the selectable range (number of characters) for the symbology being set.

Follow these instructions to set this feature:

1. Determine the desired character length. Pad the number with leading zeroes to yield two digits. For example: 0 = 00, 5 = 05, 20 = 20, etc.
2. Scan the ENTER/EXIT PROGRAMMING MODE bar code to enter Programming Mode.
3. Scan the “Select Length 1 Setting” for the symbology being set.
4. Scan the appropriate two digits from the keypad in [Appendix C](#), that represent the length setting which was determined in the steps above. You will hear a two-beep indication after the last character.



#### NOTE

If you make a mistake before the last character, scan the CANCEL bar code to abort and not save the entry string. You can then start again at the beginning.

5. Scan the ENTER/EXIT PROGRAMMING MODE bar code to exit Programming Mode.

This completes the procedure. See the table below for examples of how to set this feature.

**Table 3. Length 1 Setting Examples**

STEP	ACTION	EXAMPLES			
1	Desired Setting	01 Character	07 Characters	52 Characters	74 Characters
2	Scan ENTER/EXIT PROGRAMMING MODE				
3	Scan SELECT LENGTH 1SETTING for the desired symbology				
4	Scan Two Characters From Appendix C	'0' and '1'	'0' and '7'	'5' and '2'	'7' AND '4'
5	Scan ENTER/EXIT PROGRAMMING MODE				

## Set Length 2

This feature specifies one of the bar code lengths for a given symbology. Length 2 is the maximum label length if in Variable Length Mode, or the second fixed length if in Fixed Length Mode.

Reference the [1D Symbologies on page 69](#) section to view the selectable range (number of characters) for the symbology being set. A setting of 00 specifies to ignore this length (only one fixed length).

Follow these instructions to set this feature:

1. Determine the desired character length. Pad the number with leading zeroes to yield two digits. For example: 0 = 00, 5 = 05, 20 = 20, etc.
2. Scan the ENTER/EXIT PROGRAMMING MODE bar code to enter Programming Mode.
3. Scan the “Select Length 2 Setting” for the symbology being set.
4. Scan the appropriate two digits from the keypad in [Appendix C](#), that represent the length setting which was determined in the steps above. You will hear a two-beep indication after the last character.



### NOTE

If you make a mistake before the last character, scan the CANCEL bar code to abort and not save the entry string. You can then start again at the beginning.

5. Scan the ENTER/EXIT PROGRAMMING MODE bar code to exit Programming Mode.

This completes the procedure. See the table below for examples of how to set this feature.

**Table 4 Length 2 Setting Examples**

STEP	ACTION	EXAMPLES			
1	Desired Setting	00 (ignore second length)	07 Characters	52 Characters	74 Characters
2	Scan ENTER/EXIT PROGRAMMING MODE				
3	Scan SELECT LENGTH 2 SETTING				
4	Scan Two Characters From Appendix C	'0' and '0'	'0' and '7'	'5' and '2'	'7' and '4'
5	Scan ENTER/EXIT PROGRAMMING MODE				



# Appendix A Technical Specifications

## Technical Features

Item	Description
Physical Characteristics	
Color	Black
Dimensions	Height 27mm Length 38mm Width 47mm
Weight (with cable, without bracket)	USB version - Approximately 131 g RS-232 version - Approximately 155 g RJ45 version - Approximately 96g
Electrical Characteristics	
Input Voltage	5 VDC $\pm$ 5%
<b>External Trigger Input</b> (Only RS-232 model): 1V - 5V Current Consumption for 1V = 2mA max 5V = 4mA max Min Pulse Duration = 10ms *	

\* Although the scan engine can respond to this minimum pulse width for triggering, bar code decoding time is dependent on several factors. External Trigger should be held active until there is a good read decode or a determined timeout period.

Item	Description
Current & Power Consumption	Typical RMS Input current at 5V in Default Configuration and Trigger Single mode
<p><b>DSM04x1 models</b> (USB connected):                      Operating <math>\approx 244</math> mA**                      Standby/Idle <math>\approx 72</math> mA*                      Low Power <math>\approx 3.9</math> mA</p> <p><b>DSM04x2 models</b> (USB connected):                      Operating <math>\approx 244</math> mA**                      Standby/Idle <math>\approx 70</math> mA*                      Low Power: <math>\approx 5</math> mA</p> <p><b>DSM04x2 models</b> (RS232 connected):                      Operating <math>\approx 276</math> mA**                      Standby/Idle <math>\approx 65</math> mA*                      Low Power <math>\approx 9</math> mA</p> <p>** if 'power" and 'trigger" status LED are disabled subtract about 30mA                      * if 'power" status LED is disabled subtract about 15mA</p>	

Performance Characteristics	
Nominal Frame Rate	53 frames/second (Mpixel models) or 60 frames/second (WVGA models)
Light Source	Dual LEDs
Roll (Tilt) Tolerance	Up to $\pm 180^\circ$
Pitch Tolerance	$\pm 60^\circ$
Skew (Yaw) Tolerance	$\pm 60^\circ$
Print Contrast Minimum	25% minimum reflectance
Field of View	Depending on the selected model, see the tables below
Depth of Field (Typical)	Depending on the selected model, see the tables below

Minimum Element Width	1D linear: 2 mils (MP-DL) Data Matrix: 6 mils (MP-DL) PDF417: 3 mils (MP-DL)
	1D Linear: 3mils (WVGA) PDF: 5mils (WVGA) Datamatrix: 7.5mils (WVGA)



The reading performances may change with different symbologies

**NOTE**

<b>Decode Capability</b>	
1D / Linear Codes All standard 1D codes including: UPC/EAN/JAN, P2 /P5 add-ons; Code 39; Italian Pharmacode 39; Code 128; C128 ISBT; I 2 of 5; Standard 2 of 5; Interleaved 2 of 5; Industrial 2of 5; Datalogic 2of5; IATA; Code 11; Codabar; ABC Codabar; EAN 128; Code 93; MSI/Plessey; RSS-14; BC412; Databar Limited; Databar Omnidirectional; Databar Omnidirectional Stacked; Databar Expanded; Databar Expanded Stacked; IATA; Trioptic; Matrix 2/5; Telepen. Composite codes CC-A, CC-B and CC-C PDF417; MicroPDF417.	
2D Codes China Han Xin Code; Datamatrix with Chinese extension; QR code; Micro QR; Aztec; MaxiCode and Dotcode.	
Postal Codes Australian Post; British Post; China Post; Portugal Post; Swedish Post; New Zeland Post; Japanese Post; KIX Post; IMB; Planet Code; Postnet, Postnet BB; Royal Mail Code (RM4SCC) ; Mailmark.	
Supported Interfaces	RS-232 Standard USB-COM, USB-Keyboard, USB-OEM, USB-Composite RJ45 with Datalogic USB and RS232 cables: 90A052065: USB 2m straight cable 90A051230: RS232 2m straight cable
User Environment	
Operating Temperature	-20° to 50° C
Storage Temperature	-40° to 70° C <sup>a</sup>
Humidity	Operating: 5% to 90% relative humidity, non condensing
Drop specifications	3ft free fall drops to concrete

a. Storage conditions for EAC Compliance require the device to be kept in a heated room.

Ambient Light immunity	Up to 100,000 Lux
Contaminants	IEC529-IP54
ESD Level	12 KV
Regulatory	See the Regulatory Addendum.

### DSM04X1 models (WVGA)

Resolution: 752x480

Field of View: 40°H x 26°V

#### Typical Depth of Field

Symbology <sup>a</sup>	Resolution (mils)	Dmin (mm)	Dmax (mm)
Code 39	3	80	175
Code 39	5	55	260
PDF	10	(-) <sup>b</sup>	200
EAN13	13	45	420
Datamatrix	15	35	265
Code 39	20	(-) <sup>b</sup>	590

- a. All labels grade A, ambient light level 300lux, pitch angle 10°, tilt angle 10°, skew angle 0°, room temperature 20°C.
- b. Limited by field of view.

### DSM04X2-DL models (MP)

Resolution: 1280x960

Field of View: 42°H x 32°V

#### Typical Depth of Field

Symbology <sup>a</sup>	Resolution (mils)	Dmin (mm)	Dmax (mm)
Code 39	3	65	200
Code 39	5	35	290
Datamatrix	10	75	260
EAN13	13	45	420
Datamatrix	15	55	320
Code 39	20	(-) <sup>b</sup>	600

- a. All labels grade A, ambient light level 300lux, pitch angle 10°, tilt angle 10°, skew angle 0°, room temperature 20°C.
- b. Limited by field of view.

## DSM04X2-WA models (MP)

Resolution: 1280x960

Field of View: 52°H x 40°V

### Typical Depth of Field

Symbology <sup>a</sup>	Resolution (mils)	Dmin (mm)	Dmax (mm)
Code 39	3	50	180
Code 39	5	30	240
Datamatrix	10	40	200
EAN13	13	35	370
Datamatrix	15	30	250
Code 39	20	(1) <sup>b</sup>	600

a. All labels grade A, ambient light level 300lux, pitch angle 10°, tilt angle 10°, skew angle 0°, room temperature 20°C.

b. Limited by field of view

## RS-232 Electrical Connections

### 9-pin Connector

1	Trigger (DSM045X models only)	Trigger signal input (see <a href="#">Figure 1</a> and <a href="#">Figure 2</a> )
2	TX	Transmit Data (output from scanner)
3	RX	Receive Data (input to scanner)
4	NC	Not connected
5	GND	Ground
6	VCC	+5Vdc
7	CTS	Clear to Send (input to scanner)
8	RTS	Request to Send (output from scanner)

Default configuration is RS-232: 115200, 8, N, 1, no handshaking, ACK/NAK disabled.

## External Trigger (DSM045X models only)

Figure 1 - DSM0400 powered using DB9 pin n°6 and Input Trigger using DB9 pin n°1

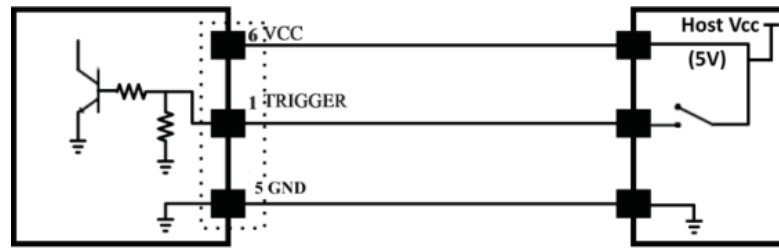
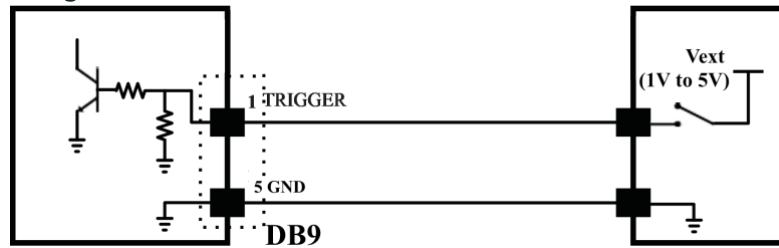

Figure 2 - DSM0400 Input Trigger using DB9 pin n°1 with an external voltage Vext

Acceptable range: from 1V to 5 V).



## LED and Beeper Indications

### Button and LED Status

The top of the product has a button and three indicator LEDs:

	POWER (yellow LED)	ON = Power ON
		OFF = Power OFF or standby BLINKS = during USB enumeration
	GOOD (green LED)	ON = Good Read
		BLINKS = during Flash memory updates
TRIGGER (blue LED)	ON = acquisition triggered (button pressed or trigger command or external trigger) BLINKS = during Programming mode	
Button	Press for manual trigger	

## Indicators

The reader's beeper sounds and its LED illuminates to indicate various functions or errors on the reader. DSM0400 also projects "Green Spot" on the field of view when the "GOOD" green LED turns on. The following tables list these indications. One exception to the behaviors listed in the tables is that the reader's functions are programmable, so they may or may not be turned on. For example, certain indications such as "Green Spot"/"GOOD" green LED can be disabled using programming bar code labels.

Indicator	Description	LED	Beeper
Power-up / Reader in IDLE mode	The device powers up and is ready for operation in IDLE mode	POWER LED turns on steadily. With a USB interface, the LED blinks until enumeration with the host is completed. The POWER LED turns off when device is in LOW POWER or when turned off.	Imager beeps four times upon power-up.
Good Read Beep	A code has been decoded successfully	"Green Spot" and GOOD LED turn on for programmed time (default). LED behavior for this indication is configurable.	Beeps if enabled
Reader in Sleep mode	The reader is in standby and in low power consumption (also USB suspend)	The POWER LED is OFF	N/A
Reader in Programming mode	The reader is in Programming, accepting programming barcodes (eg: a 'enter programming' bar code is read during IDLE mode)	The Trigger LED blinks slowly	N/A
USB Enumeration	The host is enumerating the reader in USB configuration	The POWER LED blinks fast	N/A
Imager Disabled	In USB OEM only interface the reader is disabled	The POWER LED blinks slowly	N/A
Flash Memory Update	Software update is in progress	GREEN SPOT / GOOD READ LED blinks slowly	N/A

## Troubleshooting

Problems	Possible Causes	Solutions
Nothing happens when the scan button is pulled.	No power to the imager.	Check system power. Ensure power supply is connected
	Interface or power cables are loose	Ensure all cable connections are secure.
LED comes on, but bar code does not decode.	Imager not programmed for correct bar code type.	Ensure the imager is programmed to read the bar code scanned type.
	Bar code label is unreadable.	Check the label to ensure it is not defaced. Try scanning another bar code type.
	Distance between imager and bar code is incorrect.	Move the imager closer to or further from the bar code.
Bar code is decoded but not transmitted to the host.	Imager not programmed for the correct host type.	Scan the appropriate host type bar code.

# DSM0400 Dimensions

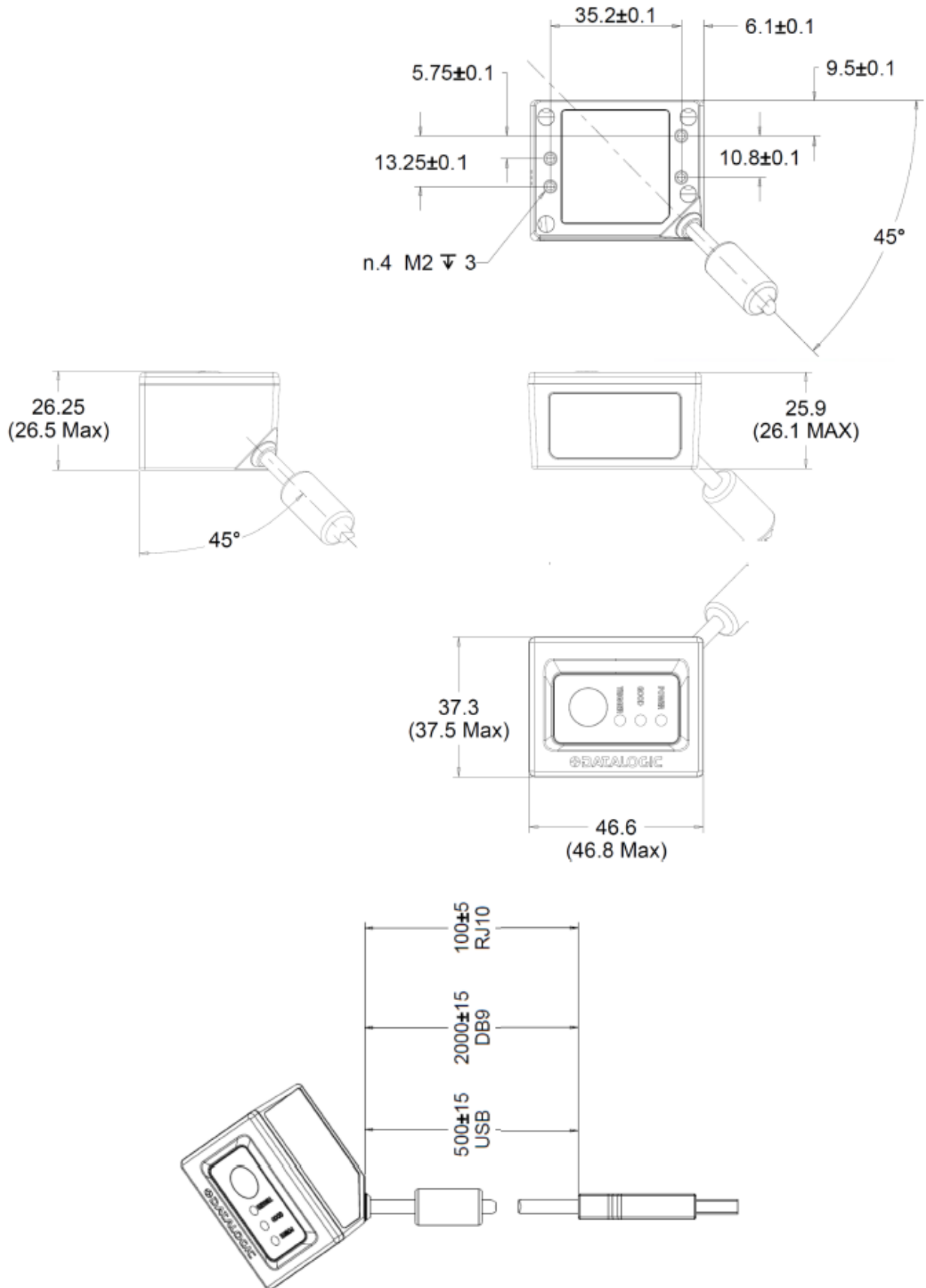

## Multi-face Bracket for Mounting in 5 sides

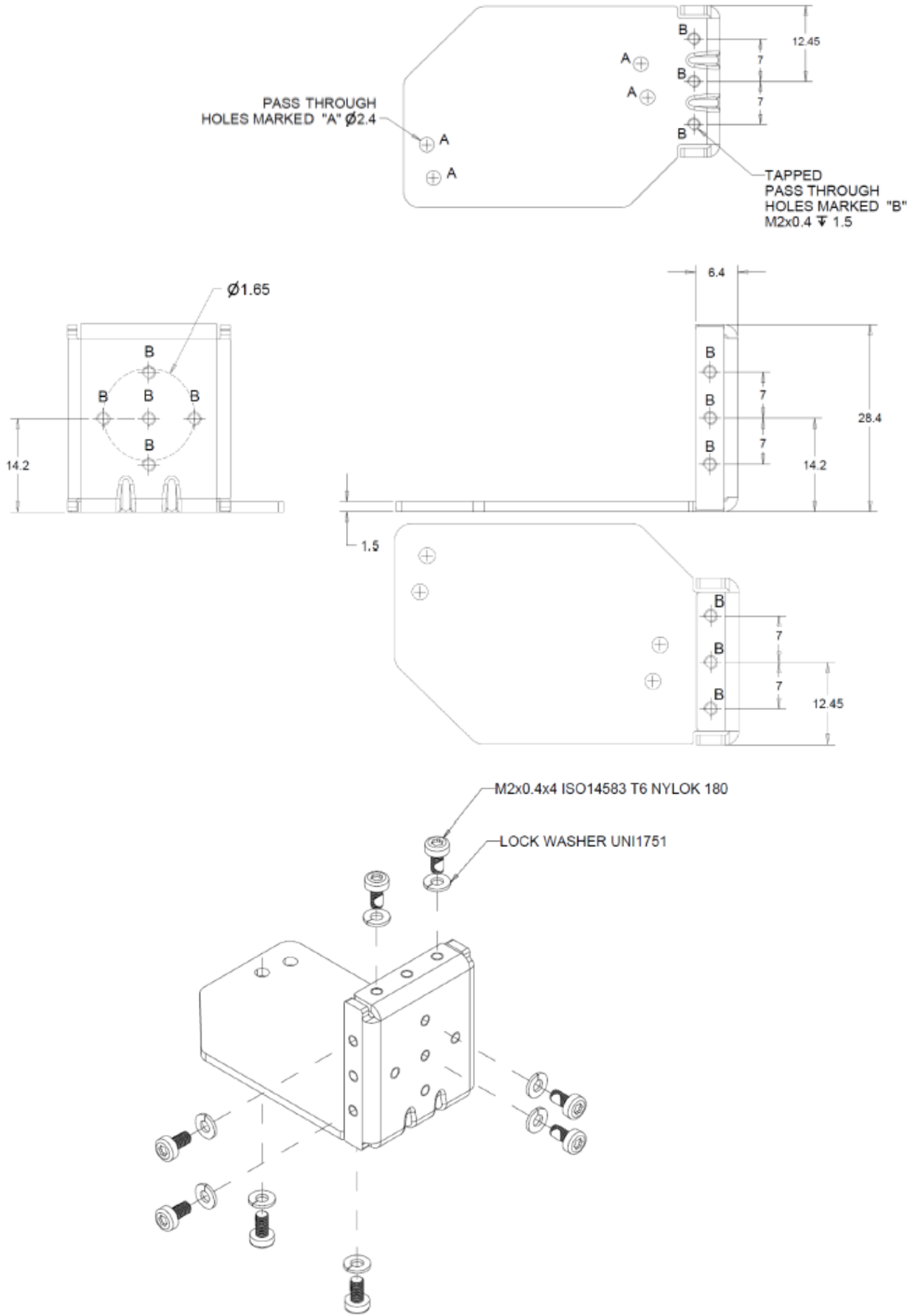

## Angular Mounting Bracket

-17° to +25° Possible Angle

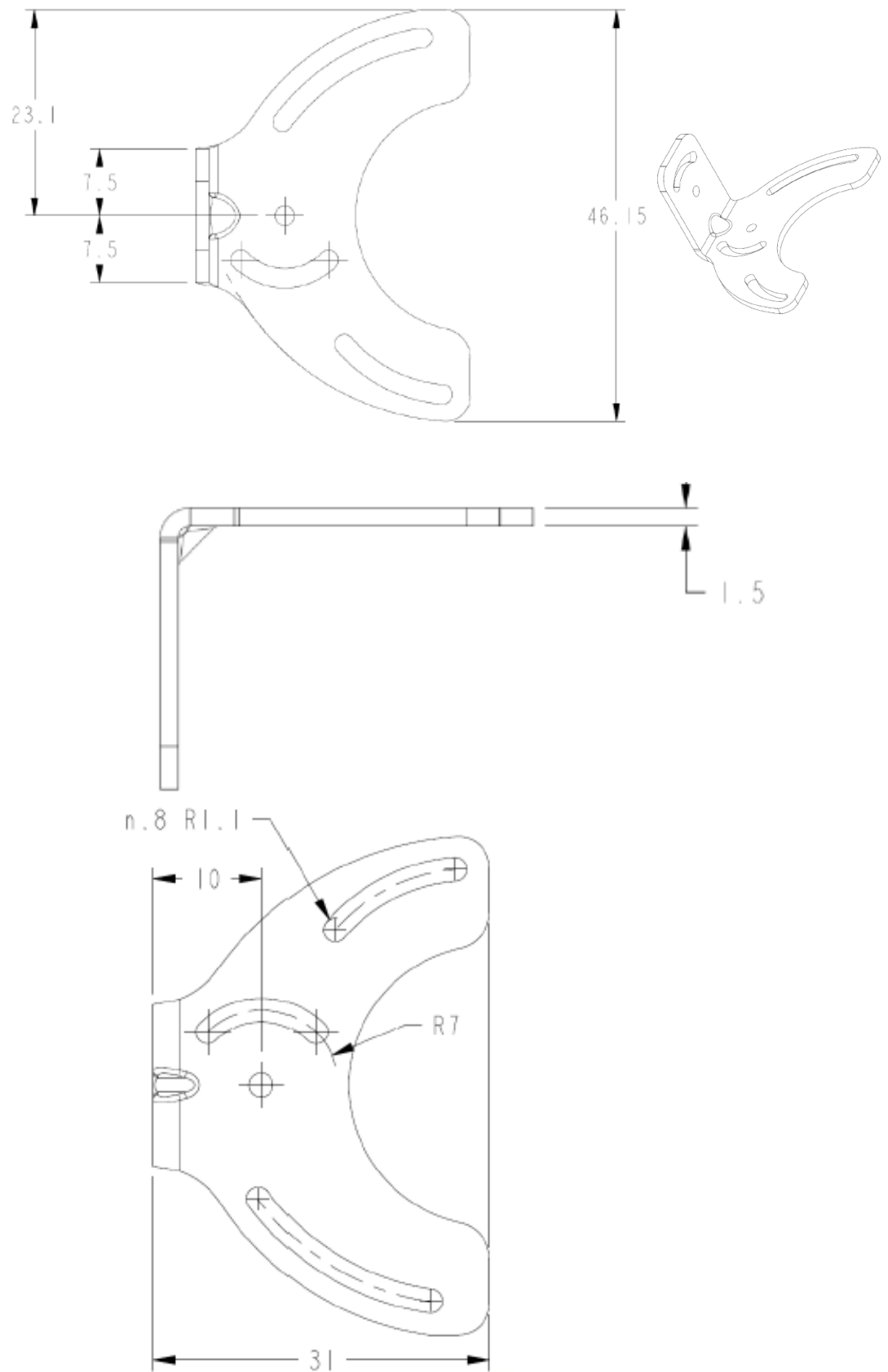

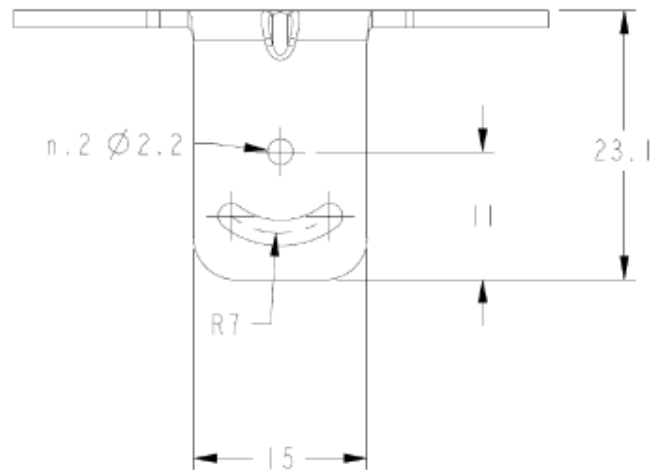

## Ergonomic Recommendations



### CAUTION

In order to avoid or minimize the potential risk of ergonomic injury follow the recommendations below. Consult with your local Health and Safety Manager to ensure that you are adhering to your company's safety programs to prevent employee injury.

- Reduce or eliminate repetitive motion
- Maintain a natural position
- Reduce or eliminate excessive force
- Keep objects that are used frequently within easy reach
- Perform tasks at correct heights
- Reduce or eliminate vibration
- Reduce or eliminate direct pressure
- Provide adjustable workstations
- Provide adequate clearance
- Provide a suitable working environment
- Improve work procedures.

## Standard Cable Pinouts for DSM049X models

Figure 1 and Table 1 provide standard pinout information for the scanner's cable.

**Figure 1. Standard Cable Pinouts for DSM049X models**

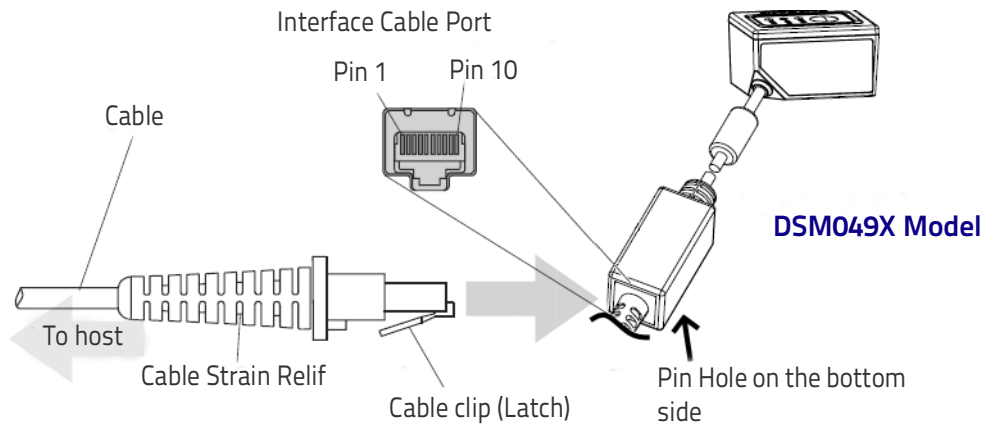

The signal descriptions in Table 1 apply to the connector on the scanner and are for reference only.

**Table 1. Standard Cable Pinouts — Scanner Side**

Pin	RS-232	USB	Keyboard Wedge
1	RTS (out)		
2		D+	CLKIN (KBD side)
3		D-	DATAIN (KBD side)
4	GND	GND	GND
5	RX		
6	TX		
7	VCC	VCC	VCC
8			
9			
10	CTS (in)		



### NOTE

**IMPORTANT:** DSM049X has to be used only with the Datalogic RS-232 or USB Cables indicated in the accessories list.

# NOTES



# Appendix B

## Sample Bar Codes

The sample bar codes in this appendix are typical representations for their symbology types.

### 1D Bar Codes

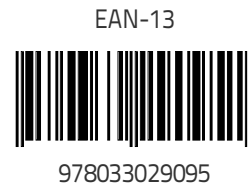

## 1D Bar Codes - continued

Code 32



B9P91Q

Codabar



13579

Code 93



ABCDEF

Code 11



123456789

# GS1 DataBar™ (RSS)



GS1 DataBar™ variants must be enabled to read the bar codes below (see "GS1 DataBar™ Omnidirectional" on page 141).

**NOTE**

GS1 DataBar™ Expanded Stacked



10293847560192837465019283746029478450366523

GS1 DataBar™ Expanded



1234890hjo9900mnb

GS1 DataBar™ Limited



08672345650916

# GS1 DataBar™-14

GS1 DataBar™ Omnidirectional Truncated



55432198673467

GS1 DataBar™ Omnidirectional Stacked



90876523412674

GS1 DataBar™ Omnidirectional Stacked



78123465709811

## 2D Bar Codes

Aztec



Datamatrix



China Sensible Code



MaxiCode

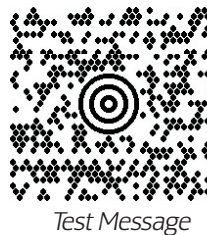

*Test Message*

PDF 417  
PDF417



*Car Registration*

ABCabc

Micro PDF 417



BV17453

QR Code

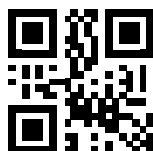

35900G9

Micro QR Code



123456

UCC Composite

(17) 050923 (10) ABC123



(01) 0 4012345 67890 1 1

## ASCII Chart





ASCII Char.	Hex No.	ASCII Char.	Hex No.	ASCII Char.	Hex No.	ASCII Char.	Hex No.
NUL	00	SP	20	@	40	'	60
SOH	01	!	21	A	41	a	61
STX	02	"	22	B	42	b	62
ETX	03	#	23	C	43	c	63
EOT	04	\$	24	D	44	d	64
ENQ	05	%	25	E	45	e	65
ACK	06	&	26	F	46	f	66
BEL	07	'	27	G	47	g	67
BS	08	(	28	H	48	h	68
HT	09	)	29	I	49	i	69
LF	0A	*	2A	J	4A	j	6A
VT	0B	+	2B	K	4B	k	6B
FF	0C	,	2C	L	4C	l	6C
CR	0D	-	2D	M	4D	m	6D
SO	0E	.	2E	N	4E	n	6E
SI	0F	/	2F	O	4F	o	6F
DLE	10	0	30	P	50	p	70
DC1	11	1	31	Q	51	q	71
DC2	12	2	32	R	52	r	72
DC3	13	3	33	S	53	s	73
DC4	14	4	34	T	54	t	74
NAK	15	5	35	U	55	u	75
SYN	16	6	36	V	56	v	76
ETB	17	7	37	W	57	w	77
CAN	18	8	38	X	58	x	78
EM	19	9	39	Y	59	y	79
SUB	1A	:	3A	Z	5A	z	7A
ESC	1B	;	3B	[	5B	{	7B
FS	1C	<	3C	\	5C		7C
GS	1D	=	3D	]	5D	}	7D
RS	1E	>	3E	^	5E	~	7E
US	1F	?	3F	_	5F	DEL	7F

# NOTES



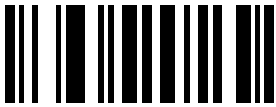



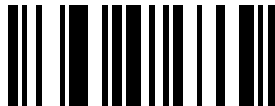

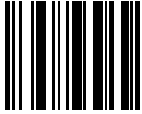

## Appendix C Keypad

Use the barcodes in this appendix to enter numbers as you would select digits/characters from a keypad.

 0	
	 1
 2	
	 3
 4	
	 5

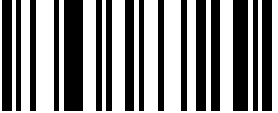

# HID Variable PIN Code

 <p>Cancel an incomplete HID Variable PIN Code</p>	
	 <p>Exit HID Variable PIN Code</p>
 <p>A</p>	
	 <p>B</p>
 <p>C</p>	
	 <p>D</p>
 <p>E</p>	
	 <p>F</p>

# NOTES





[www.datalogic.com](http://www.datalogic.com)

©2019 Datalogic S.p.A. and/or its affiliates. All rights reserved. Datalogic and the Datalogic logo are registered trademarks of Datalogic S.p.A. in many countries, including the U.S. and the E.U.

**Datalogic S.r.l.**

Via S. Vitalino, 13 | Calderara di Reno  
40012 BO | Italy | Telephone: (+39) 051-3147011  
Fax: (+39) 051-3147205

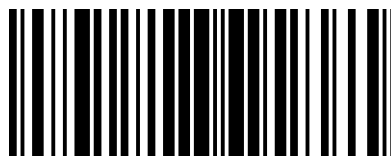

820114600

(Rev A)

September 2019