



ELITE SCREENS

GET THE BIG PICTURE





ZPM-RT2

Remote Control Kit for Spectrum 2 Series

User's Guide – V2.1

Thank you for purchasing the ZPM-RT2 kit. The ZPM-RT2 kit allows your Spectrum 2 Series electric screen the ability to control it using a Radio Frequency or Infrared remote control, and a wired or wireless 5-12volt projector trigger with the included accessories list below.

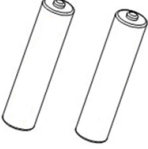
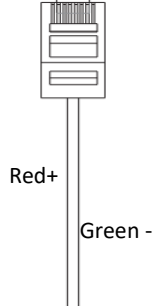
What's included:

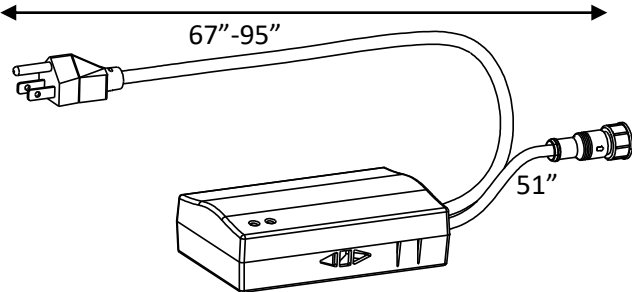
ZMP-RT2 accessories/parts list					
A. Infrared (IR) remote x 1 pc	B. Radio Frequency (RF) Remote x 1 pc	C. AAA batteries x 4 pc	D. Wired 5-12 volt projector trigger x 1 pc	E. IR "eye" receiver x 1 pc	F. Wireless 5-12v 3.5 mm mono to USB trigger cable x 1 pc
					
G. Wall box (circuit board housing)					
					

ZPM-RT2 Installation & Control Instructions

1. Disconnect the 3 Way Control Switch from the Spectrum 2 Screen as shown below.

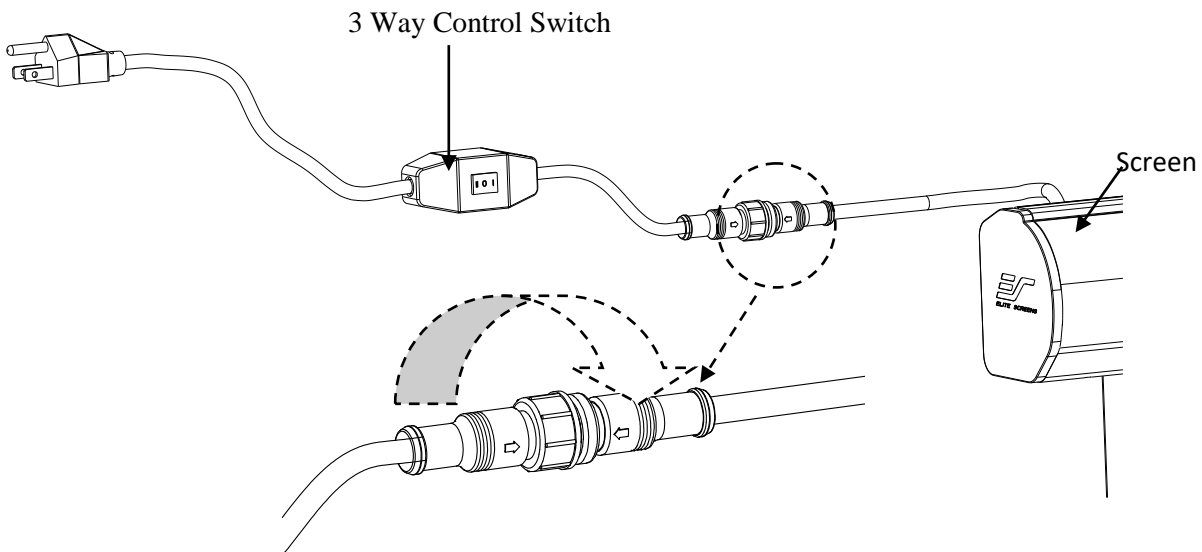

2. Connect the **Wall Box (G)** to the screen as shown below.

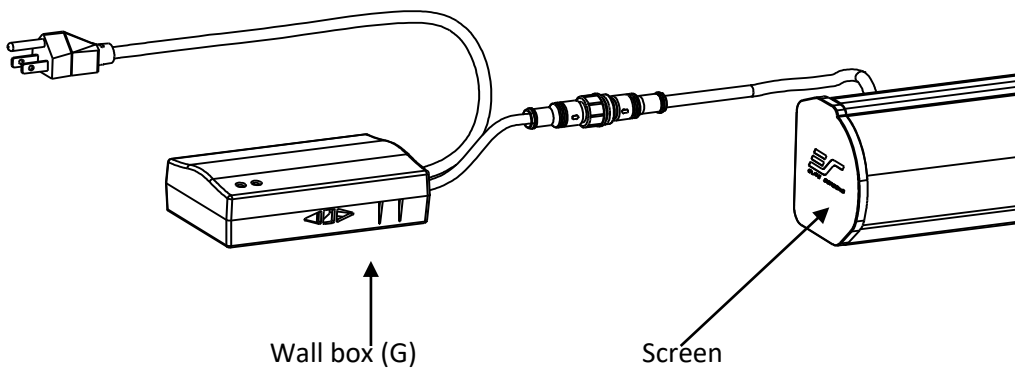

6 ways to control your Spectrum 2 screen:

1. **IR remote control (Item A, Fig 1):** The Infrared functions by direct line of sight contact with a beam range of 30 feet. Aim the IR remote at the circular window located on the left side of the screen

2. **IR "Eye" Receiver (Item E, Fig 2):** The IR "Eye" Receiver plugs directly into the wall box's RJ45 input port.

3. **RF Remote Control (Item B, Fig 1):** The radio waves eliminate the need for a direct line of sight with a range of 100 feet.

4. **3-Way Wall Switch:** This accessory is not included but can be purchased separately to use as a manual keypad switch to control the UP/STOP/DOWN functions of the screen. It connects to the RJ45 port of the wall box. **Part number ZSP-WB-W**

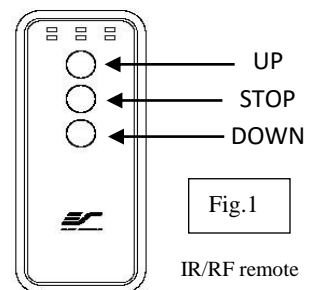

IR/RF remote

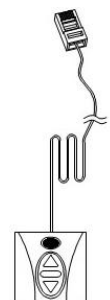

IR Eye Receiver (Item, E)

Connect the **IR Eye Receiver (E)** to the **Wall Box (G)** for high wall or ceiling installations.

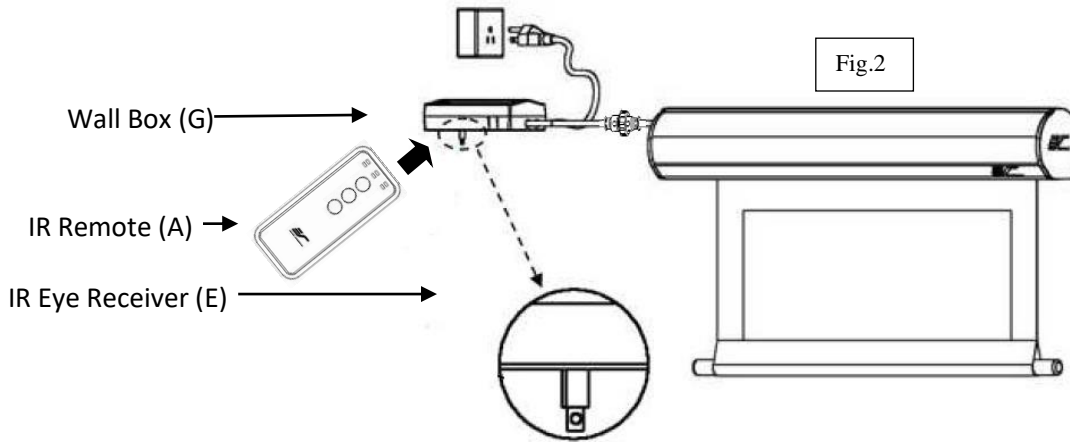

5. 5-12 volt trigger (Item E, Fig 3): The built-in 5-12V trigger input allows your screen to synchronize its drop & rise with the projector's power cycle. The screen deploys when the projector powers up and will retract when the projector powers down. The 5-12 volt RJ45 cable connects to your projector's trigger output via a separate cable that may or may not be provided by the manufacturer of the projector. The trigger feature will not work without an output cable from the projector, but it can be tested by connecting the Red (+) and Green (-) cable to a 9-volt battery.

12 Volt Trigger (Item, E)

Connect the **12 Volt Trigger (E)** to the **Wall Box (G)** for set up to your projector.

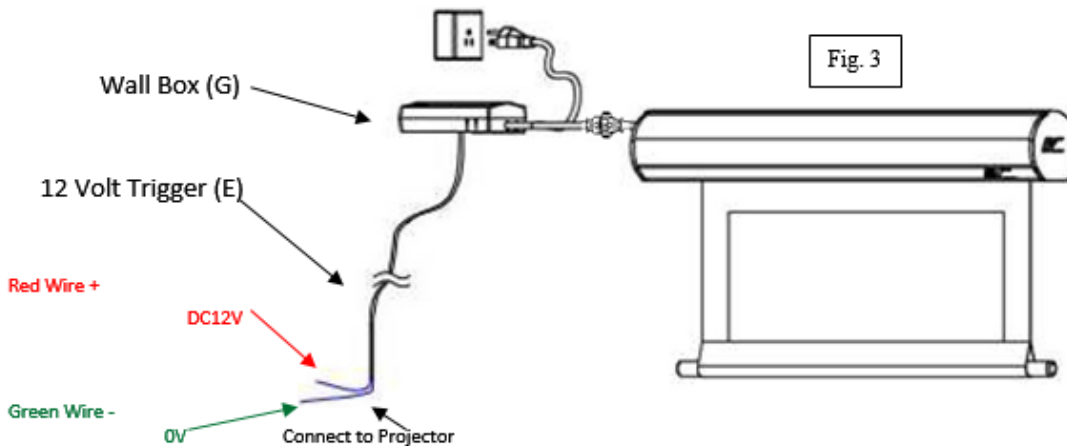

6. Wireless 5-12 volt trigger (Item F, Fig 4):

The RF remote control serves as a dual purpose, independently as a handheld remote control, or in conjunction with the Wireless 5-12 volt trigger cable. The radio frequency technology can be programmed to send a wireless signal to synchronize its drop/rise with the projector's power cycle.

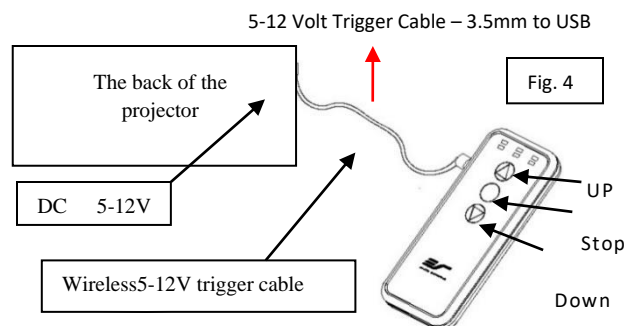

Wireless 5-12v 3.5mm mono to USB trigger cable (F)

Here's how to set up your Wireless 5-12 volt trigger | Synchronization Instructions

Step 1: Connect the 3.5 mm wireless 5-12 volt trigger cable to the RF remote.

Step 2: Connect the USB end of the wireless 5-12 volt trigger cable to your projector's USB DC output port

Step 3: Make sure to unplug your screen from the power outlet

Step 4: Hold the **UP** button on your RF remote

Step 5: While holding the **UP** button, plug the screen back to the power outlet

Step 6: Wait 5 seconds and then release the **UP** button

Step 7: Your 5-12V wireless trigger should now be activated with your screen and ready to be used and able to control your screen with your projector's power cycle. Repeat the steps again if not successful.

(Please be aware, the projector on/off cycle may take longer to fully activate. It usually takes around 20-30seconds for full off and on cycle each time)

For a local Elite Screens contact or Technical Support, please visit

www.elitescreens.com