

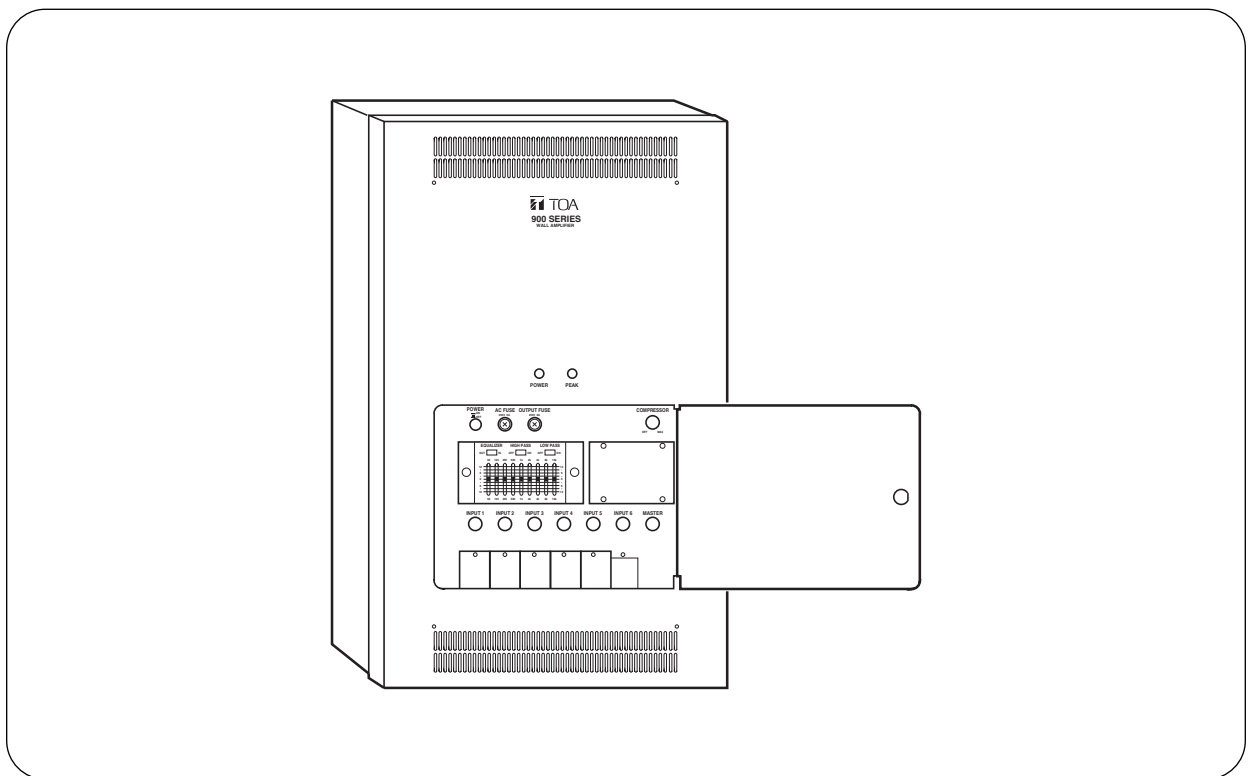

USER'S MANUAL

NEW 900 SERIES IN-WALL MIXER POWER AMPLIFIERS

**W-906A
W-912A**



Thank you for purchasing TOA's New 900 series In-wall Mixer Power Amplifier.
Please carefully follow the instructions in this manual to ensure long, trouble-free use of your equipment.

TOA Corporation

TABLE OF CONTENTS

1. IMPORTANT SAFETY INSTRUCTIONS	3
2. SAFETY PRECAUTIONS	4
3. GENERAL DESCRIPTION	6
4. FEATURES	6
5. NOMENCLATURE AND FUNCTIONS	
Front	7
6. SERVICING	8
7. OPERATION	
7.1. Basic Operation Procedure	8
7.2. Filter ON/OFF	8
7.3. Compressor ON/OFF	8
8. VOLUME CONTROL COVER ATTACHMENT	9
9. OUTPUT EQ CHARACTERISTIC	9
10. SPECIFICATIONS	10
Accessories	11
Optional products	11

1. IMPORTANT SAFETY INSTRUCTIONS

- Read these instructions.
 - Keep these instructions.
 - Heed all warnings.
 - Follow all instructions.
 - Do not use this apparatus near water.
 - Clean only with dry cloth.
 - Do not block any ventilation openings. Install in accordance with the manufacturer's instructions.
 - Do not install near any heat sources such as radiators, heat registers, stoves, or other apparatus (including amplifiers) that produce heat.
 - Do not defeat the safety purpose of the polarized or grounding-type plug. A polarized plug has two blades with one wider than the other. A grounding type plug has two blades and a third grounding prong. The wide blade or the third prong are provided for your safety. If the provided plug does not fit into your outlet, consult an electrician for replacement of the obsolete outlet.
 - Protect the power cord from being walked on or pinched particularly at plugs, convenience receptacles, and the point where they exit from the apparatus.
 - Only use attachments/accessories specified by the manufacturer.
 - Use only with the cart, stand, tripod, bracket, or table specified by the manufacturer, or sold with the apparatus. When a cart is used, use caution when moving the cart/apparatus combination to avoid injury from tip-over.
- 
- Unplug this apparatus during lightning storms or when unused for long periods of time.
 - Refer all servicing to qualified service personnel. Servicing is required when the apparatus has been damaged in any way, such as power-supply cord or plug is damaged, liquid has been spilled or objects have fallen into the apparatus, the apparatus has been exposed to rain or moisture, does not operate normally, or has been dropped.

INSTRUCTIONS ESSENTIELLES POUR LA SÉCURITÉ

- Lire ces instructions.
 - Conserver ces instructions pour référence ultérieure.
 - Respecter tous les avertissements.
 - Suivre toutes les instructions.
 - Ne pas utiliser cet appareil à proximité d'eau.
 - Nettoyer uniquement à l'aide d'un chiffon sec.
 - Ne pas obstruer les orifices de ventilation. Installer conformément aux instructions du fabricant.
 - Ne pas installer à proximité de sources de chaleur telles que des radiateurs, des registres thermiques, des chaudières ou d'autres appareils (notamment des amplificateurs) produisant de la chaleur.
 - Ne pas contourner la fonction de sécurité de la fiche polarisée ou de mise à la terre. Une fiche polarisée est équipée de deux broches, dont l'une est plus large que l'autre. Une fiche de mise à la terre est équipée de deux broches et d'une troisième pour la mise à la terre. Cette dernière, la plus large, est prévue à des fins de sécurité. Si la fiche fournie ne peut être insérée dans la prise électrique souhaitée, consulter un électricien pour faire remplacer cette dernière.
 - Protéger le cordon d'alimentation pour éviter qu'il ne soit piétiné ou pincé, notamment au niveau des fiches, des prises de courant ou de son point de sortie de l'appareil.
 - Utiliser uniquement les accessoires spécifiés par le fabricant.
 - Utiliser uniquement avec le chariot, support, trépied, la patte de montage ou la table spécifiés par le fabricant ou vendus avec l'appareil. En cas d'utilisation d'un chariot, manipuler la combinaison chariot/appareil pour éviter les blessures dues à un renversement.
- 
- Débrancher cet appareil pendant les orages ainsi que lorsqu'il reste inutilisé pendant une période prolongée.
 - La maintenance de l'appareil doit être confiée à un technicien après-vente qualifié. Une maintenance s'avère nécessaire si l'appareil est endommagé (au niveau du cordon d'alimentation ou de la fiche), a été mouillé par un liquide, un objet est tombé à l'intérieur, s'il a été exposé à la pluie ou l'humidité, s'il ne fonctionne pas normalement ou s'il est tombé.

2. SAFETY PRECAUTIONS

- Before installation or use, be sure to carefully read all the instructions in this section for correct and safe operation.
- Be sure to follow all the precautionary instructions in this section, which contain important warnings and/or cautions regarding safety.
- After reading, keep this manual handy for future reference.

Safety Symbol and Message Conventions

Safety symbols and messages described below are used in this manual to prevent bodily injury and property damage which could result from mishandling. Before operating your product, read this manual first and understand the safety symbols and messages so you are thoroughly aware of the potential safety hazards.



The exclamation point within an equilateral triangle is intended to alert the user to the presence of important operation and maintenance (servicing) instruction in the literature accompanying the appliance.



Le point d'exclamation à l'intérieur d'un triangle équilatéral avertit l'utilisateur de l'existence d'instructions d'utilisation et d'entretien (réparation) dans la documentation fournie avec l'appareil.



WARNING

Indicates a potentially hazardous situation which, if mishandled, could result in death or serious personal injury.



AVERTISSEMENT

Indique une situation risquant d'entraîner des blessures graves, voire la mort, en cas de mauvaise manipulation.

- Should the following irregularity be found during use, immediately switch off the power, disconnect the power supply plug from the AC outlet and contact your nearest TOA dealer. Make no further attempt to operate the unit in this condition as this may cause fire or electric shock.
 - If you detect smoke or a strange smell coming from the unit
 - If water or any metallic object gets into the unit
 - If the unit falls, or the unit case breaks
 - If the power supply cord is damaged (exposure of the core, disconnection, etc.)
 - If it is malfunctioning (no tone sounds.)
- To prevent a fire or electric shock, never open nor remove the unit front cover as there are high voltage components inside the unit. Refer all servicing to your nearest TOA dealer.
- Do not place cups, bowls, or other containers of liquid or metallic objects on top of the unit. If they accidentally spill into the unit, this may cause a fire or electric shock.
- Do not insert nor drop metallic objects or flammable materials in the ventilation slots of the unit's cover, as this may result in fire or electric shock.
- To reduce the risk of fire or electric shock, do not expose this apparatus to rain or moisture.
- Pour réduire le risque d'incendie ou de choc électrique, n'exposez pas cet appareil à la pluie ou à l'humidité.
- Apparatus shall not be exposed to dripping or splashing and no objects filled with liquids, such as vases, shall be placed on the apparatus.
- L'appareil ne doit pas être exposé à un suintement ou à des éclaboussures. Ne placez aucun objet rempli de liquide, tel qu'un vase, sur l'appareil.
- External wiring connected to the terminals marked with ⚡ requires installation by an instructed person.
- Les câbles externes branchés aux bornes marquées de ⚡ doivent être installé par un technicien spécialement formé.



CAUTION

Indicates a potentially hazardous situation which, if mishandled, could result in moderate or minor personal injury, and/or property damage.



ATTENTION

Indique une situation risquant d'entraîner des blessures moyennement graves ou mineures, et/ou des dommages matériels.

- Do not place objects on the unit as this may cause it to fall or break which may result in personal injury and/or property damage. In addition, the object itself may fall off and cause injury and/or damage.
- Make sure that the volume control is set to minimum position before power is switched on. Loud noise produced at high volume when power is switched on can impair hearing.
- Do not operate the unit for an extended period of time with the sound distorting. This is an indication of a malfunction, which in turn can cause heat to generate and result in a fire.
- If dust accumulates on the power supply plug or in the wall AC outlet, a fire may result. Clean it periodically. In addition, insert the plug in the wall outlet securely.
- Switch off the power, and unplug the power supply plug from the AC outlet for safety purposes when cleaning or leaving the unit unused for 10 days or more. Doing otherwise may cause a fire or electric shock.
- Do not stand or sit on, nor hang down from the unit as this may cause it to fall down or drop, resulting in personal injury and/or property damage.



The lightning flash with arrowhead symbol, within an equilateral triangle, is intended to alert the user to the presence of uninsulated "dangerous voltage" within the product's enclosure that may be of sufficient magnitude to constitute a risk of electric shock to persons.



L'éclair accompagné d'un symbole représentant une pointe de flèche à l'intérieur d'un triangle équilatéral avertit l'utilisateur de la présence d'une "tension dangereuse" à l'intérieur de l'enceinte du téléviseur, dont la magnitude peut être suffisante pour constituer un risque de choc électrique pour les personnes.



ATTENTION

L'appareil ne doit pas être exposé aux éclaboussures ou écoulements et tous objets remplis de liquide, tels que vases, ne doivent pas être sur l'appareil.

3. GENERAL DESCRIPTION

The TOA W-906A and W-912A In-Wall Mixer Power Amplifiers control and mix up to six independent input signals plus two inputs with use of WE-2 Expanding kit. The W-906A delivers up to 60 W of output power and the W-912A 120 W. Optional accessory modules are available for use with the W-906A and W-912A to provide versatility for a wide range of operating applications. Edge connectors at the bottom of the front panel permit the selection of the TOA plug-in modules. (Please contact your local TOA dealer for details on TOA plug-in modules.)

The W-906A and W-912A have a built-in one-octave graphic equalizer with 9 bands to tailor sound system frequency response to room acoustics, reducing feed-back tendencies and improving intelligibility. A built-in compressor circuit is provided to protect the output level from distortion as a result of excessive input and keeps it constant. Compressor's threshold level can be adjusted.

The speaker output terminals are designed to match 25 or 70 V line, or 4 or 8 Ω speaker systems.

User's space (blank) is provided for loading the WE-2 Expanding kit (optional), enabling the number of inputs to be increased by two. Protection against tampering is assured by means of a key-locked hinged door. The W-906A and W-912A can be mounted in any four-inch wall with of the BX-9F Flush-mounting (in-wall) back box. On-wall mounting is also possible with the BX-9S Surface-mounting (on-wall) back box.

4. FEATURES

- 6-channel mixer power amplifier
- Expandable to 8-input
- Output power: 120 W for W-912A, 60 W for W-906A
- Wide frequency response: 30 Hz to 20 kHz \pm 1dB
- Low distortion and noise
- Excellent output regulation
- Built-in one-octave equalizer
- Built-in compressor
- Self-protection circuitry design
- Separate output terminals: 4 and 8 Ω , 25 and 70 V
- Extra space for customizing
- LED peak indicator
- Full range of plug-in modules
- Flush and surface mounting

5. NOMENCLATURE AND FUNCTIONS

[Front]

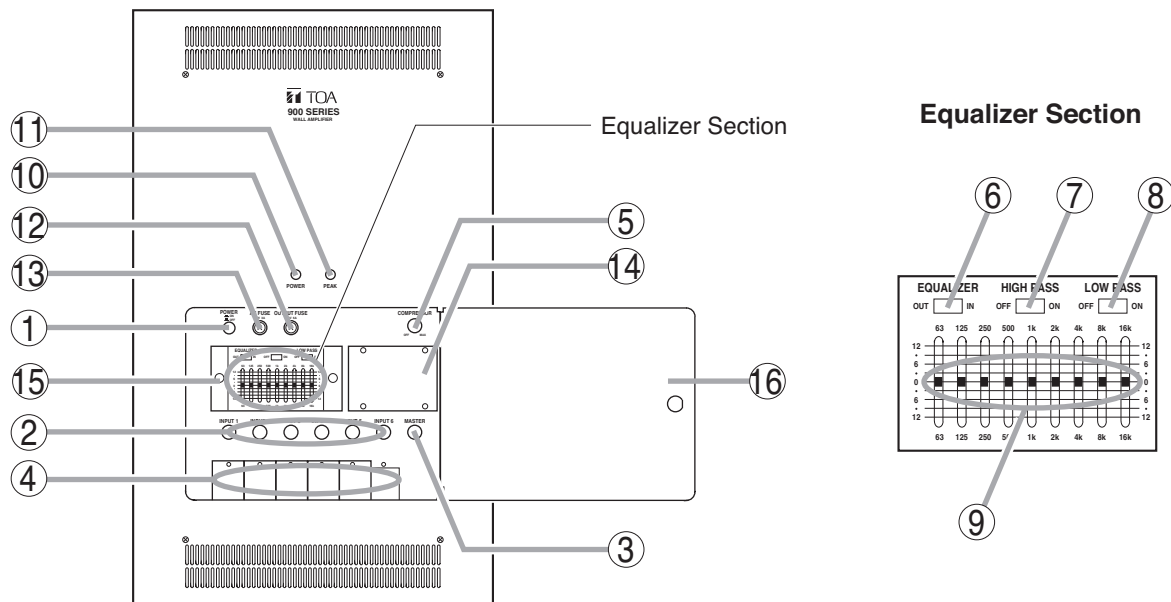

- 1. Power switch [POWER]**
Power is switched on and off with each depression of this switch.
- 2. Input volume controls [INPUT 1 – 6]**
Adjust gain of input 1 – 6 respectively.
Adjust the input volume of each input channel.
Write the input source name on the enclosed indication label, then attach it just below the corresponding control.
- 3. Master volume controls [MASTER]**
Adjusts overall gain of all input channels.
- 4. Blank panels**
Cover the Module input ports when shipped from the factory.
When mounting a module, remove the blank panel corresponding to the port.
- 5. Compressor control (limiter) [COMPRESSOR]**
Setting the control switch to OFF position bypasses the compressor circuit. As the control is turned clockwise, the output level is limited stronger.
- 6. Equalizer switch [EQUALIZER]**
Place this switch in the IN position to activate an equalizer.
- 7. High-pass filter switch [HIGH PASS]**
Place this switch in the ON position to cut off unnecessary low frequencies.
- 8. Low-pass filter switch [LOW PASS]**
Place this switch in the ON position to cut off unnecessary high frequencies.
- 9. Equalizer controls**
9 band filters. 12 dB of boost and cut at each center frequency.
- 10. Power indicator**
Lights when power is switched on.
- 11. Peak indicator**
Lights if input signals approach clipping level. If steady lit, turn down the corresponding Input volume control until the indicator flashes only intermittently.
- 12. Output fuse [OUTPUT FUSE]**
Protects against excessive current flow.
W-906A: 250 V, 6 A
W-912A: 250 V, 10 A
- 13. AC fuse [AC FUSE]**
Protects against excessive current flow.
W-906A: 250 V, 3 A
W-912A: 250 V, 5 A
- 14. Blank panel (user's space)**
The space of 103 (w) x 63 (h) x 95 (d) mm (4.06" x 2.48" x 3.74") is provided.
An optional expanding kit (WE-2) may be loaded in this space.
- 15. Equalizer security cover**
Protects against inadvertent changes of the equalizer controls set at proper level.
- 16. Key-locked door**
Protects against tampering.

6. SERVICING

Failure

Should amplifier fail, contact your nearest TOA authorized contractor or service center.

7. OPERATION

Be sure to complete all connections before operation.

7.1. Basic Operation Procedure

Step 1. Press the power switch to turn on the power.

The power indicator lights. The amplifier comes into operation about 5 seconds after the power has been switched on.

Step 2. Adjust the individual input and master volume controls for the optimum level.

Turn the knob clockwise to increase the output level and counterclockwise to decrease it. Sound quality is downgraded when the Peak Indicator remains lit.

Step 3. Adjust the graphic equalizer.

The one-octave graphic equalizer allows more precise frequency adjustments response to room acoustics, reducing feedback opportunities and improving intelligibility.

Characteristic of this equalizer is on p. 9. Adjust it to obtain the desired frequency response by actually hearing the sound or by using pink noise.

To make the adjustment, place the EQ switch in the IN position.

If a control knob is moved up, center frequency is boosted and if down, it is cut. Placing the EQ switch in the OUT position bypasses the equalizer circuit and makes frequency response flat.

7.2. Filter ON/OFF

When the HIGH PASS FILTER switch is in the ON position, low frequency is cut. In this event, low frequency below 180 Hz may be cut at a 12 dB/OCTAVE rate. When LOW PASS FILTER switch is in the ON position, high frequency of 7 kHz or higher may be cut at a 12 dB/OCTAVE rate.

To bypass the filter, place the filter switch in the OFF position.

7.3. Compressor ON/OFF

If the COMPRESSOR CONTROL switch is set to OFF, it bypasses the compressor circuit. Turn it clockwise to activate the compressor and to adjust the limiting level. Since turning it fully clockwise limits the output level to the maximum, be sure to turn it to the appropriate position so that the Peak indicator does not light.

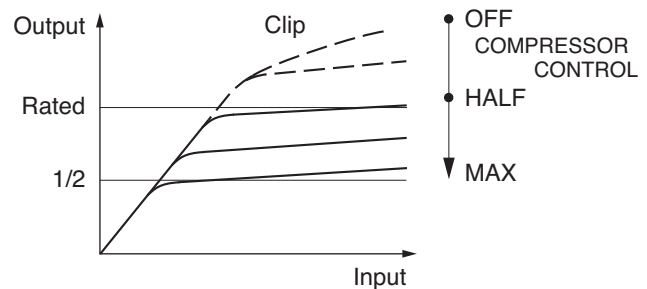

8. VOLUME CONTROL COVER ATTACHMENT

To protect the input volume control from accidental operation, it is recommended to replace the control knob with the supplied volume control cover.

Step 1. After adjusting the input volume control, remove its knob.

Step 2. Attach the supplied volume control cover in place of the knob.

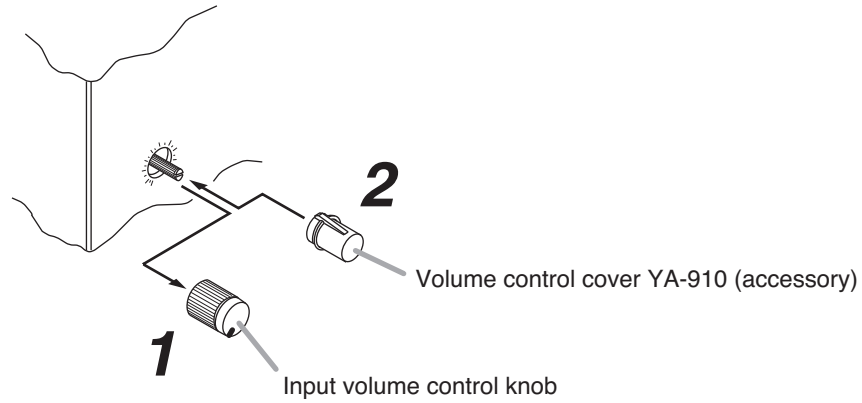

Note

The unit comes with 3 volume control covers as standard accessories. Ask for the optional one model YA-910 as necessary.

9. OUTPUT EQ CHARACTERISTIC

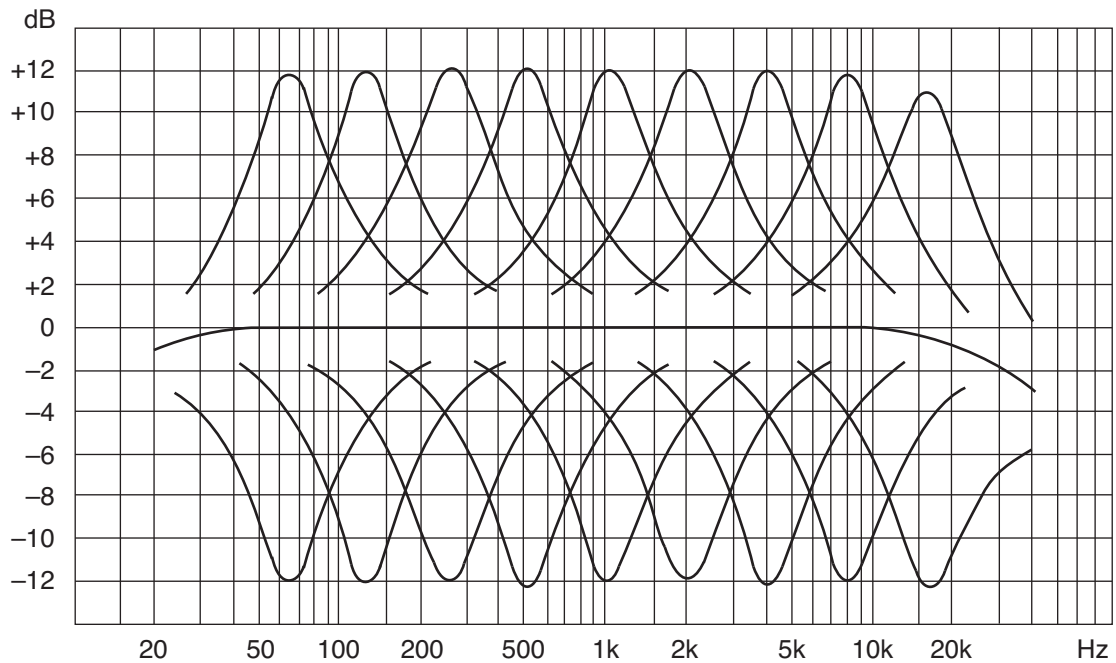

10. SPECIFICATIONS

Model No.	W-906A	W-912A
Type	Wall mounting 6-channel mixer power amplifier	
Output Power	60 W RMS	120 W RMS
Power Bandwidth	(D): 20 Hz – 20 kHz, 0.5% THD (T): 20 Hz – 20 kHz, 0.5% THD	
Frequency Response	(D): 30 Hz – 20 kHz, ± 1 dB (T): 30 Hz – 15 kHz, ± 1 dB (T): 30 Hz – 20 kHz, ± 1 dB, – 3 dB	
Total Harmonic Distortion	0.02% at 1 kHz, rated output	
Inputs	Six input ports: Each port accepts any input module except T-01S. Use T-01S only in port 5 or 6. One bridging input/output.	
Input Sensitivity/Impedance	Input ports 1 to 6: 100 mV, 10 k Ω Bridging input/output: 100 mV, 3.3 k Ω	
Outputs	(T): 8 Ω , 25 V and 70 V, balanced (D): 4 Ω , unbalanced	
Output Regulation (1 kHz)	(D): Less than 0.5 dB, no load to full load. (T): Less than 1.0 dB, no load to full load.	
Signal to Noise Ratio (Band Pass: 20 Hz – 20 kHz)	Controls OFF: 90 dB Master volume Max: 77 dB Equalizer IN: 88 dB Compressor IN: 84 dB	
Compression	Attack time: Not greater than 2 ms Compression range: 20 dB Release time: Adjustable 20 – 2000 ms Distortion: Less than 1%	
Equalization	9-Band ISO One-octave graphic equalizer Center frequencies: 63, 125, 250, 500, 1000, 2000, 4000, 8000, 16000 Hz Equalization range: ± 12 dB	
Filters	High-pass filter: 180 Hz, 12 dB/octave Low-pass filter: 7 kHz, 12 dB/octave	
Controls	6 Input gain controls, 1 Master gain control, 1 Compression level control, 9 Equalizer controls, 1 Power ON/OFF switch, 1 Equalizer ON/OFF switch, 1 High-pass filter ON/OFF switch, 1 Low-pass filter ON/OFF switch, 1 Low-cut switch (60 Hz, 6 dB/octave, inside)	
Indicators	1 LED power indicator, 1 LED peak indicator	
Protection	Self-protection, with 2 AC fuses (1 inside) and 1 output fuse	
Connectors	Input 1 to 6: Card-edge connector Output: Screw-terminal strip Bridging input/output: Screw-terminal strip Mute: Screw-terminal strip AC Power cord: SJT 3-conductor	
Power Source	120 V AC, 60 Hz	
Power Consumption (1/3 Non-Clip Maximum Power)	100 W	180 W
Color	Silver	
Dimensions	Face panel: 412 (w) x 680 (h) x 28 (d) mm (16.22" x 26.77" x 1.10") BX-9F Back Box: 362 (w) x 628 (h) x 98 (d) mm (14.25" x 24.72" x 3.86") BX-9S Back Box: 412 (w) x 680 (h) x 98 (d) mm (16.22" x 26.77" x 3.86")	
Weight	13.7 kg (30.20 lb) (without input modules and back box)	17.3 kg (38.14 lb) (without input modules and back box)
Other Features	Output disconnect for approx. 5 sec after power turned on. Muting Function: Accomplished by input modules.	

Notes

- The design and specifications are subject to change without notice for improvement.
- (D): Direct output, (T): Transformer output
- Power Bandwidth and Frequency Response are from input port to power amplifier output.

• **Accessories**

Volume control cover YA-910	3	Machine screw M3 x 10	4
Key (for door)	2	Flange nut for M3	4
Lift-off hinge (receptacle)	2	Tapping screw 3 x 8	4
Machine screw M4 x 10*	5	Inch screw	4
Machine screw M3 x 6	6	Indication label	1

* Three screws are actually used and extra two are spare.

• **Optional products**

Flush-mounting (in-wall) back box:	BX-9F
Surface-mounting (on-wall) back box:	BX-9S
Expanding kit:	WE-2
Volume control cover (black):	YA-910

