

Smart Signage User Manual (By Model)

This manual provides information about your Smart Signage including supported types and product specifications per model.

QBR (QB13R QB13R-T)

The color and the appearance may differ depending on the product, and the content in the manual is subject to change without prior notice to improve the performance.

Recommended hours of use per day of this product is under 16 hours.

If the product is used for longer than 16 hours a day, the warranty may be void.

Table of contents

Preparations

Checking the Components	3
Using the STAND-BAR	4
Parts	5
Anti-theft Lock	6
Ports	7
QB13R	7
QB13R-T	8
Control menu	9
Administrator menu (Supported model: QB13R-T)	10
Safety Precautions	11
Electricity and Safety	11
Before Installing the Product (Installation Guide)	12
Tilting Angle and Rotation	12
Ventilation	12
Installing the Wall Mount	13
Installing the Wall Mount	13
Wall Mount Kit Specifications (VESA)	13

Using a touchscreen monitor (Supported model: QB13R-T)

Touchscreen monitor	14
Read below before using the product	14
Requirements	15
Connecting the touchscreen monitor	17
Connecting to a PC	17
Connecting to a laptop or tablet PC	17
Configuring the touchscreen monitor settings	18
Calibration	18
Controlling the screen	20
Touchscreen gestures	20
Notes	21

Specifications

General	22
Preset Timing Modes	23

Appendix

License	24
---------	----

Chapter 01

Preparations

Checking the Components

 Contact the vendor where you purchased the product if any components are missing.

 The appearance of the components may differ from the images shown.

 The RS232C adapter can be used to connect to another monitor using the D-SUB (9-pin) type RS232C cable.

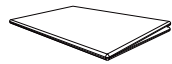

Quick Setup Guide



Warranty card
(Not available in some locations)



Regulatory guide



Power cord

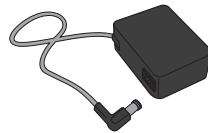

AC/DC adapter

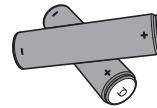

Batteries (AAA x 2)
(Not available in some locations)



Remote Control

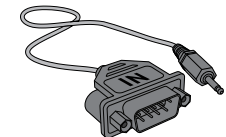

RS232C adapter

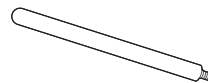

STAND-BAR x 2

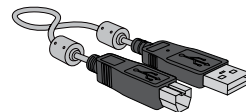

TOUCH OUT cable
(Supported model: QB13R-T)

Using the STAND-BAR

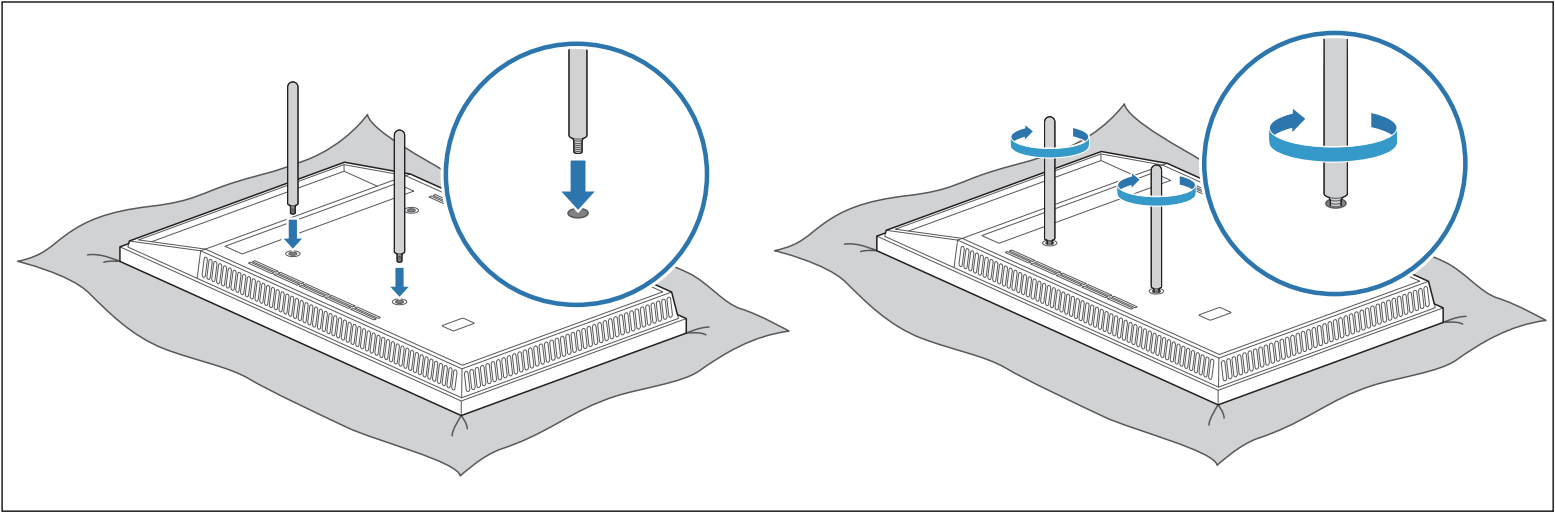

Place the product with the face down on top of the protective cloth or cushion.
Insert the bar into a slot on the product and then turn to fasten.

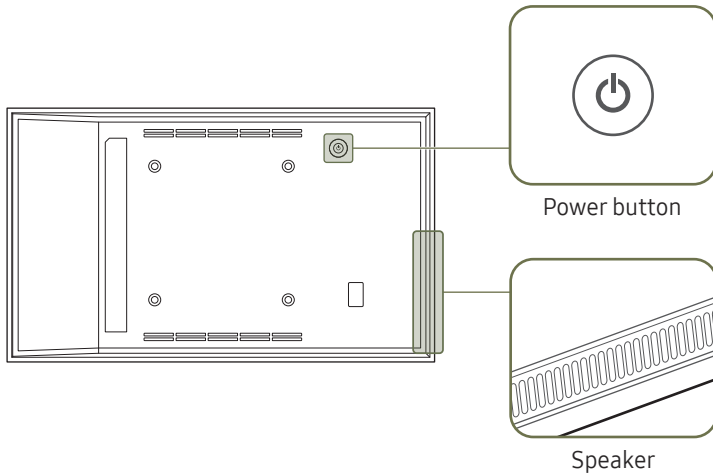
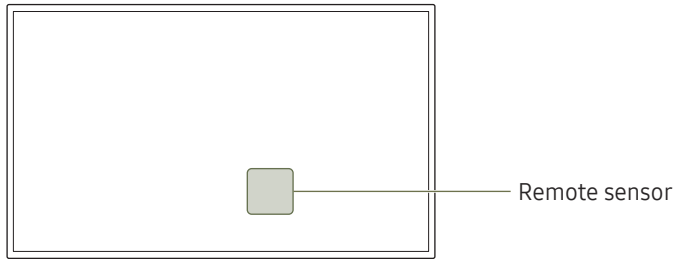

Parts





 The color and shape of parts may differ from what is shown. Specifications are subject to change without notice to improve quality.

Parts	Description
Remote sensor	Press a button on the remote control pointing at the sensor on the front of the product to perform the corresponding function.  Using other display devices in the same space as the remote control of this product can cause the other display devices to be inadvertently controlled.
Power button	Turns the product on or off.

Use the remote control within 2.5 m to 4 m from the sensor on the product at an angle of 30° from the left and right.

-  Store used batteries out of reach of children and recycle.
-  Do not use a new and used battery together. Replace both batteries at the same time.
-  Remove batteries when the remote control is not to be used for an extended period of time.

Anti-theft Lock

-  An anti-theft lock allows you to use the product securely even in public places.
-  The locking device shape and locking method depend on the manufacturer. Refer to the user guide provided with your anti-theft locking device for details.
-  The following images are for reference only. Real-life situations may differ from what is shown in the images.

To lock an anti-theft locking device:

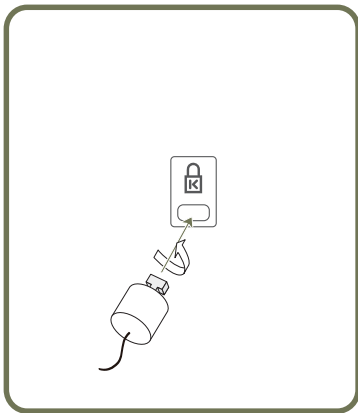



- 1 Fix the cable of your anti-theft locking device to a heavy object such as a desk.
- 2 Put one end of the cable through the loop on the other end.
- 3 Insert the locking device into the anti-theft lock slot at the back of the product.
- 4 Lock the locking device.
 - An anti-theft locking device can be purchased separately.
 - Refer to the user guide provided with your anti-theft locking device for details.
 - Anti-theft locking devices can be purchased at electronics retailers or online.

Ports

QB13R

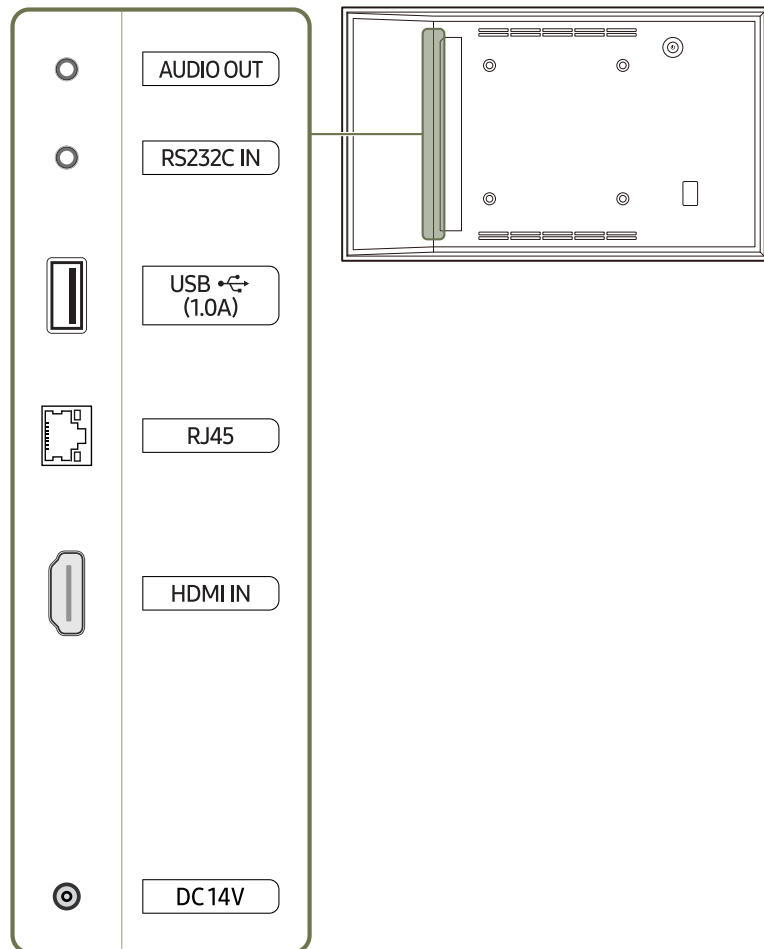
 The color and shape of parts may differ from what is shown. Specifications are subject to change without notice to improve quality.





Port	Description
AUDIO OUT	Outputs sound to an audio device via an audio cable.
RS232C IN	Connects to MDC using an RS232C adapter.
USB (1.0A)	Connect to a USB memory device.  The USB ports on the product accept a maximum constant current of 1.0A. If the maximum value is exceeded, USB ports may not work.
RJ45	Connects to MDC and the Internet using a LAN cable. (10/100 Mbps)  Use Cat7(*STP Type) cable for the connection. *Shielded Twist Pair.
HDMI IN	Connects to a source device using a HDMI cable or HDMI-DVI cable.
DC 14V	Connects to the AC/DC adapter.

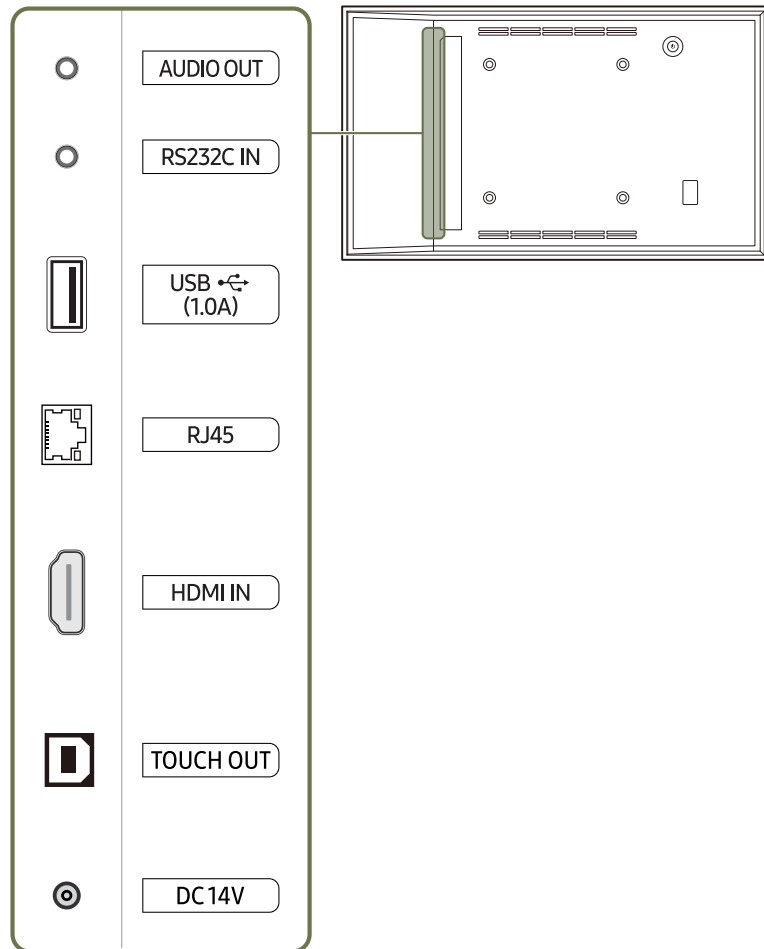

QB13R-T

 The color and shape of parts may differ from what is shown. Specifications are subject to change without notice to improve quality.





Port	Description
AUDIO OUT	Outputs sound to an audio device via an audio cable.
RS232C IN	Connects to MDC using an RS232C adapter.
USB  (1.0A)	Connect to a USB memory device.  The USB ports on the product accept a maximum constant current of 1.0A. If the maximum value is exceeded, USB ports may not work.
RJ45	Connects to MDC and the Internet using a LAN cable. (10/100 Mbps)  Use Cat7(*STP Type) cable for the connection. *Shielded Twist Pair.
HDMI IN	Connects to a source device using a HDMI cable or HDMI-DVI cable.
TOUCH OUT	Connects to a PC using a TOUCH OUT cable to enable touch functions.
DC14V	Connects to the AC/DC adapter.

Control menu

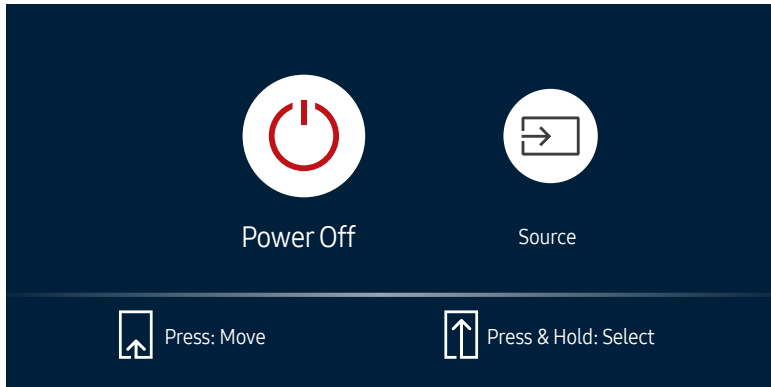
-  The power button (⏻) is located on the back of the product.
-  If you press the power button on the product when the product is turned on, the control menu will be displayed.











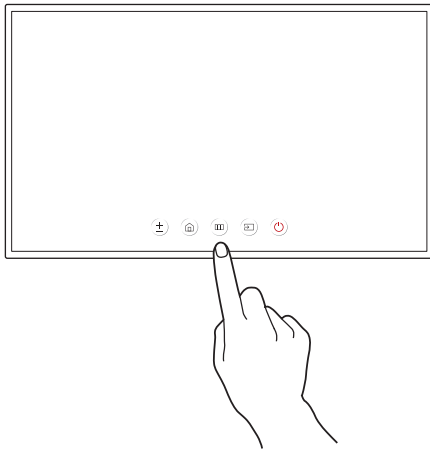

Items	Description
 Power Off	Power off the product. <ul style="list-style-type: none">With the control menu screen displayed, briefly press the power button to move the cursor to Power Off (⏻), and then press and hold the power button to turn off the product.
 Source	Select the connected input source. <ul style="list-style-type: none">With the control menu screen displayed, briefly press the power button to move the cursor to Source (➡), and then press and hold the power button to display the input source screen.With the input source screen displayed, press and hold the power button to switch to the desired input source.

-  The power button can only be used for **Power Off** and **Source**.
-  To exit from the control menu screen, wait for 3 seconds or more without pressing the power button.

Administrator menu (Supported model: QB13R-T)

- ✎ Touching and holding on the screen when the product is turned on displays the administrator menu.
- ✎ If the touchscreen control is not available, use the remote control to go to **System** → **Touch Control** → **Touch Control** and select **On** from the OSD menu. And go to **Device to Control** and select **Samsung SMART Signage** or **Auto**.
- ✎ If the administrator menu is not displayed, use the remote control to go to **System** → **Touch Control** → **Admin Menu Lock** and select **Off** from the OSD menu.



Buttons	Description
 Volume	Adjust the Volume . <ul style="list-style-type: none">• Select Volume  from the administrator menu.
 Home	Enter Home mode. <ul style="list-style-type: none">• Select Home  from the administrator menu.
 Menu	Display the OSD menu. To change settings, select a menu item. <ul style="list-style-type: none">• Select Menu  from the administrator menu.
 Source	Select the connected input source. Select an input source from the displayed list of input sources. <ul style="list-style-type: none">• Select Source  from the administrator menu.
 Power	Power off the product. <ul style="list-style-type: none">• Select Power  from the administrator menu.

Safety Precautions

Electricity and Safety

 The color and the appearance may differ depending on the model.

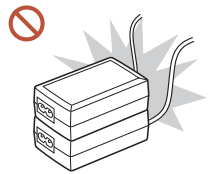

Do not put AC/DC adapters together.

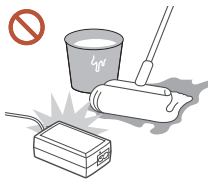

Do not let water enter the AC/DC adapter device or get the device wet.

- An electric shock or fire may result.
- Avoid using the product outdoors where it can be exposed to rain or snow.
- Be careful not to get the AC/DC adapter wet when you wash the floor.

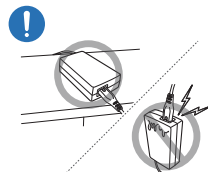

Make sure to rest the AC/DC power adapter flat on a table or the floor.

If you place the AC/DC power adapter hanging with the cord input facing upwards, water or other foreign substances could enter the adapter and cause it to malfunction.

 Remove the plastic bag from the AC/DC adapter before you use it.

 Keep the AC/DC adapter in a well-ventilated area.

Before Installing the Product (Installation Guide)

To prevent injury, this apparatus must be securely attached to the floor/wall in accordance with the installation instructions.

- Ensure that an authorized installation company installs the wall mount.
- Otherwise, it may fall and cause personal injury.
- Make sure to install the specified wall mount.

Tilting Angle and Rotation

Contact Samsung Customer Service Center for further details.

- The product can be tilted at a maximum angle of 15° from a perpendicular wall surface.
- To use the product in portrait orientation, rotate it clockwise.

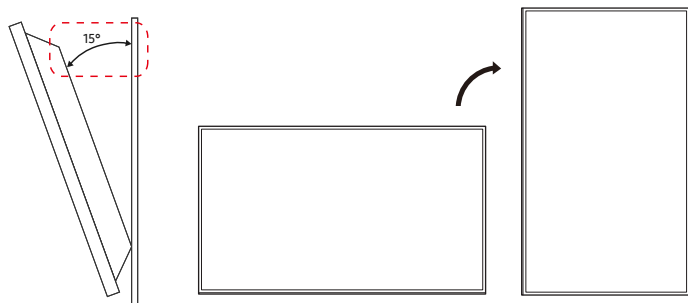

Do not use this model installed on a ceiling, floor, or table.

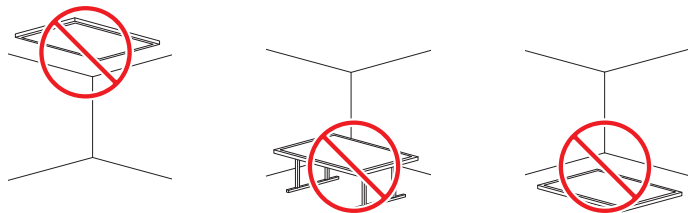

Ventilation

Contact Samsung Customer Service Center for further details.

Installation on a Perpendicular Wall

A Minimum 50 mm

B Ambient temperature

QB13R: Under 35 °C

QB13R-T: Under 30 °C

When installing the product on a perpendicular wall, allow at least 50 mm of space between the product and wall surface for ventilation and ensure that the ambient temperature is kept below 35 °C (QB13R) and 30 °C (QB13R-T).

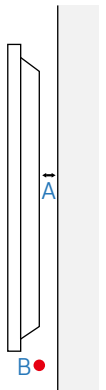

Installation on an Indented Wall

A Minimum 50 mm

B Minimum 70 mm

C Minimum 50 mm

D Minimum 50 mm

E Ambient temperature

QB13R: Under 35 °C

QB13R-T: Under 30 °C

When installing the product on an indented wall, allow at least the space specified above between the product and wall for ventilation and ensure that the ambient temperature is kept below 35 °C (QB13R) and 30 °C (QB13R-T).

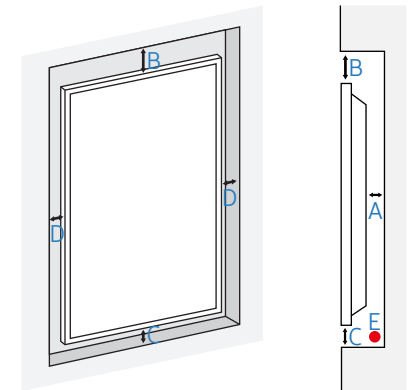

Installing the Wall Mount

Installing the Wall Mount

- The wall mount kit (sold separately) allows you to mount the product on the wall.
- The provided image is only for reference. For detailed information on installing the wall mount, see instructions provided with the wall mount.
- We recommend you contact a technician for assistance when installing the wall mount bracket.
- Samsung Electronics is not responsible for any damage to the product or injury to yourself or others if you select to install the wall mount on your own.

Wall Mount Kit Specifications (VESA)

 Install your wall mount on a solid wall perpendicular to the floor. To install the product on the other wall area, contact the nearest agency. If you install the product on a slanted wall, it may fall and result in severe personal injury.

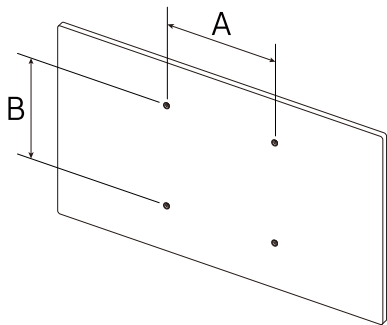

- Do not use screws that are longer than the standard length or do not comply with the VESA standard screw specifications. Screws that are too long may cause damage to the inside of the product.
- For wall mounts that do not comply with the VESA standard screw specifications, the length of the screws may differ depending on the wall mount specifications.
- Do not fasten the screws too firmly. This may damage the product or cause the product to fall, leading to personal injury. Samsung is not liable for these kinds of accidents.
- Samsung is not liable for product damage or personal injury when a non-VESA or non-specified wall mount is used or the consumer fails to follow the product installation instructions.
- Do not mount the product at more than a 15 degree tilt.
- Always have at least two people mount the product on a wall.
- Standard dimensions for wall mount kits are shown in the table below.

Model Name	VESA screw hole specs (A * B) in millimeters	Standard Screw	Quantity
QB13R / QB13R-T	100 × 100	M4	4

 Do not install your Wall Mount Kit while your product is turned on. It may result in personal injury due to electric shock.

Chapter 02

Using a touchscreen monitor (Supported model: QB13R-T)

Touchscreen monitor

Control a PC by tapping the screen instead of using an input device such as a keyboard or mouse. The touch screen functions by detecting a minute electric current that runs through your body (capacitive). Make sure to use the surface of your finger tip when tapping the screen.

 To control the touchscreen of a PC connected to the product, select **System** → **Touch Control** → **Device to Control** → **Connected Source Device** or **Auto** from the OSD menu.

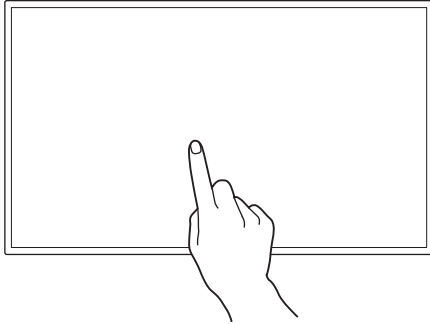

Read below before using the product

- Take extra care to ensure an electrical substance does not contact the screen. The screen may not function properly if there is static.
- Do not press hard on the touchscreen with your finger tip. Do not use a sharp object when tapping the screen. The screen may break or get damaged.
- Do not tap the screen while wearing a glove, with a dirty finger, or using something sharp such as your fingernail or a ballpoint pen. The screen may not function properly.
- Take extra care to ensure the screen does not contact moisture. The touch sensor may not function properly.
- Displaying a still image on the screen for an extended period of time may cause after images (screen degradation) or stains. Switch off the screen when not in use.

Requirements

Compatible operating systems

OS				Single	Multi	Gestures	Plug & Play	FW upgrade	Remark
Windows	Win10	Professional	32/64bit	0	0	0	0	0	
		Home		0	0	0	0	0	
	Win8.1	Professional	32/64bit	0	0	0	0	0	
		Enterprise		0	0	0	0	0	
	Win8	Professional	32/64bit	0	0	0	0	0	
		Enterprise		0	0	0	0	0	
	Win7	Ultimate	32/64bit	0	0	0	0	0	
		Enterprise		0	0	0	0	0	
		Professional		0	0	0	0	0	
		Home premium		0	0	0	0	0	
		Home Basic		X	X	X	X	X	
		Starter		X	X	X	X	X	
	Vista	Home Premium	32/64bit	X	X	X	X	X	
	Win XP	Professional	32/64bit	X	X	X	X	X	
Home		X		X	X	X	X		
Embedded	Win7		0	0	0	Δ	X		
	Win XP	32/64bit	X	X	X	X	X		

OS				Single	Multi	Gestures	Plug & Play	FW upgrade	Remark
Mac OSX	Lion	10.7.5	-	0	0	0	X	X	Device Driver : UPDD_06_00_426.DMG
	Mountain Lion	10.8.5	-	0	0	0	X		
	Mavericks	10.9.5	-	0	0	0	X		
	Yosemite	10.10.5	-	0	0	0	X		
	EL Capitan	10.11.6	-	0	0	0	X		
	Sierra	10.12	-	0	0	0	X		
	High Sierra	10.13	-	0	0	0	X		
Linux	Ubuntu	12.04 and later	32/64bit	0	0	X	0	X	Linux : Kernel version 3.15 and later : Linux IN-BOx Driver Kernel version 2.6.39~3.0.8 :ilitek_limv3_8_6
	Fedora	16 and later		0	0	X	0		
	OpenSUSE	12.2 and later		0	0	X	0		
	CentOS	-		X	X	X	X		
	Mint	17.2 and later		0	0	X	0		
VD Linux	SoC touch	Tizen 4.0	-	0	0	0	0	X	

Connecting the touchscreen monitor

 Connecting parts may differ in different products.

Connecting to a PC

- 1 Connect your PC to the product using a HDMI or HDMI-DVI cable.

Connecting the devices using a HDMI cable

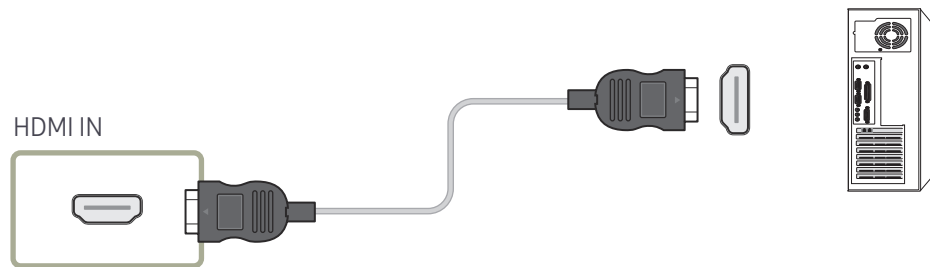

Connecting the devices using a HDMI-DVI cable

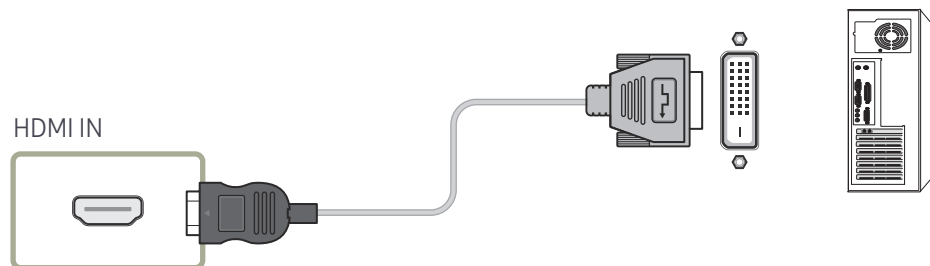

- 2 Connect the power cable from the product to the power outlet.
- 3 After the power supply is connected, the product automatically detects and switches to the connected input source.
 -  If the screen appears blank, turn the product off and then on again.
- 4 Connect the TOUCH OUT port on the product to a USB port on the PC using the TOUCH OUT cable.

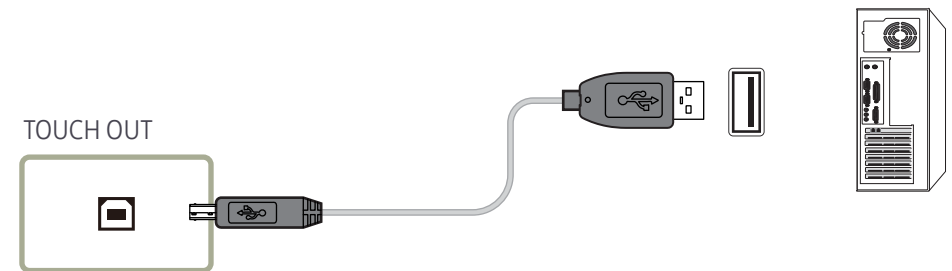

Connecting to a laptop or tablet PC

A laptop or tablet PC can be connected to the product using the same method when connecting a desktop PC.

-  If touchscreen control is not available after the devices are connected
 - Make sure to connect the HDMI or HDMI-DVI cable before connecting the TOUCH OUT cable.
 - If touchscreen control is still unavailable after the cables are connected properly, disconnect the TOUCH OUT cable and then connect it again.

Configuring the touchscreen monitor settings

To properly use the touch function of the product in Windows, go to **Tablet PC Settings** and calibrate the product.

- ✎ First connect the touchscreen monitor before configuring the following settings.
- ✎ The maximum number of touchscreen monitors that can be connected simultaneously varies, depending on the operating system and graphics card settings.
- ✎ If **Tablet PC Settings** is not found in **Control Panel**, search for **Tablet PC Settings** from **Search Control Panel**.
- ✎ If used in a multi-screen setup, make sure you have configured QB13R-T as the main display.

Calibration

- ✎ Instructions below are for Windows 8. The same method applies to both Windows 7, Windows 8 and Windows 10.
- ✎ After changing the **Picture Size** from the OSD menu, you may need to calibrate the picture settings again.
- ✎ Upon occurrence of an error during calibration, go to **Tablet PC Settings**. In the **Display** tab, tap **Reset** and calibrate again.

1 In the **Display** tab, select **Setup** under **Configure**.

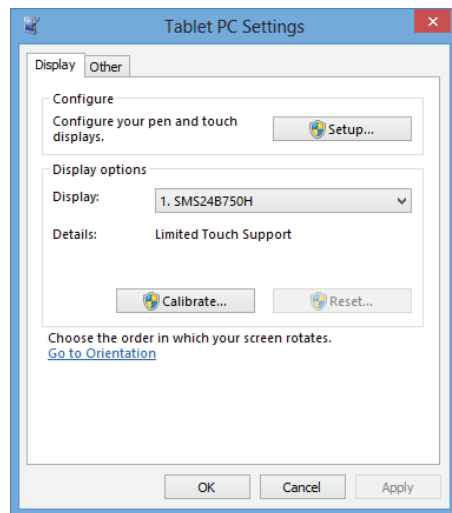

2 Tap the page displayed on the product with your finger.

- ✎ In dual monitor mode: If the following page does not appear on the product, press the Enter key to display the page.

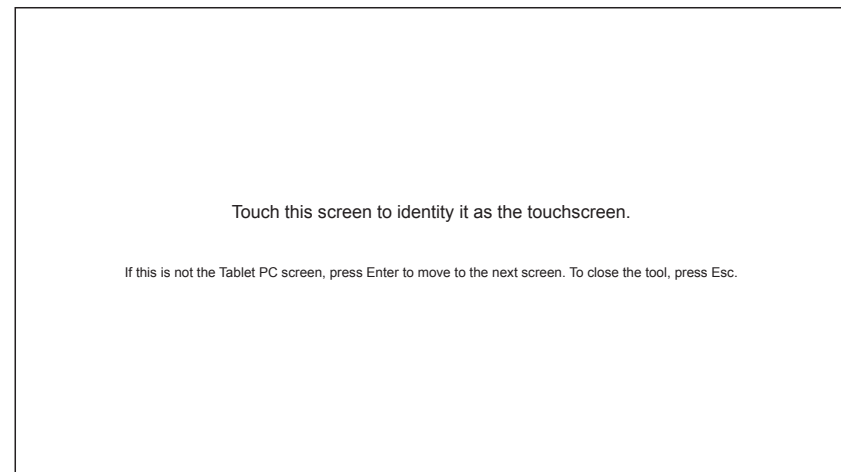

- 3 Select the product from Display under Display options. Next, select Calibrate.

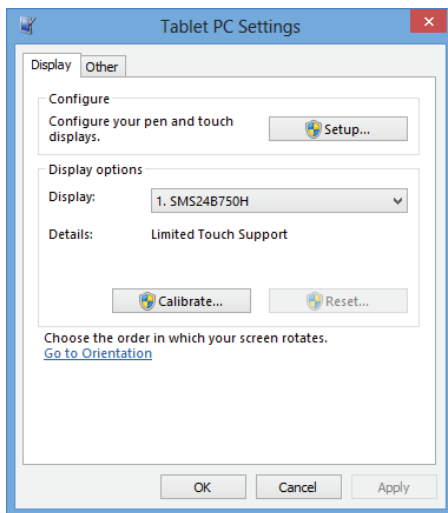

- 4 Perform calibration following the onscreen instructions displayed as shown in the image.

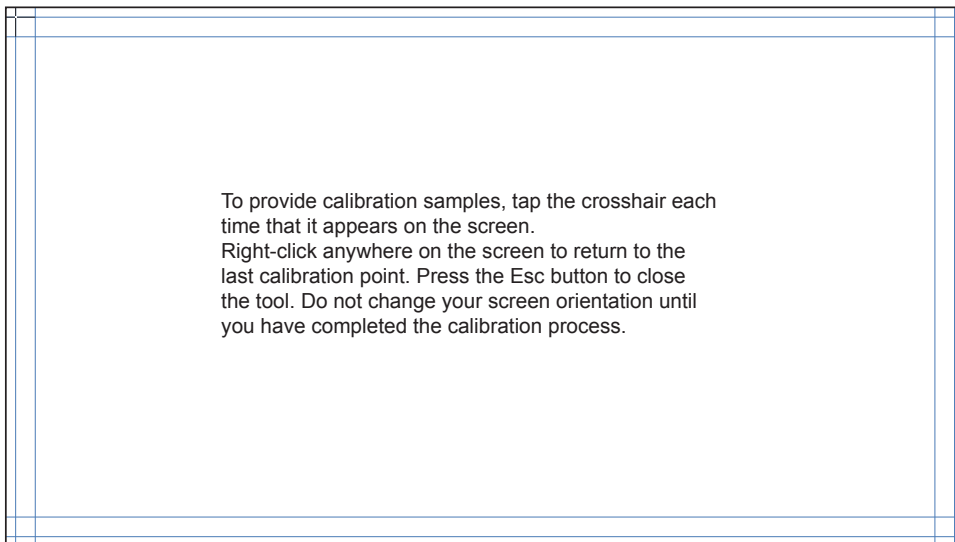

- 5 After calibration is complete, the message Do you want to save the calibration data? appears. Select Yes.

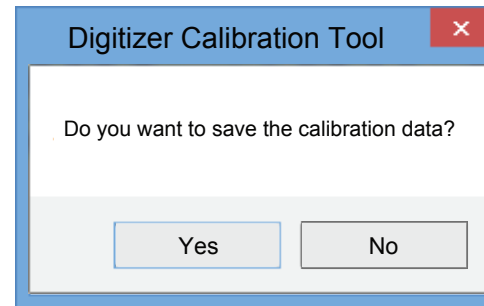

- 6 The touchscreen monitor has been calibrated successfully.

 Selecting Reset will remove the calibration data.

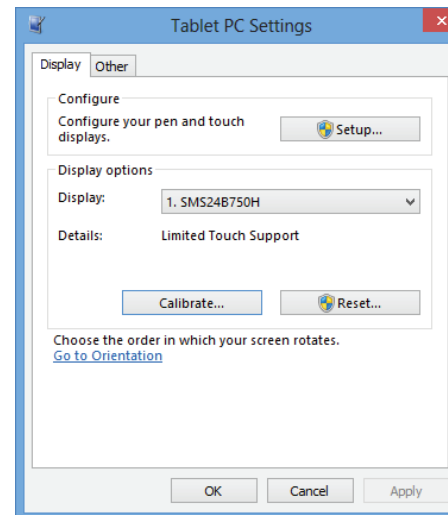

Controlling the screen

Touchscreen gestures

Using touchscreen gestures is similar to using a mouse.

 The device that receives the touchscreen's gesture inputs can be set in **System** → **Touch Control** → **Device to Control**.

Tap

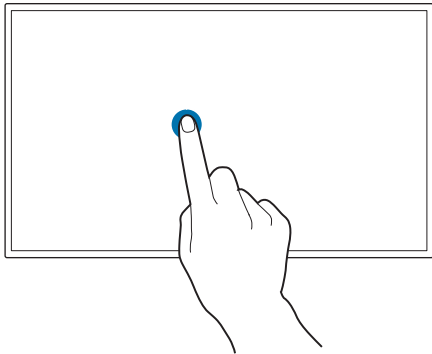

Lightly tap the screen.

Use this gesture to select a feature or menu item.

 It is similar to clicking on a mouse.

Drag

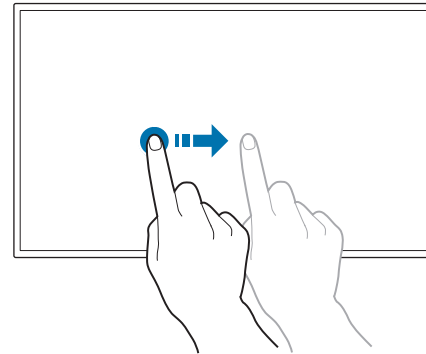

Lightly touch and drag in any direction on the screen.

Use this gesture to move in a specific direction on a web page, map or photo.

 It is similar to dragging a mouse.

Double tap

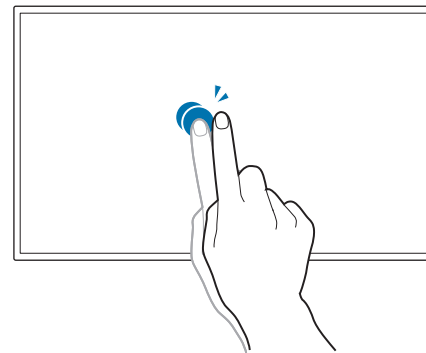

Tap the screen twice.

Use this gesture to run the selected program.

 It is similar to double-clicking on a mouse.

Flick

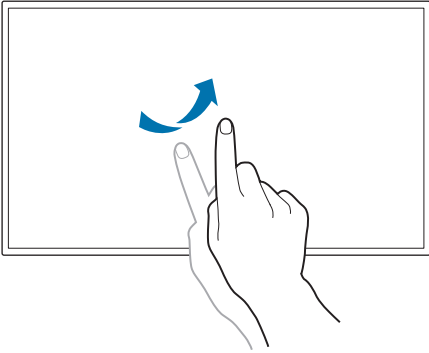

Flick your finger on the screen as shown in the image.
Use this gesture to go to the previous or next picture or web page.

Zoom in/out

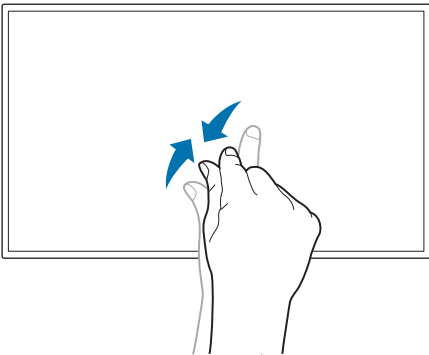

Spread or pinch your fingers on the screen as shown in the image.
Use these gestures to zoom in or out respectively on a web page, map or photo.

Notes





- To increase the touch input accuracy, enlarge the font or icons.
- In touchscreen control mode, use of the remote control when precise clicks or inputs are required is more effective.

Chapter 03

Specifications

General

Model Name		QB13R / QB13R-T
Panel	Size	13 CLASS (13.27 inches / 33.7 cm)
	Display area	295.37 mm (H) x 166.49 mm (V)
Resolution	Optimum resolution	1920 × 1080 @ 60 Hz
	Maximum resolution	
Power Supply		AC100-240V~ 50/60Hz Based on the AC voltage of the adapter. For the DC voltage of the product, refer to the product label.
Environmental considerations	Operating	Temperature: 32 °F – 104 °F (0 °C – 40 °C) * For installing the enclosure, keep the internal temperature at 30 °C or below. Humidity: 10% – 80%, non-condensing
	Storage	Temperature: -4 °F – 113 °F (-20 °C – 45 °C) Humidity: 5% – 95%, non-condensing * Applicable before the product package is unpacked.
Wireless Network		802.11 b/g/n(2.4Ghz)

-  **Plug-and-Play**
This monitor can be installed and used with any Plug-and-Play compatible systems. Two-way data exchange between the monitor and PC system optimizes the monitor settings. Monitor installation takes place automatically. However, you can customize the installation settings if desired.
-  **Due to the nature of the manufacturing of this product, approximately 1 pixel per million (1ppm) may appear brighter or darker on the panel. This does not affect product performance.**
-  **This product can be set to only one resolution for each screen size to obtain the optimum picture quality due to the nature of the panel. Using a resolution other than the specified resolution may degrade the picture quality. To avoid this, it is recommended that you select the optimum resolution specified for your product.**
-  **For detailed device specifications, visit the Samsung Electronics website.**

Preset Timing Modes

The screen will automatically be adjusted if a signal that belongs to the following standard signal modes is transmitted from your PC. If the signal transmitted from the PC does not belong to the standard signal modes, the screen may become blank. In such a case, change the settings according to the following table by referring to the graphics card user manual.

Resolution	Horizontal Frequency (kHz)	Vertical Frequency (Hz)	Pixel Clock (MHz)	Sync Polarity (H/V)
IBM, 640 x 480	31.469	59.940	25.175	-/-
IBM, 720 x 400	31.469	70.087	28.322	-/+
MAC, 640 x 480	35.000	66.667	30.240	-/-
MAC, 832 x 624	49.726	74.551	57.284	-/-
MAC, 1152 x 870	68.681	75.062	100.000	-/-
VESA, 640 x 480	31.469	59.940	25.175	-/-
VESA, 640 x 480	37.861	72.809	31.500	-/-
VESA, 640 x 480	37.500	75.000	31.500	-/-
VESA, 800 x 600	35.156	56.250	36.000	+/+
VESA, 800 x 600	37.879	60.317	40.000	+/+
VESA, 800 x 600	48.077	72.188	50.000	+/+
VESA, 800 x 600	46.875	75.000	49.500	+/+
VESA, 1024 x 768	48.363	60.004	65.000	-/-
VESA, 1024 x 768	56.476	70.069	75.000	-/-
VESA, 1024 x 768	60.023	75.029	78.750	+/+
VESA, 1152 x 864	67.500	75.000	108.000	+/+
VESA, 1280 x 720	45.000	60.000	74.250	+/+
VESA, 1280 x 800	49.702	59.810	83.500	-/+

Resolution	Horizontal Frequency (kHz)	Vertical Frequency (Hz)	Pixel Clock (MHz)	Sync Polarity (H/V)
VESA, 1280 x 1024	63.981	60.020	108.000	+/+
VESA, 1280 x 1024	79.976	75.025	135.000	+/+
VESA, 1366 x 768	47.712	59.790	85.500	+/+
VESA, 1440 x 900	55.935	59.887	106.500	-/+
VESA, 1600 x 900	60.000	60.000	108.000	+/+
VESA, 1680 x 1050	65.290	59.954	146.250	-/+
VESA, 1920 x 1080	67.500	60.000	148.500	+/+

Chapter 04

Appendix

License



Manufactured under license from Dolby Laboratories. Dolby, Dolby Audio, Pro Logic, and the double-D symbol are trademarks of Dolby Laboratories.



The terms HDMI and HDMI High-Definition Multimedia Interface, and the HDMI Logo are trademarks or registered trademarks of HDMI Licensing LLC in the United States and other countries.

Open Source License Notice

In the case of using open source software, Open Source Licenses are available on the product menu. Open Source License Notice is written only English.

For information on the Open Source License Notice, contact the Samsung Customer Center or send email to oss.request@samsung.com.



THIS PRODUCT IS SOLD WITH A LIMITED LICENCE AND IS AUTHORISED TO BE USED ONLY IN CONNECTION WITH HEVC CONTENT THAT MEETS EACH OF THE THREE FOLLOWING QUALIFICATIONS: (1) HEVC CONTENT ONLY FOR PERSONAL USE; (2) HEVC CONTENT THAT IS NOT OFFERED FOR SALE; AND (3) HEVC CONTENT THAT IS CREATED BY THE OWNER OF THE PRODUCT.

THIS PRODUCT MAY NOT BE USED IN CONNECTION WITH HEVC ENCODED CONTENT CREATED BY A THIRD PARTY, WHICH THE USER HAS ORDERED OR PURCHASED FROM A THIRD PARTY, UNLESS THE USER IS SEPARATELY GRANTED RIGHTS TO USE THE PRODUCT WITH SUCH CONTENT BY A LICENSED SELLER OF THE CONTENT.

YOUR USE OF THIS PRODUCT IN CONNECTION WITH HEVC ENCODED CONTENT IS DEEMED ACCEPTANCE OF THE LIMITED AUTHORITY TO USE AS NOTED ABOVE.
