



HDMI 2.0 4K60Hz Over IP Extender/Matrix with IR - Kit

User Manual



Important Instructions

- Suggest using IGMP switches
- Do not mix up transmitter and receiver before installation.
- Channel of the transmitter(TX) must be different, otherwise, the system would be break down (including transmitter, receiver, IGMP switch etc.).

Product Features

1. Resolution supported is up to 4K 60Hz.
2. Transmission distance is up to 120 meters via CAT6.
3. Support IR pass back function to control source device from RX location.
4. Offers scalable and flexible input-output matrix configuration, allows 100 input to infinite output.
5. Supports computer control software to select and switch source device input..

Package Contents

1. Transmitter unit / Receiver unit
2. User Manual
3. IR blaster / receiver extension cable
4. Power adapter DC5V/3A x 2
5. Remote control
6. Wall-mount kit x 2

Layout

Transmitter unit

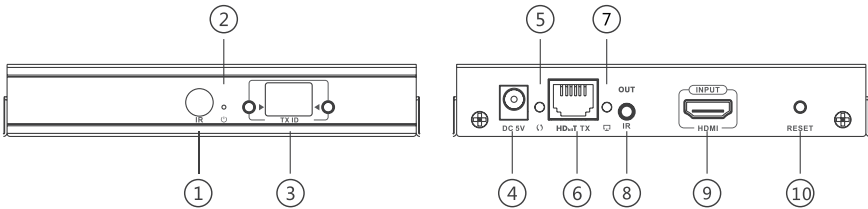

1. IR Window	Receives IR signals from the included remote control to set/select the channel
2. Power LED	On when transmitter is powered on
3. TX ID	Displays transmitter's ID number
4. Power Jack	Connects to the included power adapter
5. Data LED	Blinks when data transmission is detected
6. RJ45 Output	Connects to the receiver's RJ45 Input using a CAT5e/6 cable
7. Link LED	Lights up when RJ45 signal detected
8. IR Output	Connects to the IR Blaster extension cable
9. HDMI Input	Connects to the HDMI source device
10. Reset button	Press for restarting the unit

Receiver unit

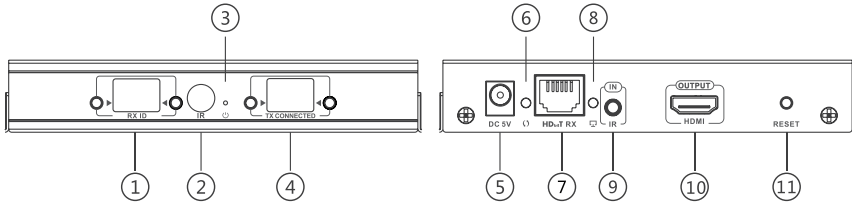

1. RX ID	Displays the receiver's ID number
2. IR Window	Receives IR signals from the included remote control to set/select the channel
3. Power LED	On when receiver is powered on
4. TX Connected	Displays transmitter's ID number for device pairing
5. Power Jack	Connects to the included power adapter
6. Data LED	Blinks when data transmission is detected
7. RJ45 Input	Connects to the transmitter's RJ45 Output using a CAT5e/6 cable
8. Link LED	Lights up when RJ45 signal detected
9. IR Input	Connects to the IR receiver extension cable
10. HDMI Out	Connects to a HDMI display
11. Reset button	Press for restarting the unit

Application

Point to point

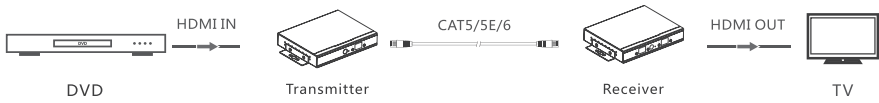

Matrix configuration

Maximum 256 combined units, limited to 100 transmitter units.

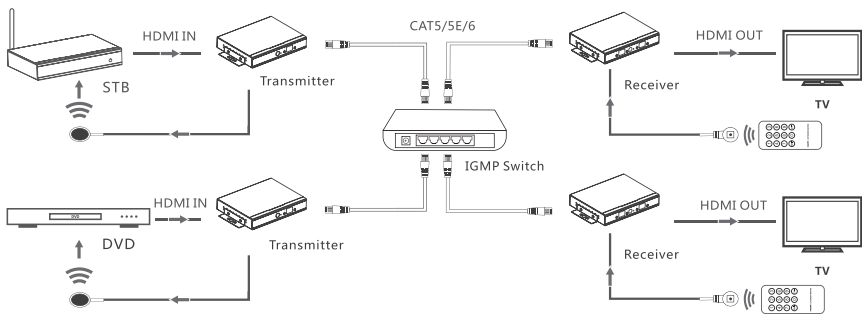

Note:

We recommend CAT5e/6 with 100% copper wiring and IEEE-568B wiring standard.

Dedicated IGMP Gigabit Ethernet switches are recommended for the best performance and reliability.

When connecting to an existing LAN environment, it's recommended to configure a VLAN dedicated to these transmitter(s) and receiver(s) to avoid traffic collision with other networking devices.

The transmitter's and receiver's default IP address is 192.168.1.238 and 192.168.1.239 respectively. If your existing network is DHCP enabled, the transmitter(s) and receiver(s) will be assigned with IP addresses automatically when connected and turned on. Press the reset button on each transmitter and receiver if an IP address is not assigned automatically.

Resetting to Default IP Address

The Transmitter's default IP address is 192.168.1.238, the Receiver's default IP address is 192.168.1.239. If you need to reset the units to the default IP address simply disconnect the TX or RX unit from the IP network, then quickly press the Reset button. Wait several seconds and power off and on the units.

IR User Guide

IR Extension Cables

The IR Blaster extension cable should be plugged into the IR Out port of the transmitter and the IR Receiver extension cable should be plugged into the IR In port of the receiver. The emitter of the IR Blaster extension cable should be placed as close to the IR receiver window of the source device.

Remote Control

Use the included remote control to set/select the TX ID on the transmitter and the TX connected ID on the receiver for device pairing.

Device ID Control User Guide

Press the left or right button control to change the Device ID and Connection ID to the desired number. To connect to the desired HDMI source device, set the Receiver's TX Connected ID to match the Transmitter's TX ID for successful device pairing.

Computer Control User Guide

The HDbitt E-Matrix Control Center application is compatible with Windows only. Download it from www.hdbitt.com/download-matrix.

1. Connect your Windows computer to the Ethernet network.
2. For **non-DHCP** networks:
Change your computer's IP address to 192.168.1.xxx (xxx can be 0 to 255, excluding 238 & 239), the same subnet as your TX and RX unit.
For **DHCP** enabled networks:
Enable DHCP on your computer and connect it to the network.
(Note: If DHCP is enabled simply plug into your network)
3. Open the application, the interface is displayed.

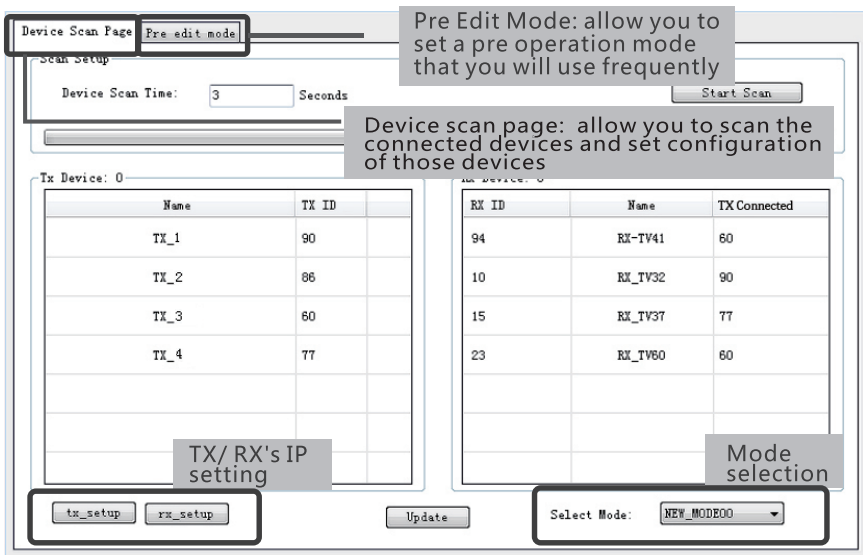

Note: If the Matrix Control Center application is not working properly. Close and restart it to clear the previous settings.

IP Setting

The Transmitter's default IP address is 192.168.1.238, the Receiver's default IP address is 192.168.1.239. There is no need to change the IP address even when multiple transmitters and/or receivers are connected to your IP network simultaneously. However, if a change is needed follow the steps below.

1. Click Tx setup
2. Enter the desired IP address, click Update to save the changes.

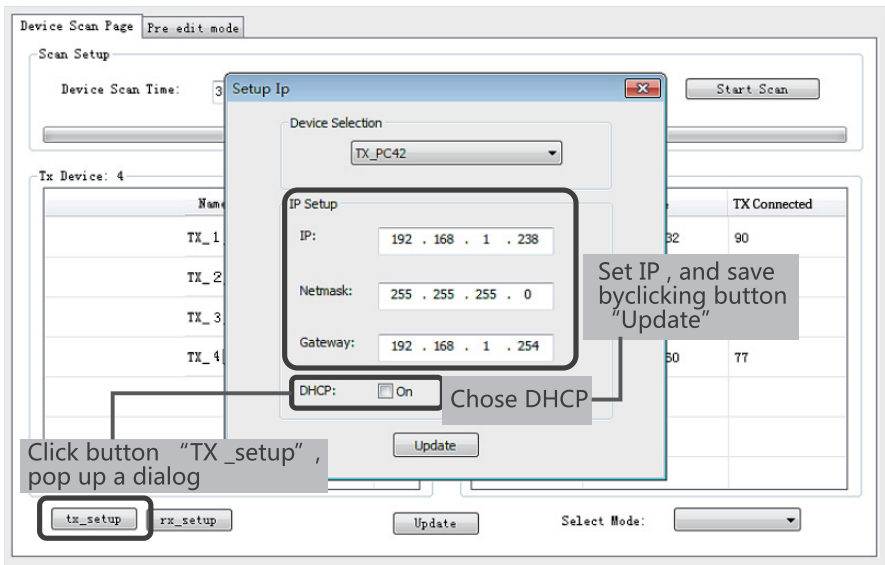

The screenshot shows the 'Device Scan Page' in 'Pre edit mode'. A 'Setup Ip' dialog box is open, displaying the following information:

- Device Selection: TX_PC42
- IP Setup:
 - IP: 192 . 168 . 1 . 238
 - Netmask: 255 . 255 . 255 . 0
 - Gateway: 192 . 168 . 1 . 254
- DHCP: On

Callouts in the image provide instructions:

- 'Click button "TX_setup", pop up a dialog' points to the 'tx_setup' button in the main window.
- 'Chose DHCP' points to the checked 'DHCP' checkbox in the dialog.
- 'Set IP, and save by clicking button "Update"' points to the 'Update' button in the dialog.

Device Name

Use this section to change the device name.

1. Click Start Scan to open the editing window
2. Double click on a TX unit to update, then click OK to save the changes

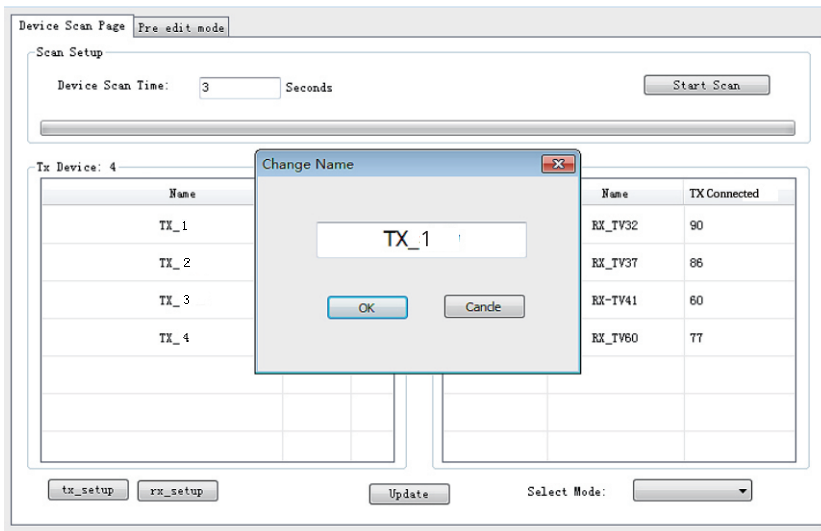
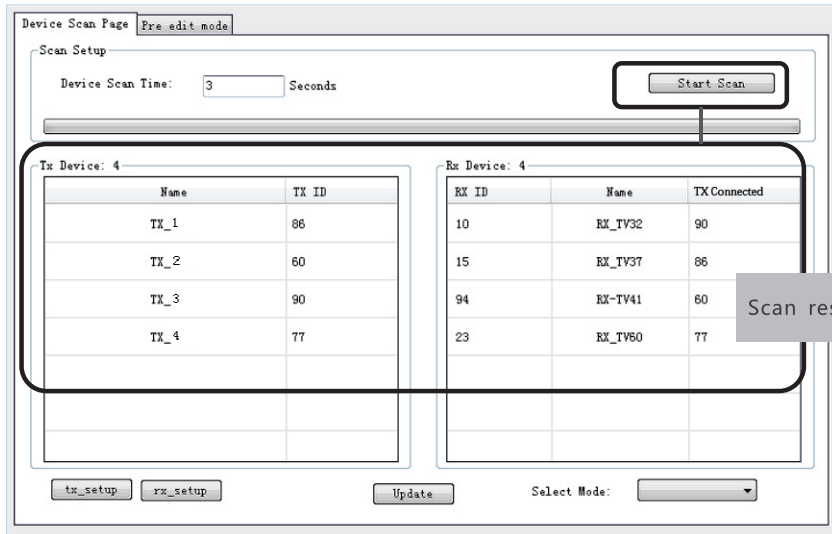

Device ID

1. Click on TX ID of the device you want to change, select an available ID from the drop down box.
2. Click Update to save the changes.

Device Scan Page Pre edit mode

Scan Setup

Device Scan Time: Seconds Start Scan

Tx Device: 4

Name	TX ID
TX_1	87
TX_2	83
	84
	85
TX_3	86
	87
	88
TX_4	89
	91
	92
	93
	94
	95
	96
	97
	98
	99

Rx Device: 4

RX ID	Name	TX Connected
10	EX_TV32	90
15	EX_TV37	86
94	EX-TV41	60
23	EX_TV60	77

tx_setup rx_setup Update Select Mode:

Operating Modes

An operating mode is a group of input and output devices allowing easy selection of desired viewing outcome quickly and stress free.

1. Click on Pre edit mode tab.
2. Select the input and output IDs.
3. Enter a name for the operating mode, then press OK to save.

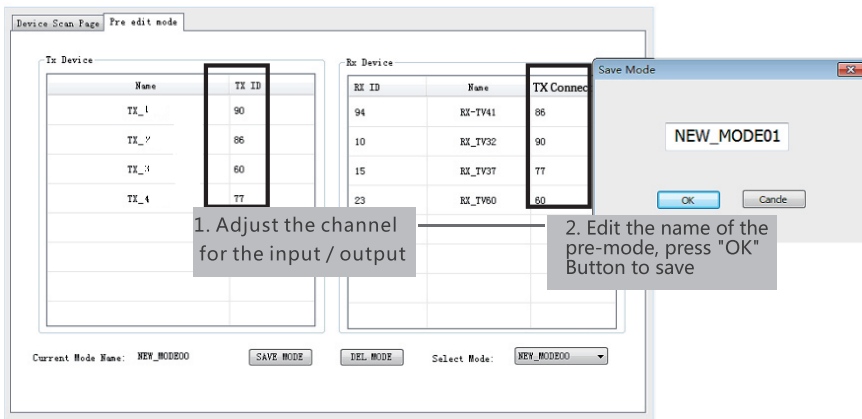

The screenshot shows the 'Pre edit mode' window with two tables for device selection and a 'Save Mode' dialog box. The 'Tx Device' table has columns 'Name' and 'TX ID'. The 'Rx Device' table has columns 'RX ID', 'Name', and 'TX Connect'. The 'Save Mode' dialog box has a text input field containing 'NEW_MODE01' and 'OK' and 'Cancel' buttons.

1. Adjust the channel for the input / output

2. Edit the name of the pre-mode, press "OK" Button to save

Name	TX ID
TX_1	90
TX_2	86
TX_3	60
TX_4	77

RX ID	Name	TX Connect
94	RX-TV41	86
10	RX_TV32	90
15	RX_TV37	77
23	RX_TV60	60

Current Mode Name: NEW_MODE00 SAVE MODE DEL MODE Select Mode: NEW_MODE00

Operating Mode Selection

1. Click on Select Mode.
2. Choose the desired operating mode.

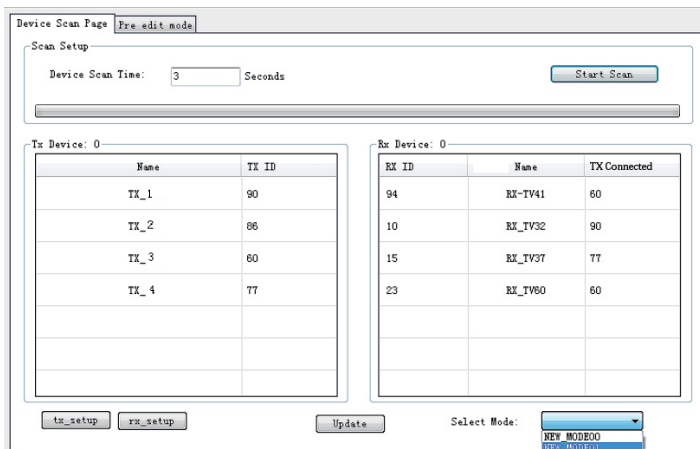

The screenshot shows the 'Pre edit mode' window with the 'Scan Setup' section and the 'Select Mode' dropdown menu. The 'Scan Setup' section has a 'Device Scan Time' field set to 3 seconds and a 'Start Scan' button. The 'Tx Device' and 'Rx Device' tables are shown below. The 'Select Mode' dropdown menu is open, showing 'NEW_MODE00' and 'NEW_MODE01' options.

Device Scan Time: 3 Seconds Start Scan

Tx Device: 0

Name	TX ID
TX_1	90
TX_2	86
TX_3	60
TX_4	77

Rx Device: 0

RX ID	Name	TX Connected
94	RX-TV41	60
10	RX_TV32	90
15	RX_TV37	77
23	RX_TV60	60

tx_setup rx_setup Update Select Mode: NEW_MODE00
NEW_MODE01

Wireless Control APP

Requires connecting a Wireless Router/Access point to the dedicated LAN.

1. Download the “Matrix Control Lite” wireless APP for Android or Apple from www.hdbitt.com/download-matrix.
2. Connect your DHCP enabled Wireless Router/Access point to your dedicated LAN.
3. Log into your Wireless Router/Access point.
4. Open the Matrix Control Lite App.
5. Press Scan to display the TX and RX units. It may take a few moments for the screen to refresh.

Device Scan Time: <input type="text" value="5"/>	scan				
Tx Device:		Rx Device:			
Name	TX ID	RX ID	Name	TX Connected	

Note: If the TX and RX units are not detected after pressing Scan several times, press the Reset button on all TX and RX units and press Scan again.

Support

For more info or tech support
<http://www.siig.com/support>