



Digital Projector

User Manual

Warranty and Copyright information

Limited warranty

BenQ warrants this product against any defects in material and workmanship, under normal usage and storage.

Proof of purchase date will be required with any warranty claim. In the event this product is found to be defective within the warranty period, BenQ's only obligation and your exclusive remedy shall be replacement of any defective parts (labor included). To obtain warranty service, immediately notify the dealer from which you purchased the product of any defects.

Important: The above warranty shall be void if the customer fails to operate the product in accordance with BenQ's written instructions, especially the ambient humidity must be in-between 10% and 90%, temperature in-between 0°C and 35°C, altitude lower than 4920 feet, and avoiding to operate the projector in a dusty environment. This warranty gives you specific legal rights, and you may have other rights which vary from country to country.

For other information, please visit www.BenQ.com.

Copyright

Copyright © 2018 by BenQ Corporation. All rights reserved. No part of this publication may be reproduced, transmitted, transcribed, stored in a retrieval system or translated into any language or computer language, in any form or by any means, electronic, mechanical, magnetic, optical, chemical, manual or otherwise, without the prior written permission of BenQ Corporation.

Disclaimer

BenQ Corporation makes no representations or warranties, either expressed or implied, with respect to the contents hereof and specifically disclaims any warranties, merchantability or fitness for any particular purpose. Further, BenQ Corporation reserves the right to revise this publication and to make changes from time to time in the contents hereof without obligation to notify any person of such revision or changes.

*DLP, Digital Micromirror Device and DMD are trademarks of Texas Instruments. Others are copyrights of their respective companies or organizations.

Patents

Please go to <http://patmarking.benq.com/> for the details on BenQ projector patent coverage.

Table of Contents

Warranty and Copyright information	2
Important safety instructions	4
Introduction	7
Shipping contents	7
Projector exterior view	8
Controls and functions.....	9
Positioning your projector	12
Choosing a location	12
Obtaining a preferred projected image size.....	13
Mounting the projector	14
Adjusting the projected image	15
Connection	17
Operation	19
Starting up the projector	19
Using the menus	20
Securing the projector	21
Switching input signal	23
Shutting down the projector	23
Direct power off	23
Menu operation	24
Basic menu	24
Advanced menu	26
Maintenance	35
Care of the projector	35
Lamp information	35
Troubleshooting	41
Specifications	42
Projector specifications	42
Dimensions	43
Timing chart.....	44

Important safety instructions

Your projector is designed and tested to meet the latest standards for safety of information technology equipment. However, to ensure safe use of this product, it is important that you follow the instructions mentioned in this manual and marked on the product.

1. **Please read this manual before you operate your projector.** Save it for future reference.



2. **Do not look straight at the projector lens during operation.** The intense light beam may damage your eyes.



3. **Refer servicing to qualified service personnel.**



4. **Always open the lens shutter (if any) or remove the lens cap (if any) when the projector lamp is on.**

5. The lamp becomes extremely hot during operation. Allow the projector to cool for approximately 45 minutes prior to removing the lamp assembly for replacement.



6. In some countries, the line voltage is NOT stable. This projector is designed to operate safely within a mains voltage between 100 to 240 volts AC, but could fail if power cuts or surges of ± 10 volts occur. **In areas where the mains voltage may fluctuate or cut out, it is recommended that you connect your projector through a power stabilizer, surge protector or uninterruptible power supply (UPS).**



7. Do not block the projection lens with any objects when the projector is under operation as this could cause the objects to become heated and deformed or even cause a fire. To temporarily turn off the lamp, use the blank function.



8. Do not operate lamps beyond the rated lamp life. Excessive operation of lamps beyond the rated life could cause them to break on rare occasions.



9. Never replace the lamp assembly or any electronic components unless the projector is unplugged.



10. Do not place this product on an unstable cart, stand, or table. The product may fall, sustaining serious damage.

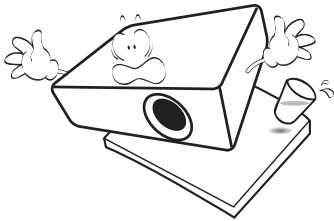

11. Do not attempt to disassemble this projector. There are dangerous high voltages inside which may cause death if you should come into contact with live parts. The only user serviceable part is the lamp which has its own removable cover.

Under no circumstances should you ever undo or remove any other covers. Refer servicing only to suitably qualified professional service personnel.

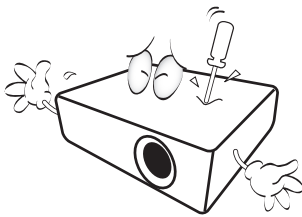

12. Do not block the ventilation holes.

- Do not place this projector on a blanket, bedding or any other soft surface.
- Do not cover this projector with a cloth or any other item.
- Do not place inflammables near the projector.

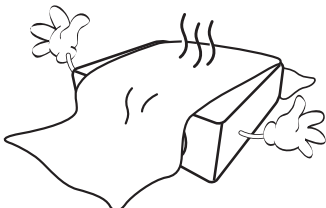

If the ventilation holes are seriously obstructed, overheating inside the projector may result in a fire.

13. Always place the projector on a level, horizontal surface during operation.

- Do not use if tilted at an angle of more than 10 degrees left to right, nor at angle of more than 15 degrees front to back. Using the projector when it is not fully horizontal may cause a malfunction of, or damage to, the lamp.



14. Do not stand the projector on end vertically. Doing so may cause the projector to fall over, causing injury or resulting in damage to the projector.



15. Do not step on the projector or place any objects upon it. Besides probable physical damage to the projector, doing so may result in accidents and possible injury.

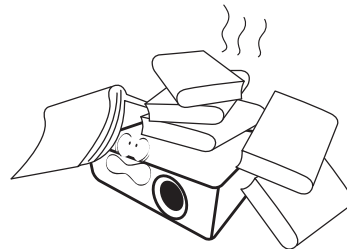

16. When the projector is under operation, you may sense some heated air and odor from its ventilation grill. It is a normal phenomenon and not a product defect.

17. Do not place liquids near or on the projector. Liquids spilled into the projector may cause it to fail. If the projector does become wet, disconnect it from the power supply's power outlet and call BenQ to have the projector serviced.

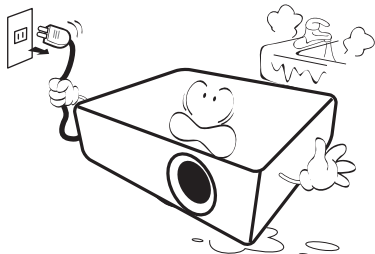

18. This product is capable of displaying inverted images for ceiling/wall mount installation.

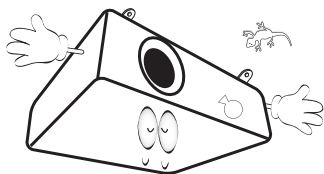

19. This apparatus must be earthed.

20. Do not place this projector in any of the following environments.

- Space that is poorly ventilated or confined. Allow at least 50 cm clearance from walls and free flow of air around the projector.
- Locations where temperatures may become excessively high, such as the inside of a car with all windows rolled up.
- Locations where excessive humidity, dust, or cigarette smoke may contaminate optical components, shorten the projector's life span and darken the image.

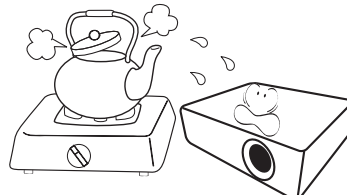

- Locations near fire alarms
- Locations with an ambient temperature above 40°C / 104°F
- Locations where the altitudes are higher than 3000 m (10000 feet).

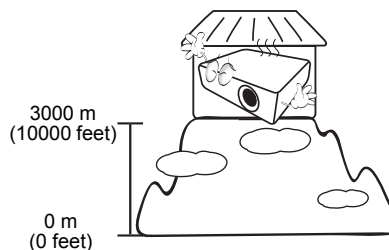

 Hg - Lamp contains mercury. Manage in accordance with local disposal laws. See www.lamprecycle.org.

Introduction

Shipping contents

Carefully unpack and verify that you have all of the items shown below. If any of these items are missing, please contact your place of purchase.

Standard accessories

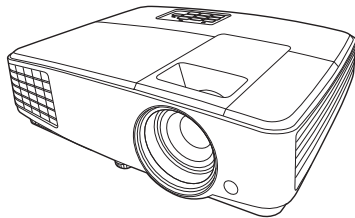

Projector

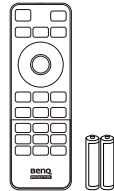

Remote control with batteries



User manual CD

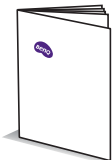

Quick start guide



Warranty card*

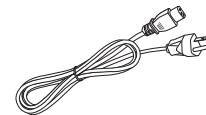

Power cord

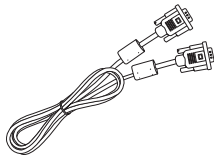

VGA cable



• The supplied accessories will be suitable for your region, and may differ from those illustrated.

• *The warranty card is only supplied in some specific regions. Please consult your dealer for detailed information.

Optional accessories

1. Spare lamp kit
2. RS232 cable
3. Ceiling mount kit
4. 3D glasses

Replacing the remote control batteries

1. Press and open the battery cover, as illustrated.
2. Remove the old batteries (if applicable) and install two AAA batteries. Make sure that the positive and negative ends are positioned correctly, as illustrated.
3. Replace the battery cover until it clicks into place.

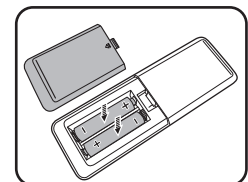
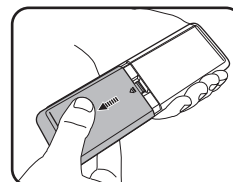



- Avoid leaving the remote control and batteries in an excessive heat or humid environment like the kitchen, bathroom, sauna, sunroom or in a closed car.
- Replace only with the same or equivalent type recommended by the battery manufacturer.
- Dispose of the used batteries according to the manufacturer's instructions and local environment regulations for your region.
- Never throw the batteries into a fire. There may be danger of an explosion.
- If the batteries are dead or if you will not be using the remote control for an extended period of time, remove the batteries to avoid damage to the remote control from possible battery leakage.

Projector exterior view

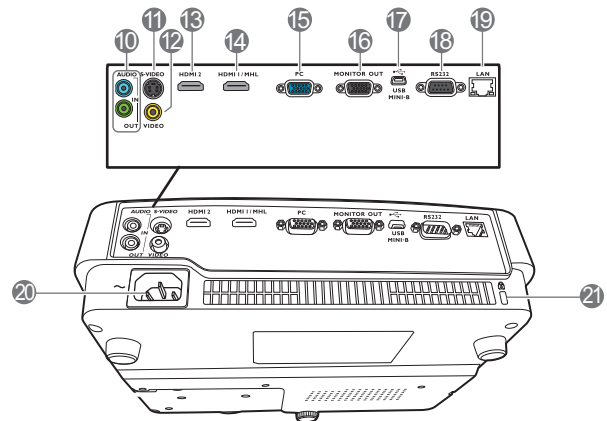
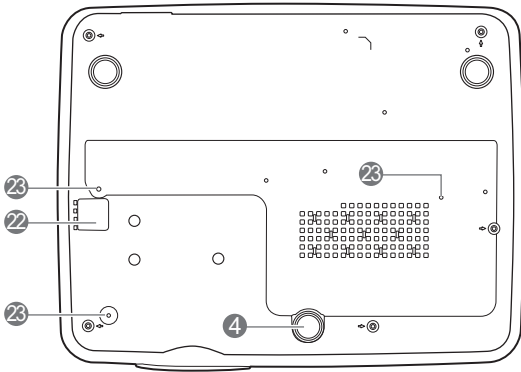
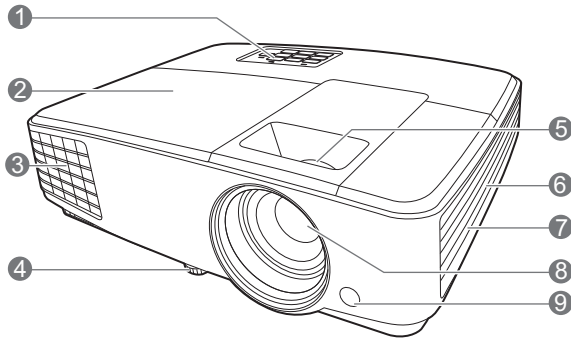

1. External control panel
(See [Controls and functions on page 9.](#))
2. Lamp cover
3. Vent (air exhaust)
4. Adjuster feet
5. Focus ring and Zoom ring
6. Vent (air inlet)
7. Speaker grill
8. Projection lens
9. IR remote sensor
10. Audio input jack
Audio output jack
11. S-Video input jack

12. Video input jack
13. HDMI input port
14. HDMI/MHL-input port (for HDMI dongle)
15. RGB (PC) signal input jack
16. RGB (PC) signal output jack
17. USB Mini-B port
18. RS-232 control port
19. RJ45 LAN input jack
20. AC power jack
21. Kensington anti-theft lock slot
22. Security bar
23. Wall mount holes

Controls and functions

Projector & Remote control



All the key presses described in this document are available on the remote control or projector.

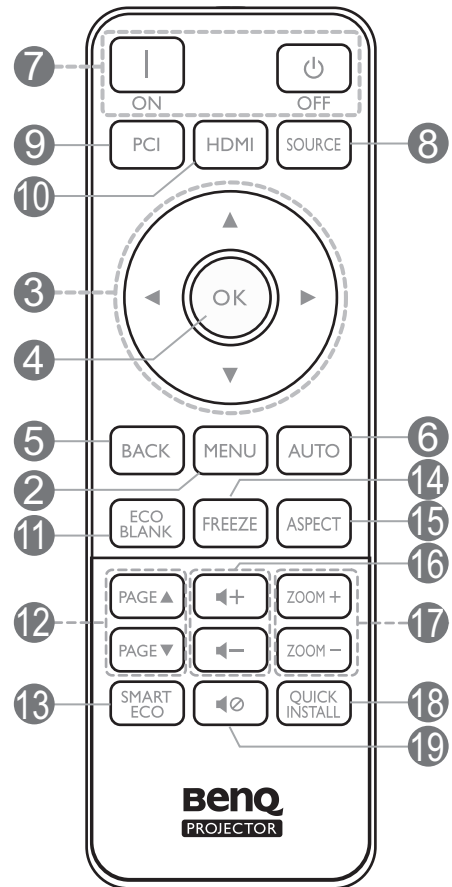
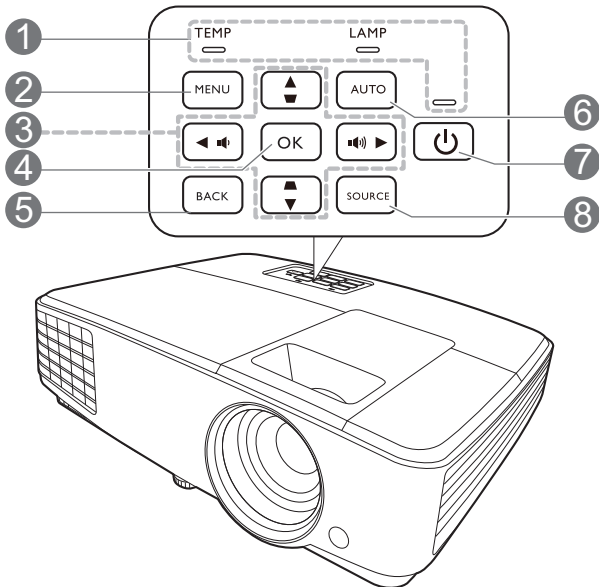

1. **POWER indicator light/TEMPerature warning light/LAMP indicator light**
(See [Indicators on page 40.](#))

2. **MENU**

Turns on the On-Screen Display (OSD) menu.

3. **Arrow keys** (▲, ▼, ◀, ▶)

When the On-Screen Display (OSD) menu is activated, these keys are used as directional arrows to select the desired menu items and to make adjustments.

Keystone keys (△, ▽)

Displays the keystone correction page.

Volume keys (🔊/🔊)

Decreases or increase the projector volume.

4. **OK**

Confirms the selected On-Screen Display (OSD) menu item.

5. **BACK**

Goes back to previous OSD menu, exits and saves menu settings.

6. **AUTO**

Automatically determines the best picture timings for the displayed image when PC signal (analog RGB) is selected.

7. **POWER**

Toggles the projector between standby mode and on.

ON / **Off**

Toggles the projector between standby mode and on.

8. SOURCE

Displays the source selection bar.

9. Source selection button: **PC 1**

Selects **PC 1** input source for display.

10. Source selection button: **HDMI**

Press this button repeatedly to select **HDMI 1** or **HDMI 2** input source for display.

11. **ECO BLANK**

Used to hide the screen picture.



Do not block the projection lens from projecting as this could cause the blocking object to become heated and deformed or even cause a fire.

12. **PAGE ▲/PAGE ▼**

Operate your display software program (on a connected PC) which responds to page up/down commands (like Microsoft PowerPoint).

13. **SMART ECO**

Displays the **Light Mode** menu for selecting a suitable lamp operating mode.

14. **FREEZE**

Freezes the projected image.

15. **ASPECT**

Selects the display aspect ratio.

16. **Volume keys** ◀- / ▶+

Decreases or increase the projector volume.

17. **ZOOM+/ZOOM-**

Magnifies or reduces the projected picture size.

18. **QUICK INSTALL**

Quickly selects several functions to adjust the projected image and displays the test pattern.

19.

Toggles projector audio between on and off.

Controlling your smart device with the remote control

When the projector projects the content from your MHL compatible smart device, you can use the remote control to control your smart device.

To enter the MHL mode, press and hold **AUTO** for 3 seconds. The following buttons are available for controlling your smart device: **Arrow keys** (▲, ▼, ◀, ▶), **MENU**, **BACK**, **OK**.

To leave the MHL mode, press and hold **AUTO** for 3 seconds.

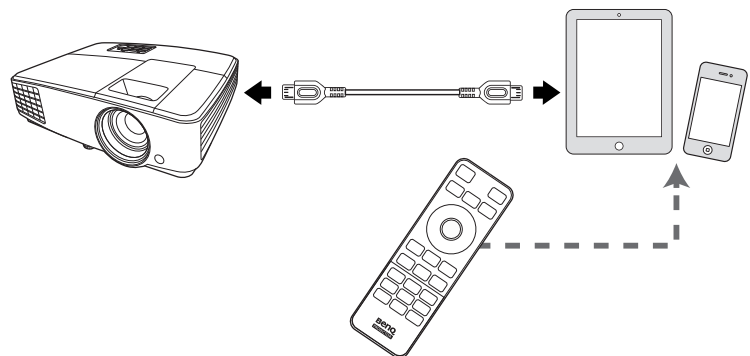

When the projector is under MHL mode, the keypad on the projector should be with the same definition of the keys on the remote control.

Remote control effective range

The remote control must be held at an angle within 30 degrees perpendicular to the projector's IR remote control sensor(s) to function correctly. The distance between the remote control and the sensor(s) should not exceed 8 meters (~ 26 feet).

Make sure that there are no obstacles between the remote control and the IR sensor(s) on the projector that might obstruct the infra-red beam.

- Operating the projector from the front

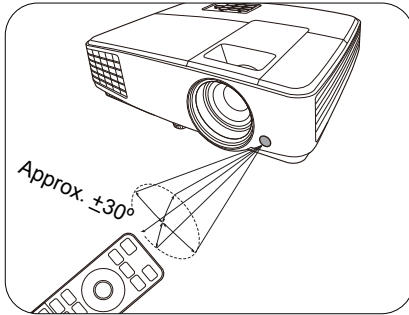

Positioning your projector

Choosing a location

Before choosing an installation location for your projector, take the following factors into consideration:

- Size and position of your screen
- Electrical outlet location
- Location and distance between the projector and the rest of your equipment

You can install your projector in the following ways.

1. Front Table

Select this location with the projector placed on the table in front of the screen. This is the most common way to position the projector for quick setup and portability.

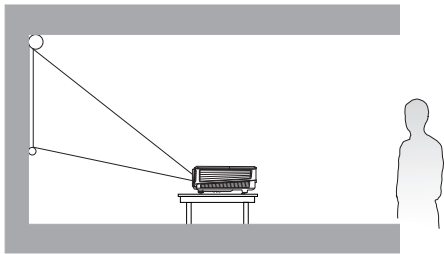

2. Rear Table

Select this location with the projector placed on the table behind the screen. Note that a special rear projection screen is required.

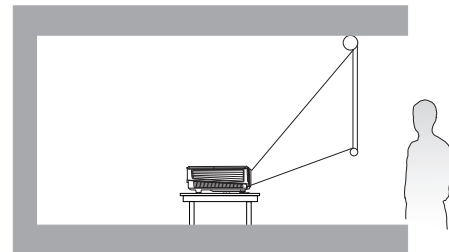

3. Front Ceiling

Select this location with the projector suspended upside-down in front of the screen. Purchase the BenQ Projector Ceiling/Wall Mount Kit from your dealer to mount your projector.

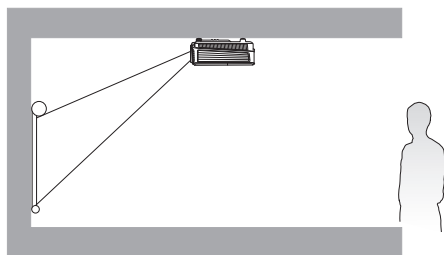

4. Rear Ceiling

Select this location with the projector suspended upside-down from behind the screen. Note that a special rear projection screen and the BenQ Projector Ceiling/Wall Mount Kit are required for this installation location.

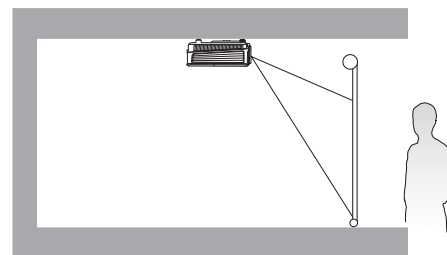

After turning on the projector, go to **Advanced Menu - Settings > Projector Installation > Projector Installation** and press ◀/▶ to select a setting.

You can also use **QUICK INSTALL** on the remote control to access this menu.

Obtaining a preferred projected image size

The distance from the projector lens to the screen, the zoom setting (if available), and the video format each factors in the projected image size.

Projection dimensions

MX707

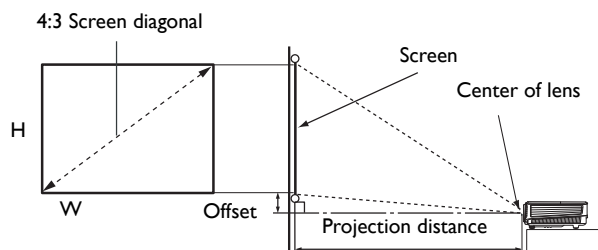

- The screen aspect ratio is 4:3 and the projected picture is in a 4:3 aspect ratio

Screen size			Projection distance (mm)			Offset (mm)	
Diagonal		W (mm)	H (mm)	Min length	Average		Max length
Inch	mm			(max. zoom)			(min. zoom)
30	762	610	457	920	1061	1201	34
40	1016	813	610	1227	1414	1601	46
50	1270	1016	762	1534	1768	2002	57
60	1524	1219	914	1841	2121	2402	69
80	2032	1626	1219	2455	2829	3202	91
100	2540	2032	1524	3068	3536	4003	114
120	3048	2438	1829	3682	4243	4804	137
150	3810	3048	2286	4602	5304	6005	171
200	5080	4064	3048	6137	7071	8006	229
250	6350	5080	3810	7671	8839	10008	286
300	7620	6096	4572	9205	10607	12009	343

For example, if you are using a 120-inch screen, the recommended projection distance is 4243 mm.

If your measured projection distance is 5000 mm, the closest match in the "Projection distance (mm)" column is 5304 mm. Looking across this row shows that a 150" (about 3.8 m) screen is required.



All measurements are approximate and may vary from the actual sizes.

BenQ recommends that if you intend to permanently install the projector, you should physically test the projection size and distance using the actual projector in situ before you permanently install it, so as to make allowance for this projector's optical characteristics. This will help you determine the exact mounting position so that it best suits your installation location.

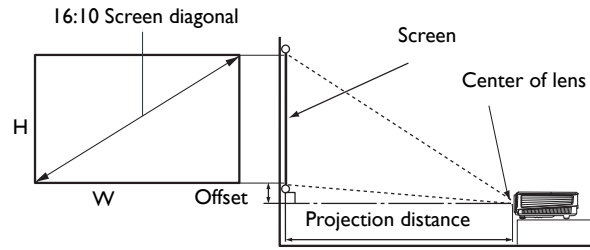

- The screen aspect ratio is 16:10 and the projected picture is in a 16:10 aspect ratio

Screen size			Projection distance (mm)			Offset (mm)	
Diagonal		W (mm)	H (mm)	Min length	Average		Max length
Inch	mm			(max. zoom)			(min. zoom)
60	1524	1292	808	1564	1796	2029	81
70	1778	1508	942	1824	2096	2367	94
80	2032	1723	1077	2085	2395	2705	108
90	2286	1939	1212	2346	2695	3044	121
100	2540	2154	1346	2606	2994	3382	135
110	2794	2369	1481	2867	3293	3720	148
120	3048	2585	1615	3128	3593	4058	162
130	3302	2800	1750	3388	3892	4396	175
140	3556	3016	1885	3649	4192	4734	189
150	3810	3231	2019	3909	4491	5073	202
160	4064	3446	2154	4170	4790	5411	215
170	4318	3662	2289	4431	5090	5749	229
180	4572	3877	2423	4691	5389	6087	242

For example, if you are using a 120-inch screen, the recommended projection distance is 3593 mm.

If your measured projection distance is 3000 mm, the closest match in the "Projection distance (mm)" column is 2994 mm. Looking across this row shows that a 100" (about 2.5 m) screen is required.



All measurements are approximate and may vary from the actual sizes.

BenQ recommends that if you intend to permanently install the projector, you should physically test the projection size and distance using the actual projector in situ before you permanently install it, so as to make allowance for this projector's optical characteristics. This will help you determine the exact mounting position so that it best suits your installation location.

Mounting the projector

If you intend to mount your projector, we strongly recommend that you use a proper fitting BenQ projector mounting kit and that you ensure it is securely and safely installed.

If you use a non-BenQ brand projector mounting kit, there is a safety risk that the projector may fall down due to an improper attachment through the use of the wrong gauge or length screws.

Before mounting the projector

- Purchase a BenQ projector mounting kit from the place you purchased your BenQ projector.
- BenQ recommends that you also purchase a separate Kensington lock compatible security cable and attach it securely to both the Kensington lock slot on the projector and the base of the mounting bracket. This will perform the secondary role of restraining the projector should its attachment to the mounting bracket become loose.

- Ask your dealer to install the projector for you. Installing the projector on your own may cause it to fall and result in injury.
- Take necessary procedures to prevent the projector from falling off such as during an earthquake.
- The warranty doesn't cover any product damage caused by mounting the projector with a non-BenQ brand projector mounting kit.
- Consider the surrounding temperature where the projector is ceiling/wall mounted. If a heater is used, the temperature around the ceiling/wall may be higher than expected.
- Read the user manual for the mounting kit about the range of torque. Tightening with torque exceeding the recommended range may cause damage to the projector and subsequently falling off.
- Make sure the power outlet is at an accessible height so that you can easily shut down the projector.

Ceiling/Wall mount installation diagram

Ceiling/Wall mount screw: M4
(Max L = 25 mm; Min L = 20 mm)

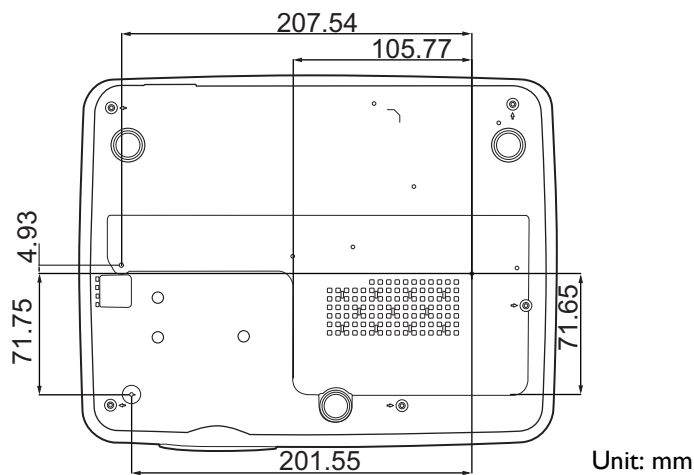

Adjusting the projected image

Adjusting the projection angle

If the projector is not placed on a flat surface or the screen and the projector are not perpendicular to each other, the projected image becomes trapezoidal. You can screw the adjuster feet to fine-tune the horizontal angle.

To retract the feet, screw the adjuster feet in a reverse direction.

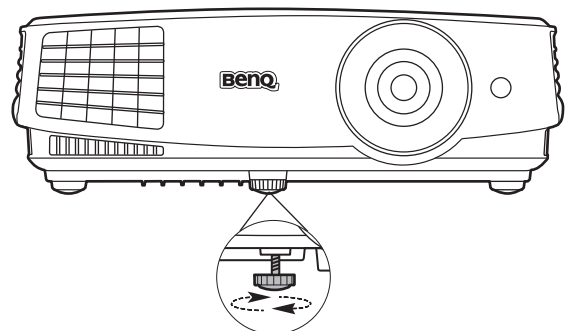

Do not look into the lens while the lamp is on. The strong light from the lamp may cause damage to your eyes.

Auto-adjusting the image

In some cases, you may need to optimize the picture quality. To do this, press **AUTO**. Within 3 seconds, the built-in Intelligent Auto Adjustment function will re-adjust the values of Frequency and Clock to provide the best picture quality.

The current source information will be displayed in the corner of the screen for 3 seconds.



This function is only available when PC signal (analog RGB) is selected.

Fine-tuning the image size and clarity

Adjust the projected image to the size that you need using the zoom ring.

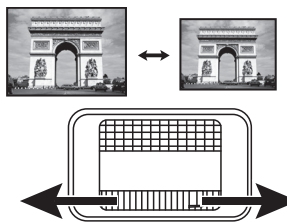

Sharpen the image by rotating the focus ring.

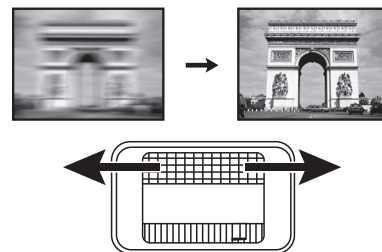

Correcting keystone

Keystoning refers to the situation where the projected image becomes a trapezoid due to angled projection.

To correct this, you will need to manually correct it following these steps.

1. Do one of the following steps to display the keystone correction page.

- Press \triangle / ∇ on the projector or remote control.
- Press **QUICK INSTALL** on the remote control. Press \blacktriangledown to highlight **Keystone** and press **OK**.
- Go to **Advanced Menu - Display > Keystone** and press **OK**.



2. After the **Keystone** correction page displays. Press \triangle to correct keystone at the top of the image. Press ∇ to correct keystone at the bottom of the image.

Connection

When connecting a signal source to the projector, be sure to:

1. Turn all equipment off before making any connections.
2. Use the correct signal cables for each source.
3. Ensure the cables are firmly inserted.

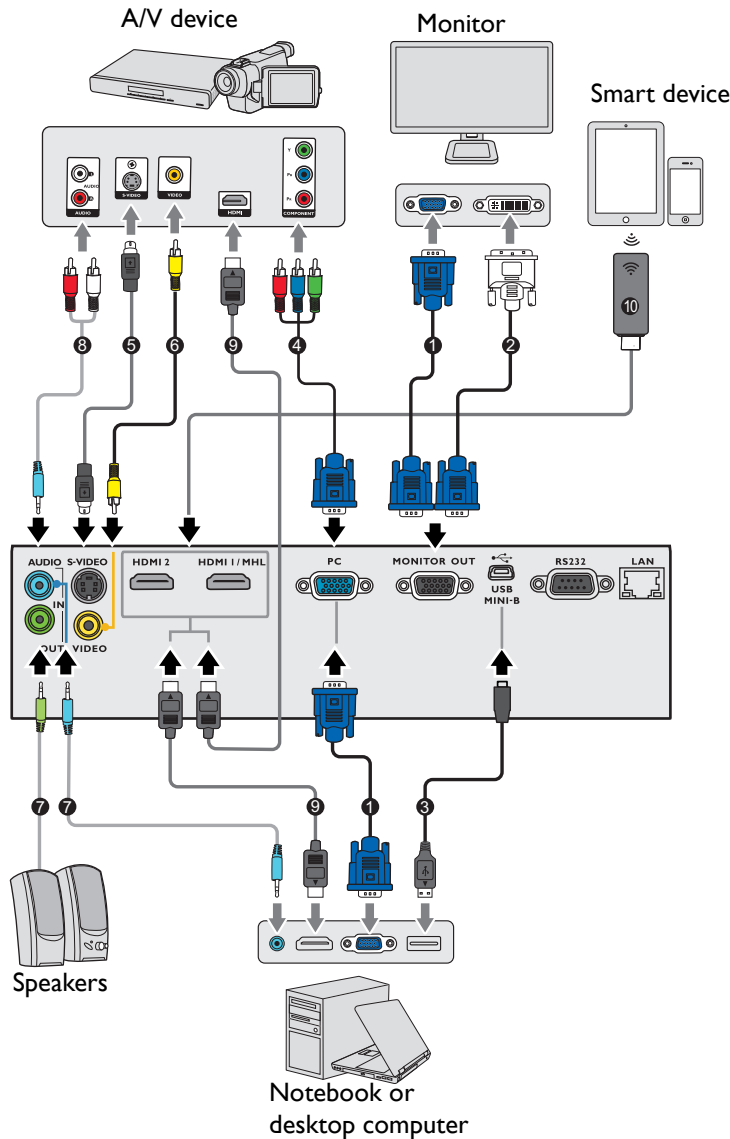



1	VGA cable
2	VGA to DVI-A cable
3	USB cable
4	Component Video to VGA (D-Sub) adapter cable
5	S-Video cable
6	Video cable
7	Audio cable
8	Audio L/R cable
9	HDMI cable
10	HDMI wireless dongle

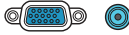

- In the connections above, some cables may not be included with the projector (see [Shipping contents on page 7](#)). They are commercially available from electronics stores.
- The connection illustrations are for reference only. The rear connecting jacks available on the projector vary with each projector model.
- Many notebooks do not turn on their external video ports when connected to a projector. Usually a key combo like FN + function key with a monitor symbol turns the external display on/off. Press FN and the labeled function key simultaneously. Refer to your notebook's documentation to find your notebook's key combination.
- If the selected video image is not displayed after the projector is turned on and the correct video source has been selected, check that the video source device is turned on and operating correctly. Also check that the signal cables have been connected correctly.

You need only connect the projector to a video source device using just one of the connecting methods, however each provides a different level of video quality.

Terminal		Picture quality
HDMI/MHL		Best
Component Video (through RGB input)		Better
S-Video		Good
Video		Normal

Connecting audio

The projector has built-in mono speaker(s) which are designed to provide basic audio functionality accompanying data presentations for business purposes only. They are not designed for, nor intended for stereo audio reproduction use as might be expected in home theater or home cinema applications. Any stereo audio input (if provided), is mixed into a common mono audio output through the projector speaker(s).



The built-in speaker(s) will be muted when the **AUDIO OUT** jack is connected.



- The projector is only capable of playing mixed mono audio, even if a stereo audio input is connected.
- If the selected video image is not displayed after the projector is turned on and the correct video source has been selected, check that the video source device is turned on and operating correctly. Also check that the signal cables have been connected correctly.

Operation

Starting up the projector

1. Plug the power cord. Turn on the power outlet switch (where fitted). The power indicator on the projector lights orange after power has been applied.
2. Press  on the projector or  on the remote control to start the projector. The power indicator flashes green and stays green when the projector is on.

The start up procedure takes about 30 seconds. In the later stage of start up, a startup logo is projected.

(If necessary) Rotate the focus ring to adjust the image clearness.

3. If the projector is activated for the first time, select your OSD language following the on-screen instructions.
4. If you are prompted for a password, press the arrow keys to enter a 6-digit password. See [Utilizing the password function on page 21](#).
5. Switch all of the connected equipment on.
6. The projector will search for input signals. The current input signal being scanned appears. If the projector does not detect a valid signal, the message “No Signal” will continue displaying until an input signal is found.

You can also press **SOURCE** to select your desired input signal. See [Switching input signal on page 23](#).

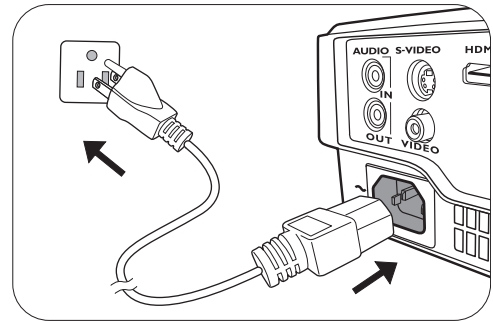

- Please use the original accessories (e.g. power cord) to avoid possible dangers such as electric shock and fire.
- If the projector is still hot from previous activity, it will run the cooling fan for approximately 90 seconds before energizing the lamp.



- The Setup Wizard screenshots are for reference only and may differ from the actual design.
- If the frequency/resolution of the input signal exceeds the projector's operating range, you will see the message “Out of Range” displayed on the background screen. Please change to an input signal which is compatible with the projector's resolution or set the input signal to a lower setting. See [Timing chart on page 44](#).
- If no signal is detected for 3 minutes, the projector automatically enters saving mode.

Using the menus

The projector is equipped with 2 types of On-Screen Display (OSD) menus for making various adjustments and settings.

- **Basic** OSD menu: provides primary menu functions. (See [Basic menu on page 24](#))
- **Advanced** OSD menu: provides full menu functions. (See [Advanced menu on page 26](#))

To access the OSD menu, press **MENU** on the projector or remote control.

- Use the arrow keys (▲/▼/◀/▶) on the projector or remote control to move through the menu items.
- Use **OK** on the projector or remote control to confirm the selected menu item.

The first time you use the projector (after finishing the initial setup), Basic OSD menu displays.



The OSD screenshots below are for reference only, and may differ from the actual design.

Below is the overview of the **Basic** OSD menu.

1	Menu Type	4	Press OK to enter the menu.
2	Main menu	5	Status
3	Current input signal	6	Press MENU to go to the previous page or to exit.

If you intend to switch from the **Basic** OSD menu to the **Advanced** OSD menu, follow the instructions below:

1. Go to **Basic Menu > Menu Type**.
2. Press **OK** and press ▲/▼ to select **Advanced**. Next time when you turn on the projector, you may access the **Advanced** OSD menu by pressing **MENU**.

Below is the overview of the **Advanced** OSD menu.

1	Main menu & Main menu icon	5	Press BACK to go to the previous page.
2	Sub-menu	6	Press MENU to go to the previous page or to exit.
3	Current input signal	7	Status
4	Press OK to enter the menu.		

Likewise, when you wish to switch from the **Advanced** OSD menu to the **Basic** OSD menu, follow the instructions below:

1. Go to **Advanced Menu - System > Menu Settings** and press **OK**.
2. Select **Menu Type** and **OK**.
3. Press **▲/▼** to select **Basic**. Next time when you turn on the projector, you may access the **Basic** OSD menu by pressing **MENU**.

Securing the projector

Using a security cable lock

The projector has to be installed in a safe place to prevent theft. Otherwise, purchase a lock, such as the Kensington lock, to secure the projector. You can locate a Kensington lock slot on the rear side of the projector. See item 23 on [page 8](#).

A Kensington security cable lock is usually a combination of key(s) and the lock. Refer to the lock's documentation for finding out how to use it.

Utilizing the password function

Setting a password

1. Go to **Advanced Menu - Settings > Security Settings**. Press **OK**. The **Security Settings** page appears.
2. Highlight **Change Password** and press **OK**.
3. The four arrow keys (**▲**, **▶**, **▼**, **◀**) respectively represent 4 digits (1, 2, 3, 4). According to the password you desire to set, press the arrow keys to enter six digits for the password.
4. Confirm the new password by re-entering the new password.
Once the password is set, the OSD menu returns to the **Security Settings** page.
5. To activate the **Power On Lock** function, press **▲/▼** to highlight **Power On Lock** and press **◀/▶** to select **On**. Input the password again.

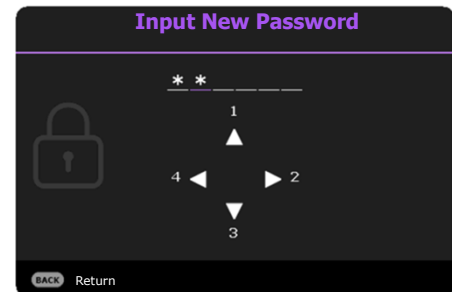

- The digits being input will display as asterisks on-screen. Make a note of your selected password and keep it in a safe place in advance or right after the password is entered so that it is available to you should you ever forget it.
- Once a password has been set and the power on lock is activated, the projector cannot be used unless the correct password is entered every time the projector is started.

If you forget the password

If you enter the wrong password, the password error message will appear, and the **Input Current Password** message follows. If you absolutely do not remember the password, you can use the password recall procedure. See [Entering the password recall procedure on page 22](#).

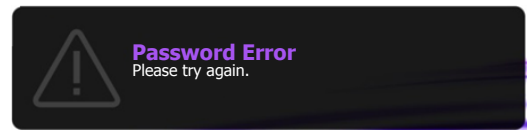

If you enter an incorrect password 5 times in succession, the projector will automatically shut down in a short time.

Entering the password recall procedure

1. Press and hold **AUTO** for 3 seconds. The projector will display a coded number on the screen.
2. Write down the number and turn off your projector.
3. Seek help from the local BenQ service center to decode the number. You may be required to provide proof of purchase documentation to verify that you are an authorized user of the projector.

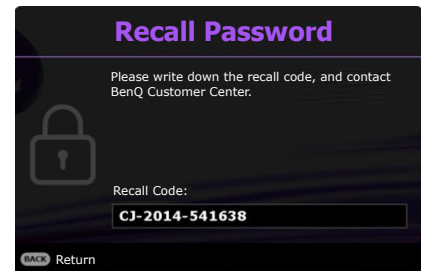

Changing the password

1. Go to **Advanced Menu - Settings > Security Settings > Change Password**.
2. Press **OK**. The message **“Input Current Password”** appears.
3. Enter the old password.
 - If the password is correct, another message **“Input New Password”** appears.
 - If the password is incorrect, the password error message will appear, and the message **“Input Current Password”** appears for your retry. You can press **BACK** to cancel the change or try another password.
4. Enter a new password.
5. Confirm the new password by re-entering the new password.

Disabling the password function

To disable password protection, go to **Advanced Menu - Settings > Security Settings > Power On Lock** and press **◀/▶** to select **Off**. The message **“Input Current Password”** appears. Enter the current password.

- If the password is correct, the OSD menu returns to the **Security Settings** page. You will not have to enter the password next time turning on the projector.
- If the password is incorrect, the password error message will appear, and the message **“Input Current Password”** appears for your retry. You can press **BACK** to cancel the change or try another password.



Though the password function is disabled, you need to keep the old password in hand should you ever need to re-activate the password function by entering the old password.

Switching input signal

The projector can be connected to multiple devices at the same time. However, it can only display one full screen at a time. When starting up, the projector automatically searches for the available signals.

Be sure the **Advanced Menu - Settings > Auto Source Search** menu is **On** if you want the projector to automatically search for the signals.

To select the source:

1. Press **SOURCE**. A source selection bar appears.
2. Press **▲/▼** until your desired signal is selected and press **OK**.

Once detected, the selected source information will appear at the corner of the screen for seconds. If there is multiple equipment connected to the projector, repeat steps 1-2 to search for another signal.



- The brightness level of the projected image will change accordingly when you switch between different input signals.
- For best display picture results, you should select and use an input signal which outputs at the projector's native resolution. Any other resolutions will be scaled by the projector depending upon the "aspect ratio" setting, which may cause some image distortion or loss of picture clarity. See [Aspect Ratio on page 24](#).

Shutting down the projector

1. Press **⏻** on the projector or **⏻** on the remote control and a confirmation message will appear prompting you. If you don't respond in a few seconds, the message will disappear.
2. Press **⏻** or **⏻** a second time. The power indicator flashes orange, the projection lamp shuts down, and the fans will continue to run for approximately 90 seconds to cool down the projector.
3. Once the cooling process finishes, the power indicator becomes a steady orange and fans stop. Disconnect the power cord from the power outlet.

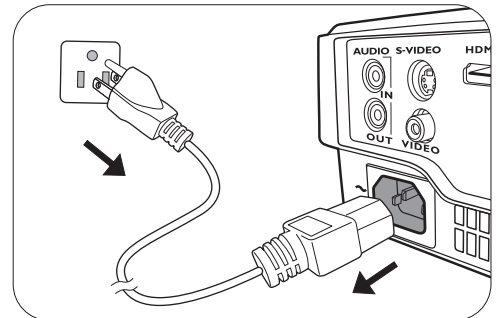

- To protect the lamp, the projector will not respond to any commands during the cooling process.
- To shorten the cooling time, you can also activate the Quick cooling function. See [Quick Cooling on page 31](#).
- Avoid turning on the projector immediately after turning it off as excessive heat may shorten lamp life.
- Lamp life results will vary depending on environmental conditions and usage.

Direct power off





The AC power cord can be pulled out right after the projector is turned off. To protect the lamp, wait about 10 minutes before re-starting the projector. If you attempt to re-start the projector, the fans may run for a few minutes to cool down. In such cases, press **⏻** or **⏻** again to start the projector after the fans stop and the power indicator turns orange.

Menu operation

Please note that the on-screen display (OSD) menus vary according to the signal type selected and the projector model you are using.

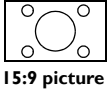
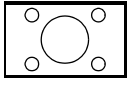
The menu items are available when the projector detects at least one valid signal. If there is no equipment connected to the projector or no signal detected, limited menu items are accessible.

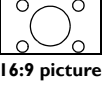
Basic menu

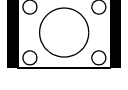
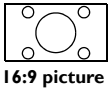
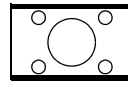
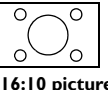
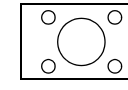
<p>Brightness</p>	<p>Adjust this control so the black areas of the image appear just as black and that detail in the dark areas is visible.</p>
<p>Aspect Ratio</p>	<p>There are several options to set the image's aspect ratio depending on your input signal source.</p> <ul style="list-style-type: none"> <p>• Auto: Scales an image proportionally to fit the projector's native resolution in its horizontal or vertical width.</p> <p>• Real: Projects an image as its original resolution and resizes it to fit within the display area. For input signals with lower resolutions, the projected image will be displayed in its original size.</p> <p>• 4:3: Scales an image so that it is displayed in the center of the screen with a 4:3 aspect ratio.</p> <p>• 16:9: Scales an image so that it is displayed in the center of the screen with a 16:9 aspect ratio.</p> <p>• 16:10: Scales an image so that it is displayed in the center of the screen with a 16:10 aspect ratio.</p> <div style="display: flex; justify-content: space-around; align-items: flex-start;"> <div style="text-align: center;"> <p>(MX707)</p>  <p>15:9 picture</p> </div> <div style="text-align: center;"> <p>(MW707)</p>  </div> </div> <div style="display: flex; justify-content: space-around; align-items: flex-start;"> <div style="text-align: center;"> <p>4:3 picture</p>  </div> <div style="text-align: center;">  </div> </div> <div style="display: flex; justify-content: space-around; align-items: flex-start;"> <div style="text-align: center;"> <p>16:9 picture</p>  </div> <div style="text-align: center;">  </div> </div> <div style="display: flex; justify-content: space-around; align-items: flex-start;"> <div style="text-align: center;"> <p>4:3 picture</p>  </div> <div style="text-align: center;">  </div> </div> <div style="display: flex; justify-content: space-around; align-items: flex-start;"> <div style="text-align: center;"> <p>16:9 picture</p>  </div> <div style="text-align: center;">  </div> </div> <div style="display: flex; justify-content: space-around; align-items: flex-start;"> <div style="text-align: center;"> <p>16:10 picture</p>  </div> <div style="text-align: center;">  </div> </div>

Picture Mode	<p>The projector is preset with several predefined picture modes so that you can choose one to suit your operating environment and input signal picture type.</p> <ul style="list-style-type: none"> • Bright: Maximizes the brightness of the projected image. This mode is suitable for environments where extra-high brightness is required, such as using the projector in well lit rooms. • Presentation: Is designed for presentations. The brightness is emphasized in this mode to match PC and notebook coloring. • sRGB: Maximizes the purity of RGB colors to provide true-to-life images regardless of brightness setting. It is most suitable for viewing photos taken with an sRGB compatible and properly calibrated camera, and for viewing PC graphic and drawing applications such as AutoCAD. • Infographic: Is perfect for presentations with the mixture of text and graphics due to its high color brightness and better color gradation to see the details clearly. • 3D: Is appropriate for playing 3D images and 3D video clips. • User 1/User 2: Recalls the settings customized based on the current available picture modes. See Reference Mode on page 26.
Volume	Adjusts the sound level.
Light Mode	See Setting the Light Mode on page 36 .
Information	<ul style="list-style-type: none"> • Native Resolution: Shows the native resolution of the projector. • Detected Resolution: Shows the native resolution of the input signal. • Source: Shows the current signal source. • Picture Mode: Shows the selected mode in the Picture menu. • Light Mode: Shows the selected mode in the Light Settings menu. • 3D Format: Shows the current 3D mode. • Color System: Shows input system format. • Light Usage Time: Shows the number of hours the lamp has been used. • Firmware Version: Shows the firmware version of your projector.
Menu Type	Switches to the Advanced OSD menu. See Using the menus on page 20 .

Advanced menu





Picture



Picture Mode	<p>The projector is preset with several predefined picture modes so that you can choose one to suit your operating environment and input signal picture type.</p> <ul style="list-style-type: none">• Bright: Maximizes the brightness of the projected image. This mode is suitable for environments where extra-high brightness is required, such as using the projector in well lit rooms.• Presentation: Is designed for presentations. The brightness is emphasized in this mode to match PC and notebook coloring.• sRGB: Maximizes the purity of RGB colors to provide true-to-life images regardless of brightness setting. It is most suitable for viewing photos taken with an sRGB compatible and properly calibrated camera, and for viewing PC graphic and drawing applications such as AutoCAD.• Infographic: Is perfect for presentations with the mixture of text and graphics due to its high color brightness and better color gradation to see the details clearly.• 3D: Is appropriate for playing 3D images and 3D video clips.• User 1/User 2: Recalls the settings customized based on the current available picture modes. See Reference Mode on page 26.
Reference Mode	<p>There are 2 user-definable modes if the current available picture modes are not suitable for your need. You can use one of the picture modes (except the User 1/User 2) as a starting point and customize the settings.</p> <ol style="list-style-type: none">1. Go to Picture > Picture Mode.2. Press ◀/▶ to select User 1 or User 2.3. Press ▼ to highlight Reference Mode, and press ◀/▶ to select a picture mode that is closest to your need.4. Press ▼ to select a menu item to be changed and adjust the value. The adjustments define the selected user mode.
Brightness	<p>Adjust this control so the black areas of the image appear just as black and that detail in the dark areas is visible.</p>
Contrast	<p>The higher the value, the greater the contrast. Use this to set the peak white level after you have previously adjusted the Brightness setting to suit your selected input and viewing environment.</p>
Color	<p>Lower setting produces less saturated colors. If the setting is too high, colors on the image will be overpowering, which makes the image unrealistic.</p>
Tint	<p>The higher the value, the more greenish the picture becomes. The lower the value, the more reddish the picture becomes.</p>
Sharpness	<p>The higher the value, the sharper the picture becomes.</p>

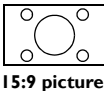

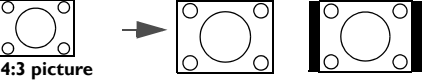
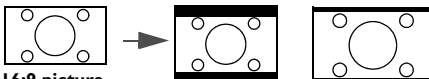
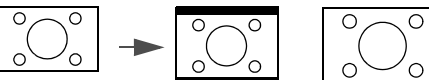
<p>Brilliant Color</p>	<p>This feature utilizes a new color-processing algorithm and system level enhancements to enable higher brightness while providing truer, more vibrant colors in picture. It enables a greater than 50% brightness increase in mid-tone images, which are common in video and natural scenes, so the projector reproduces images in realistic and true colors. If you prefer images with that quality, select On.</p> <p>When Off is selected, the Color Temperature function is not available.</p>
<p>Advanced Color Settings</p>	<p>Color Temperature</p> <p>There are several preset color temperature settings available. The available settings may vary according to the signal type selected.</p> <ul style="list-style-type: none"> • Normal: Maintains normal colorings for white. • Cool: Makes images appear bluish white. • Warm: Makes images appear reddish white. <p>Color Temperature Tuning</p> <p>You can also set a preferred color temperature by adjusting the following options.</p> <ul style="list-style-type: none"> • R Gain/G Gain/B Gain: Adjusts the contrast levels of Red, Green, and Blue. • R Offset/G Offset/B Offset: Adjusts the brightness levels of Red, Green, and Blue. <p>Color Management</p> <p>This function provides six sets (RGBCMY) of colors to be adjusted. When you select each color, you can independently adjust its range and saturation according to your preference.</p> <ul style="list-style-type: none"> • Primary Color: Selects a color from among R (Red), G (Green), B (Blue), C (Cyan), M (Magenta), or Y (Yellow). • Hue: Increase in the range will include colors consisted of more proportions of its two adjacent colors. Please refer to the illustration for how the colors relate to each other. For example, if you select Red and set its range at 0, only pure red in the projected picture will be selected. Increasing its range will include red close to yellow and red close to magenta. • Saturation: Adjusts the values to your preference. Every adjustment made will reflect to the image immediately. For example, if you select Red and set its value at 0, only the saturation of pure red will be affected. <div data-bbox="1098 1220 1453 1556" data-label="Diagram"> </div> <p> Saturation is the amount of that color in a video picture. Lower settings produce less saturated colors; a setting of “0” removes that color from the image entirely. If the saturation is too high, that color will be overpowering and unrealistic.</p> <ul style="list-style-type: none"> • Gain: Adjusts the values to your preference. The contrast level of the primary color you select will be affected. Every adjustment made will reflect to the image immediately.

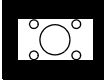
<p>Advanced Color Settings</p>	<p>Wall Color</p> <p>Corrects the projected picture's color when the projection surface such as a painted wall which may not be white, the Wall Color feature can help correct the projected picture's colors to prevent possible color difference between the source and projected pictures. There are several precalibrated colors to choose from: Light Yellow, Pink, Light Green, Blue, and Blackboard.</p>
<p>Reset Picture</p>	<p>Returns all of the adjustments you've made for the Picture menu to the factory preset values.</p>

Display

<p>Aspect Ratio</p>	<p>There are several options to set the image's aspect ratio depending on your input signal source.</p> <ul style="list-style-type: none"> • Auto: Scales an image proportionally to fit the projector's native resolution in its horizontal or vertical width. • Real: Projects an image as its original resolution and resizes it to fit within the display area. For input signals with lower resolutions, the projected image will be displayed in its original size. • 4:3: Scales an image so that it is displayed in the center of the screen with a 4:3 aspect ratio. • 16:9: Scales an image so that it is displayed in the center of the screen with a 16:9 aspect ratio. • 16:10: Scales an image so that it is displayed in the center of the screen with a 16:10 aspect ratio. <div style="display: flex; justify-content: space-around; align-items: flex-start;"> <div style="text-align: center;"> <p>(MX707) (MW707)</p>  <p>15:9 picture</p> </div> <div style="text-align: center;">  <p>4:3 picture</p> </div> <div style="text-align: center;">  <p>16:9 picture</p> </div> <div style="text-align: center;">  <p>4:3 picture</p> </div> <div style="text-align: center;">  <p>16:9 picture</p> </div> <div style="text-align: center;">  <p>16:10 picture</p> </div> </div>
<p>Keystone</p>	<p>Corrects any keystone of the image. See Correcting keystone on page 16.</p>
<p>Test Pattern</p>	<p>Adjusts the image size and focus and check that the projected image is free from distortion.</p> 
<p>PC & Component YPbPr Tuning</p>	<ul style="list-style-type: none"> • Phase: Adjusts the clock phase to reduce image distortion. This function is only available when a PC signal (analog RGB) or YPbPr signal is selected. • H. Size: Adjusts the horizontal width of the image. This function is only available when a PC signal (analog RGB) is selected. 

<p>Position</p>	<p>Displays the position adjustment page. To move the projected image, use the directional arrow keys. This function is only available when a PC signal (analog RGB) is selected.</p>
<p>3D</p>	<p>This projector features a 3D function which enables you to enjoy the 3D movies, videos, and sporting events in a more realistic way by presenting the depth of the images. You need to wear a pair of 3D glasses to view the 3D images.</p> <ul style="list-style-type: none"> • 3D Mode: The default setting is Off. If you want the projector to automatically choose an appropriate 3D format when detecting 3D contents, select Auto. If the projector cannot recognize the 3D format, press ▲/▼ to choose a 3D mode from among Top Bottom, Frame Sequential, Frame Packing and Side by Side. <p></p> <p>When 3D function is activated:</p> <ul style="list-style-type: none"> • The brightness level of the projected image will decrease. • The following settings cannot be adjusted: Picture Mode, Reference Mode. • The Keystone can only be adjusted within limited degrees. • 3D Sync Invert: When you discover the inversion of the image depth, enable this function to correct the problem. • Apply 3D Settings: After the 3D settings are saved, you can decide if you would like to apply them by choosing a set of 3D settings that you have saved. Once applied, the projector will automatically play the incoming 3D contents if it matches the 3D settings saved. <p></p> <p>Only the set(s) of 3D settings with memorized data is available.</p> <ul style="list-style-type: none"> • Save 3D Settings: When you have successfully displayed the 3D contents after making the appropriate adjustments, you can enable this function and choose a set of 3D settings to memorize current 3D settings.
<p>HDMI Format</p>	<p>Selects a suitable color format to optimize display quality.</p> <ul style="list-style-type: none"> • Auto: Automatically selects a suitable color space and gray level for the incoming HDMI signal. • RGB Limited: Utilizes the Limited range RGB 16-235. • RGB Full: Utilizes the Full range RGB 0-255. • YUV Limited: Utilizes the Limited range YUV 16-235. • YUV Full: Utilizes the Full range YUV 0-255.



<p>Digital Zoom</p>	<p>Magnifies or reduces the projected image.</p> <ol style="list-style-type: none"> 1. After the Zoom bar displays, press ▲ repeatedly to magnify the picture to a desired size. 2. To navigate the picture, press OK to switch to the panning mode and press the directional arrows (▲, ▼, ◀, ▶) on the projector or remote control to navigate the picture. 3. To reduce size of the picture, press OK to switch back to the zoom in/out function, and press AUTO to restore the picture to its original size. You can also press repeatedly until it is restored to the original size.  <p>The picture can only be navigated after it is magnified. You can further magnify the picture while searching for details.</p>
<p>Digital Shrink & Shift</p>	<p>Shrinks and/or shifts the projected image.</p> <ol style="list-style-type: none"> 1. After the adjustment bar displays, press ◀/▶ repeatedly to shrink or magnify the picture to a desired size. 2. Press OK to activate digital shift function. 3. After digital shift function is activated, press the directional arrows (▲, ▼, ◀, ▶) to shift the image. 4. Press AUTO to restore the picture to its original size.  <p>The picture can only be shifted after it shrank.</p>
<p>Reset Display</p>	<p>Returns all of the adjustments you've made for the Display menu to the factory preset values.</p>



Network

<p>Wired LAN</p>	<p>See BenQ Network Projector Operation Guide, which can be downloaded from BenQ product webpage.</p>
<p>AMX Device Discovery</p>	<p>When this function is On, the projector can be detected by AMX controller.</p>
<p>MAC Address (Wired)</p>	<p>Displays the mac address for this projector.</p>



Settings

<p>Projector Installation</p>	<p>See Choosing a location on page 12.</p>
<p>Auto Source Search</p>	<p>Allows the projector to automatically search for a signal.</p>
<p>Auto Signal Adjustment</p>	<ul style="list-style-type: none"> • On: Allows the projector to automatically determines the best picture timings for the displayed image when PC signal (analog RGB) is selected and AUTO is pressed. • Off: The projector will not respond when AUTO is pressed.

<p>Light Settings</p>	<ul style="list-style-type: none"> • Light Mode: See Setting the Light Mode on page 36. • Reset Light Timer: See Resetting the lamp timer on page 39. • Light Usage Time: Displays the number of hours the lamp has been used.
<p>Operation Settings</p>	<p>Quick Cooling: Selecting On enables the function and projector cooling time will be shortened from a normal 90-second duration to approximately 15 seconds.</p> <p>Blank Timer Sets the image blank time when there is no action taken on the blank screen, once elapsed the image will return to the screen. If the preset time spans are not suitable for your need, select Disable. No matter Blank Timer is activated or not, you can press most of the keys on the projector or remote control to restore the picture.</p> <p>Reminder Message Sets the reminder messages on or off.</p> <p>High Altitude Mode We recommend you use the High Altitude Mode when your environment is between 1500 m –3000 m above sea level, and ambient temperature is between 0°C–30°C. Operation under "High Altitude Mode" may cause a higher decibel operating noise level because of increased fan speed necessary to improve overall system cooling and performance. If you use this projector under other extreme conditions excluding the above, it may display auto shut-down symptoms, which is designed to protect your projector from over-heating. In cases like this, you should switch to High Altitude mode to solve these symptoms. However, this is not to state that this projector can operate under any and all harsh or extreme conditions.</p> <p> Do not use the High Altitude Mode if your altitude is between 0 m and 1500 m and ambient temperature is between 0°C and 35°C. The projector will be over cooled, if you turn the mode on under such a condition.</p>
<p>Operation Settings</p>	<p>Power On/Off Settings</p> <ul style="list-style-type: none"> • Direct Power On: Allows the projector to turn on automatically once the power is fed through the power cord. • Signal Power On: Sets whether to turn the projector directly on without pressing  POWER or  ON when the projector is in standby mode and detects a VGA signal or a HDMI signal with 5V power. • Auto Power Off: Allows the projector to turn off automatically if no input signal is detected after a set period of time to prevent unnecessary waste of lamp life. • Power Off Timer: Sets the auto-shutdown timer. <p>Instant Restart Allows you to restart the projector immediately within 90 seconds after turning it off.</p>

<p>Security Settings</p>	<p>Panel Key Lock</p> <p>With the control keys on the projector locked, you can prevent your projector settings from being changed accidentally (by children, for example). When the Panel Key Lock is on, no control keys on the projector will operate except  POWER.</p> <p>To release panel key lock, press and hold  (the right key) for 3 seconds on the projector or turn this function off using the remote control.</p> <p></p> <p>If you turn off the projector without disabling panel key lock, the projector will still be in locked status the next time it is turned on.</p> <p>Change Password</p> <p>See Utilizing the password function on page 21.</p> <p>Power On Lock</p> <p>See Utilizing the password function on page 21.</p>
<p>Baud Rate</p>	<p>Selects a baud rate that is identical with your computer's so that you can connect the projector using a suitable RS-232 cable and update or download the projector's firmware. This function is intended for qualified service personnel.</p>
<p>HDMI Equalizer</p>	<p>Adjusts the equalizer gain settings for an HDMI signal. The higher the setting, the stronger the gain value. If there are more than one HDMI port on the projector, select the HDMI port first before adjusting the value.</p>
<p>Reset Settings</p>	<p>Returns all of the adjustments you've made for the Settings menu to the factory preset values.</p>

System

Language	Sets the language for the On-Screen Display (OSD) menus.				
Standby Settings	<ul style="list-style-type: none"> • Network: Allows you to make following settings: <table border="1" data-bbox="375 320 1457 633"> <tr> <td data-bbox="375 320 694 398">Enable Network Standby Mode</td> <td data-bbox="694 320 1457 398">Allows the projector to provide the network function in standby mode.</td> </tr> <tr> <td data-bbox="375 398 694 633">Switch to Normal Standby Mode</td> <td data-bbox="694 398 1457 633">Allows the projector to disable the network function after a set period of time after it enters standby mode. For instance, if 20 min is selected, the projector is able to provide the network function for 20 minutes after it enters standby mode. When 20 minutes is up, the projector enters normal standby mode.</td> </tr> </table> • Audio Pass Through: The projector can play sound when it is in standby mode and the corresponding jacks are correctly connected to devices. Press ◀/▶ to choose the source that you wish to use. See Connection on page 17 for how to make the connection. 	Enable Network Standby Mode	Allows the projector to provide the network function in standby mode.	Switch to Normal Standby Mode	Allows the projector to disable the network function after a set period of time after it enters standby mode. For instance, if 20 min is selected, the projector is able to provide the network function for 20 minutes after it enters standby mode. When 20 minutes is up, the projector enters normal standby mode.
Enable Network Standby Mode	Allows the projector to provide the network function in standby mode.				
Switch to Normal Standby Mode	Allows the projector to disable the network function after a set period of time after it enters standby mode. For instance, if 20 min is selected, the projector is able to provide the network function for 20 minutes after it enters standby mode. When 20 minutes is up, the projector enters normal standby mode.				
Background Settings	<ul style="list-style-type: none"> • Background: Sets the background color for the projector. • Splash Screen: Allows you to select which logo screen will be displayed during projector start-up. 				
Menu Settings	<ul style="list-style-type: none"> • Menu Type: Switches to the Basic OSD menu. • Menu Display Time: Sets the length of time the OSD will remain active after your last key press. 				
Audio Settings	<ul style="list-style-type: none"> • Mute: Temporarily turns off the sound. • Volume: Adjusts the sound level. • Power On/Off Ring Tone: Turns on or off the ring tone when the projector is in startup and shutdown process.  <p>The only way to change Power On/Off Ring Tone is setting On or Off here. Setting the sound mute or changing the sound level will not affect the Power On/Off Ring Tone.</p>				
Closed Caption	<ul style="list-style-type: none"> • Closed Caption Enable: Activates the function by selecting On when the selected input signal carries closed captions.  <p>Captions: An on-screen display of the dialogue, narration, and sound effects of TV programs and videos that are closed captioned (usually marked as "CC" in TV listings).</p> <ul style="list-style-type: none"> • Caption Version: Selects a preferred closed captioning mode. To view captions, select CC1, CC2, CC3, or CC4 (CC1 displays captions in the primary language in your area). 				
Factory Default	<p>Returns all settings to the factory preset values.</p>  <p>The following settings will still remain: Keystone, Projector Installation, Light Usage Time, High Altitude Mode, Security Settings, Baud Rate, HDMI Equalizer.</p>				

Reset System	Returns all of the adjustments you've made for the System menu to the factory preset values.
---------------------	-----------------------------------------------------------------------------------------------------

Information

Information	<ul style="list-style-type: none"> • Native Resolution: Shows the native resolution of the projector. • Detected Resolution: Shows the native resolution of the input signal. • Source: Shows the current signal source. • Picture Mode: Shows the selected mode in the Picture menu. • Light Mode: Shows the selected mode in the Light Settings menu. • 3D Format: Shows the current 3D mode. • Color System: Shows input system format. • Light Usage Time: Shows the number of hours the lamp has been used. • Firmware Version: Shows the firmware version of your projector.
--------------------	--------------------------------------------------------------------------------------------------------------------------------------------------------------------------------------------------------------------------------------------------------------------------------------------------------------------------------------------------------------------------------------------------------------------------------------------------------------------------------------------------------------------------------------------------------------------------------------------------------------------------------------------------------------------------------------------------------------------------------------------------------

Maintenance

Care of the projector

Cleaning the lens

Clean the lens whenever you notice dirt or dust on the surface. Please be sure to turn off the projector and let it cool down completely before cleaning the lens.

- Use a canister of compressed air to remove dust.
- If there is dirt or smears, use lens-cleaning paper or moisten a soft cloth with lens cleaner and gently wipe the lens surface.
- Never use any type of abrasive pad, alkaline/acid cleaner, scouring powder, or volatile solvent, such as alcohol, benzene, thinner or insecticide. Using such materials or maintaining prolonged contact with rubber or vinyl materials may result in damage to the projector surface and cabinet material.

Cleaning the projector case

Before you clean the case, turn the projector off using the proper shutdown procedure as described in [Shutting down the projector on page 23](#) and unplug the power cord.

- To remove dirt or dust, wipe the case with a soft, lint-free cloth.
- To remove stubborn dirt or stains, moisten a soft cloth with water and a neutral pH detergent. Then wipe the case.



Never use wax, alcohol, benzene, thinner or other chemical detergents. These can damage the case.

Storing the projector

If you need to store the projector for an extended time, please follow the instructions below:

- Make sure the temperature and humidity of the storage area are within the recommended range for the projector. Please refer to [Specifications on page 42](#) or consult your dealer about the range.
- Retract the adjuster feet.
- Remove the battery from the remote control.
- Pack the projector in its original packing or equivalent.

Transporting the projector

It is recommended that you ship the projector with its original packing or equivalent.

Lamp information

Getting to know the lamp hour

When the projector is in operation, the duration (in hours) of lamp usage is automatically calculated by the built-in timer. The method of calculating the equivalent lamp hour is as follows:

Lamp Usage Time = (hours used in **Normal** mode) + (hours used in **Economic** mode) + (hours used in **SmartEco** mode) + (hours used in **LampSave** mode)

Total (equivalent) lamp hour = 3 × (hours used in **Normal** mode) + 1.5 × (hours used in **Economic** mode) + 1 × (hours used in **SmartEco** mode) + 1 × (hours used in **LampSave** mode)

To obtain the lamp hour information:

1. Go to **Advanced Menu - Settings > Light Settings** and press **OK**. The **Light Settings** page appears.
2. Press **▼** to select **Light Usage Time** and press **OK**. The **Light Usage Time** information is displayed.

You can also get the lamp hour information on the **Information** menu.

Extending lamp life

• Setting the **Light Mode**

Go to **Advanced Menu - Settings > Light Settings > Light Mode** and select a suitable lamp power from among the provided modes.

Setting the projector in **Economic, SmartEco** or **LampSave** mode extends lamp life.

Lamp mode	Description
Normal	Provides full lamp brightness
Economic	Lowers brightness to extend the lamp life and decreases the fan noise
SmartEco	Adjusts the lamp power automatically depending on the content brightness level while optimizing display quality
LampSave	Adjusts the lamp power automatically depending on the content brightness level while offering a longer lamp life

• Setting **Auto Power Off**

This function allows the projector to turn off automatically if no input signal is detected after a set period of time to prevent unnecessary waste of lamp life.

To set **Auto Power Off**, go to **Advanced Menu - Settings > Operation Settings > Power On/Off Settings > Auto Power Off** and press **◀/▶**.

Timing of replacing the lamp

When the **Lamp indicator** lights up or a message appears suggesting it is time to replace the lamp, please consult your dealer or go to <http://www.BenQ.com> before installing a new lamp. An old lamp may cause a malfunction in the projector and in some instances the lamp may explode.



- The apparent brightness of the projected image will vary depending on the ambient lighting conditions, selected input signal contrast/brightness settings, and is directly proportional to projection distance.
- The lamp brightness will decline over time and may vary within the lamp manufacturers specifications. This is normal and expected behavior.
- The **LAMP indicator light** and **TEMPerature warning light** will light up if the lamp becomes too hot. Turn the power off and let the projector cool for 45 minutes. If the Lamp or Temp indicator still lights up after turning the power back on, please contact your dealer. See [Indicators on page 40](#).

The following Lamp warning displays will remind you to change the lamp.

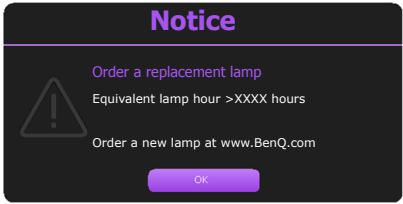
	Install a new lamp for optimal performance. Press OK to dismiss the message.
-------------------------------------------------------------------------------------	-------------------------------------------------------------------------------------

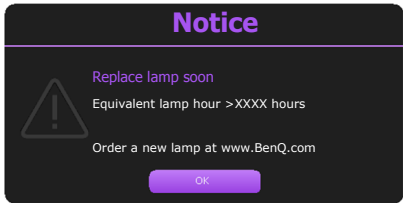
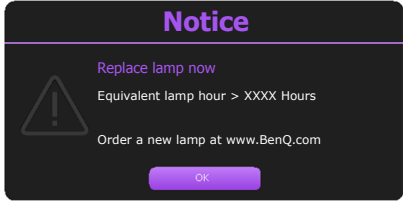
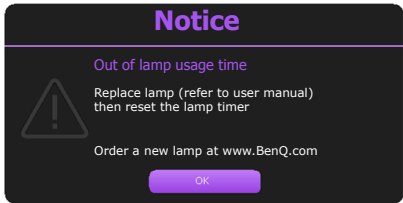
	<p>It is strongly recommended that you replace the lamp at this age. The lamp is a consumable item. The lamp brightness diminishes with use. This is normal lamp behavior. You can replace the lamp whenever you notice that the brightness level has significantly diminished. Press OK to dismiss the message.</p>
 	<p>The lamp MUST be replaced before the projector will operate normally. Press OK to dismiss the message.</p>



"XXXX" shown in the above messages are numbers that vary depending on different models.

Replacing the lamp



- To reduce the risk of electrical shock, always turn the projector off and disconnect the power cord before changing the lamp.
- To reduce the risk of severe burns, allow the projector to cool for at least 45 minutes before replacing the lamp.
- To reduce the risk of injuries to fingers and damage to internal components, use caution when removing lamp glass that has shattered into sharp pieces.
- To reduce the risk of injuries to fingers and/or compromising image quality by touching the lens, do not touch the empty lamp compartment when the lamp is removed.
- This lamp contains mercury. Consult your local hazardous waste regulations to dispose of this lamp in a proper manner.
- To assure optimal performance from the projector, it is recommended that you purchase a qualified projector lamp for lamp replacement.
- If lamp replacement is performed while the projector is suspended upside-down, make sure that no one is underneath the lamp socket to avoid any possible injury or damage to the human eyes caused by fractured lamp.
- Ensure good ventilation when handling broken lamps. We recommend that you use respirators, safety glasses, goggles or face shield and wear protective clothing such as gloves.

1. Turn the power off and disconnect the projector from the power outlet. If the lamp is hot, avoid burns by waiting for approximately 45 minutes until the lamp has cooled.
2. Loosen the screw(s) that secure the lamp cover on the side of the projector until the lamp cover loosens.
3. Open the lamp cover.

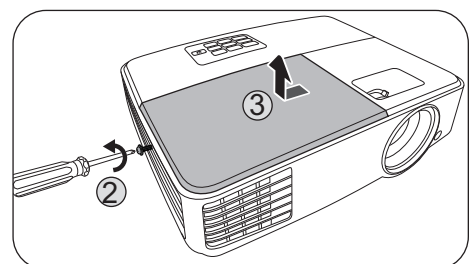

4. Remove the lamp cover from the projector.



- Do not turn the power on with the lamp cover open.
- Do not insert your fingers between the lamp and the projector. The sharp edges inside the projector may cause injuries

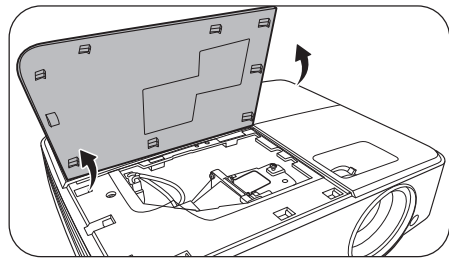

5. Disconnect the lamp connector.

6. Loosen the screw(s) that secure the inner lamp.

7. Lift the handle so that it stands up.

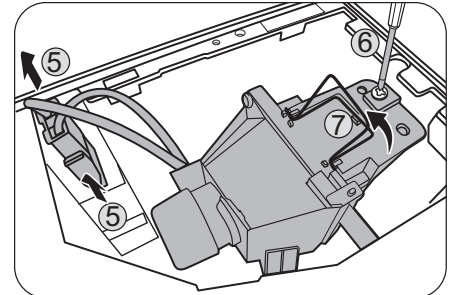

8. Use the handle to slowly pull the lamp out of the projector.



- Pulling it too quickly may cause the lamp to break and scatter broken glass in the projector.
- Do not place the lamp in locations where water might splash on it, children can reach it, or near flammable materials.
- Do not insert your hands into the projector after the lamp is removed. The sharp edges inside the projector may cause injuries. If you touch the optical components inside, it could cause color unevenness and distortion of the projected images.

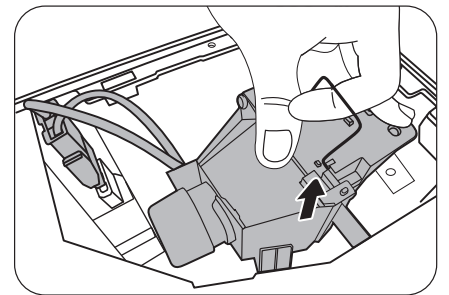

9. As shown in the figure, insert the new lamp. Align the lamp connector and 2 sharp points with the projector and push the lamp a bit into the locked position.

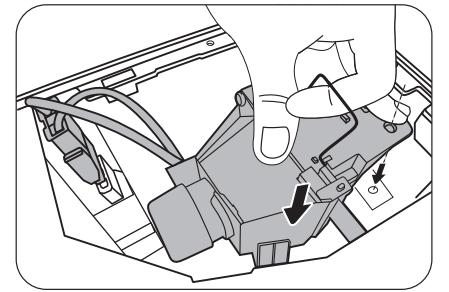

10. Insert the lamp connector.

11. Tighten the screw(s) that secures the lamp.

12. Ensure the handle is fully laid flat and locked in place.



- Loose screw may cause a bad connection, which could result in malfunction.
- Do not over tighten the screw.

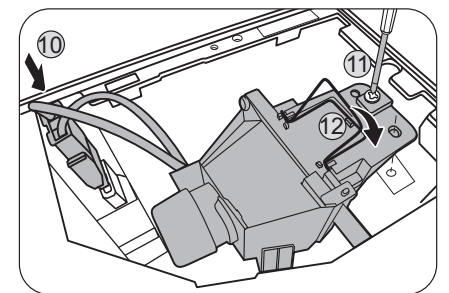

13. Replace the lamp cover on the projector.

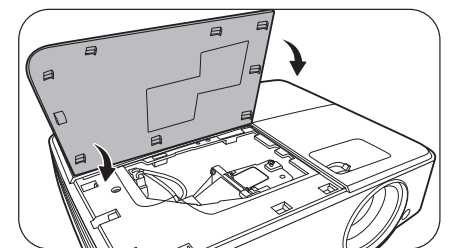

14. Tighten the screw that secures the lamp cover.



- Loose screw may cause a bad connection, which could result in malfunction.
- Do not over tighten the screw.

15. Connect the power and restart the projector.

Resetting the lamp timer

16. After the startup logo, open the On-Screen Display (OSD) menu. Go to **Advanced Menu - Settings > Light Settings** and press **OK**. The **Light Settings** page appears. Highlight **Reset Light Timer** and press **OK**. A warning message is displayed asking if you want to reset the lamp timer. Highlight **Reset** and press **OK**. The lamp time will be reset to "0".





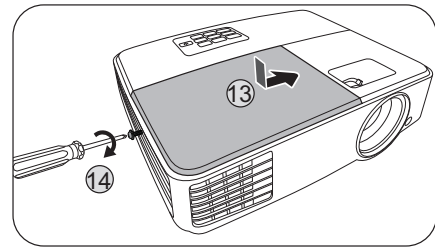





- Do not reset if the lamp is not new or replaced as this could cause damage.



Indicators

Light			Status & Description
	TEMP 	LAMP 	
Power events			
			Stand-by mode
			Powering up
			Normal operation
			Normal power-down cooling
			Download
			CW start fail
			Data abort. Scaler shutdown abnormally
			Scaler reset fail
			LAN download fail
			LAN download processing
Burn-in events			
			Burn-in on
			Burn-in off
Lamp events			
			Lamp error in normal operation
			Lamp is not lit up
			Lamp life exhausted
			Lamp door is not closed
Thermal events			
			Fan 1 error (the actual fan speed is outside the desired speed)
			Fan 2 error (the actual fan speed is outside the desired speed)
			Temperature 1 error (over limited temperature)
			Thermal Sensor 1 open error
			Thermal Sensor 1 short error
			Thermal IC #1 I2C Connection error
			Thermal IC #2 I2C Connection error
			Thermal break error

	 : Off	 : Orange On  : Orange Flashing	 : Green On  : Green Flashing	 : Red On  : Red Flashing
-------------------------------------------------------------------------------------	--------------------------------------------------------------------------------------------------	----------------------------------------------------------------------------------------------------------------------------------------------------------------------------------------------------------	--------------------------------------------------------------------------------------------------------------------------------------------------------------------------------------------------------	--------------------------------------------------------------------------------------------------------------------------------------------------------------------------------------------------------

Troubleshooting

? The projector does not turn on.

Cause	Remedy
There is no power from the power cord.	Plug the power cord into the AC power jack on the projector, and plug the power cord into the power outlet. If the power outlet has a switch, make sure that it is switched on.
Attempting to turn the projector on again during the cooling process.	Wait until the cooling down process has completed.

? No picture

Cause	Remedy
The video source is not turned on or connected correctly.	Turn the video source on and check that the signal cable is connected correctly.
The projector is not correctly connected to the input signal device.	Check the connection.
The input signal has not been correctly selected.	Select the correct input signal with the SOURCE key.
The lens cover is still closed.	Open the lens cover.

? Blurred image

Cause	Remedy
The projection lens is not correctly focused.	Adjust the focus of the lens using the focus ring.
The projector and the screen are not aligned properly.	Adjust the projection angle and direction as well as the height of the projector if necessary.
The lens cover is still closed.	Open the lens cover.

? Remote control does not work.

Cause	Remedy
The batteries are out of power.	Replace both of the batteries with new ones.
There is an obstacle between the remote control and the projector.	Remove the obstacle.
You are too far away from the projector.	Stand within 8 meters (26 feet) of the projector.

? The password is incorrect.

Cause	Remedy
You do not remember the password.	See Entering the password recall procedure on page 22.

Specifications

Projector specifications



All specifications are subject to change without notice.

Optical

Resolution

1024 x 768 XGA (MX707)
1280 x 800 WXGA (MW707)

Display system

1-CHIP DMD

Lens

F = 2.59 ~ 2.87, f = 16.88 ~ 21.88 mm

Lamp

203 W lamp

Electrical

Power supply

AC100–240V, 3.0 A, 50–60 Hz (Automatic)

Power consumption

290 W (Max); < 0.5 W (Standby); < 2 W (when the Network function in the Standby Settings is on)

Mechanical

Weight

2.0 Kg (4.41 lbs)

Output terminals

RGB output

D-Sub 15-pin (female) x 1

Speaker

10 watt x 1

Audio signal output

PC audio jack x 1

Control

RS-232 serial control

9 pin x 1

LAN control

RJ45 x 1

IR receiver x 1

Input terminals

Computer input

RGB input
D-Sub 15-pin (female) x 1

Video signal input

S-VIDEO
Mini DIN 4-pin x 1
VIDEO
RCA jack x 1
SD/HDTV signal input
Analog - Component
(through RGB input)
Digital - HDMI x 1;
HDMI/MHL x 1

Audio signal input

Audio in
PC audio jack x 1

USB

Mini-B x 1

Environmental Requirements

Operating temperature

0°C–40°C at sea level

Operating relative humidity

10%–90% (without condensation)

Operating altitude

0–1499 m at 0°C–35°C
1500–3000 m at 0°C–30°C (with High Altitude Mode on)

Storage temperature

-20°C–60°C at sea level

Storage humidity

10%–90% RH (without condensation)

Storage altitude

30°C@ 0~12,200m above sea level

Transporting

Original packing or equivalent is recommended

Repairing

Please visit below website and choose your country to find your service contact window.
<http://www.benq.com/welcome>

Dimensions

283 mm (W) x 95 mm (H) x 222 mm (D)

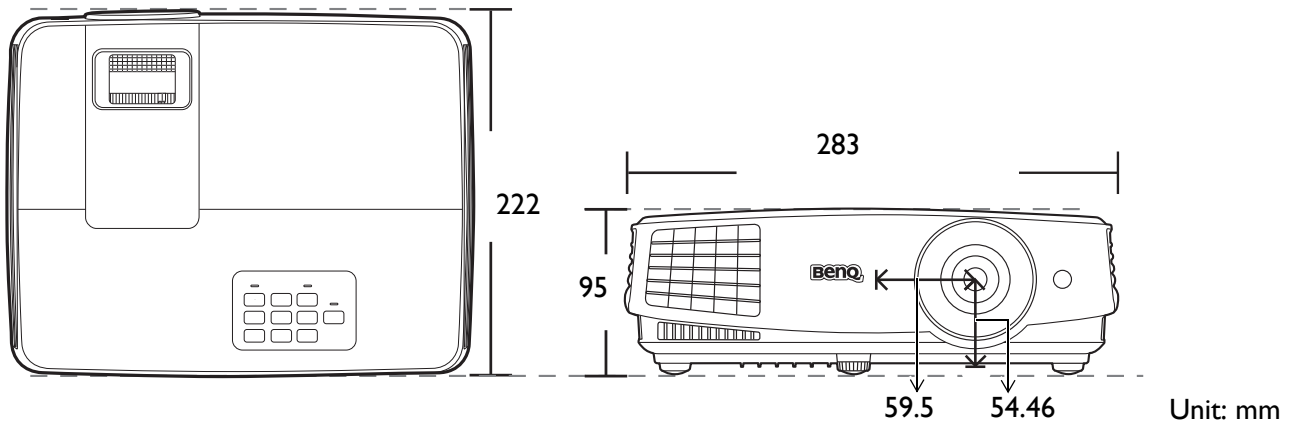

Timing chart

Supported timing for PC input

Resolution	Mode	Vertical Frequency (Hz)	Horizontal Frequency (kHz)	Pixel Frequency (MHz)	Supported 3D format		
					Frame Sequential	Top Bottom	Side by Side
720 x 400	720 x 400_70	70.087	31.469	28.3221			
640 x 480	VGA_60	59.940	31.469	25.175	V	V	V
	VGA_72	72.809	37.861	31.500			
	VGA_75	75.000	37.500	31.500			
	VGA_85	85.008	43.269	36.000			
	VGA_120**	119.518	61.910	52.500			
800 x 600	SVGA_56	56.250	35.156	36.000			
	SVGA_60	60.317	37.879	40.000	V	V	V
	SVGA_72	72.188	48.077	50.000			
	SVGA_75	75.000	46.875	49.500			
	SVGA_85	85.061	53.674	56.250			
	SVGA_120 (Reduce Blanking)	119.854	77.425	83.000	V		
1024 x 768	XGA_60	60.004	48.363	65.000	V	V	V
	XGA_70	70.069	56.476	75.000			
	XGA_75	75.029	60.023	78.750			
	XGA_85	84.997	68.667	94.500			
	XGA_120 (Reduce Blanking)	119.989	97.551	115.5	V		
1152 x 864	1152 x 864_75	75	67.5	108			
1024 x 576	BenQ Notebook_timing	60.0	35.820	46.966			
1024 x 600	BenQ Notebook_timing	64.995	41.467	51.419			
1280 x 720	1280 x 720_60	60	45.000	74.250	V	V	V
1280 x 768	1280 x 768_60	59.87	47.776	79.5	V	V	V
1280 x 800	WXGA_60	59.810	49.702	83.500	V	V	V
	WXGA_75	74.934	62.795	106.500			
	WXGA_85	84.880	71.554	122.500			
	WXGA_120 (Reduce Blanking)	119.909	101.563	146.25	V		
1280 x 1024	SXGA_60	60.020	63.981	108.000		V	V
	SXGA_75	75.025	79.976	135.000			
	SXGA_85	85.024	91.146	157.500			
1280 x 960	1280 x 960_60	60.000	60.000	108.000		V	V
	1280 x 960_85	85.002	85.938	148.500			
1360 x 768	1360 x 768_60	60.015	47.712	85.5		V	V
1440 x 900	WXGA+_60	59.887	55.935	106.500		V	V
1400 x 1050	SXGA+_60	59.978	65.317	121.750		V	V
1600 x 1200	UXGA	60.000	75.000	162.000		V	V
1680 x 1050	1680 x 1050_60	59.954	65.290	146.250		V	V
640 x 480@67Hz	MAC13	66.667	35.000	30.240			
832 x 624@75Hz	MAC16	74.546	49.722	57.280			
1024 x 768@75Hz	MAC19	74.93	60.241	80.000			
1152 x 870@75Hz	MAC21	75.060	68.680	100.000			



The timings showing above may not be supported due to EDID file and VGA graphic card limitations. It is possible that some timings cannot be chosen.

Supported timing for HDMI (HDCP) input

- PC timings

Resolution	Mode	Vertical Frequency (Hz)	Horizontal Frequency (kHz)	Pixel Frequency (MHz)	Supported 3D format		
					Frame Sequential	Top Bottom	Side by Side
640 x 480	VGA_60	59.940	31.469	25.175	V	V	V
	VGA_72	72.809	37.861	31.500			
	VGA_75	75.000	37.500	31.500			
	VGA_85	85.008	43.269	36.000			
720 x 400	720 x 400_70	70.087	31.469	28.3221			
800 x 600	SVGA_60	60.317	37.879	40.000	V	V	V
	SVGA_72	72.188	48.077	50.000			
	SVGA_75	75.000	46.875	49.500			
	SVGA_85	85.061	53.674	56.250			
	SVGA_120 (Reduce Blanking)	119.854	77.425	83.000	V		
1024 x 768	XGA_60	60.004	48.363	65.000	V	V	V
	XGA_70	70.069	56.476	75.000			
	XGA_75	75.029	60.023	78.750			
	XGA_85	84.997	68.667	94.500			
	XGA_120 (Reduce Blanking)	119.989	97.551	115.5	V		
1152 x 864	1152 x 864_75	75	67.5	108			
1024 x 576@60Hz	BenQ Notebook Timing	60.00	35.820	46.996			
1024 x 600@65Hz	BenQ Notebook Timing	64.995	41.467	51.419			
1280 x 720	1280 x 720_60	60	45.000	74.250	V	V	V
1280 x 768	1280 x 768_60	59.870	47.776	79.5	V	V	V
1280 x 800	WXGA_60	59.810	49.702	83.500	V	V	V
	WXGA_75	74.934	62.795	106.500			
	WXGA_85	84.880	71.554	122.500			
	WXGA_120 (Reduce Blanking)	119.909	101.563	146.25	V		
1280 x 1024	SXGA_60	60.020	63.981	108.000		V	V
	SXGA_75	75.025	79.976	135.000			
	SXGA_85	85.024	91.146	157.500			
1280 x 960	1280 x 960_60	60.000	60.000	108		V	V
	1280 x 960_85	85.002	85.938	148.500			
1360 x 768	1360 x 768_60	60.015	47.712	85.500		V	V
1440 x 900	WXGA+_60	59.887	55.935	106.500		V	V
1400 x 1050	SXGA+_60	59.978	65.317	121.750		V	V
1600 x 1200	UXGA	60.000	75.000	162.000		V	V
1680 x 1050	1680 x 1050_60	59.954	65.290	146.250		V	V
640 x 480@67Hz	MAC13	66.667	35.000	30.240			
832 x 624@75Hz	MAC16	74.546	49.722	57.280			
1024 x 768@75Hz	MAC19	75.020	60.241	80.000			
1152 x 870@75Hz	MAC21	75.06	68.68	100.00			
1920 x 1080@60Hz	1920 x 1080_60 (Reduce Blanking)	60	67.5	148.5		V	V
1920 x 1200@60Hz	1920 x 1200_60 (Reduce Blanking)	59.950	74.038	154.0000		V	V



The timings showing above may not be supported due to EDID file and VGA graphic card limitations. It is possible that some timings cannot be chosen.

• Video timings

Timing	Resolution	Vertical Frequency (Hz)	Horizontal Frequency (kHz)	Pixel Frequency (MHz)	Supported 3D format			
					Frame Sequential	Frame Packing	Top Bottom	Side by Side
480i	720 (1440) x 480	59.94	15.73	27	V			
480p	720 x 480	59.94	31.47	27	V			
576i	720 (1440) x 576	50	15.63	27				
576p	720 x 576	50	31.25	27				
720/50p	1280 x 720	50	37.5	74.25		V	V	V
720/60p	1280 x 720	60	45.00	74.25	V	V	V	V
1080/24P	1920 x 1080	24	27	74.25		V	V	V
1080/25P	1920 x 1080	25	28.13	74.25				
1080/30P	1920 x 1080	30	33.75	74.25				
1080/50i	1920 x 1080	50	28.13	74.25				V
1080/60i	1920 x 1080	60	33.75	74.25				V
1080/50P	1920 x 1080	50	56.25	148.5			V	V
1080/60P	1920 x 1080	60	67.5	148.5			V	V

Supported timing for MHL input

Timing	Resolution	Vertical Frequency (Hz)	Horizontal Frequency (kHz)	Pixel Frequency (MHz)
480i	720 (1440) x 480	59.94	15.73	27
480p	720 x 480	59.94	31.47	27
576i	720 (1440) x 576	50	15.63	27
576p	720 x 576	50	31.25	27
720/50p	1280 x 720	50	37.5	74.25
720/60p	1280 x 720	60	45.00	74.25
1080/24P	1920 x 1080	24	27	74.25
1080/25P	1920 x 1080	25	28.13	74.25
1080/30P	1920 x 1080	30	33.75	74.25
1080/50i	1920 x 1080	50	28.13	74.25
1080/60i	1920 x 1080	60	33.75	74.25
1080/50p	1920 x 1080	50	56.25	148.5
1080/60p	1920 x 1080	60	67.5	148.5

Supported timing for Component-YPbPr input

Timing	Resolution	Vertical Frequency (Hz)	Horizontal Frequency (kHz)	Pixel Frequency (MHz)	Supported 3D format
					Frame Sequential
480i	720 x 480	59.94	15.73	13.5	V
480p	720 x 480	59.94	31.47	27	V
576i	720 x 576	50	15.63	13.5	
576p	720 x 576	50	31.25	27	
720/50p	1280 x 720	50	37.5	74.25	
720/60p	1280 x 720	60	45.00	74.25	V
1080/50i	1920 x 1080	50	28.13	74.25	
1080/60i	1920 x 1080	60	33.75	74.25	
1080/24P	1920 x 1080	24	27	74.25	
1080/25P	1920 x 1080	25	28.13	74.25	
1080/30P	1920 x 1080	30	33.75	74.25	
1080/50P	1920 x 1080	50	56.25	148.5	
1080/60P	1920 x 1080	60	67.5	148.5	



Displaying a 1080i(1125i)@60Hz or 1080i(1125i)@50Hz signal may result in slight image vibration.

Supported timing for Video and S-Video inputs

Video mode	Horizontal Frequency (kHz)	Vertical Frequency (Hz)	Color sub-carrier Frequency (MHz)	Supported 3D format
				Frame Sequential
NTSC	15.73	60	3.58	V
PAL	15.63	50	4.43	
SECAM	15.63	50	4.25 or 4.41	
PAL-M	15.73	60	3.58	
PAL-N	15.63	50	3.58	
PAL-60	15.73	60	4.43	
NTSC4.43	15.73	60	4.43	