

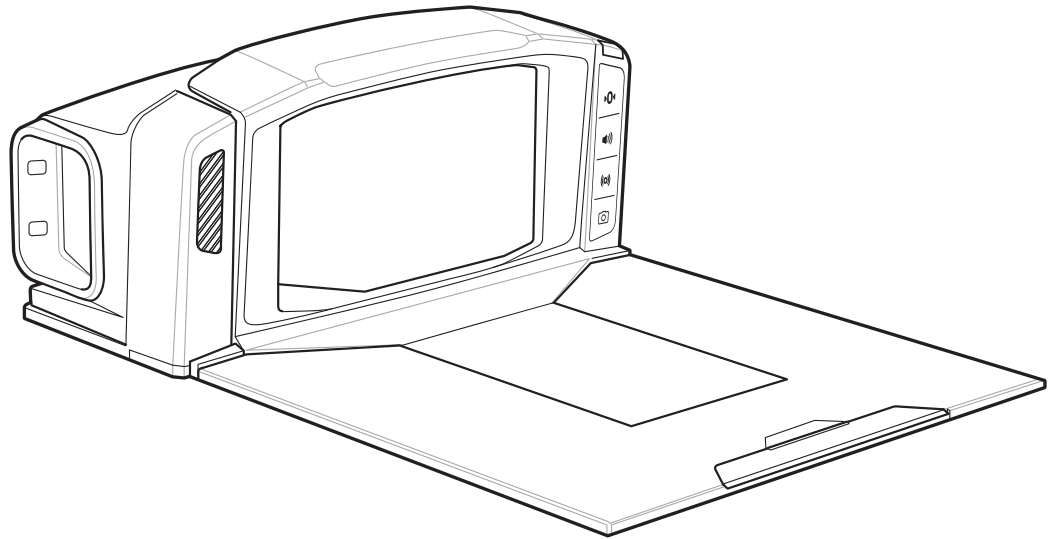

# MX101



**Customer Side Scanner  
for the MP7000 Scanner Scale**

---

**Product Reference Guide**





**MX101 CUSTOMER SIDE SCANNER  
FOR THE MP7000 SCANNER SCALE**

**PRODUCT REFERENCE GUIDE**

MN-003031-02

Revision A

April 2018

No part of this publication may be reproduced or used in any form, or by any electrical or mechanical means, without permission in writing from Zebra. This includes electronic or mechanical means, such as photocopying, recording, or information storage and retrieval systems. The material in this manual is subject to change without notice.

The software is provided strictly on an “as is” basis. All software, including firmware, furnished to the user is on a licensed basis. Zebra grants to the user a non-transferable and non-exclusive license to use each software or firmware program delivered hereunder (licensed program). Except as noted below, such license may not be assigned, sublicensed, or otherwise transferred by the user without prior written consent of Zebra. No right to copy a licensed program in whole or in part is granted, except as permitted under copyright law. The user shall not modify, merge, or incorporate any form or portion of a licensed program with other program material, create a derivative work from a licensed program, or use a licensed program in a network without written permission from Zebra. The user agrees to maintain Zebra’s copyright notice on the licensed programs delivered hereunder, and to include the same on any authorized copies it makes, in whole or in part. The user agrees not to decompile, disassemble, decode, or reverse engineer any licensed program delivered to the user or any portion thereof.

Zebra reserves the right to make changes to any software or product to improve reliability, function, or design.

Zebra does not assume any product liability arising out of, or in connection with, the application or use of any product, circuit, or application described herein.

No license is granted, either expressly or by implication, estoppel, or otherwise under any Zebra Technologies Corporation, intellectual property rights. An implied license only exists for equipment, circuits, and subsystems contained in Zebra products.

---

## Revision History

Changes to the original guide are listed below:

Change	Date	Description
MN-003031-01 Rev. A	8/2017	Initial Release
MN-003031-02 Rev. A	4/2018	Removed Scan Engine Version barcode (not supported). Updated URLs.



# TABLE OF CONTENTS

Revision History .....	iii
------------------------	-----

## About This Guide

Introduction .....	xiii
Configurations .....	xiii
Chapter Descriptions .....	xiv
Notational Conventions .....	xv
Related Documents .....	xvi
Recommended Services Information .....	xvi
Provide Documentation Feedback .....	xvi

## Chapter 1: Getting Started

Introduction .....	1-1
Interfaces .....	1-1
Unpacking .....	1-1
Features .....	1-2
Installing and Configuring the Digital Scanner .....	1-3

## Chapter 2: Data Capture

Introduction .....	2-1
Beeper and Decode LED Signals .....	2-1
Scanning .....	2-2
Decode Ranges .....	2-2

## Chapter 3: USB Interface

Introduction .....	3-1
Setting Parameters .....	3-1
Errors While Scanning .....	3-1
USB Parameter Defaults .....	3-2
USB Host Parameters .....	3-2
TGCS (IBM) USB Specification Version .....	3-3

**Chapter 4: User Preferences & Miscellaneous Options**

Introduction .....	4-1
Setting Parameters .....	4-1
Phantom Scan Session .....	4-2
Scanning Sequence Examples .....	4-2
Errors While Scanning .....	4-2
User Preferences/Miscellaneous Options Parameter Defaults .....	4-2
User Preferences .....	4-4
Default Parameters .....	4-4
Write to Custom Defaults .....	4-4
Parameter Barcode Scanning .....	4-5
Lock/Unlock Parameter Scanning .....	4-5
Locking/Unlocking via the Host Interface .....	4-6
Beep After Good Decode .....	4-6
Beeper Volume .....	4-7
Beeper Tone .....	4-8
Beeper Duration .....	4-9
Suppress Power Up Beeps .....	4-9
Trigger Mode .....	4-10
Decode Aiming Pattern .....	4-10
Motion Detect Range .....	4-11
Decode Session Timeout .....	4-11
Timeout Between Decodes, Same Symbol .....	4-12
Timeout Between Decodes, Different Symbols .....	4-12
Mobile Phone/Display Mode .....	4-13
Range Restrict .....	4-14
Presentation Mode Field of View .....	4-15
Fuzzy 1D Processing .....	4-15
Mirrored Image .....	4-16
Decoding Illumination .....	4-16
Illumination Brightness .....	4-17
Validate Concatenated Parameter Barcodes .....	4-17
Miscellaneous Scanner Parameters .....	4-18
Transmit Code ID Character .....	4-18
Prefix/Suffix Values .....	4-19
Scan Data Transmission Format .....	4-20
Send Versions .....	4-22
Software Version .....	4-22
Manufacturing Information .....	4-22
Camera Manufacturing Information .....	4-22

**Chapter 5: Symbologies**

Introduction .....	5-1
Setting Parameters .....	5-1
Scanning Sequence Examples .....	5-2
Errors While Scanning .....	5-2
Symbology Parameter Defaults .....	5-2
Enable/Disable All Code Types .....	5-8
UPC/EAN/JAN .....	5-8



UPC-A .....	5-8
UPC-E .....	5-9
UPC-E1 .....	5-9
EAN-8/JAN-8 .....	5-10
EAN-13/JAN-13 .....	5-10
Bookland EAN .....	5-11
Bookland ISBN Format .....	5-12
ISSN EAN .....	5-13
Decode UPC/EAN/JAN Supplementals .....	5-13
User-Programmable Supplementals .....	5-16
UPC/EAN/JAN Supplemental Redundancy .....	5-17
UPC/EAN/JAN Supplemental AIM ID Format .....	5-17
Transmit UPC-A Check Digit .....	5-18
Transmit UPC-E Check Digit .....	5-19
Transmit UPC-E1 Check Digit .....	5-19
UPC-A Preamble .....	5-20
UPC-E Preamble .....	5-21
UPC-E1 Preamble .....	5-22
Convert UPC-E to UPC-A .....	5-23
Convert UPC-E1 to UPC-A .....	5-23
EAN/JAN Zero Extend .....	5-24
UCC Coupon Extended Code .....	5-24
Coupon Report .....	5-25
Code 128 .....	5-26
Set Lengths for Code 128 .....	5-26
GS1-128 (formerly UCC/EAN-128) .....	5-27
ISBT 128 .....	5-28
ISBT Concatenation .....	5-28
Check ISBT Table .....	5-29
ISBT Concatenation Redundancy .....	5-29
Code 39 .....	5-30
Trioptic Code 39 .....	5-30
Convert Code 39 to Code 32 .....	5-31
Code 32 Prefix .....	5-31
Set Lengths for Code 39 .....	5-32
Code 39 Check Digit Verification .....	5-33
Transmit Code 39 Check Digit .....	5-34
Code 39 Full ASCII Conversion .....	5-34
Code 39 Buffering - Scan & Store .....	5-35
Buffer Data .....	5-35
Clear Transmission Buffer .....	5-35
Transmit Buffer .....	5-36
Overfilling Transmission Buffer .....	5-36
Attempt to Transmit an Empty Buffer .....	5-36
Code 93 .....	5-37
Set Lengths for Code 93 .....	5-37
Code 11 .....	5-39
Set Lengths for Code 11 .....	5-39
Code 11 Check Digit Verification .....	5-41
Transmit Code 11 Check Digits .....	5-42

Interleaved 2 of 5 (ITF) .....	5-42
Set Lengths for Interleaved 2 of 5 .....	5-43
I 2 of 5 Check Digit Verification .....	5-45
Transmit I 2 of 5 Check Digit .....	5-45
Convert I 2 of 5 to EAN-13 .....	5-46
Discrete 2 of 5 (DTF) .....	5-46
Set Lengths for Discrete 2 of 5 .....	5-47
Codabar (NW - 7) .....	5-48
Set Lengths for Codabar .....	5-49
CLSI Editing .....	5-51
NOTIS Editing .....	5-51
Codabar Upper or Lower Case Start/Stop Characters .....	5-52
MSI .....	5-52
Set Lengths for MSI .....	5-53
MSI Check Digits .....	5-54
Transmit MSI Check Digit(s) .....	5-55
MSI Check Digit Algorithm .....	5-55
Chinese 2 of 5 .....	5-56
Matrix 2 of 5 .....	5-56
Set Lengths for Matrix 2 of 5 .....	5-57
Matrix 2 of 5 Check Digit .....	5-58
Transmit Matrix 2 of 5 Check Digit .....	5-59
Korean 3 of 5 .....	5-59
Inverse 1D .....	5-60
GS1 DataBar .....	5-61
GS1 DataBar Omnidirectional (formerly GS1 DataBar-14), GS1 DataBar Truncated, GS1 DataBar Stacked, GS1 DataBar Stacked Omnidirectional .....	5-61
GS1 DataBar Limited .....	5-61
GS1 DataBar Expanded, GS1 DataBar Expanded Stacked .....	5-62
Convert GS1 DataBar to UPC/EAN/JAN .....	5-62
GS1 DataBar Limited Margin Check .....	5-63
Symbology-Specific Security Features .....	5-64
Redundancy Level .....	5-64
Security Level .....	5-66
Intercharacter Gap Size .....	5-67
Composite .....	5-67
Composite CC-C .....	5-67
Composite CC-A/B .....	5-68
Composite TLC-39 .....	5-68
UPC Composite Mode .....	5-69
Composite Beep Mode .....	5-70
GS1-128 Emulation Mode for UCC/EAN Composite Codes .....	5-70
2D Symbologies .....	5-71
PDF417 .....	5-71
MicroPDF417 .....	5-71
Code 128 Emulation .....	5-72
Data Matrix .....	5-73
Data Matrix Inverse .....	5-73
Decode Data Matrix Mirror Images .....	5-74
Maxicode .....	5-75

QR Code .....	5-75
QR Inverse .....	5-76
MicroQR .....	5-77
Aztec .....	5-77
Aztec Inverse .....	5-78
Macro PDF Features .....	5-79
Macro PDF User Indications .....	5-79
Macro PDF Transmit / Decode Mode Symbols .....	5-80
Transmit Macro PDF Control Header .....	5-81
Escape Characters .....	5-81
Flush Macro Buffer .....	5-82
Abort Macro PDF Entry .....	5-82
Postal Codes .....	5-82
US Postnet .....	5-82
US Planet .....	5-83
Transmit US Postal Check Digit .....	5-83
UK Postal .....	5-84
Transmit UK Postal Check Digit .....	5-84
Japan Postal .....	5-85
Australia Post .....	5-85
Australia Post Format .....	5-86
Netherlands KIX Code .....	5-87
USPS 4CB/One Code/Intelligent Mail .....	5-87
UPU FICS Postal .....	5-88
<b>Chapter 6: 123Scan and Software Tools</b>	
Introduction .....	6-1
123Scan .....	6-1
Communication with 123Scan .....	6-2
123Scan Requirements .....	6-2
123Scan Information .....	6-2
Scanner SDK, Other Software Tools, and Videos .....	6-3
Scanner Control App .....	6-3
Advanced Data Formatting (ADF) .....	6-4
<b>Chapter 7: Installing the MX101 Customer Side Scanner</b>	
Introduction .....	7-1
Installing the MX101 on the MP70XX .....	7-2
Installing the MX101 on the Customer's Right Side of the Tower Cover .....	7-3
<b>Chapter 8: Maintenance, Troubleshooting, and Signal Descriptions</b>	
Introduction .....	8-1
Maintenance .....	8-1
Troubleshooting .....	8-2
Report Software Version Barcode .....	8-3
Digital Scanner Signal Descriptions .....	8-3

**Appendix A: Standard Parameter Defaults**

**Appendix B: Programming Reference**

Symbol Code Identifiers ..... B-1  
 AIM Code Identifiers ..... B-2

**Appendix C: Numeric Barcodes**

Numeric Barcodes ..... C-1  
 Cancel ..... C-2

**Appendix D: Alphanumeric Barcodes**

Cancel ..... D-1  
 Alphanumeric Barcodes ..... D-1

**Appendix E: Sample Barcodes**

UPC/EAN ..... E-1  
     UPC-A, 100% ..... E-1  
     UPC-A with 2-digit Add-on ..... E-2  
     UPC-A with 5-digit Add-on ..... E-3  
     UPC-E ..... E-4  
     UPC-E with 2-digit Add-on ..... E-5  
     UPC-E with 5-digit Add-on ..... E-6  
     EAN-8 ..... E-7  
     EAN-13, 100% ..... E-8  
     EAN-13 with 2-digit Add-on ..... E-9  
     EAN-13 with 5-digit Add-on ..... E-10  
 Code 128 ..... E-11  
     GS1-128 ..... E-12  
 Code 39 ..... E-13  
 Code 93 ..... E-14  
 Code 11 with 2 Check Digits ..... E-15  
 Interleaved 2 of 5 ..... E-16  
 MSI with 2 Check Digits ..... E-17  
 Chinese 2 of 5 ..... E-18  
 Matrix 2 of 5 ..... E-19  
 Korean 3 of 5 ..... E-20  
 GS1 DataBar ..... E-21  
     GS1 DataBar Omnidirectional (formerly GS1 DataBar-14) ..... E-21  
     GS1 DataBar Truncated ..... E-22  
     GS1 DataBar Stacked ..... E-23  
     GS1 DataBar Stacked Omnidirectional ..... E-24  
     GS1 DataBar Limited ..... E-25  
     GS1 DataBar Expanded ..... E-26  
     GS1 DataBar Expanded Stacked ..... E-27  
 2D Symbolologies ..... E-28  
     PDF417 ..... E-28

Data Matrix ..... E-29  
QR Code ..... E-31  
MicroQR ..... E-33  
Aztec ..... E-34

**Index**



# ABOUT THIS GUIDE

---

## Introduction

The *MX101 Product Reference Guide* provides general instructions for setting up, operating, maintaining, and troubleshooting the MX101 digital scanner.

---

## Configurations

MX101 Kit: MX101-SR7000WW.

**Table ii-1** *MP7000 Scanner Scale Configurations*

Configuration	Description
<b>MP7000 Scanner Scale with CSS</b>	
MP7011-LNS0M00US	MP7011 Scanner Scale, Long, Single Interval Scale, Sapphire, CSS, Platter without Flip Up Bar, United States
MP7011-LNSLM00AU	MP7011 Scanner Scale, Long, Single Interval Scale, Sapphire, Platter with Flip Up Bar, CSS, Australia
MP7011-LNSLM00CM	MP7011 Scanner Scale, Long, Single Interval Scale, Sapphire, Platter with Flip Up Bar, Canada/Mexico
MP7011-LNSLM00US	MP7011 Scanner Scale, Long, Single Interval Scale, Sapphire, CSS, Platter with Flip Up Bar, United States

**Notes:**

1. EU scales are legally accepted in the following countries: Austria, Belgium, Bulgaria, Croatia, Cyprus, Czech Republic, Denmark, Estonia, Finland, France, Germany, Greece, Hungary, Ireland, Iceland, Italy, Liechtenstein, Lithuania, Luxembourg, Latvia, Malta, Netherlands, Norway, Poland, Portugal, Romania, Slovak Republic, Slovenia, Spain, Sweden, Switzerland, and United Kingdom
2. OIML scales are legally accepted in the following countries: Bahamas, Barbados, Belize, Bermuda, Chile, Colombia, Costa Rica, Ecuador, El Salvador, Guatemala, Hong Kong, Jamaica, Saint Lucia, Panama, Peru, Philippines, Thailand, Trinidad, and Tobago

**Table ii-1** MP7000 Scanner Scale Configurations (Continued)

Configuration	Description
MP7011-LPSLM00US	MP7011 Scanner Scale, Long, Single Interval Scale, Sapphire, CSS, Drivers License Parsing, Platter with Flip Up Bar, United States
MP7011-LNSLM00NN	MP7011 Scanner Scale, Long, Single Interval Scale, Sapphire, CSS, Platter with Flip Up Bar, OIML
MP7011-MNSLM00AU	MP7011 Scanner Scale, Medium, Single Interval Scale, Sapphire, CSS, Platter with Flip Up Bar, Australia
MP7011-MNSLM00EU	MP7011 Scanner Scale, Medium, Single Interval Scale, Sapphire, CSS, Platter with Flip Up Bar, Europe
MP7011-MNSLM00US	MP7011 Scanner Scale, Medium, Single Interval Scale, Sapphire, CSS, Platter with Flip Up Bar, United States
MP7011-MPSLM00US	MP7011 Scanner Scale, Medium, Single Interval Scale, Sapphire, CSS, Platter with Flip Up Bar, Drivers License Parsing, United States
MP7012-LNSLM00EU	MP7012 Scanner Scale, Long, Dual Interval, Sapphire, CSS, Europe
MP7012-MNSLM00EU	MP7012 Scanner Scale, Medium, Dual Interval, Sapphire, CSS, Europe
MP7012-LNSLM00NN	MP7012 Scanner Scale, Long, Dual Interval, Sapphire, CSS, OIML
MP7012-MNSLM00NN	MP7012 Scanner Scale, Medium, Dual Interval, Sapphire, CSS, OIML
MP7012-LNSLM00RU	MP7012 Scanner Scale, Long, Dual Interval, Sapphire, CSS, Russia
MP7012-MNSLM00RU	MP7012 Scanner Scale, Medium, Dual Interval, Calibration Switch, Sapphire, CSS, Russia

**Notes:**

- EU scales are legally accepted in the following countries: Austria, Belgium, Bulgaria, Croatia, Cyprus, Czech Republic, Denmark, Estonia, Finland, France, Germany, Greece, Hungary, Ireland, Iceland, Italy, Liechtenstein, Lithuania, Luxembourg, Latvia, Malta, Netherlands, Norway, Poland, Portugal, Romania, Slovak Republic, Slovenia, Spain, Sweden, Switzerland, and United Kingdom
- OIML scales are legally accepted in the following countries: Bahamas, Barbados, Belize, Bermuda, Chile, Colombia, Costa Rica, Ecuador, El Salvador, Guatemala, Hong Kong, Jamaica, Saint Lucia, Panama, Peru, Philippines, Thailand, Trinidad, and Tobago

---

## Chapter Descriptions

Topics covered in this guide are as follows:

- [Chapter 1, Getting Started](#) provides information about the scanner's features, and setting up, installing, and configuring the digital scanner.
- [Chapter 2, Data Capture](#) provides beeper and LED definitions, techniques involved in capturing barcodes, general instructions and tips about scanning, and decode range information.
- [Chapter 3, USB Interface](#) describes how to set up the decoder with a USB host.
- [Chapter 4, User Preferences & Miscellaneous Options](#) describes features frequently used to customize how data transmits to the host device and programming barcodes for selecting user preference features for the decoder.



- [Chapter 5, Symbologies](#) describes all symbology features and provides programming barcodes for selecting these features for the decoder.
- [Chapter 6, 123Scan and Software Tools](#) describes this PC-based scanner configuration tool which enables rapid and easy customized setup of scanners.
- [Chapter 7, Installing the MX101 Customer Side Scanner](#) provides the steps to install the MX101 into the MP7000.
- [Chapter 8, Maintenance, Troubleshooting, and Signal Descriptions](#) provides suggested digital scanner maintenance, troubleshooting, technical specifications, and signal descriptions (pinouts).
- [Appendix A, Standard Parameter Defaults](#) provides a table of all host devices and miscellaneous defaults.
- [Appendix B, Programming Reference](#) provides a table of AIM code identifiers, ASCII character conversions, and keyboard maps.
- [Appendix C, Numeric Bar Codes](#) includes the numeric barcodes to scan for parameters requiring specific numeric values.
- [Appendix D, Alphanumeric Bar Codes](#) includes the alphanumeric barcodes to scan for parameters requiring specific alphanumeric values.
- [Appendix E, Sample Bar Codes](#) includes sample barcodes of various code types.

---

## Notational Conventions

The following conventions are used in this document:

- MP7000 Scanner Scale is used interchangeable with MP70XX.
- *Italics* are used to highlight the following:
  - Chapters and sections in this and related documents
  - Dialog box, window and screen names
  - Drop-down list and list box names
  - Check box and radio button names
- **Bold** text is used to highlight the following:
  - Key names on a keypad
  - Button names on a screen.
- bullets (•) indicate:
  - Action items
  - Lists of alternatives
  - Lists of required steps that are not necessarily sequential
- Sequential lists (e.g., those that describe step-by-step procedures) appear as numbered lists.
- Throughout the programming barcode menus, asterisks (\*) are used to denote default parameter settings.

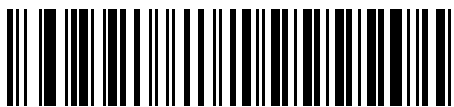

\* Indicates Default — \* **Baud Rate 9600** — Feature/Option

---

## Related Documents

- *MP7000 Scanner Scale Integrator Guide*, p/n MN-002914-xx, provides site preparation and installation information, as well as operating instructions.
- *MP7000 Scanner Scale Barcode Programming Guide*, p/n MN-002912-xx, provides barcodes for MP7000 Scanner Scale configuration.
- *MP7000 Scanner Scale Regulatory Guide*, p/n MN-002939-xx, provides domestic and international regulatory information, and China RoHS information.
- *Advanced Data Formatting Programmer Guide*, p/n 72E-69680-xx, provides information on ADF, a means of customizing data before transmission to a host.

For the latest version of this guide and all Zebra guides, go to: [www.zebra.com/support](http://www.zebra.com/support).

---

## Recommended Services Information

If you have a problem using the equipment, contact your facility's technical or systems support. If there is a problem with the equipment, they will contact the Zebra Customer Support Center at: [www.zebra.com/support](http://www.zebra.com/support).

When contacting Zebra support, please have the following information available:

- Serial number of the unit
- Model number or product name
- Software type and version number

Zebra responds to calls by e-mail, telephone or fax within the time limits set forth in service agreements.

If your problem cannot be solved by the Zebra Customer Support Center, you may need to return your equipment for servicing and will be given specific directions or a Field Service Technician may be sent to your location to perform the repair, depending on your level of entitlement set forth in the service agreement. Zebra is not responsible for any damages incurred during shipment if the approved shipping container is not used. Shipping the units improperly can possibly void the warranty.

If you purchased your business product from a Zebra business partner, please contact that business partner for support.

Zebra recommends the following Service options to keep the MP7000 Scanner Scale operating at peak performance throughout its life-cycle:

- Service from the Start with Advance Exchange Support (available for scanner-only configurations).
- Service from the Start with On Site System Support (available for scanner-only and scanner/scale configurations).

---

## Provide Documentation Feedback

If you have comments, questions, or suggestions about this guide, send an email to [EVM-Techdocs@zebra.com](mailto:EVM-Techdocs@zebra.com).

# CHAPTER 1 GETTING STARTED

---

## Introduction

The MX101 combines superior 1D and 2D omnidirectional barcode scanning with an advanced feature set in a compact design. The digital scanner was designed to integrate seamlessly into the MP7000 Scanner Scale and is optimized for scanning customer cell phones and loyalty cards.

This chapter provides information about the scanner's features, and setting up, installing, and configuring the digital scanner.

---

## Interfaces

The MX101 digital scanner connects to the MP7000 Scanner Scale via a single USB cable, and defaults to the SNAPi interface type.

---

## Unpacking

Remove the unit from the packing and inspect for damage. If the scanner was damaged in transit, visit the Zebra Support & Downloads web site at [www.zebra.com/support](http://www.zebra.com/support) for information. KEEP THE PACKING. It is the approved shipping container and should be used if the equipment ever needs to be returned for servicing.

## Features

The default location of the MX101 is in the left side tower of MP7000 Scanner Scale units purchased with an integrated MX101. The MX101 can be repositioned to the right side tower of the MP70XX if needed.

To add the MX101 to the MP7000 Scanner Scale customers must purchase the MX101-SR7000WW kit.

The MX101 scanner has the following features:

- Scans paper and mobile phone 1D/2D loyalty cards and coupons.
- Auditory and visual feedback on decode.
- Auto wakeup upon object presentation.

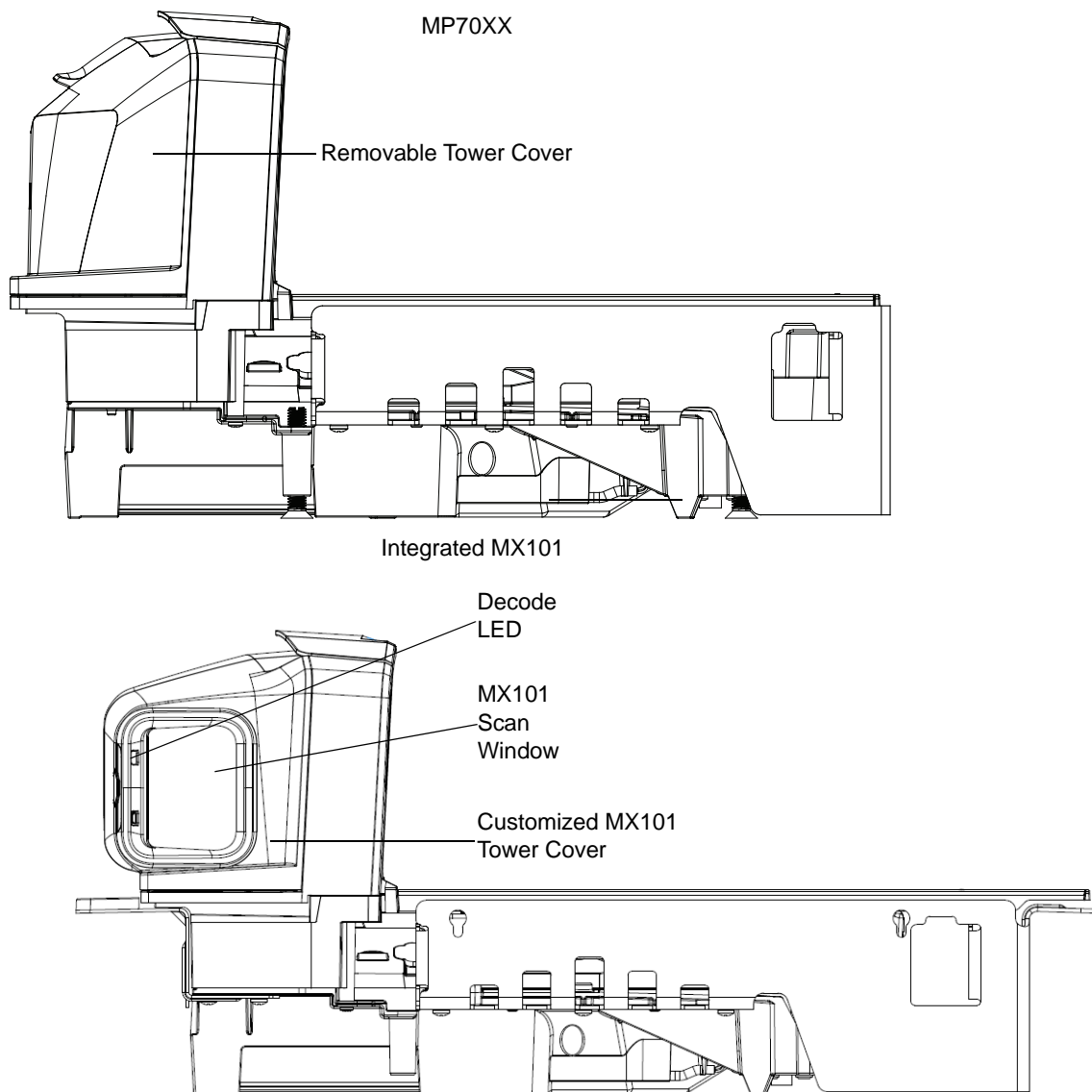

**Figure 1-1** *Scanner Features*

To add the MX101 to the MP7000 Scanner Scale customers must purchase the MX101-SR7000WW kit.

---

## Installing and Configuring the Digital Scanner

To configure the digital scanner use the barcodes included in this manual, or use the 123Scan configuration program (see [Chapter 6, 123Scan and Software Tools](#)). Also see [Chapter 4, User Preferences & Miscellaneous Options](#) and [Chapter 5, Symbologies](#) for information about programming the digital scanner using barcode menus.

See [Chapter 7, Installing the MX101 Customer Side Scanner](#) for instructions to install the MX101 into the MP7000 Scanner Scale.



# CHAPTER 2 DATA CAPTURE

---

## Introduction

This chapter provides beeper and LED definitions, techniques involved in capturing barcodes, general instructions and tips about scanning, and decode range information.

---

## Beeper and Decode LED Signals

The digital scanner has a visual green LED indicator and issues different beep sequences, and patterns to indicate status. [Table 2-1](#) defines beep sequences that occur during both normal scanning and while programming the digital scanner.

**Table 2-1** *User Interface Indications*

Description	Indication	
	Beeper	Decode LED
No Decode	No Audible Sound	No Light
Decode	Middle Tone	Flash of Light
Bootup	Low Tone, Middle Tone, High Tone	No Light
Transmission Error	Four Low Tones	No Light
Entry Error	Low Tone, High Tone	Flash of Light
Defaults Set	High Tone, Low Tone, High Tone, Low Tone	Flash of Light
Parameter Entered		
Number Entry Expected	High Tone, Low Tone	Flash of Light

## Scanning

For standard operation, the scanner automatically decodes barcodes that are presented in its field of view.

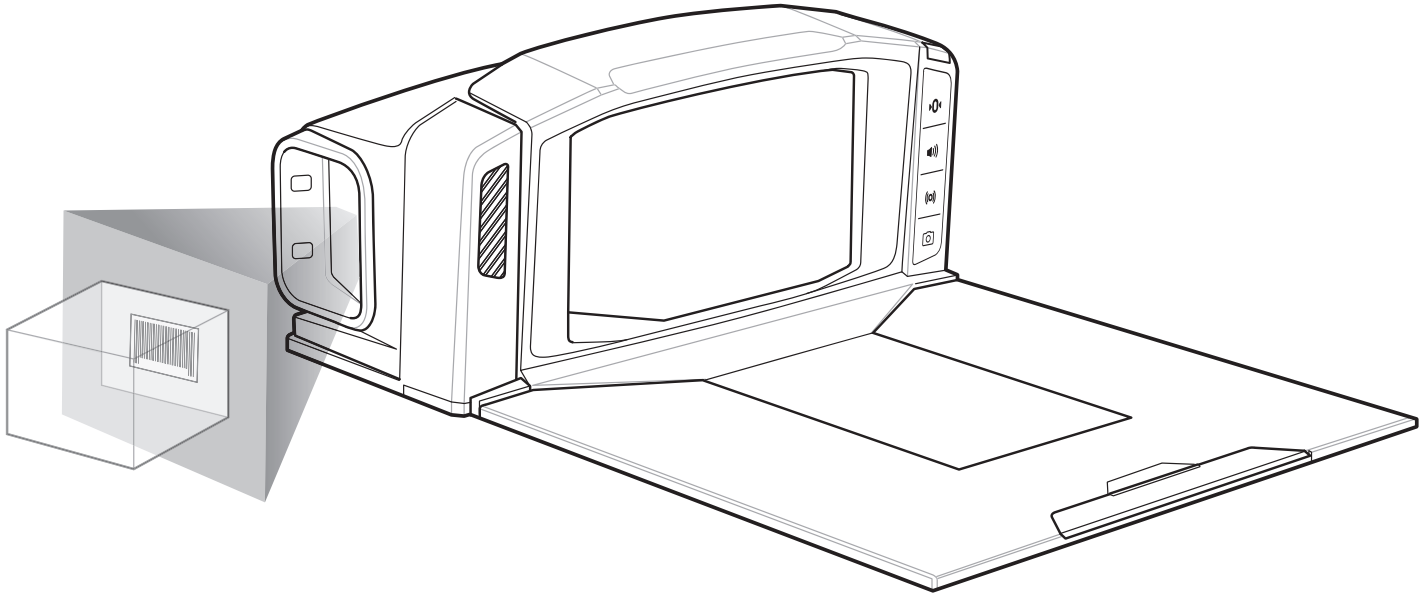

Figure 2-1 Scanning

## Decode Ranges

Table 2-2 Decode Ranges

Symbol Specification	Typical Working Ranges (from side of MP70XX)	
	Near	Far
UPCA 13.0mil 80% MRD	Contact Read	9.55 in./ 24.3 cm
PDF417 6.67mil 80% MRD	Contact Read	2.75 in./7.0 cm
Code 128 15.0mil 80% MRD	Contact Read	7.5 in./19.1 cm



# CHAPTER 3 USB INTERFACE

---

## Introduction

This chapter describes how to set up the scanner which connects directly to a USB port on the MP70XX. No additional power supply is required.

The scanner ships with the settings shown in [Table 3-1 on page 3-2](#) (also see [Appendix A, Standard Parameter Defaults](#) for all defaults). If the default values suit requirements, programming is not necessary.

---

## Setting Parameters

To set feature values, scan a single barcode or a short barcode sequence. The settings are stored in non-volatile memory and are preserved even when the scanner powers down.

✓ **NOTE** Most computer monitors allow scanning barcodes directly on the screen. When scanning from the screen, be sure to set the document magnification to a level where you can see the barcode clearly, and bars and/or spaces do not merge.

To return all features to default values, see [Default Parameters on page 4-4](#). Throughout the programming barcode menus, asterisks (\*) indicate default values.



\* Indicates default      \*Enable Parameter      Feature/option

## Errors While Scanning

Unless otherwise specified, to correct an error during a scanning sequence, just re-scan the correct parameter.

## USB Parameter Defaults

[Table 3-1](#) lists defaults for USB host parameters. Change these values in one of two ways:

- Scan the appropriate barcodes in this chapter. The new value replaces the standard default value in memory. To recall default parameter values, see [Default Parameters on page 4-4](#).
- Configure the scanner using the 123Scan configuration program. See [Chapter 6, 123Scan and Software Tools](#).

✓ **NOTE** See [Appendix A, Standard Parameter Defaults](#) for all user preference, host, symbology, and miscellaneous default parameters.

**Table 3-1** USB Interface Parameter Defaults

Parameter	Default	Page Number
USB Host Parameters	Symbol Native API (SNAPI) with Imaging Interface	<a href="#">3-2</a>
TGCS (IBM) USB Specification Version	IBM Specification Level Version 0 (Original)	<a href="#">3-3</a>

## USB Host Parameters

When the MX101 connects to the MP70XX, the MP70XX manages the device using the best fit host type to maximize communication between the two devices. Host types should not change. The default host type is **Symbol Native API (SNAPI) with Imaging Interface**. Scan **Symbol Native API (SNAPI) without Imaging Interface** to change the option.

✓ **NOTE** When changing USB Device Types, the scanner resets and issues the standard startup beep sequences.

✓ **NOTE** See [Appendix A, Standard Parameter Defaults](#) for all user preferences, symbologies, and miscellaneous default parameters.



**Symbol Native API (SNAPI) with Imaging Interface**



**Symbol Native API (SNAPI) without Imaging Interface**

## TGCS (IBM) USB Specification Version

**IBM Specification Level Version 0 (Original)** sends the following code types as Unknown:

- Data Matrix
- QR Code
- MicroQR Code
- Aztec

**IBM Specification Level Version 2.2** sends the code types with the appropriate IBM identifiers.

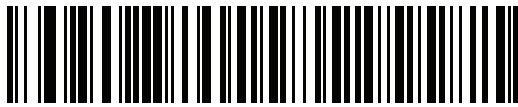

\*IBM Specification Level Version 0 (Original)



IBM Specification Level Version 2.2



# CHAPTER 4 USER PREFERENCES & MISCELLANEOUS OPTIONS

---

## Introduction

You can program the scanner to perform various functions, or activate different features. This chapter describes user preference features and provides programming barcodes for selecting these features.

The scanner ships with the settings shown in [Table 4-1 on page 4-2](#) (also see [Appendix A, Standard Parameter Defaults](#) for all defaults). If the default values suit requirements, programming is not necessary.

---

## Setting Parameters

To set feature values, scan a single barcode or a short barcode sequence. The settings are stored in non-volatile memory and are preserved even when the scanner powers down.

✓ **NOTE** Most computer monitors allow scanning barcodes directly on the screen. When scanning from the screen, be sure to set the document magnification to a level where you can see the barcode clearly, and bars and/or spaces do not merge.

If not using the default host, select the host type (see each host chapter for specific host information) after the power-up beeps sound. This is only necessary upon the first power-up when connected to a new host.

To return all features to default values, see [Default Parameters on page 4-4](#). Throughout the programming barcode menus, asterisks indicate (\*) default values.

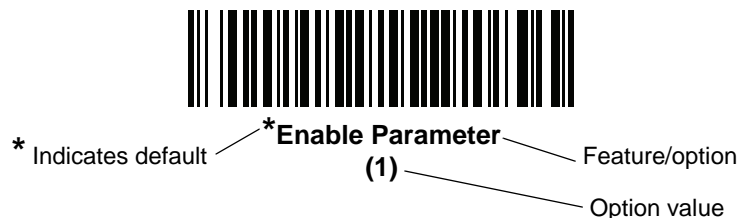

## Phantom Scan Session

The *Phantom Scan Session* feature places the system into a known state for two seconds immediately after the power-up beep sequence in order to decode a parameter barcode without intervention, and regardless of existing settings and mode. This allows the user to scan a **Set Defaults**, or other parameter barcode without triggering the decoder or initiating a host scan session in order to return an unresponsive system to its factory default settings. Aim and illumination are turned off, and Phantom Scan exits upon a host command or successful decode.

## Scanning Sequence Examples

In most cases, scanning one barcode sets the parameter value. For example, to set the beeper tone to high, scan the **High Frequency** (beeper tone) barcode listed under [Beeper Tone on page 4-8](#). The scanner issues a fast warble beep and the LED turns green, signifying a successful parameter entry.

Other parameters require scanning several barcodes. See the parameter descriptions for this procedure.

## Errors While Scanning

Unless otherwise specified, to correct an error during a scanning sequence, just re-scan the correct parameter.

## User Preferences/Miscellaneous Options Parameter Defaults

[Table 4-1](#) lists defaults for user preferences parameters. Change these values in one of two ways:

- Scan the appropriate barcodes in this chapter. The new value replaces the standard default value in memory. To recall default parameter values, see [Default Parameters on page 4-4](#).
- Configure the scanner using the 123Scan configuration program. See [Chapter 6, 123Scan and Software Tools](#).

✓ **NOTE** See [Appendix A, Standard Parameter Defaults](#) for all user preference, host, symbology, and miscellaneous default parameters.

**Table 4-1** *User Preferences Parameter Defaults*

Parameter	Parameter Number <sup>1</sup>	SSI Number <sup>2</sup>	Default	Page Number
<b>User Preferences</b>				
Set Default Parameter	N/A	N/A	Restore Defaults	<a href="#">4-4</a>
Parameter Barcode Scanning	236	ECh	Enable	<a href="#">4-5</a>
Lock Parameter Scanning	802	F2h 22h	Disable	<a href="#">4-5</a>
Unlock Parameter Scanning	803	F2h 23h	Disable	<a href="#">4-5</a>
Beep After Good Decode	56	38h	Enable	<a href="#">4-6</a>
Beeper Volume	140	8Ch	High	<a href="#">4-7</a>

1. Parameter number decimal values are used for programming via RSM commands.

2. SSI number hex values are used for programming via SSI commands.

**Table 4-1** User Preferences Parameter Defaults (continued)

Parameter	Parameter Number <sup>1</sup>	SSI Number <sup>2</sup>	Default	Page Number
Beeper Tone	145	91h	High	4-8
Beeper Duration	628	F1h 74h	Long	4-9
Trigger Mode	138	8Ah	Presentation Mode	4-10
Decode Aiming Pattern	306	F0h 32h	Disable	4-10
Suppress Power Up Beeps	721	F1h D1h	Do Not Suppress	4-9
Motion Detect Range	827	F2h 3Bh	Short Range	4-11
Decode Session Timeout	136	88h	9.9 Seconds	4-11
Timeout Between Decodes, Same Symbol	137	89h	0.6 Seconds	4-12
Timeout Between Decodes, Different Symbols	144	90h	0.2 Seconds	4-12
Mobile Phone/Display Mode	716	F1h CCh	Enable	4-13
Range Restrict	629	F1h 75h	3 inches	4-14
Presentation Mode Field of View	609	F1h 61h	Medium Field of View	4-15
Fuzzy 1D Processing	514	F1h 02h	Enable	4-15
Mirrored Image	624	F1h 70h	Disable	4-16
Decoding Illumination	298	F0h 2Ah	Enable	4-16
Illumination Brightness	669	F1h 9Dh	6	4-17
Validate Concatenated Parameter Barcodes	692	F1h B4h	Disable	4-17
Miscellaneous Options				
Transmit Code ID Character	45	2Dh	None	4-18
SSI Prefix Value	99, 105	63h, 69h	<CR>	4-19
SSI Suffix 1 Value	98, 104	62h, 68h	<CR>	4-19
SSI Suffix 2 Value	100, 106	64h, 6Ah	<CR>	
Scan Data Transmission Format	235	EBh	Data As Is	4-20
Send Versions				
Software Version	N/A	N/A	N/A	4-22
Manufacturing Information	N/A	N/A	N/A	4-22
Camera Manufacturing Information	N/A	N/A	N/A	4-22

1. Parameter number decimal values are used for programming via RSM commands.

2. SSI number hex values are used for programming via SSI commands.

---

## User Preferences

### Default Parameters

Scan one of the following barcodes to reset the scanner to its default settings as follows:

- **Restore Defaults** resets all default parameters as follows:
  - If you configured custom default parameter values via the **Write to Custom Defaults** barcode, scanning the **Restore Defaults** barcode restores these custom values.
  - If you did not configure custom default parameter values, scanning the **Restore Defaults** barcode restores the factory default values. See [Appendix A, Standard Parameter Defaults](#) for these values.
- **Set Factory Defaults** clears all custom default values and sets the factory default values. See [Appendix A, Standard Parameter Defaults](#) for these values.



\*Restore Defaults



Set Factory Defaults

### Write to Custom Defaults

To create a set of custom defaults, select the desired parameter values in this guide, and then scan **Write to Custom Defaults**.



Write to Custom Defaults



## Parameter Barcode Scanning

### Parameter # 236

#### SSI # ECh

Scan one of the following barcodes to select whether to enable or disable the decoding of parameter barcodes, including the **Set Defaults** barcodes.



\*Enable Parameter Barcode Scanning  
(1)



Disable Parameter Barcode Scanning  
(0)

## Lock/Unlock Parameter Scanning

### Lock: Parameter # 803

### Unlock: Parameter # 803

### Lock: SSI # F2h 22h

### Unlock: SSI # F2h 23h

This feature locks parameter settings with a 4-digit code to prevent the user from changing parameter values by scanning parameter barcodes. This provides an added level of security not offered via **Disable Parameter Scanning**.

After locking parameter settings, the only parameter barcode that is accepted is **Unlock** with the correct code.



**NOTE** *Parameter Barcode Scanning* must be enabled in order to scan the **Lock** parameter barcode. Once parameter scanning is locked, scanning the **Enable** or **Disable Parameter Scanning** barcode results in a parameter error beep.

To lock parameter scanning:

1. Scan the **Lock** barcode.
2. Scan four barcodes from [Appendix C, Numeric Bar Codes](#) that represent the desired code. Enter leading zeros for numbers below 1000, e.g., to program a code of 29, enter **0, 0, 2, 9**. A "lock" beep sounds (two long high beeps) in addition to the parameter entry beep.

To unlock parameter scanning:

1. Scan the **Unlock** barcode.
2. Scan four barcodes from [Appendix C, Numeric Bar Codes](#) that represent the correct code. An "unlock" beep sounds (two long low beeps) in addition to the parameter entry beep. Entering an incorrect code results in a parameter error beep.

## Lock/Unlock Parameter Scanning (continued)



Lock



Unlock

### Locking/Unlocking via the Host Interface

Parameter scanning can also be locked or unlocked using a host interface such as SSI or USB SNAPI. To lock parameter scanning using the host interface, store a 4-digit code within the range of 1-9999 in the Lock parameter. Values outside this range are ignored. To unlock parameter scanning, store this code in the Unlock parameter. To persist the lock/unlock status through a power cycle, make this parameter value permanent.

✓ **NOTE** Parameter values can be changed via host interface commands even when parameter scanning is locked.

## Beep After Good Decode

### Parameter # 56

#### SSI # 38h

Scan one of the following barcodes to select whether or not the scanner beeps after a good decode. If you select **Disable Beep After Good Decode**, the beeper still operates during parameter menu scanning and to indicate error conditions.



\*Enable Beep After Good Decode  
(1)



Disable Beep After Good Decode  
(0)

## Beeper Volume

Parameter # 140

SSI # 8Ch

Scan one of the following barcodes to select a beeper volume.



**Low Volume**  
(2)



**Medium Volume**  
(1)



**\*High Volume**  
(0)

## Beeper Tone

Parameter # 145

SSI # 91h

Scan one of the following barcodes to select a beeper tone for the good decode beep.



**Disable Tone**  
**(3)**

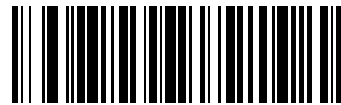

**Low Tone**  
**(2)**

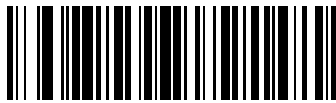

**Medium Tone**  
**(1)**

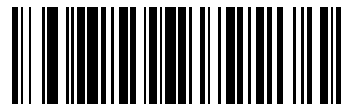

**\*High Tone**  
**(0)**



**Medium to High Tone (2-tone)**  
**(4)**

## Beeper Duration

Parameter # 628

SSI # F1h 74h

Scan one of the following barcodes to select the duration for the good decode beep.

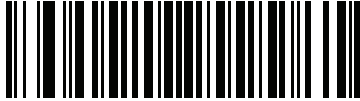

Short Duration  
(0)



Medium Duration  
(1)

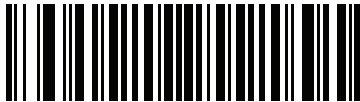

\*Long Duration  
(2)

## Suppress Power Up Beeps

Parameter # 721

SSI # F1h D1h

Scan one of the following barcodes to select whether or not to suppress the scanner's power-up beeps.



\*Do Not Suppress Power Up Beeps  
(0)



Suppress Power Up Beeps  
(1)

## Trigger Mode

Parameter # 138

SSI # 8Ah

Scan one of the following barcodes to select a trigger mode for the scanner:

- **Presentation (Blink)** - The scanner activates decode processing when it detects a barcode in its field of view. After a period of non-use, the LEDs turn off until the scanner senses motion.
- **Host and Hardware Trigger Mode** - A host command issues the triggering signal, which is interpreted as a level trigger option.

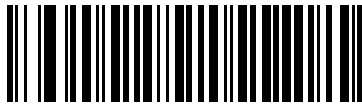

**Presentation (Blink)**  
(7)



**Host and Hardware Trigger Mode**  
(8)

## Decode Aiming Pattern

Parameter # 306

SSI # F0h 32h

Select **Enable Decode Aiming Pattern** to project the aiming pattern during barcode capture, or **Disable Decode Aiming Pattern** to turn the aiming pattern off.

- **Enable Decode Aiming Pattern** - This projects the aiming pattern during barcode capture.
- **Disable Decode Aiming Pattern** - This turns the aiming pattern off.

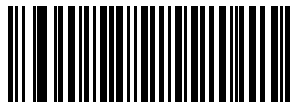

**Enable Decode Aiming Pattern**  
(2)



**\*Disable Decode Aiming Pattern**  
(0)

## Motion Detect Range

Parameter # 827

SSI # F2h 3Bh

Scan one of the following barcodes to select the distance, or range, at which the scanner detects object motion and then triggers while in presentation mode.

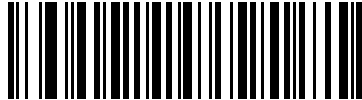

Full Range  
(1)



Medium Range  
(3)



\*Short Range  
(8)

## Decode Session Timeout

Parameter # 136

SSI # 88h

This parameter sets the maximum time decode processing continues during a scan attempt. It is programmable in 0.1 second increments from 0.5 to 9.9 seconds. The default timeout is 9.9 seconds.

To set a Decode Session Timeout, scan the following barcode, and then scan two barcodes from [Appendix C, Numeric Bar Codes](#) that correspond to the desired on time. Enter a leading zero for single digit numbers. For example, to set a Decode Session Timeout of 0.5 seconds, scan this barcode, and then scan the **0** and **5** barcodes. To correct an error or change the selection, scan [Cancel on page C-2](#).



Decode Session Timeout

## Timeout Between Decodes, Same Symbol

**Parameter # 137**

**SSI # 89h**

Use this option in presentation mode to prevent the scanner from continuously decoding the same barcode when it is left in the scanner's field of view. The barcode must be out of the field of view for the timeout period before the scanner reads the same consecutive symbol. It is programmable in 0.1 second increments from 0.0 to 9.9 seconds. The default interval is 0.6 seconds.

To select the timeout between decodes for the same symbol, scan the following barcode, and then scan two barcodes from [Appendix C, Numeric Bar Codes](#) that correspond to the desired interval, in 0.1 second increments.



**Timeout Between Decodes, Same Symbol**

## Timeout Between Decodes, Different Symbols

**Parameter # 144**

**SSI # 90h**

Use this option in presentation mode to control the time the scanner waits before decoding a different symbol. It is programmable in 0.1 second increments from 0.1 to 9.9 seconds. The default is 0.2 seconds.

To select the timeout between decodes for different symbols, scan the following barcode, and then scan two barcodes from [Appendix C, Numeric Bar Codes](#) that correspond to the desired interval, in 0.1 second increments..



**NOTE** Timeout Between Decodes, Different Symbols cannot be greater than or equal to the [Decode Session Timeout](#).



**Timeout Between Decodes, Different Symbols**



## Mobile Phone/Display Mode

Parameter # 716

SSI # F1h CCh

This mode improves barcode reading performance off mobile phones and electronic displays. Scan one of the following barcodes to select the desired mode.



**\*Enable Mobile Phone/Display Mode  
(3)**

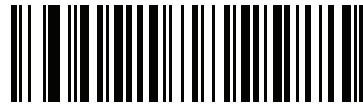

**Disable Mobile Phone/Display Mode  
(0)**

## Range Restrict

### Parameter # 629

### SSI # F1h 75h

Range restriction can be enabled by setting a parameter value greater than zero and disabled when setting a value of zero. When enabled it allows for reducing the reading range of a UPC family barcode to a restricted range in inches. The parameter value represents a maximum reading range of a 100% UPC family barcode.

The value is approximate and small variations to a restriction limit are to be expected.

When scanning barcodes of different densities (i.e., 60%, 80%, and 200%) the range limit is scaled up/down proportional to the density.

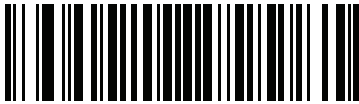

Disable  
(00h)



\* 3 inches  
(03h)

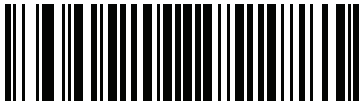

5 inches  
(05h)

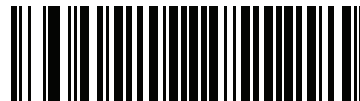

7 inches  
(07h)

## Presentation Mode Field of View

Parameter # 609

SSI # F1h 61h

In presentation mode, by default the scanner searches the larger area of the aiming pattern (**Full Field of View**). Select **Small Field of View** or **Medium Field of View** to search for a barcode in a smaller region around the aiming pattern's center in order to speed search time.

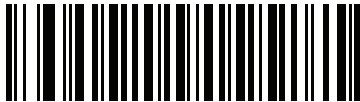

Small Field of View  
(0)

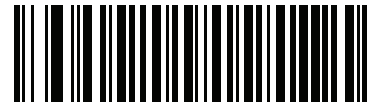

Medium Field of View  
(1)



\*Full Field of View  
(2)

## Fuzzy 1D Processing

Parameter # 514

SSI # F1h 02h

This option is enabled by default to optimize decode performance on 1D barcodes, including damaged and poor quality symbols. Disable this only if you experience time delays when decoding 2D barcodes, or in detecting a no decode.



\*Enable Fuzzy 1D Processing  
(01h)



Disable Fuzzy 1D Processing  
(00h)

## Mirrored Image

**Parameter # 624**

**SSI # F1h 70h**

Enable this to scan images in reverse, or mirrored, as if seen through a mirror. This mode is useful in applications requiring scanning through a mirror and using symbologies that do not decode in reverse.

Enabling this mode when using snapshot mode transmits images as mirrored images.

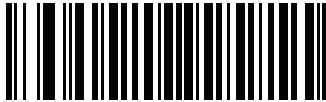

**\*Disable Mirrored Image  
(00h)**



**Enable Mirrored Image  
(01h)**

## Decoding Illumination

**Parameter # 298**

**SSI # F0h 2Ah**

Scan one of the following barcodes to determine whether the scanner turns on illumination to aid decoding.

Enabling illumination usually results in superior images and better decode performance. The effectiveness of the illumination decreases as the distance to the target increases.



**\*Enable Decoding Illumination  
(1)**



**Disable Decoding Illumination  
(0)**

## Illumination Brightness

**Parameter # 669**

**SSI # F1h 9Dh**

This feature sets the brightness of the illumination by altering LED power. The default is 10, which is maximum LED brightness. For values from 1 to 10, LED brightness varies from lowest to highest level of brightness. The default is 6.

To program Illumination Brightness, scan this barcode followed by two numeric barcodes in [Appendix C, Numeric Bar Codes](#) that correspond to the value of desired illumination brightness. For example, to set Illumination Brightness to 6, scan the barcode below followed by the 0 and 6 barcodes.



**Illumination Brightness**

## Validate Concatenated Parameter Barcodes

**Parameter # 692**

**SSI # F1h B4h**

The scanner can encounter invalid parameters when using concatenated parameter barcodes intended for different scanner models or different versions of a scanner. This parameter determines how to process concatenated parameter barcodes when the scanner encounters an invalid parameter setting in the barcode.

Disable this to ignore invalid parameters and configure valid parameters. Enable this to ignore all parameters if one or more are invalid.



**\*Disable Validate Concatenated Parameter Barcodes  
(00h)**



**Enable Validate Concatenated Parameter Barcodes  
(01h)**

---

## Miscellaneous Scanner Parameters

### Transmit Code ID Character

Parameter # 45

SSI # 2Dh

A Code ID character identifies the code type of a scanned barcode. This is useful when decoding more than one code type. In addition to any single character prefix selected, the Code ID character is inserted between the prefix and the decoded symbol.

Select no Code ID character, a Symbol Code ID character, or an AIM Code ID character. For Code ID characters, see [Symbol Code Characters on page B-1](#) and [Aim Code Characters on page B-2](#).

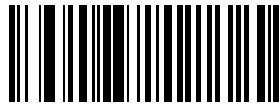

Symbol Code ID Character  
(2)

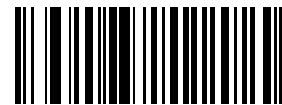

AIM Code ID Character  
(1)

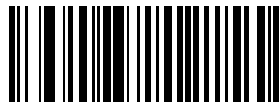

\*None  
(0)

## Prefix/Suffix Values

**Key Category Parameter # P = 99, S1 = 98, S2 = 100**

**SSI # P = 63h, S1 = 62h, S2 = 64h**

**Decimal Value Parameter # P = 105, S1 = 104, S2 = 106**

**SSI # P = 69h, S1 = 68h, S2 = 6Ah**

You can append a prefix and/or one or two suffixes to scan data for use in data editing. To set a value for a prefix or suffix, scan one of the following barcodes, and then scan four barcodes from [Appendix C, Numeric Bar Codes](#) that correspond to that value. The first digit defines the key category (type of character to send) and is stored in the key category parameter. The remaining three digits define the value of the character and are stored in the decimal value parameter. Ensure to use both key category and decimal value parameters to define the prefix/suffix value.

When using host commands to set the prefix or suffix, set the key category parameter to 1, and then set the 3-digit decimal value. See [Appendix E, ASCII Character Sets](#) for the four-digit codes.

To correct an error or change a selection, scan [Cancel on page C-2](#).

✓ **NOTE** To use Prefix/Suffix values, first set the [Scan Data Transmission Format on page 4-20](#).

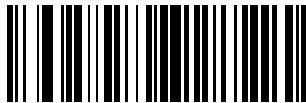

**Scan Prefix  
(7)**

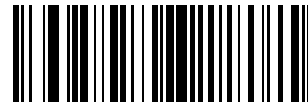

**Scan Suffix 1  
(6)**



**Scan Suffix 2  
(8)**

## Scan Data Transmission Format

### Parameter # 235

#### SSI # EBh

To change the scan data format, scan one of the following barcodes corresponding to the desired format.

✓ **NOTE** If using this parameter do not use ADF rules to set the prefix/suffix.

To set values for the prefix and/or suffix, see [Prefix/Suffix Values on page 4-19](#).



\*Data As Is  
(0)



<DATA> <SUFFIX 1>  
(1)



<DATA> <SUFFIX 2>  
(2)



<DATA> <SUFFIX 1> <SUFFIX 2>  
(3)



## Scan Data Transmission Format (continued)



<PREFIX> <DATA >  
(4)



<PREFIX> <DATA> <SUFFIX 1>  
(5)



<PREFIX> <DATA> <SUFFIX 2>  
(6)



<PREFIX> <DATA> <SUFFIX 1> <SUFFIX 2>  
(7)

---

## Send Versions

### Software Version

Scan the following barcode to send the version of software installed in the scanner.

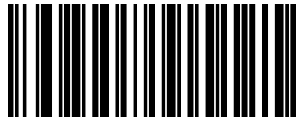

**Software Version**

### Manufacturing Information

Scan the following barcode to send the scanner manufacturing information to the host.

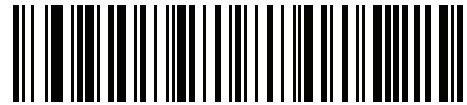

**Manufacturing Information**

### Camera Manufacturing Information

Scan the following barcode to send the camera manufacturing information to the host.

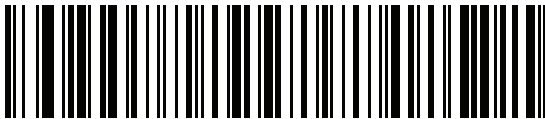

**Camera Manufacturing Information**

# CHAPTER 5 SYMBOLOGIES

---

## Introduction

You can program the scanner to perform various functions, or activate different features. This chapter describes symbology features and provides programming barcodes for selecting these features.

The scanner ships with the settings shown in [Table 5-1 on page 5-2](#) (also see [Appendix A, Standard Parameter Defaults](#) for all defaults). If the default values suit requirements, programming is not necessary.

---

## Setting Parameters

To set feature values, scan a single barcode or a short barcode sequence. The settings are stored in non-volatile memory and are preserved even when the scanner powers down.

✓ **NOTE** Most computer monitors allow scanning barcodes directly on the screen. When scanning from the screen, be sure to set the document magnification to a level where you can see the barcode clearly, and bars and/or spaces do not merge.

If not using a USB cable, select a host type (see each host chapter for specific host information) after the power-up beeps sound. This is only necessary upon the first power-up when connected to a new host.

To return all features to default values, see [Default Parameters on page 4-4](#). Throughout the programming barcode menus, asterisks (\*) indicate default values.



\* Indicates default — \*Enable Parameter — Feature/option

## Scanning Sequence Examples

In most cases, scanning one barcode sets the parameter value. For example, to transmit barcode data without the UPC-A check digit, scan the **Do Not Transmit UPC-A Check Digit** barcode under [Transmit UPC-A Check Digit on page 5-18](#). The scanner issues a fast warble beep and the LED turns green, signifying a successful parameter entry.

Other parameters require scanning several barcodes. See the parameter descriptions for this procedure.

## Errors While Scanning

Unless otherwise specified, to correct an error during a scanning sequence, just re-scan the correct parameter.

## Symbology Parameter Defaults

[Table 5-1](#) lists defaults for all symbology parameters. Change these values in one of two ways:

- Scan the appropriate barcodes in this chapter. The new value replaces the standard default value in memory. To recall the default parameter values, see [Default Parameters on page 4-4](#).
- Configure the scanner using the 123Scan configuration program. See [Chapter 6, 123Scan and Software Tools](#).

✓ **NOTE** See [Appendix A, Standard Parameter Defaults](#) for all user preference, host, symbology, and miscellaneous default parameters.

**Table 5-1** Symbology Parameter Defaults

Parameter	Parameter Number <sup>1</sup>	SSI Number <sup>2</sup>	Default	Page Number
<b>Enable/Disable All Code Types</b>				<a href="#">5-8</a>
<b>1D Symbologies</b>				
<b>UPC/EAN/JAN</b>				
UPC-A	1	01h	Disable	<a href="#">5-8</a>
UPC-E	2	02h	Disable	<a href="#">5-9</a>
UPC-E1	12	0Ch	Disable	<a href="#">5-9</a>
EAN-8/JAN 8	4	04h	Disable	<a href="#">5-10</a>
EAN-13/JAN 13	3	03h	Disable	<a href="#">5-10</a>
Bookland EAN	83	53h	Disable	<a href="#">5-11</a>
Bookland ISBN Format	576	F1h 40h	ISBN-10	<a href="#">5-12</a>
ISSN EAN	617	F1h 69h	Disable	<a href="#">5-13</a>

1. Parameter number decimal values are used for programming via RSM commands.
2. SSI number hex values are used for programming via SSI commands.

**Table 5-1** Symbology Parameter Defaults (continued)

Parameter	Parameter Number <sup>1</sup>	SSI Number <sup>2</sup>	Default	Page Number
Decode UPC/EAN/JAN Supplementals (2 and 5 digits)	16	10h	Ignore	5-13
User-Programmable Supplementals			N/A	5-16
Supplemental 1:	579	F4h F1h 43h		
Supplemental 2:	580	F4h F1h 44h		
UPC/EAN/JAN Supplemental Redundancy	80	50h	10	5-17
Decode UPC/EAN/JAN Supplemental AIM ID	672	F1h A0h	Combined	5-17
Transmit UPC-A Check Digit	40	28h	Enable	5-18
Transmit UPC-E Check Digit	41	29h	Enable	5-19
Transmit UPC-E1 Check Digit	42	2Ah	Enable	5-19
UPC-A Preamble	34	22h	System Character	5-20
UPC-E Preamble	35	23h	System Character	5-21
UPC-E1 Preamble	36	24h	System Character	5-22
Convert UPC-E to A	37	25h	Disable	5-23
Convert UPC-E1 to A	38	26h	Disable	5-23
EAN/JAN Zero Extend	39	27h	Disable	5-24
UCC Coupon Extended Code	85	55h	Disable	5-24
Coupon Report	730	F1h DAh	New Coupon Format	5-25
<b>Code 128</b>				
Code 128	8	08h	Enable	5-26
Set Length(s) for Code 128	209, 210	D1h, D2h	Any Length	5-26
GS1-128 (formerly UCC/EAN-128)	14	0Eh	Disable	5-27
ISBT 128	84	54h	Disable	5-28
ISBT Concatenation	577	F1h 41h	Disable	5-28
Check ISBT Table	578	F1h 42h	Enable	5-29
ISBT Concatenation Redundancy	223	DFh	10	5-29
<b>Code 39</b>				
Code 39	0	00h	Disable	5-30

1. Parameter number decimal values are used for programming via RSM commands.
2. SSI number hex values are used for programming via SSI commands.

**Table 5-1** Symbology Parameter Defaults (continued)

Parameter	Parameter Number <sup>1</sup>	SSI Number <sup>2</sup>	Default	Page Number
Trioptic Code 39	13	0Dh	Disable	5-30
Convert Code 39 to Code 32 (Italian Pharmacy Code)	86	56h	Disable	5-31
Code 32 Prefix	231	E7h	Disable	5-31
Set Length(s) for Code 39	18, 19	12h, 13h	2 to 55	5-32
Code 39 Check Digit Verification	48	30h	Disable	5-33
Transmit Code 39 Check Digit	43	2Bh	Disable	5-34
Code 39 Full ASCII Conversion	17	11h	Disable	5-34
Code 39 Buffering	113	71h	Disable	5-35
<b>Code 93</b>				
Code 93	9	09h	Disable	5-37
Set Length(s) for Code 93	26, 27	1Ah, 1Bh	4 to 55	5-37
<b>Code 11</b>				
Code 11	10	0Ah	Disable	5-39
Set Length(s) for Code 11	28, 29	1Ch, 1Dh	4 to 55	5-39
Code 11 Check Digit Verification	52	34h	Disable	5-41
Transmit Code 11 Check Digit(s)	47	2Fh	Disable	5-42
<b>Interleaved 2 of 5 (ITF)</b>				
Interleaved 2 of 5 (ITF)	6	06h	Disable	5-42
Set Lengths for I 2 of 5	22, 23	16h, 17h	1 Length; Length = 14	5-43
I 2 of 5 Check Digit Verification	49	31h	Disable	5-45
Transmit I 2 of 5 Check Digit	44	2Ch	Disable	5-45
Convert I 2 of 5 to EAN 13	82	52h	Disable	5-46
<b>Discrete 2 of 5 (DTF)</b>				
Discrete 2 of 5	5	05h	Disable	5-46
Set Length(s) for D 2 of 5	20, 21	14h 15h	1 Length; Length = 12	5-47
<b>Codabar (NW - 7)</b>				
Codabar	7	07h	Disable	5-48

1. Parameter number decimal values are used for programming via RSM commands.  
2. SSI number hex values are used for programming via SSI commands.

**Table 5-1** Symbology Parameter Defaults (continued)

Parameter	Parameter Number <sup>1</sup>	SSI Number <sup>2</sup>	Default	Page Number
Set Lengths for Codabar	24, 25	18h, 19h	5 to 55	<a href="#">5-49</a>
CLSI Editing	54	36h	Disable	<a href="#">5-51</a>
NOTIS Editing	55	37h	Disable	<a href="#">5-51</a>
Codabar Upper or Lower Case Start/ Stop Characters Detection	855	F2h 57h	Upper Case	<a href="#">5-52</a>
<b>MSI</b>				
MSI	11	0Bh	Disable	<a href="#">5-52</a>
Set Length(s) for MSI	30, 31	1Eh, 1Fh	4 to 55	<a href="#">5-53</a>
MSI Check Digits	50	32h	One	<a href="#">5-54</a>
Transmit MSI Check Digit	46	2Eh	Disable	<a href="#">5-55</a>
MSI Check Digit Algorithm	51	33h	Mod 10/Mod 10	<a href="#">5-55</a>
<b>Chinese 2 of 5</b>				
Chinese 2 of 5	408	F0h 98h	Disable	<a href="#">5-56</a>
<b>Matrix 2 of 5</b>				
Matrix 2 of 5	618	F1h 6Ah	Disable	<a href="#">5-56</a>
Matrix 2 of 5 Lengths	619 620	F1h 6Bh F1h 6Ch	Any Length	<a href="#">5-57</a>
Matrix 2 of 5 Check Digit	622	F1h 6Eh	Disable	<a href="#">5-58</a>
Transmit Matrix 2 of 5 Check Digit	623	F1h 6Fh	Disable	<a href="#">5-59</a>
<b>Korean 3 of 5</b>				
Korean 3 of 5	581	F1h 45h	Disable	<a href="#">5-59</a>
<b>Inverse 1D</b>	586	F1h 4Ah	Regular	<a href="#">5-60</a>
<b>GS1 DataBar</b>				
GS1 DataBar Omnidirectional (formerly GS1 DataBar-14), GS1 DataBar Truncated, GS1 DataBar Stacked, GS1 DataBar Stacked Omnidirectional	338	F0h 52h	Enable	<a href="#">5-61</a>
GS1 DataBar Limited	339	F0h 53h	Disable	<a href="#">5-61</a>
GS1 DataBar Expanded, GS1 DataBar Expanded Stacked	340	F0h 54h	Disable	<a href="#">5-62</a>
Convert GS1 DataBar to UPC/EAN/JAN	397	F0h 8Dh	Disable	<a href="#">5-62</a>

1. Parameter number decimal values are used for programming via RSM commands.
2. SSI number hex values are used for programming via SSI commands.

**Table 5-1** Symbology Parameter Defaults (continued)

Parameter	Parameter Number <sup>1</sup>	SSI Number <sup>2</sup>	Default	Page Number
GS1 DataBar Limited Margin Check	728	F1h D8h	Level 3	5-63
<b>Symbology-Specific Security Features</b>				
Redundancy Level	78	4Eh	1	5-64
Security Level	77	4Dh	1	5-66
Intercharacter Gap Size	381	F0h 7Dh	Normal	5-67
<b>Composite Codes</b>				
Composite CC-C	341	F0h 55h	Disable	5-67
Composite CC-A/B	342	F0h 56h	Disable	5-68
Composite TLC-39	371	F0h 73h	Disable	5-68
UPC Composite Mode	344	F0h 58h	UPC Never Linked	5-69
Composite Beep Mode	398	F0h 8Eh	Beep As Each Code Type is Decoded	5-70
GS1-128 Emulation Mode for UCC/EAN Composite Codes	427	F0h ABh	Disable	5-70
<b>2D Symbologies</b>				
PDF417	15	0Fh	Disable	5-71
MicroPDF417	227	E3h	Disable	5-71
Code 128 Emulation	123	7Bh	Disable	5-72
Data Matrix	292	F0h 24h	Disable	5-73
Data Matrix Inverse	588	F1h 4Ch	Regular Only	5-73
Decode Data Matrix Mirror Images	537	F1h 19h	Auto	5-74
Maxicode	294	F0h 26h	Disable	5-75
QR Code	293	F0h 25h	Disable	5-75
QR Inverse	587	F1h 4Bh	Regular	5-76
MicroQR	573	F1h 3Dh	Disable	5-77
Aztec	574	F1h 3Eh	Disable	5-77
Aztec Inverse	589	F1h 4Dh	Inverse Autodetect	5-78

1. Parameter number decimal values are used for programming via RSM commands.
2. SSI number hex values are used for programming via SSI commands.



**Table 5-1** Symbology Parameter Defaults (continued)

Parameter	Parameter Number <sup>1</sup>	SSI Number <sup>2</sup>	Default	Page Number
<b>Macro PDF</b>				
Macro PDF Transmit/Decode Mode Symbols	188	BCh	Passthrough Mode	<a href="#">5-80</a>
Transmit Macro PDF Control Header	184	B8h	Enable	<a href="#">5-81</a>
Escape Characters	233	E9h	None	<a href="#">5-81</a>
Flush Macro PDF Buffer	N/A	N/A	N/A	<a href="#">5-82</a>
Abort Macro PDF Entry	N/A	N/A	N/A	<a href="#">5-82</a>
<b>Postal Codes</b>				
US Postnet	89	59h	Disable	<a href="#">5-82</a>
US Planet	90	5Ah	Disable	<a href="#">5-83</a>
Transmit US Postal Check Digit	95	5Fh	Enable	<a href="#">5-83</a>
UK Postal	91	5Bh	Disable	<a href="#">5-84</a>
Transmit UK Postal Check Digit	96	60h	Enable	<a href="#">5-84</a>
Japan Postal	290	F0h 22h	Disable	<a href="#">5-85</a>
Australia Post	291	F0h 23h	Disable	<a href="#">5-85</a>
Australia Post Format	718	F1h CEh	Autodiscriminate	<a href="#">5-86</a>
Netherlands KIX Code	326	F0h 46h	Disable	<a href="#">5-87</a>
USPS 4CB/One Code/Intelligent Mail	592	F1h 50h	Disable	<a href="#">5-87</a>
UPU FICS Postal	611	F1h 63h	Disable	<a href="#">5-88</a>

1. Parameter number decimal values are used for programming via RSM commands.
2. SSI number hex values are used for programming via SSI commands.

---

## Enable/Disable All Code Types

Scan the **Disable All Code Types** barcode to disable all symbologies. This is useful when enabling only a few code types.

Scan **Enable All Code Types** to enable all symbologies. This is useful if you need to disable only a few code types.



**Disable All Code Types**



**Enable All Code Types**

---

## UPC/EAN/JAN

### UPC-A

Parameter # 1

SSI # 01h

Scan one of the following barcodes to enable or disable UPC-A.

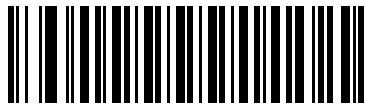

**\*Enable UPC-A  
(1)**

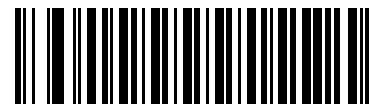

**Disable UPC-A  
(0)**

**UPC-E**

**Parameter # 2**

**SSI # 02h**

Scan one of the following barcodes to enable or disable UPC-E.



**\*Enable UPC-E  
(1)**



**Disable UPC-E  
(0)**

**UPC-E1**

**Parameter # 12**

**SSI # 0Ch**

Scan one of the following barcodes to enable or disable UPC-E1.

✓ **NOTE** UPC-E1 is not a UCC (Uniform Code Council) approved symbology.



**Enable UPC-E1  
(1)**

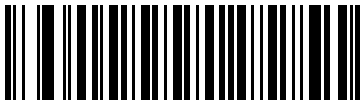

**\*Disable UPC-E1  
(0)**

## **EAN-8/JAN-8**

**Parameter # 4**

**SSI # 04h**

Scan one of the following barcodes to enable or disable EAN-8/JAN-8.

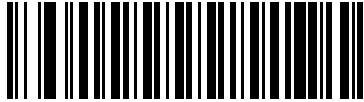

**\*Enable EAN-8/JAN-8  
(1)**

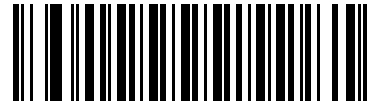

**Disable EAN-8/JAN-8  
(0)**

## **EAN-13/JAN-13**

**Parameter # 3**

**SSI # 03h**

Scan one of the following barcodes to enable or disable EAN-13/JAN-13.



**\*Enable EAN-13/JAN-13  
(1)**



**Disable EAN-13/JAN-13  
(0)**

## Bookland EAN

Parameter # 83

SSI # 53h

Scan one of the following barcodes to enable or disable Bookland EAN.

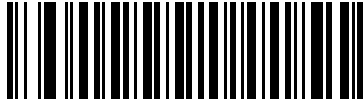

Enable Bookland EAN  
(1)



\*Disable Bookland EAN  
(0)



**NOTE** If you enable Bookland EAN, select a [Bookland ISBN Format](#). Also set [Decode UPC/EAN/JAN Supplementals on page 5-13](#) to either Decode UPC/EAN/JAN with Supplementals Only, Autodiscriminate UPC/EAN/JAN With Supplementals, or Enable 978/979 Supplemental Mode.

## Bookland ISBN Format

Parameter # 576

SSI # F1h 40h

If you enabled Bookland EAN using [Bookland EAN on page 5-11](#), select one of the following formats for Bookland data:

- **Bookland ISBN-10** - The scanner reports Bookland data starting with 978 in traditional 10-digit format with the special Bookland check digit for backward-compatibility. Data starting with 979 is not considered Bookland in this mode.
- **Bookland ISBN-13** - The scanner reports Bookland data (starting with either 978 or 979) as EAN-13 in 13-digit format to meet the 2007 ISBN-13 protocol.



\*Bookland ISBN-10  
(0)



Bookland ISBN-13  
(1)



**NOTE** For Bookland EAN to function properly, first enable Bookland EAN using [Bookland EAN on page 5-11](#), and then set [Decode UPC/EAN/JAN Supplementals on page 5-13](#) to either Decode UPC/EAN/JAN with Supplementals Only, Autodiscriminate UPC/EAN/JAN With Supplementals, or Enable 978/979 Supplemental Mode.

## ISSN EAN

Parameter # 617

SSI # F1h 69h

Scan one of the following barcodes to enable or disable ISSN EAN.



Enable ISSN EAN  
(1)



\*Disable ISSN EAN  
(0)

## Decode UPC/EAN/JAN Supplementals

Parameter # 16

SSI # 10h

Supplementals are barcodes appended according to specific format conventions (e.g., UPC A+2, UPC E+2, EAN 13+2). The following options are available:

- **Decode UPC/EAN/JAN with Supplementals Only** - The scanner only decodes UPC/EAN/JAN symbols with supplemental characters, and ignores symbols without supplementals.
- **Ignore UPC/EAN/JAN Supplementals** - When presented with a UPC/EAN/JAN plus supplemental symbol, the scanner decodes UPC/EAN/JAN and ignores the supplemental characters.
- **Autodiscriminate UPC/EAN/JAN with Supplementals** - The scanner decodes UPC/EAN/JAN symbols with supplemental characters immediately. If the symbol does not have a supplemental, the scanner must decode the barcode the number of times set via [UPC/EAN/JAN Supplemental Redundancy on page 5-17](#) before transmitting its data to confirm that there is no supplemental.

Select one of the following **Supplemental Mode** options to immediately transmit EAN-13 barcodes starting with that prefix that have supplemental characters. If the symbol does not have a supplemental, the scanner must decode the barcode the number of times set via [UPC/EAN/JAN Supplemental Redundancy on page 5-17](#) before transmitting the data to confirm that there is no supplemental. The scanner transmits UPC/EAN/JAN barcodes that do not have that prefix immediately.

- **Enable 378/379 Supplemental Mode**
- **Enable 978/979 Supplemental Mode**

✓ **NOTE** If you select 978/979 Supplemental Mode and are scanning Bookland EAN barcodes, see [Bookland EAN on page 5-11](#) to enable Bookland EAN, and select a format using [Bookland ISBN Format on page 5-12](#).

- **Enable 977 Supplemental Mode**
- **Enable 414/419/434/439 Supplemental Mode**

- **Enable 491 Supplemental Mode**
- **Enable Smart Supplemental Mode** - This applies to EAN-13 barcodes starting with any prefix listed previously.
- **Supplemental User-Programmable Type 1** - This applies to EAN-13 barcodes starting with a 3-digit user-defined prefix. Set this using [User-Programmable Supplementals on page 5-16](#).
- **Supplemental User-Programmable Type 1 and 2** - This applies to EAN-13 barcodes starting with either of two 3-digit user-defined prefixes. Set the prefixes using [User-Programmable Supplementals on page 5-16](#).
- **Smart Supplemental Plus User-Programmable 1** - This applies to EAN-13 barcodes starting with any prefix listed previously or the prefix set using [User-Programmable Supplementals on page 5-16](#).
- **Smart Supplemental Plus User-Programmable 1 and 2** - This applies to EAN-13 barcodes starting with any prefix listed previously or one of the two user-defined prefixes set using [User-Programmable Supplementals on page 5-16](#).

✓ **NOTE** To minimize the risk of invalid data transmission, select either to decode or ignore supplemental characters.

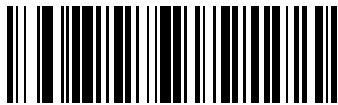

**Decode UPC/EAN/JAN With Supplementals Only  
(1)**



**\*Ignore UPC/EAN/JAN Supplementals  
(0)**



**Autodiscriminate UPC/EAN/JAN with Supplementals  
(2)**



**Enable 378/379 Supplemental Mode  
(4)**



### Decode UPC/EAN/JAN Supplementals (continued)



Enable 978/979 Supplemental Mode  
(5)



Enable 977 Supplemental Mode  
(7)



Enable 414/419/434/439 Supplemental Mode  
(6)



Enable 491 Supplemental Mode  
(8)



Enable Smart Supplemental Mode  
(3)



Supplemental User-Programmable Type 1  
(9)

## Decode UPC/EAN/JAN Supplementals (continued)



Supplemental User-Programmable Type 1 and 2  
(10)



Smart Supplemental Plus User-Programmable 1  
(11)



Smart Supplemental Plus User-Programmable 1 and  
2  
(12)

## User-Programmable Supplementals

**Supplemental 1: Parameter # 579**  
SSI # F4h F1h 43h

**Supplemental 2: Parameter # 580**  
SSI # F4h F1h 44h

If you selected a Supplemental User-Programmable option from [Decode UPC/EAN/JAN Supplementals on page 5-13](#), scan **User-Programmable Supplemental 1**, and then scan three barcodes from [Appendix C, Numeric Bar Codes](#) to set the 3-digit prefix. To set a second 3-digit prefix, scan **User-Programmable Supplemental 2**, and then scan three barcodes from [Appendix C, Numeric Bar Codes](#).



User-Programmable Supplemental 1



User-Programmable Supplemental 2

## UPC/EAN/JAN Supplemental Redundancy

### Parameter # 80

#### SSI # 50h

If you selected **Autodiscriminate UPC/EAN/JAN with Supplementals**, this option sets the number of times to decode a symbol without supplementals before transmission. The range is from two to 30. Five or above is recommended when decoding a mix of UPC/EAN/JAN symbols with and without supplementals. The default is 10.

To set a redundancy value, scan the following barcode, and then scan two barcodes from [Appendix C, Numeric Bar Codes](#). Enter a leading zero for single digit numbers. To correct an error or change a selection, scan [Appendix , Cancel](#).

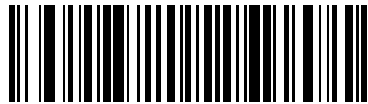

UPC/EAN/JAN Supplemental Redundancy

## UPC/EAN/JAN Supplemental AIM ID Format

### Parameter # 672

#### SSI # F1h A0h

If [Transmit Code ID Character on page 4-18](#) is set to **AIM Code ID Character**, scan one of the following barcodes to select an output format when reporting UPC/EAN/JAN barcodes with supplementals:

- **Separate** - Transmit UPC/EAN/JAN with supplementals with separate AIM IDs but one transmission, i.e.,  
]E<0 or 4><data>]E<1 or 2>[supplemental data]
- **Combined** – Transmit UPC/EAN/JAN with supplementals with one AIM ID and one transmission, i.e.,  
]E3<data+supplemental data>
- **Separate Transmissions** - Transmit UPC/EAN/JAN with supplementals with separate AIM IDs and separate transmissions, i.e.,  
]E<0 or 4><data>  
]E<1 or 2>[supplemental data]

## UPC/EAN/JAN Supplemental AIM ID Format



**Separate  
(0)**



**\*Combined  
(1)**



**Separate Transmissions  
(2)**

## Transmit UPC-A Check Digit

**Parameter # 40**

**SSI # 28h**

The check digit is the last character of the symbol used to verify the integrity of the data. Scan one of the following barcodes to transmit the barcode data with or without the UPC-A check digit. It is always verified to guarantee the integrity of the data.

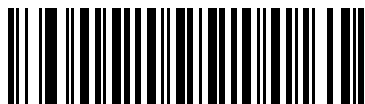

**\*Transmit UPC-A Check Digit  
(1)**

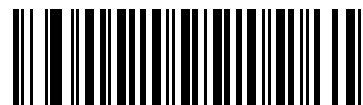

**Do Not Transmit UPC-A Check Digit  
(0)**

## Transmit UPC-E Check Digit

Parameter # 41

SSI # 29h

The check digit is the last character of the symbol used to verify the integrity of the data. Scan one of the following barcodes to transmit the barcode data with or without the UPC-E check digit. It is always verified to guarantee the integrity of the data.

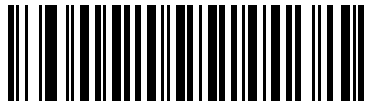

**\*Transmit UPC-E Check Digit  
(1)**



**Do Not Transmit UPC-E Check Digit  
(0)**

## Transmit UPC-E1 Check Digit

Parameter # 42

SSI # 2Ah

The check digit is the last character of the symbol used to verify the integrity of the data. Scan one of the following barcodes to transmit the barcode data with or without the UPC-E1 check digit. It is always verified to guarantee the integrity of the data.

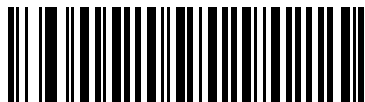

**\*Transmit UPC-E1 Check Digit  
(1)**

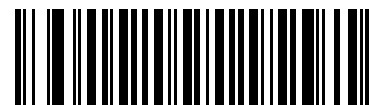

**Do Not Transmit UPC-E1 Check Digit  
(0)**

## UPC-A Preamble

### Parameter # 34

### SSI # 22h

Preamble characters are part of the UPC symbol, and include Country Code and System Character. Select the appropriate option for transmitting a UPC-A preamble to match the host system:

- Transmit System Character only
- Transmit System Character and Country Code ("0" for USA)
- Transmit no preamble.

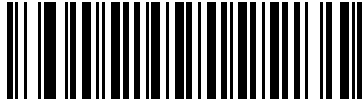

**No Preamble (<DATA>)**  
(0)

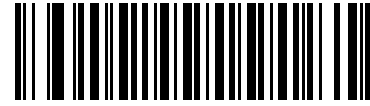

**\*System Character**  
**(<SYSTEM CHARACTER> <DATA>)**  
(1)

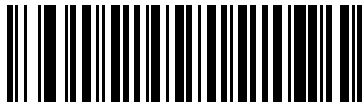

**System Character & Country Code**  
**(<COUNTRY CODE> <SYSTEM CHARACTER> <DATA>)**  
(2)

## UPC-E Preamble

### Parameter # 35

### SSI # 23h

Preamble characters are part of the UPC symbol, and include Country Code and System Character. Select the appropriate option for transmitting a UPC-E preamble to match the host system:

- Transmit System Character only
- Transmit System Character and Country Code ("0" for USA)
- Transmit no preamble.



**No Preamble (<DATA>)**  
(0)

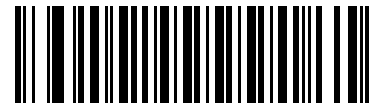

**\*System Character**  
**(<SYSTEM CHARACTER> <DATA>)**  
(1)

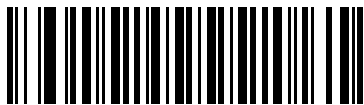

**System Character & Country Code**  
**(< COUNTRY CODE> <SYSTEM CHARACTER> <DATA>)**  
(2)

## UPC-E1 Preamble

### Parameter # 36

### SSI # 24h

Preamble characters are part of the UPC symbol, and include Country Code and System Character. Select the appropriate option for transmitting a UPC-E1 preamble to match the host system:

- Transmit System Character only
- Transmit System Character and Country Code ("0" for USA)
- Transmit no preamble.

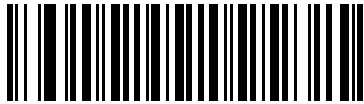

**No Preamble (<DATA>)**  
**(0)**

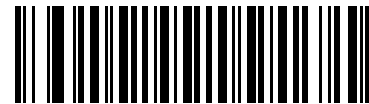

**\*System Character**  
**(<SYSTEM CHARACTER> <DATA>)**  
**(1)**

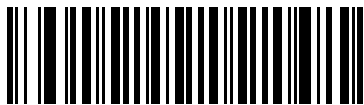

**System Character & Country Code**  
**(< COUNTRY CODE> <SYSTEM CHARACTER> <DATA>)**  
**(2)**



**Convert UPC-E to UPC-A**

**Parameter # 37**

**SSI # 25h**

Enable this to convert UPC-E (zero suppressed) decoded data to UPC-A format before transmission. After conversion, the data follows UPC-A format and is affected by UPC-A programming selections (e.g., Preamble, Check Digit).

Disable this to transmit UPC-E decoded data as UPC-E data, without conversion.

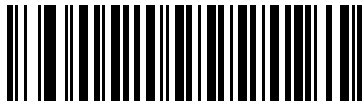

**Convert UPC-E to UPC-A (Enable)**  
**(1)**

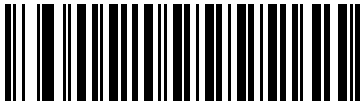

**\*Do Not Convert UPC-E to UPC-A (Disable)**  
**(0)**

**Convert UPC-E1 to UPC-A**

**Parameter # 38**

**SSI # 26h**

Scan **Convert UPC-E1 to UPC-A (Enable)** to convert UPC-E1 decoded data to UPC-A format before transmission. After conversion, the data follows UPC-A format and is affected by UPC-A programming selections (e.g., Preamble, Check Digit).

Scan **Do Not Convert UPC-E1 to UPC-A (Disable)** to transmit UPC-E1 decoded data as UPC-E1 data, without conversion.

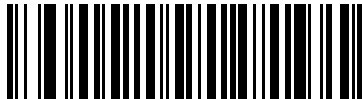

**Convert UPC-E1 to UPC-A (Enable)**  
**(1)**

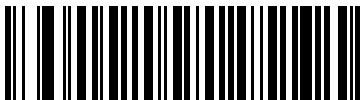

**\*Do Not Convert UPC-E1 to UPC-A (Disable)**  
**(0)**

## EAN/JAN Zero Extend

Parameter # 39

SSI # 27h

Scan **Enable EAN/JAN Zero Extend** to add five leading zeros to decoded EAN-8 symbols to make them compatible in length to EAN-13 symbols. Scan **Disable EAN/JAN Zero Extend** to transmit EAN-8 symbols as is.

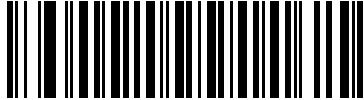

Enable EAN/JAN Zero Extend  
(1)

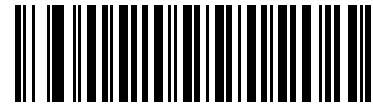

\*Disable EAN/JAN Zero Extend  
(0)

## UCC Coupon Extended Code

Parameter # 85

SSI # 55h

Scan **Enable UCC Coupon Extended Code** to decode UPC-A barcodes starting with digit '5', EAN-13 barcodes starting with digit '99', and UPC-A/GS1-128 coupon codes. UPC-A, EAN-13, and GS1-128 must be enabled to use this feature.

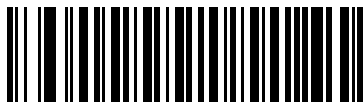

Enable UCC Coupon Extended Code  
(1)



\*Disable UCC Coupon Extended Code  
(0)



**NOTE** See [UPC/EAN/JAN Supplemental Redundancy on page 5-17](#) to control autodiscrimination of the GS1-128 portion (right half) of a coupon code.

## Coupon Report

Parameter # 730

SSI # F1h DAh

Scan one of the following barcodes to select the type of coupon format to support.

- **Old Coupon Format** - Support UPC-A/GS1-128 and EAN-13/GS1-128.
- **New Coupon Format** - An interim format to support UPC-A/GS1-DataBar and EAN-13/GS1-DataBar.
- **Autodiscriminate Format** - Support both **Old Coupon Format** and **New Coupon Format**.



**Old Coupon Format  
(0)**



**\*New Coupon Format  
(1)**



**Autodiscriminate Coupon Format  
(2)**

## Code 128

Parameter # 8

SSI # 08h

Scan one of the following barcodes to enable or disable Code 128.

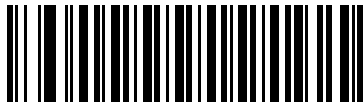

\*Enable Code 128  
(1)

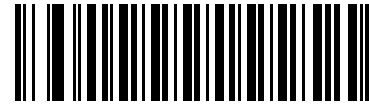

Disable Code 128  
(0)

### Set Lengths for Code 128

L1 = Parameter # 209

SSI # D1h

L2 = Parameter # 210

SSI # D2h

The length of a code refers to the number of characters (i.e., human readable characters), including check digit(s) the code contains. Set lengths for Code 128 to any length, one or two discrete lengths, or lengths within a specific range. The default is **Any Length**.



**NOTE** When setting lengths, enter a leading zero for single digit numbers.

Scan one of the following barcodes to select a length option:

- **One Discrete Length** - Decode only Code 128 symbols containing a selected length. Select the length using the barcodes in [Appendix C, Numeric Bar Codes](#). For example, to decode only Code 128 symbols with 14 characters, scan **Code 128 - One Discrete Length**, and then scan **1, 4**. To correct an error or change the selection, scan [Cancel on page C-2](#).
- **Two Discrete Lengths** - Decode only Code 128 symbols containing either of two lengths. Select lengths using the barcodes in [Appendix C, Numeric Bar Codes](#). For example, to decode only Code 128 symbols containing either 2 or 14 characters, scan **Code 128 - Two Discrete Lengths**, and then scan **0, 2, 1, 4**. To correct an error or change the selection, scan [Cancel on page C-2](#).
- **Length Within Range** - Decode Code 128 symbols with a specific length range. Select lengths using the barcodes in [Appendix C, Numeric Bar Codes](#). For example, to decode Code 128 symbols containing between 4 and 12 characters, scan **Code 128 - Length Within Range**, and then scan **0, 4, 1, 2**. To correct an error or change the selection, scan [Cancel on page C-2](#).
- **Any Length** - Decode Code 128 symbols containing any number of characters within the scanner's capability.

### Set Lengths for Code 128 (continued)

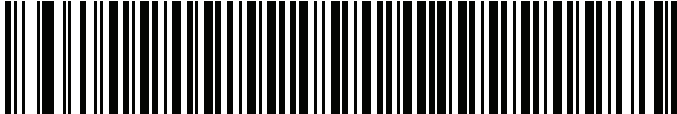

Code 128 - One Discrete Length

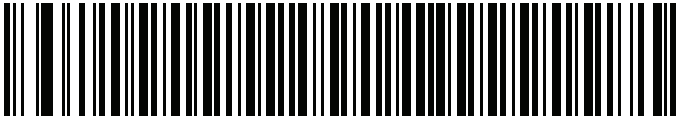

Code 128 - Two Discrete Lengths

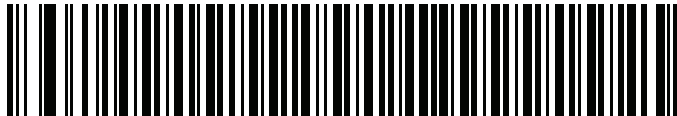

Code 128 - Length Within Range

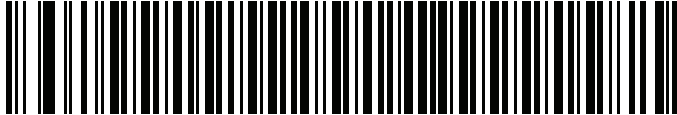

\*Code 128 - Any Length

### GS1-128 (formerly UCC/EAN-128)

Parameter # 14

SSI # 0Eh

Scan one of the following barcodes to enable or disable GS1-128.



Enable GS1-128  
(1)



\*Disable GS1-128  
(0)

## ISBT 128

Parameter # 84

SSI # 54h

ISBT 128 is a variant of Code 128 used in the blood bank industry. Scan one of the following barcodes to enable or disable ISBT 128.



Enable ISBT 128  
(1)



\*Disable ISBT 128  
(0)

## ISBT Concatenation

Parameter # 577

SSI # F1h 41h

Select an option for concatenating pairs of ISBT code types:

- **Enable ISBT Concatenation** - There must be two ISBT codes in order for the scanner to decode and perform concatenation. The scanner does not decode single ISBT symbols.
- **Disable ISBT Concatenation** - The scanner does not concatenate pairs of ISBT codes it encounters.
- **Autodiscriminate ISBT Concatenation** - The scanner decodes and concatenates pairs of ISBT codes immediately. If only a single ISBT symbol is present, the scanner must decode the symbol the number of times set via [ISBT Concatenation Redundancy on page 5-29](#) before transmitting its data to confirm that there is no additional ISBT symbol.



Enable ISBT Concatenation  
(1)

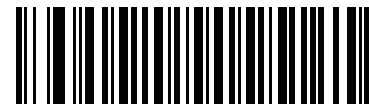

\*Disable ISBT Concatenation  
(0)

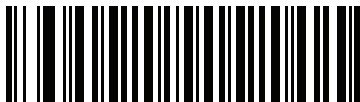

Autodiscriminate ISBT Concatenation  
(2)

## Check ISBT Table

Parameter # 578

SSI # F1h 42h

The ISBT specification includes a table that lists several types of ISBT barcodes that are commonly used in pairs. If you set **ISBT Concatenation** to **Enable**, enable **Check ISBT Table** to concatenate only those pairs found in this table. Other types of ISBT codes are not concatenated.



\*Enable Check ISBT Table  
(1)



Disable Check ISBT Table  
(0)

## ISBT Concatenation Redundancy

Parameter # 223

SSI # DFh

If you set *ISBT Concatenation on page 5-28* to **Autodiscriminate** (the default), use this parameter to set the number of times the scanner must decode an ISBT symbol before determining that there is no additional symbol.

Scan the following barcode, and then scan barcodes in *Appendix C, Numeric Bar Codes* to set a value between 2 and 20. Enter a leading zero for single digit numbers. To correct an error or change a selection, scan *Cancel on page C-2*. The default is 10.



ISBT Concatenation Redundancy

---

## Code 39

**Parameter # 0**

**SSI # 00h**

Scan one of the following barcodes to enable or disable Code 39.

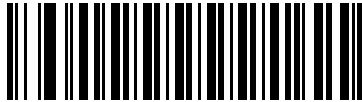

**Enable Code 39**  
(1)

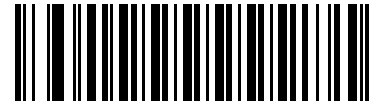

**\*Disable Code 39**  
(0)

## Trioptic Code 39

**Parameter # 13**

**SSI # 0Dh**

Trioptic Code 39 is a variant of Code 39 used in the marking of computer tape cartridges. Trioptic Code 39 symbols always contain six characters. Scan one of the following barcodes to enable or disable Trioptic Code 39.

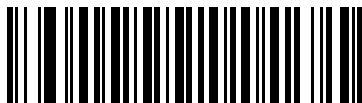

**Enable Trioptic Code 39**  
(1)



**\*Disable Trioptic Code 39**  
(0)



**NOTE** You cannot enable Trioptic Code 39 and Code 39 Full ASCII simultaneously.



## Convert Code 39 to Code 32

Parameter # 86

SSI # 56h

Code 32 is a variant of Code 39 used by the Italian pharmaceutical industry. Scan one of the following barcodes to enable or disable converting Code 39 to Code 32.



**NOTE** Code 39 must be enabled for this parameter to function.

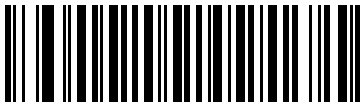

Enable Convert Code 39 to Code 32

(1)

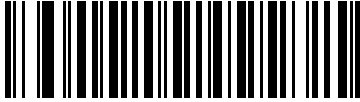

\*Disable Convert Code 39 to Code 32

(0)

## Code 32 Prefix

Parameter # 231

SSI # E7h

Scan one of the following barcodes to enable or disable adding the prefix character “A” to all Code 32 barcodes.



**NOTE** Convert Code 39 to Code 32 must be enabled for this parameter to function.

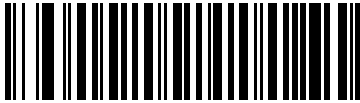

Enable Code 32 Prefix

(1)

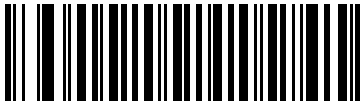

\*Disable Code 32 Prefix

(0)

## Set Lengths for Code 39

**L1 = Parameter # 18**  
**SSI # 12h**

**L2 = Parameter # 19**  
**SSI # 13h**

The length of a code refers to the number of characters (i.e., human readable characters), including check digit(s) the code contains. Set lengths for Code 39 to any length, one or two discrete lengths, or lengths within a specific range. If Code 39 Full ASCII is enabled, **Length Within Range** or **Any Length** are the preferred options. The default is **Length Within Range**: 2 to 55.

✓ **NOTE** When setting lengths, enter a leading zero for single digit numbers.

Scan one of the following barcodes to select a length option:

- **One Discrete Length** - Decode only Code 39 symbols containing a selected length. Select the length using the barcodes in [Appendix C, Numeric Bar Codes](#). For example, to decode only Code 39 symbols with 14 characters, scan **Code 39 - One Discrete Length**, and then scan **1, 4**. To correct an error or change the selection, scan [Cancel on page C-2](#).
- **Two Discrete Lengths** - Decode only Code 39 symbols containing either of two lengths. Select lengths using the barcodes in [Appendix C, Numeric Bar Codes](#). For example, to decode only Code 39 symbols containing either 2 or 14 characters, scan **Code 39 - Two Discrete Lengths**, and then scan **0, 2, 1, 4**. To correct an error or change the selection, scan [Cancel on page C-2](#).
- **Length Within Range** - Decode Code 39 symbols with a specific length range. Select lengths using the barcodes in [Appendix C, Numeric Bar Codes](#). For example, to decode Code 39 symbols containing between 4 and 12 characters, scan **Code 39 - Length Within Range**, and then scan **0, 4, 1, 2**. To correct an error or change the selection, scan [Cancel on page C-2](#).
- **Any Length** - Decode Code 39 symbols containing any number of characters within the scanner's capability.

## Set Lengths for Code 39 (continued)



Code 39 - One Discrete Length



Code 39 - Two Discrete Lengths



\*Code 39 - Length Within Range



Code 39 - Any Length

## Code 39 Check Digit Verification

Parameter # 48

SSI # 30h

Scan **Enable Code 39 Check Digit** to check the integrity of all Code 39 symbols to verify that the data complies with specified check digit algorithm. Only Code 39 symbols which include a modulo 43 check digit are decoded. Enable this feature if the Code 39 symbols contain a Modulo 43 check digit.

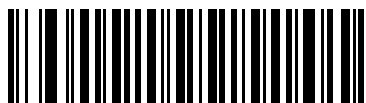

Enable Code 39 Check Digit  
(1)



\*Disable Code 39 Check Digit  
(0)

## Transmit Code 39 Check Digit

Parameter # 43

SSI # 2Bh

Scan one of the following barcodes to transmit Code 39 data with or without the check digit.

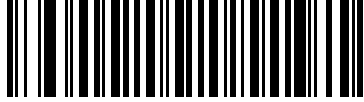

Transmit Code 39 Check Digit (Enable)  
(1)

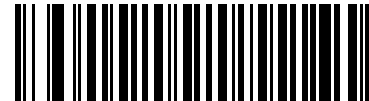

\*Do Not Transmit Code 39 Check Digit (Disable)  
(0)



**NOTE** *Code 39 Check Digit Verification* must be enabled for this parameter to function.

## Code 39 Full ASCII Conversion

Parameter # 17

SSI # 11h

Code 39 Full ASCII is a variant of Code 39 which pairs characters to encode the full ASCII character set. Scan one of the following barcodes to enable or disable Code 39 Full ASCII.

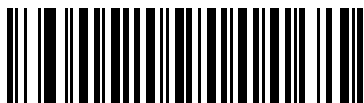

Enable Code 39 Full ASCII  
(1)



\*Disable Code 39 Full ASCII  
(0)



**NOTE** You cannot enable Trioptic Code 39 and Code 39 Full ASCII simultaneously.

Code 39 Full ASCII to Full ASCII Correlation is host-dependent, and is therefore described in the ASCII character set table for the appropriate interface. See [Table E-1 on page E-1](#).

## Code 39 Buffering - Scan & Store

### Parameter # 113

#### SSI # 71h

This feature allows the scanner to accumulate data from multiple Code 39 symbols.

Selecting the Scan and Store option (Buffer Code 39) temporarily buffers all Code 39 symbols having a leading space as a first character for later transmission. The leading space is not buffered.

Decoding a Code 39 symbol with no leading space transmits in sequence all buffered data in a first-in first-out format, plus the “triggering” symbol. See the following pages for further details.

Select **Do Not Buffer Code 39** to transmit all decoded Code 39 symbols immediately without storing them in the buffer.

This feature affects Code 39 only. If selecting **Buffer Code 39**, we recommend configuring the scanner to decode Code 39 symbology only.



Buffer Code 39 (Enable)  
(01h)

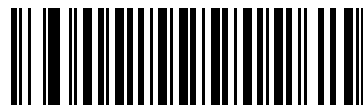

\*Do Not Buffer Code 39 (Disable)  
(00h)

While there is data in the transmission buffer, you cannot select **Do Not Buffer Code 39**. The buffer holds 200 bytes of information.

To disable Code 39 buffering when there is data in the transmission buffer, first force the buffer transmission (see [Transmit Buffer on page 5-36](#)) or clear the buffer.

### Buffer Data

To buffer data, enable Code 39 buffering and scan a Code 39 symbol with a space immediately following the start pattern.

- Unless the data overflows the transmission buffer, the scanner issues a low/high beep to indicate successful decode and buffering. (For overflow conditions, see [Overfilling Transmission Buffer on page 5-36](#).)
- The scanner adds the decoded data excluding the leading space to the transmission buffer.
- No transmission occurs.

### Clear Transmission Buffer

To clear the transmission buffer, scan the **Clear Buffer** barcode below, which contains only a start character, a dash (minus), and a stop character.

- The scanner issues a short high/low/high beep.
- The scanner erases the transmission buffer.
- No transmission occurs.

### Clear Transmission Buffer (continued)



**Clear Buffer**

- ✓ **NOTE** The Clear Buffer contains only the dash (minus) character. In order to scan this command, set Code 39 lengths to include length 1.

### Transmit Buffer

There are two methods to transmit the Code 39 buffer.

1. Scan the **Transmit Buffer** barcode below, which includes only a start character, a plus (+), and a stop character.
2. The scanner transmits and clears the buffer.
  - The scanner issues a low/high beep.



**Transmit Buffer**

3. Scan a Code 39 barcode with a leading character other than a space.
  - The scanner appends new decode data to buffered data.
  - The scanner transmits and clears the buffer.
  - The scanner signals that it transmitted the buffer with a low/high beep.
  - The scanner transmits and clears the buffer.

- ✓ **NOTE** The Transmit Buffer contains only a plus (+) character. In order to scan this command, set Code 39 lengths to include length 1.

### Overfilling Transmission Buffer

The Code 39 buffer holds 200 characters. If the symbol just read overflows the transmission buffer:

- The scanner indicates that it rejected the symbol by issuing three long, high beeps.
- No transmission occurs. The data in the buffer is not affected.

### Attempt to Transmit an Empty Buffer

If you scan the **Transmit Buffer** symbol and the Code 39 buffer is empty:

- A short low/high/low beep signals that the buffer is empty.
- No transmission occurs.
- The buffer remains empty.

## Code 93

Parameter # 9

SSI # 09h

Scan one of the following barcodes to enable or disable Code 93.

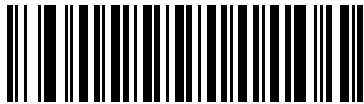

Enable Code 93  
(1)

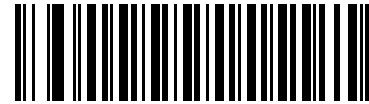

\*Disable Code 93  
(0)

### Set Lengths for Code 93

L1 = Parameter # 26

SSI # 1Ah

L2 = Parameter # 27

SSI # 1Bh

The length of a code refers to the number of characters (i.e., human readable characters), including check digit(s) the code contains. Set lengths for Code 93 to any length, one or two discrete lengths, or lengths within a specific range.

✓ **NOTE** When setting lengths, enter a leading zero for single digit numbers.

Scan one of the following barcodes to select a length option:

- **One Discrete Length** - Decode only Code 93 symbols containing a selected length. Select the length using the barcodes in [Appendix C, Numeric Bar Codes](#). For example, to decode only Code 93 symbols with 14 characters, scan **Code 93 - One Discrete Length**, and then scan **1, 4**. To correct an error or change the selection, scan [Cancel on page C-2](#).
- **Two Discrete Lengths** - Decode only Code 93 symbols containing either of two lengths. Select lengths using the barcodes in [Appendix C, Numeric Bar Codes](#). For example, to decode only Code 93 symbols containing either 2 or 14 characters, scan **Code 93 - Two Discrete Lengths**, and then scan **0, 2, 1, 4**. To correct an error or change the selection, scan [Cancel on page C-2](#).
- **Length Within Range** - Decode Code 93 symbols with a specific length range. Select lengths using the barcodes in [Appendix C, Numeric Bar Codes](#). For example, to decode Code 93 symbols containing between 4 and 12 characters, scan **Code 93 - Length Within Range**, and then scan **0, 4, 1, 2**. To correct an error or change the selection, scan [Cancel on page C-2](#).
- **Any Length** - Decode Code 93 symbols containing any number of characters within the scanner's capability.

### Set Lengths for Code 93 (continued)



**Code 93 - One Discrete Length**



**Code 93 - Two Discrete Lengths**



**\*Code 93 - Length Within Range**



**Code 93 - Any Length**



## Code 11

Parameter # 10

SSI # 0Ah

Scan one of the following barcodes to enable or disable Code 11

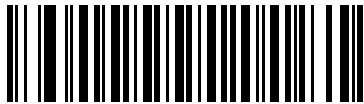

Enable Code 11  
(1)

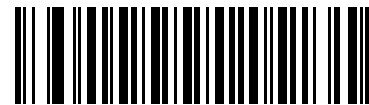

\*Disable Code 11  
(0)

### Set Lengths for Code 11

L1 = Parameter # 28

SSI # 1Ch

L2 = Parameter # 29

SSI # 1Dh

The length of a code refers to the number of characters (i.e., human readable characters), including check digit(s) the code contains. Set lengths for Code 11 to any length, one or two discrete lengths, or lengths within a specific range. The default is **Length Within Range: 4 to 55**.

✓ **NOTE** When setting lengths, enter a leading zero for single digit numbers.

Scan one of the following barcodes to select a length option:

- **One Discrete Length** - Decode only Code 11 symbols containing a selected length. Select the length using the barcodes in [Appendix C, Numeric Bar Codes](#). For example, to decode only Code 11 symbols with 14 characters, scan **Code 11 - One Discrete Length**, and then scan **1, 4**. To correct an error or change the selection, scan [Cancel on page C-2](#).
- **Two Discrete Lengths** - Decode only Code 11 symbols containing either of two lengths. Select lengths using the barcodes in [Appendix C, Numeric Bar Codes](#). For example, to decode only Code 11 symbols containing either 2 or 14 characters, scan **Code 11 - Two Discrete Lengths**, and then scan **0, 2, 1, 4**. To correct an error or change the selection, scan [Cancel on page C-2](#).
- **Length Within Range** - Decode Code 11 symbols with a specific length range. Select lengths using the barcodes in [Appendix C, Numeric Bar Codes](#). For example, to decode Code 11 symbols containing between 4 and 12 characters, scan **Code 11 - Length Within Range**, and then scan **0, 4, 1, 2**. To correct an error or change the selection, scan [Cancel on page C-2](#).
- **Any Length** - Decode Code 11 symbols containing any number of characters within the scanner's capability.

### Set Lengths for Code 11 (continued)



**Code 11 - One Discrete Length**



**Code 11 - Two Discrete Lengths**



**\*Code 11 - Length Within Range**



**Code 11 - Any Length**

## Code 11 Check Digit Verification

### Parameter # 52

### SSI # 34h

This feature allows the scanner to check the integrity of all Code 11 symbols to verify that the data complies with the specified check digit algorithm.

Scan one of the following barcodes to specify the number of check digits encoded in the Code 11 symbols, or to disable this feature.

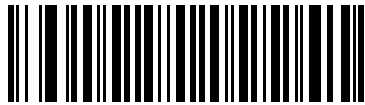

**\*Disable  
(0)**



**One Check Digit  
(1)**

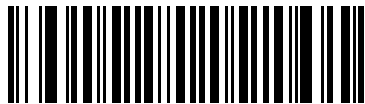

**Two Check Digits  
(2)**

## Transmit Code 11 Check Digits

Parameter # 47

SSI # 2Fh

Scan one of the following barcodes to select whether or not to transmit the Code 11 check digit(s).

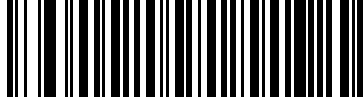

Transmit Code 11 Check Digit(s) (Enable)  
(1)

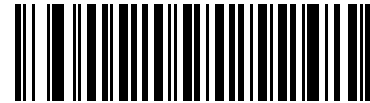

\*Do Not Transmit Code 11 Check Digit(s) (Disable)  
(0)



**NOTE** *Code 11 Check Digit Verification* must be enabled for this parameter to function.

---

## Interleaved 2 of 5 (ITF)

Parameter # 6

SSI # 06h

Scan one of the following barcodes to enable or disable Interleaved 2 of 5.

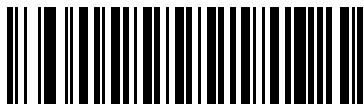

Enable Interleaved 2 of 5  
(1)



\*Disable Interleaved 2 of 5  
(0)

## Set Lengths for Interleaved 2 of 5

**L1 = Parameter # 22**  
**SSI # 16h**

**L2 = Parameter # 23**  
**SSI # 17h**

The length of a code refers to the number of characters (i.e., human readable characters), including check digit(s) the code contains. Set lengths for I 2 of 5 to any length, one or two discrete lengths, or lengths within a specific range. The default is **1 Length** (14).

✓ **NOTE** When setting lengths, enter a leading zero for single digit numbers.

Scan one of the following barcodes to select a length option:

- **One Discrete Length** - Decode only I 2 of 5 symbols containing a selected length. Select the length using the barcodes in [Appendix C, Numeric Bar Codes](#). For example, to decode only I 2 of 5 symbols with 14 characters, scan **I 2 of 5 - One Discrete Length**, and then scan **1, 4**. To correct an error or change the selection, scan [Cancel on page C-2](#).
- **Two Discrete Lengths** - Decode only I 2 of 5 symbols containing either of two lengths. Select lengths using the barcodes in [Appendix C, Numeric Bar Codes](#). For example, to decode only I 2 of 5 symbols containing either 2 or 14 characters, scan **I 2 of 5 - Two Discrete Lengths**, and then scan **0, 2, 1, 4**. To correct an error or change the selection, scan [Cancel on page C-2](#).
- **Length Within Range** - Decode I 2 of 5 symbols with a specific length range. Select lengths using the barcodes in [Appendix C, Numeric Bar Codes](#). For example, to decode I 2 of 5 symbols containing between 4 and 12 characters, scan **I 2 of 5 - Length Within Range**, and then scan **0, 4, 1, 2**. To correct an error or change the selection, scan [Cancel on page C-2](#).

## Set Lengths for Interleaved 2 of 5 (continued)

- **Any Length** - Decode I 2 of 5 symbols containing any number of characters within the scanner's capability.



**NOTE** Due to the construction of the I 2 of 5 symbology, it is possible for a scan line covering only a portion of the code to transmit as a complete scan, yielding less data than is encoded in the barcode. To prevent this, select specific lengths (I 2 of 5 - One Discrete Length, Two Discrete Lengths) for I 2 of 5 applications.



**\*I 2 of 5 - One Discrete Length**



**I 2 of 5 - Two Discrete Lengths**



**I 2 of 5 - Length Within Range**



**I 2 of 5 - Any Length**

## I 2 of 5 Check Digit Verification

**Parameter # 49**

**SSI # 31h**

Scan one of the following barcodes to check the integrity of all I 2 of 5 symbols to verify the data complies with either the specified Uniform Symbology Specification (USS), or the Optical Product Code Council (OPCC) check digit algorithm.



**\*Disable  
(0)**



**USS Check Digit  
(1)**



**OPCC Check Digit  
(2)**

## Transmit I 2 of 5 Check Digit

**Parameter # 44**

**SSI # 2Ch**

Scan one of the following barcodes to transmit I 2 of 5 data with or without the check digit.



**Transmit I 2 of 5 Check Digit (Enable)  
(1)**



**\*Do Not Transmit I 2 of 5 Check Digit (Disable)  
(0)**

## Convert I 2 of 5 to EAN-13

Parameter # 82

SSI # 52h

Scan **Convert I 2 of 5 to EAN-13 (Enable)** to convert 14-character I 2 of 5 codes to EAN-13, and transmit to the host as EAN-13. To accomplish this, the I 2 of 5 code must be enabled, and the code must have a leading zero and a valid EAN-13 check digit.

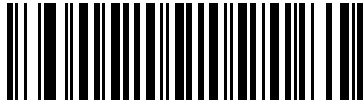

**Convert I 2 of 5 to EAN-13 (Enable)**  
(1)

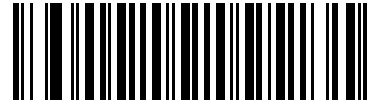

**\*Do Not Convert I 2 of 5 to EAN-13 (Disable)**  
(0)

---

## Discrete 2 of 5 (DTF)

Parameter # 5

SSI # 05h

Scan one of the following barcodes to enable or disable Discrete 2 of 5.

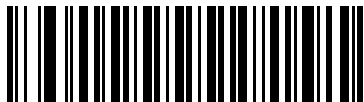

**Enable Discrete 2 of 5**  
(1)



**\*Disable Discrete 2 of 5**  
(0)



## Set Lengths for Discrete 2 of 5

**L1 = Parameter # 20**  
**SSI # 14h**

**L2 = Parameter # 21**  
**SSI # 15h**

The length of a code refers to the number of characters (i.e., human readable characters), including check digit(s) the code contains. Set lengths for D 2 of 5 to any length, one or two discrete lengths, or lengths within a specific range. The default is **1 Length** (12).

✓ **NOTE** When setting lengths, enter a leading zero for single digit numbers.

Scan one of the following barcodes to select a length option:

- **One Discrete Length** - Decode only D 2 of 5 symbols containing a selected length. Select the length using the barcodes in [Appendix C, Numeric Bar Codes](#). For example, to decode only D 2 of 5 symbols with 14 characters, scan **D 2 of 5 - One Discrete Length**, and then scan **1, 4**. To correct an error or change the selection, scan [Cancel on page C-2](#).
- **Two Discrete Lengths** - Decode only D 2 of 5 symbols containing either of two lengths. Select lengths using the barcodes in [Appendix C, Numeric Bar Codes](#). For example, to decode only D 2 of 5 symbols containing either 2 or 14 characters, scan **D 2 of 5 - Two Discrete Lengths**, and then scan **0, 2, 1, 4**. To correct an error or change the selection, scan [Cancel on page C-2](#).
- **Length Within Range** - Decode D 2 of 5 symbols with a specific length range. Select lengths using the barcodes in [Appendix C, Numeric Bar Codes](#). For example, to decode D 2 of 5 symbols containing between 4 and 12 characters, scan **D 2 of 5 - Length Within Range**, and then scan **0, 4, 1, 2**. To correct an error or change the selection, scan [Cancel on page C-2](#).
- **Any Length** - Decode D 2 of 5 symbols containing any number of characters within the scanner's capability.

✓ **NOTE** Due to the construction of the D 2 of 5 symbology, it is possible for a scan line covering only a portion of the code to transmit as a complete scan, yielding less data than is encoded in the barcode. To prevent this, select specific lengths (D 2 of 5 - One Discrete Length, Two Discrete Lengths) for D 2 of 5 applications.



\*D 2 of 5 - One Discrete Length



D 2 of 5 - Two Discrete Lengths

## Set Lengths for Discrete 2 of 5 (continued)



D 2 of 5 - Length Within Range



D 2 of 5 - Any Length

---

## Codabar (NW - 7)

Parameter # 7

SSI # 07h

Scan one of the following barcodes to enable or disable Codabar.

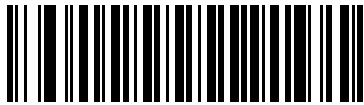

Enable Codabar  
(1)



\*Disable Codabar  
(0)

## Set Lengths for Codabar

**L1 = Parameter # 24**  
**SSI # 18h**

**L2 = Parameter # 25**  
**SSI # 19h**

The length of a code refers to the number of characters (i.e., human readable characters), including check digit(s) the code contains. Set lengths for Codabar to any length, one or two discrete lengths, or lengths within a specific range. The default is **Length Within Range: 5 to 55**.

✓ **NOTE** When setting lengths, enter a leading zero for single digit numbers.

Scan one of the following barcodes to select a length option:

- **One Discrete Length** - Decode only Codabar symbols containing a selected length. Select the length using the barcodes in [Appendix C, Numeric Bar Codes](#). For example, to decode only Codabar symbols with 14 characters, scan **Codabar - One Discrete Length**, and then scan **1, 4**. To correct an error or change the selection, scan [Cancel on page C-2](#).
- **Two Discrete Lengths** - Decode only Codabar symbols containing either of two lengths. Select lengths using the barcodes in [Appendix C, Numeric Bar Codes](#). For example, to decode only Codabar symbols containing either 2 or 14 characters, scan **Codabar - Two Discrete Lengths**, and then scan **0, 2, 1, 4**. To correct an error or change the selection, scan [Cancel on page C-2](#).
- **Length Within Range** - Decode Codabar symbols with a specific length range. Select lengths using the barcodes in [Appendix C, Numeric Bar Codes](#). For example, to decode Codabar symbols containing between 4 and 12 characters, scan **Codabar - Length Within Range**, and then scan **0, 4, 1, 2**. To correct an error or change the selection, scan [Cancel on page C-2](#).
- **Any Length** - Decode Codabar symbols containing any number of characters within the scanner's capability.

## Set Lengths for Codabar (continued)



**Codabar - One Discrete Length**

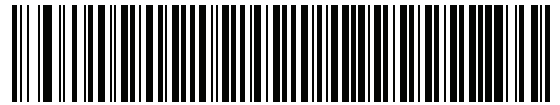

**Codabar - Two Discrete Lengths**



**\*Codabar - Length Within Range**



**Codabar - Any Length**

### CLSI Editing

Parameter # 54

SSI # 36h

Scan **Enable CLSI Editing** to strip the start and stop characters and insert a space after the first, fifth, and tenth characters of a 14-character Codabar symbol if the host system requires this data format.

✓ **NOTE** Symbol length does not include start and stop characters.

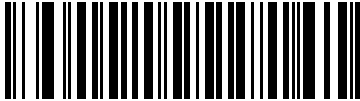

Enable CLSI Editing  
(1)

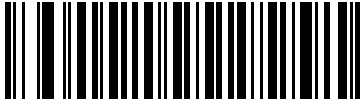

\*Disable CLSI Editing  
(0)

### NOTIS Editing

Parameter # 55

SSI # 37h

Scan **Enable NOTIS Editing** to strip the start and stop characters from a decoded Codabar symbol if the host system requires this data format.

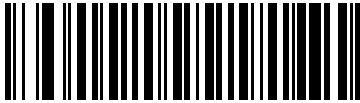

Enable NOTIS Editing  
(1)

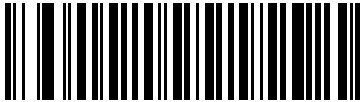

\*Disable NOTIS Editing  
(0)

## Codabar Upper or Lower Case Start/Stop Characters

Parameter # 855

SSI # F2h 57h

Scan one of the following barcodes to select whether to transmit upper case or lower case Codabar start/stop characters.



Lower Case  
(1)

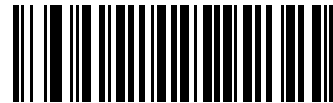

\*Upper Case  
(0)

---

## MSI

Parameter # 11

SSI # 0Bh

Scan one of the following barcodes to enable or disable MSI.

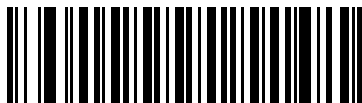

Enable MSI  
(1)



\*Disable MSI  
(0)

## Set Lengths for MSI

**L1 = Parameter # 30**  
**SSI # 1Eh**

**L2 = Parameter # 31**  
**SSI # 1Fh**

The length of a code refers to the number of characters (i.e., human readable characters), including check digit(s) the code contains. Set lengths for MSI to any length, one or two discrete lengths, or lengths within a specific range. The default is **Length Within Range: 4 to 55**.

✓ **NOTE** When setting lengths, enter a leading zero for single digit numbers.

Scan one of the following barcodes to select a length option:

- **One Discrete Length** - Decode only MSI symbols containing a selected length. Select the length using the barcodes in [Appendix C, Numeric Bar Codes](#). For example, to decode only MSI symbols with 14 characters, scan **MSI - One Discrete Length**, and then scan **1, 4**. To correct an error or change the selection, scan [Cancel on page C-2](#).
- **Two Discrete Lengths** - Decode only MSI symbols containing either of two lengths. Select lengths using the barcodes in [Appendix C, Numeric Bar Codes](#). For example, to decode only MSI symbols containing either 2 or 14 characters, scan **MSI - Two Discrete Lengths**, and then scan **0, 2, 1, 4**. To correct an error or change the selection, scan [Cancel on page C-2](#).
- **Length Within Range** - Decode MSI symbols with a specific length range. Select lengths using the barcodes in [Appendix C, Numeric Bar Codes](#). For example, to decode MSI symbols containing between 4 and 12 characters, scan **MSI - Length Within Range**, and then scan **0, 4, 1, 2**. To correct an error or change the selection, scan [Cancel on page C-2](#).
- **Any Length** - Decode MSI symbols containing any number of characters within the scanner's capability.

✓ **NOTE** Due to the construction of the MSI symbology, it is possible for a scan line covering only a portion of the code to transmit as a complete scan, yielding less data than is encoded in the barcode. To prevent this, select specific lengths (**MSI - One Discrete Length, Two Discrete Lengths**) for MSI applications.



**MSI - One Discrete Length**



**MSI - Two Discrete Lengths**

## Set Lengths for MSI (continued)



\*MSI - Length Within Range



MSI - Any Length

## MSI Check Digits

### Parameter # 50

#### SSI # 32h

With MSI symbols, one check digit is mandatory and always verified by the reader. The second check digit is optional. If the MSI codes include two check digits, scan the **Two MSI Check Digits** barcode to enable verification of the second check digit.

See [MSI Check Digit Algorithm on page 5-55](#) to select second digit algorithms.

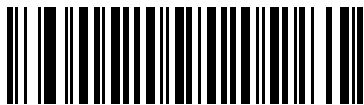

\*One MSI Check Digit  
(0)



Two MSI Check Digits  
(1)



### Transmit MSI Check Digit(s)

Parameter # 46

SSI # 2Eh

Scan one of the following barcodes to transmit MSI data with or without the check digit.

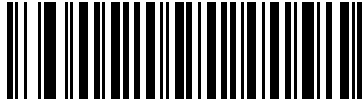

Transmit MSI Check Digit(s) (Enable)  
(1)

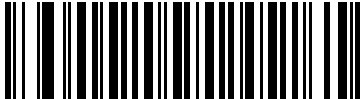

\*Do Not Transmit MSI Check Digit(s) (Disable)  
(0)

### MSI Check Digit Algorithm

Parameter # 51

SSI # 33h

Two algorithms are available for verifying the second MSI check digit. Scan one of the following barcodes to select the algorithm used to encode the check digit.

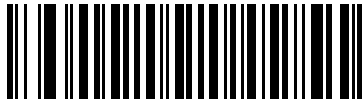

MOD 11/MOD 10  
(0)

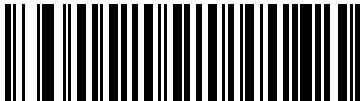

\*MOD 10/MOD 10  
(1)

---

## Chinese 2 of 5

**Parameter # 408**

**SSI # F0h 98h**

Scan one of the following barcodes to enable or disable Chinese 2 of 5.



**Enable Chinese 2 of 5  
(1)**

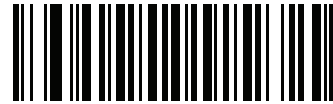

**\*Disable Chinese 2 of 5  
(0)**

---

## Matrix 2 of 5

**Parameter # 618**

**SSI # F1h 6Ah**

Scan one of the following barcodes to enable or disable Matrix 2 of 5.



**Enable Matrix 2 of 5  
(1)**



**\*Disable Matrix 2 of 5  
(0)**

## Matrix 2 of 5 (continued)

### Set Lengths for Matrix 2 of 5

**L1 = Parameter # 619**

**SSI # F1h 6Bh**

**L2 = Parameter # 620**

**SSI # F1h 6Ch**

The length of a code refers to the number of characters (i.e., human readable characters), including check digit(s) the code contains. Set lengths for Matrix 2 of 5 to any length, one or two discrete lengths, or lengths within a specific range. The default is **Any Length**.

✓ **NOTE** When setting lengths, enter a leading zero for single digit numbers.

Scan one of the following barcodes to select a length option:

- **One Discrete Length** - Decode only Matrix 2 of 5 symbols containing a selected length. Select the length using the barcodes in [Appendix C, Numeric Bar Codes](#). For example, to decode only Matrix 2 of 5 symbols with 14 characters, scan **Matrix 2 of 5 - One Discrete Length**, and then scan **1, 4**. To correct an error or change the selection, scan [Cancel on page C-2](#).
- **Two Discrete Lengths** - Decode only Matrix 2 of 5 symbols containing either of two lengths. Select lengths using the barcodes in [Appendix C, Numeric Bar Codes](#). For example, to decode only Matrix 2 of 5 symbols containing either 2 or 14 characters, scan **Matrix 2 of 5 - Two Discrete Lengths**, and then scan **0, 2, 1, 4**. To correct an error or change the selection, scan [Cancel on page C-2](#).
- **Length Within Range** - Decode Matrix 2 of 5 symbols with a specific length range. Select lengths using the barcodes in [Appendix C, Numeric Bar Codes](#). For example, to decode Matrix 2 of 5 symbols containing between 4 and 12 characters, scan **Matrix 2 of 5 - Length Within Range**, and then scan **0, 4, 1, 2**. To correct an error or change the selection, scan [Cancel on page C-2](#).
- **Any Length** - Decode Matrix 2 of 5 symbols containing any number of characters within the scanner's capability.



**Matrix 2 of 5 - One Discrete Length**

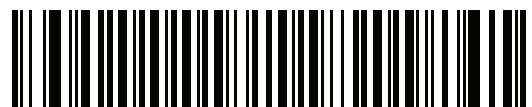

**Matrix 2 of 5 - Two Discrete Lengths**

## Set Lengths for Matrix 2 of 5 (continued)



**\*Matrix 2 of 5 - Length Within Range**



**\*Matrix 2 of 5 - Any Length**

## Matrix 2 of 5 Check Digit

**Parameter # 622**

**SSI # F1h 6Eh**

The check digit is the last character of the symbol used to verify the integrity of the data. Scan one of the following barcodes to determine whether to include the Matrix 2 of 5 check digit with the barcode data.



**Enable Matrix 2 of 5 Check Digit  
(1)**



**\*Disable Matrix 2 of 5 Check Digit  
(0)**

## Transmit Matrix 2 of 5 Check Digit

Parameter # 623

SSI # F1h 6Fh

Scan one of the following barcodes to transmit Matrix 2 of 5 data with or without the check digit.

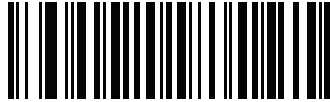

Transmit Matrix 2 of 5 Check Digit  
(1)



\*Do Not Transmit Matrix 2 of 5 Check Digit  
(0)

---

## Korean 3 of 5

Parameter # 581

SSI # F1h 45h

Scan one of the following barcodes to enable or disable Korean 3 of 5.

✓ **NOTE** The length for Korean 3 of 5 is fixed at 6.



Enable Korean 3 of 5  
(1)



\*Disable Korean 3 of 5  
(0)

---

## Inverse 1D

**Parameter # 586**

**SSI # F1h 4Ah**

Scan one of the following barcodes to set the 1D inverse decoder setting:

- **Regular Only** - The scanner decodes regular 1D barcodes only.
- **Inverse Only** - The scanner decodes inverse 1D barcodes only.
- **Inverse Autodetect** - The scanner decodes both regular and inverse 1D barcodes.



**\*Regular  
(0)**



**Inverse Only  
(1)**



**Inverse Autodetect  
(2)**

---

## GS1 DataBar

The variants of GS1 DataBar are DataBar Omnidirectional, DataBar Limited, and DataBar Expanded. The limited and expanded versions have stacked variants. Scan the appropriate barcodes to enable or disable each variant of GS1 DataBar.

### GS1 DataBar Omnidirectional (formerly GS1 DataBar-14), GS1 DataBar Truncated, GS1 DataBar Stacked, GS1 DataBar Stacked Omnidirectional

Parameter # 338

SSI # F0h 52h

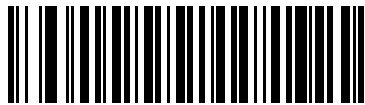

**\*Enable GS1 DataBar Omnidirectional  
(1)**



**Disable GS1 DataBar Omnidirectional  
(0)**

### GS1 DataBar Limited

Parameter # 339

SSI # F0h 53h

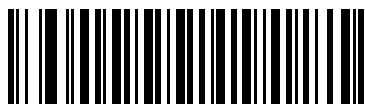

**Enable GS1 DataBar Limited  
(1)**



**\*Disable GS1 DataBar Limited  
(0)**

## GS1 DataBar Expanded, GS1 DataBar Expanded Stacked

Parameter # 340

SSI # F0h 54h

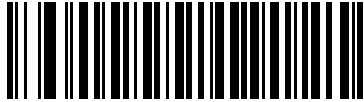

Enable GS1 DataBar Expanded  
(1)



\*Disable GS1 DataBar Expanded  
(0)

## Convert GS1 DataBar to UPC/EAN/JAN

Parameter # 397

SSI # F0h, 8Dh

This parameter only applies to GS1 DataBar Omnidirectional and GS1 DataBar Limited symbols not decoded as part of a Composite symbol. Scan **Enable Convert GS1 DataBar to UPC/EAN/JAN** to strip the leading '010' from DataBar Omnidirectional and DataBar Limited symbols encoding a single zero as the first digit, and report the barcode as EAN-13.

For barcodes beginning with between two and five zeros, this strips the leading '0100' and reports the barcode as UPC-A. The [UPC-A Preamble](#) option that transmits the system character and country code applies to converted barcodes. Note that neither the system character nor the check digit can be stripped.

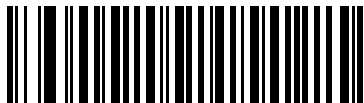

Enable Convert GS1 DataBar to UPC/EAN/JAN  
(1)



\*Disable Convert GS1 DataBar to UPC/EAN/JAN  
(0)



# GS1 DataBar Limited Margin Check

Parameter # 728

SSI # F1h D8h

The scanner offers four levels of decode security for GS1 DataBar Limited barcodes. There is an inverse relationship between the level of margin check and scanner aggressiveness. Increasing the level of margin check can reduce scanning aggressiveness, so select only the level of margin check necessary.

- **Margin Check Level 1** – No clear margin required. This complies with the original GS1 standard, yet can result in erroneous decoding of a DataBar Limited barcode when scanning some UPC symbols that start with digits 9 and 7.
- **Margin Check Level 2** – Automatic risk detection. This level of margin check can result in erroneous decoding of DataBar Limited barcodes when scanning some UPC symbols. If a misdecode is detected, the scanner operates in Level 3 or Level 1.
- **Margin Check Level 3** – Margin check level reflects the newly proposed GS1 standard that requires a five times trailing clear margin.
- **Margin Check Level 4** – Security level extends beyond the standard required by GS1. This level of margin check requires a five times leading and trailing clear margin.



GS1 DataBar Limited Margin Check Level 1 (1)



GS1 DataBar Limited Margin Check Level 2 (2)



\*GS1 DataBar Limited Margin Check Level 3 (3)



GS1 DataBar Limited Margin Check Level 4 (4)

---

## Symbology-Specific Security Features

### Redundancy Level

#### Parameter # 78

#### SSI # 4Eh

The scanner offers four levels of decode redundancy. Select higher redundancy levels for decreasing levels of barcode quality. As redundancy levels increase, the scanner's aggressiveness decreases.

Scan one of the following barcodes to select the redundancy level appropriate for the barcode quality:

- **Redundancy Level 1** - The scanner must read the following code types twice before decoding:
  - Codabar (8 characters or less)
  - MSI (4 characters or less)
  - D 2 of 5 (8 characters or less)
  - I 2 of 5 (8 characters or less)
- **Redundancy Level 2** - The scanner must read all code types twice before decoding.
- **Redundancy Level 3** - The scanner must read code types other than the following twice before decoding, but must read the following codes three times:
  - Codabar (8 characters or less)
  - MSI (4 characters or less)
  - D 2 of 5 (8 characters or less)
  - I 2 of 5 (8 characters or less)
- **Redundancy Level 4** - The scanner must read all code types three times before decoding.

Redundancy Level (continued)

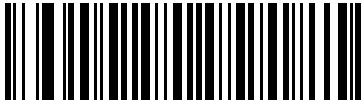

\*Redundancy Level 1  
(1)

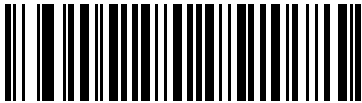

Redundancy Level 2  
(2)

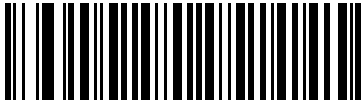

Redundancy Level 3  
(3)

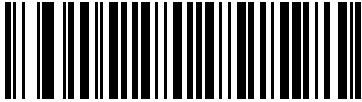

Redundancy Level 4  
(4)

## Security Level

### Parameter # 77

#### SSI # 4Dh

The scanner offers four levels of decode security for delta barcodes, which include the Code 128 family, UPC/EAN/JAN, and Code 93. Select increasing levels of security for decreasing levels of barcode quality. There is an inverse relationship between security and scanner aggressiveness, so choose only that level of security necessary for the application.

- **Security Level 0** - The scanner operates in its most aggressive state, while providing sufficient security decoding most in-spec barcodes.
- **Security Level 1** - This default setting eliminates most misdecodes.
- **Security Level 2** - Select this option if Security Level 1 fails to eliminate misdecodes.
- **Security Level 3** - If you selected Security Level 2 and misdecodes still occur, select this security level.

✓ **NOTE** Selecting this option is an extreme measure against mis-decoding severely out-of-spec barcodes, and significantly impairs the decoding ability of the scanner. If this level of security is required, try to improve the quality of the barcodes.

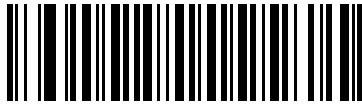

**Security Level 0  
(0)**

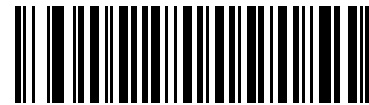

**\*Security Level 1  
(1)**

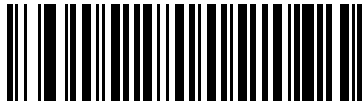

**Security Level 2  
(2)**

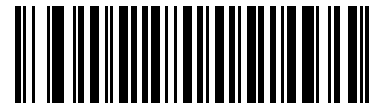

**Security Level 3  
(3)**

## Intercharacter Gap Size

Parameter # 381

SSI # F0h, 7Dh

The Code 39 and Codabar symbologies have an intercharacter gap that is typically quite small. Due to various barcode printing technologies, this gap can grow larger than the maximum size allowed, preventing the scanner from decoding the symbol. If this problem occurs, scan the **Large Intercharacter Gaps** parameter to tolerate these out-of-specification barcodes.



**\*Normal Intercharacter Gaps**  
(6)



**Large Intercharacter Gaps**  
(10)

---

## Composite

Composite CC-C

Parameter # 341

SSI # F0h 55h

Scan one of the following barcodes to enable or disable Composite barcodes of type CC-C.



**Enable CC-C**  
(1)



**\*Disable CC-C**  
(0)

## Composite CC-A/B

Parameter # 342

SSI # F0h 56h

Scan one of the following barcodes to enable or disable Composite barcodes of type CC-A/B.

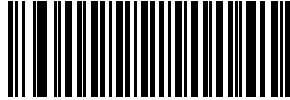

Enable CC-A/B  
(1)

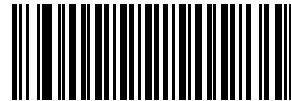

\*Disable CC-A/B  
(0)

## Composite TLC-39

Parameter # 371

SSI # F0h 73h

Scan one of the following barcodes to enable or disable Composite barcodes of type TLC-39.

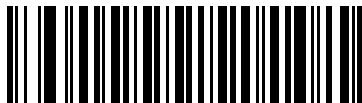

Enable TLC39  
(1)



\*Disable TLC39  
(0)

## UPC Composite Mode

Parameter # 344

SSI # F0h 58h

Select an option for linking UPC symbols with a 2D symbol during transmission as if they were one symbol:

- **UPC Never Linked** - Transmit UPC barcodes regardless of whether a 2D symbol is detected.
- **UPC Always Linked** - Transmit UPC barcodes and the 2D portion. If 2D is not present, do not transmit the barcode.
- **Autodiscriminate UPC Composites** - The scanner determines if there is a 2D portion, then transmits the UPC, as well as the 2D portion if present.

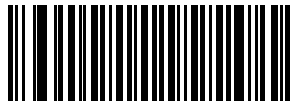

\*UPC Never Linked  
(0)



UPC Always Linked  
(1)



Autodiscriminate UPC Composites  
(2)

## Composite Beep Mode

Parameter # 398

SSI # F0h, 8Eh

Scan one of the following barcodes to select the number of decode beeps that sound upon decoding a Composite barcode.

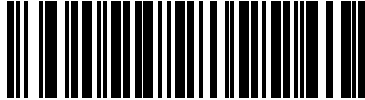

Single Beep After Both are Decoded  
(0)

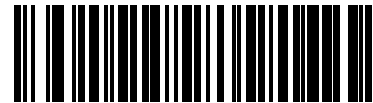

\*Beep as Each Code Type is Decoded  
(1)

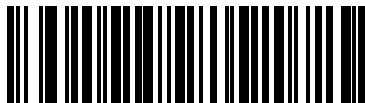

Double Beep After Both are Decoded  
(2)

## GS1-128 Emulation Mode for UCC/EAN Composite Codes

Parameter # 427

SSI # F0h, ABh

Scan one of the following barcodes to enable or disable this mode.



Enable GS1-128 Emulation Mode for  
UCC/EAN Composite Codes  
(1)



\*Disable GS1-128 Emulation Mode for  
UCC/EAN Composite Codes  
(0)



---

## 2D Symbologies

### PDF417

Parameter # 15

SSI # 0Fh

Scan one of the following barcodes to enable or disable PDF417.



Enable PDF417  
(1)



\*Disable PDF417  
(0)

### MicroPDF417

Parameter # 227

SSI # E3h

Scan one of the following barcodes to enable or disable MicroPDF417.



Enable MicroPDF417  
(1)



\*Disable MicroPDF417  
(0)

## Code 128 Emulation

### Parameter # 123

#### SSI # 7Bh

Enable this parameter to transmit data from certain MicroPDF417 symbols as Code 128. You must enable [AIM Code ID Character \(1\) on page 4-18](#) for this parameter to work.

Enable Code 128 Emulation to transmit these MicroPDF417 symbols with one of the following prefixes:

- ]C1 if the first codeword is 903-905
- ]C2 if the first codeword is 908 or 909
- ]C0 if the first codeword is 910 or 911

Disable Code 128 Emulation to transmit these MicroPDF417 symbols with one of the following prefixes:

- ]L3 if the first codeword is 903-905
- ]L4 if the first codeword is 908 or 909
- ]L5 if the first codeword is 910 or 911

Scan one of the following barcodes to enable or disable Code 128 Emulation.



**NOTE** Linked MicroPDF codewords 906, 907, 912, 914, and 915 are not supported. Use GS1 Composites instead.



**Enable Code 128 Emulation  
(1)**



**\*Disable Code 128 Emulation  
(0)**

## Data Matrix

Parameter # 292

SSI # F0h, 24h

Scan one of the following barcodes to enable or disable Data Matrix.



Enable Data Matrix  
(1)



\*Disable Data Matrix  
(0)

## Data Matrix Inverse

Parameter # 588

SSI # F1h 4Ch

Scan one of the following barcodes to select the Data Matrix inverse decoder setting:

- **Regular Only** - The scanner decodes regular Data Matrix barcodes only.
- **Inverse Only** - The scanner decodes inverse Data Matrix barcodes only.
- **Inverse Autodetect** - The scanner decodes both regular and inverse Data Matrix barcodes.



\*Regular Only  
(0)



Inverse Only  
(1)



Inverse Autodetect  
(2)

## Decode Data Matrix Mirror Images

Parameter # 537

SSI # F1h 19h

Scan one of the following barcodes to select an option for decoding mirror image Data Matrix barcodes:

- **Never** - Do not decode Data Matrix barcodes that are mirror images.
- **Always** - Decode only Data Matrix barcodes that are mirror images.
- **Auto** - Decode both mirrored and unmirrored Data Matrix barcodes.



**Never**  
**(0)**



**Always**  
**(1)**



**\* Auto**  
**(2)**

### Maxicode

Parameter # 294

SSI # F0h, 26h

Scan one of the following barcodes to enable or disable Maxicode.



Enable Maxicode  
(1)



\*Disable Maxicode  
(0)

### QR Code

Parameter # 293

SSI # F0h, 25h

Scan one of the following barcodes to enable or disable QR Code.

✓ **NOTE** Enabling this also enables [QR Inverse](#), QR Mirrored, and Linked QR.



Enable QR Code  
(1)



\*Disable QR Code  
(0)

## QR Inverse

Parameter # 587

SSI # F1h 4Bh

Scan one of the following barcodes to set the QR inverse decoder setting:

- **Regular Only** - The scanner decodes regular QR barcodes only.
- **Inverse Only** - The scanner decodes inverse QR barcodes only.
- **Inverse Autodetect** - The scanner decodes both regular and inverse QR barcodes.



**\*Regular Only**  
**(0)**



**Inverse Only**  
**(1)**



**Inverse Autodetect**  
**(2)**

**MicroQR**

**Parameter # 573**

**SSI # F1h 3Dh**

Scan one of the following barcodes to enable or disable MicroQR.



**Enable MicroQR  
(1)**



**\*Disable MicroQR  
(0)**

**Aztec**

**Parameter # 574**

**SSI # F1h 3Eh**

Scan one of the following barcodes to enable or disable Aztec.



**NOTE** Enabling this also enables Linked Aztec.



**Enable Aztec  
(1)**



**\*Disable Aztec  
(0)**

## Aztec Inverse

Parameter # 589

SSI # F1h 4Dh

Scan one of the following barcodes to select the Aztec inverse decoder setting:

- **Regular Only** - The scanner decodes regular Aztec barcodes only.
- **Inverse Only** - The scanner decodes inverse Aztec barcodes only.
- **Inverse Autodetect** - The scanner decodes both regular and inverse Aztec barcodes.



**Regular Only**  
(0)



**Inverse Only**  
(1)



**\*Inverse Autodetect**  
(2)



## Macro PDF Features

Macro PDF is a special feature for concatenating multiple PDF symbols into one file. The scanner can decode symbols encoded with this feature, and can store more than 64 Kb of decoded data from up to 50 MacroPDF symbols.



**CAUTION** When printing, keep each Macro PDF sequence separate, as each sequence has unique identifiers. Do not mix barcodes from several Macro PDF sequences, even if they encode the same data. When scanning a Macro PDF sequence, scan the entire sequence without interruption. When scanning a mixed sequence, two long low beeps (low / low) indicate an inconsistent file ID or inconsistent symbology error.

## Macro PDF User Indications

In this mode the scanner provides the following feedback.

**Table 5-2** Macro PDF User Indications

User Scans	Passthrough All Symbols		Transmit Any Symbol in Set		Buffer All Symbols	
	Beep	T	Beep	T	Beep	T
Last Macro PDF in set	Decode beep	Y	Decode beep	Y	Decode beep	Y
Any Macro PDF in set except last	Decode beep	Y	Decode beep	Y	2 short low	N
Macro PDF is not in current set	Decode beep	Y	2 long low	N	2 long low	N
Invalid Macro PDF formatting	Decode beep	Y	2 long low	N	2 long low	N
Macro PDF from set was already scanned	Decode beep	Y	4 long low	N	4 long low	N
Out of Macro PDF memory	N/A		3 long low	N	3 long low	N
A non-Macro PDF scanned during a set	N/A	-	4 long low	N	4 long low	N
Flush Macro PDF	Low high	N	5 long low	N	5 long low	Y
Abort Macro PDF	High low high low	N	High low high low	N	High low high low	N

**Notes:**

1. The beep only sounds if the \*BEEPER\_ON signal is connected.
2. The T columns indicate whether the symbol transmitted to the host (N = No transmission).

## Macro PDF Transmit / Decode Mode Symbols

### Parameter # 188

#### SSI # BCh

Scan one of the following barcodes to select an option for managing Macro PDF decoding. In **Buffer All Symbols** the scanner can manage sets of up to 50 maximum-sized Macro PDF symbols. In all other modes there is no limit to the size of the MacroPDF set.

- **Buffer All Symbols / Transmit Macro PDF When Complete** - Transmit all decode data from a Macro PDF sequence only when the entire sequence is scanned and decoded. Use the beeper and LED signals provided with the decoder when using this mode to ensure proper feedback. If the decode data exceeds the limit of 50 symbols, there is no transmission because the entire sequence was not scanned. Use the parameter [Flush Macro Buffer on page 5-82](#) to purge the buffer.
- **Transmit Any Symbol in Set / No Particular Order** - Transmit data from each Macro PDF symbol as decoded, regardless of the sequence (although some error handling is performed; see [Table 5-2](#)). When selecting this mode, enable [Transmit Macro PDF Control Header on page 5-81](#). Also use the beeper and LED signals provided with the decoder to ensure proper feedback.
- **Passthrough All Symbols** - Transmit and decode all Macro PDF symbols and perform no processing. In this mode the host is responsible for detecting and parsing the Macro PDF sequences.

Use this mode when the scanner's BEEPER\_ON signal is not used to drive a beeper. In the other modes, some Macro PDF scanning sequences provide audible feedback only, so if BEEPER\_ON is not used no user feedback is provided. In [Table 5-2](#), all actions marked **No Transmission** provide no feedback unless the BEEPER\_ON signal is used. By using **Passthrough All Symbols** mode every user decode is transmitted to the host where the host software can provide the appropriate feedback.



**Buffer All Symbols /  
Transmit Macro PDF When Complete**  
(0)



**Transmit Any Symbol in Set / No Particular Order**  
(1)



**\*Passthrough All Symbols**  
(4)

### Transmit Macro PDF Control Header

Parameter # 184

SSI # B8h

Enable this to transmit the control header, which contains the segment index and the file ID, in Macro PDF symbols. For example, the field may be: \92800000\725\120\343. The five digits after the \928 are the segment index (or block index), and \725\120\343 is the file ID.

Enable this when selecting **Transmit Any Symbol in Set / No Particular Order** for the *Macro PDF Transmit / Decode Mode Symbols on page 5-80*, and disable this when selecting **Buffer All Symbols / Transmit Macro PDF When Complete**. This parameter has no effect when **Passthrough All Symbols** is selected.



\*Enable Macro PDF Control Header Transmit  
(1)



Disable Macro PDF Control Header Transmit  
(0)

### Escape Characters

Parameter # 233

SSI # E9h

This enables the backslash (\) character as an Escape character for systems that can process transmissions containing special data sequences. Scan one of the following barcodes to either format special data according to the GLI (Global Label Identifier) protocol, or to disable this parameter. This parameter only affects the data portion of a Macro PDF symbol transmission; the Macro PDF Control Header (if enabled) is always sent with GLI formatting.



GLI Protocol  
(2)



\*None  
(0)

## Flush Macro Buffer

Scan the following barcode to flush the buffer of all decoded Macro PDF data stored to that point, transmit it to the host device, and abort from Macro PDF mode.



**Flush Macro PDF Buffer**

## Abort Macro PDF Entry

Scan the following barcode to clear all currently-stored Macro PDF data in the buffer without transmission and abort from Macro PDF mode.



**Abort Macro PDF Entry**

---

## Postal Codes

### US Postnet

Parameter # 89

SSI # 59h

Scan one of the following barcodes to enable or disable US Postnet.



**Enable US Postnet  
(1)**



**\*Disable US Postnet  
(0)**

**US Planet**

**Parameter # 90**

**SSI # 5Ah**

Scan one of the following barcodes to enable or disable US Planet.



**Enable US Planet  
(1)**

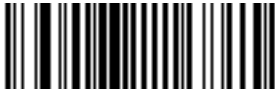

**\*Disable US Planet  
(0)**

**Transmit US Postal Check Digit**

**Parameter # 95**

**SSI # 5Fh**

Scan one of the following barcodes to select whether to transmit US Postal data, which includes both US Postnet and US Planet, with or without the check digit.

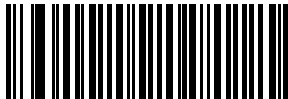

**\*Transmit US Postal Check Digit  
(1)**

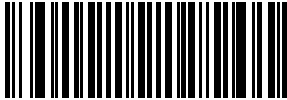

**Do Not Transmit US Postal Check Digit  
(0)**

## UK Postal

Parameter # 91

SSI # 5Bh

Scan one of the following barcodes to enable or disable UK Postal.



Enable UK Postal  
(1)



\*Disable UK Postal  
(0)

## Transmit UK Postal Check Digit

Parameter # 96

SSI # 60h

Scan one of the following barcodes to select whether to transmit UK Postal data with or without the check digit.



\*Transmit UK Postal  
Check Digit  
(1)



Do Not Transmit UK Postal Check Digit  
(0)

### Japan Postal

Parameter # 290

SSI # F0h, 22h

Scan one of the following barcodes to enable or disable Japan Postal.



Enable Japan Postal  
(1)



\*Disable Japan Postal  
(0)

### Australia Post

Parameter # 291

SSI # F0h, 23h

Scan one of the following barcodes to enable or disable Australia Post.



Enable Australia Post  
(1)



\*Disable Australia Post  
(0)

## Australia Post Format

### Parameter # 718

### SSI # F1h, CEh

Scan one of the following barcodes to select a format for Australia Post:

- **Autodiscriminate** (or Smart mode) - Decode the Customer Information Field using the N and C Encoding Tables.
- ✓ **NOTE** This option increases the risk of misdecodes because the encoded data format does not specify the Encoding Table used for encoding.
- **Raw Format** - Output raw bar patterns as a series of numbers 0 through 3.
- **Alphanumeric Encoding** - Decode the Customer Information Field using the C Encoding Table.
- **Numeric Encoding** - Decode the Customer Information Field using the N Encoding Table.

For more information on Australia Post Encoding Tables, refer to the *Australia Post Customer Barcoding Technical Specifications* available at [www.auspost.com.au](http://www.auspost.com.au).



\*Autodiscriminate  
(0)



Raw Format  
(1)



Alphanumeric Encoding  
(2)



Numeric Encoding  
(3)



**Netherlands KIX Code**

**Parameter # 326**

**SSI # F0h, 46h**

Scan one of the following barcodes to enable or disable Netherlands KIX Code.



**Enable Netherlands KIX Code  
(1)**



**\*Disable Netherlands KIX Code  
(0)**

**USPS 4CB/One Code/Intelligent Mail**

**Parameter # 592**

**SSI # F1h 50h**

Scan one of the following barcodes to enable or disable USPS 4CB/One Code/Intelligent Mail.



**Enable USPS 4CB/One Code/Intelligent Mail  
(1)**



**\*Disable USPS 4CB/One Code/Intelligent Mail  
(0)**

## UPU FICS Postal

Parameter # 611

SSI # F1h 63h

Scan one of the following barcodes to enable or disable UPU FICS Postal.



**Enable UPU FICS Postal  
(1)**

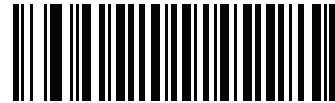

**\*Disable UPU FICS Postal  
(0)**

# CHAPTER 6 123SCAN AND SOFTWARE TOOLS

---

## Introduction

This chapter briefly describes the Zebra software tools available for customizing scanner operation.

---

## 123Scan

123Scan is a software tool that simplifies scanner setup and more.

Intuitive enough for first time users, the 123Scan wizard guides users through a streamlined setup process. Settings are saved in a configuration file that can be printed as a single programming barcode for scanning, emailed to a smart phone for scanning from its screen, or downloaded to the scanner using a USB cable.

Through 123Scan a user can accomplish the following.

- Configure a scanner using a wizard.
  - Program the following scanner settings:
    - Beeper tone / volume settings.
    - Enable / disable symbologies.
    - Communication settings.
  - Modify data before transmission to a host using:
    - Advanced Data Formatting (ADF) - Scan one barcode per trigger pull.
  - Load parameter settings to a scanner via:
    - Bar code scanning.
      - Scan a paper barcode.
      - Scan a barcode from a PC screen.
      - Scan a barcode from a smart phone screen.
  - Download over a USB cable:
    - Load settings to one scanner.
    - Stage up to 10 scanners simultaneously (Powered USB Hub recommended with 0.5 amp / port).

- Validate scanner setup:
  - View scanned data within the utility's Data View screen.
  - Capture an image and save to a PC within the utility's Data View screen.
  - Review settings using the Parameter Report.
  - Clone settings from an already deployed scanner from the start screen.
- Upgrade scanner firmware:
  - Load settings to one scanner.
  - Stage up to 10 scanners simultaneously (Powered USB Hub recommended with 0.5 amp / port).
- View statistics such as:
  - Asset tracking information.
  - Time and usage information.
  - Bar codes scanned by symbology.
  - Battery diagnostics (select scanners).
- Generate the following reports:
  - Barcode Report - Programming barcode, included parameter settings, and supported scanner models.
  - Parameter Report - Lists parameters programmed within a configuration file.
  - Inventory Report - Lists scanner asset tracking information.
  - Validation Report - Printout of scanned data from the Data view.
  - Statistics Report - Lists all statistics retrieved from the scanner.

For more information go to: [www.zebra.com/123Scan](http://www.zebra.com/123Scan).

### Communication with 123Scan

Use a USB cable to connect the scanner to a Windows host computer running 123Scan.

### 123Scan Requirements

- Host computer running Windows XP, 7, 8 and 10
- Scanner
- USB cable

### 123Scan Information

For more information on 123Scan, go to: [www.zebra.com/123Scan](http://www.zebra.com/123Scan).

For a 1 minute tour of 123Scan, go to: [www.zebra.com/ScannerHowToVideos](http://www.zebra.com/ScannerHowToVideos).

To see a list of all of our free software tools, go to: [www.zebra.com/scannersoftware](http://www.zebra.com/scannersoftware).

## Scanner SDK, Other Software Tools, and Videos

Tackle all your scanner programming needs with our diversified set of software tools. Whether you need to simply stage a device, or develop a fully featured application with image and data capture as well as asset management, these tools help you every step of the way.

To download any of the following free tools, go to: [www.zebra.com/scannersoftware](http://www.zebra.com/scannersoftware).

- 123Scan configuration utility
- SDKs
  - Scanner SDK for Windows
  - Scanner SDK for Linux
  - Scanner SDK for Android
  - Scanner SDK for iOS
- Drivers
  - OPOS driver
  - JPOS driver
  - USB CDC driver
  - TWAIN driver
- Scanner Management Service (SMS) for Remote Management
  - Windows
  - Linux
- How-To-Videos

## Scanner Control App

The Scanner Control App (SCA) allows you to control a Bluetooth scanner from a phone or tablet without a cradle. Use this app to showcase a Zebra Bluetooth scanner's capabilities and ease of control right from your phone.

The Scanner Control App supports Scan-To-Connect technology for one-step Bluetooth pairing, and allows you to control the following scanner functions:

- Program the beeper and LEDs
- Enable and disable symbologies
- Remotely trigger a scan

The app displays scanned barcode data, and can query scanner asset information and battery health statistics.

The Scanner Control App also works with USB connected scanners like the MP7000, assuming your Android tablet has a powered USB host port.

The Scanner Control app is available on the Android Play, iOS App, and Zebra AppGallery stores. Source code is available within the Zebra Scanner SDK for Android and iOS.

To watch a 1 minute tour of the Scanner Control App, go to: [www.zebra.com/scannercontrolapp](http://www.zebra.com/scannercontrolapp).

---

## Advanced Data Formatting (ADF)

Advanced Data Formatting (ADF) is a means of customizing data from before transmission to the host device. Use ADF to edit scan data to suit your host application requirements. With ADF you scan one barcode per trigger pull. ADF is programmed using 123Scan.

To watch a video on Creating an Advanced Data Formatting (ADF) Rule using 123Scan, go to:  
[www.zebra.com/ScannerHowToVideos](http://www.zebra.com/ScannerHowToVideos).

For additional information, refer to the Advanced Data Formatting Programmer Guide, p/n 72E-69680-xx.

# CHAPTER 7 INSTALLING THE MX101 CUSTOMER SIDE SCANNER

## Introduction

This chapter provides instructions to install the MX101 Customer Side Scanner (CSS) into the MP7000 Scanner Scale.

The MX101 optional modular unit replaces the MP70XX tower cover. The modular unit is pre-assembled to install the scanner on the left side of the MP7000 Scanner Scale. The scanner can be repositioned for right side installation.

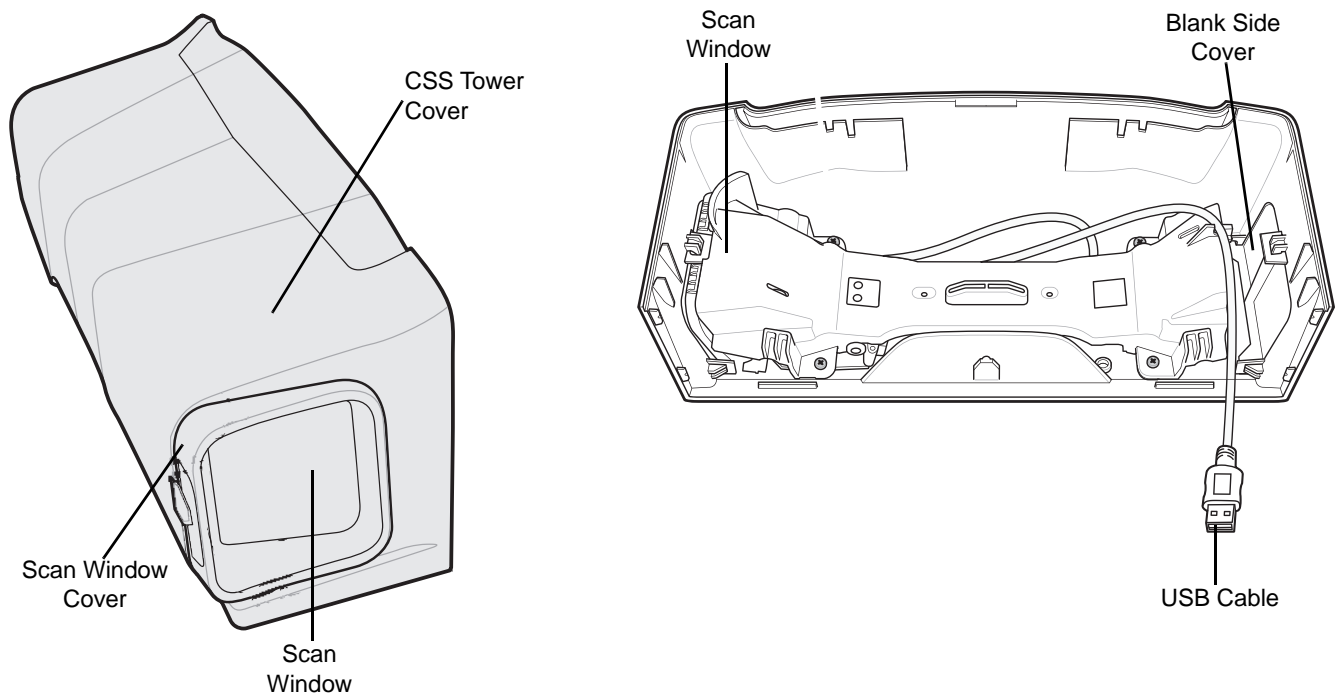
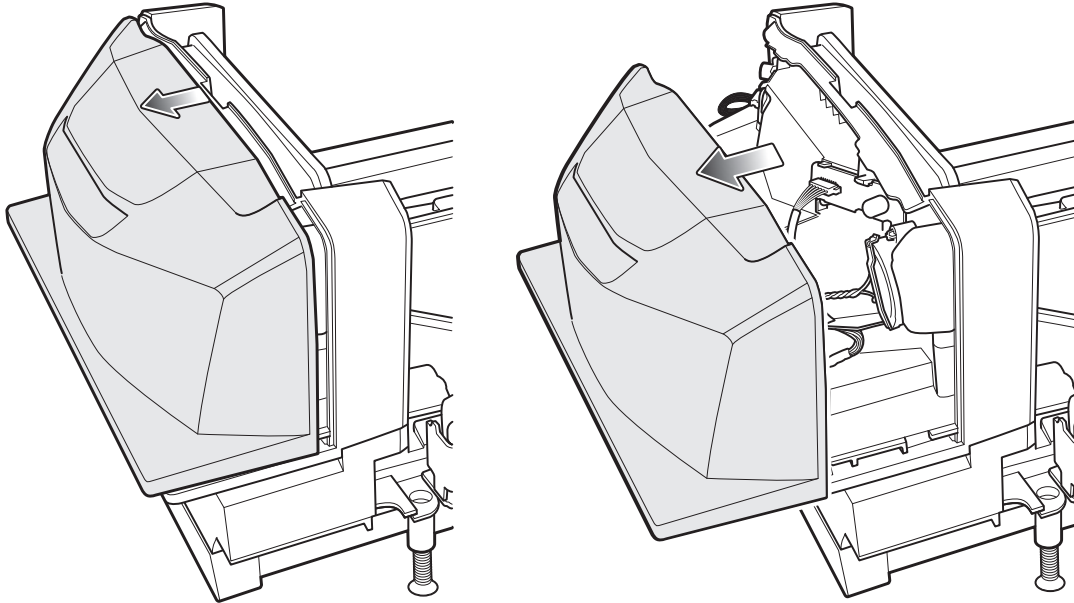

**Figure 7-1** MX101 Modular Unit Parts

## Installing the MX101 on the MP70XX

To install the MX101 on the customer's left side (default) of an MP70XX without a CSS module:

1. Lift the MP70XX out of the checkstand, if already installed.
2. Remove the tower cover by lifting the center of the cover with your thumb to disengage from the tower housing, and pulling the cover back.



**Figure 7-2** Removing the MP70XX Tower Cover

3. Before replacing the tower cover with the MX101 tower cover kit, route the cable into the side cable slots as shown in [Figure 7-3](#) and connect the USB cable to the top USB port (recommended) on the MP70XX.

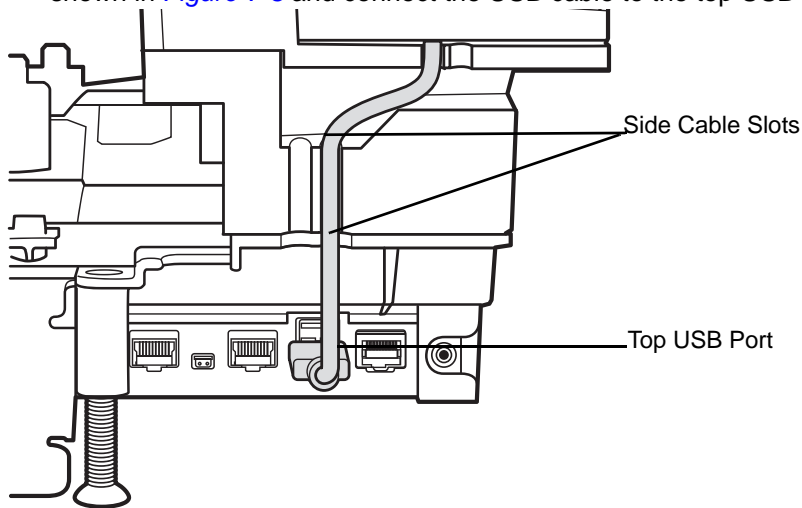

**Figure 7-3** Connecting the Cable



4. Replace the tower cover with the MX101 tower cover kit by sliding it onto the back housing and clicking it into place.

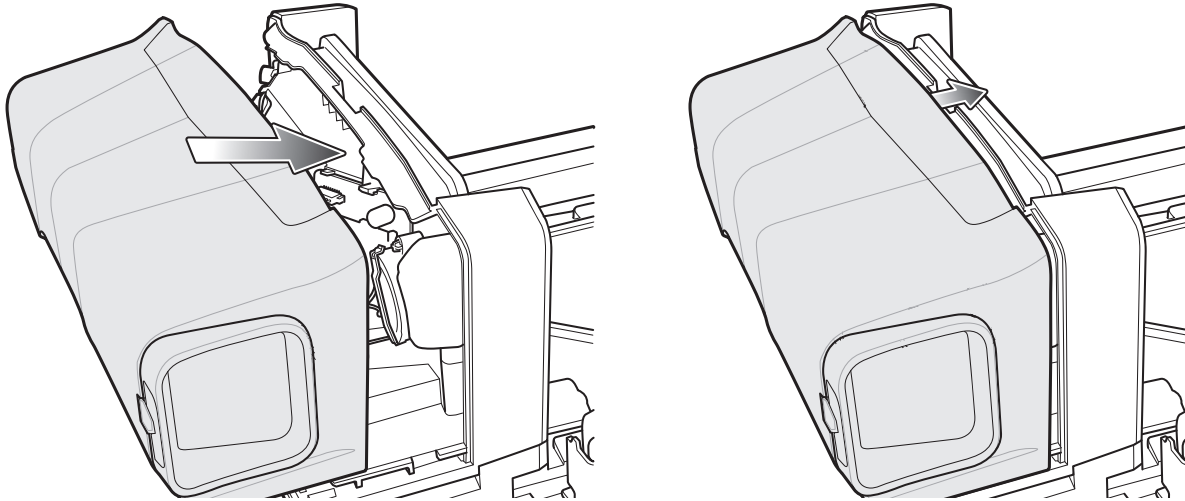

Figure 7-4 Replacing the MP70XX Tower Cover with MX101

## Installing the MX101 on the Customer's Right Side of the Tower Cover

- ✓ **NOTE** The following steps to reposition the CSS from left to right side apply to an MX101 unit already integrated into the MP70XX and to a new MX101 kit to be installed for customer right side use.



**IMPORTANT** When handling the scan window, do not scratch or smudge the window.

To reposition the MX101 to the customer's right side of the MP70XX:

1. Lift the MP70XX out of the checkstand, if already installed.
2. Remove the tower cover, if already installed, by lifting the center of the cover with your thumb to disengage from the tower housing, and pulling the cover back (see [Figure 7-2 on page 7-2](#)).

3. Remove the screws attaching the bracket to the tower cover.

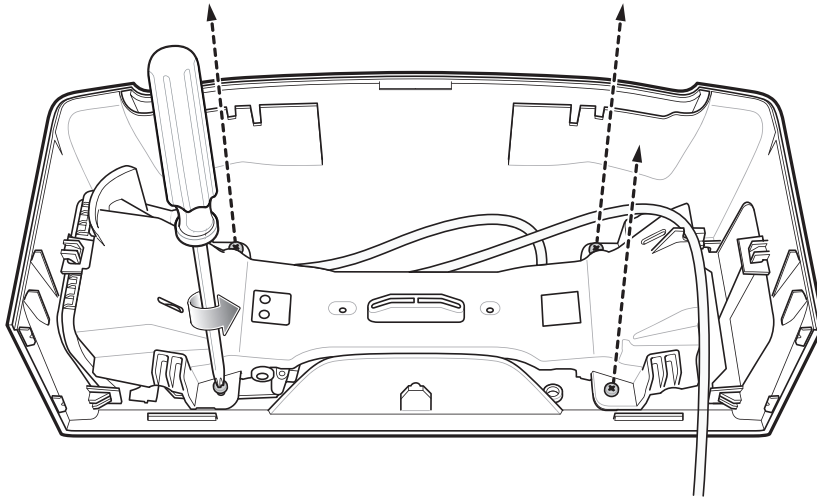

**Figure 7-5** *Unscrewing the Bracket*

4. Remove bracket from tower.

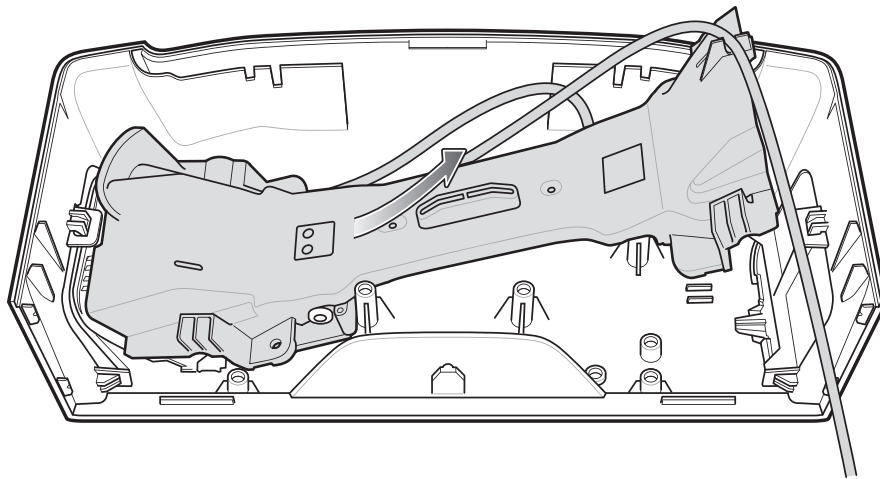

**Figure 7-6** *Removing the Bracket*

5. Remove the blank side cover from the right side of the CSS tower by depressing the three snaps and pushing the cover out.

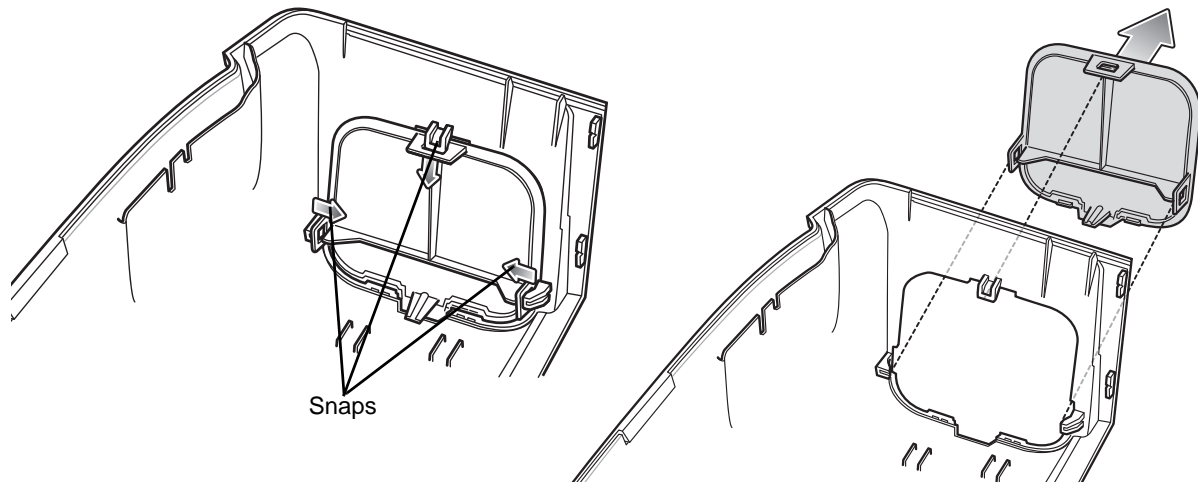

**Figure 7-7** *Removing Blank Cover*

6. Remove the scan window cover from the left side of the CSS tower by depressing the three snaps and pushing the cover out.

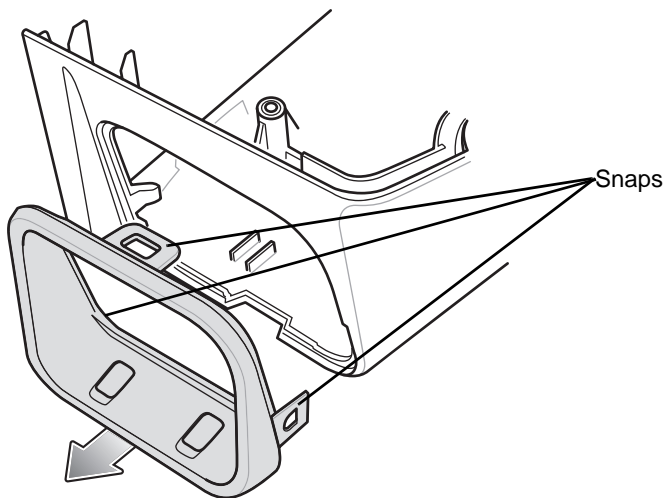

**Figure 7-8** *Removing the Scan Window Cover*

7. Snap the blank cover into the left side of the CSS tower cover.

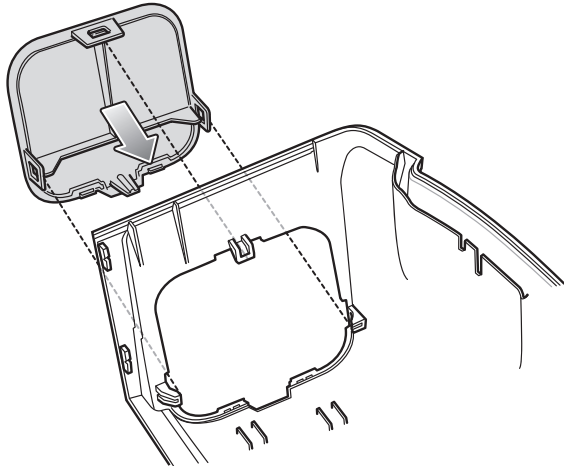

**Figure 7-9** *Snapping the Blank Cover into the Left Side*

8. Snap the scan window cover into the right side of the CSS tower cover.

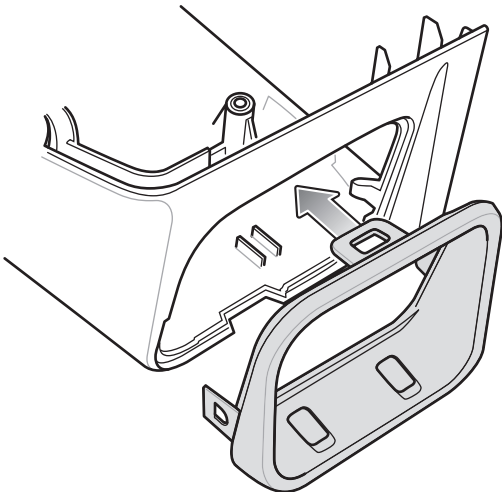

**Figure 7-10** *Snapping the Scan Window Cover into the Right Side*

9. Remove the scan module from the left side of the bracket.

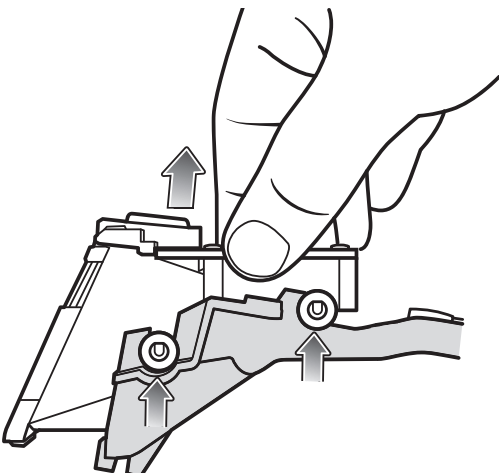

**Figure 7-11** *Removing the Scan Module from Bracket*

10. Insert the scan module into the right side of the bracket. Ensure the gaskets on the scan window fit securely into the bracket sockets as shown in [Figure 7-12](#). The module should snap into place when securely seated.

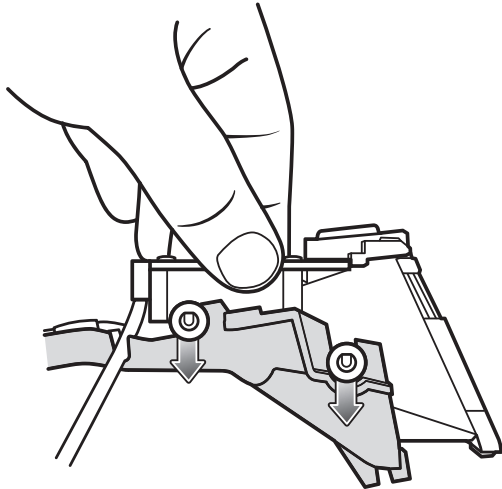

**Figure 7-12** *Inserting the Scan Module into the Bracket*

11. Follow the numbers next to each indent on the bracket to route the USB cable as shown in [Figure 7-13](#).

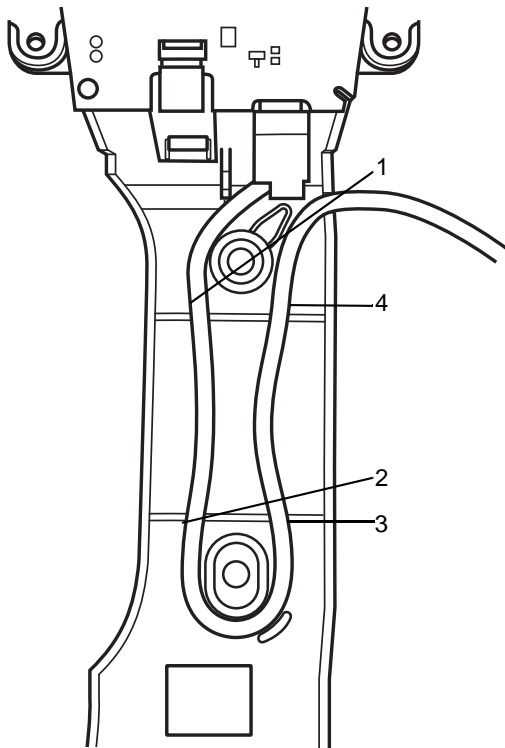

**Figure 7-13** *Routing the USB Cable*

12. Insert the USB cable into the clip on the top of the bracket as shown in [Figure 7-14](#). Leave approximately 240 mm (9.5 in.) of the cable free to store inside the tower housing.

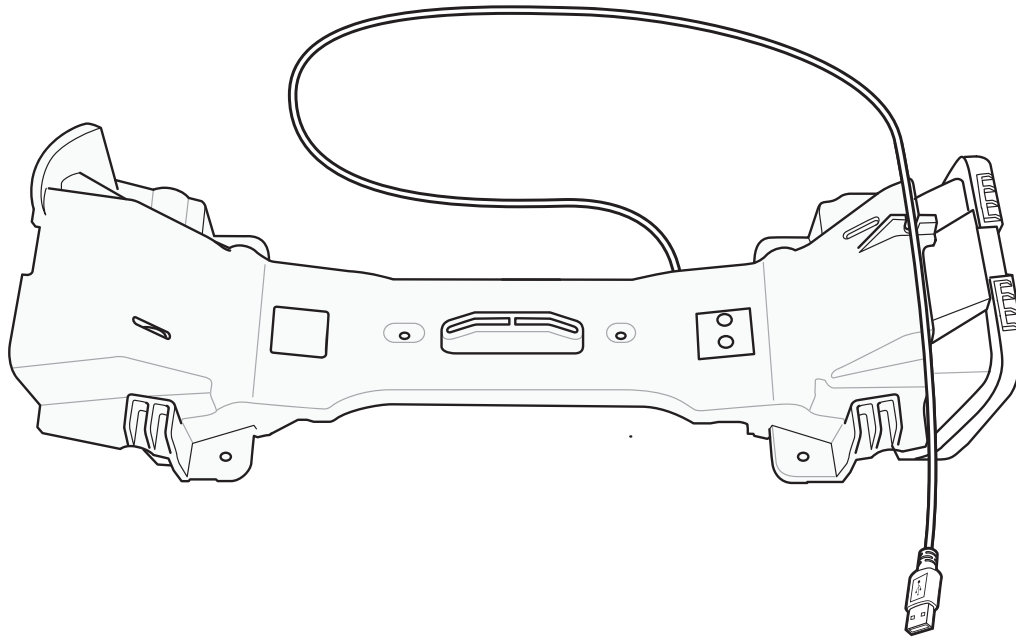

**Figure 7-14** *Routing the USB Cable*

13. Insert the bracket into the tower cover (scan window on the right side) by lining up the screw holes and screw the bracket in place.

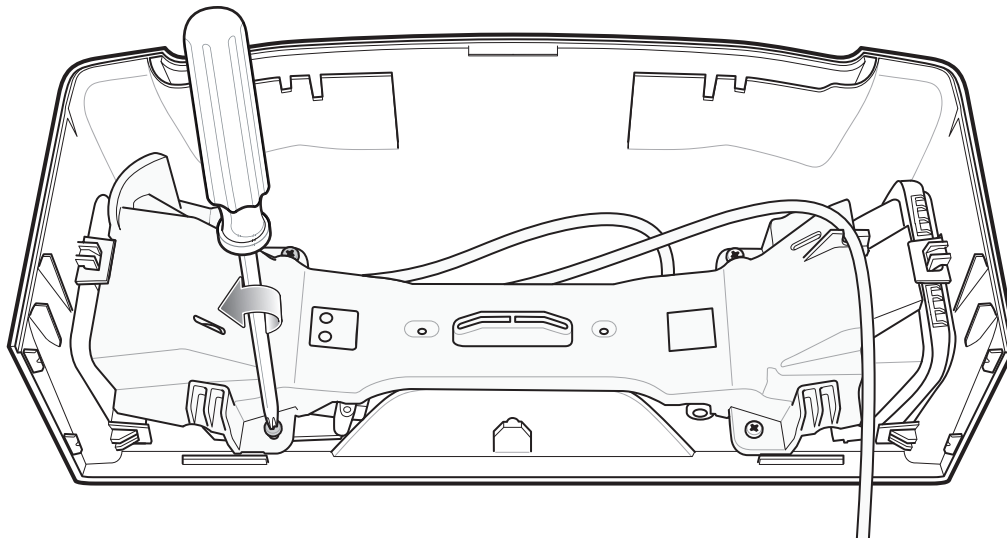

**Figure 7-15** *Insert Bracket and Tighten*

14. Route the cable into the side cable slots as shown in [Figure 7-3](#) and connect the USB cable to the top USB port (recommended) on the MP70XX.
15. Replace the MP70XX tower cover with the MX101 tower cover kit by sliding it onto the back housing and clicking it into place (see [Figure 7-4 on page 7-3](#)).

# CHAPTER 8 MAINTENANCE, TROUBLESHOOTING, AND SIGNAL DESCRIPTIONS

---

## Introduction

This chapter provides suggested digital scanner maintenance, troubleshooting, and pinout signal descriptions.

---

## Maintenance

Cleaning the scan window is the only maintenance required. A dirty window can affect scanning accuracy.

- Do not allow abrasive material to touch the window.
- Remove any dirt particles with a damp cloth.
- Wipe the window using a dust-free soft cloth moistened with isopropyl alcohol-based cleaner. Do not let liquid pool around the window or any other area on the scanner.
- Do not spray water or other cleaning liquids directly into the window.

## Troubleshooting

**Table 8-1** *Troubleshooting*

Problem	Possible Causes	Possible Solutions
Digital scanner emits short low/short medium/short high beep sequence (power-up beep sequence) more than once.	The USB bus may put the digital scanner in a state where power to the scanner is cycled on and off more than once.	Normal during host reset.
Digital scanner emits illumination, but does not decode the barcode.	Digital scanner is not programmed for that barcode type.	Program the digital scanner to read that type of barcode. See <a href="#">Chapter 5, Symbologies</a> .
	Barcode symbol is unreadable.	Scan test symbols of the same barcode type to determine if the barcode is defaced.
Digital scanner decodes barcode, but does not transmit the data to the host.	USB interface cable is loose.	Re-connect the cable.
	If the digital scanner emits 5 low beeps, a conversion or format error occurred.	Configure the digital scanner's conversion parameters properly.
	If the digital scanner emits low/high/low beeps, it detected an invalid ADF rule.	Program the correct ADF rules. Refer to the <i>Advanced Data Formatting Programmer Guide</i> .
	If the digital scanner emits high/low beeps, the scanner is buffering Code 39 data.	Normal scanning a Code 39 barcode and the Code 39 Buffering option is enabled.
Digital scanner emits low/high beeps during programming.	Input error or <b>Cancel</b> barcode was scanned.	Scan the correct numeric barcodes within range for the parameter programmed.
Digital scanner emits low/high/low/high beeps during programming.	Out of ADF parameter storage space.	Erase all rules and re-program with shorter rules.
Digital scanner emits low/high/low beeps.	Clearing Code 39 buffer.	Normal when scanning the Code 39 Buffering <b>Clear Buffer</b> barcode or upon attempt to transmit an empty Code 39 buffer.



**NOTE** If after performing these checks the digital scanner still experiences problems, contact the distributor or Zebra support. See [page xvi](#) for more information.



## Report Software Version Barcode

When contacting Zebra support, a support representative may ask you to scan the barcode below to determine the version of software installed in the digital scanner.



## Digital Scanner Signal Descriptions

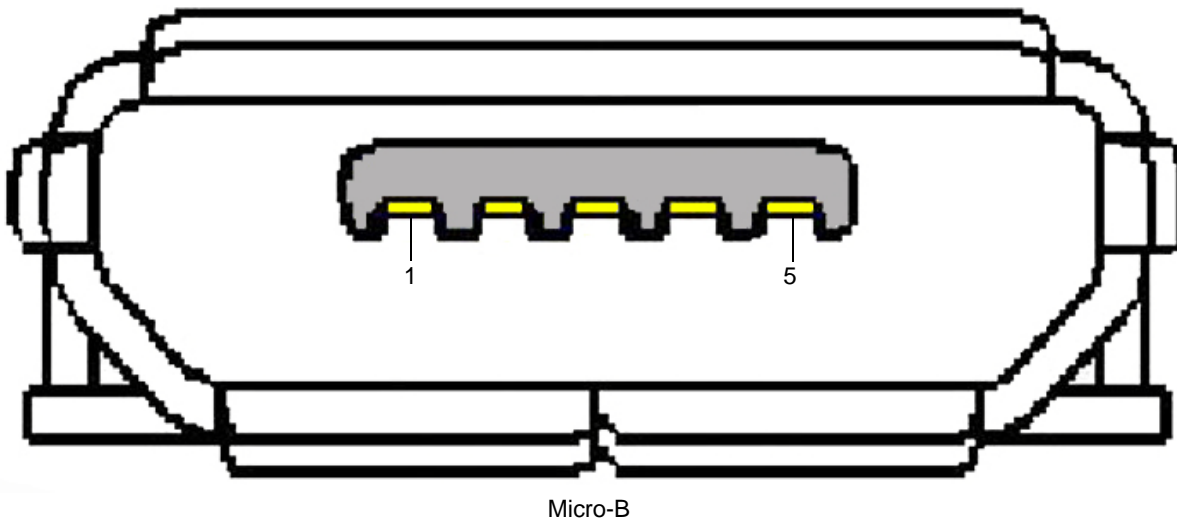

**Figure 8-1** Digital Scanner Cable Pinouts

The signal descriptions in [Table 8-2](#) apply to the connector on the MX101 digital scanner.

**Table 8-2** USB Connector Pin-outs

Pin	Signal	Function
1	5VDC	USB 5V
2	D-	USB Data-
3	D+	USB Data+
4	DOWNLOAD	Active High Download PIN
5	GND	Circuit GND
SHELL	GND_CHAS	Chassis GND



# APPENDIX A STANDARD PARAMETER DEFAULTS

**Table A-1** *Parameter Defaults*

Parameter	Parameter Number <sup>1</sup>	SSI Number <sup>2</sup>	Default	Page Number
<b>USB Host Parameters</b>				
USB Host Parameters	N/A	N/A	Symbol Native API (SNAPI) with Imaging Interface	<a href="#">3-2</a>
TGCS (IBM) USB Specification Version	N/A	N/A	IBM Specification Level Version 0 (Original)	<a href="#">3-3</a>
<b>User Preferences</b>				
Set Default Parameter	N/A	N/A	Restore Defaults	<a href="#">4-4</a>
Parameter Barcode Scanning	236	ECh	Enable	<a href="#">4-5</a>
Lock Parameter Scanning	802	F2h 22h	Disable	<a href="#">4-5</a>
Unlock Parameter Scanning	803	F2h 23h	Disable	<a href="#">4-5</a>
Beep After Good Decode	56	38h	Enable	<a href="#">4-6</a>
Beeper Volume	140	8Ch	High	<a href="#">4-7</a>
Beeper Tone	145	91h	High	<a href="#">4-8</a>
Beeper Duration	628	F1h 74h	Long	<a href="#">4-9</a>
Trigger Mode	138	8Ah	Presentation Mode	<a href="#">4-10</a>
Decode Aiming Pattern	306	F0h 32h	Disable	<a href="#">4-10</a>
Suppress Power Up Beeps	721	F1h D1h	Do Not Suppress	<a href="#">4-9</a>

1. Parameter number decimal values are used for programming via RSM commands.
2. SSI number hex values are used for programming via SSI commands.

**Table A-1** *Parameter Defaults (continued)*

Parameter	Parameter Number <sup>1</sup>	SSI Number <sup>2</sup>	Default	Page Number
Motion Detect Range	827	F2h 3Bh	Short Range	<a href="#">4-11</a>
Decode Session Timeout	136	88h	9.9 Seconds	<a href="#">4-11</a>
Timeout Between Decodes, Same Symbol	137	89h	0.6 Seconds	<a href="#">4-12</a>
Timeout Between Decodes, Different Symbols	144	90h	0.2 Seconds	<a href="#">4-12</a>
Mobile Phone/Display Mode	716	F1h CCh	Enable	<a href="#">4-13</a>
Range Restrict	629	F1h 75h	3 inches	<a href="#">4-14</a>
Presentation Mode Field of View	609	F1h 61h	Medium Field of View	<a href="#">4-15</a>
Fuzzy 1D Processing	514	F1h 02h	Enable	<a href="#">4-15</a>
Mirrored Image	624	F1h 70h	Disable	<a href="#">4-16</a>
Decoding Illumination	298	F0h 2Ah	Enable	<a href="#">4-16</a>
Illumination Brightness	669	F1h 9Dh	6	<a href="#">4-17</a>
Validate Concatenated Parameter Barcodes	692	F1h B4h	Disable	<a href="#">4-17</a>
<b>Miscellaneous Options</b>				
Transmit Code ID Character	45	2Dh	None	<a href="#">4-18</a>
SSI Prefix Value	99, 105	63h, 69h	<CR>	<a href="#">4-19</a>
SSI Suffix 1 Value	98, 104	62h, 68h	<CR>	<a href="#">4-19</a>
SSI Suffix 2 Value	100, 106	64h, 6Ah	<CR>	
Scan Data Transmission Format	235	EBh	Data As Is	<a href="#">4-20</a>
<b>Send Versions</b>				
Software Version	N/A	N/A	N/A	<a href="#">4-22</a>
Manufacturing Information	N/A	N/A	N/A	<a href="#">4-22</a>
Camera Manufacturing Information	N/A	N/A	N/A	<a href="#">4-22</a>
<b>Enable/Disable All Code Types</b>				<a href="#">5-8</a>
<b>1D Symbolologies</b>				
<b>UPC/EAN/JAN</b>				
UPC-A	1	01h	Disable	<a href="#">5-8</a>

**1. Parameter number decimal values are used for programming via RSM commands.  
2. SSI number hex values are used for programming via SSI commands.**

**Table A-1** Parameter Defaults (continued)

Parameter	Parameter Number <sup>1</sup>	SSI Number <sup>2</sup>	Default	Page Number
UPC-E	2	02h	Disable	<a href="#">5-9</a>
UPC-E1	12	0Ch	Disable	<a href="#">5-9</a>
EAN-8/JAN 8	4	04h	Disable	<a href="#">5-10</a>
EAN-13/JAN 13	3	03h	Disable	<a href="#">5-10</a>
Bookland EAN	83	53h	Disable	<a href="#">5-11</a>
Bookland ISBN Format	576	F1h 40h	ISBN-10	<a href="#">5-12</a>
ISSN EAN	617	F1h 69h	Disable	<a href="#">5-13</a>
Decode UPC/EAN/JAN Supplementals (2 and 5 digits)	16	10h	Ignore	<a href="#">5-13</a>
User-Programmable Supplementals			N/A	<a href="#">5-16</a>
Supplemental 1:	579	F4h F1h 43h		
Supplemental 2:	580	F4h F1h 44h		
UPC/EAN/JAN Supplemental Redundancy	80	50h	10	<a href="#">5-17</a>
UPC/EAN/JAN Supplemental AIM ID Format	672	F1h A0h	Combined	<a href="#">5-17</a>
Transmit UPC-A Check Digit	40	28h	Enable	<a href="#">5-18</a>
Transmit UPC-E Check Digit	41	29h	Enable	<a href="#">5-19</a>
Transmit UPC-E1 Check Digit	42	2Ah	Enable	<a href="#">5-19</a>
UPC-A Preamble	34	22h	System Character	<a href="#">5-20</a>
UPC-E Preamble	35	23h	System Character	<a href="#">5-21</a>
UPC-E1 Preamble	36	24h	System Character	<a href="#">5-22</a>
Convert UPC-E to A	37	25h	Disable	<a href="#">5-23</a>
Convert UPC-E1 to A	38	26h	Disable	<a href="#">5-23</a>
EAN/JAN Zero Extend	39	27h	Disable	<a href="#">5-24</a>
UCC Coupon Extended Code	85	55h	Disable	<a href="#">5-24</a>
Coupon Report	730	F1h DAh	New Coupon Format	<a href="#">5-25</a>
<b>Code 128</b>				
Code 128	8	08h	Enable	<a href="#">5-26</a>

1. Parameter number decimal values are used for programming via RSM commands.
2. SSI number hex values are used for programming via SSI commands.

**Table A-1** *Parameter Defaults (continued)*

Parameter	Parameter Number <sup>1</sup>	SSI Number <sup>2</sup>	Default	Page Number
Set Length(s) for Code 128	209, 210	D1h, D2h	Any Length	<a href="#">5-26</a>
GS1-128 (formerly UCC/EAN-128)	14	0Eh	Disable	<a href="#">5-27</a>
ISBT 128	84	54h	Disable	<a href="#">5-28</a>
ISBT Concatenation	577	F1h 41h	Disable	<a href="#">5-28</a>
Check ISBT Table	578	F1h 42h	Enable	<a href="#">5-29</a>
ISBT Concatenation Redundancy	223	DFh	10	<a href="#">5-29</a>
<b>Code 39</b>				
Code 39	0	00h	Disable	<a href="#">5-30</a>
Trioptic Code 39	13	0Dh	Disable	<a href="#">5-30</a>
Convert Code 39 to Code 32 (Italian Pharmacy Code)	86	56h	Disable	<a href="#">5-31</a>
Code 32 Prefix	231	E7h	Disable	<a href="#">5-31</a>
Set Length(s) for Code 39	18, 19	12h, 13h	2 to 55	<a href="#">5-32</a>
Code 39 Check Digit Verification	48	30h	Disable	<a href="#">5-33</a>
Transmit Code 39 Check Digit	43	2Bh	Disable	<a href="#">5-34</a>
Code 39 Full ASCII Conversion	17	11h	Disable	<a href="#">5-34</a>
Code 39 Buffering	113	71h	Disable	<a href="#">5-35</a>
<b>Code 93</b>				
Code 93	9	09h	Disable	<a href="#">5-37</a>
Set Length(s) for Code 93	26, 27	1Ah, 1Bh	4 to 55	<a href="#">5-37</a>
<b>Code 11</b>				
Code 11	10	0Ah	Disable	<a href="#">5-39</a>
Set Lengths for Code 11	28, 29	1Ch, 1Dh	4 to 55	<a href="#">5-39</a>
Code 11 Check Digit Verification	52	34h	Disable	<a href="#">5-41</a>
Transmit Code 11 Check Digit(s)	47	2Fh	Disable	<a href="#">5-42</a>
<b>Interleaved 2 of 5 (ITF)</b>				
Interleaved 2 of 5 (ITF)	6	06h	Disable	<a href="#">5-42</a>

**1. Parameter number decimal values are used for programming via RSM commands.  
2. SSI number hex values are used for programming via SSI commands.**

**Table A-1** Parameter Defaults (continued)

Parameter	Parameter Number <sup>1</sup>	SSI Number <sup>2</sup>	Default	Page Number
Set Lengths for I 2 of 5	22, 23	16h, 17h	1 Length; Length = 14	5-43
I 2 of 5 Check Digit Verification	49	31h	Disable	5-45
Transmit I 2 of 5 Check Digit	44	2Ch	Disable	5-45
Convert I 2 of 5 to EAN 13	82	52h	Disable	5-46
<b>Discrete 2 of 5 (DTF)</b>				
Discrete 2 of 5	5	05h	Disable	5-46
Set Length(s) for D 2 of 5	20, 21	14h 15h	1 to 55	5-47
<b>Codabar (NW - 7)</b>				
Codabar	7	07h	Disable	5-48
Set Lengths for Codabar	24, 25	18h, 19h	5 to 55	5-49
CLSI Editing	54	36h	Disable	5-51
NOTIS Editing	55	37h	Disable	5-51
Codabar Upper or Lower Case Start/ Stop Characters Detection	855	F2h 57h	Upper Case	5-52
<b>MSI</b>				
MSI	11	0Bh	Disable	5-52
Set Length(s) for MSI	30, 31	1Eh, 1Fh	4 to 55	5-53
MSI Check Digits	50	32h	One	5-54
Transmit MSI Check Digit	46	2Eh	Disable	5-55
MSI Check Digit Algorithm	51	33h	Mod 10/Mod 10	5-55
<b>Chinese 2 of 5</b>				
Chinese 2 of 5	408	F0h 98h	Disable	5-56
<b>Matrix 2 of 5</b>				
Matrix 2 of 5	618	F1h 6Ah	Disable	5-56
Set Lengths for Matrix 2 of 5	619 620	F1h 6Bh F1h 6Ch	Any Length	5-57
Matrix 2 of 5 Check Digit	622	F1h 6Eh	Disable	5-58

1. Parameter number decimal values are used for programming via RSM commands.  
2. SSI number hex values are used for programming via SSI commands.

**Table A-1** *Parameter Defaults (continued)*

Parameter	Parameter Number <sup>1</sup>	SSI Number <sup>2</sup>	Default	Page Number
Transmit Matrix 2 of 5 Check Digit	623	F1h 6Fh	Disable	<a href="#">5-59</a>
<b>Korean 3 of 5</b>				
Korean 3 of 5	581	F1h 45h	Disable	<a href="#">5-59</a>
<b>Inverse 1D</b>	586	F1h 4Ah	Regular	<a href="#">5-60</a>
<b>GS1 DataBar</b>				
GS1 DataBar Omnidirectional (formerly GS1 DataBar-14), GS1 DataBar Truncated, GS1 DataBar Stacked, GS1 DataBar Stacked Omnidirectional	338	F0h 52h	Enable	<a href="#">5-61</a>
GS1 DataBar Limited	339	F0h 53h	Disable	<a href="#">5-61</a>
GS1 DataBar Expanded, GS1 DataBar Expanded Stacked	340	F0h 54h	Disable	<a href="#">5-62</a>
Convert GS1 DataBar to UPC/EAN/JAN	397	F0h 8Dh	Disable	<a href="#">5-62</a>
GS1 DataBar Limited Margin Check	728	F1h D8h	Level 3	<a href="#">5-63</a>
<b>Symbology-Specific Security Features</b>				
Redundancy Level	78	4Eh	1	<a href="#">5-64</a>
Security Level	77	4Dh	1	<a href="#">5-66</a>
Intercharacter Gap Size	381	F0h 7Dh	Normal	<a href="#">5-67</a>
<b>Composite Codes</b>				
Composite CC-C	341	F0h 55h	Disable	<a href="#">5-67</a>
Composite CC-A/B	342	F0h 56h	Disable	<a href="#">5-68</a>
Composite TLC-39	371	F0h 73h	Disable	<a href="#">5-68</a>
UPC Composite Mode	344	F0h 58h	UPC Never Linked	<a href="#">5-69</a>
Composite Beep Mode	398	F0h 8Eh	Beep As Each Code Type is Decoded	<a href="#">5-70</a>
GS1-128 Emulation Mode for UCC/EAN Composite Codes	427	F0h ABh	Disable	<a href="#">5-72</a>

1. Parameter number decimal values are used for programming via RSM commands.
2. SSI number hex values are used for programming via SSI commands.



**Table A-1** *Parameter Defaults (continued)*

Parameter	Parameter Number <sup>1</sup>	SSI Number <sup>2</sup>	Default	Page Number
<b>2D Symbolologies</b>				
PDF417	15	0Fh	Disable	<a href="#">5-71</a>
MicroPDF417	227	E3h	Disable	<a href="#">5-71</a>
Code 128 Emulation	123	7Bh	Disable	<a href="#">5-70</a>
Data Matrix	292	F0h 24h	Disable	<a href="#">5-73</a>
Data Matrix Inverse	588	F1h 4Ch	Regular Only	<a href="#">5-73</a>
Decode Data Matrix Mirror Images	537	F1h 19h	Auto	<a href="#">5-74</a>
Maxicode	294	F0h 26h	Disable	<a href="#">5-75</a>
QR Code	293	F0h 25h	Disable	<a href="#">5-75</a>
QR Inverse	587	F1h 4Bh	Regular	<a href="#">5-76</a>
MicroQR	573	F1h 3Dh	Disable	<a href="#">5-77</a>
Aztec	574	F1h 3Eh	Disable	<a href="#">5-77</a>
Aztec Inverse	589	F1h 4Dh	Inverse Autodetect	<a href="#">5-78</a>
<b>Macro PDF</b>				
Macro PDF Transmit/Decode Mode Symbols	188	BCh	Passthrough Mode	<a href="#">5-80</a>
Transmit Macro PDF Control Header	184	B8h	Enable	<a href="#">5-81</a>
Escape Characters	233	E9h	None	<a href="#">5-81</a>
Flush Macro PDF Buffer	N/A	N/A	N/A	<a href="#">5-82</a>
Abort Macro PDF Entry	N/A	N/A	N/A	<a href="#">5-82</a>
<b>Postal Codes</b>				
US Postnet	89	59h	Disable	<a href="#">5-82</a>
US Planet	90	5Ah	Disable	<a href="#">5-83</a>
Transmit US Postal Check Digit	95	5Fh	Enable	<a href="#">5-83</a>
UK Postal	91	5Bh	Disable	<a href="#">5-84</a>
Transmit UK Postal Check Digit	96	60h	Enable	<a href="#">5-84</a>
Japan Postal	290	F0h 22h	Disable	<a href="#">5-85</a>

1. Parameter number decimal values are used for programming via RSM commands.
2. SSI number hex values are used for programming via SSI commands.

**Table A-1** *Parameter Defaults (continued)*

Parameter	Parameter Number <sup>1</sup>	SSI Number <sup>2</sup>	Default	Page Number
Australia Post	291	F0h 23h	Disable	<a href="#">5-85</a>
Australia Post Format	718	F1h CEh	Autodiscriminate	<a href="#">5-86</a>
Netherlands KIX Code	326	F0h 46h	Disable	<a href="#">5-87</a>
USPS 4CB/One Code/Intelligent Mail	592	F1h 50h	Disable	<a href="#">5-87</a>
UPU FICS Postal	611	F1h 63h	Disable	<a href="#">5-88</a>

1. Parameter number decimal values are used for programming via RSM commands.
2. SSI number hex values are used for programming via SSI commands.

# APPENDIX B PROGRAMMING REFERENCE

---

## Symbol Code Identifiers

**Table B-1** *Symbol Code Characters*

Code Character	Code Type
A	UPC-A, UPC-E, UPC-E1, EAN-8, EAN-13
B	Code 39, Code 32
C	Codabar
D	Code 128, ISBT 128, ISBT 128 Concatenated
E	Code 93
F	Interleaved 2 of 5
G	Discrete 2 of 5, or Discrete 2 of 5 IATA
H	Code 11
J	MSI
K	GS1-128
L	Bookland EAN
M	Trioptic Code 39
N	Coupon Code
R	GS1 DataBar Family
S	Matrix 2 of 5
T	UCC Composite, TLC 39
U	Chinese 2 of 5

**Table B-1** *Symbol Code Characters (continued)*

Code Character	Code Type
V	Korean 3 of 5
X	ISSN EAN, PDF417, Macro PDF417, Micro PDF417
z	Aztec, Aztec Rune
P00	Data Matrix
P01	QR Code, MicroQR
P02	Maxicode
P03	US Postnet
P04	US Planet
P05	Japan Postal
P06	UK Postal
P08	Netherlands KIX Code
P09	Australia Post
P0A	USPS 4CB/One Code/Intelligent Mail
P0B	UPU FICS Postal

---

## AIM Code Identifiers

Each AIM Code Identifier contains the three-character string **jcm** where:

- j = Flag Character (ASCII 93)
- c = Code Character (see [Table B-2](#))
- m = Modifier Character (see [Table B-3](#))

**Table B-2** *Aim Code Characters*

Code Character	Code Type
A	Code 39, Code 39 Full ASCII, Code 32
C	Code 128, ISBT 128, ISBT 128 Concatenated, GS1-128, Coupon (Code 128 portion)
d	Data Matrix
E	UPC/EAN, Coupon (UPC portion)
e	GS1 DataBar Family
F	Codabar
G	Code 93

**Table B-2** Aim Code Characters (continued)

Code Character	Code Type
H	Code 11
I	Interleaved 2 of 5
L	PDF417, Macro PDF417, Micro PDF417
L2	TLC 39
M	MSI
Q	QR Code, MicroQR
S	Discrete 2 of 5, IATA 2 of 5
U	Maxicode
z	Aztec, Aztec Rune
X	Bookland EAN, ISSN EAN, Trioptic Code 39, Chinese 2 of 5, Matrix 2 of 5, Korean 3 of 5, US Postnet, US Planet, UK Postal, Japan Postal, Australia Post, Netherlands KIX Code, USPS 4CB/One Code/ Intelligent Mail, UPU FICS Postal

The modifier character is the sum of the applicable option values based on [Table B-3](#).

**Table B-3** Modifier Characters

Code Type	Option Value	Option
<b>Code 39</b>	0	No check character or Full ASCII processing.
	1	Reader has checked one check character.
	3	Reader has checked and stripped check character.
	4	Reader has performed Full ASCII character conversion.
	5	Reader has performed Full ASCII character conversion and checked one check character.
	7	Reader has performed Full ASCII character conversion and checked and stripped check character.
	Example: A Full ASCII barcode with check character W, <b>A+I+MI+DW</b> , is transmitted as <b>J A7AIMID</b> where 7 = (3+4).	
<b>Trioptic Code 39</b>	0	No option specified at this time. Always transmit 0.
	Example: A Trioptic barcode 412356 is transmitted as <b>JX0412356</b>	
<b>Code 128</b>	0	Standard data packet, no Function code 1 in first symbol position.
	1	Function code 1 in first symbol character position.
	2	Function code 1 in second symbol character position.
	Example: A Code (EAN) 128 barcode with Function 1 character <sup>FNC1</sup> in the first position, AIMID is transmitted as <b>J C1AIMID</b>	

## B - 4 MX101 Customer Side Scanner for the MP7000 Scanner Scale PRG

**Table B-3** *Modifier Characters (continued)*

Code Type	Option Value	Option
<b>I 2 of 5</b>	0	No check digit processing.
	1	Reader has validated check digit.
	3	Reader has validated and stripped check digit.
	Example: An I 2 of 5 barcode without check digit, 4123, is transmitted as <b>J</b> I04123	
<b>Codabar</b>	0	No check digit processing.
	1	Reader has checked check digit.
	3	Reader has stripped check digit before transmission.
	Example: A Codabar barcode without check digit, 4123, is transmitted as <b>J</b> F04123	
<b>Code 93</b>	0	No options specified at this time. Always transmit 0.
	Example: A Code 93 barcode 012345678905 is transmitted as <b>J</b> G0012345678905	
<b>MSI</b>	0	Check digits are sent.
	1	No check digit is sent.
	Example: An MSI barcode 4123, with a single check digit checked, is transmitted as <b>J</b> M14123	
<b>D 2 of 5</b>	0	No options specified at this time. Always transmit 0.
	Example: A D 2 of 5 barcode 4123, is transmitted as <b>J</b> S04123	
<b>UPC/EAN</b>	0	Standard data packet in full EAN format, i.e., 13 digits for UPC-A, UPC-E, and EAN-13 (not including supplemental data).
	1	Two digit supplemental data only.
	2	Five digit supplemental data only.
	3	Combined data packet comprising 13 digits from EAN-13, UPC-A or UPC-E symbol and 2 or 5 digits from supplemental symbol.
	4	EAN-8 data packet.
	Example: A UPC-A barcode 012345678905 is transmitted as <b>J</b> E00012345678905	
<b>Bookland EAN</b>	0	No options specified at this time. Always transmit 0.
	Example: A Bookland EAN barcode 123456789X is transmitted as <b>J</b> X0123456789X	
<b>ISSN EAN</b>	0	No options specified at this time. Always transmit 0.
	Example: An ISSN EAN barcode 123456789X is transmitted as <b>J</b> X0123456789X	
<b>Code 11</b>	0	Single check digit
	1	Two check digits
	3	Check characters validated but not transmitted.

Table B-3 *Modifier Characters (continued)*

Code Type	Option Value	Option
<b>GS1 DataBar Family</b>		No option specified at this time. Always transmit 0. GS1 DataBar-14 and GS1 DataBar Limited transmit with an Application Identifier "01". Note: In GS1-128 emulation mode, GS1 DataBar is transmitted using Code 128 rules (i.e., ]C1).
	Example: A GS1 DataBar-14 barcode 0110012345678902 is transmitted as ]e00110012345678902.	
<b>EAN.UCC Composites (GS1 DataBar, GS1-128, 2D portion of UPC composite)</b>		Native mode transmission. Note: UPC portion of composite is transmitted using UPC rules.
	0	Standard data packet.
	1	Data packet containing the data following an encoded symbol separator character.
	2	Data packet containing the data following an escape mechanism character. The data packet does not support the ECI protocol.
	3	Data packet containing the data following an escape mechanism character. The data packet supports the ECI protocol.
		GS1-128 emulation Note: UPC portion of composite is transmitted using UPC rules.
	1	Data packet is a GS1-128 symbol (i.e., data is preceded with ]JC1).
<b>PDF417, Micro PDF417</b>	0	Reader set to conform to protocol defined in 1994 PDF417 symbology specifications. <b>Note:</b> When this option is transmitted, the receiver cannot reliably determine whether ECIs have been invoked or whether data byte 92 <sub>DEC</sub> has been doubled in transmission.
	1	Reader set to follow the ECI protocol (Extended Channel Interpretation). All data characters 92 <sub>DEC</sub> are doubled.
	2	Reader set for Basic Channel operation (no escape character transmission protocol). Data characters 92 <sub>DEC</sub> are not doubled. <b>Note:</b> When decoders are set to this mode, unbuffered Macro symbols and symbols requiring the decoder to convey ECI escape sequences cannot be transmitted.
	3	The barcode contains a GS1-128 symbol, and the first codeword is 903-907, 912, 914, 915.
	4	The barcode contains a GS1-128 symbol, and the first codeword is in the range 908-909.
	5	The barcode contains a GS1-128 symbol, and the first codeword is in the range 910-911.
	Example: A PDF417 barcode ABCD, with no transmission protocol enabled, is transmitted as ]L2ABCD.	

B - 6 MX101 Customer Side Scanner for the MP7000 Scanner Scale PRG

**Table B-3** *Modifier Characters (continued)*

<b>Code Type</b>	<b>Option Value</b>	<b>Option</b>
<b>Data Matrix</b>	0	ECC 000-140, not supported.
	1	ECC 200.
	2	ECC 200, FNC1 in first or fifth position.
	3	ECC 200, FNC1 in second or sixth position.
	4	ECC 200, ECI protocol implemented.
	5	ECC 200, FNC1 in first or fifth position, ECI protocol implemented.
	6	ECC 200, FNC1 in second or sixth position, ECI protocol implemented.
<b>MaxiCode</b>	0	Symbol in Mode 4 or 5.
	1	Symbol in Mode 2 or 3.
	2	Symbol in Mode 4 or 5, ECI protocol implemented.
	3	Symbol in Mode 2 or 3, ECI protocol implemented in secondary message.
<b>QR Code</b>	0	Model 1 symbol.
	1	Model 2 / MicroQR symbol, ECI protocol not implemented.
	2	Model 2 symbol, ECI protocol implemented.
	3	Model 2 symbol, ECI protocol not implemented, FNC1 implied in first position.
	4	Model 2 symbol, ECI protocol implemented, FNC1 implied in first position.
	5	Model 2 symbol, ECI protocol not implemented, FNC1 implied in second position.
	6	Model 2 symbol, ECI protocol implemented, FNC1 implied in second position.
<b>Aztec</b>	0	Aztec symbol.
	C	Aztec Rune symbol.



# APPENDIX C NUMERIC BAR CODES

---

## Numeric Barcodes

For parameters requiring specific numeric values, scan the appropriately numbered barcode(s).



0



1



2



3



4

---

## Numeric Barcodes (continued)



5



6



7



8



9

---

## Cancel

To correct an error or change a selection, scan the barcode below.



Cancel

# APPENDIX D ALPHANUMERIC BAR CODES

---

## Cancel

To correct an error or change a selection, scan the following barcode.



Cancel

---

## Alphanumeric Barcodes

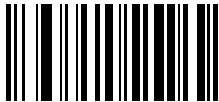

Space



#



\$

---

## Alphanumeric Barcodes (continued)



\*



%

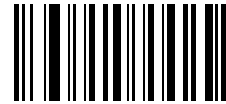

+

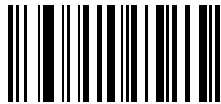

-



.

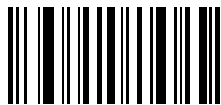

/



!

---

## Alphanumeric Barcodes (continued)



“

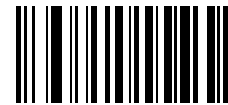

&

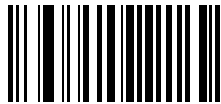

<

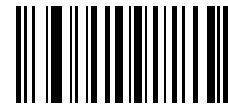

(

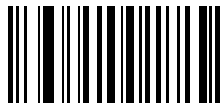

)

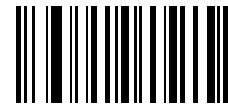

:



;

---

## Alphanumeric Barcodes (continued)

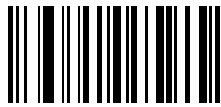

=

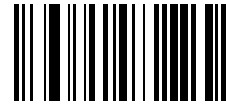

<



?

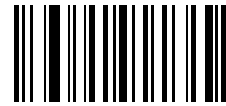

>



[

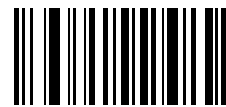

@



\

---

## Alphanumeric Barcodes (continued)

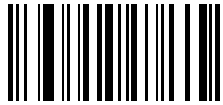

1

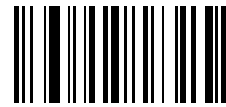

2

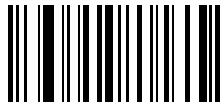

3

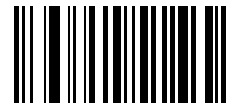

4

---

## Alphanumeric Barcodes (continued)

✓ **NOTE** Do not confuse the following barcodes with those on the numeric keypad.



0

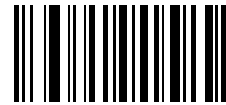

1



2

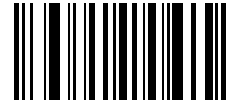

3



4

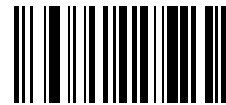

5



---

## Alphanumeric Barcodes (continued)



6



7

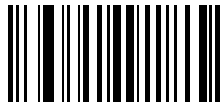

8

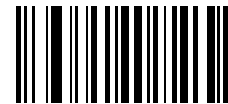

9



End of Message



Cancel

---

## Alphanumeric Barcodes (continued)



A

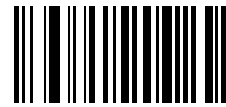

B



C

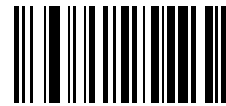

D



E



F

---

## Alphanumeric Barcodes (continued)



G

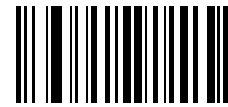

H



I

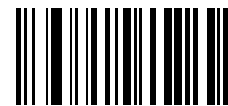

J



K

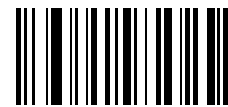

L

---

## Alphanumeric Barcodes (continued)

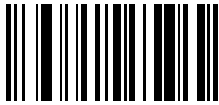

M

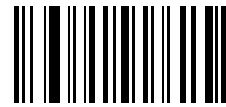

N



O

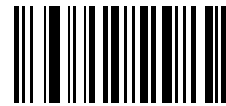

P

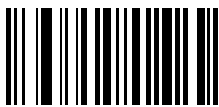

Q



R

---

## Alphanumeric Barcodes (continued)



S

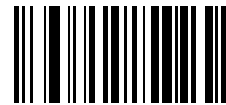

T

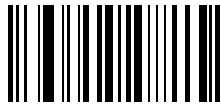

U

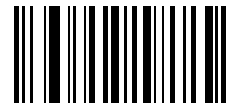

V

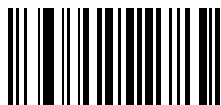

W

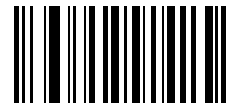

X

---

## Alphanumeric Barcodes (continued)



Y



Z

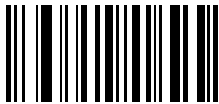

a

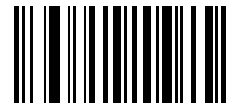

b



c

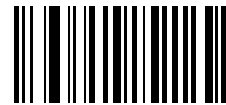

d

---

## Alphanumeric Barcodes (continued)



e

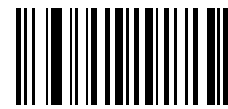

f



g

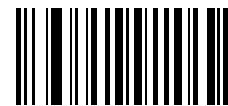

h

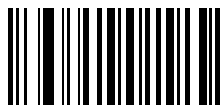

i



j

---

## Alphanumeric Barcodes (continued)

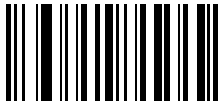

k

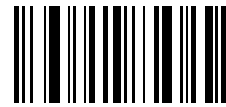

l

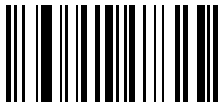

m



n



o

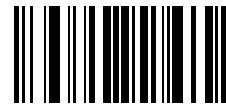

p



---

## Alphanumeric Barcodes (continued)



q

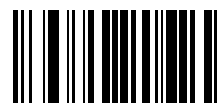

r



s

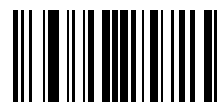

t



u

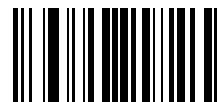

v

---

## Alphanumeric Barcodes (continued)

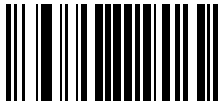

w

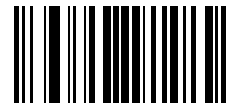

x

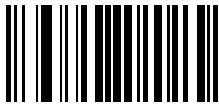

y

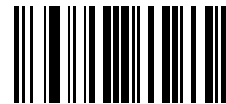

z

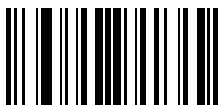

{

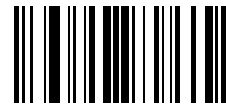

|

---

## Alphanumeric Barcodes (continued)

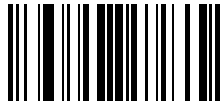

}

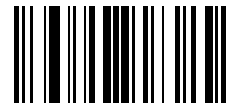

~



# APPENDIX E SAMPLE BAR CODES



**IMPORTANT** To read a sample barcode the parameter must be enabled. To enable a parameter scan the appropriate enable barcode in [Chapter 5, Symbologies](#).

---

## UPC/EAN

UPC-A, 100%



---

## UPC/EAN (continued)

### UPC-A with 2-digit Add-on

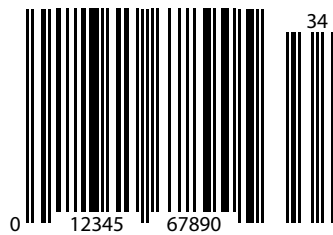

---

## UPC/EAN (continued)

### UPC-A with 5-digit Add-on



---

## UPC/EAN (continued)

UPC-E





---

## UPC/EAN (continued)

UPC-E with 2-digit Add-on



---

## UPC/EAN (continued)

### UPC-E with 5-digit Add-on



---

**UPC/EAN (continued)**

**EAN-8**



---

**UPC/EAN (continued)**

**EAN-13, 100%**

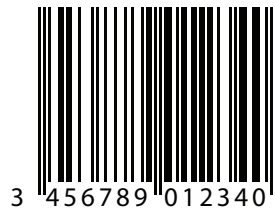

---

## UPC/EAN (continued)

EAN-13 with 2-digit Add-on



---

## UPC/EAN (continued)

**EAN-13 with 5-digit Add-on**



---

**Code 128**



---

**Code 128 (continued)**

**GS1-128**



(01)94019097685457(13)170119(30)17



---

**Code 39**



---

**Code 93**

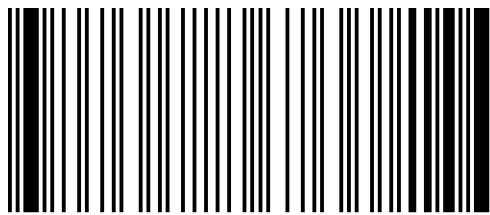

1234567890

---

**Code 11 with 2 Check Digits**

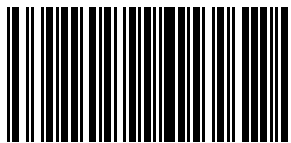

2468101275

---

**Interleaved 2 of 5**



12345678901231

---

**MSI with 2 Check Digits**

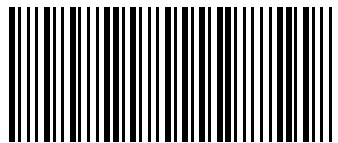

123455834

---

**Chinese 2 of 5**

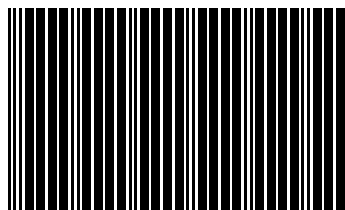

45454545454

---

**Matrix 2 of 5**



---

**Korean 3 of 5**





---

## GS1 DataBar

GS1 DataBar Omnidirectional (formerly GS1 DataBar-14)



7612341562341

---

## GS1 DataBar (continued)

GS1 DataBar Truncated

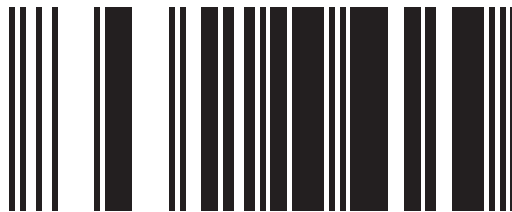

(01)00614141999996

---

## GS1 DataBar (continued)

### GS1 DataBar Stacked



---

## GS1 DataBar (continued)

### GS1 DataBar Stacked Omnidirectional



---

## GS1 DataBar (continued)

GS1 DataBar Limited

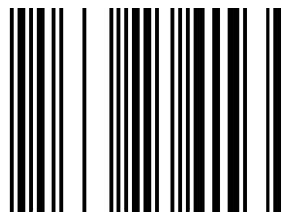

(01)00012345678905

---

## GS1 DataBar (continued)

### GS1 DataBar Expanded

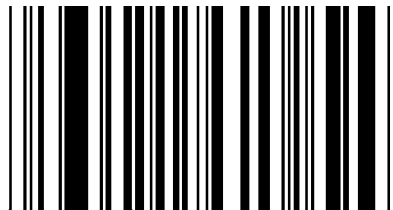

(01)12345678901231

---

## GS1 DataBar (continued)

### GS1 DataBar Expanded Stacked



---

## 2D Symbolologies

PDF417





---

## 2D Symbologies (continued)

Data Matrix



---

## 2D Symbologies (continued)

---

## 2D Symbologies (continued)

QR Code



---

## 2D Symbologies (continued)

---

## 2D Symbologies (continued)

MicroQR



---

## 2D Symbolologies (continued)

Aztec



0123456789ABCDEFGHIJKLMNOPQRSTUVWXYZ0123456789ABCDEFGHIJKLMNOPQRSTUVWXYZ0123456789012345  
6789ABCDEFGHIJKLMNOPQRSTUVWXYZ0123456789ABCDEFGHIJKLMNOPQRSTUVWXYZ0123456789

# INDEX

## Numerics

123Scan	
overview	6-1
requirements	6-2
videos/tools	
SDKs, drivers, apps	6-3
URLs	6-2
2D barcodes	
aztec	5-77
aztec inverse	5-78
code 128 emulation	5-72
data matrix	5-73
data matrix inverse	5-73
data matrix mirror images	5-74
maxicode	5-75
microPDF417	5-71
microQR	5-77
PDF417	5-71
QR code	5-75
QR inverse	5-76

## A

ADF	6-4
advanced data formatting	6-4
aiming	
pattern	4-10
aztec barcodes	
sample	E-34
aztec barcodes	5-77
inverse	5-78

## B

barcodes	
alphanumeric	D-1

cancel	C-2, D-1
enable all code types	5-8
GS1 databar	
convert to UPC/EAN/JAN	5-62
inverse 1D	5-60
numeric	C-1, C-2
numeric barcodes	C-2
report software version	8-3
samples	E-1
barcode samples	E-1
barcodes	
aztec	5-77
inverse	5-78
beep after good decode	4-6
beeper duration	4-9
beeper tone	4-8
beeper volume	4-7
buffering	5-35
camera manufacturing information	4-22
Chinese 2 of 5	5-56
codabar	5-48
CLSI editing	5-51
lengths	5-49
NOTIS editing	5-51
start and stop characters	5-52
code 11	5-39
check digit verification	5-41
lengths	5-39
transmit check digits	5-42
code 128	5-26
check ISBT table	5-29
GS1-128	5-27
ISBT 128	5-28
ISBT concatenation	5-28
ISBT concatenation redundancy	5-29
lengths	5-26
code 128 emulation	5-72

## Index - 2 MX101 Customer Side Scanner for the MP7000 Scanner Scale PRG

code 39	5-30	maxicode	5-75
check digit verification	5-33	microPDF417	5-71
code 32 prefix	5-31	mirrored image	4-16
convert code 39 to code 32	5-31	mobile phone/display mode	4-13
full ASCII conversion	5-34	motion detect range	4-11
lengths	5-32	MSI	5-52
transmit buffer	5-36	check digit algorithm	5-55
transmit check digit	5-34	check digits	5-54
trioptic code 39	5-30	lengths	5-53
code 93	5-37	transmit check digit	5-55
lengths	5-37	parameter scanning	4-5
composite		PDF417	5-71
beep mode	5-70	postal	5-82
composite CC-A/B	5-68	Australia post	5-85
composite CC-C	5-67	Australia post format	5-86
composite TLC-39	5-68	Japan postal	5-85
GS1-128 emulation mode	5-70	Netherlands KIX code	5-87
UPC composite mode	5-69	transmit UK postal check digit	5-84
data matrix	5-73	transmit US postal check digit	5-83
data matrix inverse	5-73	UK postal	5-84
mirror images	5-74	UPU FICS postal	5-88
decode aiming pattern	4-10	US planet	5-83
decode session timeout	4-11	US postnet	5-82
disable all code types	5-8	USPS 4CB/One Code/Intelligent Mail	5-87
discrete 2 of 5	5-46	prefix/suffix values	4-19
lengths	5-47	presentation mode field of view	4-15
fuzzy 1D processing	4-15	QR code	5-75
GS1 databar	5-61	inverse	5-76
GS1 databar expanded	5-62	microQR	5-77
GS1 databar limited	5-61	range restrict	4-14
GS1 databar limited margin check	5-63	redundancy level	5-64
GS1 databar omnidirectional	5-61	scan data options	4-20
illumination	4-16	security level	5-66
illumination brightness	4-17	send versions	4-22
intercharacter gap size	5-67	set defaults	4-4
interleaved 2 of 5	5-42	software version	4-22
check digit verification	5-45	suppress power up beeps	4-9
convert to EAN-13	5-46	symbolologies	
lengths	5-43	default table	5-2
transmit check digit	5-45	timeout between decodes,	
inverse 1D	5-60	different symbols	4-12
Korean 3 of 5	5-59	timeout between decodes,	
lock/unlock parameter scanning	4-5	same symbol	4-12
macro PDF		transmit code ID character	4-18
abort entry	5-82	trigger mode	4-10
escape characters	5-81	UPC/EAN/JAN	
flush buffer	5-82	bookland EAN	5-11
transmit / decode mode symbols	5-80	bookland ISBN	5-12
transmit control header	5-81	convert UPC-E to UPC-A	5-23
manufacturing information	4-22	convert UPC-E1 to UPC-A	5-23
matrix 2 of 5	5-56	coupon report	5-25
check digit	5-58	EAN/JAN zero extend	5-24
lengths	5-57	EAN-13/JAN-13	5-10
transmit check digit	5-59	EAN-8/JAN-8	5-10



- ISSN EAN . . . . . 5-13
  - supplemental AIM ID format . . . . . 5-17
  - supplemental redundancy . . . . . 5-17
  - supplementals . . . . . 5-13
  - transmit UPC-A check digit . . . . . 5-18
  - transmit UPC-E check digit . . . . . 5-19
  - transmit UPC-E1 check digit . . . . . 5-19
  - UCC coupon extended code . . . . . 5-24
  - UPC-A . . . . . 5-8
  - UPC-A preamble . . . . . 5-20
  - UPC-E . . . . . 5-9
  - UPC-E preamble . . . . . 5-21
  - UPC-E1 . . . . . 5-9
  - UPC-E1 preamble . . . . . 5-22
  - user programmable supplementals . . . . . 5-16
  - USB
    - default table . . . . . 3-2
    - IBM specification version . . . . . 3-3
  - user preferences
    - default table . . . . . 4-2
  - validate concatenated parameter
    - barcodes . . . . . 4-17
  - beeper
    - beep after good decode . . . . . 4-6
    - definitions, macro PDF . . . . . 5-79
    - duration . . . . . 4-9
    - suppress on power up . . . . . 4-9
    - tone adjustment . . . . . 4-8
  - beeper definitions . . . . . 2-1
  - bullets . . . . . xv
- C**
- cables
    - signal descriptions . . . . . 8-3
  - Chinese 2 of 5 barcodes
    - sample . . . . . E-18
  - Chinese 2 of 5 barcodes . . . . . 5-56
  - codabar barcodes . . . . . 5-48
    - CLSI editing . . . . . 5-51
    - lengths . . . . . 5-49
    - NOTIS editing . . . . . 5-51
    - start and stop characters . . . . . 5-52
  - code 11 barcodes
    - sample . . . . . E-15
  - code 11 barcodes . . . . . 5-39
    - check digit verification . . . . . 5-41
    - lengths . . . . . 5-39
    - transmit check digits . . . . . 5-42
  - code 128 barcodes
    - sample . . . . . E-11
  - code 128 barcodes . . . . . 5-26
    - check ISBT table . . . . . 5-29
    - GS1-128 . . . . . 5-27
  - ISBT 128 . . . . . 5-28
  - ISBT concatenation . . . . . 5-28
  - ISBT concatenation redundancy . . . . . 5-29
    - lengths . . . . . 5-26
  - code 128 emulation barcodes . . . . . 5-72
  - code 39 barcodes
    - sample . . . . . E-1, E-13
  - code 39 barcodes . . . . . 5-30
    - buffering . . . . . 5-35
    - check digit verification . . . . . 5-33
    - code 32 prefix . . . . . 5-31
    - convert code 39 to code 32 . . . . . 5-31
    - full ASCII conversion . . . . . 5-34
    - lengths . . . . . 5-32
    - transmit check digit . . . . . 5-34
    - trioptic . . . . . 5-30
  - code 93 barcodes
    - sample . . . . . E-14
  - code 93 barcodes . . . . . 5-37
    - lengths . . . . . 5-37
  - code identifiers
    - AIM . . . . . B-2
    - modifier characters . . . . . B-3
    - Symbol . . . . . B-1
    - transmitting . . . . . 4-18
  - composite barcodes
    - beep mode . . . . . 5-70
    - composite CC-A/B . . . . . 5-68
    - composite CC-C . . . . . 5-67
    - composite TLC-39 . . . . . 5-68
    - GS1-128 emulation mode . . . . . 5-70
    - UPC composite mode . . . . . 5-69
  - conventions
    - notational . . . . . xv
  - CSS
    - installation . . . . . 7-1
- D**
- data matrix barcodes . . . . . 5-73
    - data matrix inverse . . . . . 5-73
    - mirror images . . . . . 5-74
  - decode ranges . . . . . 2-2
  - default parameters . . . . . 4-2
    - all . . . . . A-1
    - setting . . . . . 4-4
    - USB . . . . . 3-2
    - user preferences . . . . . 4-2
  - discrete 2 of 5 barcodes . . . . . 5-46
    - lengths . . . . . 5-47
- E**
- exposure options

illumination ..... 4-16  
 presentation mode field of view ..... 4-15

**G**

GS1 databar barcodes  
     convert GS1 databar to UPC/EAN/JAN ..... 5-62  
     sample ..... E-21  
 GS1 databar barcodes ..... 5-61  
     GS1 databar expanded ..... 5-62  
     GS1 databar limited ..... 5-61  
     GS1 databar limited margin check ..... 5-63  
     GS1 databar omnidirectional ..... 5-61

**I**

illumination ..... 4-16  
     brightness ..... 4-17  
 indicators ..... 2-1  
 interleaved 2 of 5 barcodes  
     sample ..... E-16  
 interleaved 2 of 5 barcodes ..... 5-42  
     check digit verification ..... 5-45  
     convert to EAN-13 ..... 5-46  
     lengths ..... 5-43  
     transmit check digit ..... 5-45

**K**

Korean 2 of 5 barcodes  
     sample ..... E-20  
 Korean 3 of 5 barcodes ..... 5-59

**L**

LED definitions ..... 2-1

**M**

macro PDF ..... 5-79  
     abort entry ..... 5-82  
     escape characters ..... 5-81  
     flush buffer ..... 5-82  
     transmit / decode mode symbols ..... 5-80  
     transmit control header ..... 5-81  
     user indications ..... 5-79  
 maintenance ..... 8-1  
 matrix 2 of 5 barcodes  
     sample ..... E-19  
 matrix 2 of 5 barcodes ..... 5-56  
     check digit ..... 5-58  
     lengths ..... 5-57  
     transmit check digit ..... 5-59  
 maxicode barcodes ..... 5-75

microPDF417 barcodes ..... 5-71  
 microQR code barcodes  
     sample ..... E-33  
 MSI barcodes  
     sample ..... E-17  
 MSI barcodes ..... 5-52  
     check digit algorithm ..... 5-55  
     check digits ..... 5-54  
     lengths ..... 5-53  
     transmit check digit ..... 5-55  
 MX101 installation ..... 7-1

**N**

notational conventions ..... xv

**P**

PDF417 barcodes  
     sample ..... E-28  
 PDF417 barcodes ..... 5-71  
 phantom scan session ..... 4-2  
 pinouts  
     scanner signal descriptions ..... 8-3  
 postal code barcodes ..... 5-82  
     Australia post ..... 5-85  
     Australia post format ..... 5-86  
     Japan postal ..... 5-85  
     Netherlands KIX code ..... 5-87  
     transmit UK postal check digit ..... 5-84  
     transmit US postal check digit ..... 5-83  
     UK postal ..... 5-84  
     UPU FICS postal ..... 5-88  
     US planet ..... 5-83  
     US postnet ..... 5-82  
     USPS 4CB/One Code/Intelligent Mail ..... 5-87  
 presentation mode  
     field of view ..... 4-15

**Q**

QR code barcodes  
     inverse ..... 5-76  
     microQR ..... 5-77

**S**

sample barcodes  
     aztec ..... E-34  
     Chinese 2 of 5 ..... E-18  
     code 11 ..... E-15  
     code 128 ..... E-11  
     code 39 ..... E-1, E-13  
     code 93 ..... E-14

- GS1 databar ..... E-21
  - interleaved 2 of 5 ..... E-16
  - Korean 2 of 5 ..... E-20
  - matrix 2 of 5 ..... E-19
  - microQR code ..... E-33
  - MSI ..... E-17
  - PDF417 ..... E-28
  - sample barcodes
    - UPC/EAN ..... E-1
  - scanner control app ..... 6-3
  - scanning ..... 2-2
  - security
    - intercharacter gap size ..... 5-67
    - redundancy level ..... 5-64
    - security level ..... 5-66
  - service information ..... xvi
  - setting defaults ..... 4-4
  - signal descriptions ..... 8-3
  - software tools
    - 123Scan ..... 6-1
    - ADF ..... 6-4
    - scanner control app ..... 6-3
  - support ..... xvi
  - symbolologies
    - barcodes ..... 5-8
    - default parameters ..... 5-2
- T**
- trigger mode ..... 4-10
  - troubleshooting ..... 8-2
- U**
- UPC/EAN/JAN barcodes
    - bookland EAN ..... 5-11
    - bookland ISBN ..... 5-12
    - convert UPC-E to UPC-A ..... 5-23
    - convert UPC-E1 to UPC-A ..... 5-23
    - coupon report ..... 5-25
    - decode supplementals ..... 5-13
    - EAN/JAN zero extend ..... 5-24
    - EAN-13/JAN-13 ..... 5-10
    - EAN-8/JAN-8 ..... 5-10
    - ISSN EAN ..... 5-13
    - samples ..... E-1
    - supplemental AIM ID format ..... 5-17
    - supplemental redundancy ..... 5-17
    - transmit UPC-A check digit ..... 5-18
    - transmit UPC-E check digit ..... 5-19
    - transmit UPC-E1 check digit ..... 5-19
    - UCC coupon extended code ..... 5-24
    - UPC-A ..... 5-8
    - UPC-A preamble ..... 5-20
    - UPC-E ..... 5-9
    - UPC-E preamble ..... 5-21
    - UPC-E1 ..... 5-9
    - UPC-E1 preamble ..... 5-22
    - user programmable supplementals ..... 5-16
- USB**
- barcodes ..... 3-2
  - default parameters ..... 3-2
- V**
- version
    - barcodes ..... 4-22
- Z**
- Zebra support ..... xvi







Zebra Technologies Corporation, Inc.  
3 Overlook Point  
Lincolnshire, IL 60069, U.S.A.  
[www.zebra.com](http://www.zebra.com)

© 2018 ZIH Corp and/or its affiliates. All rights reserved. ZEBRA and the stylized Zebra head are trademarks of ZIH Corp, registered in many jurisdictions worldwide. All other trademarks are the property of their respective owners.

**MN-003031-02 Revision A - April 2018**