



Contents

Safety Instructions	3
Intended Use Statement	4
Safety Information	4
Safety Labels	6
Trademarks	7
Video and Audio Decoder Notices	7
Regulatory Notices	8
CE Statement	9
WEEE Statement	9
Introduction.....	10
Package Contents	10
About Your Projector	11
Main Unit	11
Input / Output Connections	12
Control Panel	13
Remote Control	14
Installing the Remote Control Battery.....	15
Operating Range with Remote Control	15
Installation.....	16
Connecting to a Computer	16
Connecting to a DVD Player	17
Connecting to Multi-Media.....	18
Turning On/Off the Projector	19
Turning Your Projector On	19
Turning Your Projector Off	19
Adjusting the Projected Image	20
360° Projection Capability	20
Adjusting Projection Image Size	21
User Controls.....	23
Using the On-Screen Display	23
Main Menu (WXGA model)	23
Image	24
Display	25
Setup	26
Setup > Advanced	27
Info	27

Main Menu (1080p model).....	28
Audio	28
Color.....	29
Image	30
3D.....	31
Info	33
Multi-Media Introduction	34
Photo Format	34
Video Format	34
Audio Format.....	35
Office Viewer Format.....	35
How to set-up File Type for Multi-Media with USB	37
Multi-Media Settings for System and USB	44
System Settings.....	44
Photo Settings	45
Video Setup.....	45
Music Setup	46
Office Setup	47
Mirroring the Screen of a Portable Device	48
How to opt out EZCast Google Analytics.....	55
Appendices	57
Troubleshooting	57
Status Indicators	58
Compatibility Modes (HDMI/VGA).....	59
Ceiling Mount the Projector	64
Specification	65

Safety Instructions

	The lightning flash with arrow head within an equilateral triangle is intended to alert the user to the presence of uninsulated "dangerous voltage" within the product's enclosure that may be of sufficient magnitude to constitute a risk of electric shock to persons.
	The exclamation point within an equilateral triangle is intended to alert the user to the presence of important operating and maintenance (servicing) instructions in the literature accompanying the appliance.

WARNING: TO REDUCE THE RISK OF FIRE OR ELECTRIC SHOCK, DO NOT EXPOSE THIS APPLIANCE TO RAIN OR MOISTURE. DANGEROUS HIGH VOLTAGES ARE PRESENT INSIDE THE ENCLOSURE. DO NOT OPEN THE CABINET. REFER SERVICING TO QUALIFIED PERSONNEL ONLY.

Important Safety Instruction

1. Do not block any ventilation openings. To ensure reliable operation of the projector and to protect from over heating, it is recommended to install the projector in a location that does not block ventilation. As an example, do not place the projector on a crowded coffee table, sofa, bed, etc. Do not put the projector in an enclosure such as a book case or a cabinet that restricts air flow.
2. Do not use the projector near water or moisture. To reduce the risk of fire and/or electric shock, do not expose the projector to rain or moisture.
3. Do not install near heat sources such as radiators, heaters, stoves or any other apparatus such as amplifiers that emit heat.
4. Clean only with dry cloth.
5. Only use attachments/accessories specified by the manufacturer.
6. Do not use the unit if it has been physically damaged or abused.
Physical damage/abuse would be (but not limited to):
 - Unit has been dropped.
 - Power supply cord or plug has been damaged.
 - Liquid has been spilled on to the projector.
 - Projector has been exposed to rain or moisture.
 - Something has fallen in the projector or something is loose inside.Do not attempt to service the unit yourself. Opening or removing covers may expose you to dangerous voltages or other hazards. Please call InFocus before you send the unit for repair.
7. Do not let objects or liquids enter the projector. They may touch dangerous voltage points and short out parts that could result in fire or electric shock.
8. See projector enclosure for safety related markings.
9. The unit should only be repaired by appropriate service personnel.

Intended Use Statement

- Operation temperature:
 - For 0 - 2500 ft, 5 °C ~ 40 °C
 - For 2500 - 5000 ft, 5 °C ~ 35 °C
 - For 5000 - 10000 ft, 5 °C ~ 30 °C
- Maximum Humidity:
 - Operating: 10%~80%RH (Max.), Non-condensing
 - Storage: 5%~95% RH, Non-condensing

The ambient operating environment should be free of airborne smoke, grease, oil and other contaminants that can affect the operation or performance of the projector.

Use of this product in adverse conditions will void the product warranty.

Safety Information

Please read, understand, and follow all safety information contained in these instructions prior to the use of this projector. Retain these instructions for future reference.

Explanation of Signal Word Consequences

- | |
|---|
| <p>⚠ Warning: Indicates a potentially hazardous situation, which, if not avoided, could result in death or serious injury and/or property damage.</p> <p>⚠ Caution: Indicates a potentially hazardous situation, which, if not avoided, may result in minor or moderate injury and/or property damage.</p> <p>⚠ Warning: Hazardous voltage</p> |
|---|

⚠ Warning

To reduce the risk associated with hazardous voltage:

- Do not modify this product in any way.
- Do not attempt to service this projector.
- There are no user-serviceable parts. Service to be performed only by a InFocus authorized service provider using InFocus approved system components.

To reduce the risk associated with fire and explosion:

- Do not immerse the projector in any liquid or allow to get wet.

To reduce the risks associated with choking:

- Keep all small parts like the remote control battery away from young children and pets.

To reduce the risk associated with hazardous voltage, impact, tripping, and intense visible light:

- Do not use this projector around unsupervised children.

⚠ Caution

To reduce the risks associated with hearing loss:

- Be sure to read earphone manufacturer's instructions with respect to volume level.
- User is responsible to set a safe volume level.

To reduce the risk associated with explosion, and/or chemicals from a leaking batteries:

- Use only with battery type CR2025.
- Orient the battery's plus (+) and minus (-) terminals of the batteries according to the markings found on the remote control.
- Do not leave the battery in the remote for an extended period of time.
- Do not heat or expose the battery to fire.
- Do not disassemble, short, or recharge battery
- Do not carry batteries loose in your pocket or purse.
- Avoid eye and skin contact in the event that the battery leaks.
- Do not recharge the battery near a heat source or in extremely hot conditions.

To reduce the risk associated with environmental contamination:

- Dispose of all system components in accordance with applicable government regulations.

To reduce the risks associated with LED bright light:

- Do not stare directly into the projector lens.

To reduce the risks associated with tripping and falling:

- Position the power cord and data cables so that they are not a tripping hazard.

Important Note: *Do not expose the projector to direct sunlight in a closed space such as a vehicle.*

SAVE THESE INSTRUCTIONS

Safety Labels

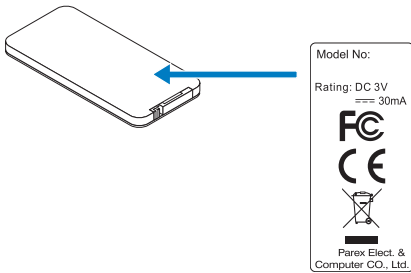

Trademarks

InFocus and the InFocus logo are trademarks of InFocus Corporation.

Adobe and the Adobe logo are either registered trademarks or trademarks of Adobe Systems Incorporated in the United States and/or other countries.

Microsoft, PowerPoint, and Excel are registered trademarks of Microsoft Corporation.

All other trademarks or registered trademarks are property of their respective companies.

Video and Audio Decoder Notices

MPEG-4 NOTICE

This product is licensed under the mpeg-4 visual patent portfolio license for the personal and non-commercial use of a consumer for (i) encoding video in compliance with the mpeg-4 visual standard ("mpeg-4 video") and/or (ii) decoding mpeg-4 video that was encoded by a consumer engaged in a personal and noncommercial activity and/or was obtained from a video provider licensed by mpeg la to provide mpeg-4 video. No license is granted or shall be implied for any other use. Additional information including that relating to promotional, internal and commercial uses and licensing may be obtained from mpeg la, llc. See <http://www.mpegla.com>.

AVC VIDEO NOTICE

This product is licensed under the avc patent portfolio license for the personal and noncommercial use of a consumer to (i) encode video in compliance with the avc standard ("avc video") and/or (ii) decode avc video that was encoded by a consumer engaged in a personal and non-commercial activity and/or was obtained from a video provider licensed to provide avc video. No license is granted or shall be implied for any other use. Additional information may be obtained from mpeg la, I.L.C. See <http://www.mpegla.com>.

MPEG LAYER-3 NOTICE

Supply of this product does not convey a license nor imply any right to distribute MPEG Layer-3 compliant content created with this product in revenue-generating broadcast systems (terrestrial, satellite, cable and/or other distribution channels), streaming applications (via Internet, intranets and/or other networks), other content distribution systems (pay-audio or audio-on-demand applications and the like) or on physical media (compact discs, digital versatile discs, semiconductor chips, hard drives, memory cards and the like). An independent license for such use is required.

For details, please visit <http://mp3licensing.com>.

Regulatory Notices

FCC STATEMENT - CLASS B

This equipment generates, uses and can radiate radio frequency energy, and if not installed and used in accordance with the instruction manual may cause interference to radio communications. It has been tested and found to comply with the limits for a Class “B” computing device pursuant to Subpart B of Part 15 of the FCC Rules, which are designed to provide reasonable protection against such interference when operated in a residential installation. However, there is no guarantee that interference will not occur in a particular installation. If this equipment does cause harmful interference to radio or television reception, which can be determined by turning the equipment off and on, the user is encouraged to try to correct the interference by one or more of the following measures:

- Reorient or relocate the receiving antenna.
- Increase the separation between the equipment and receiver.
- Connect the equipment into an outlet on a circuit different from that to which the receiver is connected.
- Consult the dealer or an experienced radio/TV technician for help.

NOTICE: This Class B digital apparatus complies with Canadian ICES-003.

Cet appareil numérique de la classe B est conforme à la norme NMB-003 du Canada.

Industry Canada regulatory information

Operation is subject to the following two conditions:

- (1) this device may not cause interference, and
- (2) this device must accept any interference, including interference that may cause undesired operation of the device.

The user is cautioned that this device should be used only as specified within this manual to meet RF exposure requirements. Use of this device in a manner inconsistent with this manual could lead to excessive RF exposure conditions.

INSTRUCTIONS TO USERS: This equipment complies with the requirements of FCC equipment provided that the following conditions are met. If the cables include a EMI ferrite core, attach the ferrite core end of the cable to the projector. Use the cables which are included with the projector or specified.

Note: *Changes or modifications not expressly approved by the party responsible for compliance could void the user's authority to operate the equipment.*

Complies with IDA Standards DA103121

CE Statement

Electromagnetic Compatibility Statement: Meets 2014/30/EU Directive

Low Voltage Directive: Meets 2014/35/EU Directive.

WEEE Statement

The following information is only for EU-member States:

The mark shown below is in compliance with Waste Electrical and Electronic Equipment Directive 2012/19/EU (WEEE). The mark indicates the requirement NOT to dispose of the equipment as unsorted municipal waste, but use the return and collection systems according to local law.



Do not stare into beam, RG2

As with any bright source, do not stare into the direct beam, RG2 IEC 62471-5:2015.

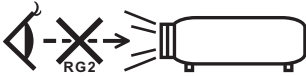

Introduction

Package Contents

Your projector comes with all the items shown below. Ensure that you have all the items, and contact your local reseller or service center if anything is missing.

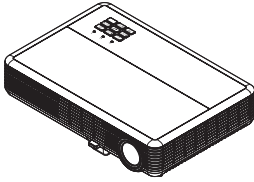

Projector



Lens cap

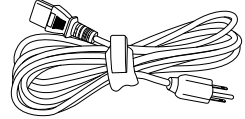

Power cable

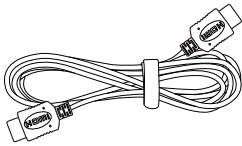

HDMI cable

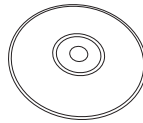

CD user manual

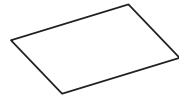

Quick Start Guide

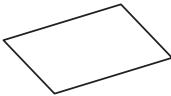

Warranty card



Carrying case



Remote control



CR2025 battery (optional)

About Your Projector

Main Unit

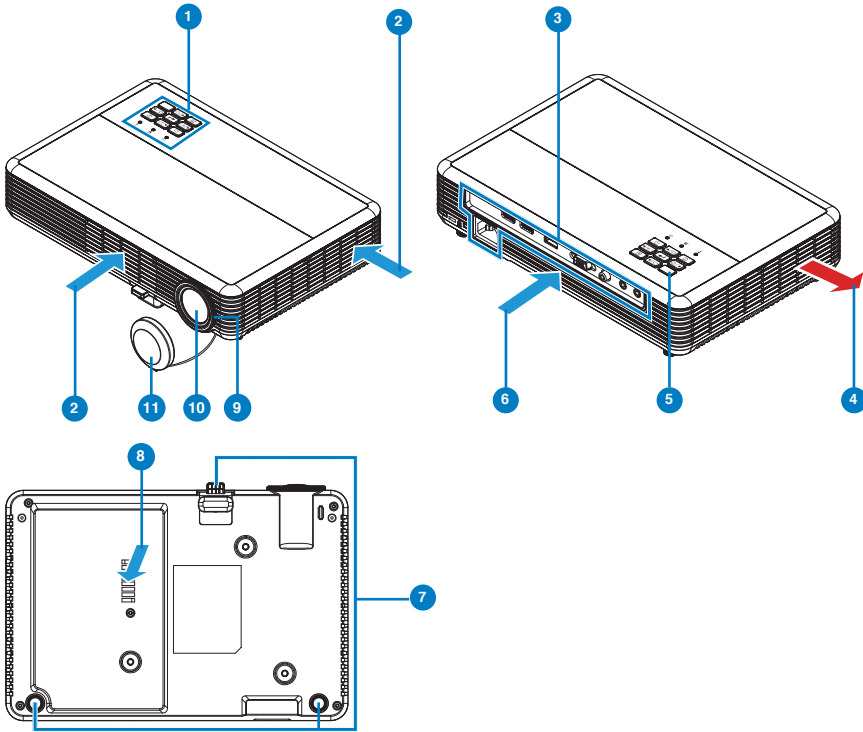

#	Description
1	Control panel
2	Ventilation (intake)
3	Input / Output connections
4	Ventilation (exhaust)
5	IR sensor
6	Ventilation (intake) (1080p model only)

#	Description
7	Tilt-adjustment feet
8	Ventilation (intake) (WXGA model only)
9	Focus ring
10	Lens
11	Lens cap

Note:

- Do not block projector intake and exhaust vents.
- When operating the projector in an enclosed space, allow at least 15cm clearance around the intake and exhaust vents.

Input / Output Connections

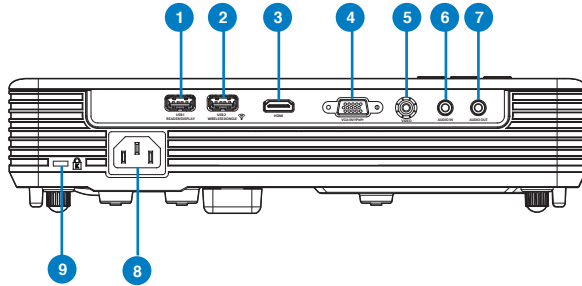

#	Description
1	USB1 Reader/Display connector*
2	USB2 Wireless Adapter connector*
3	HDMI connector
4	VGA-IN/YPbPr connector
5	VIDEO connector
6	AUDIO IN connector
7	AUDIO OUT connector
8	Power socket
9	Kensington™ Lock

Note:

* Both File Reader and Wireless Adapter USB A connectors support up to USB 2.0 and 5V/1A power. In addition, USB2 supports Wireless adapter.

* Use the USB connectors for firmware upgrade or for multimedia applications as follows:

- **Wireless Display:** Plug the optional Wireless adapter in USB2. Use the EZCast Pro application on your phone, tablet or computer to project.
- **Multimedia:** Display photos, movies, documents and play music files from a USB drive plugged into USB1.



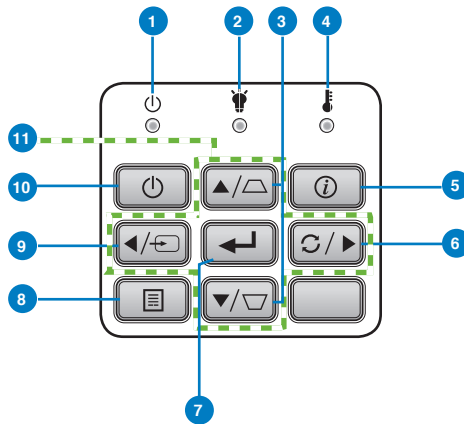

Control Panel

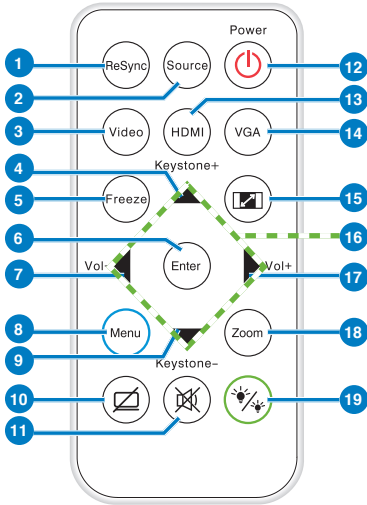

#	Name	Description
1	Power LED	Indicates the projector's power status. Please refer to "Status Indicators" for more information on Power LED behavior.
2	Illumination LED	Indicates the projector's LED status. Please refer to "Status Indicators" for more information on Illumination LED behavior.
3	Keystone Correction	Adjusts the image to compensate for distortion caused by tilting the projector (vertical/horizontal ± 40 degrees). Auto Keystone correction is on by default.
4	Temp LED	Indicates the projector's temperature status. Please refer to "Status Indicators" for more information on Temp LED behavior.
5	Information	Displays the projector information.
6	Re-Sync	Automatically synchronizes the projector to the input source.
7	Enter	Press to confirm the selection item.
8	Menu	Press to activate the On-Screen Display (OSD) Menu. Use the directional keys and the Menu button to navigate through the OSD.
9	Source	Press to select the desired input source.
10	Power	Turns the projector on or off.
11	Four Directional Select Keys	Press to navigate through the OSD Menu items.

Remote Control



#	Name	Description
1	ReSync	Press to automatically synchronize the projector to the input source.
2	Source	Press to select an input signal.
3	Video	Press to choose the video source.
4	Keystone +	Press to adjust image distortion caused by tilting the projector.
5	Freeze	Press to freeze and unfreeze the displayed image.
6	Enter	Press to confirm the selected item.
7	Vol -	Press to decrease the volume.
8	Menu	Press to activate the OSD Menu.
9	Keystone -	Press to adjust image distortion caused by tilting the projector.
10	Hide 	Momentarily turns off/on the video.
11	Mute 	Press to mute or unmute audio.
12	Power 	Turns the projector on or off.
13	HDMI	Press to choose HDMI source.
14	VGA	Press to choose VGA source.
15	Aspect 	Press to change aspect ratio of a displayed image.
16	Up/Down/Left/Right	Press to navigate through the OSD Menu items.
17	Vol +	Press to increase the volume.
18	Zoom	Zoom the projected image in or out.
19	Display Mode 	Allows you to select the display mode.

Installing the Remote Control Battery

1. Remove the battery holder by holding down the side release firmly and pulling out the battery holder.
2. Insert a CR2025 coin cell battery and align the polarity correctly according to the marking in the battery holder.

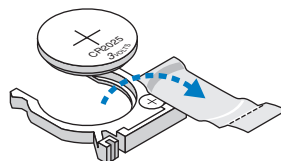
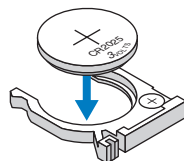
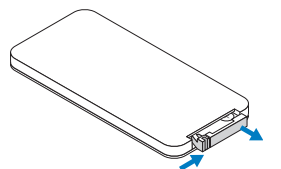

3. Replace the battery holder.

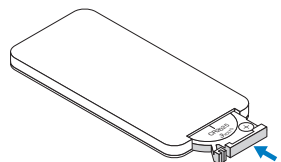

Operating Range with Remote Control

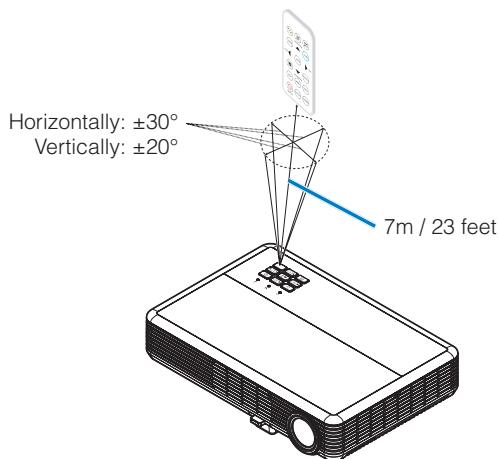

Note:

- Actual operating range may slightly differ from the diagram. A weak battery can reduce the operating range.
- When pointing the remote control directly (0 degrees angle) on the IR sensor, the distance between the remote control and the sensor should not exceed 10 meters (~ 33 feet).

Installation

Connecting to a Computer

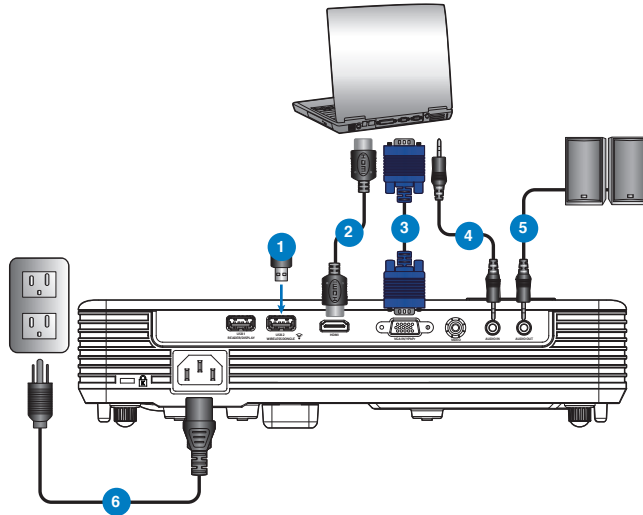

#	Description
1	Wireless adapter (*)
2	HDMI cable
3	VGA cable (*)
4	Audio in cable (*)
5	Audio out cable (*)
6	Power cord

Note: (*) The accessory is not shipped with your projector.

Connecting to a DVD Player

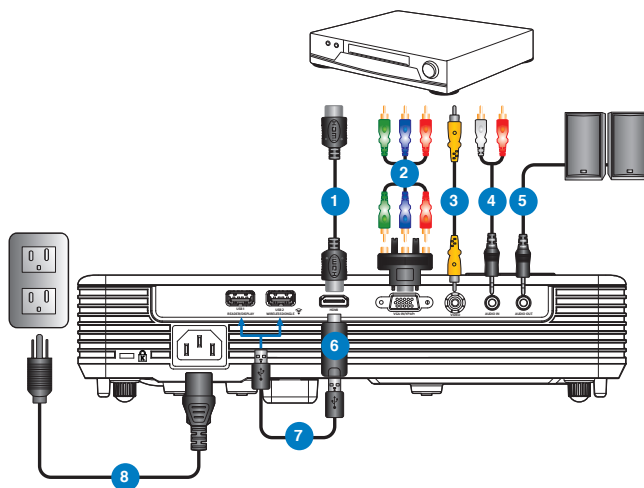

#	Description
1	HDMI cable
2	RCA component cable (*)
3	Video cable (*)
4	Audio input cable (*)
5	Audio out cable (*)
6	HDMI stick (*)
7	USB power cable (*)
8	Power cord

Note: (*)The accessory is not shipped with your projector.

Connecting to Multi-Media

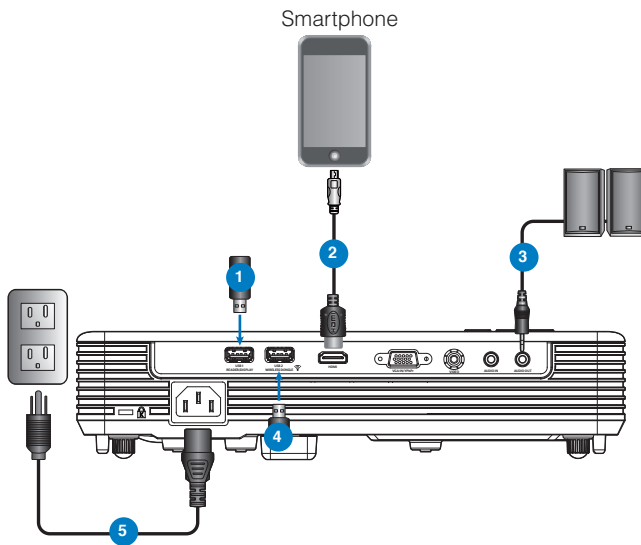

Description

- 1 USB drive (*)
- 2 USB video adapter (*)
- 3 Audio out cable (*)
- 4 Wireless adapter (*)
- 5 Power cord

Note: (*) *The accessory is not shipped with your projector.*

Turning On/Off the Projector

Turning Your Projector On

Note: Turn on the projector before you turn on the source (computer, DVD player, etc.). The Power LED is lighted solid red until the **Power** button is pressed.

1. Connect the power cord and appropriate signal cables to the projector.
2. Remove the lens cap.
3. Press the **Power** button. The Power LED will blink blue.
4. Turn on your source (computer, DVD player, etc).
5. Connect your source to the projector using the appropriate cable.
6. The input source is determined by the last connected input source. (By default, the input source of the projector is set to HDMI). Change the input source of the projector if necessary.

Turning Your Projector Off

Note: The "Press power key again." message will be displayed. The message times out after 5 seconds or press the **Menu** button to clear it.

1. Press the **Power** button. Follow the instruction displayed on screen to properly turn off the projector.
2. Press the **Power** button again. The cooling fans continue to operate for 3~5 seconds.

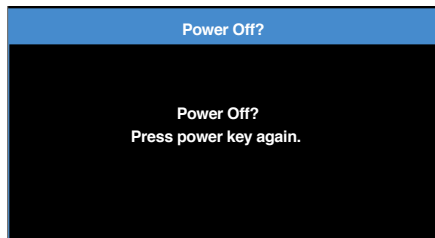

3. Disconnect the power cord from the electrical outlet and the projector.

Adjusting the Projected Image

The projector is equipped with tilt-adjustment feet for adjusting the image height.

1. Press the tilt-adjustment foot release button. **1**
Hold the release button to adjust the height then release to lock. **2**
2. Rotate the rear feet counter clockwise to raise the projector or clockwise to lower it. **3**

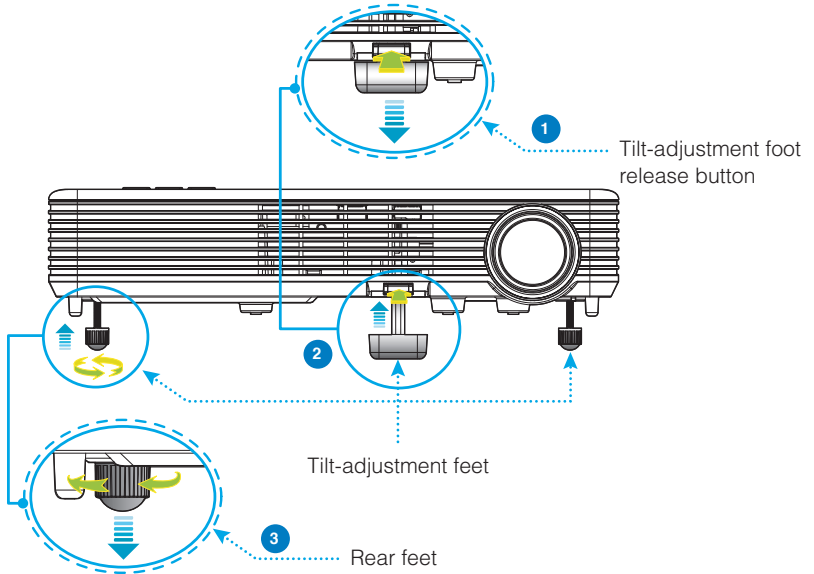

Important Note: To avoid damaging the projector, ensure that the tilt-adjustment feet are fully retracted before moving the projector or placing the projector in its carrying case.

360° Projection Capability

Images can be projected over a full 360° range along the vertical axis, including reproduction on a ceiling or floor.

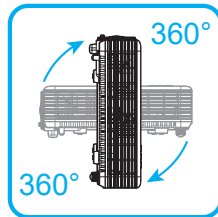

Adjusting Projection Image Size

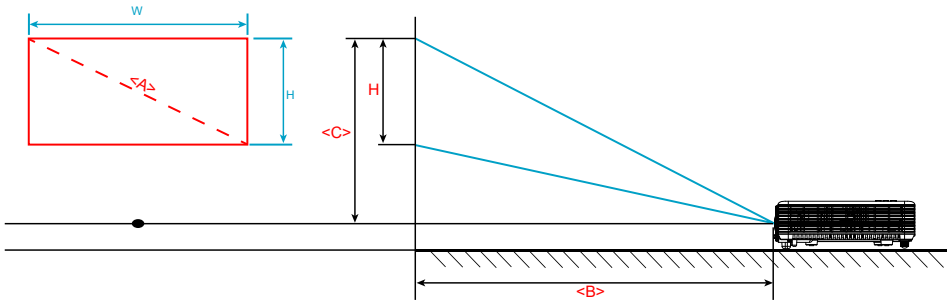

WXGA model







Desired image size		Distance (m)	Top (cm)
Diagonal (inch) <A>	W (cm) x H (cm)		From lens center to top of image <C>
30	65 x 40	0.8	41.2
40	86 x 54	1.1	55.6
50	108 x 67	1.4	69
60	129 x 81	1.6	83.4
70	151 x 94	1.9	96.8
80	172 x 108	2.2	111.2
90	194 x 121	2.5	124.6
100	215 x 135	2.7	139.1
120	258 x 162	3.3	166.9
150	323 x 202	4.1	208.1
180	388 x 242	4.9	249.3
200	431 x 269	5.4	277.1
300	646 x 404	8.2	416.1

1080P model

Desired image size		Distance (m)	Top (cm)
Diagonal (inch) <A>	W (cm) x H (cm)		From lens center to top of image <C>
30	66 x 37	0.8	38.1
40	89 x 50	1.1	51.5
50	111 x 62	1.3	63.9
60	133 x 75	1.6	77.3
70	155 x 87	1.9	89.6
80	177 x 100	2.1	103
90	199 x 112	2.4	115.4
100	221 x 125	2.7	128.8
120	266 x 149	3.2	153.5
150	332 x 187	4.0	192.6
180	398 x 224	4.8	230.7
200	443 x 249	5.3	256.5
250	553 x 311	6.6	320.3
300	664 x 374	8.0	385.2

User Controls

Using the On-Screen Display

1. The projector has a multi-language On-Screen Display (OSD) Menu that can be displayed with or without an input source.
2. Press the  button on the control panel or the **Menu** button on the remote control to enter the Main Menu.
3. To select an option, press the  or  button on your projector's control panel or remote control.
4. Use the  or  button on the control panel or remote control to adjust the settings.
5. Press the **Enter** button on the remote control or the  button on the control panel to select highlighted menu items.
6. To exit the OSD, press the  button directly on the control panel or the **Menu** button on the remote control.

Main Menu (WXGA model)

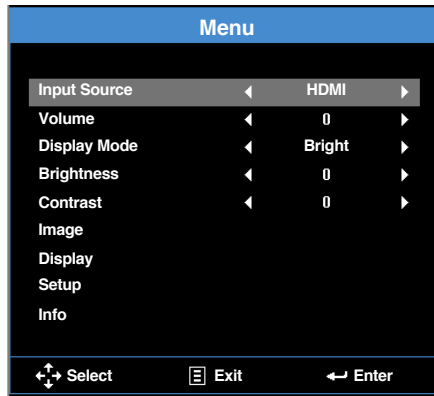

- **Input Source:** Select your projector's input source. The options are: **VGA**, **HDMI**, **Media**, and **Video**.
- **Volume:** Adjust the volume.
- **Display Mode:** Optimize the display image. The options are: **Bright**, **PC**, **sRGB**, **Cinema**, **Photo**, and **Eco**.
- **Brightness:** Adjust the display brightness.
- **Contrast:** Adjust the display contrast.

Image

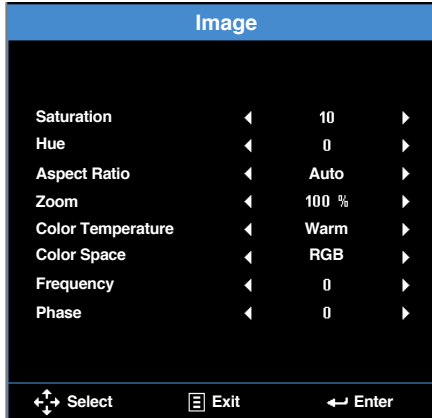

- **Saturation:** Adjust the saturation of the image.
Note: *Not available with computer sources.*
- **Hue:** Adjust the hue of the image.
Note: *Not available with computer sources.*
- **Aspect Ratio:** Adjust the aspect ratio to match the video source. Options are:
 - **Auto:** Automatically selects the appropriate display format.
 - **4:3:** The input source scales to fit the screen and projects a 4:3 image.
 - **16:9:** The input source scales to fit the screen and projects a 16:9 image.
 - **16:10:** The input source scales to fit the screen and projects a 16:10 image.
- **Zoom:** Zoom in or out of the image. Options are **50%**, **75%**, **100%**, **125%**, **150%**.
- **Color Temperature:** Select the color temperature. Options are: **Warm**, **Medium**, and **Cold**.
Note: *The Color Temperature function is not supported in Bright, Eco, and 3D modes.*
- **Color Space:** Select an appropriate color matrix type. Options are: **Auto**, **RGB**, and **YCbCr**.
Note: *The Color Space function is supported only in HDMI mode.*
- **Frequency:** Change the display data clock frequency to match the frequency of your computer's graphics card. If you see a vertical flickering wave, use the Frequency control to minimize the bars. This is a coarse adjustment.
Note: *The Frequency can be adjusted only in VGA mode.*
- **Phase:** Synchronize the signal timing of the display with the graphic card. If the image appears to be unstable or flickers, use the Phase to correct it. This is a fine adjustment.
Note: *The Phase can be adjusted only in VGA mode.*

Display

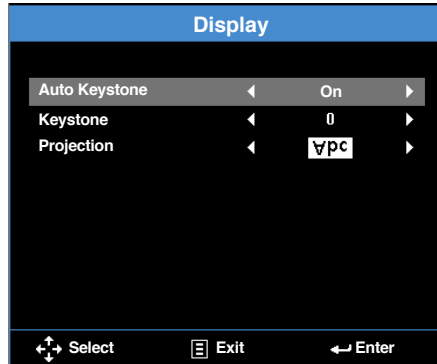

- **Auto Keystone:** Select **On** to automatically adjust image distortion caused by tilting the projector.

Note: The Auto Keystone function can be only used to adjust the image distortion vertically.

- **Keystone:** Adjust image distortion caused by tilting the projector (+/-40 degrees).

Note: If you adjust the keystone degrees manually then the Auto Keystone function will be automatically switched off.

- **Projection:** Select the projection mode, depending upon how the projector is mounted.

- **Auto Keystone:** On

Abc Direct projection

∩dA Rear projection

- **Auto Keystone:** Off

Abc Direct projection

∩dA Rear projection

Abc Ceiling mount projection

∩dA Ceiling mount rear projection

Setup

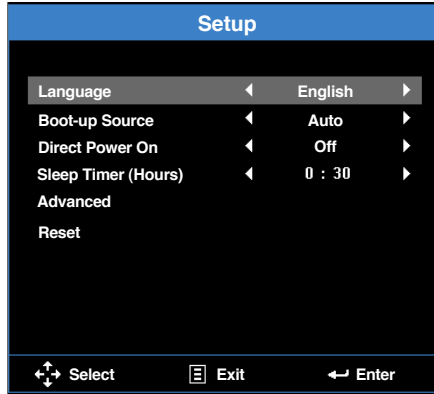

- **Language:** Set the language for the OSD.
- **Boot-up Source:** Select the projector's boot-up source. Options are: **Auto**, **VGA**, **Video**, **HDMI**, and **Media**.
Note: *If set to **Auto** the last source used will be displayed.*
- **Direct Power On:** Choose **On** to activate Direct Power mode. The projector will automatically power on when AC power is applied, without pressing the **Power** button on the projector control panel or on the remote control.
- **Sleep Timer (Hours):** Set the sleep timer duration. The sleep timer will start with or without a video source. The projector will automatically shut off after the selected time. Options are: **Auto**, **Off**, **0.5**, **1**, **3**, **8**, **12**.
Note: *If the Sleep Timer is set to "Auto" then the projector will automatically power off after 15 minutes if no video source has been detected.*
- **Reset:** Reset all settings to the factory default, including computer sources and video source settings. After choosing this option, a confirmation message appears on the screen. Select **Yes** to confirm or **No** to cancel reset.

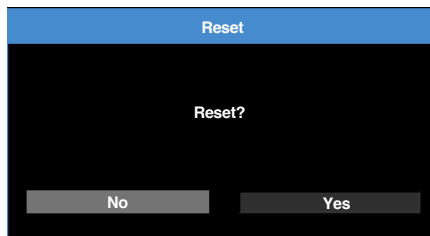

Setup > Advanced

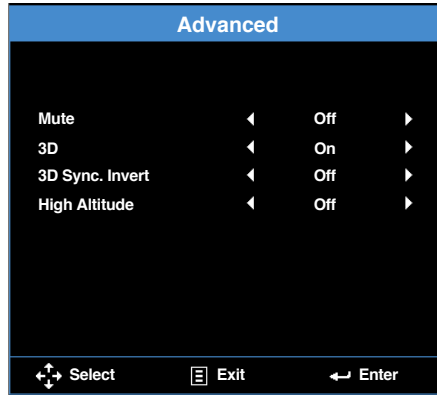

- **Mute:** Turn the mute function on or off.
- **3D:** Turn the 3D function on or off.
- **3D Sync. Invert:** Turn the 3D sync. inverter option on or off.

Note:

- 3D/3D Sync. Invert cannot be changed when you select image settings.
- In 3D mode, the maximum supported input timing is 1280 x 720 at 120Hz.

- **High Altitude:** Turn fans on high for high altitude environments.

Info

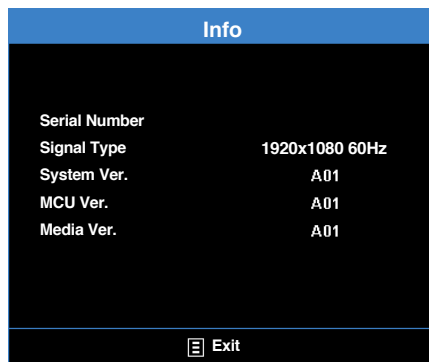

Review projector related information, such as **Serial Number**, **Signal Type**, **System Ver.**, **MCU Ver.**, and **Media Ver.**.

Main Menu (1080p model)

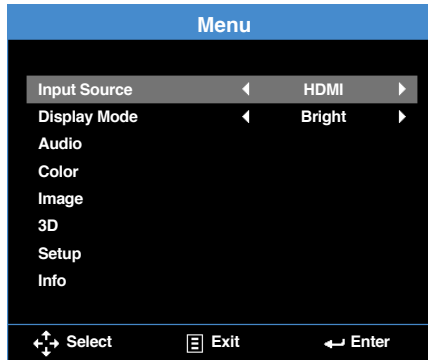

- **Input Source:** Select your projector's input source. The options are: **HDMI**, **VGA**, **Video**, and **Media**.
- **Display Mode:** Optimize the display image. The options are: **Bright**, **PC**, **sRGB**, **HDR** (High Dynamic Range), **Cinema**, **Photo**, **Eco.**, and **3D**.

Audio

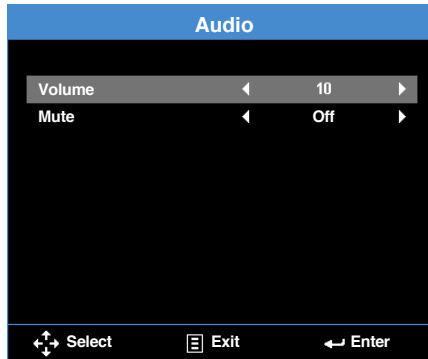

- **Volume:** Adjust the volume.
- **Mute:** Choose **On** to mute audio.

Color

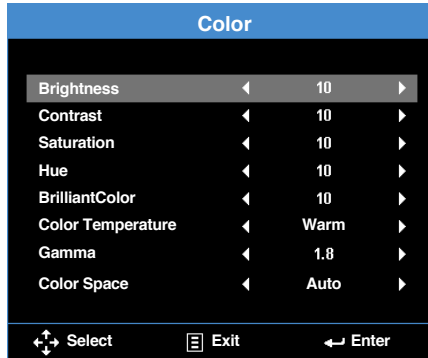

- **Brightness:** Adjust the display brightness.
- **Contrast:** Adjust the display contrast.
- **Saturation:** Adjust the saturation of the image.
Note: Only available with video sources.
- **Hue:** Adjust the hue of the image.
Note: Only available with video sources.
- **BrilliantColor™:** Enables higher brightness while providing true more vibrant colors in the image.
- **Color Temperature:** Select the color temperature. Options are: **Warm**, **Medium**, and **Cold**.
- **Gamma:** Set up gamma curve type. Options are: 1.8, 2.0, 2.2, 2.4, and 3D.
- **Color Space:** Select an appropriate color matrix type. Options are: **Auto**, **RGB**, and **YCbCr**.

Note: The Color Space function is supported only in HDMI mode.

Image

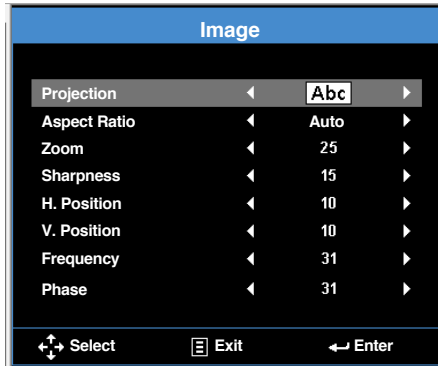

- **Projection:** Select the projection mode, depending upon how the projector is mounted.
 - **Auto Keystone:** On. See Setup Menu.
 - Abc** Direct projection
 - dA** Rear projection
 - **Auto Keystone:** Off
 - Abc** Direct projection
 - dA** Rear projection
 - bcA** Ceiling mount projection
 - pcA** Ceiling mount rear projection
- **Aspect Ratio:** Adjust the aspect ratio to match the video source. Options are:
 - **Auto:** Automatically selects the appropriate display format.
 - **16:9:** The input source scales to fit the screen and projects a 16:9 image.
 - **4:3:** The input source scales to fit the screen and projects a 4:3 image.
- **Zoom:** Zoom in or out of the image.
- **Sharpness:** Adjust the sharpness of the image.
- **H. Position:** Shift the projected image position horizontally.
- **V. Position:** Shift the projected image position vertically.
- **Frequency:** Change the display data clock frequency to match the frequency of your computer's graphics card. If you see a vertical flickering wave, use the Frequency control to minimize the bars. This is a coarse adjustment.

Note: *The Frequency can be adjusted only in VGA mode.*

- **Phase:** Synchronize the signal timing of the display with the graphic card. If the image appears to be unstable or flickers, use the Phase to correct it. This is a fine adjustment.

Note: *The Phase can be adjusted only in VGA mode.*

3D

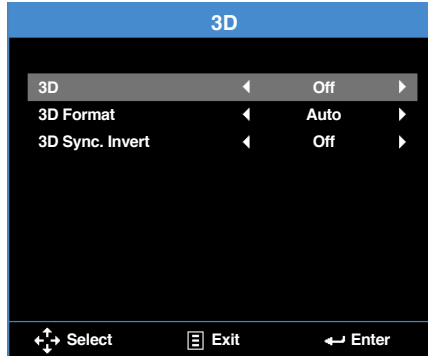

- **3D:** Turn the 3D function on or off.
- **3D Format:** Set up the 3D format according to the 3D input signal. Options are: **Auto**, **Frame Packing**, **Side by Side Half**, **Side by Side Full**, **Top and Bottom**, and **Frame Sequential**.
- **3D Sync. Invert:** Turn the 3D sync. inverter option on or off.

Note: *3D/3D Sync. Invert cannot be changed when you select image settings.*

Setup

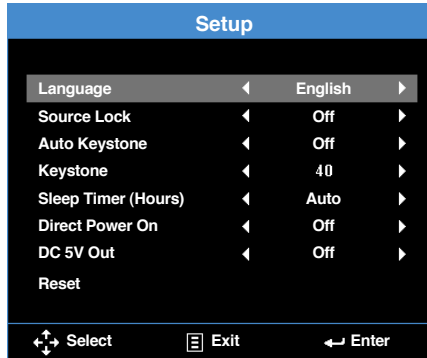

- **Language:** Set the language for the OSD.
- **Source Lock:** Select **On** to lock the current source as the only available source, even if the cable is unplugged.
- **Auto Keystone:** Select **On** to automatically adjust image distortion caused by tilting the projector.
Note: *The Auto Keystone function can be only used to adjust the image distortion vertically.*
- **Keystone:** Adjust image distortion caused by tilting the projector (+/-40 degrees).
Note: *If you adjust the keystone degrees manually then the Auto Keystone function will be automatically switched off.*
- **Sleep Timer (Hours):** Set the sleep timer duration. The sleep timer will start with or without a video source. The projector will automatically shut off after the selected time. Options are: **Auto, Off, 0.5, 1, 3, 8, 12.**
Note: *If the Sleep Timer is set to "Auto" then the projector will automatically power off after 15 minutes if no video source has been detected.*
- **Direct Power On:** Choose **On** to activate Direct Power mode. The projector will automatically power on when AC power is applied, without pressing the **Power** button on the projector control panel or on the remote control.
- **DC 5V Out:** Choose **On** to enable DC 5V output function when using either of the USB connectors: USB1 or USB2.

- **Reset:** Reset all settings to the factory default, including computer sources and video source settings. After choosing this option, a confirmation message appears on the screen. Select **Yes** to confirm or **No** to cancel reset.

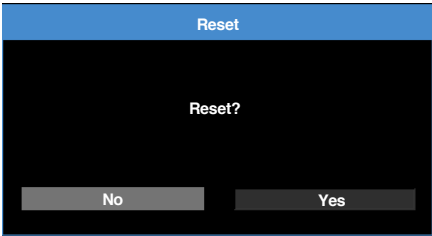

Info

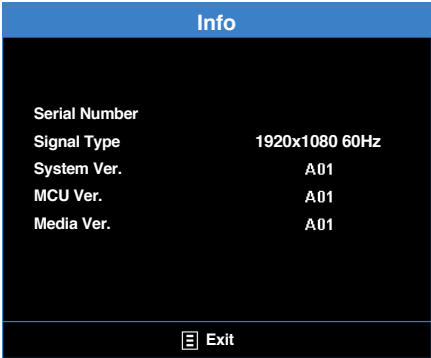

Review projector related information, such as **Serial Number**, **Signal Type**, **System Ver.**, **MCU Ver.**, and **Media Ver.**.

Multi-Media Introduction

Multi-media format supported:

Photo Format

Image Type (Ext Name)	Sub Type	Encode Type	Max Size
Jpeg / Jpg	Baseline	YUV420	6000x4000=24MP
		YUV422	
		YUV440	
		YUV444	
	Progressive	YUV420	6000x4000=24MP
		YUV422	
		YUV440	
		YUV444	
BMP			6000x4000=24MP

Video Format

File Format	Video Format	Decode Max res.	Max Bit Rate (bps)	Audio Format	Profile
MPG, MPEG	MPEG1/2	1920x1080 30fps	30M bps	MPEG1 L1-3, LPCM	
AVI, MOV, MP4, MKV	H.264	1920x1080 30fps	30M bps	MPEG1 L1-3, AAC,LPCM	BP (Baseline Profile)/ MP (Main Profile)/ HP (High Profile)
AVI, MOV, MP4	MPEG4	1920x1080 30fps	30M bps		SP(Simple Profile)/ ASP (Advanced Simple Profile)
AVI, MOV, MP4,	Xvid	1920x1080 30fps	30M bps		SP(Simple Profile)/ ASP (Advanced Simple Profile)
AVI	MJPEG	1920x1080 30fps	30Mbps		BP (Baseline Profile)

File Format	Video Format	Decode Max res.	Max Bit Rate (bps)	Audio Format	Profile
WMV	VC-1	1920x1080 30fps	30M bps	WMA8/9	SP (Simple Profile)/ MP (Main Profile)

Audio Format

Music Type (Ext Name)	Sample Rate (KHz)	Bit Rate (Kbps)
MP3	8-48	8-320
WMA	8-48	5-320
WAV (ADPCM-WAV)	8-48	32-384
WAV (PCM-WAV)	8-48	128-1536
AAC	8-48	8-320
M4A	8-48	8-320

Office Viewer Format

File Format	Supported Version	Page/Lines Limitation	Size Limitation
Adobe PDF	PDF 1.0, 1.1, 1.2, 1.3, 1.4	Up to 360 pages (one file)	Up to 32MB
MS Word	British Word 95	Because office viewer does not load all pages of MS Word file at the same time, there are not obvious limitations of page and line.	Up to 20MB
	Word 97, 2000, 2002, 2003		
	Word 2007(.docx)		Up to 30MB
	Word 2010(.docx)		
MS Excel	British Excel 5,95	Row Limit: up to 300	Up to 14MB
	Excel 97, 2000, 2002, 2003	Column Limit: up to 100	
	Excel 2007(.xlsx)	Sheet Limit: up to 50	
	Excel 2010(.xlsx)	Note: Any of the three limitations above can not appear in one excel file simultaneously.	
	Office XP Excel		

File Format	Supported Version	Page/Lines Limitation	Size Limitation
MS PowerPoint	PowerPoint 97	Up to 100 pages (One File)	Up to 19MB
	PowerPoint 2000, 2002, 2003		
	PowerPoint 2007(.pptx)		
	PowerPoint 2010(.pptx)		
	Office XP PowerPoint		
	PowerPoint presentation 2003 and earlier (.ppx)		
	PowerPoint presentation 2007 and 2010 (.ppsx)		

Note:

- *Animations are not supported when viewing MS PowerPoint files.*
- *When projecting files, some documents may not be displayed the same as shown on the screen of a PC.*

How to set-up File Type for Multi-Media with USB

Note:

1. A USB flash disk must be plugged into the projector if you want to use the multimedia USB function.
2. Please do not connect a camera to USB port in order to avoid compatibility issues.

Follow these steps to playback the Photo, Video, Music, or Office files on your projector:

1. Connect the power cord to the projector and turn on the projector by pressing the **Power** button.

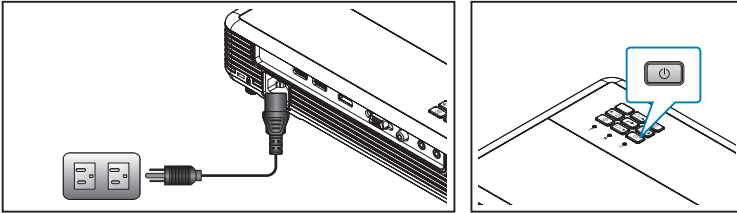

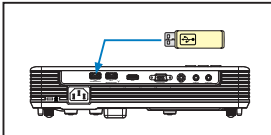

2. Plug a USB drive into USB-1.

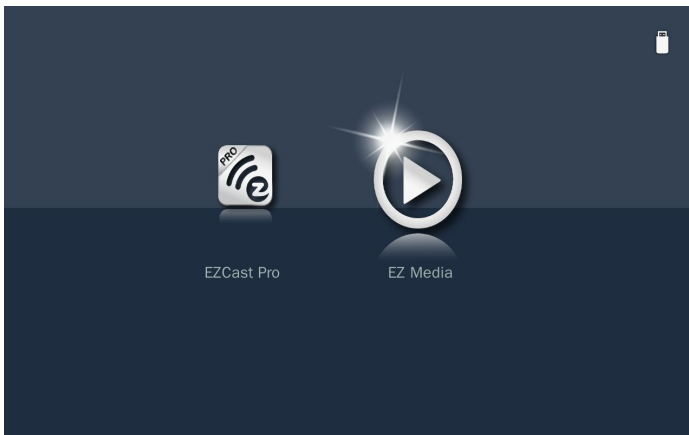

Select the **Media** source using the remote control or control panel on the projector. The Multi-Media menu opens.



Note: To open the projector Main Menu, hold the **Menu** button on the remote control or the  button on the control panel for longer than 1 second.

3. Select the **EZ Media** icon, and then press the **Enter** button on the remote control or the  button on the control panel.

The **EZ Media** menu opens.

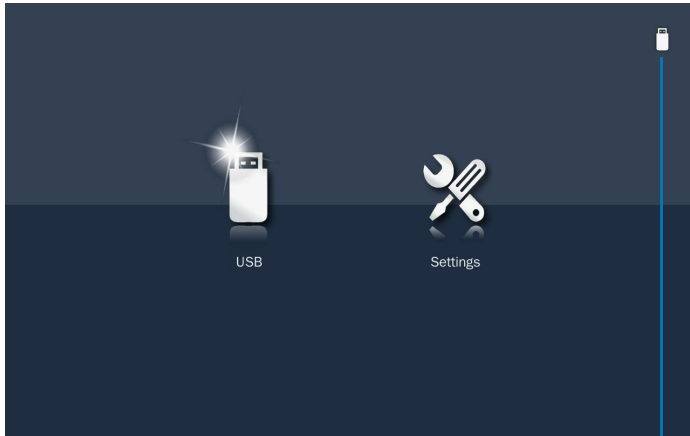

Note: The USB icon indicates if a USB disk is inserted in connector USB1.

4. Select USB to view files or select **Settings** to change media and system settings.
5. Select USB then select what kind of file to be opened: **Photo**, **Video**, **Music**, or **Office**.

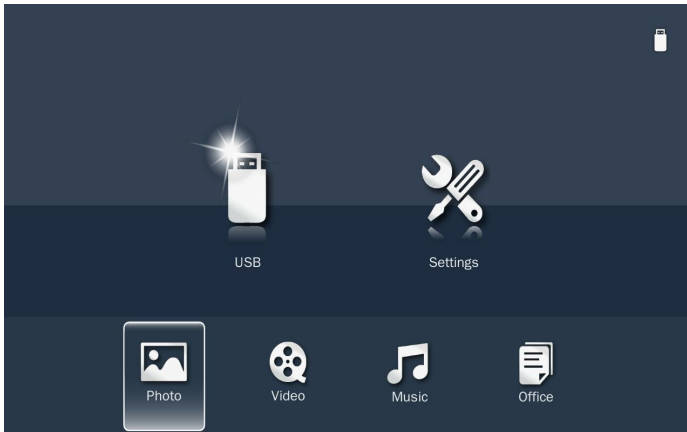

Note: The maximum allowed file name length is 28 characters.

Photo Viewer

When a **Photo** folder is selected thumbnails are displayed. Only folders with photos will be displayed.

Use the ◀ or ▶ button to select the folder containing the photo you want to display, and then press the ↵ button on the control panel or the **Enter** button on the remote control.

Note: To return to the previous folder or to exit the **Photo viewer**, press the **Menu** button on the remote control or the ☰ button on the control panel.

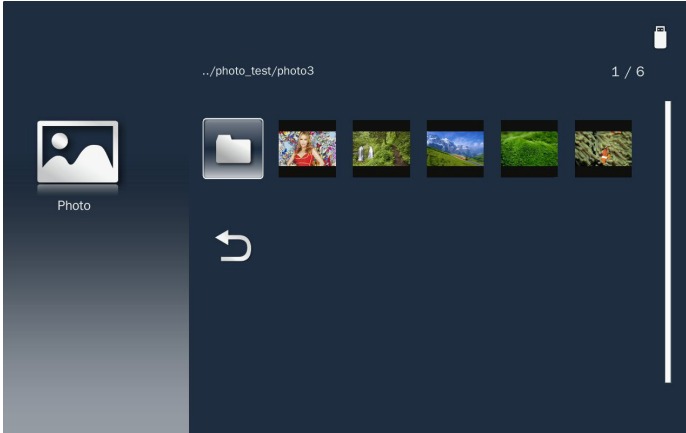

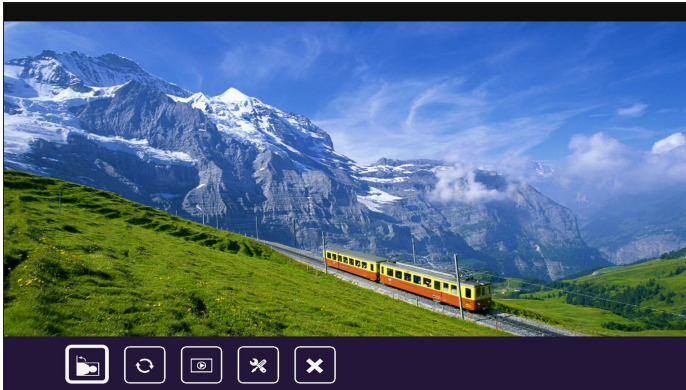

Highlight the thumbnail of the photo you want to display and press the ↵ button on the control panel or the **Enter** button on the remote control to display a full size image.



While viewing a photo file, you can control playback using the control command bar icons on the bottom of the screen. Press the ◀ or ▶ button to select the command and then press the ↵ button on the control panel or the **Enter** button on the remote control to execute the command.

🔄: Rotates the photo 90-degree clockwise.

🔄: Activates the repeat function. The photos will be automatically rotated during a slide show.

- : Starts the slide show.
- : Configures the slide show settings. Refer to page 45.
- : Exits playback and returns to the file list.

Video Viewer

When a **Video** folder is selected videos are displayed by filename. Only folders with photos will be displayed.

Use the ▲ or ▼ button to select the folder containing the video you want to view, and then press the ← button on the control panel or the **Enter** button on the remote control.

Note: To return to the previous folder or to exit the **Video** viewer, press the **Menu** button on the remote control or the  button on the control panel.

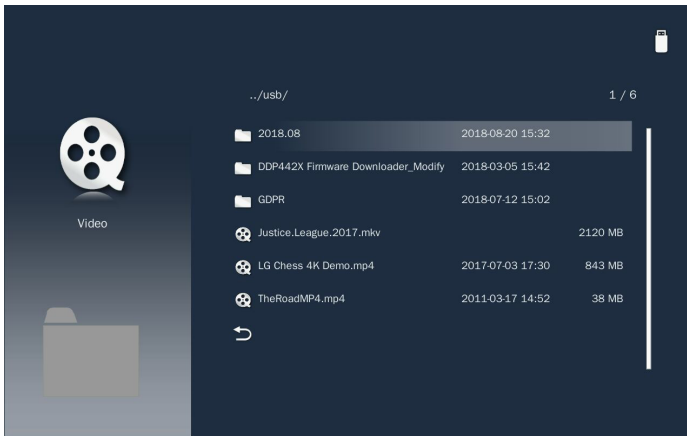









Highlight the desired video file and press the ← button on the control panel or the **Enter** button on the remote control to play it.



While playing a video file, you can control playback using the control command bar icons on the bottom of the screen. Press the ◀ or ▶ button to select the command and

then press the **↵** button on the control panel or the **Enter** button on the remote control to execute the command.

The commands are:

- : Goes to the previous video file.
- : Rewind playback. The speeds are 2x/4x/8x/16x.
- : Pauses playback; : Restarts playback.
- : Fast forward playback. The speeds are 2x/4x/8x/16x.
- : Goes to the next video file.
- : Configures the video settings. Refer to page 45.
- : Exits playback and returns to the file list.

Music Player

When a **Music** folder is selected music files are displayed by filename. Only folders with music will be displayed.

Use the **▲** or **▼** button to select the folder containing the music file you want to hear, and then press the **↵** button on the control panel or the **Enter** button on the remote control.

Note: To return to the previous folder or to exit the **Music** player, press the **Menu** button on the remote control or the  button on the control panel.

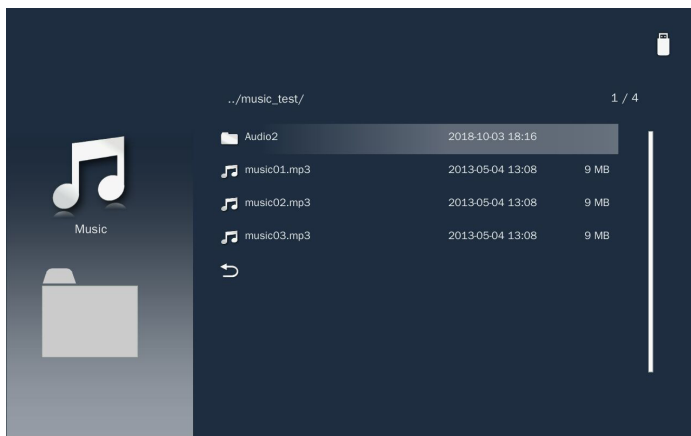

Choose a music file and press the **↵** button on the control panel or the **Enter** button on the remote control to play it.

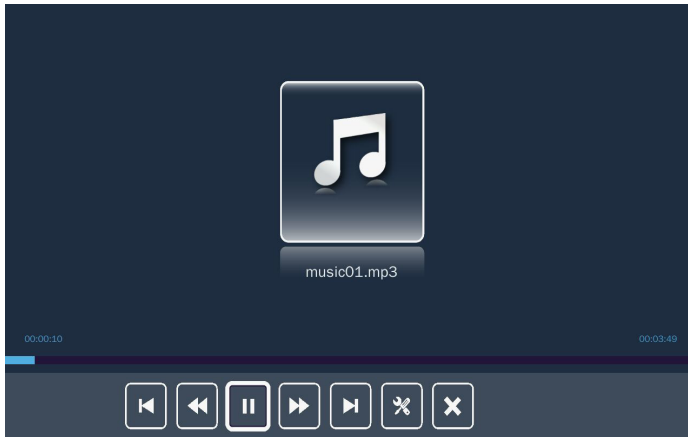

While playing a music file, you can control playback using the control command bar icons on the bottom of the screen. Press the ◀ or ▶ button to select the command and then press the ⏏ button on the control panel or the **Enter** button on the remote control to execute the command.

The commands are:

- ◀: Goes to the previous music file.
- ◀◀: Rewinds playback.
- ⏏: Pauses playback; ▶▶: Restarts playback.
- ▶▶: Fast forward playback.
- ▶: Goes to the next music file.
- ⚙: Configures the music settings. Refer to page 46.
- ✕: Exits playback and returns to the file list.

Office Viewer

When an **Office** folder is selected office files are displayed by filename. Only folders with office files will be displayed.

Note: *If you cannot see the desired office file in the folder, make sure the file format is supported. Please refer to page 35.*

Use the ▲ or ▼ button to select the folder containing the office document you want to view, and then press the ⏏ button on the control panel or the **Enter** button on the remote control.

Note: *To return to the previous folder or to exit the **Office** viewer, press the **Menu** button on the remote control or the ☰ button on the control panel.*

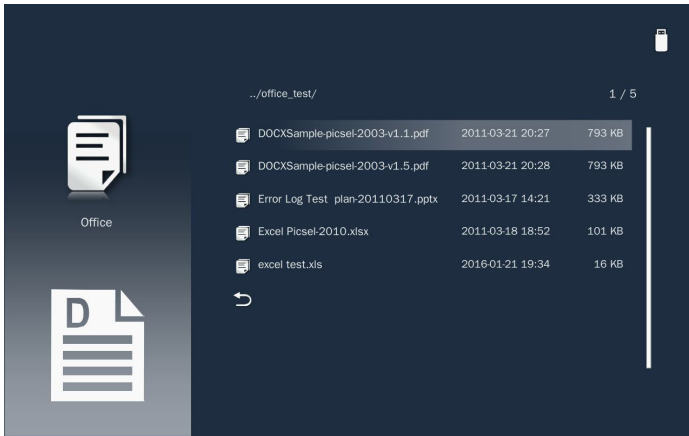

Choose an office file and press the **←** button on the control panel or the **Enter** button on the remote control to open it on the screen.

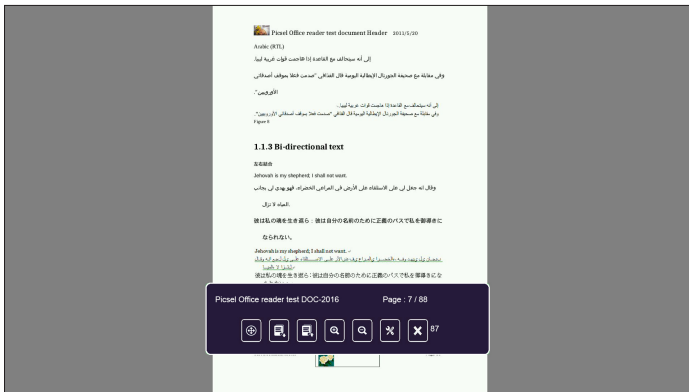

While viewing an office file, you can control playback using the control command bar icons on the bottom of the screen. Press the **←** or **→** button to select the command and then press the **←** button on the control panel or the **Enter** button on the remote control to execute the command.

The commands are:

- : Navigates the page.
- : Goes to the previous page.
- : Goes to the next page.
- : Zooms in on a page.
- : Zooms out on a page.
- : Configures the office settings. Refer to page 47.
- : Exits playback and returns to the file list.

Multi-Media Settings for System and USB

The multi-media settings menu allows you to change settings for **System**, **Photo**, **Video**, and **Music**.

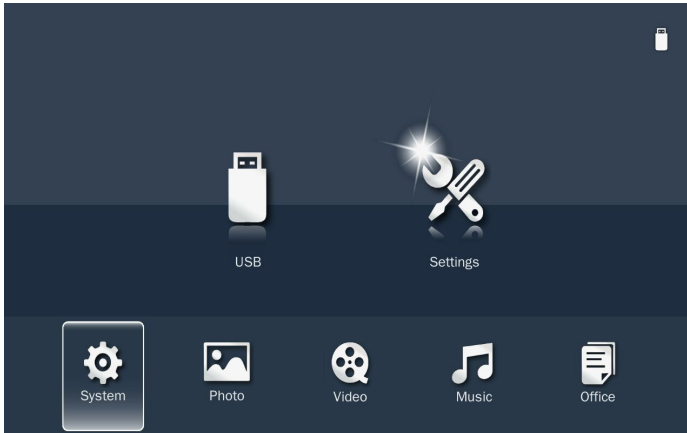

System Settings

Access the system settings menu. The system settings menu provides the following options:

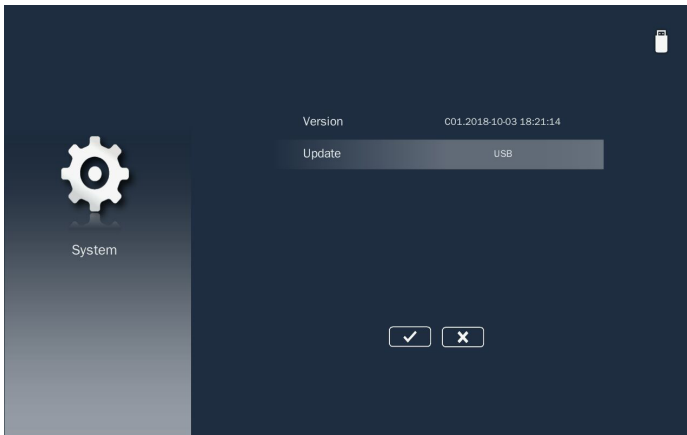

■ **Version**

Displays the **Media** firmware version.

■ **Update**

Update the multimedia firmware only from the **USB** drive.

Note: Choose and press the **↵** button on the control panel or the **Enter** button on the remote control to save the settings and exit the menu or choose and press the **↵** button on the control panel or the **Enter** button on the remote control to exit the menu without saving the settings.

Photo Settings

Access the photo settings menu. The photo settings menu provides the following options:

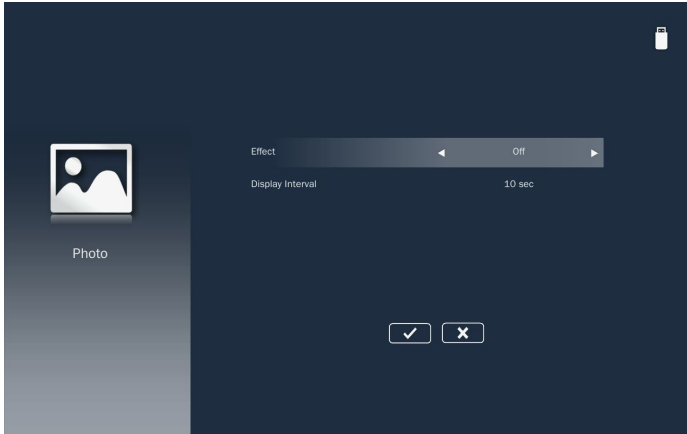

■ Effect

Select the slide transition effect for the slideshow. Options are: **Off**, **Mode A**, **Mode B**, or **Mode C**.

■ Display Interval

Select the slideshow duration. Options are: **10 sec**, **30 sec**, or **1 min**. The image will automatically switch to the next photo after the time out.

Note: Choose and press the \leftarrow button on the control panel or the **Enter** button on the remote control to save the settings and exit the menu or choose and press the \leftarrow button on the control panel or the **Enter** button on the remote control to exit the menu without saving the settings.

Video Setup

Access the video settings menu. The video setting menu provides the following option:

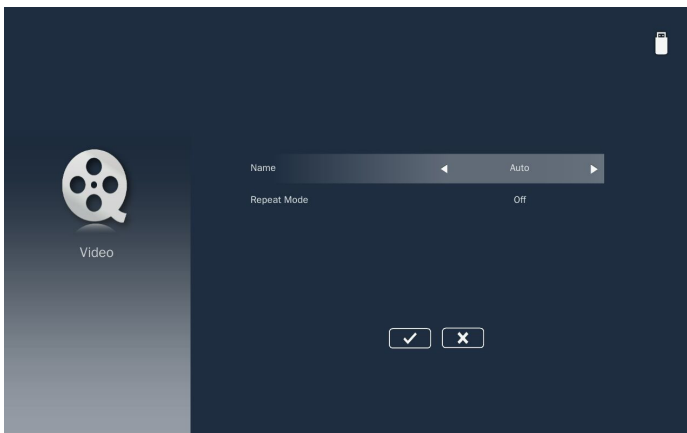

■ Display Ratio

Select the display ratio of the video.

- **Auto:** The resolution of the video image is detected automatically.
- **Full screen:** Regardless the native aspect ratio, the video image is stretched non-linearly in the horizontal and vertical directions to exactly fit the screen. You will not see the "black bars" around the video image but the proportions of the original content may be distorted.

■ Repeat Mode

Select the video repeat mode. Options are: **Sequence**, **Single**, **Random**, or **Off**.

Note: Choose and press the **↵** button on the control panel or the **Enter** button on the remote control to save the settings and exit the menu or choose and press the **↵** button on the control panel or the **Enter** button on the remote control to exit the menu without saving the settings.

Music Setup

Access the music settings menu. The music settings menu provides the following option:

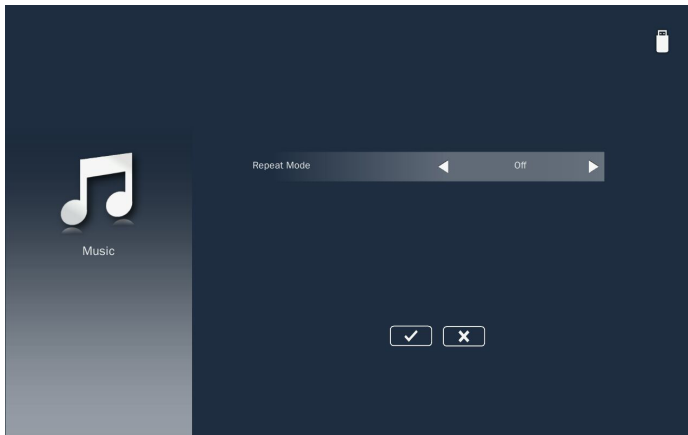

■ Repeat Mode

Select the music play mode. Options are: **Sequence**, **Single**, **Random**, or **Once**.

Note: Choose and press the **↵** button on the control panel or the **Enter** button on the remote control to save the settings and exit the menu or choose and press the **↵** button on the control panel or the **Enter** button on the remote control to exit the menu without saving the settings.

Office Setup

Access the office settings menu. The office settings menu provides the following option:

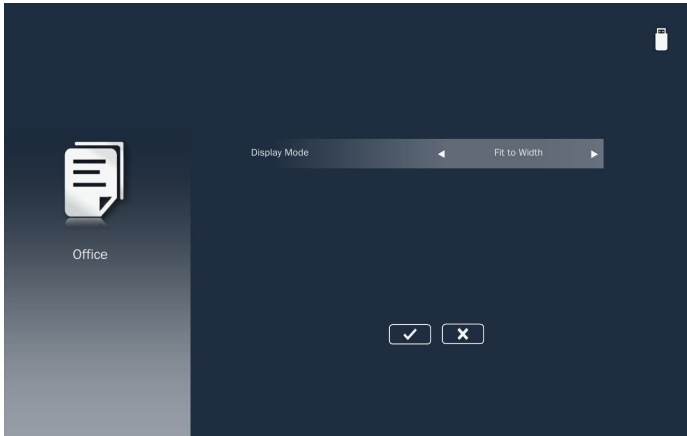

■ **Display Mode**

Select the document display mode. Options are: **Fit to Width**, **Fit to Height**, or **Fit to Screen**.

Mirroring the Screen of a Portable Device

Follow these steps to mirror the screen of your portable device:

1. Connect the power cord to the projector and turn on the projector by pressing the **Power** button.

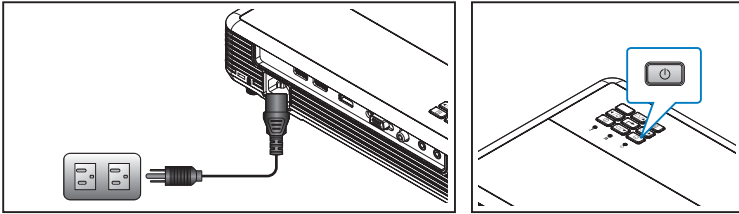

Select the **Media** source using the remote control or control panel on the projector. The Multi-Media menu opens.

2. Select the **EZCast Pro** icon and press the **Enter** button on the remote control or press the **↵** button on the control panel.

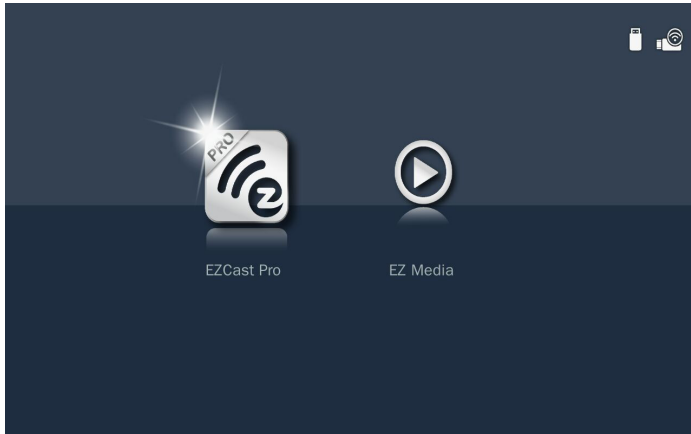

The **EZCast Pro** menu opens.

A blue icon indicates mobile devices are connected to the projector.

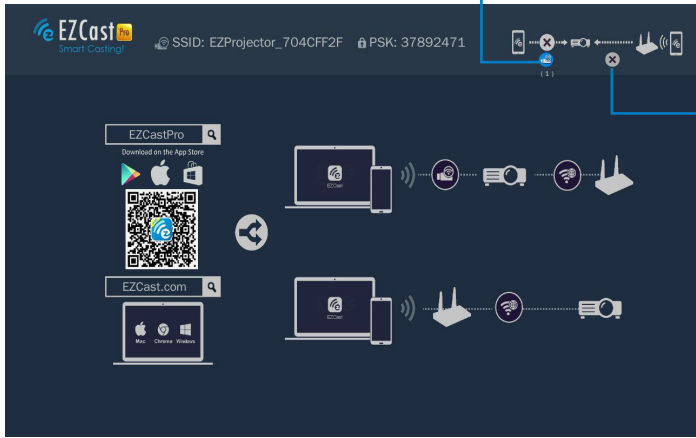

If this icon is blue it indicates the projector is connected to an Access Point.

3. Do one of the following:

- Depending on the operating system of your mobile device, open the **App Store** (iOS) or **Google Play** (Android) and install the **EZCast Pro** app on your mobile device.
- Scan the QR code on the **EZCast Pro** menu with your mobile device and then follow the on-screen instructions to install the **EZCast Pro** app.

If you are using a laptop, download **EZCast** app from www.ezcast.com/upgrade/download.php?vendor=ezcastpro website.



4. Insert the optional Wireless adapter into USB2.

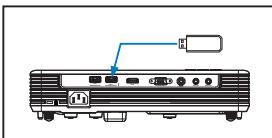

5. Connect your portable device via Wi-Fi to the projector. Example connection parameters:

- SSID of the projector: **EZProjector_704CFF2F**
- PSK: **37892471**

Note: The projector SSID and PSK vary depending on the connected Wireless adapter.

6. Connect the projector to the Wi-Fi network.

Mobile Device

a. On your mobile device, enable the Wi-Fi function and open the **EZCast Pro** app. Then select  > **Settings**.

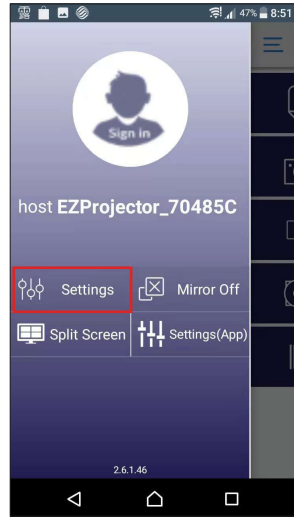
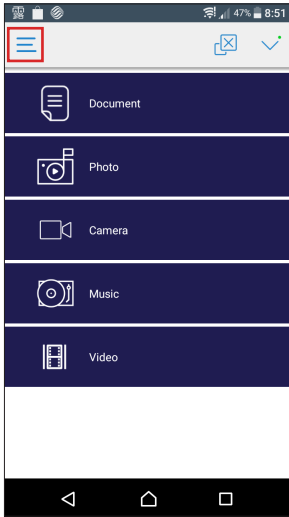

b. Connect to an available Wi-Fi network from the list. If you connect to a secure Wi-Fi network, enter the password and tap **OK** to establish the connection.

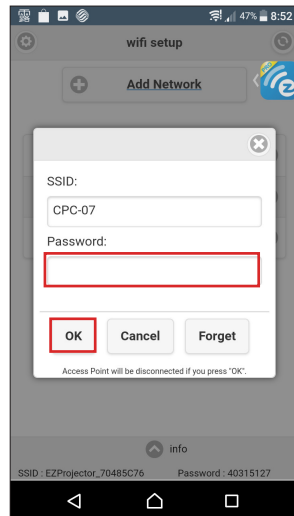
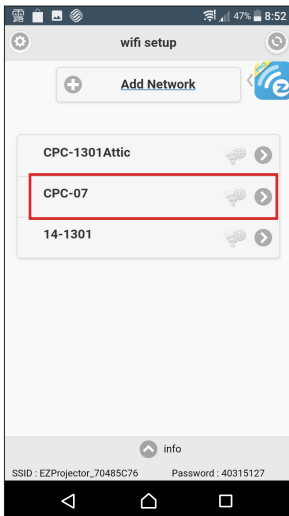

Once connected, the connection status icon turns blue, indicating the projector is connected to the Wi-Fi network.

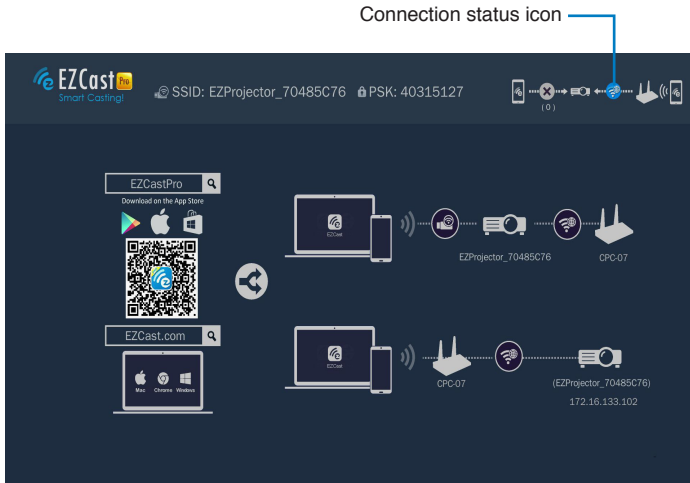

Windows/Mac

- On your computer, enable the Wi-Fi function and open the **EZCast Pro** app. Then select **Search Device**.

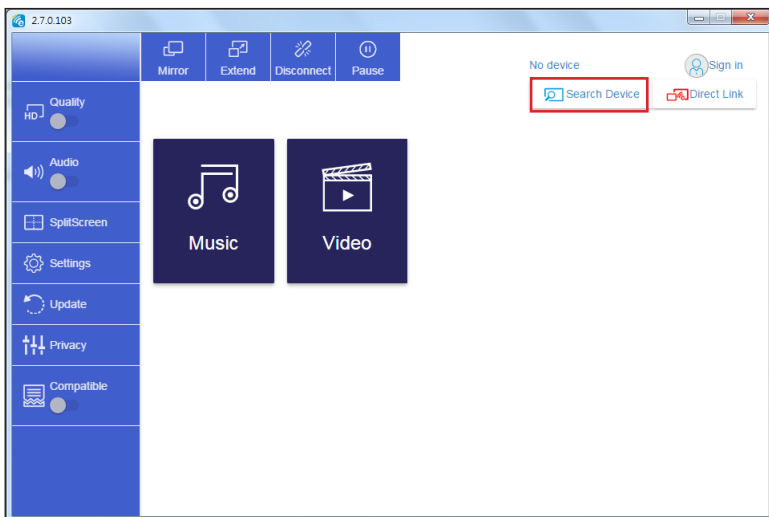

- b. Select the projector you want to connect.

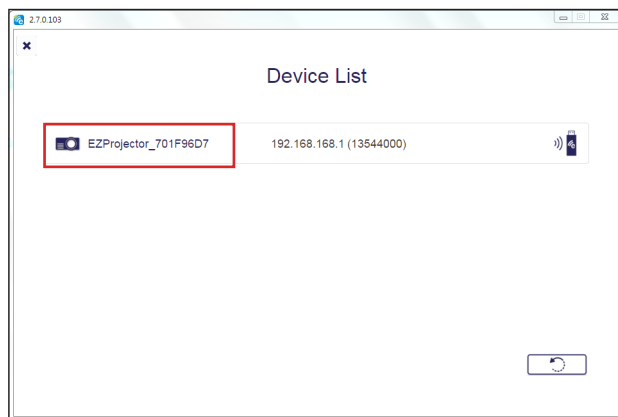

- c. Once connected, select **Settings**.

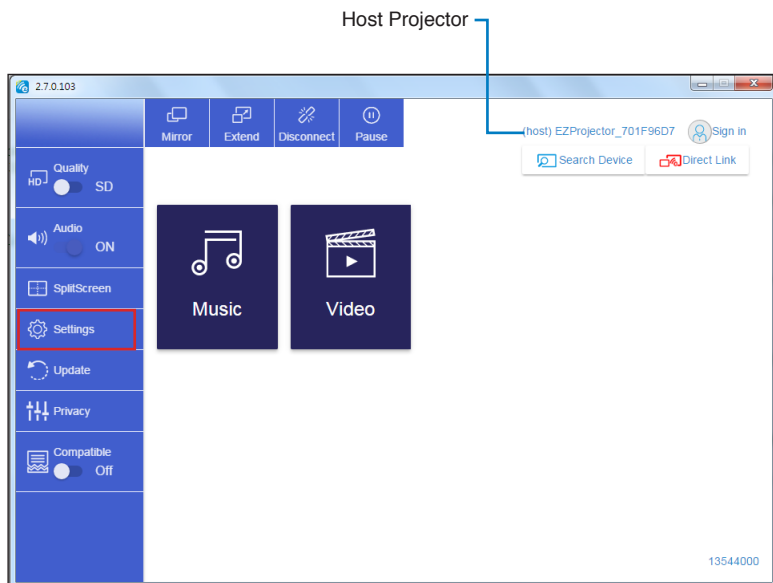

- d. Connect to an available Wi-Fi network from the list. If you connect to a secure Wi-Fi network, enter the password and click **OK** to establish the connection.

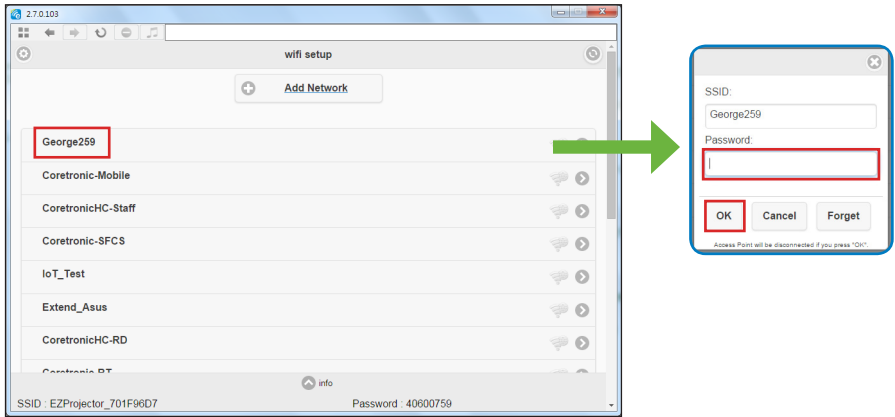

Once connected, the connection status icon turns blue, indicating the projector is connected to the Wi-Fi network.

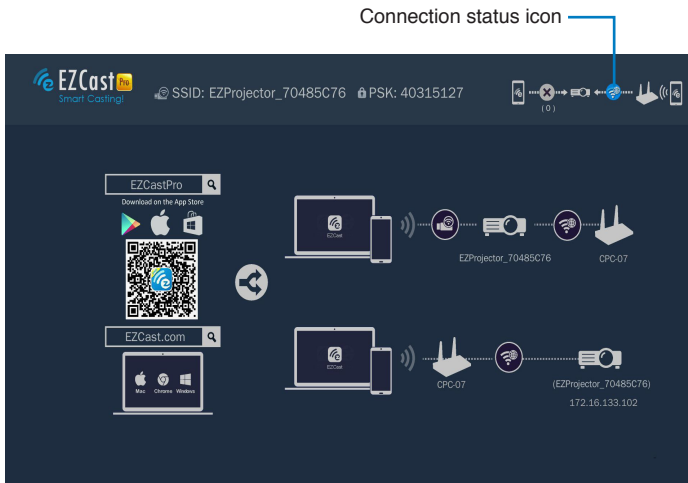

5. Open the **EZCast Pro** app on the portable device.

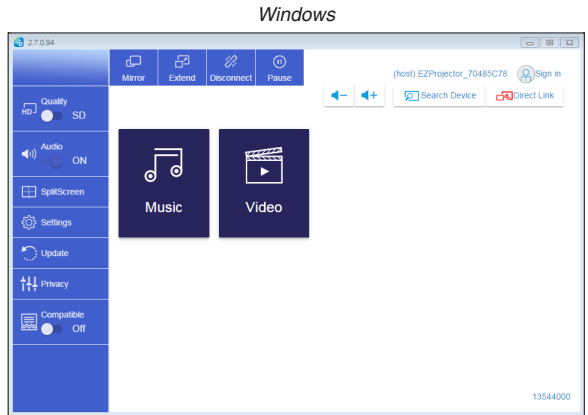
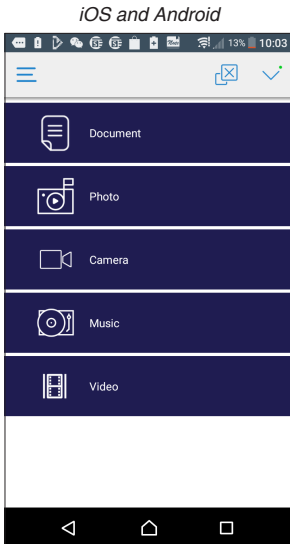

6. Select what you want to display, local photos and documents, files from the Web or Cloud storage. The display of your device will be mirrored by the projector.

How to opt out EZCast Google Analytics

iOS

1. Open the **EZCast Pro** app. Then select  > **Privacy**.

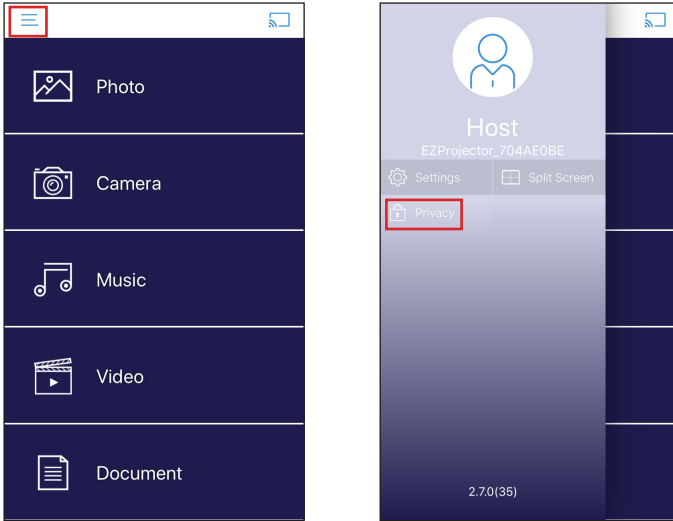

2. On the ANALYTICS section, disable all items to opt out analytics.

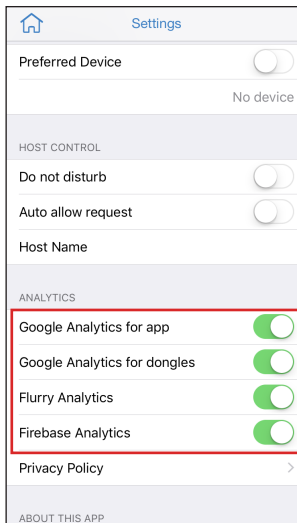

Android

1. Open the **EZCast Pro** app. Then select  > **Privacy**.

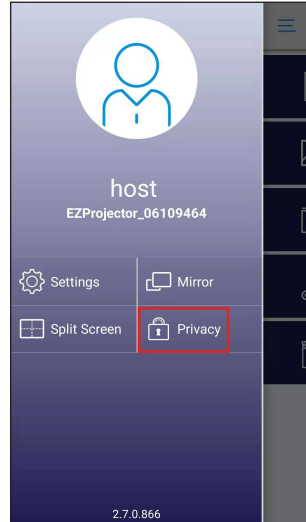
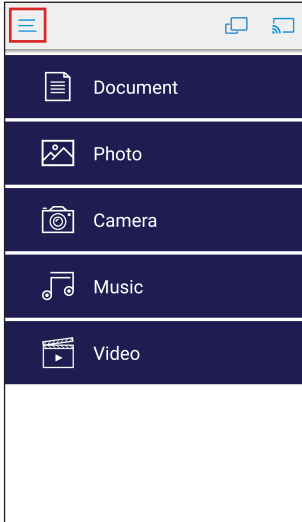

2. On the ANALYTICS section, disable all items to opt out analytics.

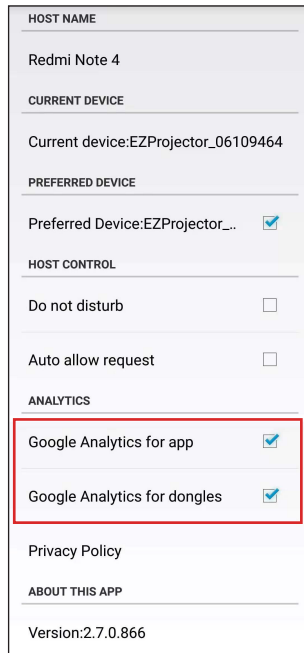

For EZCast privacy statement, please visit <https://www.ezcast.com/privacy>.

Appendices

Troubleshooting

If you experience problems with your projector, see the following troubleshooting tips. If the problem persists, contact your local reseller or service center.

Problem	Possible Solution
No image appears on the screen	<ul style="list-style-type: none">• Ensure that the projector is turned on.• Ensure that you have chosen the correct input source on the OSD Menu > Input Source menu.• Ensure the external graphics port is enabled. If images are not displayed properly, please upgrade the video driver of your computer.• Ensure that all the cables are securely connected.• Ensure that the pins of the connectors are not bent or broken.
Partial, scrolling or incorrectly displayed image	<ul style="list-style-type: none">• If you experience difficulty in changing resolutions, or if your monitor freezes, restart all the equipment and the projector.• If images are not displayed properly, please upgrade the video driver of your computer.
The screen does not display your presentation	<ul style="list-style-type: none">• If you are using a portable computer, press the toggle output settings. Example: [Fn]+[F4].
Image is unstable or flickering	<ul style="list-style-type: none">• Adjust the phase in the OSD Menu > Image > Phase menu.
Image has vertical flickering bar	<ul style="list-style-type: none">• Adjust the frequency in the OSD Menu > Image > Frequency menu.
Image is out of focus	<ul style="list-style-type: none">• Adjust the focus ring on the projector lens.• Ensure that the projection screen is within the required distance from the projector (2.6ft [82cm] to 26.8ft [817cm]).
The image is stretched when displaying a 16:9 DVD	<ul style="list-style-type: none">• The projector automatically detects the input signal format. It will maintain the aspect ratio of the projected image according to input signal format with an original setting.• If the image is still stretched, adjust the format in the Menu > Image > Aspect Ratio menu in the OSD.
Power LED is flashing red and Illumination LED is solid red.	<ul style="list-style-type: none">• A projector LED has failed and the projector will automatically shut down. If the problem persists, contact InFocus.

Problem	Possible Solution
Power LED is flashing red, is solid blue, and Temp LED is flashing red	<ul style="list-style-type: none"> The projector has overheated. The display automatically shuts down. Turn the projector on again after cool down. If the problem persists, contact InFocus. If the projector fan fails, the projector will automatically shut down. Clear the projector mode by pressing and holding the Power button for 10 seconds. Please wait for about 5 minutes and try to power up again. If the problem persists, contact InFocus.
The remote control is not operating smoothly or works only within a limited range	<ul style="list-style-type: none"> The battery may be low. If so, replace with a new CR2025 battery.

Status Indicators

Projector Status	Description	Power (Blue / Red)	Temp (Red)	Illumination (Red)
Standby mode	Projector in Standby mode. Ready to power on.	Red	OFF	OFF
Power on	Projector in Normal mode, ready to display an image.	Blue	OFF	OFF
Projector overheated	Air vents might be blocked or ambient temperature may be above 35°C. The projector automatically shuts down. Ensure that the air vents are not blocked and that the ambient temperature is within operational range. If the problem persists, contact us.	Red flashing	Red	OFF
Fan failure	One of the fans has failed. The projector automatically shuts down. If the problem persists, contact us.	Red flashing and Blue ON	Red flashing (0.5 seconds off, 2 seconds on)	OFF
LED failure	LED shutdown.	Red flashing	OFF	Red

Note: *If the projector fan fails, the projector will automatically shut down. Reset the projector mode by pressing and holding the **Power** button for 10 seconds. Please wait for about 5 minutes and try to power up again.*

Compatibility Modes (HDMI/VGA)

Signal	Mode	Resolution	Refresh Rate (Hz)	Notes for Mac
HDMI, VGA	VGA	640 x 480	60/75	60/75
	SVGA	800 x 600	60/75/120(*)	60/75
	XGA	1024 x 768	60/75/120(*)	60/75
	SXGA	1280 x 1024	60/75	60
	WXGA	1280 x 768	60/75	-
	WXGA	1280 x 800	60	60
	WXGA	1366 x 768	60	60
	WXGA	1280 x 720	60	-
	WXGA+	1440 x 900	60/75	-
	SXGA+	1400 x 1050	60	60
	WSXGA+	1680 x 1050	60	60
HDMI, YPbPr (via VGA connector)	480i/480p		60	-
	576i/576p		50	-
	720p		50/60	60
	1080i		50/60	-
	1080p		24/50/60	60

Note: (*)3D timing for TI DLP 3D (for WXGA only).

A. VGA Analog

Modes	Resolution	V.Frequency [Hz]	H.Frequency [KHz]
(1) VGA Analog - PC Signal			
VGA	640x480	60.0	31.5
	640x480	75.0	37.5
	800x600	60.0	37.9
	800x600	75.0	46.9
XGA	1024x768	60.0	48.4
	1024x768	75.0	60.0
	1024x768	120.0	99.0
	1280x1024	60.0	64.0
	1280x1024	75.0	80.0
SXGA+	1400x1050	60.0	65.3
PowerBook G4	640x480	60.0	31.4
PowerBook G4	800x600	60.0	37.9
PowerBook G4	1024x768	60.0	48.4

Modes	Resolution	V.Frequency [Hz]	H.Frequency [KHz]
PowerBook G4	1152x870	75.0	68.7
i Mac DV(G3)	1024x768	75.0	60.0
(2) VGA Analog - Extended Wide timing			
WXGA	1280x720	60.0	44.8
	1280x720	120.0	
	1280x800	60.0	49.6
	1280x800	120.0	101.6
	1440x900	60.0	59.9
WSXGA+	1680x1050	60.0	65.3
	1920x1080 (1080P)	60.0	67.5
	1366x768	60.0	47.7
WUXGA	1920x1200-RB	59.9	74.0
	1920x1080 (1080P)	60	67.5
	1366x768	60	47.7
WUXGA	1920x1200-RB	59.9	74.0
(3) VGA Analog - Component Signal			
480i	720x480(1440x480)	59.94(29.97)	15.7
576i	720x576(1440x576)	50(25)	15.6
480p	720x480	59.9	31.5
576p	720x576	50.0	31.3
720p	1280x720	60.0	45.0
720p	1280x720	50.0	37.5
1080i	1920x1080	60(30)	33.8
1080i	1920x1080	50(25)	28.1
1080p	1920x1080	23.97/24	27.0
1080p	1920x1080	60.0	67.5
1080p	1920x1080	50.0	56.3
Graphic source monitor range limits	Horizontal scan rate:	15k-103.1kHz	
	Vertical scan rate:	24-120Hz	
	Max. pixel rate:	Analog:170MHz	

B. HDMI2.0 Digital (1080p model)

Modes	Resolution	V.Frequency [Hz]	H.Frequency [KHz]
(1) HDMI - PC Signal			
VGA	640x480	60.0	31.5
	640x480	75.0	37.5
SVGA	800x600	60.0	37.9
	800x600	75.0	46.9
XGA	1024x768	60.0	48.4
	1024x768	75.0	60.0
	1024x768 4:3	120.0	99.0
	1280x1024 5:4	60.0	64.0
	1280x1024	75.0	80.0
SXGA+	1400x1050	60.0	65.3
PowerBook G4	640x480	60.0	31.4
PowerBook G4	800x600	60.0	37.9
PowerBook G4	1024x768	60.0	48.4
PowerBook G4	1152x870	75.0	68.7
i Mac DV(G3)	1024x768	75.0	60.0
(2) HDMI - Extended Wide timing			
WXGA	1280x720 16:9	60.0	44.8
	1280x720 16:9	120.0	
	1280x800 16:10	60.0	49.6
	1440x900 16:10	60.0	59.9
WSXGA+	1680x1050 16:10	60	65.29
	1920x1080(1080P)	60	67.5
	1920x1080	120	135
UHD	3840x2160	60.0	135.0
(3) HDMI - Video Signal			
480i	720(1440)x480 4:3	59.94(29.97)	15.7
576i	720(1440)x576 4:3	50(25)	15.6
480p	720x480 4:3	59.9	31.5
576p	720x576 4:3	50.0	31.3
720p	1280x720 16:9	60.0	45.0
720p	1280x720 16:9	50.0	37.5
1080i	1920x1080 16:9	60(30)	33.8
1080i	1920x1080 16:9	50(25)	28.1
1080p	1920x1080 16:9	23.97/24	27.0

Modes	Resolution	V.Frequency [Hz]	H.Frequency [KHz]
1080p	1920x1080 16:9	60.0	67.5
1080p	1920x1080 16:9	50.0	56.3
1080p	1920x1080 16:9	30.0	33.8
VGA	640x480 4:3	60.0	31.5
UHD	3840x2160 16:9	24.0	54.0
UHD	3840x2160 16:9	25.0	56.3
UHD	3840x2160 16:9	30.0	67.5
UHD	3840x2160 16:9	50.0	112.5
UHD	3840x2160 16:9	60.0	135.0
4K2K	4096x2160 256:135	24.0	54.0
4K2K	4096x2160 256:135	25.0	56.3
4K2K	4096x2160 256:135	30.0	67.5
4K2K	4096x2160 256:135	50.0	112.5
4K2K	4096x2160 256:135	60.0	135.0
480p	720x480 16:9	60.0	
480i	720(1440)x480 16:9	60.0	
576p	720x576p 16:9	50.0	
	2880x480i 16:9	60.0	
	1440x480p 16:9	60.0	
	2880x576i 16:9	50.0	
	1440x576p 16:9	50.0	
	720(1440)x576 16:9	50.0	
(4) HDMI - 1.4a 3D Timing (1080p model)			
720p (Frame Packing)	1280x720	50	37.5
720p (Frame Packing)	1280x720	60	45.0
1080p (Frame Packing)	1920x1080	24	27.0
720p (Top and Bottom)	1280x720	50	37.5
720p (Top and Bottom)	1280x720	60	45.0
1080i (Top and Bottom)	1920x1080	50(25)	28.1
1080i (Top and Bottom)	1920x1080	60(30)	33.8
1080p (Top and Bottom)	1920x1080	24	27.0
1080p (Top and Bottom)	1920x1080	50	56.3
1080p (Top and Bottom)	1920x1080	60	67.5
720p (Side by Side (Half))	1280x720	60	45.0
1080i (Side by Side (Half))	1920x1080	50(25)	28.1

Modes	Resolution	V.Frequency [Hz]	H.Frequency [KHz]
1080i (Side by Side (Half))	1920x1080	60(30)	33.8
1080p (Side by Side (Half))	1920x1080	50	56.3
1080p (Side by Side (Half))	1920x1080	60	67.5
Graphic source monitor range limits	Horizontal scan rate:	15k-135kHz	
	Vertical scan rate:	24-120Hz	
	Max. pixel rate:	Digital:600MHz	

Ceiling Mount the Projector

1. To prevent damage to your projector use a manufacturer recommended mount.
2. If you wish to use a third party ceiling mount kit, please ensure the screws used to attach a mount to the projector meet the following specifications:
 - Screw type: M4 x 3
 - Minimum screw length: 25mm

Note: Please note that damage resulting from incorrect installation will void the warranty.

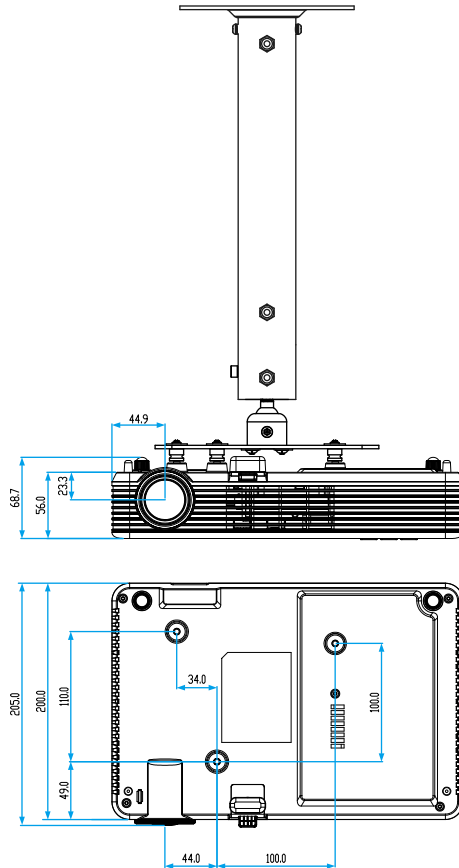

WARNING:

- If you buy a ceiling mount from another company, please be sure to use the correct screw size. Screw size will vary depending on the thickness of the mounting plate.
- Be sure to keep at least a 10cm gap between the ceiling and the bottom of the projector.
- Avoid installing the projector near a heat source.

Specification

Optical	Description
Maximum resolution	- WXGA (1280 x 800) - 1080p (1920 x 1080)
Illumination source	RGB LED (LED life=20,000hrs)
Lens	Manual focus
Image size (diagonal)	30" ~ 301", optimized at 80"
Projection distance	- WXGA: 1m ~ 8.2m - 1080p: 1.0 m ~ 8.0m

Electrical	Description
Inputs	- VGA In x1 - HDMI x1 - USB-A x2 - Audio In x1 - Video x1
Outputs	Audio Out x1
Color reproduction	- WXGA: 24bits RGB 16.7M colors - 1080p: 30bits RGB 1.07B colors
Scan rate	- Horizontal scan rate: 15.375 ~ 91.146 KHz - Vertical scan rate: 24 ~ 120 Hz (120Hz for 3D feature)
Built-in speaker	3W (mono)
Power requirement	AC100V ~ 240V ±10%, 50/60Hz
Input current	AC In 1.9A

Multimedia	Description
FW based	Linux similar OS
USB-A portion	- For firmware upgrade (USB1) - Supports Host mode for USB drive (USB 2.0 support). - Supports Wireless adapter (USB2) - Supports 5V/1A power for HDMI stick

Mechanical	Description
Installation orientation	Desktop/Front, Desktop/Rear
Dimensions	297 x 200 x 56 mm (w/o focus ring and protruding parts)
Weight	- WXGA: 2.1kg - 1080p: 2.2kg
Environmental conditions	Operating: 5 ~ 40°C, 10% to 80% humidity (non-condensing)

Note: All specifications are subject to change without notice.