

Infortrend EonServ 7000 Series User Guide

Version 1.1



Copyright Notice

All rights reserved. This publication may not be reproduced, transmitted, transcribed, stored in a retrieval system, or translated into any language or computer language, in any form or by any means, electronic, mechanical, magnetic, optical, chemical, manual or otherwise, without the prior written consent of Infortrend Technology, Inc.

Disclaimer

Infortrend Technology makes no representations or warranties with respect to the contents hereof and specifically disclaims any implied warranties of merchantability or fitness for any particular purpose. Furthermore, Infortrend Technology reserves the right to revise this publication and to make changes from time to time in the content hereof without obligation to notify any person of such revisions or changes. Product specifications are also subject to change without prior notice.

Trademarks

Infortrend, the Infortrend logo, SANWatch, ESVA, EonStor, EonStor DS, EonNAS, EonServ and EonPath are registered trademarks of Infortrend Technology, Inc. Other names prefixed with “IFT” and “ES” are trademarks of Infortrend Technology, Inc.

- Windows is a registered trademark of Microsoft Corporation.
- Mac OS X is a registered trademark of Apple Computer, Inc.
- Linux is a trademark of Linus Torvalds.

All other names, brands, products or services are trademarks or registered trademarks of their respective owners.



Legal Information

All Infortrend products, including the product customers have purchased from Infortrend, shall be subject to the latest Standard Warranty Policy available on the Infortrend website: <http://www.infortrend.com/global/Support/Warranty>

Infortrend may from time to time modify, update or upgrade the software, firmware or any accompanying user documentation without any prior notice. Infortrend will provide access to these new software, firmware or documentation releases from certain download sections of our website or through our service partners. Customer shall be responsible for maintaining updated version of the software, firmware or other documentation by downloading or obtaining from Infortrend, and installing designated updated code, including but not limited to firmware, microcode, basic input/output system code, utility programs, device drivers, and diagnostics delivered with Infortrend product.

Before installing any software, applications or components provided by a third party, customer should ensure that they are compatible and interoperable with Infortrend product by checking in advance with Infortrend. Customer is solely responsible for ensuring the compatibility and interoperability of the third party's products with Infortrend product. Customer is further solely responsible for ensuring its systems, software, and data are adequately backed up as a precaution against possible failures, alternation, or loss.

For any questions of hardware/ software compatibility, and the update/ upgrade code, customer should contact Infortrend sales representative or technical support for assistance. To the extent permitted by applicable laws, Infortrend shall NOT be responsible for any interoperability or compatibility issues that may arise when (1) products, software, or options not certified and supported by Infortrend are used; (2) configurations not certified and supported by Infortrend are used; (3) parts intended for one system are installed in another system of different make or model.



Contact Information

Customer Support

Contact your system vendor or visit Infortrend's website

<http://infortrend.com/global/About/Worldwide>

for the contact information of support offices worldwide.



About This Guide

- This User Guide introduces EonServ 7000 series' basic hardware/software and recommended procedures to produce a sample for pilot/volume production.
- If you are already an EonServ 7000 series user, please refer to the hardware and/or software manuals that came with your system for full installation details.
- For specific system information, you may also refer to the following documents:
 - EonServ 7000 Series Quick Installation Guide
 - EonServ 7000 Series Hardware Manual
 - SANWatch User Manual

Revision History

Version	Date	Description
1.0	Mar. 2017	Initial release
1.1	May 2017	Remove the limit on the minimum number of drives



Table of Contents

Copyright Notice	ii
Legal Information	iii
Contact Information	iv
About This Guide	v
Revision History	v
Table of Contents	vi
1. Introduction	1
1.1 EonServ 7000 Series Overview	1
1.2 EonServ 7000 Series Advantages	1
1.3 EonServ 7000 Series Technology	2
1.3.1 EonServ Hardware Architecture.....	2
1.3.2 Infortrend RAID Platform Virtualization (IRPV)	3
1.3.3 Intelligent Drive Recovery (IDR) for Better Data Integrity.....	3
1.3.4 Sustained IO Throughput.....	4
1.4 EonServ 7000 Series Hardware.....	4
1.4.1 Front Panel Components.....	4
1.4.2 Rear Panel Components.....	4
1.4.3 Controller Module Interfaces.....	5
2. Initial Setup.....	6
2.1 Hardware Installation	6
2.2 Software Installation	6
2.2.1 Setting up BIOS	6
2.2.2 Installing Operating System	7
2.2.3 Installing Drivers for Your Operating System	7
2.2.4 Installing SANWatch	9
2.2.5 Installing Application Software	9
Appendix.....	10
Dimensions.....	10
Environment Requirement	10
Certifications	11
JBOD Expansion.....	12
Volume Production	13



1. Introduction

1.1 EonServ 7000 Series Overview

EonServ 7000 series is a storage server series that specializes in storage while providing data access, security, management and services over a shared network or the internet. Being an integral part of modern day storage technology and with its data storage capabilities, storage servers are a great option for data backup over network. With extensive customizability when it comes to installing dedicated operating systems, EonServ 7000 series can become specialized and yet remain flexible.

While tradition storage servers usually comprise of two systems, Infortrend EonServ 7000 series uses Infortrend RAID Platform Virtualization (IRPV) to combine the reliability of RAID storage and the powerful server processing abilities into a single hybrid device. This design saves space, lowers costs, is green to operate and requires minimum maintenance. In order to meet all your requirements, Infortrend EonServ 7000 series can be turned into the central point of access for all incoming and outgoing data by simply installing the desired operating system.

Infortrend EonServ 7000 series RAID functions can be managed through the SANWatch graphic user interface (GUI), which is installed on the guest OS (currently supporting Windows 10, Windows Server 2012 R2 64-bit, and CentOS 7). Once tested and approved, you may mass produce your EonServ 7000 series to supply in volume!

1.2 EonServ 7000 Series Advantages

Unlike most storage servers currently on the market, the EonServ 7000 series is a standalone hybrid system that offers the following benefits over traditional server storage systems:

- **System hardware advantage:** EonServ is a highly integrated industrial grade storage server. It features cable-less design and modular components for easy maintenance.
- **Better data integrity with Infortrend Intelligent Drive Recovery:** With the Infortrend RAID technology, users can rest assured that the safety of their stored data is protected from accidental and mechanical errors.
- **Sustained performance guaranteed:** Featuring patented read/write technology ensures sustained data throughput.
- **Intuitive GUI:** SANWatch is intuitive and easy to use, simplifying complicated setup processes to have the system up and running as soon as possible.
- **Expandability:** EonServ 7000 series has a built-in SAS expansion port for JBODs. Maximum hard drive expansion can reach 432 HDDs for 2U and 436 HDDs for 3U EonServ systems. Based on current 8TB hard drives, maximum capacity can reach up to 3488TB.

1.3 EonServ 7000 Series Technology

EonServ 7000 series is designed for optimal performance. Infortrend RAID Platform Virtualization technology allows a dedicated operating system and Infortrend RAID to co-exist, while the Intelligent Drive Recovery function constantly monitors every hard drive for bad blocks. If bad blocks are found, the processing algorithm will find other means to sustain I/O throughput.

1.3.1 EonServ Hardware Architecture

EonServ 7000 series is available in 2U and 3U form factors with various CPU configurations (Intel Xeon E5-2609 v4 and E5-2620 v4). The system supports a maximum of 1024GB DDR4 memory.

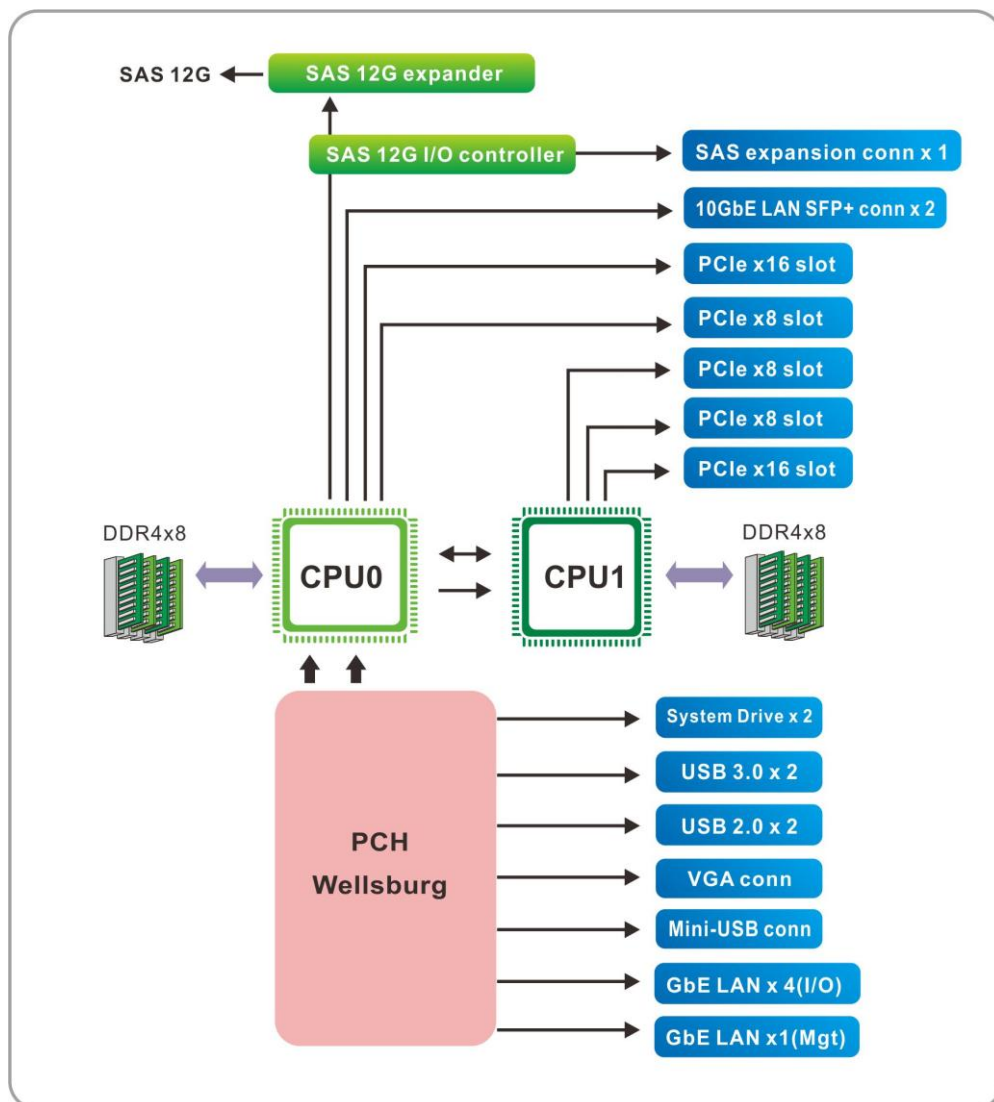



1.3.2 Infortrend RAID Platform Virtualization (IRPV)

Unlike most storage server vendors using add-on RAID card to integrate RAID and additional hardware to house the operating system (application), Infortrend's RAID Platform Virtualization is designed in-house to combine the two into one single system.

The IRPV technology allows for RAID and server to co-exist and operate side-by-side by means of an I/O tunnel (virtual PCIe channel). The utilization of virtualization technology optimizes both RAID and server components for maximum efficiency. Hardware wise, IRPV allows for total characteristic integration of two technologies into a single system. The end result is a cable-less design with easy to maintain modular components delivering optimum performance and compatibility.

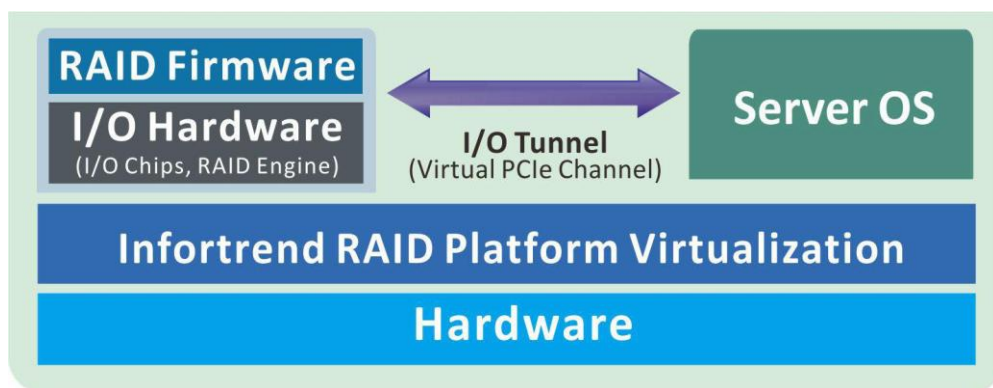

1.3.3 Intelligent Drive Recovery (IDR) for Better Data Integrity

To provide better data integrity, Infortrend EonServ 7000 series' hard drive error detection and countermeasure mechanism in a RAID6 configuration scans for damaged disk block(s) and attempts to repair it. If the damaged block is beyond repair, the Intelligent Drive Recovery (IDR) function takes over isolating the disk and copying and cloning its data to the spare disk which will replace the failing disk before it actually fails. This prevents complete failure of the RAID drive and avoids going through the rebuild process that would otherwise consume valuable resources.

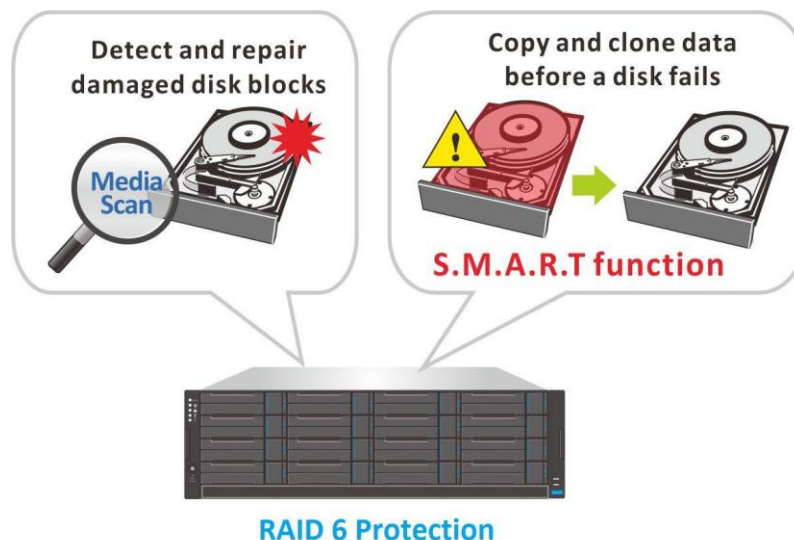

1.3.4 Sustained IO Throughput

EonServ 7000 series' RAID6 disk fault tolerance ensures better performance and quicker response time when there's a hard drive read I/O delay by promptly recalculating the lagging stripe. If there is a drive I/O delay, for read, it pre-calculates the request and for write requests, it pre-writes to cache.

Altogether, Infortrend's patented technology offers users a better user experience with stronger data integrity, system stability and more responsive operations.

1.4 EonServ 7000 Series Hardware

EonServ 7000 series is available in 2U and 3U form factors with various CPU configurations (Intel Xeon E5-2609 v4 and E5-2620 v4). It has two system drive slots (2.5" SATA), 5 PCIe card expansion slots, compatibility with 2.5" SATA SSD, 2.5" SAS SSD, 2.5" 10K RPM SAS HDD, and 3.5" 7,200 RPM NL-SAS HDD, and can expand to up to 432HDDs (for 2U) and 436HDDs (for 3U) through the built-in SAS expansion that connects to JBODs.

1.4.1 Front Panel Components

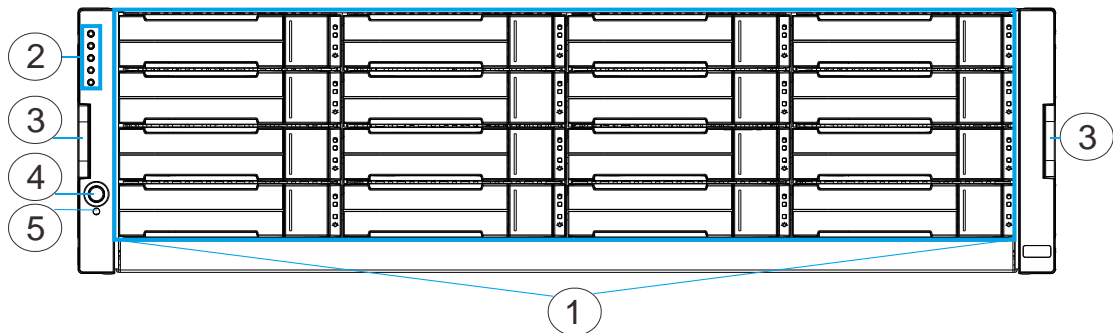

- **Drive trays (1):** Each drive tray is hot-swappable and holds a 3.5-inch hard drive.
- **LED Panel (2):** The panel has Service / Power / Cooling Fan / Thermal / System LEDs.
- **Handles (3):** There are handles on both sides of the enclosure for users to pull / push the enclosure out and into the cabinet when the enclosure is installed on a slide rail rackmount system.
- **Power Switch (4):** The power switch turns on the system.
- **Mute Button (5):** The mute button is to mute an alarm when sound or to indicate to the administrator the system requires service.

1.4.2 Rear Panel Components

The rear of the enclosure consists of major modular components. There are dual redundant power supply units on both sides of the controller module. There are LEDs for users to monitor each components status and the modular design allows for easy extracting of components for maintenance.

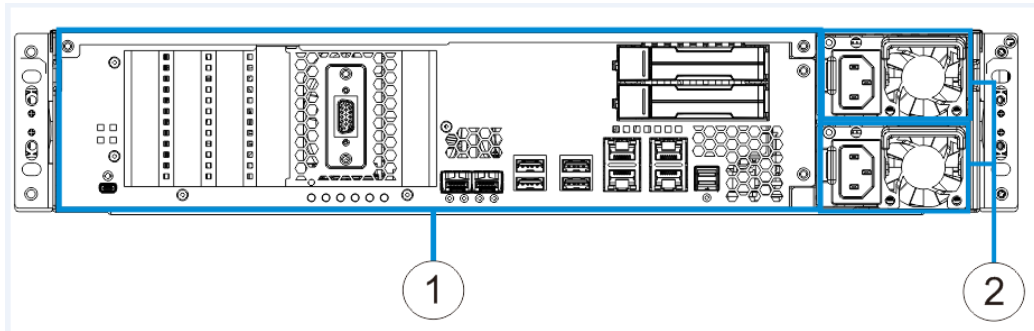

Controller (1)

The controller module represents the server component of the system that contains a main circuit board with various output and connections at the rear.

Power supply unit (2)

The hot-swappable PSUs provide power to the system.

1.4.3 Controller Module Interfaces

The controller module is situated next to the two power supply units at the rear of the system. It has a vast array of connection interfaces (input and output) to compliment user application needs. It is recommended that users familiarize themselves with these interfaces.

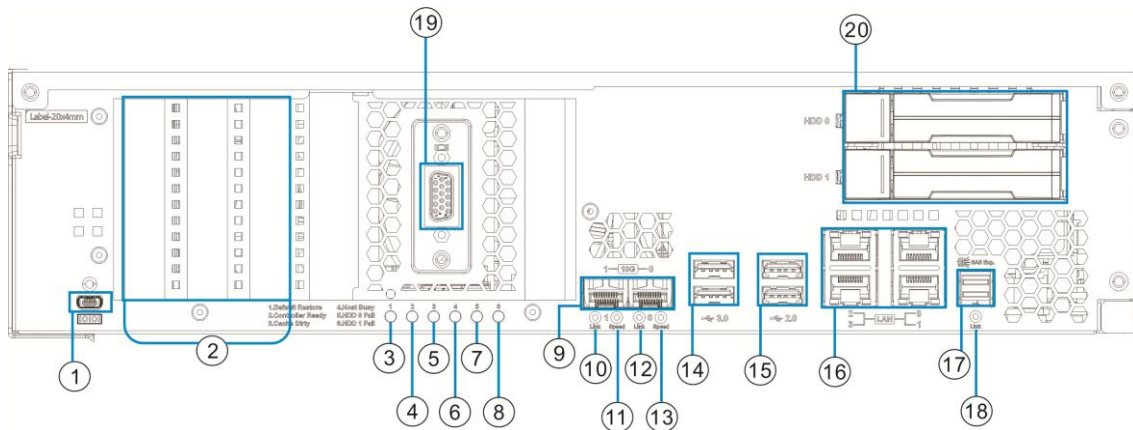

1	Service port	11	10 GbE(SFP+) port 1 Speed LED
2	PCI-E expansion slot	12	10 GbE(SFP+) port 0 Link LED
3	Default Restore LED	13	10 GbE(SFP+) port 0 Speed LED
4	Controller status LED	14	USB 3.0 port
5	Cache Dirty LED	15	USB 2.0 port
6	Host Busy LED	16	1 GbE(RJ-45) ports
7	HDD 0 Fail LED	17	SAS-12G wide port
8	HDD 1 Fail LED	18	SAS-12G wide port Link LED
9	10 GbE(SFP+) ports	19	D-Sub VGA port
10	10 GbE(SFP+) port 1 Link LED	20	HDD



2. Initial Setup

For the initial setup, EonServ requires at least basic hardware and software installations before it can be deployed for specific application purposes and volume production. If you are a current EonServ 7000 series user, please refer to the Hardware and Software Installation Manuals that came with your system for the complete setup process.

Hardware Installation

Please install the following hard drives for your EonServ 7000 series:

1. At least one system drive
2. At least 4 data drives

*Refer to Hardware Installation Manual for full details.

Software Installation

To set up EonServ 7000 series software components, please follow the steps below:

1. Set up the boot device order in BIOS (see section 2.2.1)
2. Install the desired operating system (see section 2.2.2)
3. Install drivers for your operating system (see section 2.2.3)
4. Install SANWatch management software (see section 2.2.4)
5. Install the desired application software (see section 2.2.5)

Volume Production

Once the system has been trial tested then it is ready for volume production.

1. Pilot production (see Volume Production in Appendix section)
2. Mass volume production (see Volume Production in Appendix section)

2.1 Hardware Installation

The system requires the installation of at least one system drive. For detail installation procedures, please refer to the hardware manual on the CD that came with the system for details.

2.2 Software Installation

The software installation procedure includes setting up the BIOS (for OS installation), OS installation, OS driver installation, SANWatch installation and application software installation. If you are a current EonServ 7000 series user, you can find the supported operating system drivers on the CD that came with your system.

2.2.1 Setting up BIOS

Before you can install an operating system on your system, you must setup the BIOS to boot from the desired device. To do this, please follow the instructions below. Please also refer to the document **EonServ OS Driver Installation Guide** for more details.

1. Press F2 to access the motherboard BIOS when powering up the system.
2. Go to 'Boot' tab and select the desired boot device as Boot Option #1.
3. Save and exit the BIOS.

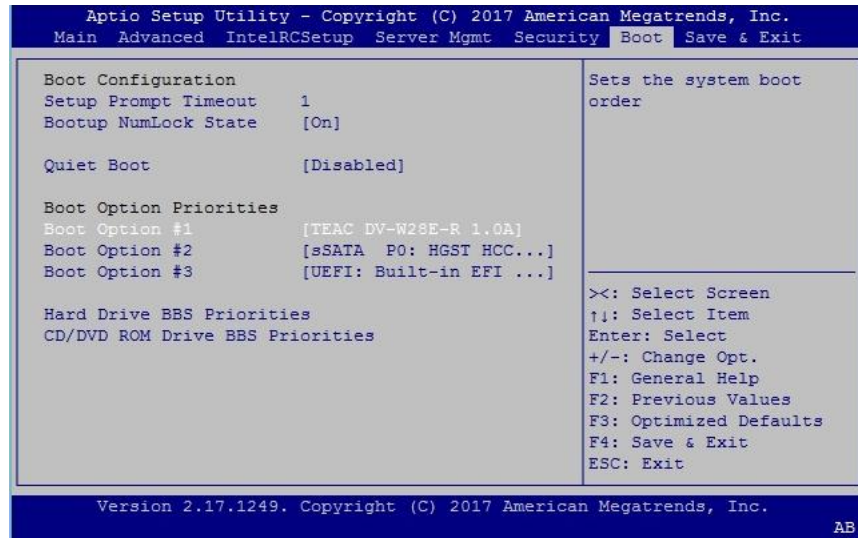

2.2.2 Installing Operating System

EonServ 7000 series drivers support **ONLY** the following operating systems:

- Windows 10
- Windows Server 2012 R2 64-bit
- CentOS 7.2

Follow the installation procedure for your operating system as described in your operating system's installation guides.



NOTE
 Upon system reboot, enter the BIOS again, go to 'Boot' tab and make sure the installed system drive is the first device to boot.

2.2.3 Installing Drivers for Your Operating System

Once the OS has been installed, you may install the driver for the OS.

Installing Drivers for Windows Server 2012 R2

Open Computer management → device manager. Find “!” devices.

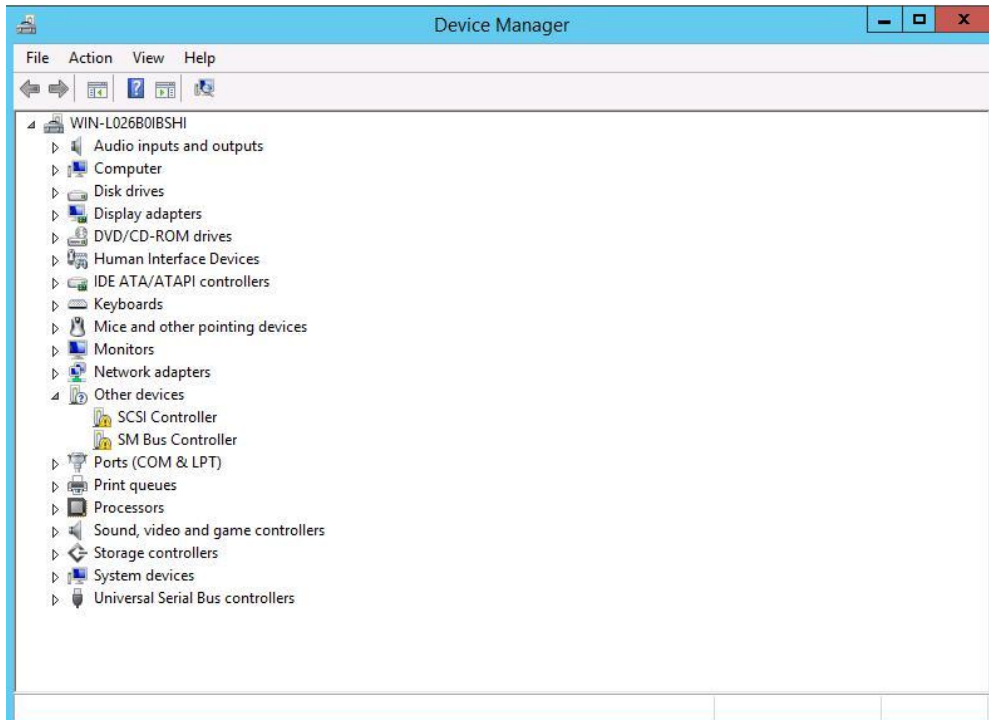

Install driver for the following devices:

1. SM Bus Controller: Intel C220 chipset driver [**SetupChipset.exe**]
2. SCSI controller: Infortrend RAID communication driver [**ift_raid.sys**]

Installing Drivers for Linux CentOS

1. Linux CentOS System Driver Installation
Use the software update feature of your Linux operating system to install the latest drivers.
Note: If the software update feature fails, check EonServ's Internet connection and try again.
2. Linux CentOS RAID Driver Installation

On the installation disc of EonServ, search for the following files and navigate to the folder which contains them:

- vscsihba.ko
- ift_driver_install.sh

Execute the following command, where the "i" option represents "install":

```
sudo sh ift_driver_install.sh i
```

2.2.4 Installing SANWatch

SANWatch is the proprietary software suite that enables you to easily configure and manage Infortrend storage systems. SANWatch can be accessed through a web browser as long as both the computer and the subsystems are online. You are no longer required to install complex desktop application to your local computer: everything is always available over the network.

SANWatch Installation & Setup

For Windows

From the installation CD, open SANWatch.exe, and from the navigation menu that appears, choose SANWatch GUI Software Installation, and then select Windows Platform under SANWatch Management Tool. Then, follow the installation steps to complete the process.



For Linux CentOS

Locate the "SANWatch" folder on the installation CD and copy it to your computer.

Open the command line utility of your OS (such as Terminal for Linux), and log into the command line shell as root.

Locate the "SANWatch" folder copied to your computer, and then browse its contents to make sure the "linux.sh" script is in the folder.

```
[root@localhost ~]# cd <computer_path>/SANWatch/
[root@localhost <computer_path>/SANWatch]# ls -l
...
-rw-r--r--. 1 root root      4279 Jun 23 19:55 linux.sh
...
-rw-r--r--. 1 root root      2037 Jun 23 19:55 unix.sh
```

Make "linux.sh" executable, and then execute it.

```
[root@localhost <computer_path>/SANWatch]# chmod +x linux.sh
[root@localhost <computer_path>/SANWatch]# ./linux.sh
```

Then, follow the installation steps to complete the process.

2.2.5 Installing Application Software

Once you have the system drive, data drive, OS, OS driver and management software installed, you may begin to install the application software relevant for your storage server applications.

Appendix

Dimensions

2U series

Dimensions	With chassis ears & protrusions
Height	88.00mm
Width	447.40mm
Length	650mm

3U series

Dimensions	With chassis ears & protrusions
Height	130.00mm
Width	447.40mm
Length	650mm

Environment Requirement

Humidity	5 to 95% (non condensing – operating and non-operating)
Temperature	Operating: 0° to 40°C Non-operating: -40° to 60°C
Altitude	Operating: Sea level to 12,000ft Packaged: Sea level to 40,000ft
Shock (Half-sine)	Operating: 5G, half-sine, 11ms pulse width Non-operating: 15G, half-sine, 11ms pulse width
Vibration	(Random) Operating: 5 to 500Hz, 0.25Grms, X/Y/Z, 30min Non-operating: 5 to 500Hz, 1.0Grms, X/Y/Z, 30min (Sine) Operating: 5 to 500Hz, 0.2Grms, X/Y/Z Sine, 1hr/sweep Non-operating: 5 to 500Hz, 1.0Grms, X/Y/Z Sine, 1hr/sweep
Acoustic Noise	65dBA boundary, 60dBA normal



Certifications

Safety	UL 60950-1, 2nd Edition BSMI CNS 14336-1: 99 年版 CB IEC 60950-1:2005 (Second Edition) + Am 1:2009 + Am 2:2013 EAC TP TC 004/2011, TP TC 020/2011
EMC	CE EN 55032:2012 +AC:2013 / EN61000-3-2:2014 / EN 61000-3-3: 2013 / EN 55024:2010+A1:2015 BSMI (CNS 13438) FCC (FCC Part 15,subpart B)
Environment	IEC 60068-2 MIL-STD-810E/883E ISTA ASTM-D3332 IPC-TM-650
Others	ISO7779/3744 RoHS Microsoft WHQL-Windows Server 2003

JBOD Expansion

Setting JBOD IDs

Use a small flat blade screwdriver to set the JBOD enclosure ID(s). A different ID number must be allocated for each JBOD.

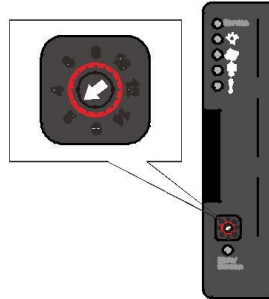

Making Connections

1. Cabling rules:
 - Host system (HBA) to JBOD: SFF-8644/SFF-8644 cable
 - JBOD to JBOD: SFF-8644/SFF-8644 cable
2. Connection rules:
 - Connect EV7000 from the OUT port to JBOD IN port.
 - JBODs can connect only from one OUT to the IN port of another JBOD (Daisy Chain).
 - JBOD OUT to JBOD OUT or JBOD IN to JBOD IN connection is not allowed.

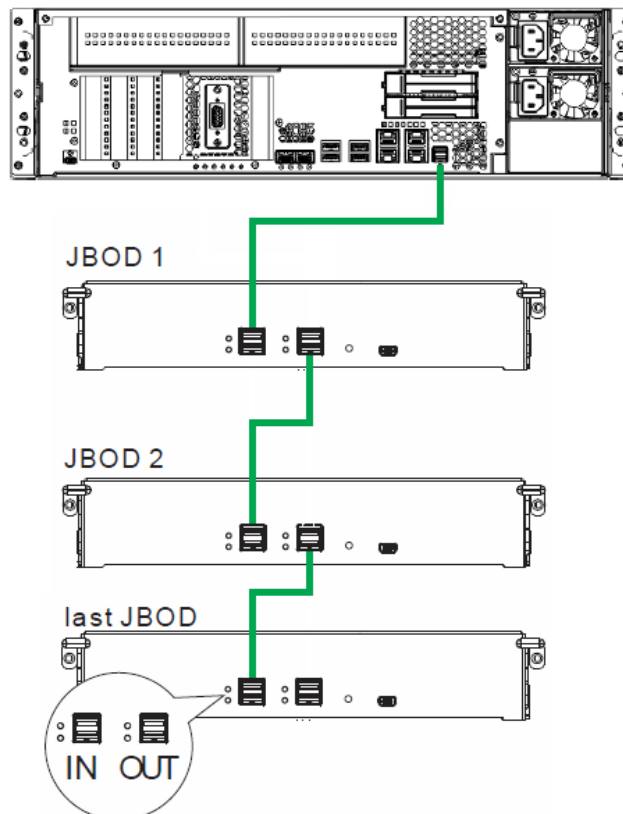



Volume Production

When you have completed the basic hardware and software setup, and have your specific application software installed. Then you are ready to test the system with designated task(s) and in desired environment(s) . Once the system has been tested and approved, you may then consider replication in volume for distribution.

Create Source Image File

You can create a replica of the system drive so it can be quickly applied to EonServ systems to suit your needs.

Clone System Drive

For small volume replication, you may use image creation software for small volume pilot runs. Once the pilot run has been approved, it is ready for mass volume replication. For mass production, you may use hard drive duplicators to mass produce the OS system drive.

OS Software Registration (if any)

Please do remember to register or purchase volume licensing for your OS!