

Lenovo 14e Chromebook User Guide



First Edition (December 2018)

© Copyright Lenovo 2018.

LIMITED AND RESTRICTED RIGHTS NOTICE: If data or software is delivered pursuant to a General Services Administration "GSA" contract, use, reproduction, or disclosure is subject to restrictions set forth in Contract No. GS-35F-05925.

Contents

About this documentation	v
---	----------

Chapter 1. Important safety information.	1
---	----------

Read this first.	1
Conditions that require immediate action	1
Service and upgrades	2
Power cords and power adapters	3
Plugs and outlets	4
Power supply statement	4
Electrical current safety information	5
Non-rechargeable coin-cell battery notice	6
Built-in rechargeable battery notice	6
Removable rechargeable battery notice	6
Heat and product ventilation	7
Liquid crystal display (LCD) notice	7
Extension cords and related devices.	8
Using headphones or earphones	8
Plastic bag notice	8
Glass parts notice	8
Safety instructions for teachers, parents and adult supervisors	8

Chapter 2. Meet your Chromebook.	11
---	-----------

Front view	11
Microphones	11
Camera light	11
Camera	12
Screen	12
Power key	12
Keyboard	12
Touchpad	12
Wireless antennas	12
Left view	13
dc-in / USB-C connector	13
dc-in light	13
USB 3.0 (Type-A) connector	14
Combo audio connector	14
microSD card slot	14
Right view	15
USB 3.0 (Type-A) connector	15
USB-C connector	15
Security-lock slot	15
Bottom view	17
Features and specifications	18
Operating environment	20

Chapter 3. Get started with your Chromebook	21
--	-----------

Charge your Chromebook.	21
User interface	22
Connect to Wi-Fi	22
Connect to Bluetooth devices	22
Set the power plan	23

Chapter 4. Navigate the screen	25
---	-----------

Use the multi-touch screen	25
Use the special keys	26
Use the touchpad	26

Chapter 5. Use multimedia	29
--	-----------

Use the camera	29
Use audio	29
Connect to an external display	29

Chapter 6. Account, login, and logout	31
--	-----------

Types of user account for logging into Chrome	31
Become your Chromebook's owner	31
Sign in with another Google account	32
Browse as a guest.	32
Create a supervised account.	32
Lock your Chromebook.	33
Sign out.	33
Give other Google Accounts permission to use your Chromebook	33
Check a Chromebook's owner	34
Disable guest browsing mode	34
Reset your Chromebook	34
Shut down your Chromebook	34
Get help from Google	34

Chapter 7. Manage files and folders	35
--	-----------

What is Google Drive.	35
Your local storage space	35
Files app	35
Create folders using the Files app.	35
Delete unused files	35
Check the amount of available storage.	36

Chapter 8. Language settings.	37
--	-----------

Change display language	37
Add an input method.	37
Switch among input methods	37

Chapter 9. Add and manage apps. . . 39

What is Chrome Web Store 39
Add apps or extensions. 39
Install Android apps 39
Pin apps to shelf 40
Pin Web pages to shelf 40

Chapter 10. Accessibility, ergonomic, and maintenance information. 41

Accessibility and comfort 41
Ergonomic information 41

Basic maintenance tips 42
Cleaning your computer 42

Appendix A. Compliance information. 45

Appendix B. Lenovo help and support. 57

Appendix C. Lenovo Limited Warranty 59

Trademarks lxvii

About this documentation

- Illustrations in this documentation might look different from your product.
- Depending on the model, some optional accessories, features, and software programs might not be available on your computer.
- Documentation content is subject to change without notice. Lenovo makes constant improvement on the documentation of your computer, including this *User Guide*. To get the latest documentation, go to <https://support.lenovo.com>.

Chapter 1. Important safety information

Read this first

This information can help you safely use your personal computer. Follow and retain all information included with your computer. The information in this document does not alter the terms of your purchase agreement or the *Lenovo Limited Warranty*.

Customer safety is important. Our products are developed to be safe and effective. However, personal computers are electronic devices. Power cords, power adapters, and other features can create potential safety risks that can result in physical injury or property damage, especially if misused. To reduce these risks, follow the instructions included with your product, observe all warnings on the product and in the operating instructions, and review the information included in this document carefully. By carefully following the information contained in this document and provided with your product, you can help protect yourself from hazards and create a safer computer work environment.

Note: This information includes references to power adapters and batteries. In addition to notebook computers, some products (such as speakers and monitors) ship with external power adapters. If you have such a product, this information applies to your product. In addition, computer products contain a coin-sized internal battery that provides power to the system clock even when the computer is unplugged, so the battery safety information applies to all computer products.

Conditions that require immediate action

Products can become damaged due to misuse or neglect. Some product damage is serious enough that the product should not be used again until it has been inspected and, if necessary, repaired by an authorized servicer.

As with any electronic device, pay close attention to the product when it is turned on. On very rare occasions, you might notice an odor or see a puff of smoke or sparks vent from your product. Or you might hear sounds like popping, cracking, or hissing. These conditions might merely mean that an internal electronic component has failed in a safe and controlled manner. Or, they might indicate a potential safety issue. However, do not take risks or attempt to diagnose the situation yourself. Contact the Customer Support Center for further guidance. For a list of Service and Support phone numbers, go to <http://www.lenovo.com/support/phone>.

Frequently inspect your computer and its components for damage or wear or signs of danger. If you have any question about the condition of a component, do not use the product. Contact the Customer Support Center or the product manufacturer for instructions on how to inspect the product and have it repaired, if necessary.

In the unlikely event that you notice any of the following conditions, or if you have any safety concerns with your product, stop using the product and unplug it from the power source and telecommunication lines until you can speak to the Customer Support Center for further guidance.

- Power cords, plugs, power adapters, extension cords, surge protectors, or power supplies that are cracked, broken, or damaged.
- Signs of overheating, smoke, sparks, or fire.
- Damage to a battery (such as cracks, dents, or creases), discharge from a battery, or a buildup of foreign substances on the battery.
- A cracking, hissing, or popping sound, or strong odor that comes from the product.

- Signs that liquid has been spilled or an object has fallen onto the computer product, the power cord, or power adapter.
- The computer product, power cord, or power adapter has been exposed to water.
- The product has been dropped or damaged in any way.
- The product does not operate normally when you follow the operating instructions.

Note: If you notice these conditions with a product (such as an extension cord) that is not manufactured for or by Lenovo, stop using that product until you can contact the product manufacturer for further instructions, or until you get a suitable replacement.

Service and upgrades

Do not attempt to service a product yourself unless instructed to do so by the Customer Support Center or your documentation. Only use a Service Provider who is approved to repair your particular product.

Note: Some computer parts can be upgraded or replaced by the customer. Upgrades typically are referred to as options. Replacement parts approved for customer installation are referred to as Customer Replaceable Units, or CRUs. Lenovo provides documentation with instructions when it is appropriate for customers to install options or replace CRUs. You must closely follow all instructions when installing or replacing parts. The Off state of a power indicator does not necessarily mean that voltage levels inside a product are zero. Before you remove the covers from a product equipped with a power cord, always make sure that the power is turned off and that the product is unplugged from any power source. If you have any questions or concerns, contact the Customer Support Center.

Although there are no moving parts in your computer after the power cord has been disconnected, the following warnings are required for your safety.



CAUTION:
Hazardous moving parts. Keep fingers and other body parts away.



CAUTION:
Before you open the computer cover, turn off the computer and wait several minutes until the computer is cool.

Power cords and power adapters



Use only the power cords and power adapters supplied by the product manufacturer.

The power cords shall be safety approved. For Germany, it shall be H05VV-F, 3G, 0.75 mm², or better. For other countries, the suitable types shall be used accordingly.

Never wrap a power cord around a power adapter or other object. Doing so can stress the cord in ways that can cause the cord to fray, crack, or crimp. This can present a safety hazard.

Always route power cords so that they will not be walked on, tripped over, or pinched by objects.

Protect power cords and power adapters from liquids. For instance, do not leave your power cord or power adapter near sinks, tubs, toilets, or on floors that are cleaned with liquid cleansers. Liquids can cause a short circuit, particularly if the power cord or power adapter has been stressed by misuse. Liquids also can cause gradual corrosion of power cord terminals and/or the connector terminals on a power adapter, which can eventually result in overheating.

Ensure that all power cord connectors are securely and completely plugged into receptacles.

Do not use any power adapter that shows corrosion at the ac input pins or shows signs of overheating (such as deformed plastic) at the ac input pins or anywhere on the power adapter.

Do not use any power cords where the electrical contacts on either end show signs of corrosion or overheating or where the power cord appears to have been damaged in any way.

To prevent possible overheating, do not cover the power adapter with clothing or other objects when the power adapter is plugged into an electrical outlet.

Plugs and outlets



If a receptacle (power outlet) that you intend to use with your computer equipment appears to be damaged or corroded, do not use the outlet until it is replaced by a qualified electrician.

Do not bend or modify the plug. If the plug is damaged, contact the manufacturer to obtain a replacement.

Do not share an electrical outlet with other home or commercial appliances that draw large amounts of electricity; otherwise, unstable voltage might damage your computer, data, or attached devices.

Some products are equipped with a three-pronged plug. This plug fits only into a grounded electrical outlet. This is a safety feature. Do not defeat this safety feature by trying to insert it into a non-grounded outlet. If you cannot insert the plug into the outlet, contact an electrician for an approved outlet adapter or to replace the outlet with one that enables this safety feature. Never overload an electrical outlet. The overall system load should not exceed 80 percent of the branch circuit rating. Consult an electrician for more information if you have questions about power loads and branch circuit ratings.

Be sure that the power outlet you are using is properly wired, easily accessible, and located close to the equipment. Do not fully extend power cords in a way that will stress the cords.

Be sure that the power outlet provides the correct voltage and current for the product you are installing.

Carefully connect and disconnect the equipment from the electrical outlet.

Power supply statement



Never remove the cover on a power supply or any part that has the following label attached.



Hazardous voltage, current, and energy levels are present inside any component that has this label attached. There are no serviceable parts inside these components. If you suspect a problem with one of these parts, contact a service technician.

Electrical current safety information



Electric current from power, telephone, and communication cables is hazardous. To avoid a shock hazard:

- Do not use your computer during a lightning storm.
- Do not connect or disconnect any cables or perform installation, maintenance, or re-configuration of this product during an electrical storm.
- Connect all power cords to a properly wired and grounded electrical outlet.
- Connect to properly wired outlets any equipment that will be attached to this product.
- Whenever possible, use one hand only to connect or disconnect signal cables.
- Never turn on any equipment when there is evidence of fire, water, or structural damage.
- Disconnect the attached power cords, battery pack, and all the cables before you open the device covers, unless instructed otherwise in the installation and configuration procedures.
- Do not use your computer until all internal parts enclosures are fastened into place. Never use the computer when internal parts and circuits are exposed.



Connect and disconnect cables as described in the following procedures when installing, moving, or opening covers on this product or attached devices.

To connect:

1. Turn everything OFF.
2. First, attach all cables to devices.
3. Attach signal cables to connectors.
4. Attach power cords to outlets.
5. Turn devices ON.

To disconnect:

1. Turn everything OFF.
2. First, remove power cords from outlets.
3. Remove signal cables from connectors.
4. Remove all cables from devices.

The power cord must be disconnected from the wall outlet or receptacle before installing all other electrical cables connected to the computer.

The power cord may be reconnected to the wall outlet or receptacle only after all other electrical cables have been connected to the computer.



During electrical storms, do not perform any replacement and do not connect the telephone cable to or disconnect it from the telephone outlet on the wall.

Non-rechargeable coin-cell battery notice



If the coin-cell battery is incorrectly replaced, there is danger of an explosion. The battery contains a small amount of harmful substance.

Do not heat to more than 100 °C (212 °F).

The following statement applies to users in the state of California, U.S.A.

Products containing manganese dioxide lithium coin-cell batteries may contain perchlorate. Perchlorate Material - special handling may apply, see <https://www.dtsc.ca.gov/hazardouswaste/perchlorate>.

Built-in rechargeable battery notice



Do not attempt to replace the built-in rechargeable battery. Replacement of the battery must be done by a Lenovo-authorized repair facility or technician.

Only recharge the battery strictly according to instructions included in the product documentation.

Removable rechargeable battery notice



Only recharge the battery strictly according to instructions included in the product documentation.

If the battery is incorrectly replaced, there is danger of an explosion. The battery contains a small amount of harmful substances.

Heat and product ventilation



Computers, ac power adapters, and many accessories can generate heat when turned on and when batteries are charging. Notebook computers can generate a significant amount of heat due to their compact size. Always follow these basic precautions:

- When your computer is turned on or the battery is charging, the base, the palm rest, and some other parts may become hot. Avoid keeping your hands, your lap, or any other part of your body in contact with a hot section of the computer for any extended length of time. When you use the keyboard, avoid keeping your palms on the palm rest for a prolonged period of time. Your computer generates some heat during normal operation. The amount of heat depends on the amount of system activity and the battery charge level. Extended contact with your body, even through clothing, could cause discomfort or even a skin burn. Periodically take breaks from using the keyboard by lifting your hands from the palm rest; and be careful not to use the keyboard for any extended length of time.
- Do not operate your computer or charge the battery near flammable materials or in explosive environments.
- Ventilation slots, fans and/or heat sinks are provided with the product for safety, comfort, and reliable operation. These features might inadvertently become blocked by placing the product on a bed, sofa, carpet, or other flexible surface. Never block, cover, or disable these features.
- When the ac power adapter is connected to an electrical outlet and your computer, it generates heat. Do not place the adapter in contact with any part of your body while using it. Never use the ac power adapter to warm your body. Extended contact with your body, even through clothing, may cause a skin burn.

For your safety, always follow these basic precautions with your computer:

- Keep the cover closed whenever the computer is plugged in.
- Regularly inspect the outside of the computer for dust accumulation.
- Remove dust from vents and any perforations in the bezel. More frequent cleaning might be required for computers in dusty or high-traffic areas.
- Do not restrict or block any ventilation openings.
- Do not operate your computer inside furniture, as this might increase the risk of overheating.
- Airflow temperatures into the computer should not exceed 35°C (95°F).

Liquid crystal display (LCD) notice

CAUTION:

The liquid crystal display (LCD) is made of glass and rough handling or dropping the computer can cause the LCD to break. If the LCD breaks and the internal fluid gets into your eyes or on your hands, immediately wash the affected areas with water for at least 15 minutes; if any symptoms are present after washing, get medical care.

Note: For products with mercury-containing fluorescent lamps (for example, non-LED), the fluorescent lamp in the liquid crystal display (LCD) contains mercury; dispose of according to local, state, or federal laws.

Extension cords and related devices

Ensure that extension cords, surge protectors, uninterruptible power supplies, and power strips that you use are rated to handle the electrical requirements of the product. Never overload these devices. If power strips are used, the load should not exceed the power strip input rating. Consult an electrician for more information if you have questions about power loads, power requirements, and input ratings.

Using headphones or earphones

CAUTION:

Excessive sound pressure from earphones and headphones can cause hearing loss. Adjustment of the equalizer to maximum increases the earphone and headphone output voltage and the sound pressure level. Therefore, to protect your hearing, adjust the equalizer to an appropriate level.

Excessive use of headphones or earphones for a long period of time at high volume can be dangerous if the output of the headphone or earphone connectors do not comply with specifications of EN 50332-2. The headphone output connector of your computer complies with EN 50332-2 Sub clause 7. This specification limits the computer's maximum wide band true RMS output voltage to 150 mV. To help protect against hearing loss, ensure that the headphones or earphones you use also comply with EN 50332-2 (Clause 7 limits) for a wide band characteristic voltage of 75 mV. Using headphones that do not comply with EN 50332-2 can be dangerous due to excessive sound pressure levels.

If your Lenovo computer came with headphones or earphones in the package, as a set, the combination of the headphones or earphones and the computer already complies with the specifications of EN 50332-1. If different headphones or earphones are used, ensure that they comply with EN 50332-1 (Clause 6.5 Limitation Values). Using headphones that do not comply with EN 50332-1 can be dangerous due to excessive sound pressure levels.

Plastic bag notice



Plastic bags can be dangerous. Keep plastic bags away from babies and children to avoid danger of suffocation.

Glass parts notice

CAUTION:

Some parts of your product may be made of glass. This glass could break if the product is dropped on a hard surface or receives a substantial impact. If glass breaks, do not touch or attempt to remove it. Stop using your product until the glass is replaced by trained service personnel.

Safety instructions for teachers, parents and adult supervisors

This Chromebook computer is intended for use as a child development tool primarily by children, 6 years of age or above. There must be supervision by an adult. It is a must to have a thorough explanation to children on safe and proper handling of the computer, battery pack, and ac power adapter.



Warning: Chocking Hazard - Small parts. Not suitable for children under age 3.

- For ITE with power supplies not intended to be handled by children: As with all electrical products, precautions should be observed handling and use to prevent electric shock. The ac power adapter should not be handled by children.
- The computer should not be placed on the bare skin (lap) of the child for long periods. The computer should be placed on a flat surface, like desktop, if your child intends to use it for more than a few minutes.
- The computer (including the ac power adapter and the battery pack, as applicable) should not be left in the rain or subjected to exposure to water. If cleaning is necessary do not immerse it in water; wipe clean with damp cloth.
- The computer (including the ac power adapter and the battery pack, as applicable) should not be dropped, crushed (stepped on) or otherwise abused.
- An adult should caution his or her child about the potential trip hazard as posed by the cable between a power source and the computer. An adult should inspect the computer (including the ac power adapter and the battery pack, as applicable) periodically for damage. Similarly, if a child notices damaged/broken parts, this should be reported to the teacher/parents/adult supervisors immediately. Damaged parts may be replaced through service provided by Lenovo.



ELECTRICALLY OPERATED PRODUCT. Not recommended for children under 3 years of age (or other intended age range). As with all electrical products, precautions should be observed during handling and use of electrical products to reduce the risk of electric shock.

Chapter 2. Meet your Chromebook

Front view

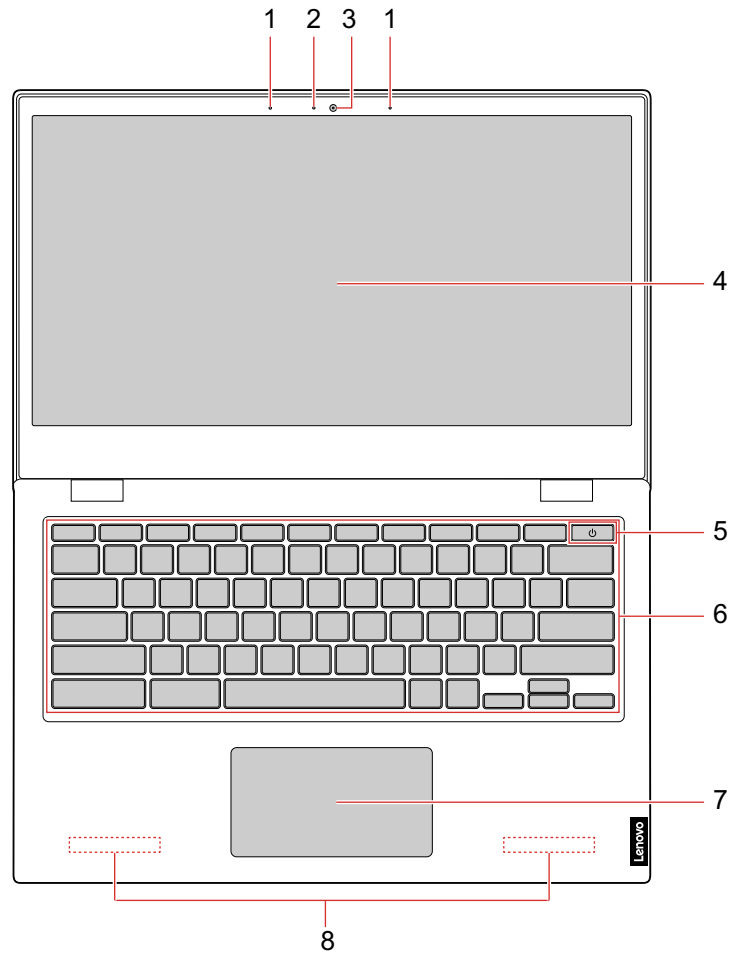

1. Microphones	2. Camera light
3. Camera	4. Screen
5. Power key	6. Keyboard
7. Touchpad	8. Wireless antennas (invisible from the outside)

Microphones

The built-in microphones can be used for voice recording, audio communication, or videoconferencing.

Camera light

The light is on when the camera is in use.

Camera

The built-in camera can be used for video calling or videoconferencing.

Note: The light next to the camera indicates whether it is in use.

Screen

The screen displays text, graphics, and videos.

Notes:

- Selected models support multi-touch function. You can use your finger for interaction with the computer. For details about the multi-touch function, see “Use the multi-touch screen” on page 25.
- The screen can be rotated up to 180 degrees. Do not rotate the screen with too much force, or apply too much force to the upper-right or upper-left corner of the screen. Otherwise, the screen or hinges might get damaged.

Power key

When you open the LCD cover, the computer starts automatically. If it does not start, press the power key. The power key also can be used to put the computer to sleep mode or wake up the computer.

Keyboard

Your Chromebook keyboard works just like a conventional keyboard but with a few special shortcut keys for quick access to certain settings. In addition to the special shortcut keys, Chromebook also supports shortcut keys using the **ctrl**, **alt**, or **shift** key.

Note: For details about shortcut keys, see “Use the special keys” on page 26.

Touchpad

The touchpad supports the single-click function. Move your finger on the touchpad to move the cursor, and tap or click on the touchpad to start apps.

Note: For details about how to use the touchpad, see “Use the touchpad” on page 26.

Wireless antennas

If your computer includes a radio transmitter, wireless antennas are built into the computer for sending and receiving radio. The antennas are not visible from the outside of the computer.

Left view

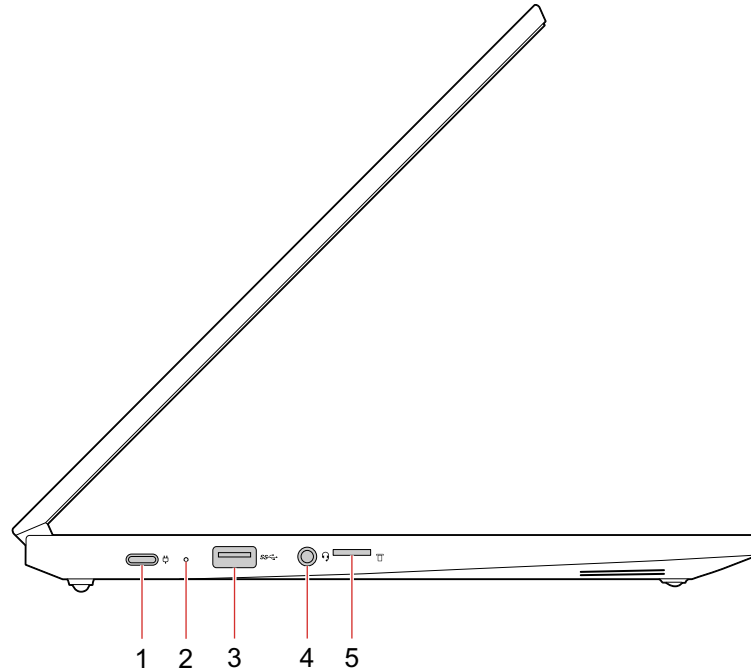

1. dc-in / USB-C connector	2. dc-in light
3. USB 3.0 (Type-A) connector	4. Combo audio connector
5. microSD card slot	

dc-in / USB-C connector

Plug in the included ac power adapter to charge the internal battery and provide power to the Chromebook.

Note: While not used by the ac power adapter, the connector can also be used to connect external devices with a USB-C plug.

dc-in light

The dc-in light shows the power and battery status of your computer.

Table 1. dc-in light status and the corresponding power and battery status

Light status	Power status	Battery status
on (red)	plugged in	<ul style="list-style-type: none">being chargedremaining power less than 2%
on (amber)	plugged in	<ul style="list-style-type: none">being chargedremaining power between 2% and 100%
on (green)	plugged in	have being fully charged for more than 5 minutes
off	unplugged	discharging

USB 3.0 (Type-A) connector

The USB 3.0 (Type-A) connector is used for connecting external devices. It is compatible with USB 3.0 (Type-A) plugs.

Combo audio connector

The combo audio connector supports headphones or headsets with a 3.5 mm TRRS plug. It does not support standalone microphones nor headsets with a separate plug for microphone.

microSD card slot

Insert a microSD card here to expand the Chromebook's local storage capacity.

Insert a microSD card

Step 1. Insert a microSD card into the slot and gently push it until it touches the end.

Note: Make sure the metal contacts of the microSD card are facing downwards when inserting it into the slot.

Step 2. Firmly push in the card until you hear a "click" sound.

Note: When properly inserted, the entire body of the microSD card should be located in the slot and is not easily moved.

Remove a microSD card

Do not remove a microSD card until the data transfer between the computer and the microSD card has finished.

Step 1. On the left pane of the Files app, click the eject button  (next to **SD Card**).

Step 2. Firmly push in the card until you hear a "click" sound.

Step 3. Slowly remove the card from your Chromebook.

Right view

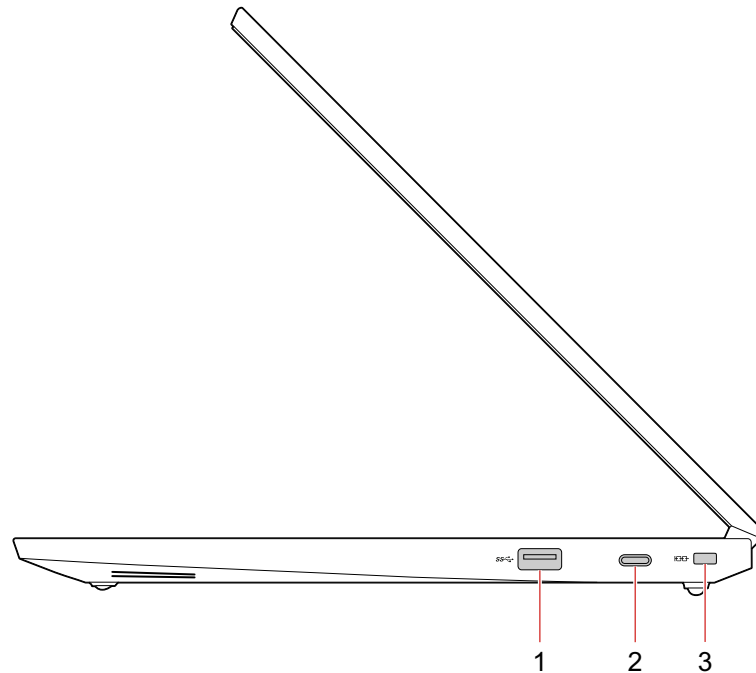

1. USB 3.0 (Type-A) connector	2. USB-C connector
3. Security-lock slot	

USB 3.0 (Type-A) connector

The USB 3.0 (Type-A) connector is used for connecting external devices. It is compatible with USB 3.0 (Type-A) plugs.

USB-C connector

This connector can be used as follows.

- Charge your computer.
- Charge USB-C compatible devices with the output voltage and current of 5 V and 3 A.
- Transfer data at USB 3.0 speed, up to 5 Gbps.
- Connect to an external display.
 - USB-C to VGA: 1900 × 1200 pixels, 60 Hz
 - USB-C to DP: 3840 × 2160 pixels, 30 Hz
- Connect to USB-C accessories to expand computer functionality. To purchase USB-C accessories, go to <https://www.lenovo.com/accessories>.

Note: When the battery power is below 10%, the connected USB-C accessories might not work correctly.

Security-lock slot

Lock your computer to a desk, table, or other fixtures through a compatible security cable lock.

Note: You are responsible for evaluating, selecting, and implementing the locking device and security feature. Lenovo makes no comments, judgments, or warranties about the function, quality, or performance of the locking device and security feature. Cable locks for your product are available from Lenovo at <https://www.lenovoquickpick.com>.

Bottom view

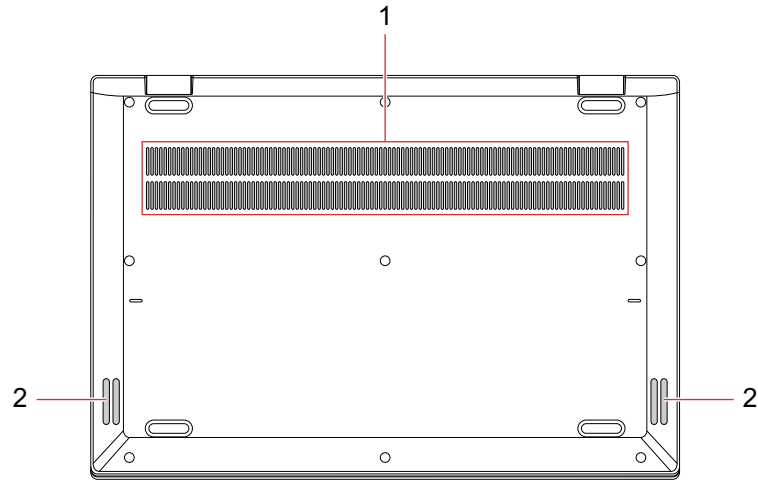

1. Ventilation slots (inlet)	Maintain the incoming airflow to dissipate internal heat.
2. Speakers	Produce sound.

Features and specifications

Note: Specifications might change without notice. Some specifications are model-specific and might not apply to the model that you purchased.

Display	<ul style="list-style-type: none">• Multi-touch screen*• Resolution: 1920 x 1080 pixels• Size: 355.6 mm (14 inches)
Memory	<ul style="list-style-type: none">• Type: DDR4, on-board memory• Capacity: 4 GB or 8 GB
Storage device	<ul style="list-style-type: none">• Type: eMMC 5.1• Capacity: 32 GB, 64 GB, or 128 GB <p>Note: The capacity of the storage device displayed in the operating system typically is lower than the nominal capacity.</p>
Connectors and slots	<ul style="list-style-type: none">• Two USB-C connectors• Two USB 3.0 (Type-A) connectors• Audio connector• microSD card slot
Wireless features	<ul style="list-style-type: none">• Bluetooth• Wireless LAN
Security	<ul style="list-style-type: none">• Password• Security-lock slot
Others	<ul style="list-style-type: none">• Camera• Microphones• Speakers
Size	<ul style="list-style-type: none">• Width: 328 mm (12.91 inches)• Depth: 225 mm (8.85 inches)• Thickness: 17.7 mm (0.69 inches)
Weight	<ul style="list-style-type: none">• 1.48 kg (3.27 lbs)
Battery	<ul style="list-style-type: none">• 3 cells• 57 Wh <p>Note: The battery capacity is the typical or average capacity as measured in a specific test environment. Capacities measured in other environments may differ but are no lower than the rated capacity (see product label).</p>
ac power adapter	<ul style="list-style-type: none">• Input: 100 V to 240 V, 50 Hz to 60 Hz• Output: 15 V dc, 3 A• Power: 45 W

* for selected models

Statement on USB transfer rate

Depending on many factors such as the processing capability of the host and peripheral devices, file attributes, and other factors related to system configuration and operating environments, the actual transfer rate using the various USB connectors on this device will vary and will be slower than the data rate listed below for each corresponding device.

USB device	Data rate (Gbit/s)
3.1 Gen 1	5
3.1 Gen 2	10
3.2	20

Operating environment

Maximum altitude

3048 m (10,000 ft) (without pressurization)

Temperature

Operating	5 °C – 35 °C (41 °F – 95 °F)
Storage	5 °C – 43 °C (41 °F – 109 °F)

Note: When charging the battery pack, the environment temperature must be at least 0 °C (32 °F).

Relative humidity

Operating	8% – 95% at wet-bulb temperature 23 °C (73 °F)
Storage	5% – 95% at wet-bulb temperature 27 °C (81 °F)

If possible, place your computer in a well-ventilated and dry area without direct exposure to sunshine.

Chapter 3. Get started with your Chromebook

Charge your Chromebook

Both USB-C connectors on your Chromebook work as power connectors. Plug in the ac power adapter to charge the built-in battery and provide power to your Chromebook.

Connect to ac power

CAUTION:

All plugs must be firmly and securely inserted into receptacles.

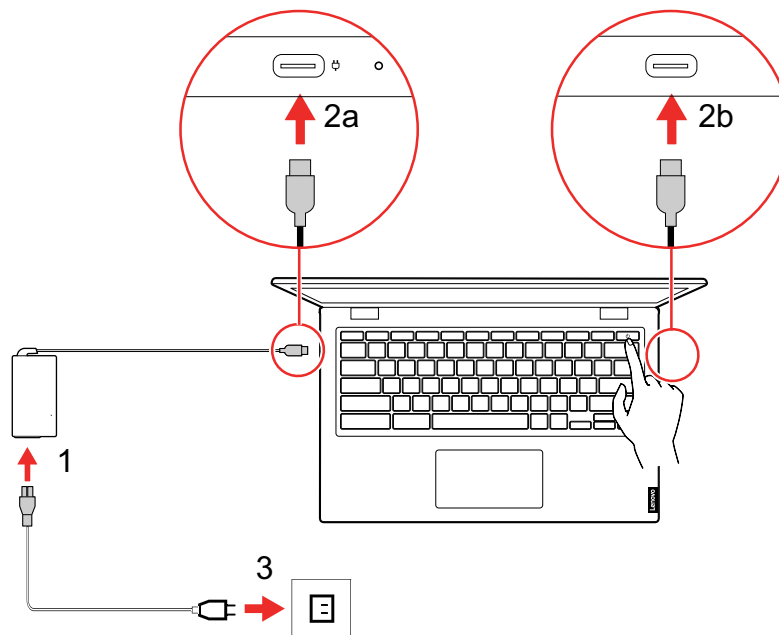

1. Connect the power cord to the ac power adapter.
2. Plug the power adapter into one of the USB-C connectors of the Chromebook.
3. Plug the power cord into a properly grounded electrical outlet.

User interface

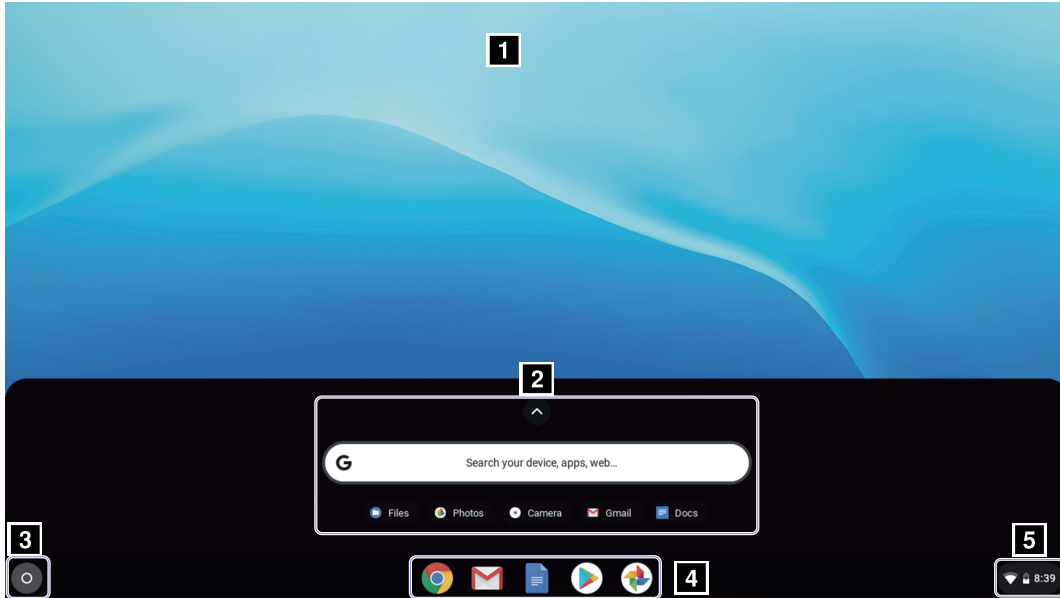

1. Wallpaper	Your wallpaper might look different. To change the wallpaper, right-click an empty area of your desktop, and select Set Wallpaper .
2. Search box and the App Launcher	<ul style="list-style-type: none">• Type the name of your device, app, or Web page in the search box.• Click any app shown in the App Launcher to open the app quickly.
3. Launcher button	Open the search box and the App Launcher.
4. Shelf	Pin your frequently used apps or Web pages to the shelf for easy access.
5. System tray	Manage network connections, updates, and settings. By default, the time, network connection status, and battery status are displayed.

Connect to Wi-Fi

1. Click the system tray.
2. Click the network icon and turn on the wireless feature.
3. Select an available network to connect. Provide required information if needed.

Connect to Bluetooth devices

Your Chromebook supports the Bluetooth feature. You can connect your Chromebook to a Bluetooth keyboard, mouse, speakers, or other Bluetooth devices.

Note: The Bluetooth devices must be with a short distance, usually 10 meters (33 feet) from the Chromebook.

1. Click the system tray, and then click the Bluetooth icon.
2. If the Bluetooth feature is off, turn on the **Bluetooth** switch.
3. Select a Bluetooth device, and then follow the on-screen instructions.

Set the power plan

For ENERGY STAR® compliant computers, the following power plan takes effect when your computers have been idle for a specified duration:

Table 2. Default power plan (when plugged into ac power)

- | |
|---|
| <ul style="list-style-type: none">• Turn off the display: After seven minutes• Put Chromebook into sleep: After 30 minutes |
|---|

To change the power settings:

1. Click the system tray, and then click the settings icon .
2. Under **Device** item, click **Power**.
3. Follow the on-screen instructions to change the settings as you prefer.

To wake up your Chromebook from sleep mode, press any key on the keyboard.

Chapter 4. Navigate the screen

Use the multi-touch screen

If your computer display supports the multi-touch function, you can navigate the screen with simple touch gestures.

Note: Some gestures might not be available depending on the app you use.

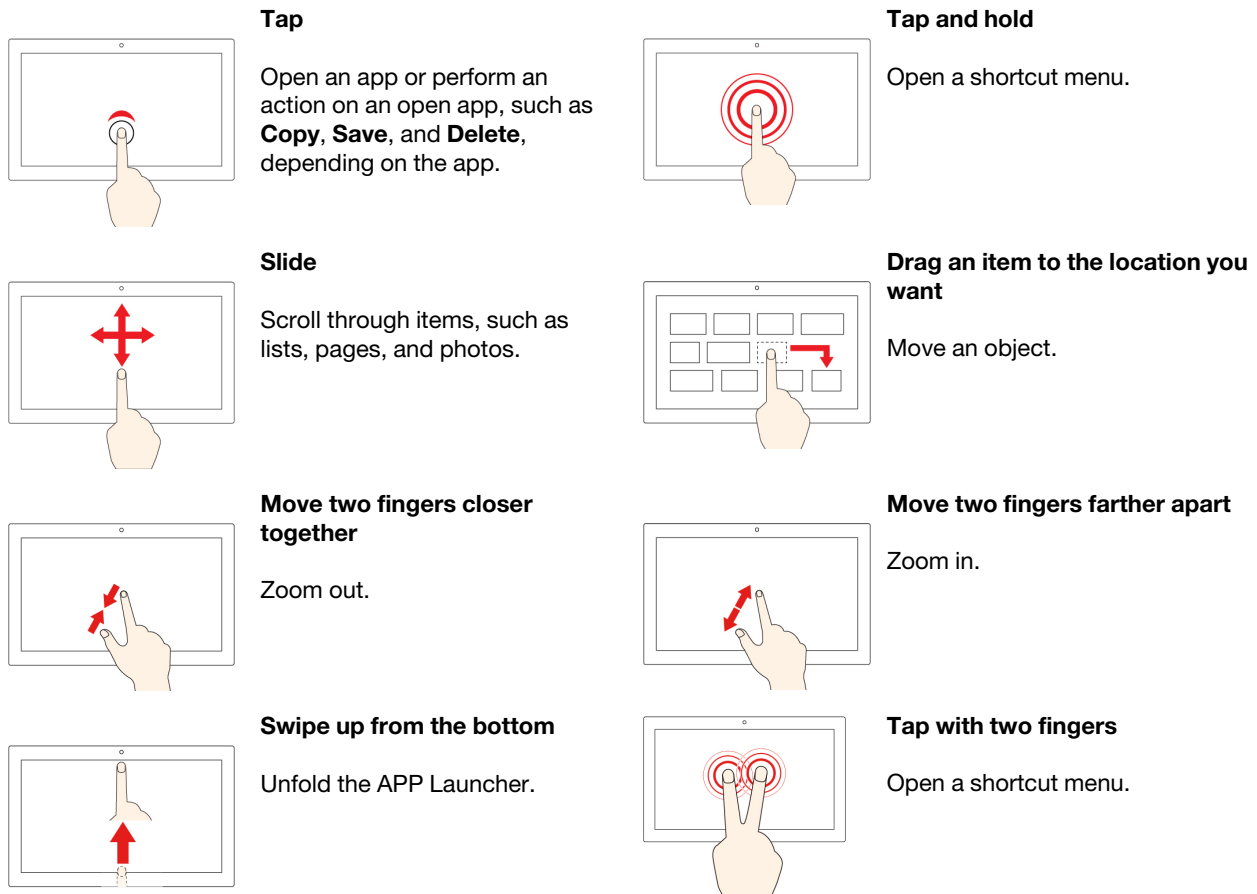











Notes:



- Turn off the computer before cleaning the multi-touch screen.
- Use a dry, soft, and lint-free cloth or a piece of absorbent cotton to remove fingerprints or dust from the multi-touch screen. Do not apply solvents to the cloth.
- The multi-touch screen is a glass panel covered with a plastic film. Do not apply pressure or place any metallic object on the screen, which might damage the touch panel or cause it to malfunction.
- Do not use fingernails, gloved fingers, or inanimate objects for input on the screen.
- Regularly calibrate the accuracy of the finger input to avoid a discrepancy.

Use the special keys

Your Chromebook keyboard works just like a conventional keyboard, with a few special keys.

	Go to the previous page you just visited.
	Go to the next page.
	Reload your current page.
	Display the current full page.
	Show all windows in overview mode.
	Decrease display brightness.
	Increase display brightness.
	Mute/Unmute sound.
	Decrease the volume.
	Increase the volume.
	Turn on the computer, put it to sleep mode, or wake it up.

Your Chromebook also supports some key combinations.

ctrl + 	Take a screenshot.
alt + 	Turn on or turn off the Caps Lock function.
 + L	Lock the computer screen.
ctrl + alt + ?	View all the keyboard shortcuts.

To change the keyboard settings:

1. Click the system tray, and then click the settings icon .
2. Under **Device** item, click **Keyboard**.
3. Follow the on-screen instruction to change the settings as you prefer.

Use the touchpad

The entire touchpad surface is sensitive to finger touch and movement. You can use the touchpad to perform all the pointing, clicking, and scrolling functions of a traditional mouse.

Notes:

- When using two or more fingers, ensure that you position your fingers slightly apart.
- Some gestures are only available when you are using certain apps.
- If the touchpad surface is stained with oil, turn off the computer first. Then, gently wipe the touchpad surface with a soft and lint-free cloth moistened with lukewarm water or computer cleaner.

Use the touchpad gestures

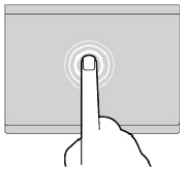

Tap

Tap anywhere on the touchpad with one finger to select or open an item.

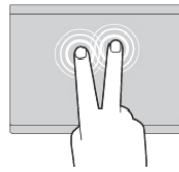

Two-finger tap

Tap anywhere on the touchpad with two fingers to display a shortcut menu.

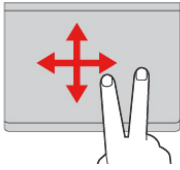

Two-finger scroll

Put two fingers on the touchpad and move them in the vertical or horizontal direction. This action enables you to scroll through the document, Web site, or apps.

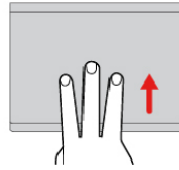

Swipe three fingers up or down

Put three fingers on the touchpad and move them up or down to see all your open windows.

To change the settings:

1. Click the system tray, and then click the settings icon .
2. Under **Device** item, Click **Touchpad**.
3. Follow the on-screen instructions to change the settings as you prefer.

Notes:

- If **enable tap-to-click** is turned on, you can tap or press the touchpad to achieve the clicking function of a traditional mouse.
- If **enable tap-to-click** is turned off, you can only press the touchpad to achieve the clicking function of a traditional mouse.

Chapter 5. Use multimedia

Use the camera

You can use the built-in camera to take photos or record videos. The camera light is on when the camera is in use.

To take photos with the camera:

1. Click the Launcher button, and then click  to display the full APP Launcher.
2. Click **Camera**.
3. Click the red camera icon. If you want to record video, click the video icon to switch to video mode.

Use audio

You can connect headphones or a headset with a 3.5-mm (0.14-inch) and 4-pole plug to the audio connector to listen to the sound from your Chromebook.

To play a saved audio or video file:

1. Click the Launcher button, and then click  to display the full APP Launcher.
2. Select **Files**.
3. Double-click a file to open it in the media player.

To adjust the volume, click the system tray, and then adjust the volume bar.

Connect to an external display

With an appropriate USB-C cable connected, you can use either of the two USB-C connectors to connect your Chromebook to an external display. If you need conversion cables, go to <https://www.lenovo.com/accessories>.

To connect your Chromebook to a projector or a monitor to give presentations or expand your workspace:

1. Connect the external display to either of the two USB-C connectors on your Chromebook.
2. Connect the external display to an electrical outlet.
3. Turn on the external display.

To change the display settings:

1. Click the system tray, and then click the settings icon .
2. Under **Device** item, click **Displays**.
3. Follow the on-screen instructions to change the display settings as you prefer.

Chapter 6. Account, login, and logout

Types of user account for logging into Chrome

There are three types of user accounts you may use to log into Chrome.

Types of user account	Description
Google Account	<p>A user account that has access to a variety of Google Web services, including Gmail™, Google Drive, and Google Docs. Typically a Google Account is created when you apply for a Gmail account. A Google Account can be used to log into any Chrome-based device unless the account is restricted by the device's owner. For details, refer to "Give other Google Accounts permission to use your Chromebook" on page 33.</p> <p>The first Google Account logged into a Chrome-based device becomes the device's owner.</p> <p>Note: If you don't have a Google Account, you can create one at http://www.google.com/accounts/NewAccount.</p>
Guest account	<p>A special account for logging into Chrome. A Guest user has limited privilege and may only be used for temporary sharing of a Chrome-based device.</p> <p>Note: Guest login may be disabled by a device's owner. For details, refer to "Disable guest browsing mode" on page 34.</p>
Supervised account	<p>A special account created by a Google Account (manager) logged into a Chrome-based device. A supervised account is device-specific and cannot be used to log into other Chrome-based device.</p> <p>The manager of a supervised user can review and control a supervised user's use of the Internet.</p>

Become your Chromebook's owner

When starting your Chromebook for the first time, you need to set the operating system language and keyboard, the Internet connection, and sign in with your Google Account. The user of the first Google Account signed into a Chromebook becomes the device's owner.

Note: The owner of a Chromebook has permissions to enable (or disable) Guest account login and restrict login of certain Google Accounts.

- Step 1. Start your Chromebook.
- Step 2. Select your local language and keyboard when prompted.
- Step 3. Set up connection to your wireless router (or a wireless LAN) that has Internet access.

Note: This step cannot be skipped. You must have an Internet connection when starting your Chromebook for the first time.

- Step 4. Sign in with your Google Account. If you don't have a Google Account, select **Create a Google Account** and follow the on-screen instructions to create one.

You're now your Chromebook's owner. To verify this, refer to "Check a Chromebook's owner" on page 34.

Sign in with another Google account

As the device owner, you may share your Chromebook with other people. They can use their Google Accounts to sign in and use your Chromebook.

- Step 1. Start the Chromebook.
- Step 2. On the login screen, click **Add person**.
- Step 3. Type the Google Account user name and password to sign in.

Note: You need to connect the Chromebook to the Internet before you sign in with the Google account for the first time.

If you cannot sign in with your Google account, your account may be restricted by the Chromebook owner. For details, refer to "Give other Google Accounts permission to use your Chromebook" on page 33.

Browse as a guest

You may share your Chromebook with people who do not have a Google Account. They can use your Chromebook with a special guest account.

Note: Some operations such as installing apps are disabled if you log in as a guest.

- Step 1. Start the Chromebook.
- Step 2. On the login screen, click **Browse as Guest**.

Note: If you cannot sign in, guest browsing may be disabled by the Chromebook owner.

Create a supervised account

You may need to create a supervised account for your child to use your Chromebook. As the manager of a supervised account, you have the ability to review and control their use of the Internet.

- Step 1. Start the Chromebook.
- Step 2. On the login screen, click the ... icon and then click **Add supervised user**.

Note: You can only create a supervised account when your Chromebook is connected to the Internet.

- Step 3. Select the manager of the supervised user and provide your password.
- Step 4. Create the name and password for the supervised user.

To change restriction settings for the supervised user, go to <http://www.chrome.com/manage>.

Lock your Chromebook

If you need to temporarily leave your Chromebook, lock it so others cannot tamper with your settings or files.

Step 1. Click the system tray.

Step 2. Click the lock icon.

Note: As a shortcut, you can also press and hold the lock key on your keyboard to lock your Chromebook.

Sign out

If you or others need to sign in with another account, sign out of current login session.

Step 1. Click the system tray.

Step 2. Click **Sign out**.

Give other Google Accounts permission to use your Chromebook

By default, anyone with a valid Google Account can sign in to a Chromebook. However, as a Chromebook owner, you can give permission to allow certain accounts to sign in.

Step 1. Start the Chromebook.

Step 2. Sign in with the owner's Google Account.

Note: If you're not sure who is the Chromebook's owner, refer to "Check a Chromebook's owner" on page 34.

Step 3. Click the system tray, and then click the settings icon .

Step 4. Under **People** item, click **Manage other people**.

Step 5. Check **Restrict sign-in to the following users** and click **Add person** to add the Google Accounts that you want to give permission.

Check a Chromebook's owner

Typically, the user of the first Google Account signed in is set as a Chromebook's owner. However, if you're not sure whether you're the owner, you can follow the steps below to check a Chromebook's owner.

- Step 1. Sign in with your Google Account.
- Step 2. Click the system tray, and then click the settings icon .
- Step 3. Under **People** item, click **Manage other people**.

- If you're not the owner of the Chromebook, you will get a warning message that the settings may only be modified by the device owner.
- If you are the owner of the Chromebook, your user name will display.

Disable guest browsing mode

As a Chromebook's owner, you can prevent guests browsing your computer for security.

- Step 1. Start the Chromebook.
- Step 2. Click the system tray, and then click the settings icon .
- Step 3. Under **People** item, click **Manage other people**.
- Step 4. De-select **Enable Guest browsing**.

Reset your Chromebook

If you need to transfer ownership of your Chromebook or if you experienced problems with the operating system, you might need to reset your Chromebook.

Important: After resetting your Chromebook, user data for all accounts stored locally will be deleted. Back up important data to Google Drive or external storage devices before resetting your Chromebook.

- Step 1. Click the system tray, and then click the settings icon .
- Step 2. Click **Advanced**.
- Step 3. Under **Reset Settings** item, click **Powerwash** and then click **Restart**.

Shut down your Chromebook

When you finish working with your Chromebook, shut it down to save power.

- Step 1. Click the system tray.
- Step 2. Click the Shut down button .

Get help from Google

After signing in to your Chromebook, click **Get Help** from the App Launcher. The **Get Help** app provides comprehensive instructions on using a Chromebook.

In addition, Google provides an online community for Chromebook users. If you're interested, go to <http://chromebook.com/community>.

Chapter 7. Manage files and folders

What is Google Drive

Google Drive is a server-based file storage and sharing service provided by Google. By creating a Google Account, you get an initial free storage space where you can save files of various formats. From your Chromebook, you can use the Google Drive app or the Files app to create and manage files on your online storage space.

Note: The Google Drive client software is available for Windows®, Android™, OSX and iOS. If you have devices running those operating systems, you can download and install Google Drive on these devices. Google Drive provides a convenient way of sharing files between devices. You can also find your files online by visiting: <http://drive.google.com>.

Your local storage space

Each Google Account signed in to a Chromebook is assigned a local storage space, in a folder named **Downloads**. Each Google Account has its own **Downloads**. You can only view and edit files in your own **Downloads** folder.

Files app

Your Chromebook has a Files app for you to manage files and folders on your local storage device, a connected external storage device, or Google Drive. The Files app can be started from the App Launcher.

Create folders using the Files app

You can create folders and sub-folders for better management of files.

- Step 1. Start the Files app from the App Launcher.
- Step 2. On the left pane, select a storage space where you want to save files.

Note: A storage space may reside on your local storage device, a connected external storage device, or Google Drive.

- Step 3. Click the More actions icon  in the upper right corner and then click **New folder**.

Delete unused files

In some cases, you may need to delete unused files to free storage space.

- Step 1. Start the Files app from the App Launcher.
- Step 2. On the left pane, select the storage space and then navigate to the folder where unused files are stored.
- Step 3. Select unused files and then click the delete button  in the upper right corner.

Check the amount of available storage

If you have failed saving a large-size file, you may need to check the amount of available storage and then decide if you need to delete unused files to free more storage.

Step 1. Start the Files app from the App Launcher.



Step 2. On the left pane, select a storage space.

Step 3. Click the More actions icon  in the upper right corner. The amount of available storage is displayed.

Chapter 8. Language settings

Change display language

When starting your Chromebook for the first time, you're prompted to select the display language. This setting can be changed at a later time if you need to use a different language.

- Step 1. Sign in to your Chromebook with your Google Account.
- Step 2. Click the system tray, and then click the settings icon .
- Step 3. Click **Advanced**.
- Step 4. Under **Languages and input** item, click **Language**, and then the More actions icon  next to the language that you want to use; select the **Display Chrome OS in this language** check box.

Note: If the language you want to use isn't shown in the list, click **Add languages**.

You need to sign out and then sign in for the changes to take effect.

Note: Each signed-in user may set their own display language.

Add an input method

You may need to add an input method to type text in a particular language.

- Step 1. Sign in to your Chromebook with your Google Account.
- Step 2. Click the system tray, and then click the settings icon .
- Step 3. Click **Advanced**.
- Step 4. Under **Languages and input** item, select **Input method** → **Manage input methods**.
- Step 5. Select the check box preceding the input method you want to add.

Switch among input methods

If you have added input methods, you may need to switch among them.

- Step 1. Click the system tray, and then click the settings icon .
- Step 2. Click **Advanced**.
- Step 3. Under **Languages and input** item, select **Input method**. The list of available input methods is displayed. If you don't find your desired input method in the list, refer to "Add an input method" on page 37.
- Step 4. Click the name of your desired input method.

Notes: As a shortcut, use key combinations to switch among input methods.

- Ctrl + Shift + Space to switch among available input methods.
- Ctrl + Space to switch to your previous input method.

Chapter 9. Add and manage apps

You can add features and functions to your Chromebooks by downloading apps from the Web Store or the Play Store.

Table 3. Comparison of available resources between the Web Store and the Play Store

Web Store	Play Store
Extensions	Apps
Themes	Games
Apps	Movies
Games	Books

Note: You cannot download and install apps if you're signing in as Guest.

What is Chrome Web Store

Chrome™ Web Store is a Web resource that provides apps and extensions dedicated for your Chromebook and the Chrome browser.

Note: Extensions are add-on features for the Chrome browser. Most of the apps and extension available on the Chrome Web Store are free but some may require payment.

You can access the Chrome Web Store by either of the following ways:

- Click the Web Store icon from the App Launcher.
- Visit <http://chrome.google.com/webstore> directly using the Chrome browser.

Apps and extensions downloaded from the Web Store run completely within the Chrome browser.

Add apps or extensions

- Step 1. Click the Launcher button, and then click  to display the full APP Launcher.
- Step 2. Click **Web Store**.
- Step 3. Within the store, find your app or extension by typing keywords or searching the list by category.
- Step 4. Click the add icon and then click **Add to Chrome**.

Most of the apps from the Web Store are Web based and do not require installation. The added apps are pinned to the App Launcher and extensions to the right of the Chrome's address bar.

Note: If you sign in to different Chromebooks with the same Google Account, apps you added on one Chromebook are synchronized on other Chromebooks.

Install Android apps

You can download and install Android apps on your Chromebook using the Google Play™ Store.

- Step 1. Start Play Store from the App Launcher.
- Step 2. Select the app that you want to install and then click **INSTALL**.

Note: Not all apps in the Play Store are free of charge. Some apps require the purchase for downloading or full-function using.

The installed Android apps are accessible from the App Launcher.

Pin apps to shelf

Apps pinned to shelf are accessible from the center of bottom in the Chrome desktop.

Step 1. Locate the app icon in the App Launcher.

Step 2. Press and hold the app icon, and then select **Pin to shelf** on the context menu.

To unpin an app, press and hold the app icon on the shelf, then select **Unpin** on the context menu.

Pin Web pages to shelf

If you need to visit a Web page frequently, you can pin the Web page to shelf for easy access.

Step 1. Start the Chrome browser and go to your favorite Web page.

Step 2. With the Web page open, select the Customize and control Google Chrome icon  in the upper right corner.

Step 3. Select **More tools** → **Create shortcut** → **Create**.

To unpin the Web page, press and hold the app icon on the shelf, and then select **Unpin** on the context menu.

Chapter 10. Accessibility, ergonomic, and maintenance information

Accessibility and comfort

Good ergonomic practice is important to get the most from your personal computer and to avoid discomfort. Arrange your workplace and the equipment you use to suit your individual needs and the kind of work that you perform. In addition, use healthy work habits to maximize your performance and comfort while using your computer.

Lenovo is committed to providing the latest information and technology to our customers with disabilities. Refer to our accessibility information which outlines our efforts in this area.

Ergonomic information

Working in the virtual office might mean adapting to frequent changes in your environment. Following some simple rules will make things easier and bring you the maximum benefits of your computer. Keeping in mind such basics as good lighting and proper seating, for example, can help you improve your performance and achieve greater comfort.

This example shows someone in a conventional setting. Even when not in such a setting, you can follow many of these tips. Develop good habits, and they will serve you well.



Figure 1. Illustration of proper seating and computer positioning

General posture

Make minor modifications in your working posture to deter the onset of discomfort caused by long periods of working in the same position. Frequent, short breaks from your work also help to prevent minor discomfort associated with your working posture.

Display

Position the display to maintain a comfortable viewing distance of 510-760 mm (20-30 inch). Avoid glare or reflections on the display from overhead lighting or outside sources of light. Keep the display screen clean and set the brightness to levels that enable you to see the screen clearly. Press the corresponding hotkeys on the keyboard to adjust display brightness.

Head position

Keep your head and neck in a comfortable and neutral (vertical or upright) position.

Chair

Use a chair that gives you good back support and seat height adjustment. Use chair adjustments to best suit your desired posture.

Arm and hand position

If available, use chair arm rests or an area on your working surface to provide weight support for your arms. Keep your forearms, wrists, and hands in a relaxed and neutral (horizontal) position. Type with a soft touch without pounding the keys.

Leg position

Keep your thighs parallel to the floor and your feet flat on the floor or on a footrest.

What if you are traveling?

It might not be possible to observe the best ergonomic practices when you are using your computer while on the move or in a casual setting. Regardless of the setting, try to observe as many of the tips as possible. Sitting properly and using adequate lighting, for example, will help you maintain desirable levels of comfort and performance.

Questions about vision?

The visual display screens of Lenovo notebook computers are designed to meet the highest standards and to provide you with clear, crisp images and large, bright displays that are easy to see, yet easy on the eyes. Of course, any concentrated and sustained visual activity can be tiring. If you have questions on eye fatigue or visual discomfort, consult a vision care specialist for advice.

Basic maintenance tips

- Keep your computer away from magnets, activated cellular phones, electrical appliances, or speakers (more than 13 cm or 5 inches).
- Avoid subjecting your computer to extreme temperatures (below 5 °C/41 °F or above 35 °C/95 °F).
- Avoid placing any objects (including paper) between the display and the keyboard or the palm rest.
- Do not turn your computer over when the ac power adapter is plugged in, otherwise, it could break the adapter plug.
- Before moving your computer, be sure to remove any media, turn off attached devices, and disconnect cords and cables.
- When picking up your open notebook computer, hold it by the bottom. Do not pick up or hold your notebook computer by the display.
- Avoid directly exposing your computer and peripherals to the air from an appliance that can produce negative ions. Wherever possible, ground your computer to facilitate safe electrostatic discharge.

Cleaning your computer

It is a good practice to clean your computer periodically to protect the surfaces and ensure trouble-free operation.

Cleaning the computer cover

Wipe it with a lint-free cloth dampened in mild soap and water. Avoid applying liquids directly to the cover.

Cleaning the keyboard

Wipe the keys one by one with a lint-free cloth dampened in mild soap and water. If you wipe several keys at a time, the cloth might hook onto an adjacent key and possibly damage it. Avoid spraying cleaner directly

onto the keyboard. To remove any crumbs or dust from beneath the keys, you can use a camera blower with a brush or use cool air from a hair dryer.

Cleaning the computer screen

Scratches, oil, dust, chemicals, and ultraviolet light can affect the performance of your computer screen. Use a dry, soft lint-free cloth to wipe the screen gently. If you see a scratch-like mark on your screen, it might be a stain. Wipe or dust the stain gently with a soft, dry cloth. If the stain remains, moisten a soft, lint-free cloth with water or eyeglass cleaner, but do not apply liquids directly to your computer screen. Ensure that the computer screen is dry before closing it.

Appendix A. Compliance information

This chapter provides regulatory, environmental, RoHS, and ENERGY STAR information about Lenovo products.

Radio frequency compliance statements

Computer models equipped with wireless communications comply with the radio frequency and safety standards of any country or region in which it has been approved for wireless use.

Besides this document, ensure that you read the *Regulatory Notice* for your country or region before using the wireless devices contained in your computer.

European Union - compliance with the Radio Equipment Directive

This product is in conformity with all the requirements and essential norms that apply to EU Council Radio Equipment Directive 2014/53/EU on the approximation of the laws of the Member States relating to radio equipment. The full text of the system EU declaration of conformity and the EU wireless module declarations are available at the following Internet addresses:

- For notebook computers: https://www.lenovo.com/us/en/social_responsibility/EU_DoC_notebooks
- For tablet computers: https://www.lenovo.com/us/en/social_responsibility/EU_DoC_notebooks
- For wireless peripheral devices: https://www.lenovo.com/us/en/social_responsibility/EU_DoC_wireless_options

Lenovo cannot accept responsibility for any failure to satisfy the protection requirements resulting from a non-recommended modification of the product, including the installation of option cards from other manufacturers. This product has been tested and found to comply with the limits for Class B equipment according to European Standards harmonized in the Directives in compliance. The limits for Class B equipment were derived for typical residential environments to provide reasonable protection against interference with licensed communication devices.

Brazil

Este equipamento não tem direito à proteção contra interferência prejudicial e não pode causar interferência em sistemas devidamente autorizados.

This equipment is not protected against harmful interference and may not cause interference with duly authorized systems.

Mexico

Advertencia: En Mexico la operación de este equipo está sujeta a las siguientes dos condiciones: (1) es posible que este equipo o dispositivo no cause interferencia perjudicial y (2) este equipo o dispositivo debe aceptar cualquier interferencia, incluyendo la que pueda causar su operación no deseada.

Singapore

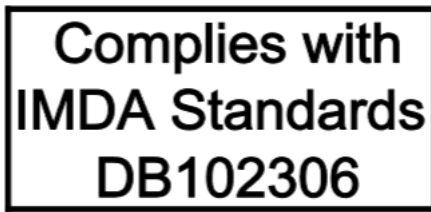

Korea

무선설비 전파 혼신 (사용주파수 2400~2483.5 , 5725~5825 무선제품해당)

해당 무선설비가 전파혼신 가능성이 있으므로 인명안전과 관련된 서비스는 할 수 없음

SAR 정보

본 장치는 전파 노출에 대한 가이드라인을 충족합니다.

본 장치는 무선 송수신기입니다. 본 장치는 국제 가이드라인으로 권장되는 전파 노출에 대한 제한을 초과하지 않도록 설계되었습니다. 장치 액세서리 및 최신 부품을 사용할 경우 SAR 값이 달라질 수 있습니다. SAR 값은 국가 보고 및 테스트 요구 사항과 네트워크 대역에 따라 다를 수 있습니다. 본 장치는 사람의 신체에서 20mm 이상의 거리에서 사용할 수 있습니다.

Environmental information of countries and regions

This section provides environmental, recycling, and RoHS information about Lenovo products.

Recycling and environmental information

Lenovo encourages owners of information technology (IT) equipment to responsibly recycle their equipment when it is no longer needed. Lenovo offers a variety of programs and services to assist equipment owners in recycling their IT products. For information about recycling Lenovo products, go to:

<https://www.lenovo.com/recycling>

The latest environmental information about our products is available at:

<https://www.lenovo.com/ecodeclaration>

Important WEEE information



The WEEE marking on Lenovo products applies to countries with WEEE and e-waste regulations (for example, the European WEEE Directive, India E-Waste Management Rules). Appliances are labeled in accordance with local regulations concerning waste electrical and electronic equipment (WEEE). These regulations determine the framework for the return and recycling of used appliances as applicable within each geography. This label is applied to various products to indicate that the product is not to be thrown away, but rather put in the established collection systems for reclaiming these end of life products.

Users of electrical and electronic equipment (EEE) with the WEEE marking must not dispose of end of life EEE as unsorted municipal waste, but use the collection framework available to them for the return, recycle, and recovery of WEEE and to minimize any potential effects of EEE on the environment and human health due to the presence of hazardous substances. Lenovo electrical and electronic equipment (EEE) may contain parts and components, which at end-of-life might qualify as hazardous waste.

EEE and waste electrical and electronic equipment (WEEE) can be delivered free of charge to the place of sale or any distributor that sells electrical and electronic equipment of the same nature and function as the used EEE or WEEE.

For additional WEEE information, go to:

<https://www.lenovo.com/recycling>

WEEE information for Hungary

Lenovo, as a producer, bears the cost incurred in connection with the fulfillment of Lenovo's obligations under Hungary Law No. 197/2014 (VIII.1.) subsections (1)-(5) of section 12.

Japan recycling statements

Collecting and recycling a disused Lenovo computer or monitor

If you are a company employee and need to dispose of a Lenovo computer or monitor that is the property of the company, you must do so in accordance with the Law for Promotion of Effective Utilization of Resources. Computers and monitors are categorized as industrial waste and should be properly disposed of by an industrial waste disposal contractor certified by a local government. In accordance with the Law for Promotion of Effective Utilization of Resources, Lenovo Japan provides, through its PC Collecting and Recycling Services, for the collecting, reuse, and recycling of disused computers and monitors. For details, visit the Lenovo Web site at:

<https://www.lenovo.com/recycling/japan>

Pursuant to the Law for Promotion of Effective Utilization of Resources, the collecting and recycling of home-used computers and monitors by the manufacturer was begun on October 1, 2003. This service is provided free of charge for home-used computers sold after October 1, 2003. For details, go to:

<https://www.lenovo.com/recycling/japan>

Disposing of Lenovo computer components

Some Lenovo computer products sold in Japan may have components that contain heavy metals or other environmental sensitive substances. To properly dispose of disused components, such as a printed circuit board or drive, use the methods described above for collecting and recycling a disused computer or monitor.

Disposing of disused lithium batteries from Lenovo computers

A button-shaped lithium battery is installed inside your Lenovo computer to provide power to the computer clock while the computer is off or disconnected from the main power source. If you need to replace it with a new one, contact your place of purchase or contact Lenovo for service. If you need to dispose of a disused

lithium battery, insulate it with vinyl tape, contact your place of purchase or an industrial-waste-disposal operator, and follow their instructions.

Disposal of a lithium battery must comply with local ordinances and regulations.

Disposing of a disused battery from Lenovo notebook computers

Your Lenovo notebook computer has a lithium ion battery or a nickel metal hydride battery. If you are a company employee who uses a Lenovo notebook computer and need to dispose of a battery, contact the proper person in Lenovo sales, service, or marketing, and follow that person's instructions. You also can refer to the instructions at:

<https://www.lenovo.com/jp/ja/environment/recycle/battery>

If you use a Lenovo notebook computer at home and need to dispose of a battery, you must comply with local ordinances and regulations. You also can refer to the instructions at:

<https://www.lenovo.com/jp/ja/environment/recycle/battery>

Recycling information for Brazil

Declarações de Reciclagem no Brasil

Descarte de um Produto Lenovo Fora de Uso

Equipamentos elétricos e eletrônicos não devem ser descartados em lixo comum, mas enviados à pontos de coleta, autorizados pelo fabricante do produto para que sejam encaminhados e processados por empresas especializadas no manuseio de resíduos industriais, devidamente certificadas pelos órgãos ambientais, de acordo com a legislação local.

A Lenovo possui um canal específico para auxiliá-lo no descarte desses produtos. Caso você possua um produto Lenovo em situação de descarte, ligue para o nosso SAC ou encaminhe um e-mail para: reciclar@lenovo.com, informando o modelo, número de série e cidade, a fim de enviarmos as instruções para o correto descarte do seu produto Lenovo.

Battery recycling information for the European Union

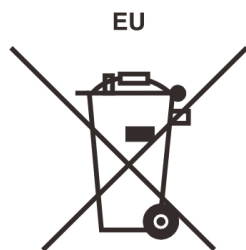

Notice: This mark applies only to countries within the European Union (EU).

Batteries or packaging for batteries are labeled in accordance with European Directive 2006/66/EC concerning batteries and accumulators and waste batteries and accumulators. The Directive determines the framework for the return and recycling of used batteries and accumulators as applicable throughout the European Union. This label is applied to various batteries to indicate that the battery is not to be thrown away, but rather reclaimed upon end of life per this Directive.

In accordance with the European Directive 2006/66/EC, batteries and accumulators are labeled to indicate that they are to be collected separately and recycled at end of life. The label on the battery may also include

a chemical symbol for the metal concerned in the battery (Pb for lead, Hg for mercury, and Cd for cadmium). Users of batteries and accumulators must not dispose of batteries and accumulators as unsorted municipal waste, but use the collection framework available to customers for the return, recycling, and treatment of batteries and accumulators. Customer participation is important to minimize any potential effects of batteries and accumulators on the environment and human health due to the potential presence of hazardous substances.

Before placing electrical and electronic equipment (EEE) in the waste collection stream or in waste collection facilities, the end user of equipment containing batteries and/or accumulators must remove those batteries and accumulators for separate collection.

Disposing of lithium batteries and battery packs from Lenovo products

A coin-cell type lithium battery might be installed inside your Lenovo product. You can find details about the battery in the product documentation. If the battery needs to be replaced, contact your place of purchase or contact Lenovo for service. If you need to dispose of a lithium battery, insulate it with vinyl tape, contact your place of purchase or a waste-disposal operator, and follow their instructions.

Disposing of battery packs from Lenovo products

Your Lenovo device might contain a lithium-ion battery pack or a nickel metal hydride battery pack. You can find details on the battery pack in the product documentation. If you need to dispose of a battery pack, insulate it with vinyl tape, contact Lenovo sales, service, or your place of purchase, or a waste-disposal operator, and follow their instructions. You also can refer to the instructions provided in the user guide for your product.

For proper collection and treatment, go to:

<https://www.lenovo.com/lenovo/environment>

Recycling information for China

《废弃电器电子产品回收处理管理条例》提示性说明

联想鼓励拥有联想品牌产品的用户当不再需要此类产品时，遵守国家废弃电器电子产品回收处理相关法律法规，将其交给当地具有国家认可的回收处理资质的厂商进行回收处理。更多回收服务信息，请点击进入<http://support.lenovo.com.cn/activity/551.htm>

Battery recycling information for Taiwan



廢電池請回收

Battery recycling information for the United States and Canada



US & Canada Only

Restriction of Hazardous Substances (RoHS) Directive of countries and regions

The latest environmental information about Lenovo products is available at:

<https://www.lenovo.com/ecodeclaration>

European Union RoHS

This Lenovo product, with included parts (cables, cords, and so on) meets the requirements of Directive 2011/65/EU on the restriction of the use of certain hazardous substances in electrical and electronic equipment ("RoHS recast" or "RoHS 2").

For more information about Lenovo worldwide compliance on RoHS, go to:

<https://www.lenovo.com/rohs-communication>

Turkish RoHS

The Lenovo product meets the requirements of the Republic of Turkey Directive on the Restriction of the Use of Certain Hazardous Substances in Waste Electrical and Electronic Equipment (WEEE).

Türkiye AEEE Yönetmeliğine Uygunluk Beyanı

Bu Lenovo ürünü, T.C. Çevre ve Orman Bakanlığı'nın "Atık Elektrik ve Elektronik Eşyalarda Bazı Zararlı Maddelerin Kullanımının Sınırlandırılmasına Dair Yönetmelik (AEEE)" direktiflerine uygundur.

AEEE Yönetmeliğine Uygundur.

Ukraine RoHS

Цим підтверджуємо, що продукція Леново відповідає вимогам нормативних актів України, які обмежують вміст небезпечних речовин

India RoHS

RoHS compliant as per E-Waste (Management) Rules.

China RoHS

The information in the following table is applicable to products manufactured on or after January 1, 2015 for sale in the People's Republic of China.

产品中有害物质的名称及含量

部件名称	铅 (Pb)	汞 (Hg)	镉 (Cd)	六价铬 (Cr (VI))	多溴联苯 (PBB)	多溴二苯醚 (PBDE)
印刷电路板组件	X	○	○	○	○	○
硬盘	X	○	○	○	○	○
LCD 面板 (LED 背光源)	X	○	○	○	○	○
键盘	X	○	○	○	○	○
内存	X	○	○	○	○	○
电池	X	○	○	○	○	○
电源适配器	X	○	○	○	○	○
底壳、顶盖和扬声器	X	○	○	○	○	○

注：

本表依据SJ/T 11364的规定编制。

○：表示该有害物质在该部件所有均质材料中的含量均在 GB/T 26572 标准规定的限量要求以下。

X：表示该有害物质至少在该部件的某一均质材料中的含量超出 GB/T 26572 标准规定的限量要求。标有“X”的部件，皆因全球技术发展水平限制而无法实现有害物质的替代。印刷电路板组件包括印刷电路板（PCB）及其组件、集成电路（IC）和连接器。某些型号的产品可能不包含上表中的某些部件，请以实际购买机型为准。

图示：



在中华人民共和国境内销售的电子信息产品上将印有“环保使用期限”（EPuP）符号。圆圈中的数字代表产品的正常环保使用期限。

Taiwan RoHS

單元 Unit	限用物質及其化學符號 Restricted substances and its chemical symbols					
	鉛Lead (Pb)	汞Mercury (Hg)	鎘Cadmium (Cd)	六價鉻 Hexavalent chromium (Cr ⁺⁶)	多溴聯苯 Polybrominated biphenyls (PBB)	多溴二苯醚 Polybrominated diphenyl ethers (PBDE)
印刷電路板組件	-	○	○	○	○	○
硬碟機	-	○	○	○	○	○
LCD面板 (LED背光源)	-	○	○	○	○	○
鍵盤	-	○	○	○	○	○
記憶體	-	○	○	○	○	○
電源供應器	-	○	○	○	○	○
底殼、頂蓋和喇叭	-	○	○	○	○	○
麥克風	-	○	○	○	○	○
攝影機	-	○	○	○	○	○
風扇	-	○	○	○	○	○
分離式電源線組	-	○	○	○	○	○
固態硬碟	-	○	○	○	○	○

備考1. “超出0.1 wt %” 及 “超出0.01 wt %” 係指限用物質之百分比含量超出百分比含量基準值。
 Note 1 : “Exceeding 0.1 wt %” and “exceeding 0.01 wt %” indicate that the percentage content of the restricted substance exceeds the reference percentage value of presence condition.

備考2. “○” 係指該項限用物質之百分比含量未超出百分比含量基準值。
 Note 2 : “○” indicates that the percentage content of the restricted substance does not exceed the percentage of reference value of presence.

備考3. “-” 係指該項限用物質為排除項目。
 Note 3 : The “-” indicates that the restricted substance corresponds to the exemption.

Electromagnetic emission notices

Federal Communications Commission (FCC) Supplier's Declaration of Conformity

The following information refers to Lenovo 14e Chromebook, machine type: 81MH.

This equipment has been tested and found to comply with the limits for a Class B digital device, pursuant to Part 15 of the FCC Rules. These limits are designed to provide reasonable protection against harmful interference in a residential installation. This equipment generates, uses, and can radiate radio frequency

energy and, if not installed and used in accordance with the instructions, may cause harmful interference to radio communications. However, there is no guarantee that interference will not occur in a particular installation. If this equipment does cause harmful interference to radio or television reception, which can be determined by turning the equipment off and on, the user is encouraged to try to correct the interference by one or more of the following measures:

- Reorient or relocate the receiving antenna.
- Increase the separation between the equipment and receiver.
- Connect the equipment into an outlet on a circuit different from that to which the receiver is connected.
- Consult an authorized dealer or service representative for help.

Lenovo is not responsible for any radio or television interference caused by using other than recommended cables and connectors or by unauthorized changes or modifications to this equipment. Unauthorized changes or modifications could void the user's authority to operate the equipment.

This device complies with Part 15 of the FCC Rules. Operation is subject to the following two conditions: (1) this device may not cause harmful interference, and (2) this device must accept any interference received, including interference that may cause undesired operation.

Responsible Party:
Lenovo (United States) Incorporated
7001 Development Drive
Morrisville, NC 27560
Email: FCC@lenovo.com



Industry Canada compliance statement

CAN ICES-3(B)/NMB-3(B)

European Union conformity

EU Contact: Lenovo (Slovakia), Landererova 12, 811 09 Bratislava, Slovakia



Compliance with the EMC Directive

This product is in conformity with the protection requirements of EU Council Directive 2014/30/EU on the approximation of the laws of the Member States relating to electromagnetic compatibility.

This product has been tested and found to comply with the limits for Class B equipment according to European Standards harmonized in the Directives in compliance. The Class B requirements for equipment are intended to offer adequate protection to broadcast services within residential environments.

German Class B compliance statement

Hinweis zur Einhaltung der Klasse B zur elektromagnetischen Verträglichkeit

Dieses Produkt entspricht den Schutzanforderungen der EU-Richtlinie zur elektromagnetischen Verträglichkeit Angleichung der Rechtsvorschriften über die elektromagnetische Verträglichkeit in den EU-Mitgliedsstaaten und hält die Grenzwerte der Klasse B der Norm gemäß Richtlinie.

Um dieses sicherzustellen, sind die Geräte wie in den Handbüchern beschrieben zu installieren und zu betreiben. Des Weiteren dürfen auch nur von der Lenovo empfohlene Kabel angeschlossen werden. Lenovo übernimmt keine Verantwortung für die Einhaltung der Schutzanforderungen, wenn das Produkt ohne Zustimmung der Lenovo verändert bzw. wenn Erweiterungskomponenten von Fremdherstellern ohne Empfehlung der Lenovo gesteckt/eingebaut werden.

Zulassungsbescheinigung laut dem Deutschen Gesetz über die elektromagnetische Verträglichkeit von Betriebsmitteln, EMVG vom 20. Juli 2007 (früher Gesetz über die elektromagnetische Verträglichkeit von Geräten), bzw. der EU Richtlinie 2014/30/EU, der EU Richtlinie 2014/53/EU Artikel 3.1b), für Geräte der Klasse B.

Dieses Gerät ist berechtigt, in Übereinstimmung mit dem Deutschen EMVG das EG-Konformitätszeichen - CE - zu führen. Verantwortlich für die Konformitätserklärung nach Paragraf 5 des EMVG ist die Lenovo (Deutschland) GmbH, Meitnerstr. 9, D-70563 Stuttgart.

Japan VCCI Class B compliance statement

この装置は、クラスB機器です。この装置は、住宅環境で使用することを目的としていますが、この装置がラジオやテレビジョン受信機に近接して使用されると、受信障害を引き起こすことがあります。
取扱説明書に従って正しい取り扱いをして下さい。

VCCI-B

Japan compliance statement for products which connect to the power mains with rated current less than or equal to 20 A per phase

日本の定格電流が 20A/相 以下の機器に対する高調波電流規制
高調波電流規格 JIS C 61000-3-2 適合品

Japan notice for ac power cord

The ac power cord shipped with your product can be used only for this specific product. Do not use the ac power cord for other devices.

本製品およびオプションに電源コード・セットが付属する場合は、それぞれ専用のものになっていますので他の電気機器には使用しないでください。

Other compliance information

This section provides other compliance information about Lenovo products.

TCO Certified

Selected models are TCO Certified and bear the TCO Certified logo.

Note: TCO Certified is an international third-party sustainability certification for IT products. For details, go to https://www.lenovo.com/us/en/pdf/social_responsibility/tco_certified.pdf

Export classification notice

This product is subject to the United States Export Administration Regulations (EAR) and has an Export Classification Control Number (ECCN) of 5A992.c. It can be re-exported except to any of the embargoed countries in the EAR E1 country list.

Lenovo product service information for Taiwan

委製商/進口商名稱: 荷蘭商聯想股份有限公司台灣分公司
進口商地址: 台北市中山區北安路780號7樓
進口商電話: 0800-000-702 (代表號)

Taiwan precautionary vision statement

警語：使用過度恐傷害視力

注意事項：

- 使用30分鐘請休息10分鐘。
- 未滿2歲幼兒不看螢幕，2歲以上每天看螢幕不要超過1小時。

Eurasian compliance mark



Brazil audio notice

Ouvir sons com mais de 85 decibéis por longos períodos pode provocar danos ao sistema auditivo.

ENERGY STAR model information



ENERGY STAR is a joint program of the U.S. Environmental Protection Agency and the U.S. Department of Energy aimed at saving money and protecting the environment through energy efficient products and practices.

Lenovo is proud to offer our customers products with an ENERGY STAR compliant designation. Machine type 81MH have been designed and tested to conform to the ENERGY STAR program requirement for computers at the time of manufacture.

For more information about Lenovo ENERGY STAR certified products, go to https://www.lenovo.com/us/en/social_responsibility/energy.

By using ENERGY STAR compliant products and taking advantage of the power management features of your computer, you reduce the consumption of electricity. Reduced electrical consumption contributes to potential financial savings, a cleaner environment, and the reduction of greenhouse gas emissions.

For more information about ENERGY STAR, go to <https://www.energystar.gov>.

Lenovo encourages you to make efficient use of energy an integral part of your day-to-day operations. To help in this endeavor, Lenovo has preset a default power plan. To change the power plan, see “Set the power plan” on page 23.

Appendix B. Lenovo help and support

Lenovo support Web site

Technical support information is available on the Lenovo support Web site at <http://www.lenovo.com/support>.

Call Lenovo customer support center

If you have tried to correct the problem yourself but still need help, during the warranty period, you can get help and information by telephone through the customer support center.

Before calling customer support

Ensure that you have downloaded the most current drivers and system updates and recorded information about your computer before you call. When calling for technical assistance, have the following information available.

- Machine type and model
- Serial number of your computer
- Description of the problem
- Exact wording of any error messages
- Hardware and software configuration information

Services supported by Lenovo customer support center

The following services are available during the warranty period.

- Problem determination - Trained personnel are available to assist you with determining if you have a hardware problem and deciding what action is necessary to fix the problem.
- Lenovo hardware repair - If the problem is determined to be caused by Lenovo hardware under warranty, trained service personnel are available to provide the applicable level of service.
- Engineering change management - Occasionally, there might be changes that are required after a product has been sold. Lenovo or your reseller, if authorized by Lenovo, will make selected Engineering Changes (ECs) that apply to your hardware available.

Services not supported by Lenovo customer support center

- Replacement or use of parts not manufactured for or by Lenovo or non-warranted parts
- Identification of software problem sources
- Configuration of UEFI BIOS as part of an installation or upgrade
- Changes, modifications, or upgrades to device drivers
- Installation and maintenance of network operating systems (NOS)
- Installation and maintenance of programs

Support phone numbers

For the Lenovo support phone number for your country or region, go to <http://www.lenovo.com/support/phone>.

Note: Phone numbers are subject to change without notice. If the number for your country or region is not provided, contact your Lenovo reseller or Lenovo marketing representative.

Appendix C. Lenovo Limited Warranty

L505-0010-02 08/2011

This Lenovo Limited Warranty consists of the following parts:

- Part 1 – General Terms
- Part 2 – Country-specific Terms
- Part 3 – Warranty Service Information

The terms of Part 2 replace or modify terms of Part 1 as specified for a particular country.

Part 1 - General Terms

This Lenovo Limited Warranty applies only to Lenovo hardware products you purchased for your own use and not for resale.

This Lenovo Limited Warranty is available in other languages at <http://www.lenovo.com/warranty>.

What this Warranty Covers

Lenovo warrants that each Lenovo hardware product that you purchase is free from defects in materials and workmanship under normal use during the warranty period. The warranty period for the product starts on the original date of purchase as shown on your sales receipt or invoice or as may be otherwise specified by Lenovo. The warranty period and type of warranty service that apply to your product are as specified in "Part 3 - Warranty Service Information" below. This warranty only applies to products in the country or region of purchase.

THIS WARRANTY IS YOUR EXCLUSIVE WARRANTY AND REPLACES ALL OTHER WARRANTIES OR CONDITIONS, EXPRESS OR IMPLIED, INCLUDING, BUT NOT LIMITED TO, ANY IMPLIED WARRANTIES OR CONDITIONS OF MERCHANTABILITY OR FITNESS FOR A PARTICULAR PURPOSE. AS SOME STATES OR JURISDICTIONS DO NOT ALLOW THE EXCLUSION OF EXPRESS OR IMPLIED WARRANTIES, THE ABOVE EXCLUSION MAY NOT APPLY TO YOU. IN THAT EVENT, SUCH WARRANTIES APPLY ONLY TO THE EXTENT AND FOR SUCH DURATION AS REQUIRED BY LAW AND ARE LIMITED IN DURATION TO THE WARRANTY PERIOD. AS SOME STATES OR JURISDICTIONS DO NOT ALLOW LIMITATIONS ON THE DURATION OF AN IMPLIED WARRANTY, THE ABOVE LIMITATION ON DURATION MAY NOT APPLY TO YOU.

How to Obtain Warranty Service

If the product does not function as warranted during the warranty period, you may obtain warranty service by contacting Lenovo or a Lenovo approved Service Provider. A list of approved Service Providers and their telephone numbers is available at: <http://www.lenovo.com/support/phone>.

Warranty service may not be available in all locations and may differ from location to location. Charges may apply outside a Service Provider's normal service area. Contact a local Service Provider for information specific to your location.

Customer Responsibilities for Warranty Service

Before warranty service is provided, you must take the following steps:

- follow the service request procedures specified by the Service Provider
- back up or secure all programs and data contained in the product

- provide the Service Provider with all system keys or passwords
- provide the Service Provider with sufficient, free, and safe access to your facilities to perform service
- remove all data, including confidential information, proprietary information and personal information, from the product or, if you are unable to remove any such information, modify the information to prevent its access by other party or so that it is not personal data under applicable law. The Service Provider shall not be responsible for the loss or disclosure of any data, including confidential information, proprietary information, or personal information, on a product returned or accessed for warranty service
- remove all features, parts, options, alterations, and attachments not covered by the warranty
- If you are not the owner of a product or part, obtain authorization from the owner for the Service Provider to provide warranty service

What Your Service Provider Will Do to Correct Problems

When you contact a Service Provider, you must follow the specified problem determination and resolution procedures.

The Service Provider will attempt to diagnose and resolve your problem by telephone, e-mail or remote assistance. The Service Provider may direct you to download and install designated software updates.

Some problems may be resolved with a replacement part that you install yourself called a "Customer Replaceable Unit" or "CRU." If so, the Service Provider will ship the CRU to you for you to install.

If your problem cannot be resolved over the telephone, through the application of software updates or the installation of a CRU, the Service Provider will arrange for service under the type of warranty service designated for the product under "Part 3 - Warranty Service Information" below.

If the Service Provider determines that it is unable to repair your product, the Service Provider will replace it with one that is at least functionally equivalent.

If the Service Provider determines that it is unable to either repair or replace your product, your sole remedy under this Limited Warranty is to return the product to your place of purchase or to Lenovo for a refund of your purchase price.

Replacement Products and Parts

When warranty service involves the replacement of a product or part, the replaced product or part becomes Lenovo's property and the replacement product or part becomes your property. Only unaltered Lenovo products and parts are eligible for replacement. The replacement product or part provided by Lenovo may not be new, but it will be in good working order and at least functionally equivalent to the original product or part. The replacement product or part shall be warranted for the balance of the period remaining on the original product.

Use of Personal Contact Information

If you obtain service under this warranty, you authorize Lenovo to store, use and process information about your warranty service and your contact information, including name, phone numbers, address, and e-mail address. Lenovo may use this information to perform service under this warranty. We may contact you to inquire about your satisfaction with our warranty service or to notify you about any product recalls or safety issues. In accomplishing these purposes, you authorize Lenovo to transfer your information to any country where we do business and to provide it to entities on our behalf. We may also disclose it where required by law. Lenovo's privacy policy is available at <http://www.lenovo.com>.

What This Warranty Does not Cover

This warranty does not cover the following:

- uninterrupted or error-free operation of a product

- loss of, or damage to, your data by a product
- any software programs, whether provided by the product or installed subsequently
- failure or damage resulting from misuse, abuse, accident, modification, unsuitable physical or operating environment, natural disasters, power surges, improper maintenance, or use not in accordance with product information materials
- damage caused by non-authorized service provider
- failure of, or damage caused by, any third party products, including those that Lenovo may provide or integrate into the Lenovo product at your request
- any technical or other support, such as assistance with "how-to" questions and those regarding product set-up and installation
- products or parts with an altered identification label or from which the identification label has been removed

Limitation of Liability

Lenovo is responsible for loss or damage to your product only while it is in the Service Provider's possession or in transit, if the Service Provider is responsible for the transportation.

Neither Lenovo nor the Service Provider is responsible for loss or disclosure of any data, including confidential information, proprietary information, or personal information, contained in a product.

UNDER NO CIRCUMSTANCES, AND NOTWITHSTANDING THE FAILURE OF ESSENTIAL PURPOSE OF ANY REMEDY SET FORTH HEREIN, SHALL LENOVO, ITS AFFILIATES, SUPPLIERS, RESELLERS, OR SERVICE PROVIDERS BE LIABLE FOR ANY OF THE FOLLOWING EVEN IF INFORMED OF THEIR POSSIBILITY AND REGARDLESS OF WHETHER THE CLAIM IS BASED IN CONTRACT, WARRANTY, NEGLIGENCE, STRICT LIABILITY OR OTHER THEORY OF LIABILITY: 1) THIRD PARTY CLAIMS AGAINST YOU FOR DAMAGES; 2) LOSS, DAMAGE OR DISCLOSURE OF YOUR DATA; 3) SPECIAL, INCIDENTAL, PUNITIVE, INDIRECT OR CONSEQUENTIAL DAMAGES, INCLUDING BUT NOT LIMITED TO LOST PROFITS, BUSINESS REVENUE, GOODWILL OR ANTICIPATED SAVINGS. IN NO CASE SHALL THE TOTAL LIABILITY OF LENOVO, ITS AFFILIATES, SUPPLIERS, RESELLERS OR SERVICE PROVIDERS FOR DAMAGES FROM ANY CAUSE EXCEED THE AMOUNT OF ACTUAL DIRECT DAMAGES, NOT TO EXCEED THE AMOUNT PAID FOR THE PRODUCT.

THE FOREGOING LIMITATIONS DO NOT APPLY TO DAMAGES FOR BODILY INJURY (INCLUDING DEATH), DAMAGE TO REAL PROPERTY OR DAMAGE TO TANGIBLE PERSONAL PROPERTY FOR WHICH LENOVO IS LIABLE UNDER LAW.

AS SOME STATES OR JURISDICTIONS DO NOT ALLOW THE EXCLUSION OR LIMITATION OF INCIDENTAL OR CONSEQUENTIAL DAMAGES, THE ABOVE LIMITATION OR EXCLUSION MAY NOT APPLY TO YOU.

Your Other Rights

THIS WARRANTY GIVES YOU SPECIFIC LEGAL RIGHTS. YOU MAY HAVE OTHER RIGHTS ACCORDING TO THE APPLICABLE LAWS OF YOUR STATE OR JURISDICTION. YOU MAY ALSO HAVE OTHER RIGHTS UNDER A WRITTEN AGREEMENT WITH LENOVO. NOTHING IN THIS WARRANTY AFFECTS STATUTORY RIGHTS, INCLUDING RIGHTS OF CONSUMERS UNDER LAWS OR REGULATIONS GOVERNING THE SALE OF CONSUMER GOODS THAT CANNOT BE WAIVED OR LIMITED BY CONTRACT.

Part 2 – Country-specific Terms

Australia

"Lenovo" means Lenovo (Australia & New Zealand) Pty Limited ABN 70 112 394 411. Address: Level 10, North Tower, 1-5 Railway Street, Chatswood, NSW, 2067. Telephone: +61 2 8003 8200. Email: lensyd_au@lenovo.com

The following replaces the same section in Part 1:

What this Warranty Covers

Lenovo warrants that each hardware product that you purchase is free from defects in materials and workmanship under normal use and conditions during the warranty period. If the product fails due to a covered defect during the warranty period, Lenovo will provide you a remedy under this Limited Warranty. The warranty period for the product starts on the original date of purchase specified on your sales receipt or invoice unless Lenovo informs you otherwise in writing. The warranty period and type of warranty service that apply to your product are set forth below in Part 3 - Warranty Service Information.

THE BENEFITS GIVEN BY THIS WARRANTY ARE IN ADDITION TO YOUR RIGHTS AND REMEDIES AT LAW, INCLUDING THOSE UNDER THE AUSTRALIAN CONSUMER LAW.

The following replaces the same section in Part 1:

Replacement Products and Parts

When warranty service involves the replacement of a product or part, the replaced product or part becomes Lenovo's property and the replacement product or part becomes your property. Only unaltered Lenovo products and parts are eligible for replacement. The replacement product or part provided by Lenovo may not be new, but it will be in good working order and at least functionally equivalent to the original product or part. The replacement product or part shall be warranted for the balance of the period remaining on the original product. Products and parts presented for repair may be replaced by refurbished products or parts of the same type rather than being repaired. Refurbished parts may be used to repair the product; and repair of the product may result in loss of data, if the product is capable of retaining user-generated data.

The following is added to the same section in Part 1:

Use of Personal Contact Information

Lenovo will not be able to perform our service under this warranty if you refuse to provide your information or do not wish us to transfer your information to our agent or contractor. You have the right to access your personal contact information and request correction of any errors in it pursuant to the Privacy Act 1988 by contacting Lenovo.

The following replaces the same section in Part 1:

Limitation of Liability

Lenovo is responsible for loss or damage to your product only while it is in the Service Provider's possession or in transit, if the Service Provider is responsible for the transportation.

Neither Lenovo nor the Service Provider is responsible for loss or disclosure of any data, including confidential information, proprietary information, or personal information, contained in a product.

TO THE EXTENT PERMITTED BY LAW, UNDER NO CIRCUMSTANCES AND NOTWITHSTANDING THE FAILURE OF ESSENTIAL PURPOSE OF ANY REMEDY SET FORTH HEREIN, SHALL LENOVO, ITS AFFILIATES, SUPPLIERS, RESELLERS, OR SERVICE PROVIDERS BE LIABLE FOR ANY OF THE FOLLOWING EVEN IF INFORMED OF THEIR POSSIBILITY AND REGARDLESS OF WHETHER THE CLAIM IS BASED IN CONTRACT, WARRANTY, NEGLIGENCE, STRICT LIABILITY OR OTHER THEORY OF LIABILITY: 1) THIRD PARTY CLAIMS AGAINST YOU FOR DAMAGES; 2) LOSS, DAMAGE OR DISCLOSURE OF YOUR DATA; 3) SPECIAL, INCIDENTAL, PUNITIVE, INDIRECT OR CONSEQUENTIAL DAMAGES, INCLUDING BUT NOT LIMITED TO LOST PROFITS, BUSINESS REVENUE, GOODWILL OR ANTICIPATED

SAVINGS. IN NO CASE SHALL THE TOTAL LIABILITY OF LENOVO, ITS AFFILIATES, SUPPLIERS, RESELLERS OR SERVICE PROVIDERS FOR DAMAGES FROM ANY CAUSE EXCEED THE AMOUNT OF ACTUAL DIRECT DAMAGES, NOT TO EXCEED THE AMOUNT PAID FOR THE PRODUCT.

THE FOREGOING LIMITATIONS DO NOT APPLY TO DAMAGES FOR BODILY INJURY (INCLUDING DEATH), DAMAGE TO REAL PROPERTY OR DAMAGE TO TANGIBLE PERSONAL PROPERTY FOR WHICH LENOVO IS LIABLE UNDER LAW.

The following replaces the same section in Part 1:

Your Other Rights

THIS WARRANTY GIVES YOU SPECIFIC LEGAL RIGHTS. YOU ALSO HAVE OTHER RIGHTS AT LAW, INCLUDING UNDER THE AUSTRALIAN CONSUMER LAW. NOTHING IN THIS WARRANTY AFFECTS STATUTORY RIGHTS OR RIGHTS AT LAW, INCLUDING RIGHTS THAT CANNOT BE WAIVED OR LIMITED BY CONTRACT.

For example, our products come with guarantees that cannot be excluded under the Australian Consumer Law. You are entitled to a replacement or refund for a major failure and compensation for any other reasonably foreseeable loss or damage. You are also entitled to have the products repaired or replaced if the products fail to be of acceptable quality and the failure does not amount to a major failure.

New Zealand

The following is added to the same section in Part 1:

Use of Personal Information

Lenovo will not be able to perform our service under this warranty if you refuse to provide your information or do not wish us to transfer your information to our agent or contractor. You have the right to access your personal information and request correction of any errors in it pursuant to the Privacy Act 1993 by contacting Lenovo (Australia & New Zealand) Pty Limited ABN 70 112 394 411. Address: Level 10, North Tower, 1-5 Railway Street, Chatswood, NSW, 2067. Telephone: 61 2 8003 8200. Email: lensyd_au@lenovo.com

Bangladesh, Cambodia, India, Indonesia, Nepal, Philippines, Vietnam and Sri Lanka

The following is added to Part 1:

Dispute Resolution

Disputes arising out of or in connection with this warranty shall be finally settled by arbitration held in Singapore. This warranty shall be governed, construed and enforced in accordance with the laws of Singapore, without regard to conflict of laws. If you acquired the product in India, disputes arising out of or in connection with this warranty shall be finally settled by arbitration held in Bangalore, India. Arbitration in Singapore shall be held in accordance with the Arbitration Rules of Singapore International Arbitration Center ("SIAC Rules") then in effect. Arbitration in India shall be held in accordance with the laws of India then in effect. The arbitration award shall be final and binding on the parties without appeal. Any award shall be in writing and set forth the findings of fact and the conclusions of law. All arbitration proceedings, including all documents presented in such proceedings shall be conducted in the English language. The English language version of this warranty prevails over any other language version in such proceedings.

European Economic Area (EEA)

The following is added to Part 1:

Customers in the EEA may contact Lenovo at the following address: EMEA Service Organization, Lenovo (International) B.V., Floor 2, Einsteinova 21, 851 01, Bratislava, Slovakia. Service under this warranty for

Lenovo hardware products purchased in EEA countries may be obtained in any EEA country in which the product has been announced and made available by Lenovo.

Russia

The following is added to Part 1:

Product Service Life

The product service life is four (4) years from the original date of purchase.

Part 3 - Warranty Service Information

Product Type	Country or Region of Purchase	Warranty Period	Type of Warranty Service
81MH	Australia, New Zealand, Finland, France, Germany, Ireland, Netherlands, Norway, Sweden, Switzerland, United Kingdom, Denmark, Belgium, Italy, Spain, Poland, Czech Republic, Romania, Portugal, Israel	<ul style="list-style-type: none"> Parts and labor - 1 year Battery pack - 1 year 	1, 3
	Argentina, Chile, Columbia, Peru, India, Singapore, Indonesia		1, 4
	United Arab Emirates, South Africa		4
	United States, Canada, Japan		1, 3, 5
	Mexico		1, 3, 4

If required, the Service Provider will provide repair or exchange service depending on the type of warranty service specified for your product and the available service. Scheduling of service will depend upon the time of your call, parts availability, and other factors.

Types of Warranty Service

1. Customer Replaceable Unit (“CRU”) Service

Under CRU Service, the Service Provider will ship CRUs to you at its cost for installation by you. CRU information and replacement instructions are shipped with your product and are available from Lenovo at any time upon request. CRUs that are easily installed by you are called “Self-service CRUs.” “Optional-service CRUs” are CRUs that may require some technical skill and tools. Installation of Self service CRUs is your responsibility. You may request that a Service Provider install Optional-service CRUs under one of the other types of warranty service designated for your product. An optional service offering may be available for purchase from a Service Provider or Lenovo under which Self-service CRUs would be installed for you. You may find a list of CRUs and their designation in the publication that was shipped with your product or at <https://www.lenovo.com/CRUs>. The requirement to return a defective CRU, if any, will be specified in the instructions shipped with a replacement CRU. When return is required: 1) return instructions, a prepaid return shipping label, and a container will be included with the replacement CRU; and 2) you may be charged for

the replacement CRU if the Service Provider does not receive the defective CRU from you within thirty (30) days of your receipt of the replacement CRU.

2. On-site Service

Under On-Site Service, a Service Provider will either repair or exchange the product at your location. You must provide a suitable working area to allow disassembly and reassembly of the product. Some repairs may need to be completed at a service center. If so, the Service Provider will send the product to the service center at its expense.

3. Courier or Depot Service

Under Courier or Depot Service, your product will be repaired or exchanged at a designated service center, with shipping at the expense of the Service Provider. You are responsible for disconnecting the product and packing it in a shipping container provided to you to return your product to a designated service center. A courier will pick up your product and deliver it to the designated service center. The service center will return the product to you at its expense.

4. Customer Carry-In Service

Under Customer Carry-In Service, your product will be repaired or exchanged after you deliver it to a designated service center at your risk and expense. After the product has been repaired or exchanged, it will be made available to you for collection. If you fail to collect the product, the Service Provider may dispose of the product as it sees fit, with no liability to you.

5. Mail-In Service

Under Mail-In Service, your product will be repaired or exchanged at a designated service center after you deliver it at your risk and expense. After the product has been repaired or exchanged, it will be returned to you at Lenovo's risk and expense, unless the Service Provider specifies otherwise.

6. Customer Two-Way Mail-In Service

Under Customer Two-Way Mail-In Service, your product will be repaired or exchanged after you deliver it to a designated service center at your risk and expense. After the product has been repaired or exchanged, it will be made available to you for return shipping at your risk and expense. If you fail to arrange return shipment, the Service Provider may dispose of the product as it sees fit, with no liability to you.

7. Product Exchange Service

Under Product Exchange Service, Lenovo will ship a replacement product to your location. You are responsible for its installation and verification of its operation. The replacement product becomes your property in exchange for the failed product, which becomes the property of Lenovo. You must pack the failed product in the shipping carton in which you received the replacement product and return it to Lenovo. Transportation charges, both ways, shall be at Lenovo's expense. If you fail to use the carton in which the replacement product was received, you may be responsible for any damage to the failed product occurring during shipment. You may be charged for the replacement product if Lenovo does not receive the failed product within thirty (30) days of your receipt of the replacement product.

Trademarks

Lenovo and the “Lenovo” logo are trademarks or registered trademarks of Lenovo in the United States, other countries, or both.

Google, Chrome, Chromebook, Gmail, Google Play, and Android are trademarks or registered trademarks of Google Inc. USB-C is a trademark of USB Implementers Forum.

Other company, products, or service names may be trademarks or service marks of others.

